

INSTRUCTIONS FOR MODELS

VS-157

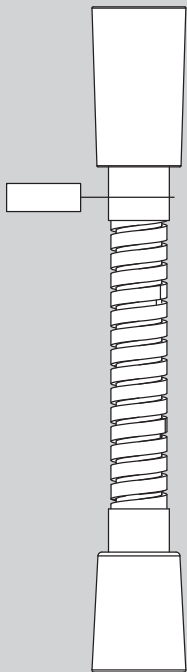

NEED HELP?

For additional assistance or service please contact:

SPEAKMAN® Company
400 Anchor Mill Road
New Castle, DE 19720

 800-537-2107

 customerservice@speakman.com

 www.speakman.com

92-VS-157-R1



IMPORTANT



Be sure to read instructions thoroughly before beginning installation. Do not overtighten any connections or damage may occur.

SAFETY TIPS

Cover your drain to prevent loss of parts.

MAINTENANCE

Periodic cleaning using a mild soap and warm water will help keep your Hand Shower Hose in its original condition.

For best results, dry immediately with a soft, clean cloth. **DO NOT USE** harsh and/or abrasive cleaners.

WARRANTY

Additional warranty information can be found at: www.speakman.com

1

Connect the tagged side of the hose to the water outlet. **WATER WILL NOT FLOW THROUGH THE HOSE IF THE WRONG SIDE IS CONNECTED.**

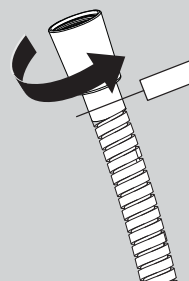
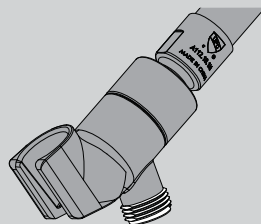

2

Connect the hose to the hand shower.

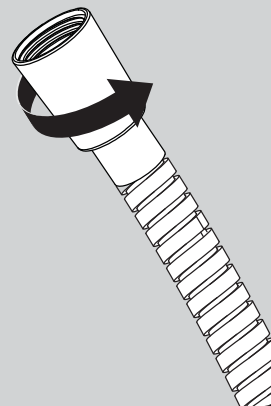
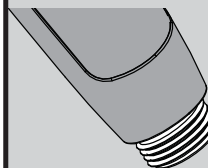

ROUGH IN DIMENSIONS

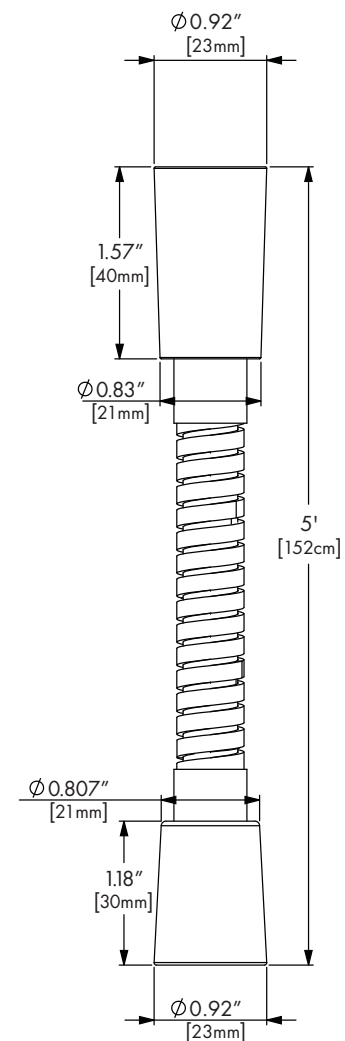

Specifications:

Inlet / Outlet: 1/2" NPSM