

Section 9

AMERICAN Restrained Joint Pipe

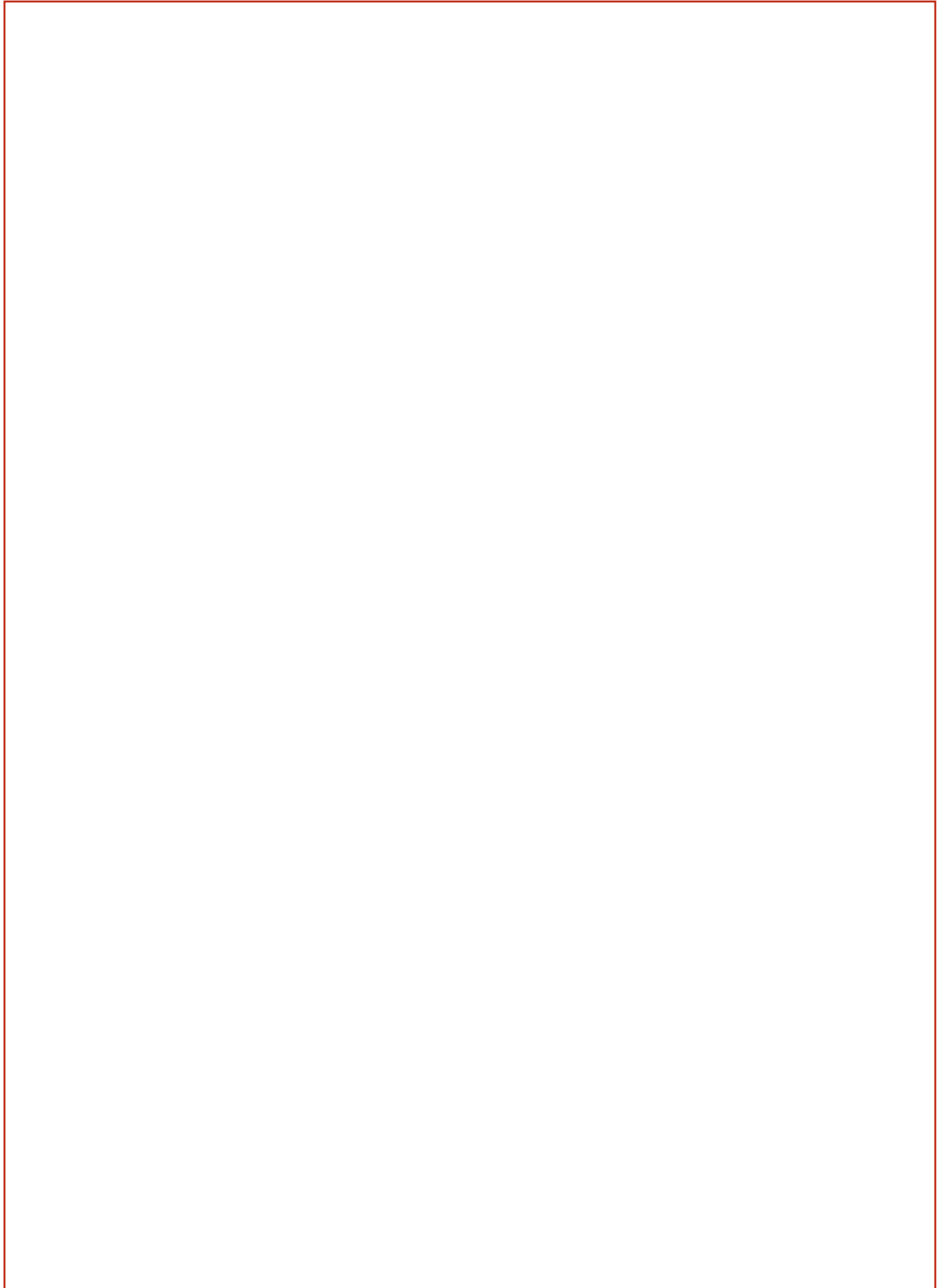





AMERICAN Restrained Joint Pipe

The principal standards relating to applicable features of AMERICAN Restrained Joint Pipe and Fittings are ANSI/AWWA C151/A21.51, ANSI/AWWA C110/A21.10, ANSI/AWWA C111/A21.11 and ANSI/AWWA C153/A21.53. These and other standards are referenced throughout this Section either by the full ANSI/AWWA designation or by only the AWWA numbering, such as AWWA C151.

In many piping installations, the restraining of forces due to internal pressure at fittings, valves, or dead ends is a major consideration. In most underground piping, the restraining of such forces is normally accomplished by concrete reaction blocking, which generally provides the most economical and practical means of pipeline restraint.

In some situations concrete reaction blocking is not practical. For such projects*, AMERICAN has developed pipe joints that provide restraint against external forces or against separation due to internal pressure. Restrained joints are provided in all sizes 4" through 64" as shown below and described in this Section.

4"-12" Flex-Ring® Joint



Fast-Grip® Joint



14"-54" Flex-Ring® Joint



Lok-Ring® Joint



Field Flex-Ring® Joint



MJ Coupled Joint

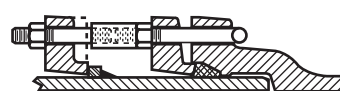

The following joints provide restraint but are not generally furnished primarily for the restraining feature:

Flange Joint—See Sections 6 and 8.

Flex-Lok Joint—See Section 10.

Grooved Joint—See Section 2.

Shouldered Joint—See Section 2.

*To determine the number of joints to be restrained in a given situation, see "Thrust Restraint Design for Ductile Iron Pipe" published by the Ductile Iron Pipe Research Association.



AMERICAN Amarillo Fast-Grip® Gasket

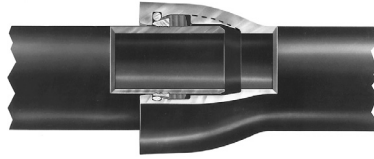

AMERICAN has been in the business of bright ideas for over 110 years. The bright yellow Amarillo Fast-Grip® gasket is just the latest example of a water works innovation that benefits our customers and the public. Designed to the same specifications as the previous generation of Fast-Grips, the Amarillo model gives you added confidence that you've selected the proper gasket for the Fastite bell, that the gasket seated properly during installation and that it's an AMERICAN product — made in America, The Right Way.

The restraint provided by the patented* AMERICAN Amarillo Fast-Grip® gasket is due to the development of wedging action between pairs of high-strength stainless steel elements spaced around the gasket. The outer metal element acts as a bearing member for the wedge-shaped inner element which has sharp teeth on its inner surface for gripping the spigot.

Because of the wedging design utilized, the force between the spigot and the socket of the joint is essentially constant at any given pressure thrust regardless of the "tightness" or "looseness" of the joint fit or the joint deflection.

Amarillo Fast-Grip gaskets are suitable for an allowable water working pressure of 350 psi for 4"-18"*** pipe and 250 psi for 20" and 24"*** sizes. The 30" size is suitable for a 150 psi water working pressure. The joint has a maximum allowable deflection of 5° in the 4"-12", 4° in the 14", 3° in the 16"-24", and 2 1/2° in the 30" size.

Proof-of-design tests have confirmed that the joints are capable of restraining deadend thrust of two or more times the rated working pressure, as applicable. These tests were accomplished with the joints in both straight alignment and at the maximum rated deflection.

The Amarillo Fast-Grip gasket has the same basic shape as AMERICAN's Fastite® gasket, so it can be used in any 4"-30" standard Fastite pipe or fitting socket. The gasket rubber is standard SBR which meets all the material requirements of ANSI/AWWA C111/A21.11.

When they are available on the jobsite, AMERICAN's 16"-30" Flex-Ring® fittings may also be used with the Fast-Grip gasket.

The Fast-Grip gasket is Underwriters Laboratories listed and Factory Mutual approved for use in Fastite or Flex-Ring sockets with Fastite plain ends in all sizes 4"-16". The UL listing and FM approvals apply to all pressure classes and special thickness classes of ductile iron pipe.

In addition to the positive restraint achieved, Amarillo Fast-Grip gaskets offer ergonomically friendly advantages compared to other restrained joints for fittings and pipe requiring bolts, lugs, segments, wrenches, etc. Joints can easily be assembled with current tools and methods used for many years in the assembly of standard Fastite joints. Assembly and disassembly instructions follow.

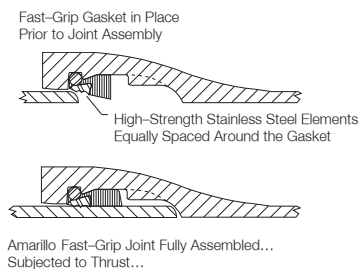

* U.S. Patent No. 5,067,751.

** Because the pressure rating of the joint cannot exceed that of the pipe, the 350 psi rating for 14"-18" sizes and the 250 psi rating for 24" size are limited by the pressure class of pipe with which they are used. For example, an 18" Fast-Grip gasket used with Pressure Class 250 pipe would carry a rating of 250 psi instead of 350 psi. Contact AMERICAN for higher working pressure applications.



AMERICAN Amarillo Fast-Grip® Gasket

Assembly Instructions

Assembling pipe and fitting joints using Amarillo Fast-Grip gaskets is simple. It is very similar to the assembly of Fastite joints shown in Section 2. Amarillo Fast-Grip gaskets may be used in lieu of standard Fastite gaskets in the bells of Fastite and Flex-Ring joint pipe and fittings where easy, field-adaptable restraint is desired.

1. Cleaning of Socket and Spigot

Clean the socket and plain end thoroughly, removing any mud, sand, gravel, ice, frozen material, or other matter that could prevent a proper joint seal. Material in the gasket grooves may cause the gasket to protrude into the path of the entering spigot. Therefore, **it is important that all joint recesses be kept clean during insertion of the gasket and assembly of the joint to prevent gasket dislodgment and/or subsequent leakage.**



2. Placement of Gasket

Wipe the gasket clean. After flexing one or more "loops" in the gasket, insert the gasket in the gasket recess of the socket with the large sealing end of the gasket toward the rear of the socket. The center of the gasket loops should be positioned between tooth locations. Press the gasket into the mating socket recesses, so the metal-carrying retainer end of the gasket is seated completely and uniformly in the socket groove. Take care that no gasket loops or bulges protrude into the path of the entering pipe spigot. In extremely cold weather conditions, gaskets should be warmed before installing. (One way to keep gaskets warm is to keep them in a truck or heated vehicle cab until they are ready to be used.)



Incorrect

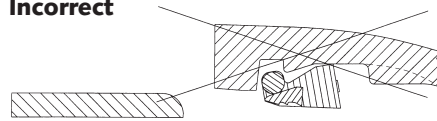

Incorrect

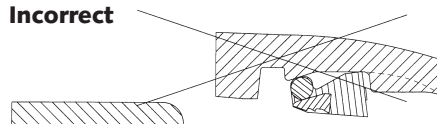

Incorrect

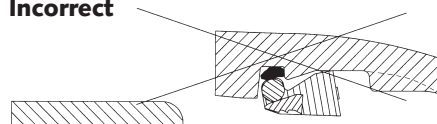

Correct

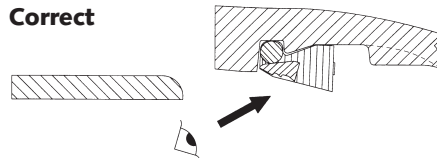



AMERICAN Amarillo Fast-Grip® Gasket

Assembly Instructions—Continued

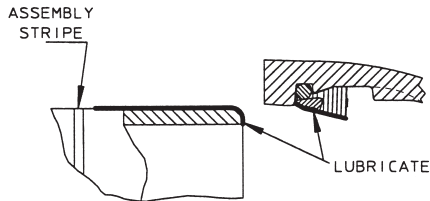

3. Lubrication of the Joint

With a clean brush, apply a liberal amount of regular Fastite lubricant completely **over the end of the pipe, the spigot radius, and the outer surface of the pipe up to the assembly stripe.** Also apply lubricant completely over the exposed inner surface of the gasket. AMERICAN supplies an extra 10% of lubricant to be used with the Amarillo Fast-Grip joints to ensure ease of assembly. **Use only lubricant provided by AMERICAN.** For underwater conditions, special AMERICAN underwater lubricant is recommended and is available upon request.

4. Initial Placement of Bevel End Into Socket

The spigot end of the pipe should be in reasonably straight alignment before it is placed into the socket. Center the spigot in the gasket so it makes firm and even contact with the inner surface of the gasket. Do not place pipe spigot in socket while in a substantially deflected position.



5. Complete Assembly of Plain End Into Socket

For 4" -18" sizes, simply push the bevel end into the bell until it contacts the rear of the socket. Desired joint deflection may then be set.



If the joint is to be deflected less than 2 1/4° for 20", 1 3/4° for 24", and 1° for 30", simply push the pipe spigot until it contacts the back of the socket and deflect. If the joint is to be deflected greater than these amounts, push the pipe spigot into the bell (while in straight alignment) only until the leading edge of the factory-applied yellow assembly stripe is even with the face of the bell. The desired deflection up to the maximum may then be set.

Abnormal joint assembly loads or behavior, such as unexplained exposure of the assembly stripe outside the bell, may indicate improper cleaning, gasket insertion, spigot placement, or lubrication. In any joint assembly, **a thin feeler gauge passed between the bell and spigot all around the assembled joint can be used to confirm correct gasket placement. (See figure below.)** Any joint with apparent problems should be disassembled and corrected before filling and testing the pipeline. (See Disassembly Instructions.)

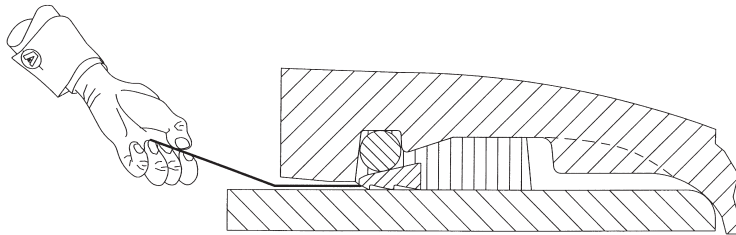



AMERICAN Amarillo Fast-Grip® Gasket

Assembly Instructions—Continued

Field-Cut Pipe

When pipe is cut in the field, the cut end must be properly prepared prior to assembly. In 18" and larger sizes, the ordering and use of a few select pipes that have been "gauged full length" at the factory should be considered when field cuts are anticipated.

Using a portable grinder or other suitable device, place an approximately 3/8" - to 5/8"-long smooth assembly chamfer or bevel on the outside end of the pipe. This bevel should make an angle of 30-40° with the axis of the pipe. Care should be taken to ensure that all corners are rounded and no sharp edges remain that might damage or dislodge the gasket.

If deflection greater than 2 1/4", 1 3/4", and 1° is required for 20", 24", and 30" field-cut

pipe, respectively, place an assembly mark on the pipe, respectively, as shown. The spigot should be inserted into the bell during assembly only until the mark becomes even with the bell face. Spigot insertion to the field-applied assembly mark will result in a space between the spigot and the back of the socket.

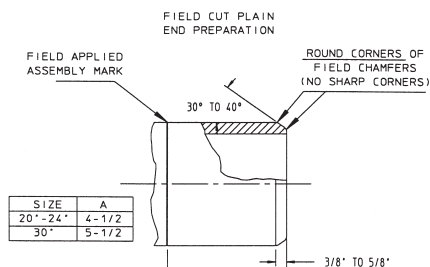

Allowable Joint Deflection for 4"-30" Fastitex Ductile Iron Pipe with Amarillo Fast-Grip Gaskets



Size In.	Nominal Laying Length ft.	Maximum Recommended Deflection	
		X Offset per 20' Length (in.)	Y Deflection Angle
4	20	21	5°
6	20	21	5°
8	20	21	5°
10	20	21	5°
12	20	21	5°
14	20	17	4°
16	20	12	3°
18	20	12	3°
20	20	12	3°
24	20	12	3°
30	20	10	2 1/2°

† Allowable deflection for Flex-Ring sockets with Amarillo Fast-Grip gaskets is the same as above for Fastite.



AMERICAN Amarillo Fast-Grip® Gasket

Assembly Instructions—Continued

Disassembly Instructions

Amarillo Fast-Grip gasket joints may normally be disassembled if required. Disassembly kits, consisting of a steel shim holder and special high-strength steel disassembly shims, are required for this operation and are available from AMERICAN. For easier disassembly of a joint that has been subjected to separating thrust or movement, first push the spigot back into the rear of the socket to “unwedge” the teeth.



Using gloves to protect hands from sharp edges, insert a shim fully into the groove in the shim holder.

Starting at the bottom of the joint, carefully drive the disassembly shim past the gasket between the outside of the spigot and the gasket by striking the holder with a hammer. Remove the holder from the shim, and progressively place other shims in this manner all around the joint.

Shims should be in contact with one another to ensure all teeth are disengaged from the spigot. Overlapping of some shims may be required to dislodge all teeth. After all shims are in place, pull or jack the spigot out of the socket.



Very tight joints may have to be separated by cutting pipe. The reuse of Fast-Grip gaskets after disassembly is not advised.

Joint Extension After Installation

The Amarillo Fast-Grip gasket locking mechanism is activated by relative movement

between the spigot and socket. The joint thus allows for movement, joint take-up, and substantial flexibility after installation. Joints may be extended after assembly to minimize joint take-up in test or service and for further assurance of correct joint locking. This may be accomplished by pulling or jacking the spigot away from the socket until firm resistance is encountered. This will not prevent proper joint deflection. In vertical applications such as exposed risers, standard (weld bead) Flex-Ring joints that also should be effectively extended and braced in original installation are recommended instead of Fast-Grip gaskets.



In most underground installations, including most restrained bend locations, joint take-up is advantageous in that increased thrust-resisting soil forces are generated. Also, expansion and contraction due to temperature variations may be accommodated without excessive stress in the pipe members. The amount of joint take-up or line movement in buried restrained pipelines is substantially limited by the surrounding soil. Therefore, system security and safety is maximized by filling and testing restrained sections of pipelines after backfilling.

In any application where axial movement may be undesirable, such as some exposed piping applications, or certain connections of restrained pipe sections at angles to rigid piping, special provisions, including effective joint extension, may be necessary to control unacceptable pipeline movement. Depending on job conditions and restrained pipe length, cumulative joint take-up can be substantial, particularly in exposed or unburied piping applications.



AMERICAN Fast-Grip® Gasket

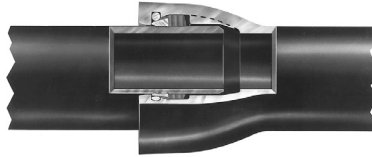

American Fast-Grip gaskets have been proven to be a superior field-adaptable method of restraining 4"-30" ductile iron pipe or fittings for water service.

The restraint provided by the patented* AMERICAN Fast-Grip® gasket is due to the development of wedging action between pairs of high-strength stainless steel elements spaced around the gasket. The outer metal element acts as a bearing member for the wedge-shaped inner element which has sharp teeth on its inner surface for gripping the spigot.

Because of the wedging design utilized, the force between the spigot and the socket of the joint is essentially constant at any given pressure thrust regardless of the "tightness" or "looseness" of the joint fit or the joint deflection.

Fast-Grip gaskets are suitable for an allowable water working pressure of 350 psi for 4"-18"*** pipe and 250 psi for 20" and 24"*** sizes. The 30" size is suitable for a 150 psi working pressure. The joint has a maximum allowable deflection of 5° in the 4"-12", 4° in the 14", 3° in the 16"-24", and 2 1/2° in the 30" size.

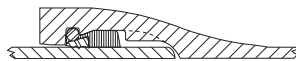
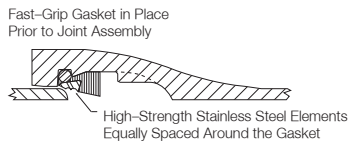

Proof-of-design tests have confirmed that the joints are capable of restraining deadend thrust of two or more times the rated working pressure,

as applicable. These tests were accomplished with the joints in both straight alignment and at the maximum rated deflection.

The Fast-Grip gasket has the same basic shape as AMERICAN's Fastite® gasket, so it can be used in any 4"-30" standard Fastite pipe or fitting socket. The gasket rubber is standard SBR*** which meets all the material requirements of ANSI/AWWA C111/A21.11.

Fastite**** fittings per ANSI/AWWA C110/A21.10 or C153/A21.53 are available in 18"-30" sizes. When they are available on the jobsite, AMERICAN's 16"-30" Flex-Ring® fittings may also be used with the Fast-Grip gasket.

The Fast-Grip gasket is Underwriters Laboratories listed and Factory Mutual approved for use in Fastite or Flex-Ring sockets with Fastite plain ends in all sizes 4"-16". The UL listing and FM approvals apply to all pressure classes and special thickness classes of ductile iron pipe.

In addition to the positive restraint achieved, Fast-Grip gaskets offer ergonomically friendly advantages compared to other restrained joints for fittings and pipe requiring bolts, lugs, segments, wrenches, etc. Joints can easily be assembled with current tools and methods used for many years in the assembly of standard Fastite joints. Assembly and disassembly instructions follow.



* U.S. Patent No. 5,067,751.

** Because the pressure rating of the joint cannot exceed that of the pipe, the 350 psi rating for 14"-18" sizes and the 250 psi rating for 24" size are limited by the pressure class of pipe with which they are used. For example, an 18" Fast-Grip gasket used with Pressure Class 250 pipe would carry a rating of 250 psi instead of 350 psi. Contact AMERICAN for higher working pressure applications.

*** Contact AMERICAN if other types of rubber are required.

**** Contact AMERICAN for the availability of fitting plain ends.



AMERICAN Fast-Grip® Gasket

Assembly Instructions

Assembling pipe and fitting joints using Fast-Grip gaskets is simple. It is very similar to the assembly of Fastite joints shown in Section 2. Fast-Grip gaskets may be used in lieu of standard Fastite gaskets in the bells of Fastite and Flex-Ring joint pipe and fittings where easy, field-adaptable restraint is desired.



1. Cleaning of Socket and Spigot

Clean the socket and plain end thoroughly, removing any mud, sand, gravel, ice, frozen material, or other matter that could prevent a proper joint seal. Material in the gasket grooves may cause the gasket to protrude into the path of the entering spigot. Therefore, **it is important that all joint recesses be kept clean during insertion of the gasket and assembly of the joint to prevent gasket dislodgment and/or subsequent leakage.**

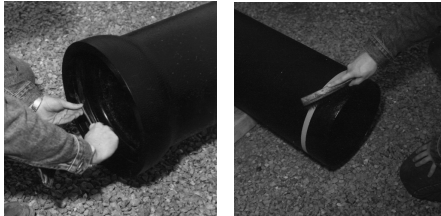

2. Placement of Gasket

Wipe the gasket clean. After flexing one or more "loops" in the gasket, insert the gasket in the gasket recess of the socket with the large sealing end of the gasket toward the rear of the socket. The center of the gasket loops should be positioned between tooth locations. Press the gasket into the mating socket recesses, so the metal-carrying retainer end of the gasket is seated completely and uniformly in the socket groove. Take care that no gasket loops or bulges protrude into the path of the entering pipe spigot. In extremely cold weather conditions,



gaskets should be warmed before installing. (One way to keep gaskets warm is to keep them in a truck or heated vehicle cab until they are ready to be used.)

Incorrect

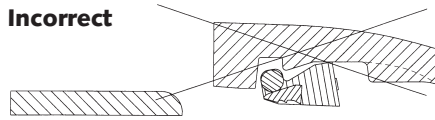

Incorrect

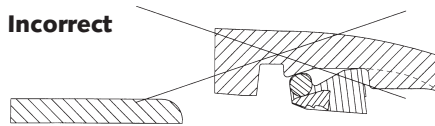

Incorrect

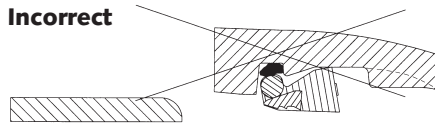

Correct

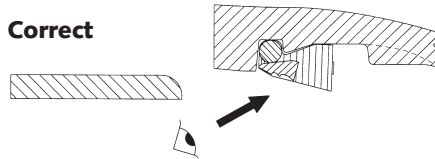



AMERICAN Fast-Grip® Gasket

Assembly Instructions—Continued

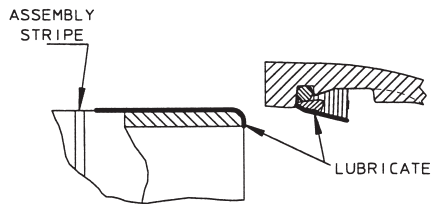

3. Lubrication of the Joint

With a clean brush, apply a liberal amount of regular Fastite lubricant completely **over the end of the pipe, the spigot radius, and the outer surface of the pipe up to the assembly stripe.** Also apply lubricant completely over the exposed inner surface of the gasket. AMERICAN supplies an extra 10% of lubricant to be used with the Fast-Grip joints to ensure ease of assembly. **Use only lubricant provided by AMERICAN.** For underwater conditions, special AMERICAN underwater lubricant is recommended and is available upon request.

4. Initial Placement of Bevel End Into Socket

The spigot end of the pipe should be in reasonably straight alignment before it is placed into the socket. Center the spigot in the gasket so it makes firm and even contact with the inner surface of the gasket. Do not place pipe spigot in socket while in a substantially deflected position.



5. Complete Assembly of Plain End Into Socket

For 4"-18" sizes, simply push the bevel end into the bell until it contacts the rear of the socket. Desired joint deflection may then be set.



If the joint is to be deflected less than 2 1/4° for 20", 1 3/4° for 24", and 1° for 30", simply push the pipe spigot until it contacts the back of the socket and deflect. If the joint is to be deflected greater than these amounts, push the pipe spigot into the bell (while in straight alignment) only until the leading edge of the factory-applied yellow assembly stripe is even with the face of the bell. The desired deflection up to the maximum may then be set.

Abnormal joint assembly loads or behavior, such as unexplained exposure of the assembly stripe outside the bell, may indicate improper cleaning, gasket insertion, spigot placement, or lubrication. In any joint assembly, **a thin feeler gauge passed between the bell and spigot all around the assembled joint can be used to confirm correct gasket placement. (See figure below.)** Any joint with apparent problems should be disassembled and corrected before filling and testing the pipeline. (See Disassembly Instructions.)

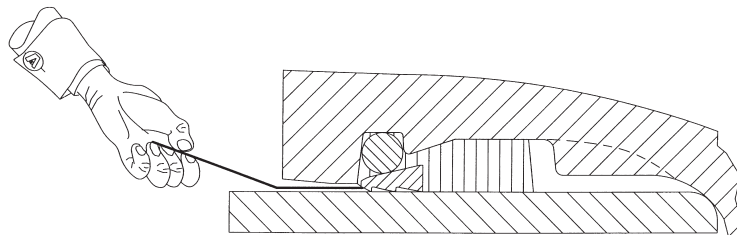



AMERICAN Fast-Grip® Gasket

Assembly Instructions—Continued

Field-Cut Pipe

When pipe is cut in the field, the cut end must be properly prepared prior to assembly. In 16" and larger sizes, the ordering and use of a few select pipes that have been "gauged full length" at the factory should be considered when field cuts are anticipated.

Using a portable grinder or other suitable device, place an approximately 3/8"- to 5/8"-long smooth assembly chamfer or bevel on the outside end of the pipe. This bevel should make an angle of 30-40° with the axis of the pipe. **Care should be taken to ensure that all corners are rounded and no sharp edges remain that might damage or dislodge the gasket.**

If deflection greater than 2 1/4", 1 3/4", and 1" is required for 20", 24", and 30" field-cut

pipe, respectively, place an assembly mark on the spigot as shown. The spigot should be inserted into the bell during assembly only until the mark becomes even with the bell face. Spigot insertion to the field-applied assembly mark will result in a space between the spigot and the back of the socket.

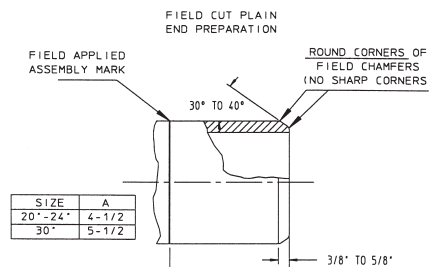

Allowable Joint Deflection for 4"-30" Fastite† Ductile Iron Pipe with Fast-Grip Gaskets

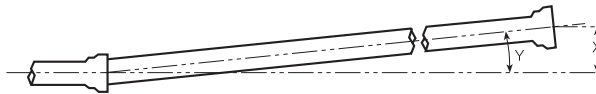

Size In.	Nominal Laying Length ft.	Maximum Recommended Deflection	
		X Offset per 20' Length (in.)	Y Deflection Angle
4	18	19	5°
6	20	21	5°
8	20	21	5°
10	20	21	5°
12	20	21	5°
14	20	17	4°
16	20	12	3°
18	20	12	3°
20*	20	12	3°
24*	20	12	3°
30*	20	10	2 1/2°

† Allowable deflection for Flex-Ring sockets with Fast-Grip gaskets is the same as above for Fastite.

* Allowable deflection for 20", 24", and 30" Fastite AWWA C110 fitting joints with Fast-Grip gaskets 2 1/4", 1 3/4", and 1", respectively.

Assembly of Fittings

Pipe and fittings joints can be easily assembled with current tools and methods used for many years in the assembly of Fastite joints. A line of "assembly yokes" and associated rigging for 4"-16" sizes are available that allow easy assembly

of fitting configurations, such as 90° bends, etc. Field rigging for larger-sized fitting assemblies can normally be accomplished with common grab chains, wire rope choker cables, etc. as per photographs in Section 4.



AMERICAN Fast-Grip® Gasket

Assembly Instructions—Continued

*Fast-Grip gasketed joints requiring a particular orientation (such as with bends) should be assembled in the intended service position. In some instances, this may be accomplished more easily by first assembling the bend on a pipe above the trench. The jointed bend and pipe may then be lowered (orienting as required) and assembled into place. **Relative rotation of joint members to one another after assembly is not recommended as it could cause damage or leakage.***

See Push-On Fittings Assembly Instructions in Section 4.



Disassembly Instructions

Fast-Grip gasket joints may normally be disassembled if required. Disassembly kits, consisting of a steel shim holder and special high-strength steel disassembly shims, are required for this operation and are available from AMERICAN. For easier disassembly of a joint that has been subjected to separating thrust or movement, first push the spigot back into the rear of the socket to “unwedge” the teeth.

Using gloves to protect hands from sharp edges, insert a shim fully into the groove in the shim holder.

Starting at the bottom of the joint, carefully drive the disassembly shim past the gasket between the outside of the spigot and the gasket by striking the holder with a hammer. Remove the holder from the shim, and progressively place other shims in this manner all around the joint.

Shims should be in contact with one another to ensure all teeth are disengaged from the spigot. Overlapping of some shims may be required to dislodge all teeth. After all shims are in place, pull or jack the spigot out of the socket.



Very tight joints may have to be separated by cutting pipe. The reuse of Fast-Grip gaskets after disassembly is not advised.

Joint Extension After Installation

The Fast-Grip gasket locking mechanism is activated by relative movement between the spigot and socket. The joint thus allows for movement, joint take-up, and substantial flexibility after installation. Joints may be extended after assembly to minimize joint take-up in test or service and for further assurance of correct joint locking. This may be accomplished by pulling or jacking the spigot away from the socket until firm resistance is encountered. This will not prevent proper joint deflection. In vertical applications such as exposed risers, standard (weld bead) Flex-Ring joints that also should be effectively extended and braced in original installation are recommended instead of Fast-Grip gaskets.



In most underground installations, including most restrained bend locations, joint take-up is advantageous in that increased thrust-resisting soil forces are generated. Also, expansion and contraction due to temperature variations may be accommodated without excessive stress in the pipe members. The amount of joint take-up or line movement in buried restrained pipelines is substantially limited by the surrounding soil. Therefore, system security and safety is maximized by filling and testing restrained sections of pipelines after backfilling.

In any application where axial movement may be undesirable, such as some exposed piping applications, or certain connections of restrained pipe sections at angles to rigid piping, special provisions, including effective joint extension, may be necessary to control unacceptable pipeline movement. Depending on job conditions and restrained pipe length, cumulative joint take-up can be substantial, particularly in exposed or unburied piping applications.



AMERICAN Ductile Iron Flex-Ring® Joint Pipe

Centrifugally Cast for Water, Sewage, or Other Liquids

4"-12" Flex-Ring® Joint

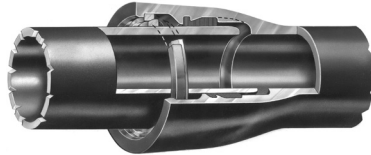

AMERICAN Flex-Ring® Restrained Joint Ductile Iron pipe, utilizing the sealing features of the time-proven Fastite® Joint and a boltless restrained connection, provides flexible, easily assembled, positive restraint against endwise separation due to thrust.

The patented¹ Flex-Ring Joint is designed for a working pressure² equal to that of the pipe or up to 350 psi in sizes 4"-24" and up to 250 psi in sizes 30" and 48". The joint has been thoroughly factory tested to withstand dead-end thrust resulting from more than twice those working pressures.

Flex-Ring® joint pipe with its positive, flexible joint restraint may also be used in trenchless applications such as **horizontal directional drilling** and pipe bursting. With spigot ahead, the low-profile Flex-Ring® bell assembles quickly and offers a smooth transition during pipe pull-back. AMERICAN offers a Flex-Ring® pulling bell assembly specifically designed for this installation method.



Pulling Bell Assembly

14"-54" Flex-Ring® Joint

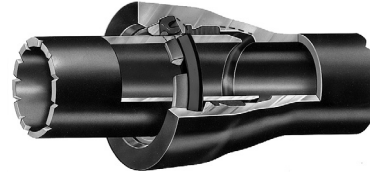

For 4"-12" sizes, a beveled ductile iron, welded-on retainer ring and a yellow painted ductile iron split flex-ring, assembled behind the retainer ring, provide the means of restraint. After the plain end of the pipe is assembled into the Flex-Ring bell, the split flex-ring is inserted and springs into the socket locking groove. The flex-ring is securely positioned behind the welded-on retainer ring and in the socket locking groove on the inside of the pipe bell. This provides the flexible restraint.

For 14"-54" sizes, a shop-applied weld bead and a rubber-backed ring, containing yellow painted ductile iron segments, provide the means of restraint. As the plain end of the pipe is fully assembled into the bell, the ductile iron segments automatically close on the pipe behind the weld bead. The enclosure of the segments between the weld bead, spigot, and the sloped inner lip of the bell provides the flexible restraint.

The Flex-Ring Joint can be safely deflected after assembly to the limits shown in Table Nos. 9-1 and 9-2. This liberal deflection facilitates installation, decreases the number of necessary fittings, and accommodates settlement.

The Flex-Ring Joint is Underwriters Laboratories listed and Factory Mutual approved in sizes 4"-12". This UL listing and FM approval applies to all pressure classes and special thickness classes of ductile iron pipe. The only joint components needed to assemble the Flex-Ring Joint are a gasket and a single ring.

¹ U.S. Patent Nos. 4,643,466, 4,685,708, and 5,197,768
² If higher working pressures are required, check AMERICAN.



AMERICAN Ductile Iron Flex-Ring® Joint Pipe

Centrifugally Cast for Water, Sewage, or Other Liquids

No loose lugs, heavy wedges, rubber tubes, etc. are necessary. Also, there is no need to orient bells to ensure proper installation, though for convenience, most installers orient the split locking ring ends in 4"-12" sizes away from the very bottom of the joints. Just follow the simple instructions shown on the following pages, and positive restraint is ensured.

Flex-Rings, Flex-Ring segments, and retainer rings are manufactured of ductile iron compatible with pipe. Welds and weld beads (if used) are nickel-iron, proven desirably cathodic to the ductile iron pipe, and welding is performed using welders qualified to produce high-quality, dependable welds.

Fittings for use with 16"- 48" Flex-Ring pipe are ductile iron and meet or exceed the applicable performance and manufacturing requirements of ANSI /AWWA C110/A21.10 or ANSI/AWWA C153/A21.53. These are rated

for the same working pressures shown for like fittings in C110 and C153. Fittings in these sizes are also available in both bell-bell and bell-Flex-Ring spigot configurations for installation versatility and economy.

AMERICAN Flex-Ring® pipe and fittings are normally furnished with standard asphaltic coating outside and cement lined in accordance with ANSI/AWWA C104/A21.4. Special coatings and linings can be furnished when specified.

Field closures or other restraint can normally be securely made by using AMERICAN's Fast-Grip® gasket, which is available in 4"-30" sizes. (See page 9-2 for details of the Fast-Grip gasket.)The Fast-Grip® gasket restraint closure is UL listed and FM approved for use in Flex-Ring and Fastite bells in 4"-16" sizes. Field closures or other restraint in 14"-36" sizes can also be made in Flex-Ring bells only by using AMERICAN's Field Flex-Ring®. (See page 9-16.)



AMERICAN Ductile Iron Flex-Ring® Joint Pipe
Standard Dimensions and Pressure Ratings

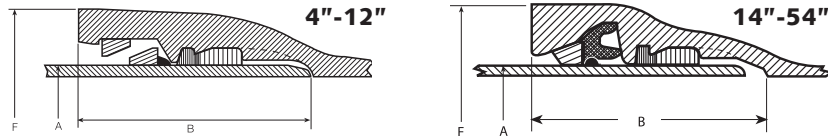

Table No. 9-1 **4"-12"**

Size in.	Working Pressure* psi	Nominal Laying Length** ft.	A O.D. in.	B Socket Depth in.	F Bell O.D.† in.	Allowable Pulling Load lb.††	Allowable Deflection degree	Offset per 20' Length in.	Radius of Curve^ ft.	Empty Pipe Buoyancy in Water (lb/ft)^^^
4	350	20	4.80	5.62	7.06	10,000	5	21	230	-5
6	350	20	6.90	5.62	9.19	20,000	5	21	230	-2
8	350	20	9.05	5.74	11.33	30,000	5	21	230	3
10	350	20	11.10	6.72	13.56	45,000	5	21	230	11
12	350	20	13.20	6.72	15.74	60,000	5	21	230	19

* Working pressure is the maximum pressure rating of the joint and is based on its capability to resist thrust due to internal pressure. If higher working pressure is required, check AMERICAN.

** Laying length is nominal 20'. Where exact lengths are required, contact AMERICAN. Minimum laying lengths for Flex-Ring & Flex-Ring End pipe is 1'-0" and for Flex-Ring End & Flex-Ring End pipe is 2'-0".

† Dimensions subject to change at our option. Check AMERICAN if smaller or exact dimensions are required.

†† Intended for Horizontal Directional Drilling (HDD) applications, so these pulling loads are for a fully deflected position. Flex-Ring pipe may be available for greater pulling loads than indicated in the tabulated values. **Contact AMERICAN when higher pulling loads are required.**

^ Approximate radius of curve produced by a succession of 20' lengths of pipe fully deflected.

^^ Based on weight of empty (full of air) Pressure Class 350 Flex-Ring pipe with standard cement lining immersed in water. Positive numbers indicate such pipe will float.

Table No. 9-2 **14"-54"**

Size in.	Working Pressure* psi	Nominal Laying Length** ft.	A O.D. in.	B Socket Depth in.	F Bell O.D.† in.	Allowable Pulling Load lb.††	Allowable Deflection degree	Offset per 20' Length in.	Radius of Curve^ ft.	Empty Pipe Buoyancy in Water (lb/ft)^^^
14	350	20	15.30	7.38	19.31	75,000	4	17	285	27
16	350	20	17.40	7.38	21.08	95,000	3 3/4	16	305	38
18	350	20	19.50	8.20	23.70	120,000	3 3/4	16	305	52
20	350	20	21.60	8.20	25.37	150,000	3 1/2	15	327	69
24	350	20	25.80	8.96	29.88	210,000	3	12	380	104
30	250	20	32.00	9.63	36.34	220,000	2 1/2	10	458	175
36	250	20	38.30	9.63	43.10	310,000	2	8	570	266
42	250	20	44.50	10.84	49.92	390,000	2	8	570	359
48	250	20	50.80	12.37	56.36	500,000	2	8	570	484
54	250	20	57.56	12.74	63.90	650,000	1 1/2	8	570	632

* Working pressure is the maximum pressure rating of the joint and is based on its capability to resist thrust due to internal pressure. If higher working pressure is required, check AMERICAN. Pressure rating of the joint is limited by the pressure rating of the parent pipe.

** Laying length is nominal 20'. Where exact lengths are required, contact AMERICAN. See below for minimum laying lengths for 14"-48" Flex-Ring.

† Dimensions subject to change at our option. Check AMERICAN if smaller or exact dimensions are required.

†† Intended for Horizontal Directional Drilling (HDD) applications, so these pulling loads are for a fully deflected position. The tabulated values are based on Pressure Class 350 pipe thickness. **Contact AMERICAN when it may be desirable to use lesser pressure class pipe or when higher pulling loads are required.** Flex-Ring pipe may be available for greater pulling loads than indicated in the tabulated values.

^ Approximate radius of curve produced by a succession of 20' lengths of pipe fully deflected.

^^ Based on weight of empty (full of air) Pressure Class 350 Flex-Ring pipe with standard cement lining immersed in water. Positive numbers indicate such pipe will float.

Minimum Laying Lengths

Size in.	Flex-Ring & Flex-Ring End	Flex-Ring End & Flex-Ring End
14	1'-6"	2'-0"
16	1'-6"	2'-0"
18	1'-6"	2'-0"
20	1'-6"	2'-0"
24	2'-0"	2'-6"
30	2'-0"	2'-6"
36	2'-0"	2'-6"
42	2'-0"	3'-0"
48	2'-6"	3'-0"
54	3'-0"	3'-6"



**AMERICAN Ductile Iron Flex-Ring® Joint Pipe
Assembly Instructions
4"-12"**

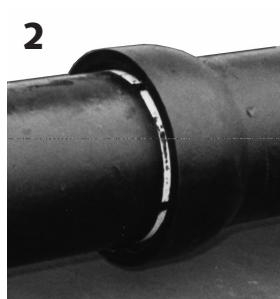

Prior to joint assembly, remove the packing material holding the split flex-ring onto the pipe. (See "Field Assembly of Flex-Ring" if split flex-ring is shipped separately.) Thoroughly clean the socket locking groove as well as the Fastite gasket recess and pipe plain end. In accordance with standard Fastite joint assembly instructions, insert the gasket and lubricate the pipe plain end, bevel, and inside surface of the gasket. With the pipe in essentially straight alignment, assemble the plain end into the Flex-Ring socket until the spigot stripe disappears into the bell. The orientation of the spigot stripe relative to the bell face is an indication of pipe alignment.

1. Tap the flex-ring into the socket beginning with one end of the flex-ring and progressing around the joint as shown in Photo 1. This

operation is made easier by holding one end of the flex-ring inside the bell as the remainder of the ring is caulked into the socket. Correct seating is generally ensured by a snapping noise as the flex-ring springs into position. This should be accompanied by visual or tactile inspection (the flex-ring is painted yellow to aid in this inspection). (Note: When a visual inspection to determine the flex-ring position is not practical, such as in an underwater installation, a feeler gauge can be used to ensure the correct positioning of the flex-ring in the socket locking groove. It may be necessary to move the entering pipe slightly to improve alignment if the ring does not readily spring into the socket locking groove.)

2. The completed joint.



This bridge crossing illustrates design/construction advantages, including the deflection capabilities of AMERICAN Flex-Ring Joint Pipe.



AMERICAN Ductile Iron Flex-Ring® Joint Pipe Assembly Instructions 4"-12"



FIELD ASSEMBLY OF FLEX-RING

If the split flex-ring is shipped separately, assemble it onto the pipe spigot by spreading the Flex-Ring ends as shown above. Be sure that the flex-ring is oriented so that the small end is toward the pipe plain end.



DISASSEMBLY OF 4"-12" FLEX-RING

If disassembly of the joint is required, it may be accomplished by inserting pins or nails into the drilled holes furnished in the flex-ring ends and compressing the flex-ring firmly onto the pipe as shown above. If desired, steel pins can be field welded onto the ends of common adjustable pliers, if such a disassembly tool is more desirable to the user. If axial movement or joint extension has occurred in the joint prior to disassembly, it may be necessary to move the spigot completely to the rear of the socket in straight alignment to allow the Flex-Ring to be compressed for removal.

THE FOLLOWING INFORMATION PERTAINS TO 4"-54" JOINTS:

NOTE: The AMERICAN Flex-Ring Joint allows for joint take-up and flexibility after installation. In most underground installations, including most restrained bend locations, this feature is advantageous in that increased thrust-resisting soil forces are generated. Also, expansion and contraction due to temperature variations may be accommodated without excessive stress in the pipe members.

In any application where axial or lateral movement may be undesirable, such as certain bridge crossings, certain exposed or unburied piping applications, or certain connections of restrained pipe sections to rigid piping, special provisions, including effective joint extension, may be necessary to control unacceptable pipe-

line movement. (See also Section 7, Pipe-On-Supports, etc.)

Depending on job conditions and restrained pipe length, cumulative joint take-up can be substantial, particularly in exposed or unburied piping applications. In this regard, joints may be extended after assembly to minimize further joint take-up in test or service. This will not prevent proper joint deflection.

The amount of joint take-up or line movement in buried restrained pipelines is substantially limited by the surrounding soil. Therefore, system security and safety is maximized by filling and testing restrained sections of pipelines after back-filling as recommended by ANSI/AWWA C600, [Installation of Ductile Iron Water Mains and Their Appurtenances](#) and AWWA M41.



AMERICAN Ductile Iron Flex-Ring® Joint Pipe Assembly Instructions 14"-54"

1) Cleaning and Fastite gasket insertion

Thoroughly clean the socket restraining groove (nearest the bell end), the Fastite gasket recess, and the pipe plain end, removing dirt, sand, ice, mud, or any other material which could prevent the proper placement of the Fastite gasket and flex-ring. As in normal Fastite joint assembly, insert the gasket into the gasket socket groove

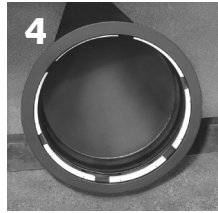
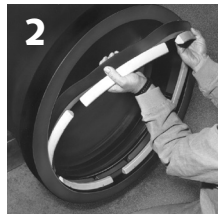

(1). Important: A Fastite gasket must also be used, because the rubber-backed flex-ring does not perform any sealing function. 2) Placement of the flex-ring in socket and joint lubrication

Remove the flex-ring from its container and place it in the socket restraining groove in gasket-like fashion (Photo 2). The **yellow** restraining segments of the flex-ring must be oriented toward the entering spigot. This may be done by first placing the flex-ring in the socket groove by forming one or more inward or lateral loops in the rubber backed ring (Photo 3). Work all inward or lateral loops fully outward and planar such that each metal segment fits reasonably flush against the

wedging surface of the socket, and no rubber bulges or twists remain (Photo 4).

Lubricate the inside surface of the gasket and the first four inches of the spigot including the beveled nose end of the pipe. Do not allow the lubricated spigot end of the pipe to contact the ground prior to insertion.

3) Initial placement of Flex-Ring spigot end into socket

With the spigot in reasonably straight alignment and centered within the flex-ring (Photo 5),

insert the spigot until it contacts the back of the socket per normal Fastite joint assembly procedure. (See Section 2 for additional detail on Fastite assembly procedures.) When

the weld bead is in proper assembled position fully beyond the yellow Flex-Ring segments, every segment will be trapped firmly between the weld bead, the spigot, and the wedging surface of the socket.

Verify the correct positioning of the yellow Flex-Ring segments by visual inspection (or by "feeler" gauge if installed in conditions of poor visibility).

The segments will normally snap directly into the correct assembled position. However, if any segment should not come down firmly onto the pipe at any location, deflect the pipe slightly in that direction, thereby allowing the segment to seat itself correctly.

After joint assembly, the joint may be extended and then deflected within the range of allowable joint deflection for the size of pipe being assembled.

4) Assembly of fittings

Flex-Ring pipe and fitting joints can generally be assembled with the same tools and methods used for many years with Fastite joints. When using a field-cut pipe to locate a fitting, it may be advantageous to use an uncut flex-ring spigot end (with factory weld bead) and a standard Flex-Ring in the fitting socket rather than using a field-cut plain end and Field Flex-Ring with

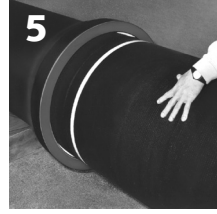



AMERICAN Ductile Iron Flex-Ring® Joint Pipe Assembly Instructions 14"-54"

black-toothed gripping segments. A Field Flex-Ring and cut pipe plain end may then be used in the nearest pipe socket on either side of the fitting. When possible, the use of standard flex-ring with yellow segments and factory spigots with weld beads in the sockets of a fitting may allow easier orientation or rotation of the fitting relative to the pipe after assembly, if this is needed. (See Section 4 for additional detail on the assembly of Fastite fittings.)

5) Joint extension after installation

The 14" - 54" Flex-Ring locking mechanism allows approximately one inch of free axial movement and also provides substantial flexibility after installation. However, the joints may be extended after assembly to minimize this joint takeup in test or service conditions.

In most underground installations (including most restrained bend locations), joint take-up is advantageous in that increased thrust-resisting forces are generated. Also, expansion and contraction due to temperature variations may be accommodated without excessive stress in pipe members. The amount of joint take-up or line movement in buried restrained pipelines is substantially limited by the surrounding soil. There-

fore, system security and safety is maximized by filling and testing restrained sections of pipelines **after** backfilling as recommended by ANSI/AWWA C600, Installation of Ductile Iron Water Mains and Their Appurtenances and AWWA M41.

In any application where axial or lateral movement may be undesirable, such as certain bridge crossings, certain exposed or unburied piping applications, or certain connections of restrained pipe sections to rigid piping, special provisions, including effective joint extension, may be necessary to control unacceptable pipeline movement.

Depending on job conditions and restrained pipe length, cumulative joint take-up can obviously be substantial, particularly in exposed piping applications. Where joint pre-extension is necessary in a piping system, it may be accomplished by pulling or jacking the spigot away from the socket until firm resistance is encountered. This will not limit joint flexibility. See "Restrained Joint Pipe Assembly Extension Procedure" in this section of the Pipe Manual for more information concerning joint extension.



The versatile performance capabilities of AMERICAN Flex-Ring Joint Pipe are perfectly suited for projects containing a variety of conditions such as the hilly, rocky terrain shown in this photo.



AMERICAN Ductile Iron Flex-Ring® Joint Pipe Disassembly Instructions for 14"-54" Flex-Ring Joints

Flex-Ring joints may be disassembled if required using sharp wedges and 3/16"-1/4" thick disassembly shims. Flex-Ring disassembly sets are available from AMERICAN and are suggested for disassembly. These disassembly sets include two sharp steel starter wedges and an appropriate number of "L"-shaped shims. The wedges are used to start the separation of the yellow Flex-Ring joint locking segments outward from the spigot while it is in the bell of an already assembled joint. The "L"-shaped shims are then hammered between the spigot and each locking segment. The thicker shims lift the locking segments entirely away from the spigot when fully inserted, and allow the spigot weld bead to pass under the locking segments generally located as shown in Figs. 1 and 2. Step-by-step instructions follow:

1. First straighten the joint as much as possible and push or pull the spigot back into the bell until it "bottoms out" in the rear of the socket. (Fig. 3)

2. Hammer a starter wedge under a yellow locking segment until an approximately 1/8" gap is seen between the segment and the spigot. (Fig. 4)

3. Hammer a second wedge (if necessary to start the shims) under the other end of the locking segment as in step 2.

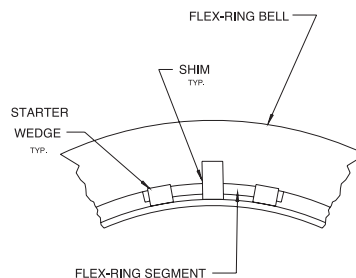

Figure 1
Starter shim and wedge arrangement for 14", 18", and 20" sizes.

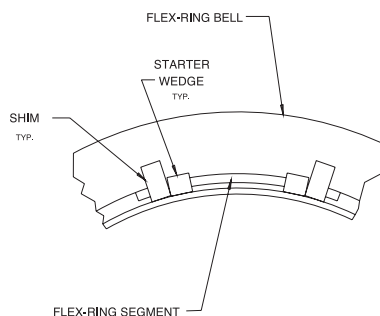

Figure 2
Shim and wedge arrangement for 16", 24", 30", 42", 48", and 54" sizes.

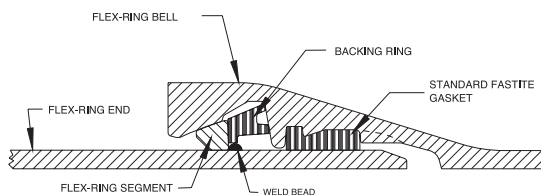

Figure 3

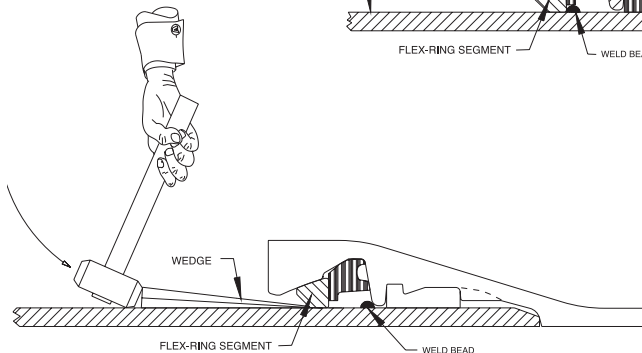

Figure 4

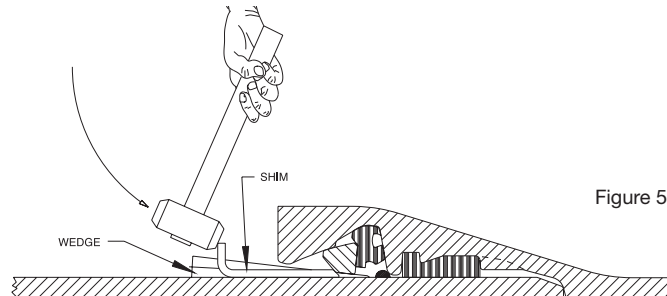

Figure 5

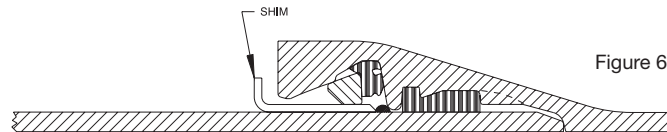

Figure 6

4. With a large hammer (such as a six pounder) vigorously drive one or two “L”-shaped shims under the locking segment until the ends of the shims firmly contact the spigot weld bead. (Fig. 5) Shims and wedges can be safely and firmly held against the pipe as they are hammered using a block of wood or a board. Safety precautions such as the wearing of safety glasses and keeping clear of the hammer during striking should always be taken to avoid injury.

5. Remove the starter wedges from between the locking segment and spigot, leaving the shim(s) in place. (Fig. 6) Note that the wedges are reused for each locking segment.

6. Drive wedges and shims under all locking segments as shown in steps 2-5. (See photo.) Check to be sure that the inner surface of all segments will not interfere with the spigot weld bead during joint separation after inserting shims.

7. Separate the joint. During joint separation, it is generally best to pull the spigot straight out of the socket. Extreme back and forth deflecting motions of the spigot during joint separation can cause shims to fall out of the joint and/or relocking to occur. If the joint does not readily come apart, check to see if one or more of the segments is in locking contact with the spigot weld bead. If so, push or deflect the spigot back in that location and add or replace shims as required.



Disassembly kits accompanied by instructions for use can be furnished by AMERICAN upon request.



AMERICAN Ductile Iron Flex-Ring® Joint Pipe Field Flex-Ring®

4-inch, 6-inch, 8-inch and 12-inch



The AMERICAN Field Flex-Ring is a field adaptable restrained joint utilizing a grooved fabricated end in conjunction with a corrosion-resistant, high-strength, low-alloy (HSLA) steel Field Ring. AMERICAN Field Flex-Ring® Restrained Joint Ductile Iron Pipe, utilizing the sealing features of the time-proven Fastite® Joint and a one-bolt restrained connection, provides flexible, easily assembled and positive restraint against endwise separation due to thrust.

The AMERICAN Field Flex-Ring is an integral part of the AMERICAN Flex-Ring Joint restraint system on 4-, 6-, 8- and 12-inch ductile iron Flex-Ring Pipe and fittings as an easy, one-bolt field adaptable way of restraining field connections, which also does not require a factory or field weldment. Where field cuts are anticipated, the AMERICAN Field Flex-Ring may be used to restrain joints with any suitable ductile iron plain end or cut pipe for water service in lieu of a standard Flex-Ring Joint spigot with a factory welded-on ring.

The AMERICAN Field Flex-Ring is designed to restrain joints using the Flex-Ring sockets with the same allowable working

pressures and deflection capabilities as the standard Flex-Ring Joint. (See Table 9-1.) Field Flex-Rings may be used with a minimum 53 thickness class ductile iron pipe with a maximum working pressure of 350 psi. Restrained joints using the AMERICAN Field Flex-Ring have been thoroughly factory tested to withstand dead end thrust resulting from more than twice the rated working pressure.

For the 4-, 6-, 8- and 12-inch sizes, the restraint is provided by wedging action between the beveled corrosion-resistant, high-strength, low-alloy (HSLA) steel Field Ring and a yellow painted ductile iron split Flex-Ring assembled behind the retainer ring. Once the grooved fabricated end is created and the Field Ring is installed, the Field-Flex Ring spigot end behaves identically to the Flex-Ring spigot end. After the spigot end of the Field Flex-Ring pipe is assembled into the Flex-Ring bell, the split Flex-Ring is inserted and springs into the socket locking groove. The Flex-Ring is securely positioned behind the bolt-on retainer ring and in the socket locking groove on the inside of the pipe bell, providing the flexible restraint.

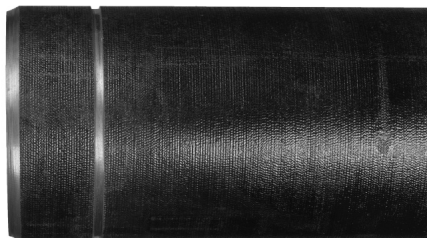



AMERICAN Ductile Iron Flex-Ring® Joint Pipe Field Flex-Ring® 4-inch, 6-inch, 8-inch and 12-inch Assembly Instructions

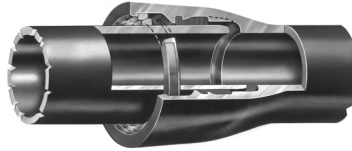

AMERICAN Field FLEX-RING® Spigot Rings are intended for use with AMERICAN Flex-Ring® Ductile Iron Pipe, 4-, 6-, 8- and 12-inch, for thickness classes 53 through 56 per ANSI/AWWA C151/A21.51 having a pressure rating of 350 psi.

Field-Cut Joint

Measure the pipe diameter at the desired cut distance to ensure it meets the ANSI/AWWA C111/A21.11 tolerances. Cutting the pipe can be performed using abrasive wheels, torch or milling cutter. When the cut end is to be assembled in a Flex-Ring® bell, an adequately smooth (without sharp edges) bevel should be ground or filed on the cut edge to prevent damage to or dislodgement of the gasket during assembly (Figure 1). If desired, a thin field assembly line may be drawn in marker or paint, with the line located from the spigot end the same distance as the far edge of factory-applied assembly stripe.

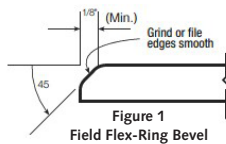

Groove Pipe

Several types of grooving machines are available that operate hydraulically, pneumatically, electrically, or are self-powered by a gasoline engine. The grooving machine will normally cut pipe from 4- to 64-inch diameter. The set-up time for this cutter is usually less than ten minutes; it requires a minimum clearance of 12 inches and has a cutting speed of approximately one minute per inch of pipe diameter. The grooving machine should be installed to provide the cut edge at the designated distance from the spigot end as shown in Table 1. The groove should be cut as a standard AWWA C606 groove as seen in Figure 2

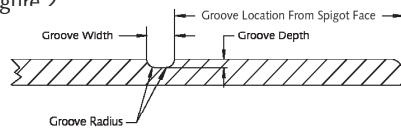

Table No. 9-3

Field Groove Dimensions				
Size	Groove Location From Spigot Face	Groove Width	Groove Depth	Groove Radius
4-inch	4.06 inches (+0.10/-0.03)	0.38 inches (+0.03/-0.02)	0.12 inches (+0.03/-0.02)	0.120 inches
6-inch	4.06 inches (+0.10/-0.03)	0.38 inches (+0.03/-0.02)	0.13 inches (+0.02/-0.03)	0.120 inches
8-inch	4.18 inches (+0.06/-0.06)	0.50 inches (+0.03/-0.02)	0.15 inches (+0.02/-0.05)	0.145 inches
12-inch	4.75 inches (+0.09/-0.04)	0.50 inches (+0.03/-0.02)	0.15 inches (+0.04/-0.03)	0.145 inches

Installing Field Flex-Ring

Once a proper AWWA C606 groove has been created at the specified distance from the spigot end, the specified coating system shall be applied to the grooved section, unless otherwise specified. Once the coating is dry to the touch install the Field Flex-Ring into the groove with the square side of the ring facing the spigot end, ensuring proper placement around the pipe (Photo 2). Using a 3/16-inch Allen wrench, tighten the bolt to approximately 3 to 5 ft-lbs of torque to snug ring in groove (not to exceed 9 ft-lbs of torque), making sure that the cleat on the ID of the spigot ring stays aligned with the groove on the pipe (Photo 4). The ring is sufficiently tight when the gap between the ends of the ring has almost completely closed and when it requires tapping on the ring with a hammer to make it move back and forth in the groove. Coat the installed Field Flex-Ring with the specified coating system, unless otherwise specified. (Photo 3) Once sufficiently dry, proceed with the 4- to 12-inch Flex-Ring assembly instructions.

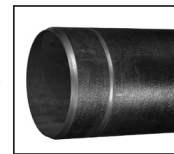

Photo 1



Photo 2



Photo 3



Photo 4



AMERICAN Ductile Iron Flex-Ring® Joint Pipe

Field Flex-Ring®

14"-36"

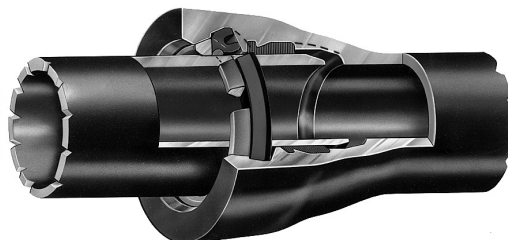

The AMERICAN Field Flex-Ring with black-toothed gripping segments is an integral part of the AMERICAN Flex-Ring Joint restraint system. The AMERICAN Field Flex-Ring method of restraining AMERICAN 14"-36" ductile iron Flex-Ring pipe and fittings is an easy, totally boltless and glandless way of restraining field connections, which also does not require a factory or field weldment. Where field cuts are anticipated, the Field Flex-Ring may be used to restrain joints with any suitable ductile iron plain end or cut pipe, for water service in lieu of a standard Flex-Ring joint spigot with a factory welded-on bead.

The patented* AMERICAN Field Flex-Ring is designed to restrain joints using Flex-Ring sockets with the same allowable working pressures and deflection capabilities as the standard Flex-Ring joint. (See Table 9-2.) Field Flex-Rings may be used with any standard pressure class of ductile iron pipe with an allowable working pressure equal to that of the pipe class, or a maximum of 350 psi in the 14"-24" sizes and 250 psi in the 30" and 36" sizes. Flex-Ring fittings are manufactured per ANSI/AWWA C110/A21.10 or ANSI/AWWA C153/A21.53.

Restrained joints using Field Flex-Ring have been thoroughly factory tested to withstand dead end thrust resulting from more than twice the rated working pressure. The restraint is provided by the wedging action of heat-treated, high-strength ductile iron segments. The segments have a wedge-shaped cross-section with gripping teeth on the inner surface.

The ductile iron segments are held in the proper position for assembly by a rubber backing ring. This rubber backing ring is compressed during assembly to ensure that the restraining segments are held firmly in place against the socket wedging surface and spigot. The positioning and compressive force exerted by the backing ring on the restraining segments result in dependable gripping of the spigot when thrust is applied.

The rubber backing ring for the Field Flex-Ring does not perform any sealing function for the joint. (A separate, standard Fastite gasket is employed in the joint for this purpose.) The backing ring is made of gasket-quality SBR rubber which meets all the material requirements of ANSI/AWWA C111/A21.11, Rubber-Gasketed Joints for Ductile-Iron Pressure Pipe and Fittings.



AMERICAN Ductile Iron Flex-Ring® Joint Pipe Field Flex-Ring® 14"-36" Assembly Instructions

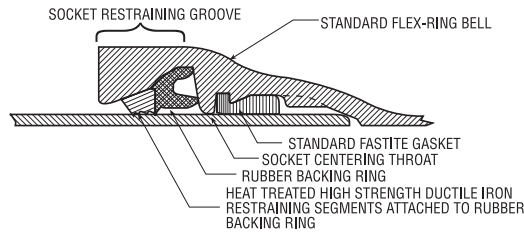

1) Cleaning, gasket insertion, spigot marking and lubrication of the joint

Remove the standard flex-ring with yellow metal segments from the socket, if present. Place an assembly mark on the spigot plain end located as shown in Table No. 9-3. Thoroughly clean the socket restraining groove (nearest the bell end), the Fastite gasket recess, and the pipe plain end, removing dirt, sand, ice, mud, or any other material that could prevent the proper placement of the Field Flex-Ring or Fastite gasket. As in normal Fastite joint assembly, insert the gasket into the gasket socket grooves, then lubricate the inside surface of the gasket.

Important : A Fastite gasket must be used as the Field Flex-Ring does not perform any sealing function. Lubricate the first four inches of the spigot, including the

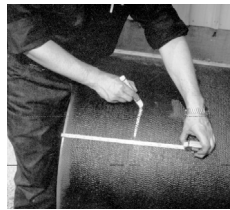

Spigot Assembly Stripe Location

Table No. 9-4

Pipe Size in.	Location of Stripe from spigot end
14-16	7 1/4"
18-20	8 1/16"
24	8 13/16"
30-36	9 1/2"

pipe end and bevel. Do not allow the spigot end of the pipe to touch the ground after it is lubricated.

2) Placement of the Field Flex-Ring in socket

Remove the Field Flex-Ring with black-toothed gripping segments from its container and place it in the socket restraining groove (nearest to the bell end) in gasket-like fashion. The metal restraining segments of the

Field Flex-Ring should be oriented toward the entering spigot. This may be done by first placing the Field Flex-Ring in the groove at the bottom of the socket, so that the rubber backing ring is fitted flush against the radial surface of the socket centering throat.

The rubber ring may then be worked into the restraining groove around the sides of the socket until a loop is formed at the top. At this time, the formation of a second smaller loop at the bottom of the socket will

facilitate placement of the first looped section into the top of the socket restraining groove.





It is often easier to properly insert the top loop of the Field Flex-Ring by pushing it axially into the socket after it has been allowed to protrude beyond the face of the bell. The second smaller loop may then be pushed radially outward into the restraining groove.

Any bulges present in the rubber backing ring after it is placed in the socket should be removed. This may normally be done by simply pushing the protruding rubber radially outward. Some bulges may require forming a small loop



in the ring opposite the bulge. The ring may then be allowed to slide circumferentially around the socket toward the loop, thus relieving rubber compression in the bulging area. Make sure that the angled bearing surface of the segments are secure against the socket, and the toothed side of the segments are facing inward. This should be done by examining and pushing each segment toward the back of the socket until the rubber backing ring is firmly in place against the socket centering throat.

3) Initial placement of beveled plain end into socket

With the spigot in reasonably straight alignment and centered within the Field Flex-Ring, insert the spigot until it contacts the back of the socket per normal Fastite joint assembly procedure. Joint deflection may be taken immediately after assembly. Verify correct position of the locking segments in the fully assembled joint.

(Note: The complete insertion of a factory supplied spigot stripe on a Fastite pipe into the deeper Flex-Ring socket does not indicate full assembly. The use of a field-applied assembly mark is recommended.)



4) Field-cut pipe

A) Selecting pipe: When possible, an appropriate pipe to be field cut should be selected before it is required. This may be done by measuring the outside diameter or circumference of the pipe at the location to be cut. The measured diameter or circumference of the candidate pipe should be within the ranges shown in Table No. 9-4. In 16" and larger sizes, the ordering and use of a few select pipes that have been gauged full length at the factory should be considered when field cuts are anticipated.

B) Preparing pipe end when making a field cut: The cut end must be properly prepared prior to assembly. The pipe should be cut as square as possible with the pipe axis and beveled on the outside extreme end after cutting.



A portable grinder should be used to make a bevel 3/8" to 5/8" long at an angle of 30-40° with the axis of the pipe. All sharp corners or rough edges that might damage or dislodge the Fastite gasket or Field Flex-Ring should be removed from the beveled pipe end.

Table No. 9-5 Recommended Spigot Diameters at Pipe Field-Cut Locations

Pipe Size in.	Diameters		Circumference	
	Min. in.	Max. in.	Min. in.	Max. in.
14	15.22	15.35	47 ¹³ / ₁₆	48 ⁷ / ₃₂
16	17.32	17.45	54 ¹³ / ₃₂	54 ¹³ / ₁₆
18	19.42	19.55	61	61 ¹³ / ₃₂
20	21.52	21.65	67 ¹⁹ / ₃₂	68
24	25.72	25.85	80 ¹³ / ₁₆	81 ⁷ / ₃₂
30	31.94	32.08	100 ¹¹ / ₃₂	100 ²⁵ / ₃₂
36	38.24	38.38	120 ¹ / ₈	120 ⁹ / ₁₆



C) Rounding Clip Set:

Rounding clips* are available from AMERICAN and are helpful when making a

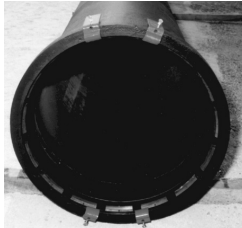

joint using an out-of-round field-cut end. These clips may be readily attached to a Flex-Ring bell containing a Field Flex-Ring to quickly and easily round a pipe spigot during insertion assembly.

When using rounding clips with a severely oval field-cut pipe, they may be placed at the 12:30, 5:30, 6:30, and 11:30 o'clock** positions. The spigot should then be oriented with the maximum diameter in a vertical position and, while in reasonably straight alignment, centered within the funnel formed by the rounding clips. The spigot will then be automatically rounded when inserted into the socket. The rounding clips should then be removed after assembly and reused as needed.

* U.S. Patent No. 5,426,842

** Due to actual field conditions and pipe shape, adjustment of rounding clip locations may be needed.

5) Assembly of fittings

Flex-Ring pipe and fitting joints using Field Flex-Rings can be assembled with the same tools and methods used for many years with Fastite joints. When using a fieldcut pipe to locate a fitting, it may be advantageous to use a standard Flex-Ring spigot with a factory weld bead and a standard flex-ring with yellow metal segments in the fitting rather than pipe socket. A Field Flex-Ring with black-toothed gripping segments and cut pipe plain end may then be used in the nearest pipe socket on either side of the fitting. When possible, the use of a standard flex-ring and a factory spigot with weld bead in the sockets of a cumbersome fitting may allow easier orientation or rotation of the fitting relative to the pipe after assembly. The use of a pipe socket with a Field Flex-Ring may also facilitate easier alignment of the joint during insertion assembly and installation. (See Section 4 for additional detail on the assembly of Fastite fittings.)

6) Deflection

Flex-Ring joints using Field Flex-Rings have an allowable deflection equal to those of standard Flex-Ring joints (Table No. 9-2). Deflection may be taken immediately after full insertion of the spigot into the socket.

7) Joint extension after installation

The Field Flex-Ring locking mechanism is activated by relative movement between the socket and spigot. This allows for movement, joint take-up and substantial flexibility after installation. The joints may be extended after assembly to minimize joint take-up in test or service conditions. This may be accomplished by pulling or jacking the spigot away from the socket until firm resistance is encountered. This will not limit joint deflection.

In vertical applications, such as exposed risers, standard (weld bead) Flex-Ring joints that also should be effectively extended and braced in original installation are required instead of Field Flex-Rings.

In most underground installations (including most restrained bend locations), joint take-up is advantageous in that increased thrust-resisting forces are generated. Also, expansion and contraction due to temperature variations may be accommodated without excessive stress in pipe members. The amount of joint take-up or line movement in buried restrained pipelines is substantially limited by the surrounding soil. Therefore, system security and safety is maximized by filling and testing restrained sections of pipelines after backfilling as recommended by ANSI/AWWA C600, [Installation of Ductile Iron Water Mains and Their Appurtenances](#) and AWWA M41.

In any application where axial or lateral movement may be undesirable, such as some exposed or unburied piping applications, or certain connections of restrained pipe sections to rigid piping, special provisions, including effective joint extensions, may be necessary to control unacceptable pipeline movement. Depending on job conditions and restrained pipe length, cumulative joint take-up can be substantial, particularly in exposed piping applications.



8) Disassembly instructions

Flex-Ring joints containing Field Flex-Rings may normally be disassembled if required. Field Flex-Ring disassembly kits, consisting of a shim holder and high-strength disassembly shims, are available from AMERICAN. (Use Fast-Grip disassembly kits for the 14"-16" sizes.) In some cases, due to the time and effort involved for disassembly of these joints, it may be preferable to disassemble the pipeline at the nearest standard Flex-Ring (using a standard flex-ring and spigot weld bead) or other joint. In this manner, the Field Flex-Ring-joined pipes and/or fittings can be removed as a unit.

If joint disassembly is required, a disassembly kit should be used in accordance with the procedure below to separate a Flex-Ring joint containing a Field Flex-Ring.

Disassembly Procedure:

A) If the joint has been subjected to separating thrust, movement, or joint deflection, first push the spigot back into the rear of the socket so as to "unwedge" the straining segments.



B) Using gloves to protect hands from sharp edges, insert the long end of a disassembly shim fully into the groove in the shim holder. Two lengths of shims are supplied with the 18"-36" disassembly kit for customer convenience. The shorter shims may often be easier to use in some hard-to-reach locations such as the bottom of a joint, or when a small gap exists between the longer shims.



C) Carefully drive a disassembly shim between the gripping teeth of the segments and the spigot with a hammer. Lifting or offsetting of the spigot relative to the socket (to relieve

metal-to-metal contact) may be required to insert some shims. It is sometimes easier to start a shim under the teeth if the holder is initially placed near one end of the shim (off center) so that one corner of the shim is inserted first. The holder may then be slid along the shim to start the middle, while the other end of the shim is placed under the teeth.

D) When properly in place, the end of the shim should be visible 1/4" to 3/4" outside the socket for the 14"-16" sizes and 1 1/2" to 2" for the 18"-36" sizes. Remove the holder from the shim and progressively place other shims around the joint. It is often easier to drive a shim under the teeth if the edge of one shim is initially inserted 1/8" to 1/4" under the previously placed shim. Shims should be in contact with one another to ensure all teeth are disengaged from the spigot. Overlapping of some shims may be required to dislodge all teeth.



E) After all shims are inserted, place a reference mark on the spigot even with the exposed end of the shims. Pull, jack, or deflect the spigot

out from the socket. After the spigot has been pulled from the socket approximately 1 1/2" to 2", check the positioning of each shim. Any shim found to have been pulled out of the socket 1/2" or more from its original position should be tapped back into the socket. The procedure of pulling the spigot out of the socket 1 1/2" to 2" and adjusting the shim positioning may have to be repeated several times before the joint is completely disassembled. *NOTE: The measured distance between the reference mark on the pulled-out spigot and the exposed edge of the shims (when shims are fully in place inside the socket) is indicative of the length of spigot removed from the socket. A very tight joint may have to be separated by cutting the pipe with a pipe saw or oxyacetylene torch.*



AMERICAN DUCTILE IRON PIPE

AMERICAN Ductile Iron Lok-Ring® Joint Pipe

Centrifugally Cast for Water, Sewage, or Other Liquids
54"-64"

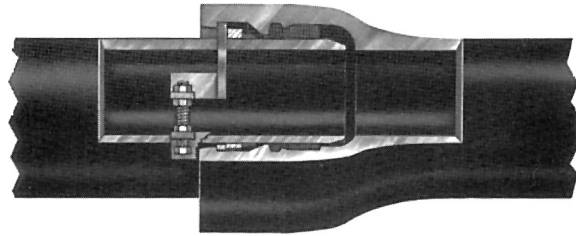

The AMERICAN Lok-Ring® Joint is another restrained joint that utilizes the sealing features of the time-proven AMERICAN Fastite Joint. It is an essentially boltless, flexible restrained connection that provides an easily assembled positive restraint against endwise separation due to thrust resulting from internal pressure or external forces. Only a minimal amount of time is required to complete the Lok-Ring assembly, or disassembly if necessary.

The patented* AMERICAN Lok-Ring® Joint is designed for working pressures up to 250 psi for sizes 54" through 64". It can be used with any lesser pressure class of ductile iron pipe with the maximum operating pressure rating of the joint limited in such cases to that of the pipe. An alloy steel welded-on retainer ring and a split lok-ring, assembled behind the retainer ring, provide the means of restraint. The split lok-ring is held "snug" against the pipe O.D. for assembly of the AMERICAN Fastite portion of the joint. After the plain end of the pipe is assembled into the Lok-Ring bell, the lok-ring is released, permitting it to expand. The lok-ring is thus securely positioned behind the welded-on retainer ring and in the socket locking groove on the I.D. of the Lok-Ring bell. This locks the joint.

The joint can be easily disassembled if the need arises, using the closure-spreader mechanism provided for this purpose. The lok-ring, welded retainer ring and all parts of the closure-spreader mechanism are all constructed of cor-

rosion-resistant, high-strength, low-alloy (HSLA) steel. This is the same type steel specified for bolting material per ANSI/AWWA C111/A21.11. The alloy steel of the lok-ring and the welded retainer ring is also the same material that has been used successfully in several AMERICAN restrained joint constructions for approximately 40 years. The weld is aluminum bronze (also as was used in the Lok-Fast Joint), and both the weld and ring are cathodic to, and thus protected by, the greater area of the ductile iron pipe. Welding is performed using welders qualified to produce high-quality, dependable welds.

Standard Fastite gaskets and lubricant are used with the AMERICAN Lok-Ring® Joint. (See Section 2 for gasket compounds.) AMERICAN recommends underwater lubricant where the joint is to be assembled in very wet conditions or under water.

The AMERICAN Lok-Ring® Joint is designed to permit deflection in order to facilitate installation and accommodate settlement. It may be safely deflected after assembly to the limits shown in Table No. 9-7. These deflection values have proven adequate for thousands of Lok-Ring joints furnished over the past several years and exceed the deflection capabilities of many types of restrained joints that have performed successfully for many years in buried service. It is noted that rotation of the lok-ring under great loads helps to distribute the forces substantially around and between the bell and spigot members.

* U.S. Patents 4,428,604 and 4,524,505.



AMERICAN Ductile Iron Lok-Ring® Joint Pipe

Centrifugally Cast for Water, Sewage, or Other Liquids

AMERICAN Lok-Ring® Pipe is ductile iron, grade 60-42-10, manufactured and tested in accordance with AWWA C151. It is normally furnished standard asphaltic coated outside and cement lined in accordance with AWWA C104. When specified, other special coatings or linings can be furnished as described in Section 11.

A full complement of AMERICAN Lok-

Ring ductile iron fittings is available. These fittings are available in both bell-bell and bell-plain end configurations for installation versatility and economy. Lok-Ring fittings meet applicable requirements of ANSI/AWWA C153/A21.53 and are pressure rated for at least 250 psi in most configurations. Check AMERICAN if higher pressure is required. See Section 4.

Standard Dimensions

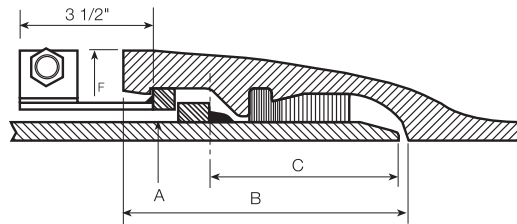

Table No. 9-6

Size in.	Working Pressure* psi	Nominal Laying Length† ft.	A Outside Diameter in.	B Socket Depth in.	C Plain End to Retaining Ring in.	F Bell O.D.†† in.	Retainer Ring	Lok-Ring
54	250	20	57.56	10.07	6.38	62.14	3/4" x 1 1/4"	3/4" sq.
60	250	20	61.61	10.57	6.38	66.27	3/4" x 1 1/4"	3/4" x 1 1/4"
64	250	20	65.67	10.57	6.38	70.45	3/4" x 1 1/4"	3/4" x 1 1/4"

*Working pressure is the maximum pressure rating of the joint and is based on its capability to resist thrust due to internal pressure. If higher working pressure is required, check AMERICAN.

†Laying length is nominal 20 feet. Where exact lengths are required, contact AMERICAN. (See minimum laying lengths in Table No. 9-6.)

††Dimensions subject to change at our option. Check AMERICAN if smaller or exact dimensions are required. Note that the struts may protrude slightly above the bell in one spot; contact AMERICAN if this may be critical to the application.



AMERICAN Ductile Iron Lok-Ring® Joint Pipe

Minimum Laying Lengths

Table No. 9-7

Size in.	Lok-Ring & Lok-Ring End	Lok-Ring End & Lok-Ring End
54	2'-0"	2'-6"
60	2'-6"	3'-0"
64	2'-6"	3'-0"

Allowable Joint Deflection

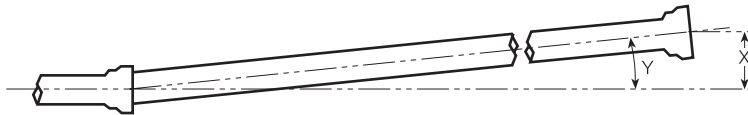

Table No. 9-8

Size in.	Nominal Laying Length ft.	Maximum Recommended Deflection	
		X Offset* per Length in.	Y Deflection Angle
54	20	2	1/2°
60	20	2	1/2°
64	20	2	1/2°

*Offset distances are based on 20' lengths of pipe.



AMERICAN Ductile Iron Lok-Ring® Joint Pipe Assembly Instructions

Thoroughly clean the socket locking groove as well as the Fastite gasket recess and pipe plain end, being sure to remove any mud, gravel, or any other foreign matter. Insert standard Fastite gasket and lubricate the joint components in accordance with standard Fastite assembly instructions and, with pipe in essentially straight alignment, assemble the plain end into the Lok-Ring bell. **(Photos 1 & 2.)** Assembly tools shown in **Photo 2** are available from AMERICAN on a rental basis for installers not electing assembly with a backhoe or other like equipment.

Once the spigot is completely inserted as evidenced by the spigot stripe disappearing into the bell (the orientation of the spigot stripe in relationship to the bell face is an indication of pipe alignment), loosen the outside stud closure nuts fully to the end of the stud to allow the lok-ring to spring outward and into the socket locking groove.* In lieu of the outside stud closure nut provided for this purpose, some installers prefer to install a "quick release" locking clamp or grip device beforehand (e.g., "outside the trench") and back the outside closure nut out of the way for very rapid assembly. **(Photo 3.)** The correct seating** of the lok-ring in the socket locking groove should be accompanied by an obvious spreading of the lok-ring struts. If

inspection around the joint reveals that the lok-ring is not completely seated in the annular socket locking groove at any location, the lok-ring may be completely seated by tapping the loose lok-ring into the socket locking groove with a flat caulking tool and/or by moving the entering pipe slightly. When a visual inspection to determine the lok-ring position is not practical, such as in an underwater installation, **a feeler gauge can be used to ensure that the lok-ring is correctly seated in the socket locking groove all around the joint. (Photo 4.)**

Once the lok-ring is correctly seated in the socket locking groove, turn the inside stud spreader nuts out firmly against the struts **(Photo 5.)** as shown to ensure firm contact of the lok-ring in the socket locking groove. **During the lok-ring spreading operation, the outside stud closure nuts should be positioned so as not to restrict the outward movement of the drilled struts on the stud.** (The outside stud closure nuts perform no function in the finished joint; however, these closure nuts can be used to effect simple disassembly of the joint, if required, by reversing the assembly procedure outlined above.) Once the inside spreader nuts are properly positioned, the lok-ring is positively secured in the socket locking groove.

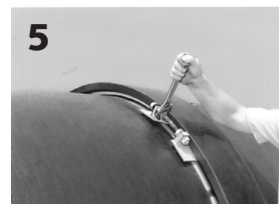
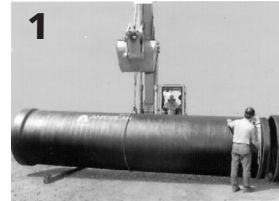

***Note:** The lok-ring is normally shipped in position on the pipe plain end behind the welded-on retainer ring. See page 9-25 if field assembly of lok-ring is required.

****Note:** It is **imperative** that the installer verify that the lok-ring is seated outward in the socket locking groove **completely** around each joint. Lok-rings are painted yellow to visually aid in this verification.



AMERICAN DUCTILE IRON PIPE

“Backward” installation. AMERICAN does not recommend “backward laying” (bells assembled over spigots, rather than spigots inserted into bells as pictured in this literature) of large-diameter ductile iron pipe in buried installations. AMERICAN can furnish bell and plain end fittings to minimize the need for backward pipe laying.

Other devices such as sleeves and couplings may also be employed for this reason. However, if this condition cannot be avoided, we strongly recommend that installers contact AMERICAN for instructions on how to reduce the potential for problems that could occur when assembling pipe in this manner.

FIELD ASSEMBLY OF LOK-RING

Should it be necessary to place the lok-ring on the pipe spigot in the field, unscrew and remove one outside stud closure nut to permit the lok-ring to be spread and positioned on the plain end of the pipe behind the welded-on retainer ring.

To complete field placing of the lok-ring on the pipe, reassemble the outside stud closure nut and tighten both outside stud closure nuts to pull lok-ring substantially flush against the pipe barrel and immediately behind the welded-on retainer ring.

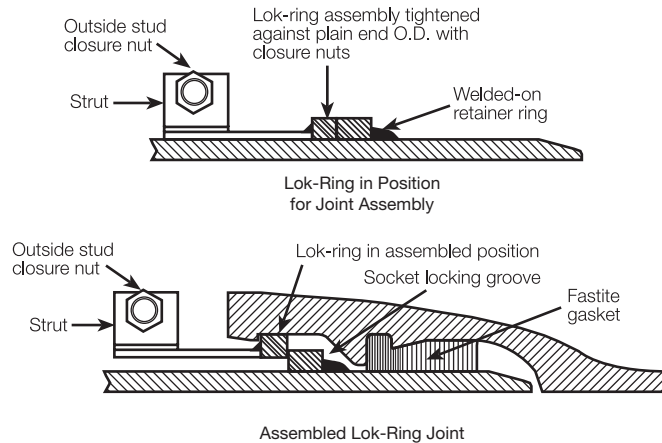

NOTE: The AMERICAN Lok-Ring Joint allows for joint take-up after installation. In most underground installations, including most restrained bend locations, this feature is advantageous in that increased thrust-resisting soil forces are generated. Also, expansion and contraction due to temperature variations may be accommodated without excessive stress in the pipe members.

In any application where axial or lateral movement may be undesirable, such as certain bridge crossings, certain other exposed or unburied piping applications, or certain connections of restrained pipe sections to rigid piping, special design or installation provisions, including effective joint extension, may be necessary to control any unacceptable pipeline movement.

Depending on job conditions and restrained pipe length, cumulative joint take-up can be substantial, particularly in exposed or unburied piping applications. In this regard, joints may be extended after assembly to minimize further joint take-up in test or service.

The amount of joint take-up or line movement in buried restrained pipelines is substantially limited by the surrounding soil. Therefore, system security and safety is maximized by filling and testing restrained sections of pipelines **after backfilling** as recommended by ANSI/AWWA C600, [Installation of Ductile Iron Water Mains and Their Appurtenances](#) and AWWA M41.



The AMERICAN Earthquake Joint System



The AMERICAN Earthquake Joint System combines the rugged, tough, and time-proven deflection performance of AMERICAN's Flex-Ring restrained joint pipe with the capacity to expand and contract.

The system is built around a central ductile iron Earthquake System casting that features in its design an extended socket depth allowing the specially placed Flex-Ring weld ring an expansive range of motion.

The ductile iron Earthquake System casting and Flex-Ring connecting piece arrive at the jobsite pre-assembled by our professional staff at our manufacturing plant. The extended socket receives a special Flex-Ring spigot end with a specially located restraining ring. The pre-assembled Earthquake System spigot has a double stripe, one showing full insertion and the other mid-point insertion. The illustration above shows the joint installed in the fully extended position, such that both assembly stripes are fully visible.

Pre-assembly means the on-site contractor needs to assemble only the familiar and conventional Flex-Ring joint. In this application, the Flex-Ring spigot on the central ductile iron

Earthquake System casting is red in color and machined instead of welded. Conventionally, it's a Flex-Ring joint and is assembled in the field in the same manner.

The AMERICAN Earthquake System joint may be assembled in the fully contracted position, allowing for maximum expansion; it may be assembled in the mid-point position, allowing for both joint expansion and contraction; or it may be assembled in the fully extended position, allowing for maximum joint contraction.

The more common is the mid-point position, which allows for both expansion and contraction during a seismic event.

After assembly, the AMERICAN Earthquake Joint System can expand and contract longitudinally and deflect at both joints. With deflection from the conventional Flex-Ring joint and additional deflection from the extended socket Flex-Ring joint, the assembly provides 8 degrees deflection for 6", 8" and 12"; 7 degrees for 16"; and 6 degrees for 20" and 24"; as well as 2.4 inches of either expansion or contraction. If assembled in the fully contracted or fully extended position, 4.8 inches of one-way longitudinal differential is available.

Standard Dimensions

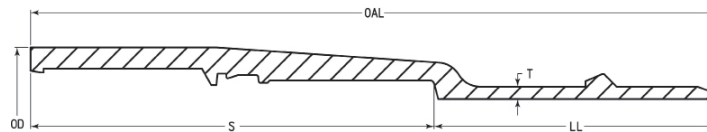

Table No. 9-9

Size (in.)	Working Pressure ¹ (psi)	Earthquake Casting OAL (in.)	Earthquake Casting LL (in.)	Socket Depth (in.)	Thickness (in.)	Bell OD (in.)	Spigot OD (in.)
6	350	25.63	10.53	15.10	0.43	9.54	6.9
8	350	25.93	10.71	15.22	0.45	11.78	9.05
12	350	27.60	11.38	16.22	0.49	16.34	13.2
16	350	31.75	14.31	17.44	0.70	20.54	17.40
20	350	32.20	15.02	17.18	0.80	25.20	21.60
24	350	33.70	16.44	17.26	0.89	29.46	25.80

¹Working pressure is the maximum pressure rating of the joint and is based on its capability to resist thrust due to internal pressure. If higher working pressure is required, contact AMERICAN.



AMERICAN DUCTILE IRON PIPE

Standard Dimensions (Continued)

Nominal full laying lengths for AMERICAN Earthquake Joint System assembled with AMERICAN Flex-Ring Joint Pipe*

Table No. 9-10

Size (in.)	Casting Fully Homed	Casting at Midpoint of Insertion	Casting Fully Extended	Casting Weight (lbs.)
6	20'-9.57"	21'-0.32"	21'-2.74"	104
8	20'-9.75"	21'-0.54"	21'-2.95"	140
12	20'-9.34"	21'-0.21"	21'-2.65"	263
16	20'-11.79"	21'-2.80"	21'-5.63"	419
20	21'-0.02"	21'-2.76"	21'-5.07"	610
24	21'-1.44"	21'-4.18"	21'-6.56"	779

* Subject to trim pipe allowances per AWWA C151. Where exact lengths are required, contact AMERICAN.

Table No. 9-11

Size (in.)	Working Pressure ¹ (psi)	Earthquake Casting OAL (in.)	Allowable Deflection (degrees)	Offset Per Nominal Assembly LL (in.)	Radius of Curvature (ft.)
6	350	25.63	8	35.12	150
8	350	25.93	8	35.15	150
12	350	27.60	8	35.10	150
16	350	31.75	7	31.05	174
20	350	32.20	6	26.63	203
24	350	33.70	6	26.78	204

Suggested Specification

As required on the project plans and in these specifications, in high-risk areas subject to earthquakes, a ductile iron system shall be provided that delivers joint deflection and longitudinal expansion and contraction. This system shall be the AMERICAN Earthquake Joint System or a system equal to or exceeding each of these performance criteria:

Table No. 9-12

Size (in.)	Pipe Joint Deflection	Casting Joint Deflection ¹	Combined Assembly Deflection	Longitudinal Extension from Mid-Point	Ultimate Dead End Thrust Resistance ²
6	5 degrees	3 degrees	8 degrees	± 2.4 inches	102,000 lbs
8	5 degrees	3 degrees	8 degrees	± 2.4 inches	136,000 lbs
12	5 degrees	3 degrees	8 degrees	± 2.4 inches	204,000 lbs
16	5 degrees	2 degrees	7 degrees	± 2.4 inches	272,000 lbs
20	4 degrees	2 degrees	6 degrees	± 2.4 inches	340,000 lbs
24	4 degrees	2 degrees	6 degrees	± 2.4 inches	408,000 lbs

¹This deflection is available from the mid-point, from full insertion, or from fully extended positions.

²Ultimate dead end thrust resistance from straight alignment and special thickness class 53 wall.



Suggested Specification (Continued)

Ductile iron earthquake resistant pipe shall meet all applicable requirements of **AWWA C150** (design), **AWWA C151** (manufacture), **AWWA C104** (lining), C111 (joints), **AWWA C153** (fittings), **AWWA C105** (polyethylene encasement), and **AWWA C600** (installation). The ductile iron pipe shall be sized in inches, and be special thickness class 53.

The piping shall meet defined classifications detailed below as shown in **ISO 16134 Earthquake Resistant Ductile Iron Pipe and Subsidence-Resistant Design**. The seismic design shall be verified by an independent seismic lab such as Cornell University or an owner-approved alternative.

1. All ductile iron pipe and fittings joints shall meet or exceed **3dKN pull out strength or category A**.
2. Designated Earthquake System piping shall meet or exceed a minimum deflection of **7.5 degrees or category M2** for sizes 6" - 12" and **equal to or under 7.5 degrees or category M3** for sizes 16" and above, whether in the mid-point, fully inserted, or fully extended positions.
3. Designated ductile iron Earthquake System piping will have a minimum **strain relief of plus or minus 1% or category S1**.

As a designation, the minimum requirements would be **A-M2-S1** per **ISO 16134** for sizes 6" - 12" and **A-M3-S1** for sizes 16" and

above, unless otherwise shown on plans and specifications.

The network of ductile iron pipe connected to the Earthquake Joint System shall have the exterior of the pipe coated with a layer of arc-sprayed zinc. The mass of the zinc applied shall be a minimum of 200 g/m² of pipe surface area, and the coating system shall conform in every respect to **ISO 8179-1, "Ductile Iron Pipes - External Zinc-Based Coating - Part 1: Metallic Zinc with Finishing Layer,"** second edition 2004-06-01. The zinc shall have a top coat of approved materials. (Component pieces and field touch up may require the use of a zinc-rich coating 85% zinc per **ISO-8179-part 2**).

The Earthquake System piping will be installed in the fully open, fully closed, or mid-point position per design criteria. To facilitate determining field joint alignment, the expansion spigot in the assembly shall have a minimum of two assembly stripes – one indicating fully contracted and one indicating the mid-point of extension. Full extension can be achieved by pulling the completed joint out until the joint stops movement.

In addition, the connected network of ductile iron pipe shall be encased in 8 mil **V-Bio polyethylene encasement** meeting the requirements of **AWWA C105** concerning both materials and installation.

The pipeline will be installed with a **locator tape** that identifies the buried line as an earthquake resistant pipeline. The tape will be a minimum 2 inches in width and red in color labeled "*Earthquake Resistant Pipeline Below.*"



The AMERICAN Earthquake Joint System

Assembly Instructions – 6-inch, 8-inch and 12-inch

General Note: The assembly of the AMERICAN Earthquake Joint System relies on the efficient and proven assembly features of the AMERICAN Flex-Ring joint. This system can be field assembled with various pushing or pulling devices and rigging to provide the nominal Fastite gasket assembly force of 100-300 lbs. times the outside diameter in inches.

The enhanced strain and deflection capabilities of the Earthquake system should be maximized by careful field positioning of a central ductile iron Earthquake casting bell joint. The design of this joint features an extended socket depth, allowing the extended Flex-Ring weld ring on the Earthquake spigot end an expansive range of motion.

1. Ensure the required material to assemble and extend the joint is available. This includes the Flex-Ring locking ring, Fastite gasket, AMERICAN Fastite lubricant, one lever hoist, two choker cables, one hydraulic ram and one split restraining gland. Prior to joint insertion, remove the full-length strap holding the Earthquake Joint in the contracted position (Figure 1) as well as the packing material holding the split Flex-Ring onto the casting spigot (Figure 2), unless Flex-Rings have been shipped separately.

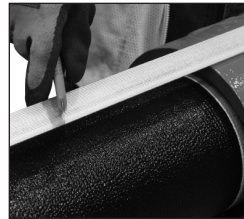

Figure 1



Figure 2

2. Thoroughly clean the pipe socket locking groove, the Fastite gasket recess and casting plain end in accordance with standard 4- to 12-inch Flex-Ring and Fastite joint assembly instructions.

3. In accordance with standard Fastite joint assembly instructions, insert the Fastite gasket ensuring gasket is flush without protrusions. Lubricate the inside surface of the gasket and the plain end of the casting up to the ring abutment, paying close attention to the beveled nose end of the casting. Ensure the lubricated portion of the casting does not come in contact

with the ground to ensure dirt and debris do not contaminate the surface during assembly.

4. With the pipe in essentially straight alignment, assemble the casting spigot end into the Flex-Ring pipe socket until the spigot stripe disappears into the bell. The orientation of the spigot stripe relative to the bell face is an indication of pipe alignment. For the most control and least disturbance of the intended position of the opposite Earthquake Joint and any previously



Figure 3

installed joint, assembly of the joint with a lever hoist and two choker slings is recommended. Assemble by installing one choker anchored around/behind the previously installed pipe bell and one anchored around the long bell cylinder of the Earthquake casting with the lever hoist between. Use the lever hoist to apply assembly force needed to position the joint fully homed (Figure 3).

5. Tap the split flex-ring into the bell's Flex-Ring socket beginning with one end of the split flex-ring and progressing around the joint (Figure 4). This operation is made easier by holding one end of the split flex-ring inside the bell as the remainder of the ring is tapped into the socket. Correct seating is generally indicated by a snapping noise as the split flex-ring springs into position. Visually confirm the ring is fully in position (the split flex-ring



Figure 4



is painted yellow to aid in this inspection). (Note: When a visual inspection to determine the split flex-ring position is not practical, such as with underwater installations, a feeler gauge may be used to verify the correct positioning of the Flex-Ring in the socket locking groove. It may be necessary to move the entering pipe slightly to improve alignment if the ring does not readily spring into the socket locking groove.)

6. When the fully contracted position is not desired, extension can be performed with the use of a split restraining gland and one hydraulic ram to extend the Earthquake casting to the desired position. Install the split restraining gland on the Earthquake spigot with the leading edge facing away from the bell face. Distance should be sufficient to install hydraulic ram (Figure 5). Once installed in straight alignment per manufacturer's



Figure 5



Figure 6

instructions, place the hydraulic ram between the split restrained gland and Earthquake casting bell face (Figure 6). Ensure consistent force is applied by the hydraulic ram until the desired placement is reached as indicated by paint stripes.

7. Once the Earthquake stripe location has been reached, remove the hydraulic ram and split restraining gland. After removal of restraining gland ensure the pipe coating has not been damaged during extension. If coating damage has occurred during extension, repair coating per the AMERICAN coating repair procedure. The

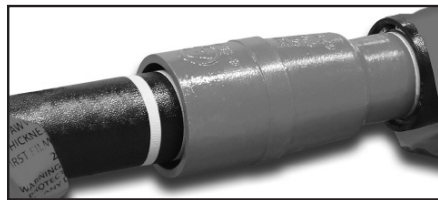

Figure 7

completed joint pictured in Figure 7 is in the intermediate position* as previously described, with the first assembly stripe of the opposite Earthquake joint fully inserted and flush with the bell face and the second stripe is fully exposed.

***Note:** The expansion/contraction position can be varied as desired by the positioning of the two assembly stripes of the bell joint of the Earthquake casting. When a position other than midpoint is desired, the stripe position can be adjusted by moving/telescoping the spigot of the Earthquake joint in or out the amount desired.



The AMERICAN Earthquake Joint System

Assembly Instructions – 16-inch, 20-inch and 24-inch

General Note: The assembly of the AMERICAN Earthquake Joint System relies on the efficient and proven assembly features of the AMERICAN Flex-Ring joint. This system can be field assembled with various pushing or pulling devices and rigging to provide the nominal Flex-Ring joint assembly force of 200-500 lbs. times the outside diameter in inches.

The enhanced strain and deflection capabilities of the Earthquake system should be maximized by careful field positioning of a central ductile iron Earthquake casting bell joint. The design of this joint features an extended socket depth, allowing the Flex-Ring weld ring on the Earthquake spigot end an expansive range of motion.

1. Ensure the required material to assemble and extend the joint is available. This includes (the rubber backed Flex-Ring, Fastite gasket, AMERICAN Fastite Lubricant, two lever hoists, four choker cables, two hydraulic rams and one split restraining gland). Remove the full-length strap holding the Earthquake Joint in the fully contracted position (Figure 1).

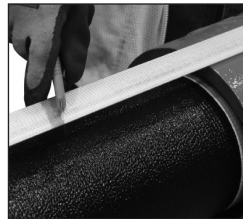

Figure 1



Figure 2

2. Thoroughly clean the pipe socket locking groove, the Fastite gasket recess area, and the casting plain end in accordance with standard 14-inch through 54-inch Flex-Ring and Fastite joint assembly instructions.

3. In accordance with 14- to 54-inch Flex-Ring joint assembly instructions, place the rubber-backed Flex-Ring in the socket restraining groove in gasket-like fashion. Ensure the yellow restraining segments are oriented toward the entering spigot and evenly spaced.

4. In accordance with standard Fastite joint assembly instructions, insert the Fastite gasket ensuring gasket is flush without

protrusions. Lubricate the inside surface of the gasket (Figure 2) and the red plain end of the casting up to the ring abutment, paying close attention to the beveled nose end of the casting. There is no need to lubricate the Flex-Ring rubber-backing ring or segments. Ensure the lubricated portion of the casting does not come in contact with the ground to ensure dirt and debris do not contaminate the surface during assembly.

5. With the pipe in essentially straight alignment, assemble the casting plain end into the Flex-Ring pipe socket until the spigot stripe disappears into the bell. The orientation of the ring abutment and spigot stripe relative to the bell face is an indication of pipe alignment.



Figure 3

Correct assembly is generally indicated by an audible snap of the Flex-Ring segments into the correct position; however, if any segment should not come down firmly on the casting, deflect the entering assembly slightly in that direction, allowing the segment to seat itself correctly. Verify the correct positioning of the yellow Flex-Ring segments by visual inspection or feeler gauge if conditions are limiting. The ring abutment is in the proper assembled position when it is fully beyond the yellow Flex-Ring segments and all segments are fully against the casting. For the most control and least disturbance of the intended position of the opposite Earthquake joint and any previously installed Earthquake castings, assembly of this joint using two lever hoists and four reasonably short choker slings is recommended. Assembly using two choker slings anchored around/behind the previously



installed pipe bell and two anchored around the long bell cylinder of the Earthquake casting with the two lever hoists between is best for applying the assembly force needed (Figure 3). Ensure even distribution of assembly force by tightening both lever hoists at the same rate.

6. When the fully contracted position is not desired, it is necessary to use a split restraining gland and two hydraulic rams to extend the Earthquake casting to the desired



Figure 4

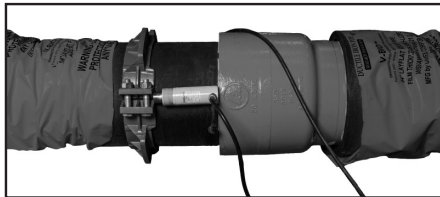

Figure 5

position. Install the split restraining gland on the Earthquake spigot with the leading edge facing away from the bell face at a distance sufficient to install hydraulic rams (Figure 4). Once installed in straight alignment per manufacturer's instructions, place the hydraulic rams between the split restraining gland and

Earthquake casting bell face. Ensure even and consistent force is applied by the hydraulic rams until the desired placement is reached as indicated by paint stripes (Figure 5).

7. Once the Earthquake pipe location has been reached, remove the hydraulic rams and split restraining gland. After removal of the restraining gland ensure the pipe coating has not been damaged during extension. If coating damage has occurred during extension, repair coating per the AMERICAN coating repair procedure. The completed joint pictured in Figure 6 is in the intermediate position* as previously described, with the first assembly stripe of the opposite Earthquake joint fully inserted and flush with the bell face, and the second stripe is fully exposed.

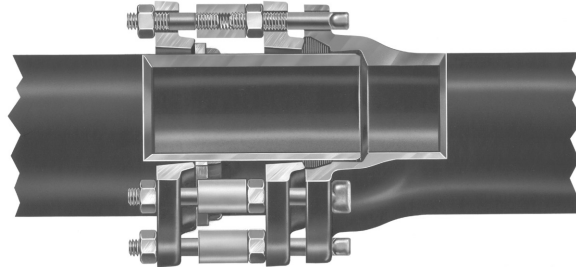

Figure 6

***Note: The expansion/contraction position can be varied as desired by the positioning of the two assembly stripes of the bell joint of the Earthquake casting. When a position other than midpoint is desired, the stripe position can be adjusted by moving/telescoping the spigot of the Earthquake joint in or out the amount desired.**



AMERICAN Ductile Iron MJ Coupled Joint Pipe



The MJ Coupled Joint offers a method of providing joint restraint with a standard Mechanical Joint socket of a pipe, fitting, valve, or other product. It is available in sizes 4"-12" with a pressure rating of 350 psi and deflection capability up to 2 1/2°, and in 14"-48" with a pressure rating of 250 psi intended for installation in essentially straight alignment. Check AMERICAN if larger sizes or greater deflections are desired. The MJ Coupled Joint is commonly used as a method of joint restraint for Mechanical Joint all bell fittings and valves.

The joint material consists of a standard MJ gasket and a standard ductile iron joint gland. The restraint gland* is ductile iron and is assembled on

the pipe behind a welded-on 1/2" square alloy steel retaining ring. Coupling nuts, studs, teehead bolts and nuts, and retaining ring are all alloy steel. Teehead bolts are special-length bolts.

* The restraint gland for 30"-48" sizes is a substantially rectangular cross-section ductile iron gland.

Note: It is sometimes possible to provide for field-cutting and positive, even "drop-in" field-adaptable restraint in restrained piping areas by using modified MJ Coupled joints where the weld ring and restraint gland are intentionally moved farther away from the joint, and the standard short studs of the joint are replaced by longer threaded rods in the field. Threaded rods, of course, can also be cut to suit in the field. Similar effect can also be accomplished utilizing standard fabricated, stuffing-box couplings and similarly modified "Coupling Gland Ends" (see pg 9-36). Contact AMERICAN for additional information on this.

Assembly Instructions

1. Assemble the Mechanical Joint according to standard MJ joint procedures with the pipe and/or fitting in essentially straight alignment. Note that the bolts for this joint are not standard length; special-length bolts are furnished for this joint by AMERICAN. Where tapped holes are encountered in fittings or in valves, use studs of the same special length as specified for the THHN Bolts.

2. Thread the coupling nuts onto the tee-head bolts and hand tighten against the hex nuts.** Install short, threaded end of studs into the coupling nuts.

3. Slide the gland into position and install outer hex nuts. (Note: If deflection is desired, it should be taken at this point prior to tightening the outer hex nuts.) Tighten to 20 ft-lb in order to draw gland substantially against welded-on ring on pipe. Joint is now complete.

** In 20" and 24" sizes only, the coupling nut is to be positioned not against the hex nut, but rather so that there is a minimum of 3/4" thread engagement with both the tee-head as well as stud threads.



**AMERICAN Ductile Iron
MJ Coupled Joint**

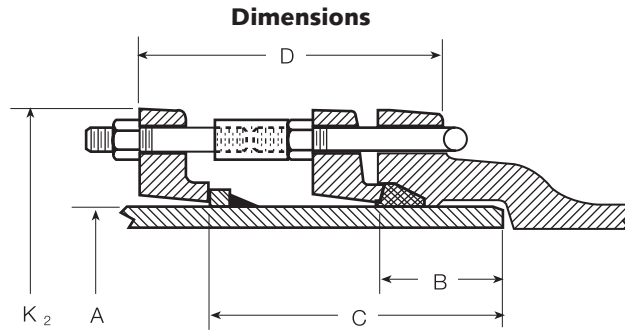

Table No. 9-13

4"-24"

Size in.	A Outside Diameter in.	B Socket Depth in.	C Plain End to Gland in.	K2 Gland O.D. in.	Bolts or Studs No.	Tee-Head Bolt in.	Stud in.	MJCJE & MJCJE Minimum Laying Length (ft.)
4	4.80	2.50	6.34	9.12	4	3/4 x 4	3/4 x 3 1/2	2'-3"
6	6.90	2.50	6.50	11.12	6	3/4 x 4	3/4 x 3 1/2	2'-3"
8	9.05	2.50	6.64	13.37	6	3/4 x 4 1/2	3/4 x 3 1/2	2'-3"
10	11.10	2.50	6.71	15.69	8	3/4 x 4 1/2	3/4 x 3 1/2	2'-3"
12	13.20	2.50	6.77	17.94	8	3/4 x 4 1/2	3/4 x 3 1/2	2'-3"
14	15.30	3.50	8.88	20.31	10	3/4 x 5	3/4 x 5	2'-9"
16	17.40	3.50	8.88	22.56	12	3/4 x 5	3/4 x 5	2'-9"
18	19.50	3.50	8.88	24.83	12	3/4 x 5	3/4 x 5	3'-0"
20	21.60	3.50	8.88	27.08	14	3/4 x 6	3/4 x 5	3'-0"
24	25.80	3.50	8.88	31.58	16	3/4 x 6	3/4 x 5	3'-0"

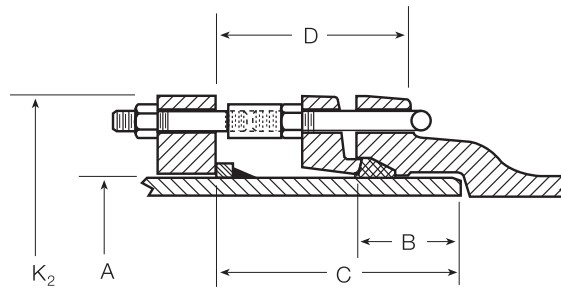

Table No. 9-14

30"-48"

Size in.	A Outside Diameter in.	B Socket Depth in.	C Plain End to Gland in.	K2 Gland O.D. in.	Bolts or Studs No.	Tee-Head Bolt in.	Stud in.	MJCJE & MJCJE Minimum Laying Length (ft.)
30	32.00	4.00	10.88	39.12	20	1 x 7	1 x 6	3'-6"
36	38.30	4.00	10.88	46.00	24	1 x 7	1 x 6	3'-6"
42	44.50	4.00	11.63	53.12	28	1 1/4 x 7	1 1/4 x 7	4'-0"
48	50.80	4.00	11.63	60.00	32	1 1/4 x 7	1 1/4 x 7	4'-0"



AMERICAN Joints - Restrained Coupling Gland Joint

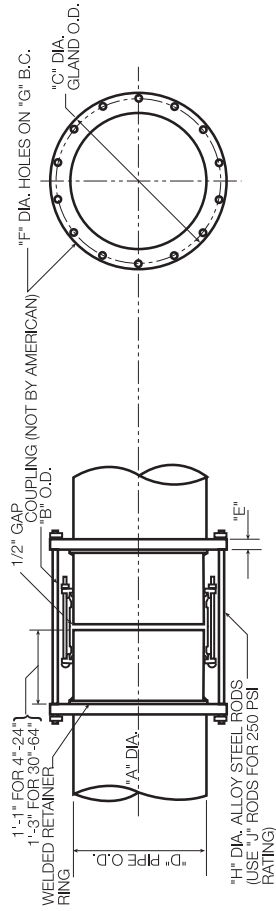

Table No. 9-15

A in.	B Maximum in.	C in.	D Pipe O.D. in.	E in.	F B.H. Dia. in.	G B.C. in.	H Tie Rod ϕ in.	J No. Rods	Tie Rod Length in.
4	9.00	11.50	4.80	1.00	7/8	9.88	3/4	4	31 1/2
6	11.00	13.50	6.90	1.00	7/8	11.88	3/4	4	31 1/2
8	13.06	15.63	9.05	1.00	7/8	13.94	3/4	4	31 1/2
10	15.81	18.37	11.10	1.00	7/8	16.69	3/4	4	31 1/2
12	18.06	20.63	13.20	1.00	7/8	18.94	3/4	6	31 1/2
14	19.31	23.00	15.30	1.50	7/8	21.32	3/4	0	31 1/2
16	21.38	24.63	17.40	2.00	7/8	23.01	3/4	2	31 1/2
18	23.50	27.00	19.50	2.00	7/8	25.38	3/4	2	31 1/2
20	25.63	29.13	21.60	2.00	7/8	27.51	3/4	14	31 1/2
24	29.19	33.38	25.80	2.00	7/8	31.69	3/4	16	31 1/2
30	37.00	40.11	32.00	2.25	1 1/8	38.25	1	20	39 1/2
36	43.31	46.30	38.30	2.44	1 1/8	44.56	1	24	39 1/2
42	49.50	53.12	44.50	2.62	1 3/8	51.00	1 1/4	28	41 1/2
48	55.81	60.00	50.80	2.81	1 3/8	57.50	1 1/4	32	41 1/2
54	62.57	66.88	57.56	3.00	1 3/8	64.38	1 1/4	36	41 1/2
60	66.41	73.00	61.61	3.12	1 3/4	69.25	1 1/2	26	42
64	70.47	80.00	65.67	3.38	1 3/4	76.00	1 1/2	26	42

*If limited flexibility or expansion/contraction capabilities are important in the application, Coupling gland ends (CGE) are provided as a method of restraining across couplings. Restraining glands can be furnished of steel or ductile iron at manufacturer's option. Alloy steel rods are furnished and the number of rods furnished for each pipe size allows the joint to be rated at 250 psi water working pressure.

The joint is designed to allow "drop-in" installation. This means that, based on popular short coupling lengths, the coupling will normally clear the end of the pipe if it is pushed all of the way to the gland on that piece of pipe. Note: AMERICAN does not furnish the couplings used with this joint; therefore, the user should check coupling pressure rating, length, and diameter dimensions used for appropriate clearances to make sure they are compatible with the joint before ordering.



Thrust Collars

One method of restraining a pipeline is to provide a welded-on thrust collar or other dependable anchorage means on one or both sides of the point requiring restraint and to use concrete poured around the collar for support against undisturbed soil surrounding the pipe.

At a bend, the fitting and pipe ends would have to be of a restrained type, adequate to withstand total thrust involved. The required number of thrust collars would be dependent on the mag-

nitude of the thrust force to be restrained and the allowable load per collar.

Thrust collars are also used in lieu of water stops on fabricated wall pipe for installation in load-bearing walls to resist thrust caused by internal pressure.

The allowable load per standard collar for the various sizes of pipe is tabulated below.

Contact AMERICAN when greater loads are involved.

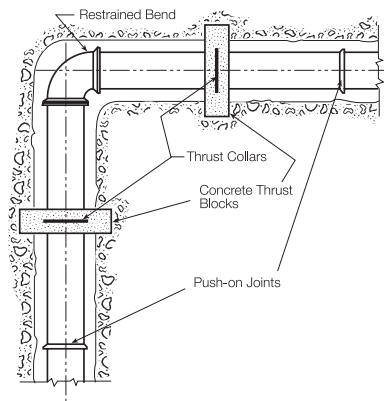

Table No. 9-16 **Thrust Collar Blocking Arrangement**

Pipe Size in.	Collar O.D. * in.	Collar Thickness* in.	Weight of Collar* lbs	Allowable Load Per Collar** lbs
4	6.80	.25	1	4,500
6	8.90	.25	2	9,300
8	11.05	.25	2	16,000
10	13.10	.25	3	24,000
12	15.20	.25	3	34,000
14	17.30	.25	5	46,000
16	19.40	.25	6	59,000
18	22.50	.38	15	75,000
20	24.60	.38	11	92,000
24	28.80	.38	13	130,000
30	36.00	.50	29	200,000
36	42.30	.50	35	290,000
42	50.75	.75	98	390,000
48	57.05	.75	111	510,000
54	66.06	1.00	231	650,000
60	70.11	1.00	246	745,000
64	74.17	1.00	261	847,000

*Dimensions and weights of thrust collars furnished by AMERICAN but manufactured by others may vary from those shown in Table 9-11.

**These values are based on dead-end thrust due to 250 psi internal pressure. For higher allowable loads or pressures, check AMERICAN.

Thrust collars may be specified on ductile iron pipe with minimum pressure classes.

Thrust collars will be fabricated from steel.



AMERICAN Restrained Ductile Iron Pipe Joints

Field Welding Instructions

In most instances, careful planning and/or measuring ahead to position required field cuts in unrestrained sections of a pipeline can eliminate the need for any field-fabricated restrained joints. Also, it is generally and technically preferable in most 4"-36" restrained joint areas to restrain field-cut joints where possible with Fast-Grip gaskets or Field Flex-Rings which do not require field welding. In some cases, however, unforeseen circumstances may make it impossible to plan ahead, and at such times AMERICAN offers the following procedure whereby ductile iron or alloy steel rings can be field welded onto the barrels of ductile iron pipe to be used in restrained joint applications. **All operations required for field welding should never begin until the area where the welding will be performed has been appropriately checked for any potentially hazard-**

ous conditions per standard industry practice and/or as required by local, state, OSHA or any other federal requirements.

When these procedures are followed by welders skilled in the art, strong, dependable restrained joints should be produced. **In presenting this procedure, AMERICAN Cast Iron Pipe Company assumes no responsibility for the performance of field-welded pipe joints or pipe systems.**

WELDING EQUIPMENT AND MATERIALS

Welds should be applied using a D.C. arc welder and appropriate welding electrodes or wire. Welding should be accomplished using reverse polarity and amperage ranges recommended by the electrode or wire manufacturer, with appropriate operator adjustment for the actual welding conditions on ductile iron pipe.

Suitable Pipe Diameters for Field Cuts and Restrained Joint Field Fabrication

Table No. 9-17

Nominal Pipe Size in.	Min. Pipe Dia. in.	Max. Pipe Dia. in.	Min. Pipe Circumference in.	Max. Pipe Circumference in.
4	4.74	4.86	14 ^{29/32}	15 ^{9/32}
6	6.84	6.96	21 ^{1/2}	21 ^{7/8}
8	8.99	9.11	28 ^{1/4}	28 ^{5/8}
10	11.04	1.17	34 ^{11/16}	35 ^{9/32}
12	13.14	13.26	41 ^{9/32}	41 ^{21/32}
14	15.22	15.35	47 ^{13/16}	48 ^{7/32}
16	17.32	17.45	54 ^{13/32}	54 ^{13/16}
18	19.42	19.55	61	61 ^{13/32}
20	21.52	21.65	67 ^{19/32}	68
24	25.72	25.85	80 ^{13/16}	81 ^{7/32}
30	31.94	32.08	100 ^{11/32}	100 ^{25/32}
36	38.24	38.38	120 ^{1/8}	120 ^{9/16}
42	44.44	44.58	139 ^{5/8}	140 ^{1/16}
48	50.74	50.88	159 ^{13/32}	159 ^{27/32}
54	57.46	57.60	180 ^{17/32}	180 ^{31/32}
60	61.51	61.65	193 ^{1/4}	193 ^{11/16}
64	65.57	65.71	206	206 ^{7/16}

Above table based on ANSI/AWWA C151/A21.51 guidelines for push-on joints. *54" dimensions based on nominal O.D. of 57.56". If existing 57.10" O.D. pipe is being field-fabricated, dimensions must be adjusted accordingly and proper ring material must be used. Check AMERICAN for details.

Caution should be taken when taking on any field pipe modification or repair operations, etc., that might involve or include an ignition source, (i.e., grinding, cutting or welding, etc., on pipe fittings or valves). All applicable safety codes, precautions and procedures should be followed; including making sure the work atmosphere is safe for such operation.



AMERICAN Restrained Ductile Iron Pipe Joints

Field Welding Instructions—Continued

The weld electrodes or wire used to deposit the required amount of fillet weld should be in conformance with Class designations AWS A5.15 Class ENiFeT3-CI, or AWS A5.6 (ASME SFA 5.6) Class Cu A1-A2. These electrodes shall be capable of producing suitable welds without preheating or postheating of the pipe and ring. A recommended semi-automatic welding wire, with appropriate weld specifications, is as follows:

Stoody® Castweld Ni 55-0/S/G, 3/32" diameter, D.C., reverse polarity (electrode positive), 325-400 amps.

PROCEDURE USING WELDING FIXTURES AND HAND-HELD ELECTRODES

This procedure is intended to be used for manual welding. Contact AMERICAN when semi-automatic welding setups are desirable.

1. Measure the candidate pipe diameter (or circumference) at the desired location of the cut to confirm the dimensions. The allowable pipe diameter and circumference should fall in the ranges as shown in Table 9-12. Any cut pipe with substantial out-of-roundness should be temporarily rounded with a mechanical jack and shaped timbers, then braced in the rounded shape for this field welding procedure. The rounding timber or brace should normally be left in place inside the pipe until after complete joint assembly in the field, at which time it should be removed for service.

2. Cut the pipe at the desired location and bevel the cut end for joint assembly. (See

Section 3.) It is imperative that field cuts for restrained joint welding be smooth, regular, and as square as possible with the axis of the pipe, inasmuch as the cut end is usually used as a reference plane to position the welded rings from the end of the pipe.

3. Clean and grind the weld location on the pipe to bright metal (Photo 1) prior to positioning the ring. Asphaltic coating in the weld area should be removed with a torch or with a solvent wash prior to grinding. Also, the corresponding edge of the ring to be welded should be cleaned and ground to bright metal. Loose locking rings or glands (if required for the particular joint configuration) should be placed on the pipe beyond the weld ring location at this point. (See illustrations on the next page and Photo 2.)



Fig. 9-1
Circular Welding Fixture

4. Clamp the joint weld ring securely on the pipe in the correct location. (See Table 9-13.) This may be accomplished using a special welding fixture (Photo 3). An example of a recommended ring welding fixture available from AMERICAN is shown in Figure 9-1. If clamping devices not furnished by AMERICAN are utilized for the ring-clamp operation, they should





AMERICAN Restrained Ductile Iron Pipe Joints

Field Welding Instructions—Continued

be capable of holding the ring securely in the proper position and straight on the pipe until all weld is applied.

NOTE: *If clamps are used, care should be taken to cushion the clamps where they bear on the inside of the pipe to minimize damage to the pipe lining. The cement linings routinely supplied by AMERICAN are normally not adversely affected by the welding procedures described in this brochure. If significant cement lining damage occurs due to any cause, it should be patched in accordance with recommended procedures as noted in Section 11. Contact AMERICAN for requirements involving field welding of pipes with special linings.*

5. Weld the ring to the pipe with the final weld dimensions as shown in Table 9-13. Appropriate flat or down-hand techniques for field welding ductile iron should be used. In manual electrode welding, pipe welding rotators or rolling the pipe on timbers or rails is normally necessary to keep the work flat or “downhand.” For the same reason, field welding of restrained ends should generally not be done “in situ” (i.e., in the ditch, assembled), as the pipe cannot easily be rolled or rotated to keep the position “downhand.” The use of short, overlapping weld passes in manual welding will minimize heat buildup, cracking, and thermal stresses as the metal cools. Weld passes should be thoroughly cleaned (peened) and inspected before cooling and prior to the addition

of adjoining passes. Also, the ends of the adjoining passes should not coincide but should be slightly overlapped before the arc is broken. The resulting weld fillet should be of a slightly convex shape and free of significant weld defects. Weld cracks, if they occur, should be ground away and repaired with a weld overlay.

When a recommended welding fixture is utilized (Photo 4), start the weld at one end of the ring and work continuously and progressively through the other end.

After the entire ring has been field welded to the pipe, weld the ring ends to the pipe and weld in the small space remaining between the ring ends to ensure proper weld height at the ring ends.

6. Wire brush the weld and ring to remove all slag or weld spatter (Photo 5). Particular care must be taken to brush or chip away any weld spatter which may have accumulated on the pipe spigot which could interfere with proper gasket sealing or joint assembly. Any significant weld bead lumps or irregularities which might interfere with proper joint assembly or performance should also be removed.

7. Paint the ring, weld, and clean pipe metal area (Photo 6) with a smooth uniform coat of asphaltic paint or mastic which meets the requirements for ductile iron pipe outside coating per ANSI/AWWA C151/A21.51.





AMERICAN Restrained Ductile Iron Pipe Joints

Field Welding of Restrained Joints

MJ Coupled Joint

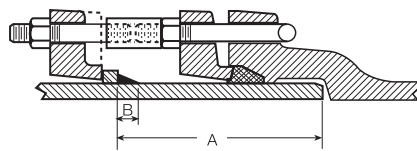

Flex-Ring® Joint 4"-12"

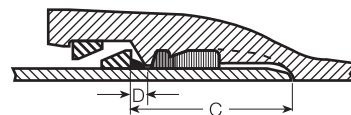

Note: Sizes 30"-48" use rectangular crosssection spigot glands in lieu of ductile MJ gland shown above.

Flex-Ring® Joint 14"-48"

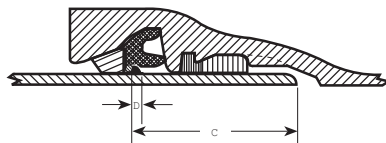

Lok-Ring® Joint

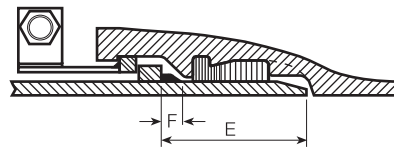

Note: Contact AMERICAN for applications involving field welding of 14"-48" Flex-Ring Joint.*

Table No. 9-18

Dimensions

Size in.	MJ Coupled Joint				Flex-Ring Joint				Lok-Ring Joint			
	A ± $\frac{1}{16}$	B ± $\frac{1}{16}$	Weld Height Min.	Weld Weight lbs.	C ± $\frac{1}{16}$	D $+\frac{3}{16}-0$	Weld Height $+\frac{1}{8}-0$	Weld Weight lbs.	E ± $\frac{1}{16}$	F ± $\frac{1}{16}$	Weld Height Min.	Weld Weight lbs.
4	5.84	.50	.20	.4	3.80	.25	.19	.1	-	-	-	-
6	6.00	.50	.20	.3	3.80	.25	.19	.2	-	-	-	-
8	6.14	.50	.20	.6	3.92	.25	.19	.2	-	-	-	-
10	6.21	.50	.20	.7	4.50	.25	.19	.3	-	-	-	-
12	6.27	.50	.20	.8	4.50	.25	.19	.4	-	-	-	-
14	8.38	.50	.20	.9	4.63	.25	-	-	-	-	-	-
16	8.38	.50	.20	1.0	4.63	.25	-	-	-	-	-	-
18	8.38	.50	.20	1.1	5.25	.25	-	-	-	-	-	-
20	8.38	.50	.20	1.2	5.25	.25	-	-	-	-	-	-
24	8.38	.50	.20	1.3	5.38	.37	-	-	-	-	-	-
30	10.38	.75	.25	2.8	6.00	.50	-	-	-	-	-	-
36	10.38	.75	.25	3.4	6.00	.50	-	-	-	-	-	-
42	11.13	.75	.25	3.9	6.07	.50	-	-	-	-	-	-
48	11.13	.75	.25	4.5	7.38	.50	-	-	-	-	-	-
54	-	-	-	-	-	-	-	-	6.38	.88	.30	4.5
60	-	-	-	-	-	-	-	-	6.38	.88	.30	4.9
64	-	-	-	-	-	-	-	-	6.38	.88	.30	5.3

Contact AMERICAN for alternative field welding considerations for 14"-48" Flex-Ring pipes. Dimensions are in inches.

Note: Dimensions shown are for current AMERICAN products and are subject to change. Check AMERICAN for field welding applications for connecting to existing piping.

Note: For alternative preferred method of restraining field-cut ends in most 4"-30" Flex-Ring Joint Systems, see pg. 9-2 "Fast-Grip® Gasket."

*Note: Field Flex-Rings are normally recommended in lieu of field welding for restraining field-cut ends in 14"-36" Flex-Ring Joint Systems, see pg. 9-21 "Field Flex-Ring®."



Restrained Joint Pipe Assembly Extension Procedure



In some installations of restrained joint pipe, it is desirable to pull-extend (or take the "slack" or movement out of) installed restrained joints. In traditional backhoe or bulldozer push-on pipe assembly, it is most common for the installer to push-assemble the latest installed pipe into the line. In applications where restrained joints are to be extended, however, and particularly in some exposed lines, the pushing operation can unnecessarily disturb previously extended joints. In such cases, some very simply designed rigging (using the same heavy equipment) can ensure that only pulling loads are applied to previously extended joints as new joints are assembled. One such rigging method, utilizing a snatch block (with pulley and hook), a wire rope pulling cable, and a pipe end hook is illustrated in the above photograph. Of course, a simple wire rope "choker cable" can be substituted for the chain around the pipe bell shown in the above photograph.

Note: Care should be taken in such operations at connections of restrained piping to unrestrained piping. One should securely anchor the first restrained pipe in-

stalled, so as not to unintentionally separate the last unrestrained (Fastite or MJ, etc.) joint installed. Also, care should be exercised to avoid damaging pipe (as by beam loading to branch lines or laterals, etc.) in pulling operations.

AMERICAN manufactures 4" through 12" Mechanical Joint Ductile Iron pipe in accordance with AWWA C151 and AWWA C111 and Mechanical Joint fittings up through 48" in accordance with AWWA C153, AWWA C110, and AWWA C111, as described therein. However, AMERICAN does not warrant the performance of third-party mechanical retainer glands or joints using third-party retainer glands, since the design, manufacturing, and installation methods are beyond our control. Furthermore, we do not recommend the use of retainer glands on minimum classes of ductile iron pipe. AMERICAN does manufacture a number of restrained joints such as Fast-Grip[®], Flex-Ring[®], Field Flex-Ring[®], Lok-Ring[®], Flex-Lok[®], and other devices, where we warrant the joint as well as the associated pipe and fittings of our manufacture.



AMERICAN DUCTILE IRON PIPE



AMERICAN reserves the right to modify or change designs, materials, specifications, or dimensions shown herein without prior notice.



*This is a preprint of a section from the 19th Edition of the AMERICAN Pipe Manual.
References may be made in this section to other sections of this manual.*



