



CARGO CONTROL

Synthetic Cargo Tiedowns and Hardware

CERTEX offers a full line of synthetic tiedown assemblies and related hardware for all the tough demands of the flatbed and van trailer industry. Also available is a full line of pickup and smaller trailer straps used for securing loads. These straps are made from a specially treated polyester webbing for minimal stretch, environmental considerations and resistance to wear. The soft polyester webbing protects material surfaces and conforms to the shape of the load at any angle. These assemblies are available in 1, 2, 3 and 4 inch widths with a variety of end fittings and working load limits (WLL). CERTEX tiedown assemblies are manufactured to strict quality guidelines according to the latest government standards.

CERTEX strongly recommends that these products be used in accordance with all local, state and Department of Transportation regulations. Users of tiedown assemblies should review and comply with all federal, state and local regulations relative to the proper securement of cargo being transported. Securement strength requirements should take into consideration "G" forces and all other contributing factors affecting the material being transported. Tiedown assemblies should not be used for overhead lifting.

For further information please consult the Web Sling and Tiedown Association's Recommended Standard Specification for Synthetic Web Tiedowns and the Recommended Standard Specification for Synthetic Web Tiedown Winches.

Recommended Operating Practices

Mechanical Considerations

Determine weight of the cargo to be secured, including expected Gravity "G" forces.

Select tiedown having suitable characteristics for the type of load and environment.

Tiedowns shall not be loaded in excess of the Working Load Limit (WLL). Consideration should be given to the angle from the vertical (cargo tiedown to load angle) which affects working load capacity.

Tiedown shall be attached to provide control of the load and positioned in accordance with applicable regulations.

Tiedowns shall not be dragged on the floor, ground, or over an abrasive surface.

Tiedowns shall not be tied into knots, or joined by knotting.

Tiedowns shall not be pulled from under loads when the load is resting on the tiedown.

Tiedowns shall always be protected from being cut by sharp corners, sharp edges, protrusions or abrasive surfaces.

Tiedowns with metal fittings shall not be dropped.

The opening in fittings shall be the proper shape and size to insure that the fitting will seat properly in the anchorage point or other attachments. If the anchor point is inadequate to support the force of the tiedown

system, then the load rating of the tiedown will be limited to the strength of the anchor point.

Tiedowns shall not be used for lifting.

Environmental Considerations

Tiedowns should be stored in a dry and dark place, and should not be exposed to sunlight when not in use.

Chemically active environments can effect the strength of synthetic web tiedowns in varying degrees ranging from little to total degradation. The tiedown manufacturer should be consulted before tiedowns are used or stored in chemically active environments.

A. Acids

1. Nylon is subject to degradation in acids, ranging from little to total degradation.
2. Polyester is resistant to some acids, but is subject to degradation ranging from little to moderate with other acids
3. Each application shall be evaluated, taking into consideration the following:
 - i. Type of Acid
 - ii. Exposure Conditions
 - iii. Concentration
 - iv. Temperature

B. Alkalis

1. Polyester is subject to degradation by alkalis, ranging from little to total degradation.

CARGO CONTROL

2. Nylon is resistant to some alkalis, but is subject to degradation ranging from little to moderate with other alkalis.
3. Each application shall be evaluated, taking into consideration the following:
 - i. Type of Alkali
 - ii. Exposure Conditions
 - iii. Concentration
 - iv. Temperature

Nylon and polyester webbing shall not be used at temperatures in excess of 194 degrees F (90 degrees C). Both types are routinely used at temperatures as low as -40 degrees F (-40 degrees C).

Tiedowns incorporating aluminum fittings shall not be used where fumes, vapors, sprays, mists or liquids of alkalis and/or acids are present.

Environments in which synthetic webbing tiedowns are continuously exposed to ultra-violet light can affect the strength of synthetic webbing tiedowns in varying degrees ranging from slight to total degradation.

- A.** Factors which can determine the degree of strength loss are:
 1. Length of time of continuous exposure
 2. Webbing construction and design
 3. Other environmental factors such as weather conditions and geographic location.
- B.** Suggested procedures to minimize the effects of ultra-violet light.
 1. Store webbing tiedowns in a cool, dry and dark place when not being used for prolonged periods of time.
 2. Inspect webbing tiedowns weekly or more often, depending on frequency of use.
 3. Impregnate a coating into the webbing.
- C.** Visual indications of possible ultra-violet degradation are:
 1. Bleaching out of webbing.
 2. Increased stiffness of webbing material.
 3. Surface abrasion in areas not normally in contact with the load.

Caution: Degradation can take place without visible indications.

Inspection

Type of Inspection

- A.** Initial Inspection — Before any tiedown is placed in service it shall be inspected to insure that the correct tiedown is being used as well as to determine that the tiedown meets the requirements of the application.
- B.** Frequent Inspection — This inspection shall be made by the person handling the tiedown each time it is used.
- C.** Periodic Inspection — This inspection shall be conducted by designated personnel. Frequency of inspection shall be based on:
 1. Frequency of use
 2. Severity of service conditions
 3. Experience gained on the service life of tiedowns used in similar applications.
 4. Inspection should be conducted at least monthly.

Inspection Records

Tiedown inspection records shall be established by the user.

Tiedown Replacement

- A.** Tiedown shall be removed from service if any of the following, are visible.
 - a. Acid or alkali burns.
 - b. Melting, charring, or weld spatter of any part of the webbing.
 - c. Holes, tears, cuts, snags or embedded particles.
 - d. Broken or worn stitching in load bearing stitch patterns.
 - e. Excessive abrasive wear.
 - f. Knots in any part of the webbing.
 - g. Distortion and excessive pitting or corrosion or broken fittings.
 - h. Other apparent defects which cause doubt as to the strength of the tiedown.

Repair of Tiedown Webbing

No repairs of webbing, fittings, or stitching shall be permitted.

CARGO CONTROL

Tiedown Assemblies

Ratchet Load Binders offer the ease of one hand tensioning with their high quality ratchet buckles. These ratchet buckles offer a variety of adjustment positions to secure loads of any type for short term or long haul transit. The ratchet buckle assemblies are easily tightened to secure your loads properly and when it comes time to release the loads at the final destination these ratchet buckles are released just as easily. The soft polyester webbing conforms to the shape of the load and is flexible at any angle. The webbing also protects finished surfaces from scratching and abrasion. The webbing is engineered and manufactured to breaking strengths to acquire specific working load limits (WLL) when fabricated into a tiedown assembly.

A variety of tensioning buckles and end fittings are available. Webbing widths range from 1 inch, 2 inch, 3 inch and 4 inches. Also many different strengths are available which effect the working load limit (WLL) of the tiedown assembly. Strength ratings are “minimum break strength”. Unless otherwise specified, the strength rating is based upon a straight tensile pull. Load direction other than straight can result in a significant reduction in strength. Strength ratings are contingent upon using combinations of components as a system. The weakest component of the system determines the strength rating including the point of attachment. Tiedown assemblies are tagged with a working load limit (WLL).

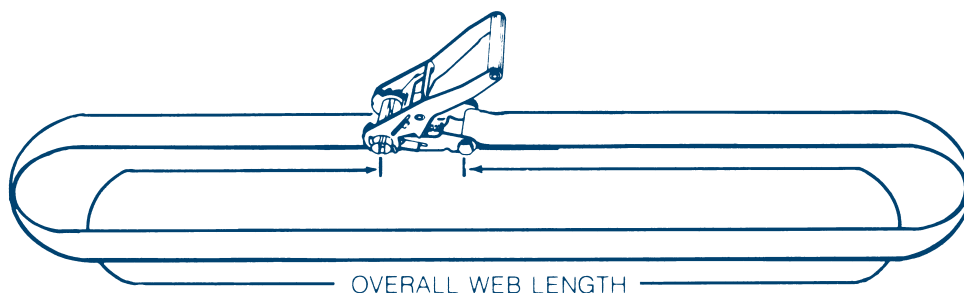

Type A – Endless

The simplest, most versatile Ratchet Binder has one end of the web sewn to the ratchet head, the other end free for passing around loads or through narrow openings, and inserting into the ratchet. Fabricated in any practical web length.

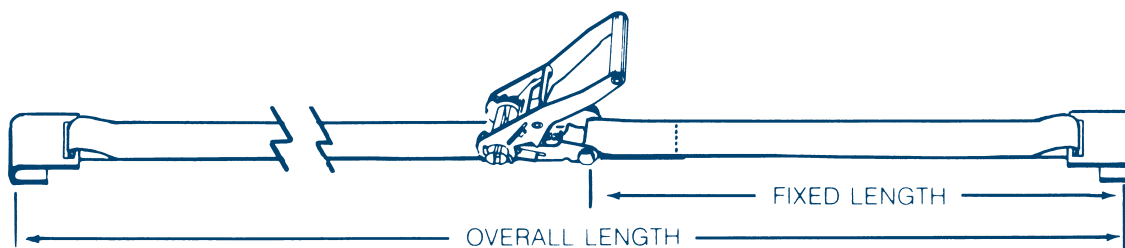

Type B – Two Piece

This is a two-piece device with flat hooks at the two extremities. The cut-and-sealed plain end inserts into the ratchet the same as Type A. Offered in any practical length, measured between hooks.

WARNING:

Tiedown assemblies are not to be used for overhead lifting.

CARGO CONTROL

Tiedown Assemblies



1 Inch Ratchet Tie Down Assembly	
CX07-0624	1" X 15' with flat hooks
CX07-0651	1" X 15' with S hooks
CX07-5113	1" X 8' with S hooks



2 Inch Ratchet Tie Down Assembly	
CX07-7074	2" X 27' with flat hooks
CX07-7075	2" X 27' with wire hooks

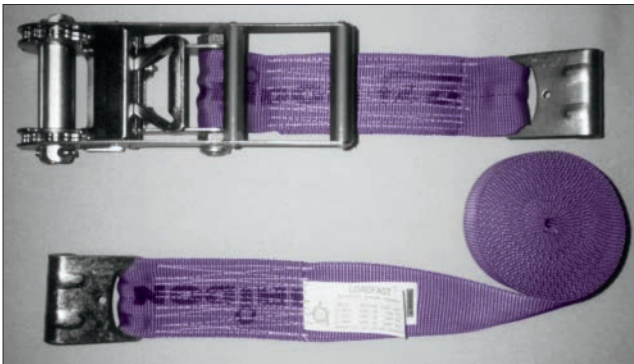

3 Inch Ratchet Tie Down Assembly	
CX07-7078	3" X 27' with flat hooks
CX07-9237	3" X 30' with flat hooks



4 Inch Ratchet Tie Down Assembly	
CX07-0641	4" X 30' with wire hooks
CX07-9238	4" X 30' with flat hooks

WARNING:
Tiedown assemblies are not to be used for overhead lifting.

Truck Winches

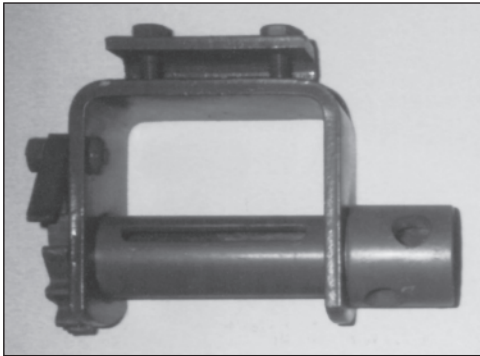

4WP

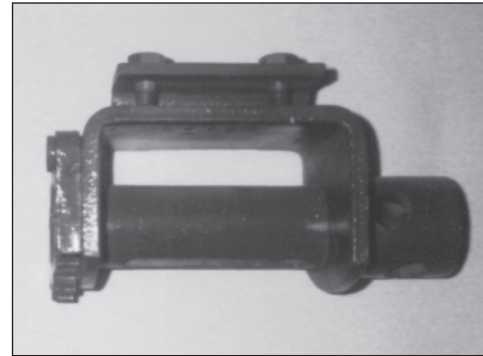

4WPL

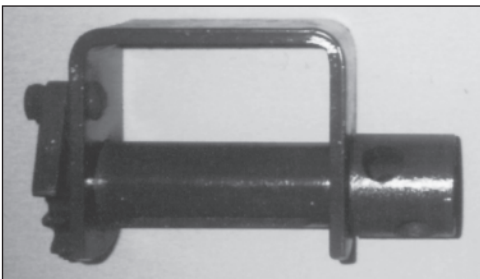

4WW



4WWL

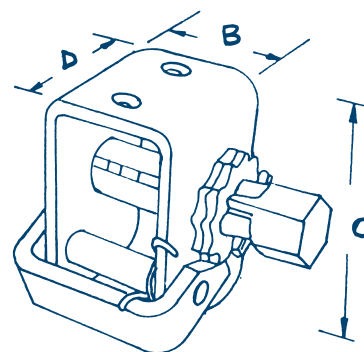
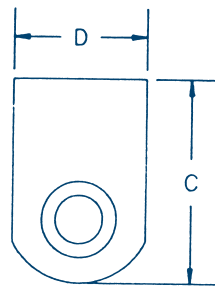
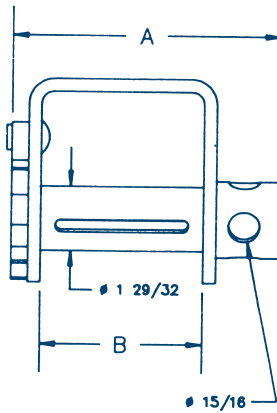

2 Inch Std.

CERTEX Cat. Ref. No.	Type	A	B	C	D	Weight
CX07-0042	2 Inch Std.	N/A	2 1/2 In.	3 1/3 In.	2 3/4 In.	3.1 Lbs.
CX07-0043	4 WWL	9	5 3/8	4 1/8	4 3/8	
CX07-0044	4 WW	9	5 3/8	5 1/2	3 1/2	
CX07-0045	4 WPL	9	5 3/8	5	4 3/8	
CX07-0046	4 WP	9	5 3/8	6 5/8	3 1/2	

CARGO CONTROL

Recommended Operating Practices

Mechanical Considerations

All winches shall be installed so the user can see the pawl to ensure proper engagement. Additionally, the winch shall be positioned so the pawl drops into the ratchet wheel by gravity. Winches shall never be installed so the user cannot see the pawl engagement or in a position where the user shall hold the pawl to engage the ratchet tooth. Portable winches shall be removed and stored when not in use. All winches, except portable and sliding styles, shall be welded to the trailer frame. Minimum welding requirements are to be specified by the manufacturer.

Winches shall be attached to vehicle structural members. If winches are installed in track, the track shall be attached to vehicle structural members.

When tightening or loosening winches, always maintain a firm grip on the winch bar. Never release a winch bar without checking the pawl to ensure that it is fully engaged between ratchet teeth. Releasing a winch bar without the pawl being properly engaged can cause serious injury to the user or bystanders. The use of non-slip handle winch bar specifically designed to tighten or loosen winches is recommended.

Set screws on portable winches are designed to position the winch while the tiedown assembly is tightened and shall be snug tightened only. Overtightening of screws may cause bracket to bend, weakening the winch and causing it to fail.

Winches shall not be loaded in excess of their Working Load Limit.

Only winch bars designed to be used with winches shall be used to tension and release tiedown assemblies. "Cheater Bars" shall not be used with the winch bars.

Environmental Considerations

Winches are subjected to dirt, mud, snow, ice, road salt, cleaning solutions, etc. And therefore require inspection and cleaning to insure they are always in operating condition prior to each use.

Winches that can be removed from the vehicle, when not in use, should be stored in a dry location.

Inspection

Type of Inspection

- A.** Initial inspection — before any winch is placed in service it shall be inspected to insure that it is the correct winch, as specified by the vehicle manufacturer. Also verify that all moving parts operate freely and the pawl drops into the ratchet wheel by gravity.
- B.** Frequent inspection — this inspection shall be made by the person operating the winch prior to each use.
- C.** Periodic inspection — this inspection shall be conducted by designated personnel.

Frequency of inspection shall be based on:

1. Frequency of use
2. Severity of Service Conditions
3. Experience gained on the service life of winches used in similar applications.
4. Inspection should be conducted at least quarterly.

Winch Replacement

A winch shall be removed from service if any of the following conditions exist:

- a. Reel bar is not free to rotate.
- b. Pawl is not free to drop into the ratchet wheel by gravity.
- c. Winch has been deformed due to overloading.
- d. Winch bar holes are deformed and will not permit use of standard winch bar.
- e. Ratchet wheel is distorted.
- f. Pawl/pawl pin is distorted.
- g. Weld on winch is cracked.
- h. Weld of winch to vehicle is cracked.
- i. Winch track shall be replaced if it is deformed in the area that transfers the winch load to the track.
- j. Other apparent defects which cause doubt as to the strength of the winch.

Inspection Records

Winch inspection records should be established by the user.

Repair of Winches

No repairs of the winch shall be permitted.

TERMINOLOGY

CERTEX Companies have been manufacturing synthetic web slings for over 30 years, manufactured to the highest quality of nylon or polyester these slings offer outstanding strength with excellent load protection. CERTEX web slings will not damage or scratch surfaces of products being lifted. These slings are lightweight and flexible to be easily handled and rigged to a load. They easily adjust and conform to the load with a non slip, secure grip and are treated

to keep out dirt, moisture and reduce abrasion. Nylon and polyester web slings are unaffected by oil and grease and offer good chemical resistance. Treated and untreated nylon and polyester webbing, used to fabricate synthetic slings, per class 5 and class 7 rated capacity charts, may contain red yarn woven into the core of the webbing to serve only as one of many aids in determining whether and when a sling should be removed from service.

Guide to CERTEX Web Sling Terminology

Product tables on the following pages contain Type designations for CERTEX Web Slings. The following key will help you interpret CERTEX Web Sling Type codes.

Interpreting Web Sling Type/Size Codes

Example: CTC1-62

C TC 1 - 6 2

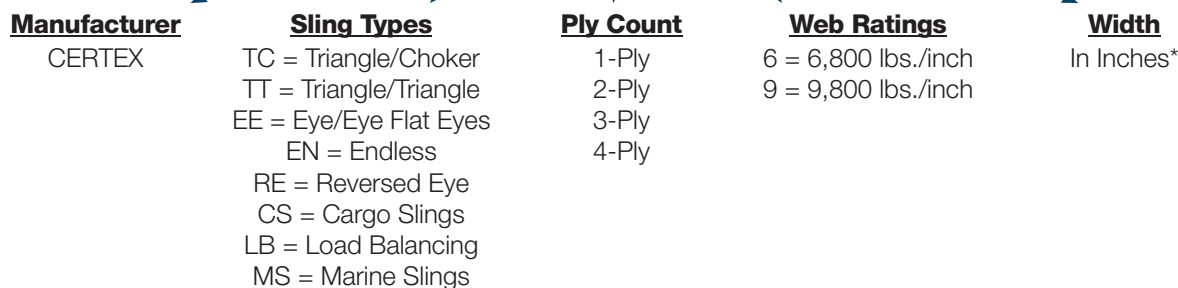

* Reversed Eye Sling Codes deviate from this code due to their style of construction. A width indicated at "1" yields a 2-inch sling; "2" yields a 4-inch sling. The number "15" in the width column means 1.5" and yields a 3-inch sling. "K" and "H" designations are special capacity ratings. End users should pay special attention to capacities.

WARNING:

Failure to read, understand and follow the use and inspection instructions could result in severe personal injury or death. Do not exceed rated capacities.

BASIC WEB SLING TYPES

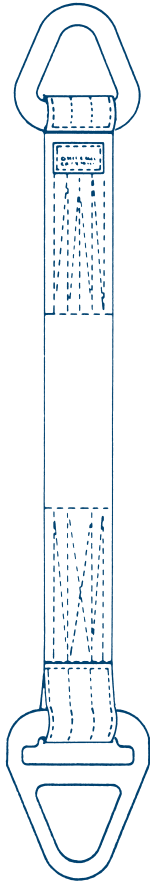

Triangle/Choker

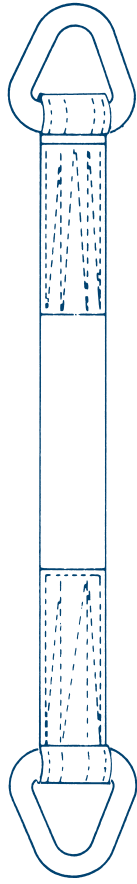

Triangle/Triangle



Eye/Eye Flat Eyes



Eye/Eye Twisted Eyes

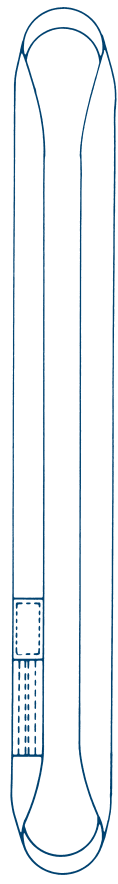

Endless

TYPE I — Web sling made with a triangle fitting on one end and a slotted triangle choker fitting on the other end. It can be used in a vertical, basket or choker hitch.

TYPE II — Web sling made with a triangle fitting on both ends. It can be used in a vertical or basket hitch only.

TYPE III — Web sling made with a flat loop eye on each end with loop eye opening on same plane as sling body. This type of sling is sometimes called a flat eye and eye, eye and eye, or double eye sling.

TYPE IV — Web Sling made with both loop eyes formed as in Type III, except that the loop eyes are turned to form a loop eye which is at a right angle to the plane of the sling body. This type of sling is commonly referred to as a twisted eye sling.

TYPE V — Endless web sling, sometimes referred to as a grommet. It is a continuous loop formed by joining the ends of the webbing together with a load bearing splice.

TYPE VI — Return eye (reversed eye) web sling is formed by using multiple widths of webbing held edge to edge. A wear pad is attached on one or both sides of the web sling body and on one or both sides of the loop eyes to form a loop eye at each end which is at a right angle to the plane of the web sling body.

WARNING:

Failure to read, understand and follow the use and inspection instructions could result in severe personal injury or death. Do not exceed rated capacities.

BASIC WEB SLING TYPES

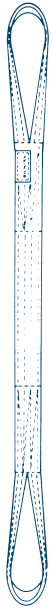

Reversed Eye

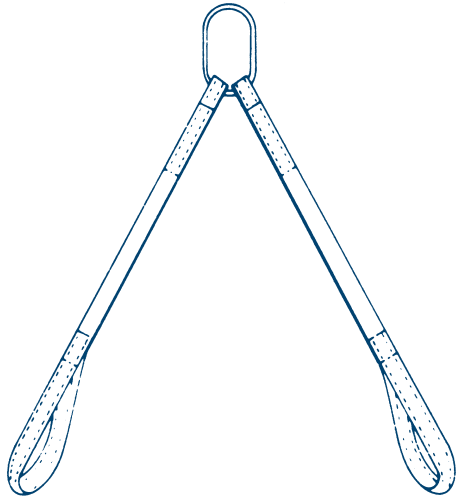

Bridle Slings (Multi-Legged)
and Hardware Type

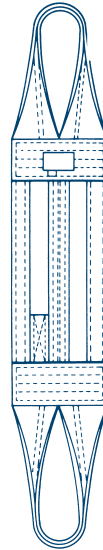

Cargo Type
(Wide Body)

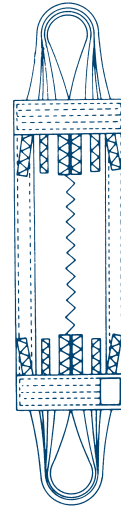

Load Balancing Type

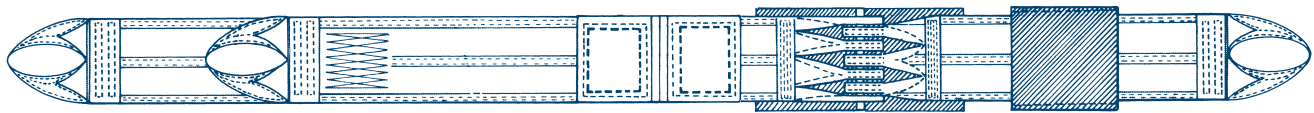

Marine/Boat Slings





WARNING AND APPLICATION INSTRUCTIONS FOR NYLON & POLYESTER WEBBING SLINGS



**Warning and Application Instructions
for Nylon & Polyester Webbing Slings**

TO ORDER ADDITIONAL COPIES OF THESE WARNINGS AND INSTRUCTIONS CALL 1-800-882-9118, CONTACT YOUR LOCAL CERTEX BRANCH OR PRINT A COPY FROM OUR WEBSITE AT WWW.CERTEXUSA.COM

Lifting Products and Services

OPERATORS INSTRUCTIONS FOR NYLON & POLYESTER WEBBING SLINGS	
 DANGER	 CAUTION

- Avoid being **HURT OR KILLED!** Inspect sling before use!
- If you see red core yarn, sling is in **DANGEROUS CONDITION! DO NOT USE!** Inspect sling before use! Take sling out of service **IMMEDIATELY.**

- This product is to be used by trained Personnel only.
- Read and understand these Warnings and Operating Instructions before using product.

WARNING

- Follow these steps to avoid SEVERE INJURY OR DEATH!
BEFORE USE:
- Inspect sling for damage from cuts, heat, chemicals or excessive wear.
 - If damage is visible, DO NOT USE! Remove sling from service IMMEDIATELY!
 - Be sure sling capacity tag is in place and can be easily read.
 - See Sling Angle Load Chart to determine loss of capacity due to lift angle and sling configuration (hitch)
 - NEVER expose sling to temperatures above 194 degrees F (90 degrees C)
 - Remember: Exposure to sunlight and ultraviolet light degrades sling strength.
- DURING USE:
- ALWAYS protect sling from cuts. Avoid sharp edges & corners, pointed objects, and rough surfaces.
 - NEVER tie knots in sling webbing.
 - NEVER pull objects that are stuck or snagged.
 - NEVER use near acids with nylon OR alkalis with polyester.

- Inspection, care and use of Synthetic Web Slings**
REMOVAL FROM SERVICE CRITERIA:
A Sling shall be removed from service if any of the following are visible:
1. Red Core Yarn is visible on any part of the Sling.
 2. If Sling rated capacity tag is missing or not readable.
 3. Acid or alkalis burns
 4. Melting, charring or weld spatter on any part of the Sling
 5. Holes, tears, cuts, snags, or embedded particles
 6. Broken or worn stitching in load bearing slices.
 7. Excessive abrasive wear
 8. Knots in any part of the Sling.
 9. Distortion, excessive pitting, corrosion or broken fittings.
 10. Any conditions which cause doubt as to the strength of the Sling.

INSPECTION RECORDS

Written inspection records should be established and kept on file for each new Sling. Records should include all the information taken from the Sling's identification tag (type, reach, rated capacity, manufacture, and date purchased), along with its location. These records should be updated after each periodic inspection.

TYPES OF INSPECTION

IMPORTANT: ALL INSPECTIONS MUST BE DONE ONLY BY TRAINED AND QUALIFIED PERSONNEL

A. Initial Inspection: Before any new or repaired Sling is placed in service, it shall be inspected to ensure that the correct Sling is being used, as well as to determine that the Sling meets the requirements of this specification and has not been damaged in shipment.

- B. Frequent Inspection: This inspection shall be done each time the Sling is used.
- C. Periodic Inspection: Frequency of inspection should be based on: 1. Frequency of Sling use. 2. Severity of service conditions. 3. Experience gained on the service life of Slings used in similar applications. 4. Periodic inspections should be conducted at least monthly.

PROOF TESTING

Proof Testing of Sling Exposed to Ultra Violet Light

Slings used in environments where they are subject to continuous exposure to ultra violet light (sunlight) should be proof tested to two (2) times rated capacity semi-annually, or more frequently, depending on severity of exposure. Testing has confirmed that Nylon Slings lose fifty (50) to sixty (60) percent of their strength after 36 months of continuous exposure to sunlight. Polyester loses about thirty (30) percent over the same period. Contact CERTEX for further information on the Testing program completed by the Web Sling and Tie Down Association.

Operating Practices

1. Determine weight of the load. The weight of the load shall be within the rated capacity of the Sling.
2. Select Sling having suitable characteristics for the type of load, hitch and environment.
3. Slings shall not be loaded in excess of the rated capacity. Consideration shall be given to the Sling to load angle which affects rated capacity. (See Sling Angle Chart)
4. Slings with fittings which are used in a choker hitch shall be of sufficient length to assure that the choking action is on the webbing and never on a fitting or splice.
5. Slings used in a basket hitch shall have the load controlled to prevent slippage.
6. The opening in fittings shall be the proper shape and size to insure that the fitting will seat properly in the hook or other attachments.
7. Slings shall always be protected from being cut by sharp corners, sharp edges, protrusions or abrasive surfaces with protection sufficient for the intended purpose.
8. Slings shall not be dragged on the floor or over abrasive surface.
9. Slings shall not be twisted or tied into knots, or shortened or joined by knotting.
10. Slings shall not be pulled from under loads if the load is resting on the Sling. Loads resting on Web slings could damage the Sling.
11. Do not drop Slings equipped with metal fittings.
12. Slings that appear to be damaged shall not be used unless inspected and accepted.
13. The Sling shall be hitched in a manner providing control of the load.
14. Personnel shall stand clear of the suspended load.
15. Personnel, including portions of the human body, shall be kept from between the Sling and the load, and from between the Sling and the crane hook or hoist hook.
16. Personnel shall not ride the Sling or load being lifted.
17. Shock loading shall be avoided.
18. Twisting and kinking the legs (branches) shall be avoided.
19. Load applied to the hook shall be centered in the base (bowl) of hook to prevent point loading on the hook.
20. During lifting, with or without the load, personnel shall be alert for possible snagging.
21. The Web Slings' legs (branches) shall contain or support the load from the sides above the center of gravity when using a basket hitch.
22. Slings shall be long enough so that the rated capacity of the Sling is adequate when the angle of the legs (branches) is taken into consideration. (See Load Chart)
23. Place blocks under load prior to setting down the load, to allow removal of the Web Sling, if applicable.
24. Nylon & Polyester Slings shall not be used in contact with objects or at temperatures above 194 degrees F (90 degrees C).
25. Exposure to sunlight or ultra-violet light degrades the strength of Slings. Store Slings in a cool, dry and dark place when not in use.
26. Slings shall not be used to pull on objects in a snagged or constrained condition.
27. Only Web Slings with legible identification tags shall be used.
28. Tags and labels should be kept away from the load, hook and point of choke.
29. Web Slings shall not be constricted or bunched between the ears of a clevis or shackle.
30. Web Slings shall not be used as bridles on suspended personnel platforms.

SLING HITCHES

Loads vary in physical dimensions, shape, and weight. Where and how to attach Slings is important to the Rigger.

Choker Hitches

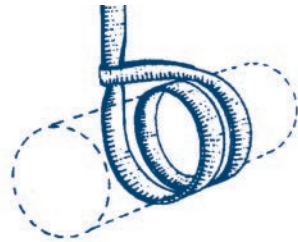
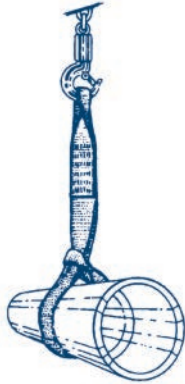

The double wrap hitch or the double wrap choker hitch provides full 360 degree contact with the load.

A contact Sling hitch in which the Sling passes entirely around the load. In its simplest form the Sling has a loop, or eye on each end, and is referred to as a Sling choker or choker. One loop passes through the other, forming a slip noose.

Basic Rules of Hitching

RATED CAPACITY – Be sure the Sling you intend to use is strong enough for the job. Consult CERTEX Catalog or refer to rated capacity tag on actual Sling.

CONTROL AND BALANCE – Use a hitch that will keep the load under control at all times and be sure the lifting device is directly over the Center of Gravity. (see example Figure 1)

PREVENT DAMAGE – Use corner protectors when bending around sharp corners. (see example Figure 2)

LIFTING LOAD – Lift load carefully, accelerating smoothly. Avoid shock loading.

CONDITION OF SLINGS – Inspect Slings and their parts carefully before each lift and at regular intervals.

USE OF LIFTING LUGS/EYE BOLTS – Many loads are equipped with lifting lugs for easy attachment of the Sling. Make sure pull is transmitted to them straight along the axis of the shank. Lifting lugs/eye bolts should be used in accordance with the lug/eye bolt manufacturer’s recommendations. (see example Figure 3) However, if “Hoist Rings” are utilized the pull does not have to be along the axis.

Basket Hitch

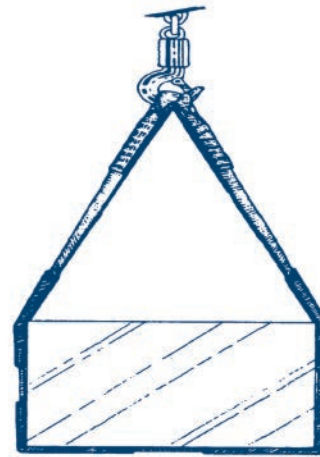

Four Leg Bridle Sling

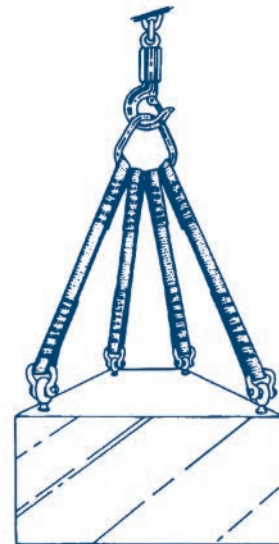

Four Leg Bridle Sling – Each leg length must be the proper length if the object is to hang level. If the hook up is such that two or even three legs are taking the load, the design factor is reduced.

WARNING:

Avoid Serious Injury or Death

Any single hitch shall NEVER be used to transport a load that is not balanced.

WARNING:

Avoid Serious Injury or Death

Rated capacities are affected by the Angle of lift (Sling to load angle) when used in multi-legged Slings or basket hitches. To determine the actual Sling capacity at a given Angle of lift, multiply the original Sling rating by the appropriate loss factor, determined from the Sling Angle Chart.

SLING HITCHES

Control & Balance

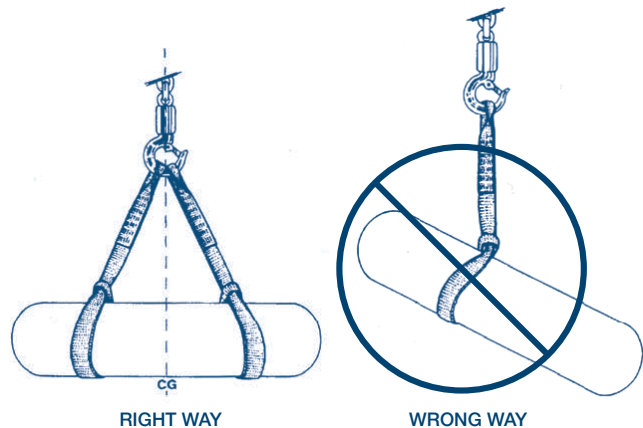

Figure 1

Prevent Damage

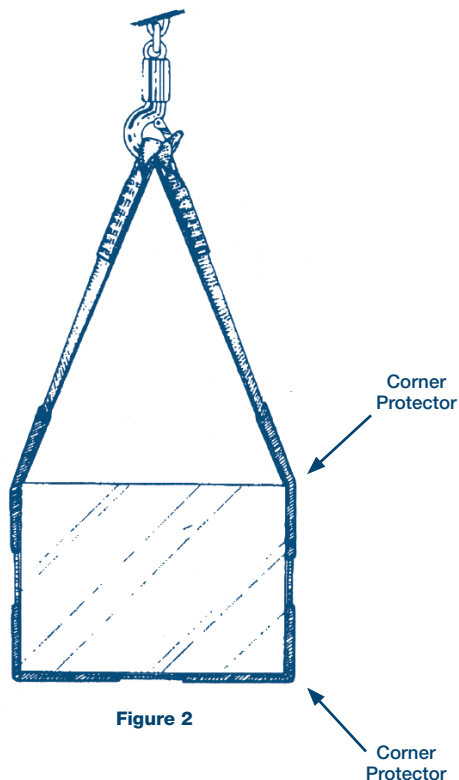

Figure 2

Use of Lifting Lugs/Eye Bolts

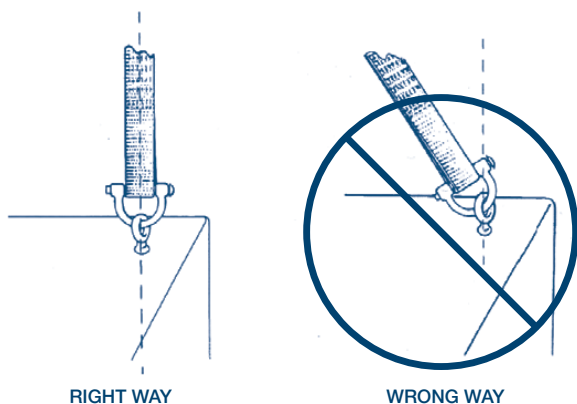
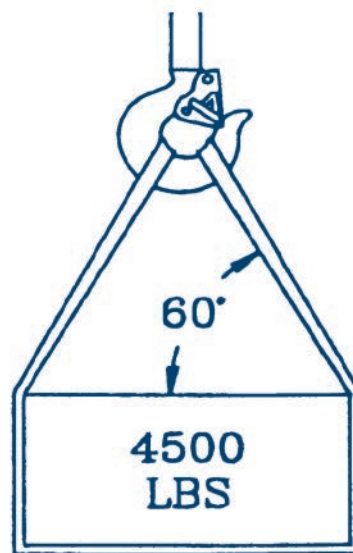

Figure 3



Sling Angle Chart (Angle of Lift)			
Angle/Degrees Horizontal	Loss Factor	Angle/Degrees Horizontal	Loss Factor
90	1.000	55	0.819
85	0.996	50	0.766
80	0.985	45	0.707
75	0.966	40	0.643
70	0.940	35	0.574
65	0.906	30	0.500
60	0.866	-	-

Rated capacities are effected by the angle of lift (Sling to load Angle) measured from the horizontal when used with multi-legged Slings or Choker/Basket Hitches. To determine the actual capacity at a given angle of lift, multiply the original Sling rating by the appropriate loss factor determined from the table above.

$$5200 \text{ lbs (Sling Rating)} \times 0.866 \text{ (Loss Factor)} = 4500 \text{ lbs Rated Capacity}$$

FOR ADDITIONAL INFORMATION, PLEASE REFER TO OSHA 1910.184, ANSI B30.9, OR OTHER REGULATIONS AS APPLICABLE

WEB SLINGS

Triangle/Choker Type I

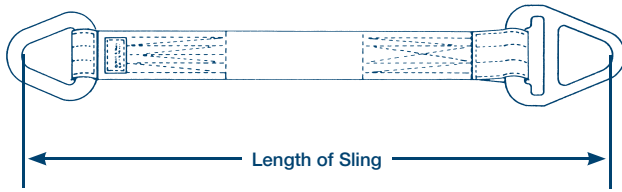

End fittings are steel or aluminum with a slip through design which provides good choke hitching. Also can be used in vertical or basket hitches.

Available in Nylon or Polyester Webbing.

Triangle/Triangle Type II

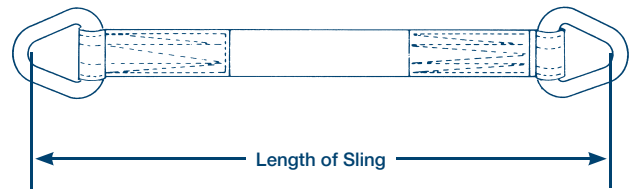

End fittings are steel or aluminum designed to be used in only a vertical or basket hitch.

CERTEX Cat. Ref. No.	Triangle/Choker Type	CERTEX Cat. Ref. No.	Triangle/Choker Type	Width	Vertical	Choker	Basket
CX07-0048	CTC1-92	CX07-0070	CTT1-92	2"	3100	2500	6200
CX07-0050	CTC2-92	CX07-0072	CTT2-92	2"	6200	5000	12400
CX07-0052	CTC1-93	CX07-0074	CTT1-93	3"	4700	3700	9400
CX07-0054	CTC2-93	CX07-0076	CTT2-93	3"	8400	6700	16800
CX07-0056	CTC1-94	CX07-0078	CTT1-94	4"	6200	5000	12400
CX07-0058	CTC2-94	CX07-0080	CTT2-94	4"	11200	9000	22400
CX07-0060	CTC1-96	CX07-0082	CTT1-96	6"	9300	7400	18600
CX07-0062	CTC2-96	CX07-0084	CTT2-96	6"	16500	13200	33000
CX07-0063	CTC1-98	CX07-0085	CTT1-98	8"	12400	9920	24800
CX07-0064	CTC2-98	CX07-0086	CTT2-98	8"	22000	17600	44000
CX07-0065	CTC1-910	CX07-0087	CTT1-910	10"	15500	12400	31000
CX07-0066	CTC2-910	CX07-0088	CTT2-910	10"	27500	22000	55000
CX07-0067	CTC1-912	CX07-0089	CTT1-912	12"	18500	14800	37000
CX07-0068	CTC2-912	CX07-0090	CTT2-912	12"	32000	25600	64000

CAUTION: Do not use aluminum fittings where acids, alkalis or other corrosive agents are present. The above capacities are for steel hardware only. Aluminum hardware may only be used with single ply web slings. Capacities shown represent minimum values. For actual rated capacities consult your local CERTEX branch.



WARNING:

Failure to read, understand and follow the use and inspection instructions could result in severe personal injury or death. Do not exceed rated capacities.

SPECIFICATIONS ON HARDWARE

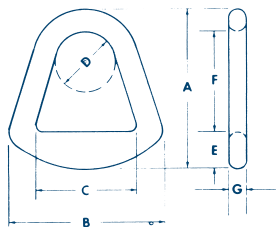

ALUMINUM CHOKERS

CERTEX Cat. Ref. No.	Size	A	B	C	D	E	F	G	Approx. Weight (lbs.)w	Rated Capacity (lbs.)	Minimum Break
CX07-0091	T2	4	3 5/8	2 1/4	1 3/4	15/16	2 3/8	9/16	.31	3,360	16,800
CX07-0092	T3	5 1/4	5	3 1/4	2	1 3/16	3 5/16	5/8	.75	5,000	25,000
CX07-0093	T4	6 1/4	6 5/8	4 3/8	2 3/8	1 7/16	4	11/16	1.1	6,700	33,500
CX07-0094	T6	8 5/16	8 7/8	6 3/8	3 1/8	1 3/4	5 1/2	15/16	2.7	9,700	48,500

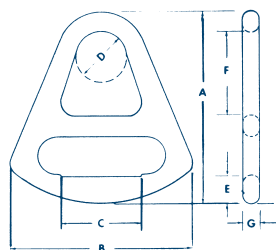

ALUMINUM CHOKERS

CERTEX Cat. Ref. No.	Size	A	B	C	D	E	F	G	Approx. Weight (lbs.)	Rated Capacity (lbs.)	Minimum Break
CX07-0095	C2	6 1/8	5 1/4	2 1/8	1 3/4	15/16	2 3/8	9/16	.73	3,360	16,800
CX07-0096	C3	7 1/2	7 1/8	3 1/8	2	1 1/8	3 5/16	5/8	1.3	5,000	25,000
CX07-0097	C4	8 3/4	8 3/4	4 1/8	2 3/8	1 7/16	4	11/16	1.9	6,700	33,500
CX07-0098	C6	11 5/16	11 3/4	6 1/8	3 1/8	1 3/4	5 1/2	15/16	5.1	9,700	48,500

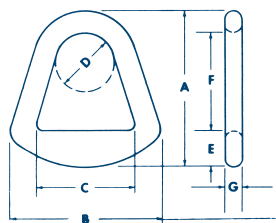

STEEL TRIANGLES

CERTEX Cat. Ref. No.	Size	A	B	C	D	E	F	G	Approx. Weight (lbs.)	Rated Capacity (lbs.)	Minimum Break
CX07-0099	ST2	2 7/8	3 3/4	2 1/8	1 3/4	1	2 5/16	1/2	1	6,600	33,000
CX07-0100	ST3	5 3/16	5	3 1/16	2	1 1/4	3 5/16	1/2	1.6	8,400	42,000
CX07-0101	ST4	6 7/16	6 5/8	4 5/16	2	1 5/8	3 7/8	1/2	2.7	11,200	56,000
CX07-0102	ST5	7 7/8	7 15/16	5 3/16	2 1/2	2	4 15/16	1/2	3.5	14,000	70,000
CX07-0103	ST6	9	9 1/4	6 1/8	2 3/4	2 5/16	5 9/16	1/2	5.3	16,800	84,000
CX07-0104	ST8	11 7/16	12	8 1/4	3 5/8	2 7/8	7 3/16	3/4	12	22,400	112,000
CX07-0105	ST10	13 1/4	14 1/8	10 1/8	4 7/8	3 5/8	8 1/4	3/4	17	28,000	140,000
CX07-0106	ST12	13 13/16	16 7/16	12 3/8	5	4 1/16	8	3/4	19	32,000	160,000

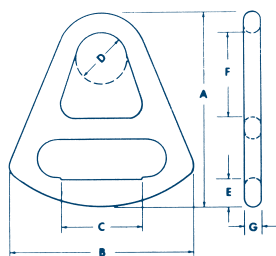

STEEL CHOKERS

CERTEX Cat. Ref. No.	Size	A	B	C	D	E	F	G	Approx. Weight (lbs.)	Rated Capacity (lbs.)	Minimum Break
CX07-0107	SC2	6	5 1/2	2 1/8	2	1 1/16	2 1/4	1/2	2	6,600	33,000
CX07-0108	SC3	7 1/2	7	3 1/8	2	1 3/16	3 3/16	1/2	2.9	8,400	42,000
CX07-0109	SC4	9 5/16	9 9/16	4 1/8	2 1/2	1 13/16	3 1/2	1/2	6	11,200	56,000
CX07-0110	SC5	10 9/16	11 5/8	5 1/8	2 3/4	2 1/16	4 7/16	1/2	7	14,000	70,000
CX07-0111	SC6	12	12 3/4	6 1/8	2 7/8	2 11/16	4 9/16	1/2	9.8	16,800	84,000
CX07-0112	SC8	14 7/16	16 1/2	8 1/8	5	2 13/16	6 7/16	3/4	24	22,400	112,000
CX07-0113	SC10	16 1/2	18 3/4	10 1/4	5 1/8	3 1/2	7 5/8	3/4	28	28,000	140,000
CX07-0114	SC12	19 1/4	22 5/8	12 1/8	5 1/2	4 1/4	9 3/4	3/4	40	32,000	160,000

Other hardware fittings are available on request. Please contact your nearest CERTEX location.

RATED CAPACITIES

Eye & Eye Type III & IV

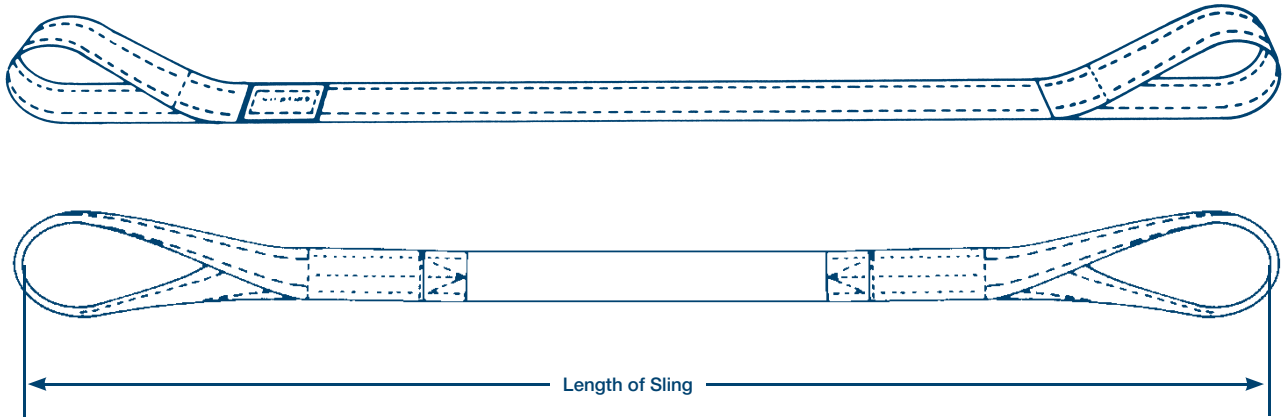

1 & 2 Ply Slings

RATED CAPACITIES (POUNDS)*

CERTEX Cat. Ref. No.	Type	Width	Vertical	Choker	Basket
CX07-0117	CEE1-91	1"	1600	1200	3200
CX07-0118	CEE2-91	1"	3100	2480	6200
CX07-0119	CEE1-k	1 3/4"	1900	1520	3000
CX07-0120	CEE2-k	1 3/4"	3800	3040	7600
CX07-0121	CEE1-H	1 3/4"	2700	2160	5400
CX07-0122	CEE2-H	1 3/4"	5400	4320	10800
CX07-0125	CEE1-92	2"	3100	2500	6200
CX07-0126	CEE2-92	2"	6200	5000	12400
CX07-0129	CEE1-93	3"	4700	3700	9400
CX07-0130	CEE2-93	3"	8800	7040	17600
CX07-0133	CEE1-94	4"	6200	5000	12400
CX07-0134	CEE2-94	4"	11000	8800	22000
CX07-0135	CEE1-95	5"	7800	6200	15600
CX07-0136	CEE2-95	5"	13700	10960	27400
CX07-0139	CEE1-96	6"	9300	7400	18600
CX07-0140	CEE2-96	6"	16500	13200	33000
CX07-0141	CEE1-98	8"	11750	9400	21150
CX07-0142	CEE2-98	8"	22750	18200	42350
CX07-0143	CEE1-910	10"	14700	11760	26450
CX07-0144	CEE2-910	10"	28400	22720	52900
CX07-0145	CEE1-912	12"	17650	14120	31750

* Rated loads are for slings without tapered eyes. Folding or bunching which occurs when used with shackles, hooks or other applications will reduce the rated load. Capacities shown represent minimum values. For actual rated capacities consult your local CERTEX branch.

WARNING:

Failure to read, understand and follow the use and inspection instructions could result in severe personal injury or death. Do not exceed rated capacities.

RATED CAPACITIES

Eye & Eye Type III & IV

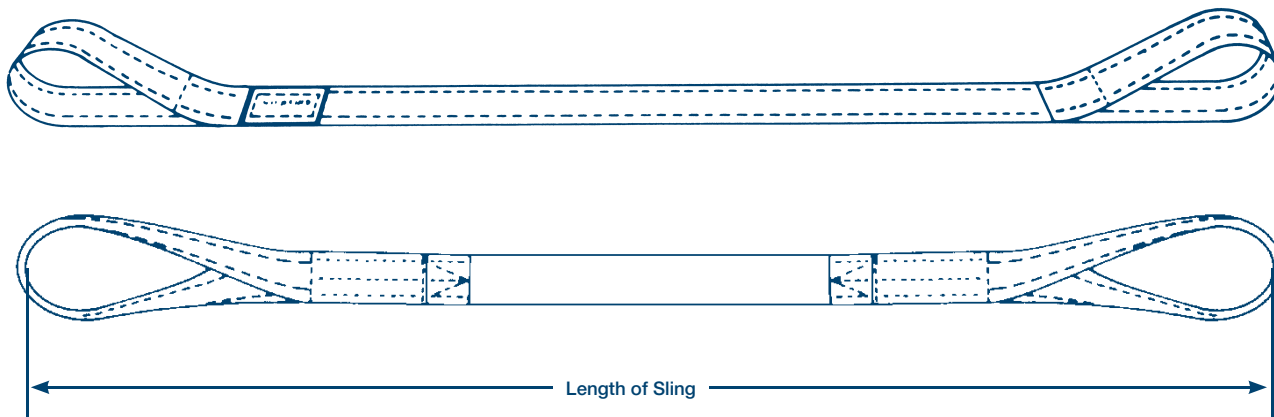

3 & 4 Ply Slings

RATED CAPACITIES (POUNDS)*

CERTEX Cat. Ref. No.	Type	Width	Vertical	Choker	Basket
CX07-0150	CEE4-91	1"	5500	4400	11000
CX07-0152	CEE4-915	1 1/2"	8200	6560	16400
CX07-0154	CEE4-K	1 3/4"	6660	5320	13320
CX07-0156	CEE4-H	1 3/4"	9600	7680	19200
CX07-0160	CEE4-92	2"	11000	8800	22000
CX07-0164	CEE4-93	3"	16450	13160	32900
CX07-0168	CEE4-94	4"	20400	16320	40800
CX07-0170	CEE4-95	5"	25500	20400	51000
CX07-0174	CEE4-96	6"	30600	24480	61200
CX07-0176	CEE4-98	8"	40800	32640	81600
CX07-0178	CEE4-910	10"	51000	40800	102000
CX07-0180	CEE4-912	12"	61240	49000	122480

* Rated loads are for slings without tapered eyes. Folding or bunching which occurs when used with shackles, hooks or other applications will reduce the rated load. Capacities shown represent minimum values. For actual rated capacities consult your local CERTEX branch.

WARNING:

Failure to read, understand and follow the use and inspection instructions could result in severe personal injury or death. Do not exceed rated capacities.

RATED CAPACITIES

Endless Type V

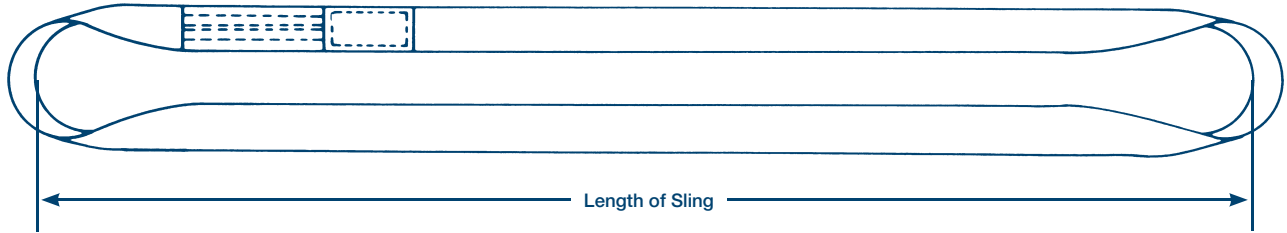

1 & 2 Ply Slings

RATED CAPACITIES (POUNDS)*

CERTEX Cat. Ref. No.	Type	Width	Vertical	Choker	Basket
CX07-0183	CEN1-91	1"	3200	2500	6400
CX07-0184	CEN2-91	1"	6400	5100	12800
CX07-0185	CEN1-K	1 3/4"	3200	2600	6400
CX07-0186	CEN2-K	1 3/4"	6150	5000	12300
CX07-0187	CEN1-H	1 3/4"	4800	3840	9600
CX07-0188	CEN2-H	1 3/4"	9600	7600	19200
CX07-0191	CEN1-92	2"	6200	5000	12400
CX07-0192	CEN2-92	2"	12400	9900	24800
CX07-0195	CEN1-93	3"	9400	7500	18800
CX07-0196	CEN2-93	3"	18800	15000	37600
CX07-0199	CEN1-94	4"	12400	9900	24800
CX07-0200	CEN2-94	4"	22000	16500	44000
CX07-0201	CEN1-95	5"	15600	12500	31200
CX07-0202	CEN2-95	5"	31200	25000	62400
CX07-0205	CEN1-96	6"	18600	14900	37200
CX07-0206	CEN2-96	6"	33000	24750	66000
CX07-0207	CEN1-98	8"	21150	15900	42300
CX07-0208	CEN2-98	8"	42350	31200	84700
CX07-0209	CEN1-910	10"	26450	19850	52900
CX07-0210	CEN2-910	10"	52900	39700	105800
CX07-0211	CEN1-912	12"	31750	23800	63750
CX07-0212	CEN2-912	12"	63500	47600	107000

* Rated loads are based on untapered slings. Folding or bunching which occurs when used with shackles, hooks or other applications will reduce rated loads. Consult the manufacturer.

Capacities shown represent minimum values. For actual rated capacities consult your local CERTEX branch.

WARNING:

Failure to read, understand and follow the use and inspection instructions could result in severe personal injury or death. Do not exceed rated capacities.

RATED CAPACITIES

Endless Type V

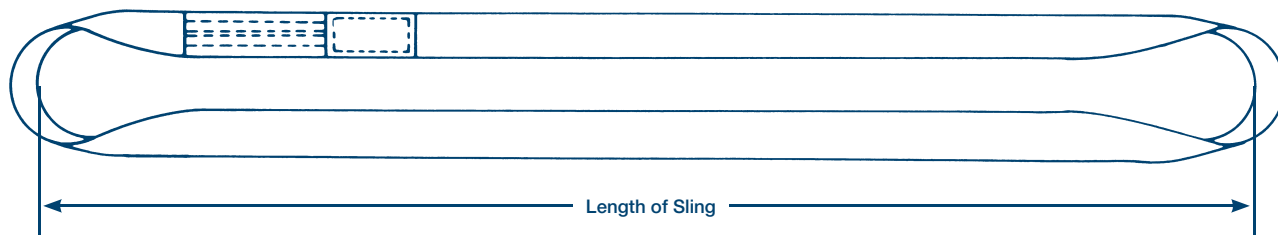

3 & 4 Ply Slings

RATED CAPACITIES (POUNDS)*

CERTEX Cat. Ref. No.	Type	Width	Vertical	Choker	Basket
CX07-0214	CEN4-61	1"	7600	6000	15200
CX07-0216	CEN4-91	1"	11000	8800	22000
CX07-0218	CEN4-915	1 1/2"	16400	13100	32800
CX07-0220	CEN4-K	1 3/4"	13300	10600	26600
CX07-0222	CEN4-H	1 3/4"	19200	15400	38400
CX07-0226	CEN4-92	2"	21900	17500	43800
CX07-0230	CEN4-93	3"	32900	26300	65800
CX07-0234	CEN4-94	4"	40800	32600	81600
CX07-0236	CEN4-95	5"	51000	40800	102000
CX07-0240	CEN4-96	6"	61200	49000	122400
CX07-0242	CEN4-98	8"	81600	65300	163200
CX07-0244	CEN4-910	10"	101000	80800	202000
CX07-0246	CEN4-912	12"	121800	97400	243600

* Rated loads are for slings without tapered eyes. Folding or bunching which occurs when used with shackles, hooks or other applications will reduce the rated load. Capacities shown represent minimum values. For actual rated capacities consult your local CERTEX branch.

WARNING:

Failure to read, understand and follow the use and inspection instructions could result in severe personal injury or death. Do not exceed rated capacities.

RATED CAPACITIES

Reversed Eye Type VI

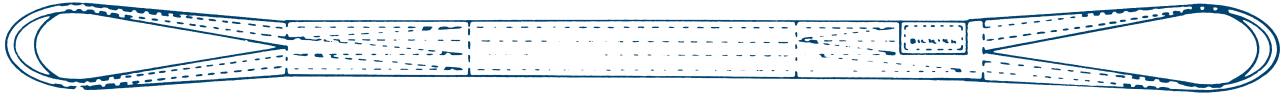

These are the most durable of all web slings. The complete sling, both sides, are covered with a buffer web for the maximum abrasion resistance, including the eyes. Eye configuration allows for tight choking also great for vertical and basket hitches.

RATED CAPACITIES (POUNDS)*

CERTEX Cat. Ref. No.	Type	Width	Vertical	Choker	Basket
CX07-0248	CRE1-91	2"	4800	3800	9600
CX07-0250	CRE2-91	2"	7700	6100	15400
CX07-0252	CRE1-915	3"	4750	3800	9500
CX07-0254	CRE2-915	3"	9000	7200	18000
CX07-0255	CRE1-K	3 1/2"	4000	3200	8000
CX07-0256	CRE1-H	3 1/2"	5000	4000	10000
CX07-0257	CRE2-K	3 1/2"	7500	6000	15000
CX07-0258	CRE2-H	3 1/2"	10000	8000	20000
CX07-0261	CRE1-92	4"	7700	6200	15400
CX07-0263	CRE2-92	4"	13000	10400	26000
CX07-0265	CRE4-92	4"	20700	16560	41400
CX07-0269	CRE2-93	6"	20000	16000	40000
CX07-0271	CRE4-93	6"	32500	26000	65000

WARNING:

Failure to read, understand and follow the use and inspection instructions could result in severe personal injury or death. Do not exceed rated capacities.

RATED CAPACITIES

Cargo Slings Wide Body

These wide body slings are used in a basket hitch only where wider slings are needed for better load stability. These wider slings distributes the load over a larger sling surface area and also offer great protection over smooth and soft surfaces. Standard widths from six through twenty four inches. Wider widths available on request.

CERTEX Cat. Ref. No.	Type	Width Inches	Vertical Basket Capacity
CX07-0273	CCS2-93	6"	18000
CX07-0275	CCS4-93	6"	37000
CX07-0277	CCS2-94	8"	24000
CX07-0279	CCS4-94	8"	41000
CX07-0281	CCS2-96	12"	37000
CX07-0283	CCS4-96	12"	66000
CX07-0284	CCS2-98	16"	42000
CX07-0285	CCS4-98	16"	86000
CX07-0287	CCS3-96	18"	37000
CX07-0289	CCS6-96	18"	66000
CX07-0290	CCS3-98	24"	44000
CX07-0291	CCS2-912	24"	66000
CX07-0292	CCS6-98	24"	88000
CX07-0293	CCS4-912	24"	130000

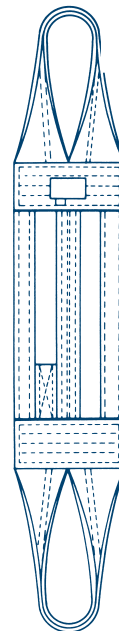

Cargo Type
(Wide Body)

Load Balancing Slings

These Load Balancing slings serve the same purpose as the Cargo type slings except they are more economical due to the reduced capacities. Also the eyes are smaller to fit the smaller hoist hooks. Wider widths available on request.

CERTEX Cat. Ref. No.	Type	Width Inches	Vertical Basket Capacity
CX07-0294	CLB6	6"	8000
CX07-0295	CLB8	8"	8000
CX07-0296	CLB12	12"	8000
CX07-0297	CLB16	16"	10000
CX07-0298	CLB18	18"	10000
CX07-0299	CLB24	24"	10000

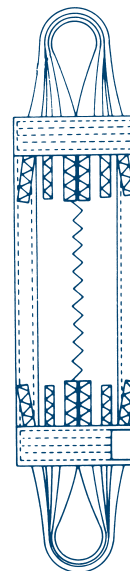

WARNING:

Failure to read, understand and follow the use and inspection instructions could result in severe personal injury or death. Do not exceed rated capacities.

WEB SLINGS

Bridle Slings (Multi-Legged)

These Bridle Slings assemblies are used on lifts that need multiple legs and come equipped with many variations of rings, hooks and other fittings.

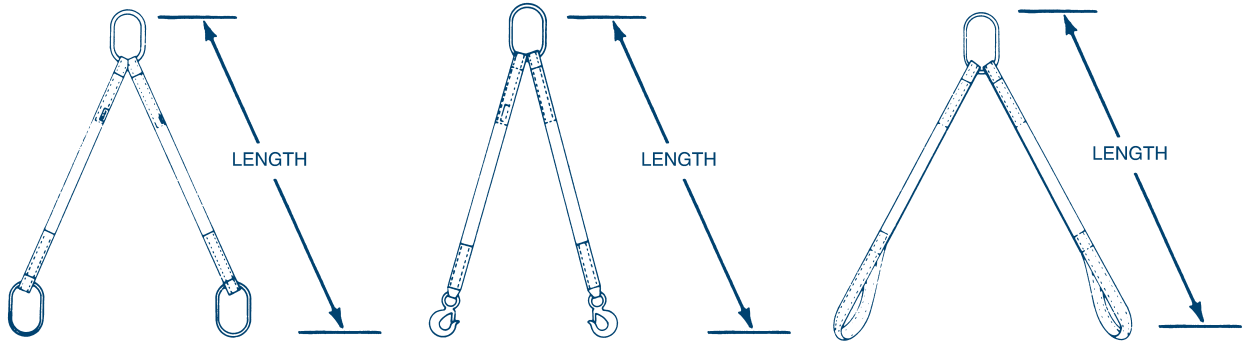

3 and 4 legged assemblies available on request. Because of the wide variety of fittings which can greatly affect the rated capacity of an assembly please contact your nearest CERTEX location to discuss your specific lifting requirements.

Hardware Slings (Single Leg)

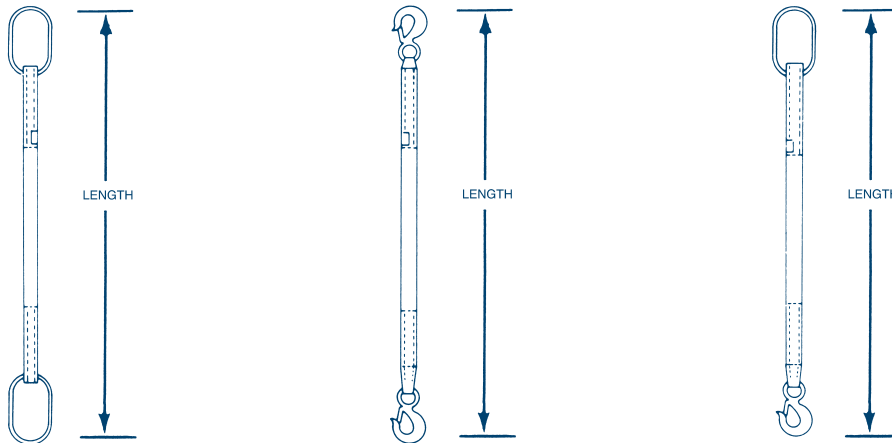

CERTEX Oneway® Slings

These slings are designed for applications where the sling is used only once or twice and then disposed of. They are constructed of materials of the same high quality as our other synthetic slings only they are not designed to take the repeated usage as standard slings. The design factors can be suited to your particular applications and we have found these slings to be quite cost effective when compared to our other slings. Oneway® Slings are available in many different constructions, widths and capacities. Give your nearest CERTEX Company a call for more information.

WARNING:

Failure to read, understand and follow the use and inspection instructions could result in severe personal injury or death. Do not exceed rated capacities.

CERTEX MARINE SLINGS

CERTEX marine slings are manufactured from heavy duty nylon or polyester webbing treated for abrasion and UV resistance. These slings are soft and flexible to conform to any boat size and hull configuration. Available in many different widths and capacities. Contact your nearest CERTEX location for more information.

CERTEX Cat. Ref. No.	Parts Number	Sling Width	Standard Eye Length	Basket Capacity In Lbs.
CX07-0301	CMS1-93	3"	9"	9,300
CX07-0303	CMS1-94	4"	12"	12,400
CX07-0305	CMS1-96	6"	14"	18,600
CX07-0306	CMS1-98	8"	18"	24,800
CX07-0307	CMS2-98		18"	44,000
CX07-0309	CMS1-910	10"	12"	31,000
CX07-0311	CMS2-910		18"	55,000
CX07-0313	CMS1-912	12"	14"	37,200
CX07-0315	CMS2-912		20"	66,000
CX07-0316	CMS1-916	16"	18"	44,000
CX07-0317	CMS2-916		24"	88,000

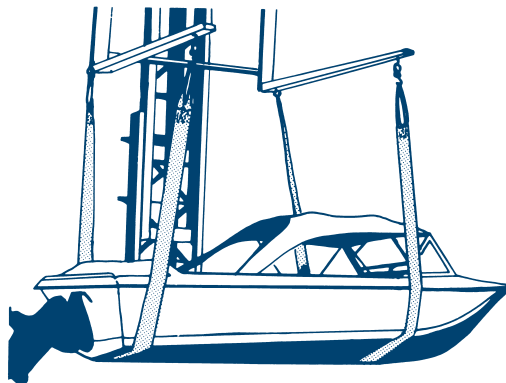

Nylon stretches approximately 6% at the rated capacity. Polyester stretches approximately 3% at rated capacity. CERTEX will custom design and fabricate marine slings to meet your specific needs.

Standard Web Type

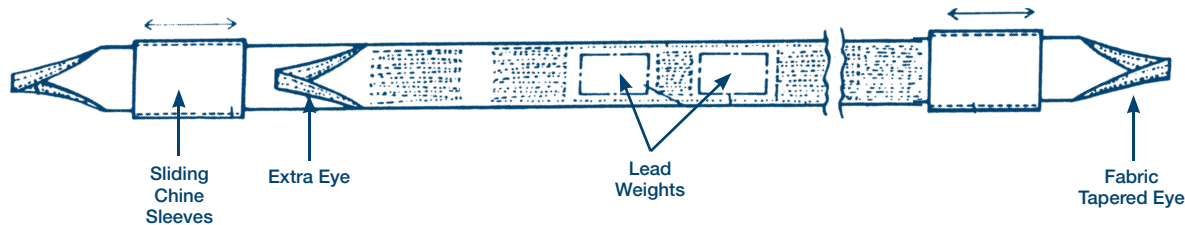

Hardware Disconnect Type

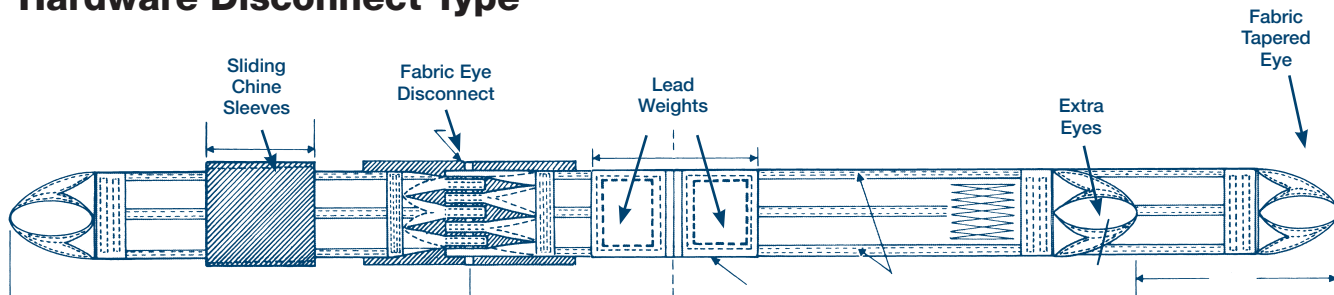

WARNING:

Marine slings which are continuously exposed to ultra-violet (sun) light can effect the strength of the slings in varying degrees ranging from slight to total degradation. Marine slings require inspections before each use by a qualified person to determine if the slings meet the requirements of the lift. Marine slings shall be proof tested to twice their rated capacity semi-annually, or more frequently depending on severity of exposure.

WARNING:

Do not exceed rated capacities.

CERTEX WHEEL NETS

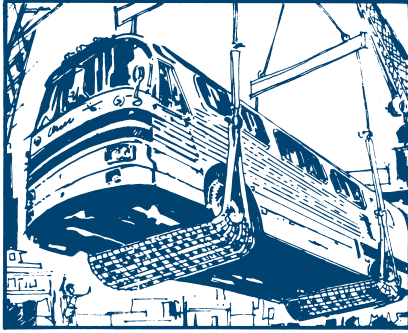

CERTEX Wheel Nets make for fast loading of any size vehicle due to the lightweight, high strength synthetic webbing. This webbing is soft and flexible to conform to any surface. These wheel nets are used in matched sets and are designed and fabricated to your specific requirements. When not in use these wheel nets fold up for easy storage and are not affected by moisture.

CERTEX Wheel Nets come in standard capacities and sizes from 5 tons through 30 tons. Call your nearest CERTEX location for more information. Please have vehicle body size, capacity of vehicle and length from ground level to lifting device.

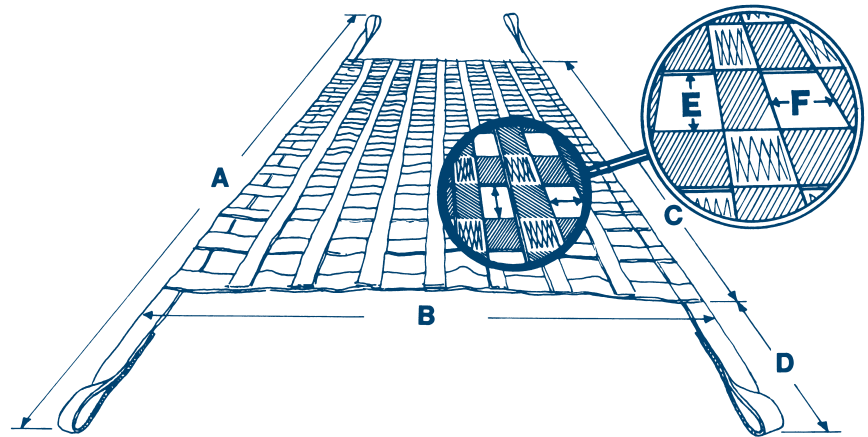

Wear Pads & Sleeves

Wear pads give a sling extra protection where it wears the most. They can be furnished in either webbing or leather. Leather pads are more resistant to wear and cutting, but are subject to gradual deterioration from oils, grease and dirt. Nylon webbing wear pads are fully resistant to oils, grease, and they stretch in proportion to the sling.

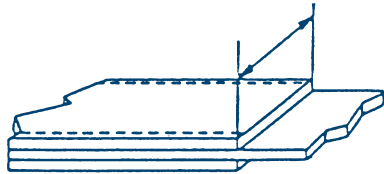

Regular Wear Pad

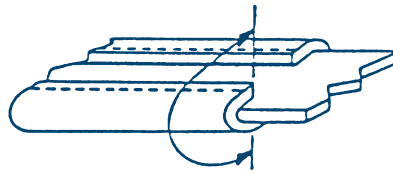

Edge Wrap

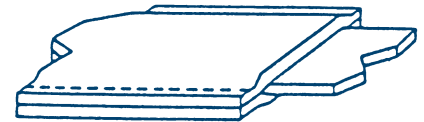

Sliding Sleeve

REGULAR – This is the type that is sewn on to give fixed protection at expected wear points. They can be sewn anywhere on the sling, at any length on one side or on both sides.

EDGE GUARD – A strip of webbing or leather is sewn around each edge of the sling, extending approximately 1/2" onto the face of the webbing. This is necessary for certain applications where sling edges are subject to damage.

SLEEVE – Sometimes called sliding sleeve or tube type wear pads, these pads are suggested for handling material with sharp edges. Sleeves cover both sides of the sling and can be shifted to wear points.

WARNING:

Failure to read, understand and follow the use and inspection instructions could result in severe personal injury or death. Do not exceed rated capacities.

SYNTHETIC SLING FITTINGS

The Crosby Group, Inc.

“Synthetic Sling Saver” Shackles and Hooks



S-252
(Bolt Type)



S-253
(Screw Pin)



WS-320A

- Designed with Non-Slip surface that:
 - Eliminates “bunching” effect caused by traditional shackles.
 - Reduces sling tendency to slide.
- Shackles available in sizes 3 1/4 to 50 tons.
- Hooks available is sizes 1 1/2, 3 and 5 tons.
- Increased radius of bow / eye gives wider sling bearing surface resulting in an increased area for load distribution, thus:
 - Increasing Synthetic Sling efficiency by at least 15% as compared to standard anchor and chain shackle bows and conventional eye hooks. This allows 100% of the slings rated Working Load Limit to be achieved.
 - Allowing better load distribution on internal fibers.
- Design factor of 5 to 1.
- Shackles available in both a Screw Pin and Bolt, Nut and cotter pin configuration.
- Bolt (Pin) has a larger diameter that provides better load distribution.
- Look for the Red Pin™ ... the mark of Genuine Crosby quality.
- Each shackle and hook has a Product Identification Code (PIC) for material traceability along with a Working Load Limit and the name Crosby forged into it.
- All Alloy construction.
- Fatigue rated to 20,000 cycles at 1 1/2 times the Working Load Limit.

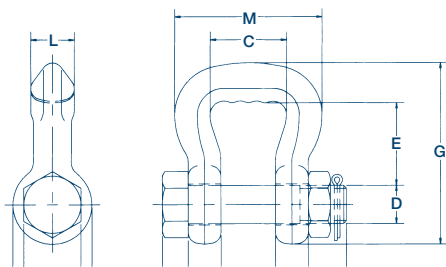

S-252

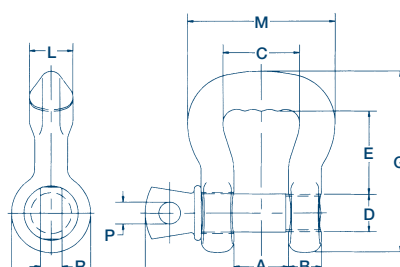

S-253

Web Sling Nominal Size (in.)	Round Sling Size (Number)	Working Load Limit* (tons)	S-252 Bolt Type			S-253 Bolt Type			Dimensions (in.)														
			CERTEX Cat. Ref. No.	Crosby S-252 Stock No.	Weight Each (lbs.)	CERTEX Cat. Ref. No.	Crosby S-253 Stock No.	Weight Each (lbs.)	A	B	C	D	E	F	G	H	J	K	L	M	N	P	R
1	1 & 2	3 1/4	CX07-0318	1020485	1.4	CX07-0325	1020575	1.4	.88	.62	1.38	.75	1.50	.44	3.38	3.68	1.12	1.50	.75	2.69	3.22	.44	1.00
1.5	3 & 4	6 1/2	CX07-0319	1020496	2.4	CX07-0326	1020584	2.2	1.25	.75	1.75	.88	1.88	.50	4.15	4.25	1.31	1.81	1.00	3.38	4.03	.50	1.19
2	5 & 6	8 3/4	CX07-0320	1020507	4.1	CX07-0327	1020593	3.8	1.38	.88	2.25	1.00	2.81	.56	5.50	4.72	1.50	2.09	1.12	4.19	4.50	.50	1.44
3	7 & 8	12 1/2	CX07-0321	1020518	8.0	CX07-0328	1020602	7.3	1.62	1.12	3.25	1.25	3.06	.75	6.34	5.88	1.88	2.62	1.38	5.62	5.59	.62	1.81
4	9 & 10	20 1/2	CX07-0322	1020529	16.9	CX07-0329	1020611	15.2	2.12	1.38	4.50	1.50	5.75	.88	9.75	7.19	2.25	3.12	1.75	7.50	6.88	.75	2.13
5	11 & 12	35	CX07-0323	1020540	35.0	CX07-0330	1020620	30.8	2.50	1.75	5.50	2.00	6.34	1.12	11.50	9.31	3.00	4.19	2.25	9.19	8.66	1.00	2.88
6	13	50	CX07-0324	1020551	57.5	CX07-0331	1020629	52.0	3.00	2.12	6.50	2.25	7.70	1.25	13.75	10.38	3.38	4.75	2.75	11.00	10.22	1.22	3.19

* Note: Maximum Proof load is 2 1/2 times the Working Load Limit. Minimum Ultimate Strength is 5 times the Working Load Limit.

SYNTHETIC SLING FITTINGS

The Crosby Group, Inc.

Accessories



S-255
Spool

The “Spool” is designed to keep the load centered on the pin, thus keeping the sling positioned correctly in the shackle bow.

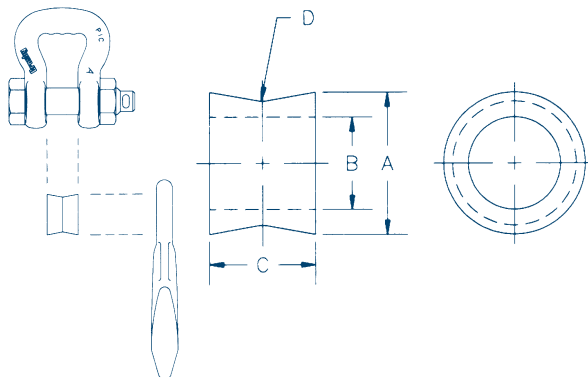

Shackle Size (in.)	CERTEX Cat. Ref. No.	Crosby Stock No.	Dimensions (in.)				Weight Each (lbs.)
			A	B	C	D	
1	CX07-0332	1020903	1.25	.81	.75	.19	.33
1.5	CX07-0333	1020912	1.50	.94	1.00	.25	.57
2	CX07-0334	1020921	1.75	1.05	1.19	.31	.89
3	CX07-0335	1020930	2.00	1.31	1.50	.38	1.45
4	CX07-0336	1020939	2.50	1.63	1.88	.44	2.79
5	CX07-0337	1020948	3.25	2.13	2.25	.50	2.40
6	CX07-0338	1020957	3.75	2.38	2.75	.62	4.06



S-256
Link Plate

The “Link Plate” is designed to connect two (2) S-252 or S-253 “Sling Saver” Shackles together.

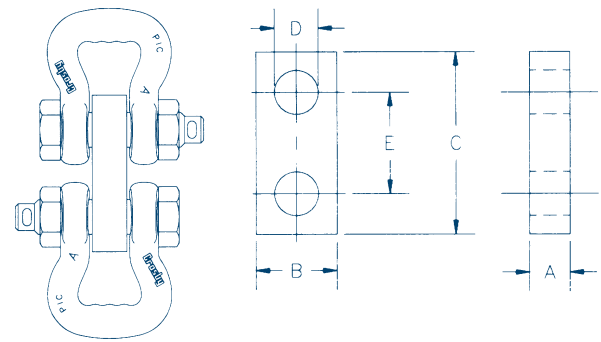

Shackle Size (in.)	CERTEX Cat. Ref. No.	Crosby Stock No.	Dimensions (in.)					Weight Each (lbs.)
			A	B	C	D	E	
1	CX07-0339	1020785	.75	1.50	3.38	.81	1.88	.83
1.5	CX07-0340	1020796	1.00	1.75	4.12	.94	2.25	1.62
2	CX07-0341	1020807	1.25	2.00	4.75	1.06	2.62	2.71
3	CX07-0342	1020818	1.50	2.50	6.00	1.31	2.35	5.18
4	CX07-0343	1020829	1.75	3.00	7.00	1.62	3.75	8.19
5	CX07-0344	1020840	2.00	4.00	9.25	2.12	5.00	17.19
6	CX07-0345	1020851	3.00	5.00	10.50	2.38	5.75	37.40

WEB CONNECTOR

Sling Saver®

The Web Connector line is designed to connect Synthetic Web Slings and Synthetic Round Slings to conventional hardware.

Load Rated®



S-280
Web Connector

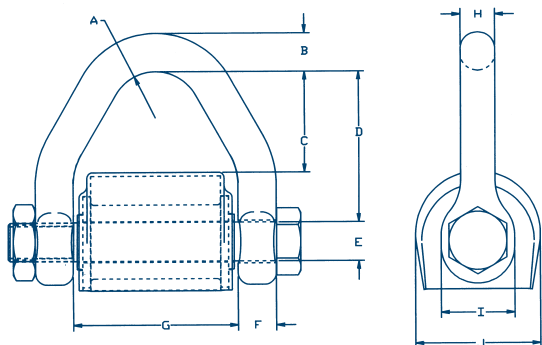

WARNING:

A falling load may cause serious injury or death.
Read, understand and follow all instructions and chart information before using web connector.
Before use, tighten bolt first, then tighten nut.

- Connects Synthetic Web and Synthetic Round Slings to conventional Crosby hardware including:
 - 320N Eye Hook
 - Additional Crosby Grade 8 Fittings
 - Master Links
 - Rings
 - Shackles
- Makes a field assembled bridle quick and easy.
- No cotter pin to snag sling material.
- Durable Vinyl cover that:
 - Protects sling at eye.
 - Keeps slings positioned correctly on spool.
- Increased radius of spool gives wider sling bearing surface resulting in an increased area for load distribution, thus:
 - Increasing Synthetic Sling efficiency by at least 15% as compared to standard anchor and chain shackle bows and conventional eye hooks. This allows 100% of the sling's rated Working Load Limit to be achieved.
 - Allowing better load distribution on internal fibers.
- All Alloy construction.
- Design Factor of 5 to 1.
- Replacement kit for spool and web cover available.
- Designed for use with Type III (Eye & Eye), Class 7, 2 ply webbing & Synthetic Round Slings. Also accommodates single ply and endless slings.

Round Sling Size (No.)	Web Slings*			S-280 Working Load Limit† (tons)	CERTEX Cat. Ref. No.	Crosby S-280 Stock No.	Weight Each (lbs.)	Dimensions (in.)									
	Webbing Width (in.)	Eye Width (in.)	Ply					A	B	C	D	E	F	G	H	I	J
1 & 2	2	2	2	3-1/4	CX07-0346	1021681	1.5	.75	.62	1.63	2.44	.63	.62	2.69	.56	1.19	2.02
3	3	1.5	2	4-1/2	CX07-0347	1021690	1.9	.75	.69	1.10	2.01	.75	.69	2.19	.60	1.38	2.34
4	4	2	2	6-1/4	CX07-0348	1021700	2.9	.75	.81	1.66	2.56	.88	.75	2.69	.69	1.62	2.46
5 & 6	6	3	2	8-1/2	CX07-0349	1021709	5.1	1.00	.94	2.47	3.50	1.00	.88	3.69	.88	1.88	2.84

* Type III (Eye & Eye), Class 7, 2-Ply

† NOTE: Maximum Proof Load is 2-1/2 times the Working Load Limit. Minimum Ultimate strength is 5 times the Working Load Limit.

WEB SLING SHACKLE

The Crosby Group, Inc.

Web Sling Shackle is designed to connect Synthetic Web Slings and Synthetic Round Slings to eyebolts, pad eyes and lifting lugs.

Load Rated®



S-281
Web Sling Shackle

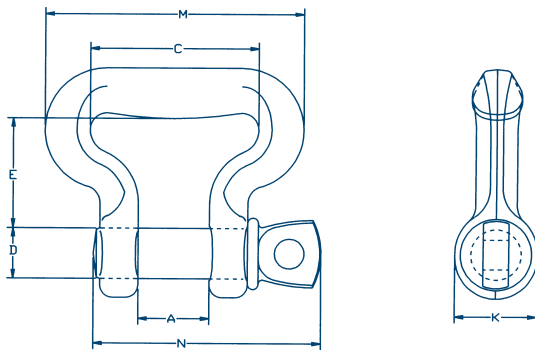

Shackles

- Incorporates same ear spread and pin dimensions as conventional Crosby Shackles.
- Allows easy connection to pad eyes, eye bolts and lifting lugs.
- Increased radius of bow gives wider sling bearing surface resulting in an increased area for load distribution, thus:
 - Increasing Synthetic Sling efficiency by at least 15% as compared to standard anchor and chain shackle bows and conventional eye hooks. This allows 100% of the sling's rated Working Load Limit to be achieved.
 - Allowing better load distribution on internal fibers.
- All Alloy construction.
- Design Factor of 5 to 1.
- Each shackle has a Product Identification Code (PIC) for material traceability along with a Working Load Limit and the name Crosby forged into it.

Round Sling Size (No.)	Web Sling *			S-281 Working Load Limit† (tons)	CERTEX Cat. Ref. No.	Crosby S-281 Stock No.	Weight Each (lbs.)	Dimensions (in.)						
	Webbing Width (in.)	Eye Width (in.)	Ply					A	C	D	E	K	M	N
1 & 2	2	2	2	3-1/4	CX07-0350	1021048	1.2	1.06	2.50	.75	1.62	1.22	3.84	3.34
3	3	1.5	2	4-1/2	CX07-0351	1021057	1.5	1.25	2.00	.88	1.50	1.41	3.38	3.97
4	4	2	2	6-1/4	CX07-0352	1021066	2.5	1.44	2.50	1.00	2.00	1.62	4.22	4.50
5 & 6	6	3	2	8-1/2	CX07-0353	1021075	4.3	1.69	3.62	1.13	2.75	1.84	5.64	5.13

* Designed for use with Type III (Eye & Eye), Class 7, 2-Ply web slings.

† NOTE: Maximum Proof Load is 2-1/2 times the Working Load Limit. Minimum Ultimate strength is 5 times the Working Load Limit.

SLIDING CHOKER HOOK

The Crosby Group, Inc.

S-287 Sliding Choker Hook for Webbing



S-287
Choker Hook

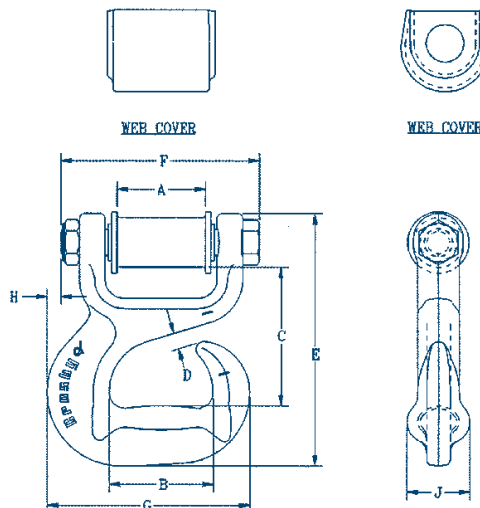

Crosby's new S-287 is designed specifically for choker applications using web slings.

- Available in 2 sizes: 3-1/4 tons (2" webbing) and 4-1/2 tons (3" webbing).
- Special design of hook protects the synthetic sling when dropped or dragged.
- Designed to reduce friction, abrasion, and fraying in choker area.

- Design factor of 5 to 1.
- Forged alloy steel.
- Each Connector has a Product Identification Code (PIC) for material traceability along with a Working Load Limit and the name Crosby forged into it.
- Use same spool and cover as S-280 Web Connector.
 - Replacement Kit for Spool and Web Cover available.

Round Sling Size (No.)	Web Sling *			Working Load Limit (tons)	CERTEX Cat. Ref. No.	Crosby S-287 Stock No.	Dimensions (in.)										Weight Each (lbs.)
	Webbing Width (in.)	Eye Width (in.)	Ply				A	B	C	D	E	F	G	H	J		
1 & 2	2	2	2	3-1/4	CX07-0503	1021909	2.13	2.50	3.32	.38	6.03	4.77	4.88	.34	1.50	3.7	
3	3	1.5	2	4-1/2	CX07-0504	1021918	1.63	3.50	3.67	.38	7.06	4.53	6.51	1.36	1.88	6.1	

* Designed for use with Type III, (Eye & Eye), Class 7, 2 Ply web slings.