

Product data sheet

Specifications

SQUARE D

Green Premium™



Mini circuit breaker, QO, 20A, 1 pole, 120/240VAC, 10kA, bolt on mount

QOB120

Product availability : Stock - Normally stocked in distribution facility

Price* : 39.80 USD

Main

Product	Miniature circuit-breaker
Range	QO
Current Rating	20 A
Voltage Rating	120/240 V AC 120 V AC
Mounting Type	Bolt-on
Number of Poles	1P
Circuit Breaker Type	Standard
Ratings	HACR and Switching Duty rated
Electrical Connection	Pressure plate

Complementary

Interrupt Rating	10 kA 120/240 V AC 50/60 Hz 10 kA 120 V AC 50/60 Hz
Number of Panel Spaces	1
Wire Size	AWG 14...AWG 8 copper or aluminium
Tightening Torque	44.25 lbf.in (5 N.m) 0.02...0.04 in ² (10...25 mm ²) (AWG 8...AWG 2)
Height	2.99 in (76 mm)
Width	0.75 in (19 mm)
Depth	2.91 in (74 mm)
Net Weight	0.30 lb(US) (0.136 kg)

Environment

Certifications	UL Listed CSA
Ambient Rating	104 °F (40 °C)

Ordering and shipping details

Category	00015-QOB CIRCUIT BREAKERS
Discount Schedule	DE2

* Price is "List Price" and may be subject to a trade discount – check with your local distributor or retailer for actual price.

GTIN	785901416722
Returnability	Yes
Country of origin	US

Packing Units

Unit Type of Package 1	PCE
Number of Units in Package 1	1
Package 1 Height	0.70 in (1.778 cm)
Package 1 Width	3.00 in (7.62 cm)
Package 1 Length	3.40 in (8.636 cm)
Package 1 Weight	4.48 oz (127.006 g)
Unit Type of Package 2	BB1
Number of Units in Package 2	10
Package 2 Height	3.50 in (8.89 cm)
Package 2 Width	3.30 in (8.382 cm)
Package 2 Length	7.90 in (20.066 cm)
Package 2 Weight	2.85 lb(US) (1.293 kg)
Unit Type of Package 3	CAR
Number of Units in Package 3	100
Package 3 Height	8.50 in (21.59 cm)
Package 3 Width	17.10 in (43.434 cm)
Package 3 Length	8.00 in (20.32 cm)
Package 3 Weight	29.00 lb(US) (13.154 kg)

Offer Sustainability

Sustainable offer status	Green Premium product
REACH Regulation	REACH Declaration
EU RoHS Directive	Compliant EU RoHS Declaration
Toxic heavy metal free	Yes
Mercury free	Yes
China RoHS Regulation	China RoHS declaration Product out of China RoHS scope. Substance declaration for your information.
RoHS exemption information	Yes
Halogen content performance	Halogen free product

Contractual warranty

Warranty	18 months
----------	-----------

Dimensions

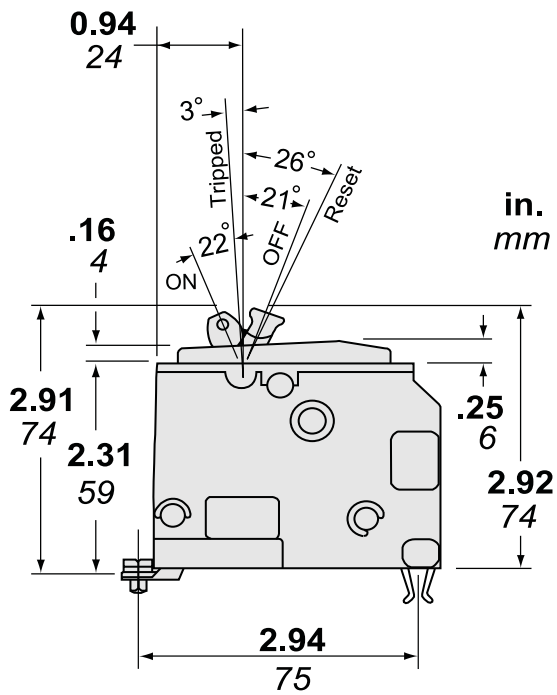
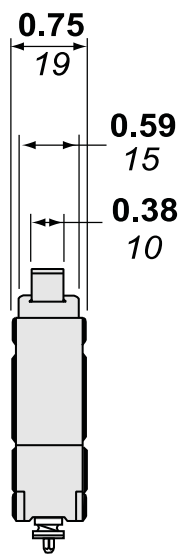
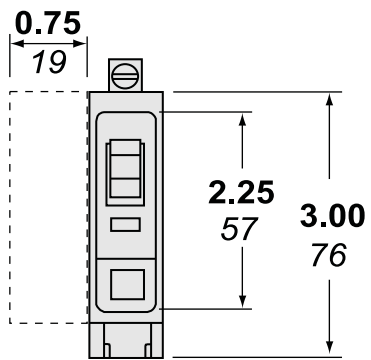

Dimensions are approximate. Refer to technical documentation for additional detail.

Recommended replacement(s)