

## ENGINEERING SUBMITTAL DATA

Metalfit manufactures Ductile Iron and Gray Cast Iron Flanged Fittings for both Waterworks and Industrial applications and conforms fully to the required industry standards. Flanged Fittings are manufactured in accordance with ANSI/AWWA C110/A21.10 and ANSI B16.1, Class 125. Metalfit 2" through 12" Flanged Fittings are also listed by Underwriters Laboratories for fire protection service. Additionally, **Metalfit hydrostatically tests every fitting** to ensure quality casting integrity. These tests are performed at 1.5 times the rated working pressure.

### Mechanical Properties

#### **Cast Iron to ASTM A48**

Minimum Tensile Strength 31,000 psi

#### **Ductile Iron to ASTM A 536**

Minimum Tensile Strength 70,000 psi

Yield Strength 50,000 psi

Elongation 5%

### Water Working Pressure

#### **Gray Cast Iron**

2" - 12" CI Fittings rated 250 psi

14" - 42" CI Fittings rated 150 psi

#### **Ductile Iron**

All DI Fittings Rated 250 psi

As noted in ANSI/AWWA C111/A21/11, ductile iron flanged joints in the 24" and smaller sizes may be rated to 350 psi with the use of "special" gaskets.

## COATINGS & LININGS

### Interior Linings

Flanged fittings are furnished cement lined and seal coated per ANSI/AWWA C104/A21.4. Fittings are also available unlined for air service or with other special linings for particular service conditions.

### Exterior Coatings

Flanged fittings are furnished standard with a red epoxy primer or tar coated at the customer's discretion. Special primer coatings are also available for particular service conditions.

**All standard coatings and linings are provided in full accordance with ANSI/NSF 61.**

## COMMITMENT TO QUALITY

Metalfit takes pride in producing the finest quality Flanged Fittings available in today's market. Our manufacturing standards and a strict adherence to the quality control procedures, developed over many years, make certain that we abide by our commitment to be the best.

## Flanged Joint Dimensions ANSI/AWWA C110/A21.10

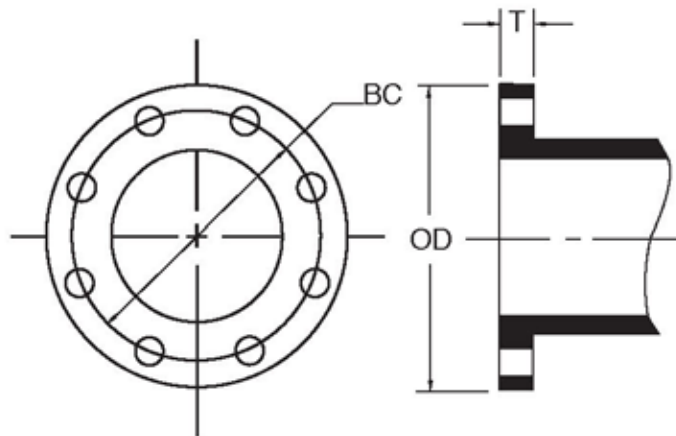

Size	OD	BC	T	Hole Dia.	Bolt Size	No. Bolts
2	6.00	4.75	0.62	0.75	5/8 x 2-1/4	4
2-1/2	7.00	5.50	0.69	0.75	5/8 x 2-1/2	4
3	7.50	6.00	0.75	0.75	5/8 x 2-1/2	4
4	9.00	7.50	0.94	0.75	5/8 x 3	8
5	10.00	8.50	0.94	0.88	3/4 x 3	8
6	11.00	9.50	1.00	0.88	3/4 x 3-1/2	8
8	13.50	11.75	1.12	0.88	3/4 x 3-1/2	8
10	16.00	14.25	1.19	1.00	7/8 x 4	12
12	19.00	17.00	1.25	1.00	7/8 x 4	12
14	21.00	18.75	1.38	1.12	1 x 4-1/2	12
16	23.50	21.25	1.44	1.12	1 x 4-1/2	16
18	25.00	22.75	1.56	1.25	1-1/8 x 5	16
20	27.50	25.00	1.69	1.25	1-1/8 x 5	20
24	32.00	29.50	1.88	1.37	1-1/4 x 5-1/2	20
30	38.75	36.00	2.12	1.37	1-1/4 x 6-1/2	28
36	46.00	42.75	2.38	1.62	1-1/2 x 7	32
42	53.00	49.50	2.62	1.62	1-1/2 x 7-1/2	36
48	59.50	56.00	2.75	1.62	1-1/2 x 8	44

### BASE DIMENSIONS

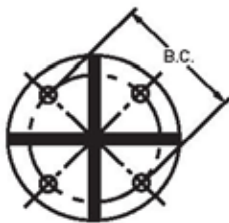

Size	B.C.	Hole Dia.	No. Bolts
3	3.88	0.62	4
4	4.75	0.75	4
6	5.50	0.75	4
8	7.50	0.75	4
10	7.50	0.75	4
12	9.50	0.88	4
14	9.50	0.88	4
16	9.50	0.88	4
18	11.75	0.88	4
20	11.75	0.88	4
24	11.75	0.88	4
30	14.25	1.00	4
36	17.00	1.00	4
42	21.25	1.12	4
48	22.75	1.25	4

### INSTALLATION NOTE

Drilling Templates are furnished in multiples of four. Standard flanged reducers, with a different number of holes in each flange, will have only two centerlines which are common to the drilling templates of both flanges.

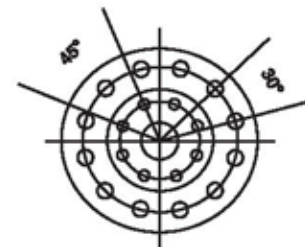

ANSI/AWWA C110/A21.10

Dimensions in inches.  
Weights in pounds.

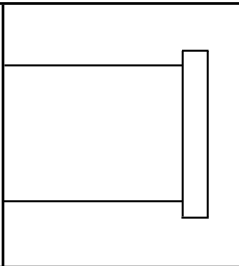

# FLANGED DI PIPE



2014 EDITION

P 3

## Flanged Pipe for Water and Other Liquids

Flanged pipe and fittings are typical components in rigid piping systems. Such systems are particularly suited for above ground installation in the following: water filtration plants, sewage disposal plants, wastewater treatment plants, pumping stations and industrial plants, per **AWWA C115/21.15**. The underground use of the flanged joint is not recommended due to the rigidity of the joint. Unequal settlement or other stressing of such piping may result in excessive strain on the flanges or the pipe due to excessive beam loadings.

### Flanged Pipe with Threaded Flanges

Pipe barrels conform to **ANSI/AWWA C151/A21.51**. Flanged pipe are fabricated by threading plain end pipe, screwing threaded flange(s) on and machine-tightening them. The bolt holes are aligned per **ANSI/AWWA C115/A21.15**. The plain end and the flange are then faced to insure that the flange is perpendicular to the pipe axis and the pipe/flange interface is flush. Pipe barrels and flanges have a taper pipe thread (NPT) in accordance with **ANSI B1.20.1**, with thread diameters adapted to Ductile Iron pipe standard outside diameters. Threaded pipe and threaded flanges are individually fitted and the flanges are not interchangeable. U.S. Pipe only uses and recommends ductile iron flanges, although **ANSI/AWWA C115/A21.15** currently allows gray iron flanges.

**Flanged pipe are furnished with a maximum length of 19' - 6". The minimum length varies by pipe size and can be found in the table on page 7.**

The minimum class thickness for Ductile Iron flanged pipe to be threaded is Special Thickness Class 53 for sizes up through 54" and pressure class 350 for 60" and 64" sizes. Greater pipe wall thicknesses can be furnished if so ordered.

Weights of flanged pipe shown are subject to a minus tolerance of not more than 10% for individual pieces. To obtain the weight of a short flanged pipe, calculate the pipe weight for the length from face to face of the flanges and add the weight of two flanges.

Pipe may be furnished with one end flanged and the other end with a TYTON<sup>®</sup>, TR FLEX<sup>®</sup>, HP LOK<sup>™</sup>, or MJ bell. Special ends such as grooved, shouldered, spigot restrained, and MJ HARNESS-LOK, are also available.

Thrust Type Wall Collars are available for wall penetrations and thrust restraint. See U.S. Pipe's THRUST COLLAR/WALL PIPE submittal for more information.

The Foreword of **ANSI/AWWA C115/A21.15** lists the required information and the options which if desired must be specified on the purchase order for flanged pipe, such as size and finished length. See the standard for more details.

### ANSI/AWWA Standards

#### **ANSI/AWWA C115/A21.15 Flanged Ductile-Iron Pipe with Ductile-Iron or Gray-Iron Threaded Flanges.**

Threaded flanged pipe conform to the requirements of ANSI/AWWA C115/A21.15.

#### **ANSI/AWWA C151/A21.51 Ductile Iron Pipe, Centrifugally Cast, for Water.**

Ductile Iron pipe used for flanging are centrifugally cast in accordance with the requirements of ANSI/AWWA C151/A21.51.

#### **ANSI/AWWA C104/A21.4 Cement-Mortar Lining for Ductile-Iron and Gray-Iron Fittings for Water.**

Cement-Mortar Lining with asphaltic coating inside in accordance with ANSI/AWWA C104/A21.4.

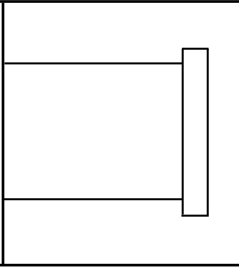

# FLANGED DI PIPE



2014 EDITION

P 4

## Flanged Pipe for Water and Other Liquids (cont.)

### Flange Compatibility and Pressure Ratings

The **ANSI/AWWA C115/A21.15 Flanged Ductile-Iron Pipe with Ductile-Iron or Gray-Iron Threaded Flanges** standards conform to the drilling and facing of ANSI B16.1 Class 125 flanges. This B16.1 Class 125 designation leads some to conclude that these AWWA flanges are only rated at 125 psi service which is not correct. Note Pressure Ratings on page 6. These ratings are at ambient temperatures with at least a 2:1 factor of safety. Special gaskets such as U.S. Pipe's **FULL FACE FLANGE-TYTE™** or **RING FLANGE-TYTE™** Gaskets are required for operating pressures greater than 250 psi for sizes 04" - 24".

(Flanges of Ductile Iron fittings meeting the requirements of **ANSI B16.1 Class 250** cannot be joined with **ANSI/AWWA C115/A21.15**.)

### Coating Systems

Unless otherwise specified, flanged pipe will be furnished with a standard thickness cement-mortar lining with asphaltic coating inside and outside. Primer coatings are available upon request. Please contact U.S. Pipe Special Projects Department at 866-DIP-PIPE for a list of available interior linings and exterior primers.

### Special Service Requirements

When requesting prices for flanged piping other than water service, please furnish complete information regarding the type of material to be conveyed, composition, concentration, pH, pressure and temperature.

### Installation

U.S. Pipe recommends the use of **FULL FACE FLANGE-TYTE™** Gaskets or **RING FLANGE-TYTE™** Gaskets with Ductile Iron flanged joint products supplied by U.S. Pipe. These gaskets were designed specifically for the unique surface of Ductile Iron. Flat rubber gaskets are NOT considered equal in performance and may not provide the sealing capability the project requires. In addition, their use could result in unintended damage to the flanges and threads of the fabricated pipe by applying excess torque to the bolts/flanges in order to seal the joint. Please refer to U.S. Pipe's **FULL FACE FLANGE-TYTE™** or **RING FLANGE-TYTE™** Gaskets at [www.uspipe.com](http://www.uspipe.com).

The use of flanged joints underground is not recommended because of the rigidity of the joint.

Flanged faces should bear uniformly on the gasket, and the bolts should be tightened in a progressively crisscrossed pattern, such as by tightening the bottom bolt first; then, the top bolt; next, the bolts at either side; and finally, the remaining bolts. This process should be repeated until all bolts are adequately tightened.

Users of flanged piping should be careful to prevent bending or torsional strains from being applied to flanges or flanged appurtenances. Piping systems must be designed so that piping connected to flanges is properly anchored, supported, or restrained to prevent breakage of flanges and flanged fittings or appurtenances.

Impact wrenches cannot be used in many cases when assembling flanged joints due to the many variations of flange shroud diameters and impact wrench socket dimensions, in combination with nut configurations (heavy or regular hex).

**CAUTION:** U.S. Pipe does not recommend the practice of assembling threaded flanges on pipe in the field.

# FLANGED DI PIPE



2014 EDITION

P 5

## Ductile Iron Flanged Pipe With Threaded Flanges Flange Details

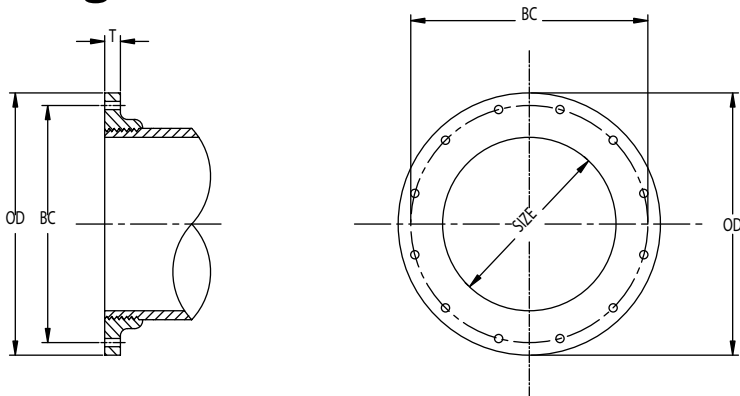

SIZE Inches	DIMENSIONS Inches					
	OD	BC	T	BOLT HOLE Diameter	BOLT Diameter & Length	QTY. OF BOLTS
3	7.50	6.00	.75 ± .12	3/4	5/8 x 2-1/2	4
4	9.00	7.50	.94 ± .12	3/4	5/8 x 3	8
6	11.00	9.50	1.00 ± .12	7/8	3/4 x 3-1/2	8
8	13.50	11.75	1.12 ± .12	7/8	3/4 x 3-1/2	8
10	16.00	14.25	1.19 ± .12	1	7/8 x 4	12
12	19.00	17.00	1.25 ± .12	1	7/8 x 4	12
14	21.00	18.75	1.38 ± .19	1-1/8	1 x 4-1/2	12
16	23.50	21.25	1.44 ± .19	1-1/8	1 x 4-1/2	16
18	25.00	22.75	1.56 ± .19	1-1/4	1-1/8 x 5	16
20	27.50	25.00	1.69 ± .19	1-1/4	1-1/8 x 5	20
24	32.00	29.50	1.88 ± .19	1-3/8	1-1/4 x 5-1/2	20
30	38.75	36.00	2.12 ± .25	1-3/8	1-1/4 x 6-1/2	28
36	46.00	42.75	2.38 ± .25	1-5/8	1-1/2 x 7	32
42	53.00	49.50	2.62 ± .25	1-5/8	1-1/2 x 7-1/2	36
48	59.50	56.00	2.75 ± .25	1-5/8	1-1/2 x 8	44
54	66.25	62.75	3.00 ± .25	2	1-3/4 x 8-1/2	44
60	73.00	69.25	3.12 ± .25	2	1-3/4 x 9	52
64	80.00	76.00	3.38 ± .25	2	1-3/4 x 9	52

**LENGTH TOLERANCE:** Pipe face-to-face dimensions conform to a tolerance of  $\pm .12$ " for sizes 3"-64"

**FLANGES:** The bolt circle and bolt holes of these flanges match those of **ANSI/AWWA C115/A21.15** and Class 125 flanges shown in ANSI B16.1 and can be joined with A21.15 and Class 125 B16.1 flanges. The flanges do not match the Class 250 flanges shown in ANSI B16.1 and cannot be joined with Class 250 B16.1 flanged fittings and valves. For technical information on Class 250 flanges see U.S. Pipe's Class 250 Flanges submittal document at [www.uspipe.com](http://www.uspipe.com).

**FACING:** Class 125 flanges are plain faced without projection and are furnished smooth or with shallow serrations.

**CERTIFICATION:** Complies with **ANSI/AWWA C115/A21.15 Flanged Ductile Iron Pipe**.

Bolts are normally not furnished by U.S. Pipe. Bolt data in the table is provided for information only. Bolts may be provided by U.S. Pipe upon request.

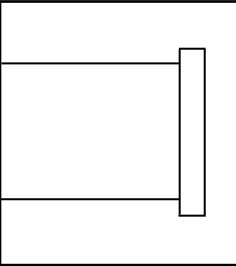

# FLANGED DI PIPE



2014 EDITION

P 7

## Minimum Lengths

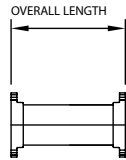

FLANGE - FLANGE

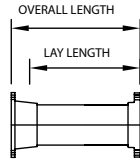

MJ - FLANGE

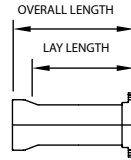

TYTON - FLANGE

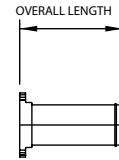

FLANGE - PLAIN END (TR or HP)

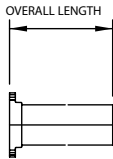

FLANGE - PLAIN END

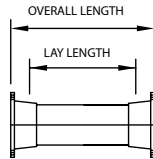

MJ - MJ

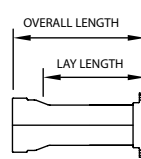

TR FLEX - FLANGE

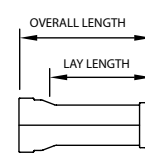

HP LOK - FLANGE

SIZE Inches	FLG - FLG	FLG - PE	MJ - FLG		MJ - MJ		TYTON® - FLG		TR FLEX® - FLG		FLG - PE (TR OR HP)	HP LOK® - FLG	
	O.A.	O.A.	O.A.	L.L.	O.A.	L.L.	O.A.	L.L.	O.A.	L.L.	O.A.	O.A.	L.L.
4	4.25	2.75	6.50	4.00	9.00	4.00	8.50	5.50	10.25	5.50	10.50	X	X
6	4.50	3.00	7.00	4.50	9.50	4.50	9.25	6.25	11.00	5.75	11.50	X	X
8	5.00	3.25	7.50	5.00	10.00	5.00	10.00	6.25	12.00	6.25	12.50	X	X
10	5.50	3.50	7.75	5.25	10.25	5.25	10.00	6.25	12.25	6.25	13.00	X	X
12	5.75	3.75	8.25	5.75	10.75	5.75	10.25	6.50	12.75	6.50	13.75	X	X
14	5.75	3.75	9.75	6.25	13.50	6.50	12.00	7.00	15.00	7.25	15.50	X	X
16	5.75	3.75	10.00	6.50	14.00	7.00	12.00	7.00	15.00	7.00	15.75	X	X
18	6.00	3.75	10.25	6.75	14.50	7.50	12.00	7.00	15.25	7.00	16.50	X	X
20	6.25	4.00	10.75	7.25	15.00	8.00	13.00	7.50	15.75	7.50	17.00	X	X
24	6.75	4.25	11.25	7.75	15.50	8.50	13.50	7.50	16.25	7.50	18.00	X	X
30	8.50	5.00	13.75	9.75	18.75	10.75	14.75	8.25	18.50	8.25	20.75	18.50	10.00
36	9.50	5.50	14.75	10.75	20.00	12.00	16.00	9.00	19.75	9.00	22.50	19.75	11.00
42	10.50	6.00	15.75	11.75	21.00	13.00	18.25	10.25	19.75	10.25	20.25	19.75	10.50
48	10.75	6.25	16.00	12.00	21.00	13.00	18.75	10.25	20.25	12.25	19.00	20.25	10.50
54	12.00	6.75	X	X	X	X	22.25	13.00	21.50	12.75	20.75	21.50	11.50
60	12.50	7.00	X	X	X	X	21.75	11.75	21.75	11.75	22.50	21.75	11.75
64	13.00	7.25	X	X	X	X	23.00	12.50	23.00	12.50	23.25	23.00	13.00

Lengths shown are subject to manufacturing tolerances. If exact lengths are critical, please contact U.S. Pipe Special Projects Department.

Flanges and MJ Bells should normally be specified as "tapped for studs" for minimum pieces in order to be able to assemble the joints.

If shorter lengths are required, please contact U.S. Pipe Customer Service.

All lengths for MJ bells are based on threaded-on MJ bells. Lengths may vary if cast MJ pipe is used.