

CHEM-FEED[®]

Diaphragm Metering Pump



Series C2

1.0	Introduction	4
	1.1 Available Models	4
2.0	Specifications	6
	2.1 Materials of Construction	7
3.0	Features	7
	3.1 Agency Listings	7
4.0	Installation	8
	4.1 Mounting Location	8
	4.2 Dimensions	8
	4.3 Installing Injection Fitting and Strainer	9
5.0	Power Connections	10
	5.1 C2F Wiring Terminal and I/O Schematics	11
	5.2 C2V Wiring Terminal and I/O Schematics	12
6.0	How to Operate CHEM-FEED C2F Control Pad	13
	6.1 Set Remote Start/Stop (C2F)	14
	6.2 Set FVS (Flow Verification System) (C2F)	15
7.0	How to Operate CHEM-FEED C2V Control Pad	17
	7.1 Mode 0 - Mode Descriptions (C2V)	18
	7.2 Mode 0 - Set Remote Start/Stop (C2V)	19
	7.3 Mode 0 - Set DFD Sensitivity (C2V)	20
	7.2 Mode 0 - Set FVS (flow verification system) (C2V)	21
	7.3 Mode 0 - Set 4-20mA Output (C2V PUMP Only)	23
8.0	Mode 1 - Manual Operation	25
	8.1 Mode 1 - Manual Operation Screen Shots	26
9.0	Mode 2 - 4-20mA Input Operation (C2V PUMP Only)	27
	9.1 Mode 2 - 4-20mA Input Screen Shots	28
10.0	Mode 3 - Frequency Input (Hz) Operation (C2V PUMP Only)	29
11.0	Mode 4 - Pulse Batch (low speed pulse) Operation (C2V PUMP Only)	31
	11.1 Mode 4 - Pulse Batch Operation Screen Shots	32
12.0	Alarm Relay	33
13.0	Volumetric Test - Calibration	33
14.0	Pump Maintenance	34
	14.1 Routine Inspection and Maintenance	34
	14.2 Cleaning Pump	34
	14.3 Replacing the Diaphragm	35
15.0	Output Versus Pressure - Flow Curves	36
16.0	DFD (Diaphragm Failure Detection)	37
17.0	Replacement Parts List	38
	17.1 C2 Exploded View	38
	17.2 C2 Parts List	39
18.0	Warranty	42
19.0	Product Matrix	43

PLEASE READ ENTIRE INSTRUCTION MANUAL PRIOR TO INSTALLATION AND USE.



+1 (714) 893 - 8529



sales@blue-white.com



customerservice@blue-white.com



5300 Business Drive
Huntington Beach, CA 92649

1.0 Introduction

Congratulations on purchasing CHEM-FEED® variable speed Diaphragm Metering Pump. A diaphragm pump is a type of positive displacement pump used for pumping a variety of fluids.

Your CHEM-FEED® pump is pre-configured for diaphragm, pump head and fittings that shipped with your metering pump.

Please Note: Your new pump has been pressure tested at the factory with clean water before shipping. You may notice trace amounts of clean water in pump head. This is part of our stringent quality assurance program at Blue-White.

1.1 Available Models

Feed Rate Range at 0 PSig		Max Pressure	CAM Stroke Length and Diaphragm Size
GPH	LPH	PSI(bar)	
.02 - 2.3	.09 - 9.0	150 (10)	.040" (1.02 mm) stroke with Micro-Feed
.04 - 4.0	.15 - 15.0	150 (10)	.060" (1.52 mm) stroke with Micro-Feed
.067 - 6.7	.254 - 25.4	175 (12)	.040" (1.02 mm) stroke with small diaphragm
.10 - 10	.38 - 38	175 (12)	.060" (1.52 mm) stroke with small diaphragm
.165 - 16.5	.625 - 62.5	175 (12)	.060" (1.52 mm) stroke with large diaphragm

- CHEM-FEED® Pumps motor speed is linear over the entire 1% to 100% adjustment range.
- Output versus pressure is nearly linear in all models.
- Feed rates taken in laboratory environment with clean water after 20 minute diaphragm break-in period with a 3 foot (1 meter) suction lift.
- See Section 15 for Flow Curves. Size pump based on flow curves.

2.0 Specifications

Maximum Working Pressure	150 psig (10.4 bar), 175 psig (12 bar) See specific Model
Maximum Fluid Temperature	130 °F (54 °C)
Maximum Ambient Temperature	14 °F to 110 °F (-10 °C to 46 °C)
Maximum Viscosity	1,000 Centipoise
Maximum Suction Lift	15 ft. Water, 0 psig (4.5 m, 0 bar)
Operating Voltage	115VAC/60Hz, 1ph (1.5 Amp Maximum)
	230VAC/60Hz, 1ph (0.7 Amp Maximum)
	220VAC/50Hz, 1ph (1.0 Amp Maximum)
	240VAC/50Hz, 1ph (1.0 Amp Maximum)
	230VAC/50Hz, 1ph (1.0 Amp Maximum)
Power Cord Options	115V60Hz = NEMA 5/15 (USA)
	230V60Hz = NEMA 6/15 (USA)
	220V50Hz = CEE 7/VII (EU)
	240V50Hz = AS 3112 (Australia/New Zealand)
	230V50Hz = BS 1363/A (UK)
Motor	1/8 HP, Brushed DC
Duty Cycle	Continuous
Motor Speed Adjustment Resolution	100:1, (1.0% – 100% motor speed) Max. spm (strokes/min) = 166
Accuracy	+/- 2% of full scale, +/- 0.5% repeatability
Display	Backlit LCD, UV resistant
Keypad	Positive action tactile switch keypad
Approximate Shipping Weight	24 lb. (10.9 Kg)
Enclosure	NEMA 4X (IP66), Polyester powder coated aluminum.
RoHS Compliant	Yes
Standards	cETLus, CE

2.1 Materials of construction

Non-wetted Components:

Enclosure: 413 Aluminum (Polyester powder coated)

Pump Head: PVDF

Cover Screws: 300 Series stainless steel

DFD System Sensor pins: Hastelloy C-276

Power Cord: 3 conductor, SJTW-A water-resistant

Mounting Brackets and Hardware: 316 Stainless steel

Wetted Components:

Pump Head Assembly:

Pump Head: PVDF

Adapter Fittings: PVDF

Valve Cartridges: PVDF

Valve Balls: Ceramic
(optional: PTFE & Hastelloy)

O-Ring Seals: TFE/P (optional EP)

Diaphragm: PVDF, Flex-A-Prene® (optional)

Body & Insert: PVDF

Injection / Back-Flow Check Valve:

Check Ball: Ceramic

Spring: Hastelloy C-276

O-Ring Seals: TFE/P (optional EP)

Body & Adapter: PVDF

Check Ball: Ceramic

Foot Valve / Strainer:

Spring: Hastelloy C-276

O-Ring Seals: TFE/P (optional EP)

Filter Screen: PVDF

Suction Tubing

1/2" connections: Not supplied

1/4" x 3/8" Tube connections:
Clear PVC

Discharge Tubing

1/2" connections: Not supplied

1/4" x 3/8" Tube connections:
Natural Polyethylene (LLDPE)

3.0 Features

Motor driven diaphragm pump offers smooth and quiet chemical dosing.

Full stroke every time avoids vapor lock.

Variable speed DC motor.

Rated for continuous duty (24X7).

Exclusive DIAFLEX® Diaphragm guaranteed to last the life of the pump.

PVDF / PTFE / Ceramic pump head components.

Diaphragm Failure Detection (DFD) system. Senses diaphragm failure by detecting chemical in pump head.

Backlit LCD displays motor speed, input signal values, service and alarm status.

CNC precision machined cam and piston for optimum efficiency, unparalleled accuracy, and linearity.

Heavy duty PVDF pump head and valves are standard.

Compatible with Blue-White's output Flow Verification Sensor (FVS) system.

3.1 Agency Listings



This pump is ETL listed to conform to the following:
UL Standard 778 as a motor operated water pump
CSA Standard C22.2 as process control equipment



This pump complies to the Machinery Directive 98/37/EC, BS EN 60204-1, Low Voltage Directive 73/23/EC BS EN 61010-1, EMC Directive 89/336/EC, BS EN 50081-1/BS EN 50082-1.

Symbol	Explanation
	WARNING, risk of electric shock
	CAUTION, refer to users' guide
	GROUND, PROTECTIVE CONDUCTOR TERMINAL

Enclosure Rating:

NEMA 4X: Constructed for either indoor or outdoor use to provide a degree of protection to personnel against incidental contact with enclosed equipment; to provide a degree of protection against falling dirt, rain, sleet, snow, windblown dust, splashing water, and hose-directed water; and that will be undamaged by external formation of ice on enclosure.

IP66: No ingress of dust; complete protection against contact. Water projected in powerful jets against enclosure from any direction shall have no harmful effects.

4.0 Installation

CAUTION ⚠	Risk of chemical overdose. Be certain pump does not overdose chemical during backwash and periods of no flow in circulation system.
CAUTION ⚠	Always wear protective clothing, face shield, safety glasses and gloves when working on or near your metering pump. Additional precautions should be taken depending on solution being pumped. Refer to MSDS precautions from your solution supplier.
CAUTION ⚠	All diagrams are strictly for guideline purposes only. Always consult an expert before installing metering pump on specialized systems. Metering pump should be serviced by qualified persons only.

4.1 Mounting Location

Choose an area located near chemical supply tank, chemical injection point, and electrical supply. Install pump where it can be easily serviced.

316SS Mounting brackets are included. (Optional Extended brackets available. See below.) Mount pump to a secure surface using enclosed mounting hardware.

Mount pump close to injection point. Keep inlet (suction) and outlet (discharge) tubing as short as possible. Longer discharge tubing increases back pressure at pump head.

Important! Install a back flow prevention check valve at discharge side of pump to prevent system fluid from flowing back through pump during pump maintenance. **Important!**

A pressure relief valve is recommended at discharge of pump.

4.2 Dimensions

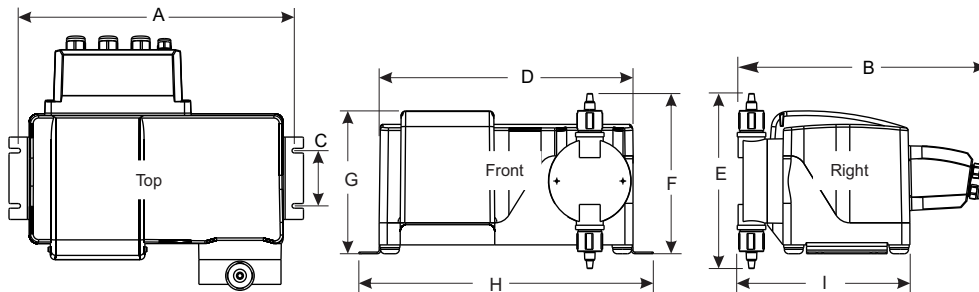

Dim	Inch	cm
A	14.1"	35.8
B	11.5"	29.2
C	2.5"	6.4
D	13.1"	33.2
E	7.9"	20.1
F	7.3"	18.4
G	6.5"	16.4
H	15"	38.0
I	8"	20.3

NOTE: Optional Extended Bracket adds 4.5" (11.43cm) to overall height (dimension F and G).

Optional Extended Brackets

Stainless Steel extended brackets allow pump to be securely mounted to most any surface; floor, shelf, or skid. Brackets lift pump up 4-1/2 inches (11.43 cm), for easy pump access in hard to reach areas.

- Raise metering pump 4-1/2 inches (11.43 cm) off ground or a surface.
- Made out of tough Stainless Steel.
- Provides a stable mounting surface.

Model #	Description
72000-380	Extended Mounting Bracket, 1 Pair, SS, 4 SS Screws





4.3 Installing Injection Fitting and Strainer

CAUTION Proper eye and skin protection must be worn when installing and servicing pump.

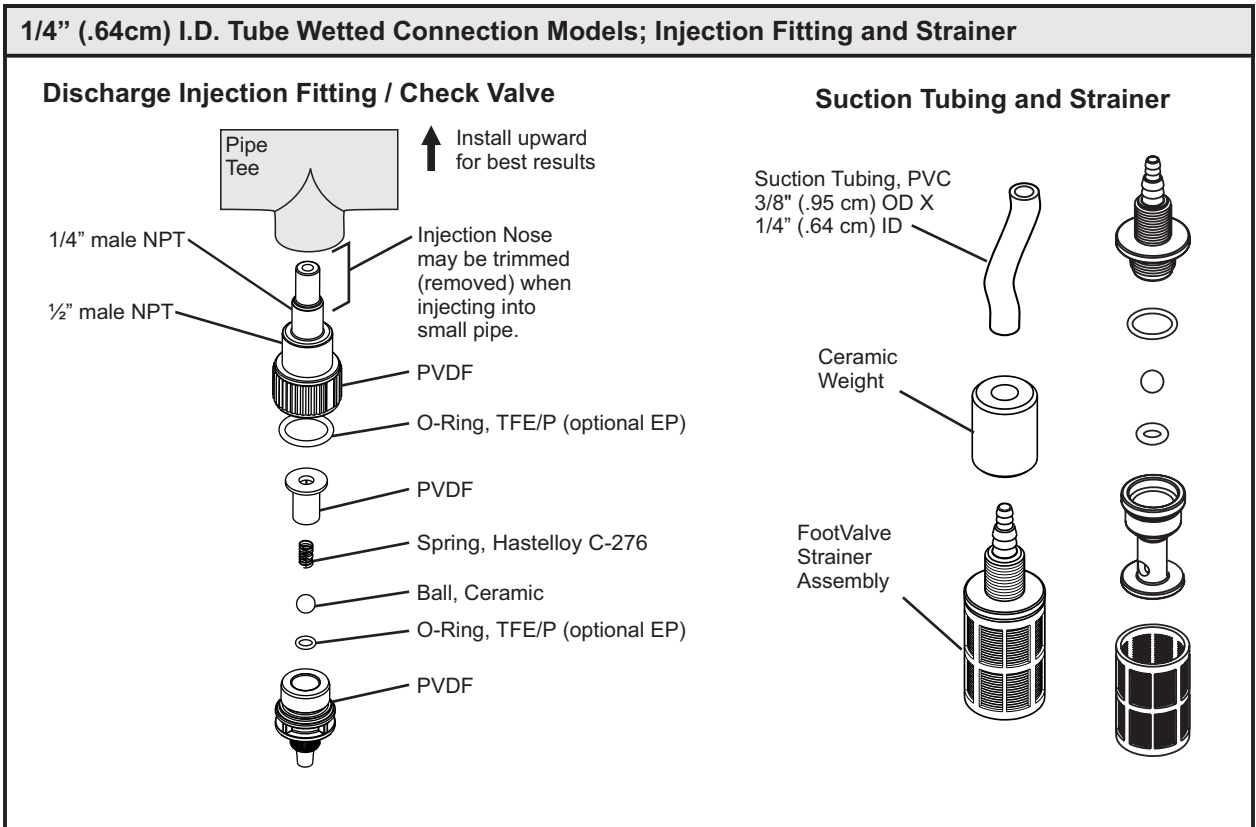
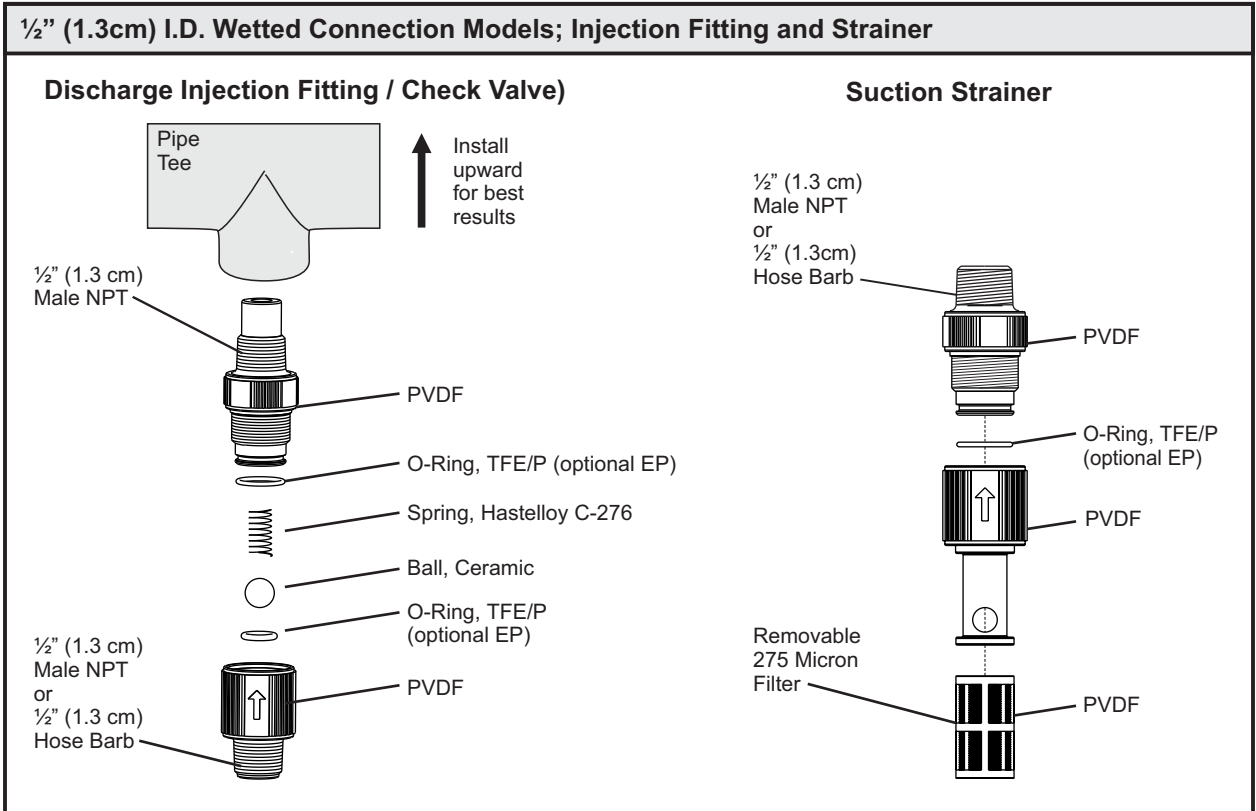
CAUTION This Pump Has Been Evaluated for Use with Water Only.



5.0 Power Connections

WARNING 	Risk of electric shock – cord connected models are supplied with a grounding conductor and grounding-type attachment plug. To reduce risk of electric shock, be certain that it is connected only to a properly grounded, grounding-type receptacle.
WARNING 	Electrical connections and grounding (earthing) must conform to local wiring codes. Be certain that a grounding conductor is connected to terminal T11-1 located in wiring compartment.
WARNING 	Risk of electric shock - Disconnect electricity before removing wiring compartment cover.

Be certain to connect pump to proper supply voltage. Using incorrect voltage will damage pump and may result in injury. Voltage requirement is printed on pump serial label.

Input power: 115VAC 50/60 Hz 1.5 amp or 230/240VAC 50/60 Hz 0.7 amp.

Power switch located in Junction Box.

Use voltage your power cord is rated for.

Cord connected models are supplied with a ground wire conductor and a grounding type attachment plug (power cord). To reduce risk of electric shock, be certain that power cord is connected only to a properly grounded, grounding type receptacle.

Permanently connected models must be properly grounded. Be certain that a grounding conductor is connected to terminal T11-1 located in wiring compartment.

Never strap control (input / output) cables and power cables together.

Power Interruption: This pump has an auto-restart feature which will restore pump to operating state it was in when power was lost.

Note: When in doubt regarding your electrical installation, contact a licensed electrician.

WIRING COMPARTMENT COVER

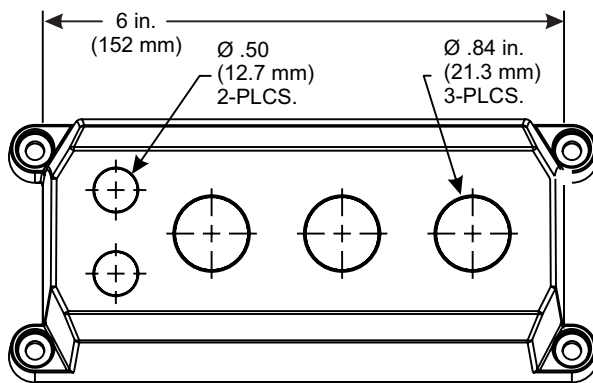

POWER CORD OPTIONS

Four power cord plug types available.
Power cord length is 6 feet (3.83 meters)



115V 60Hz
NEMA 5/15 (USA)
max: 125V AC

230V 60Hz
NEMA 6/15 (USA)
max: 250V AC

240V 50Hz
CEE 7/VII (EU)
max: 250V AC

Included cable and conduit connectors:

QTY.	DESCRIPTION
Qty: 2	.50 Inch (12.7 Mm) Liq-tight Hole Plugs (mat'l = Neoprene), Pre-installed
Qty: 3	.875 Inch (22.2 Mm) Liq-tight Hole Plugs (mat'l = Neoprene), 2 Pre-installed
Qty: 2	.50 Inch (12.7 Mm) Liq-tight Connectors For Pass Thru Cords (mat'l = Nylon) Acceptable Cable Diameter .12 To .26 Inch (3.0 To 6.5 Mm), Not Installed
Qty: 3	.875 Inch (22.2 Mm) Liq-tight Connectors For Pass Thru Cords (mat'l = Nylon) Acceptable Cable Diameter .20 To .40 Inch (5.1 To =10.0 Mm), 1 Pre-installed W/ Power Cord Models
Qty: 2	Metallic Liq-tight Connectors For .50 Inch Flexible Conduit (mat'l = Die Cast Zinc), Not Installed

5.1 C2F Wiring Terminals and I/O Schematics

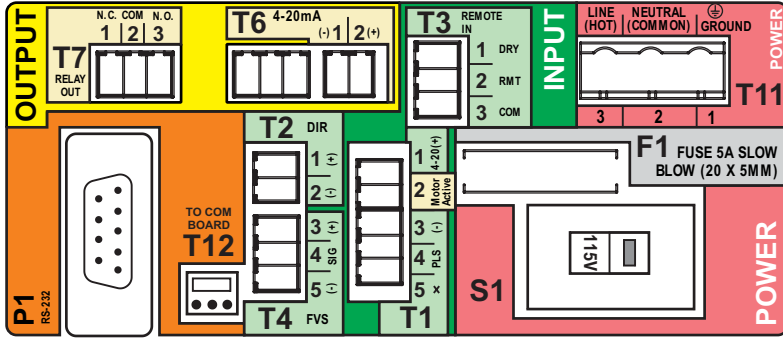

WARNING Risk of electric shock - All wiring must be insulated and rated 300V minimum.

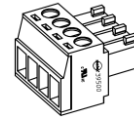

Terminals T1 Thru T8
Plug type
16 - 24 AWG

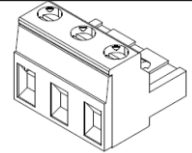

Power Input Terminal T11
Plug type
14 - 30 AWG

FUNCTION	TERM	PIN #	RATING	ELECTRICAL SP.	BLOCK DIAGRAM
INPUT: FVS SYSTEM (FLOW VERIFICATION SENSOR) FV SENSOR ONLY	T4	3	(+) POSITIVE		
	T4	4	SIGNAL		
	T4	5	(-) NEGATIVE		
INPUT: FVS SYSTEM (FLOW VERIFICATION SENSOR) MS6 FLOW METER ONLY	T4	4	SIGNAL		
	T4	5	(-) NEGATIVE		
INPUT: REMOTE START / STOP (DRY CONTACT C.)	T3	1	(+) POSITIVE	NO VOLTAGE	<p>NOTE: USE ONLY DRY CONTACT FOR REMOTE S/S WHEN USING 4-20mA INPUT</p>
	T3	2	(-) NEGATIVE		
INPUT: REMOTE START / STOP (WET CONTACT C.)	T3	2	(+) POSITIVE	6 TO 30 VOLT DC 1 AMP MAX.	
	T3	3	(-) NEGATIVE		
OUTPUT: RELAY, 3 AMP (Triggers with DFD, or FVS, if enabled)	T7	1	NORM. CLOSED	Form C 3 AMP MAX AT 250 VAC, 3 AMP MAX AT 30 VOLT DC	<p>SWITCH LOAD 3 AMP MAX @ 250V AC 3 AMP MAX @ 30V DC</p>
	T7	2	COMMON		
	T7	3	NORM. OPEN		
INPUT: POWER	T11	1	GROUND	115V OR 230V AC MANUAL SWITCH 50 / 60 HZ 100W	
	T11	2	NEUTRAL		
	T11	3	LINE (HOT)		
FUSE	F1	N/A	5 AMP	5A SLOW BLOW (20 X 5MM)	

5.2 C2V Wiring Terminals and I/O Schematics

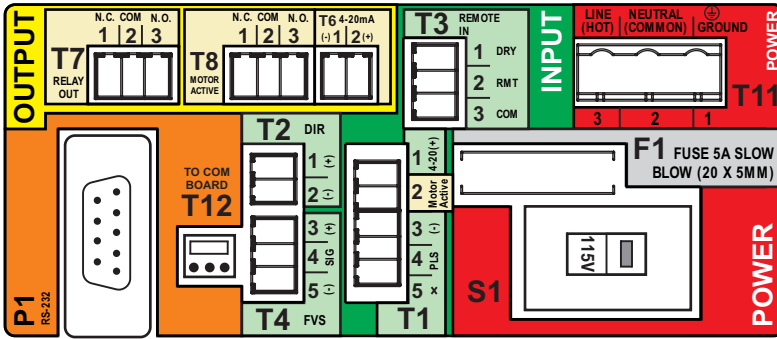

WARNING Risk of electric shock - All wiring must be insulated and rated 300V minimum.

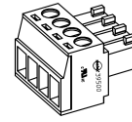

Terminals T1 Thru T8
Plug type
16 - 24 AWG

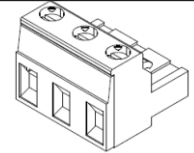

Power Input Terminal T11
Plug type
14 - 30 AWG

Shielded cables should be used on all input signal wires.

FUNCTION	TERM	PIN #	RATING	ELECTRICAL SP.	BLOCK DIAGRAM
INPUT: 4-20 mA	T1	1	(+) POSITIVE	120 OHM IMPEDANCE, NON POWERED LOOP	Single or dual pump (series) input. Loop voltage must be a minimum of 15V, and not exceed 24 Volts. ACTIVE 4-20mA TRANSMITTER SOURCE
	T1	3	(-) NEGATIVE		
INPUT: FREQUENCY, AC SINE WAVE, TTL, CMOS	T1	3	(-) NEGATIVE	0-1000 HZ MAX.	FREQUENCY TRANSMITTER SOURCE
	T1	4	(+) POSITIVE		
INPUT: FVS SYSTEM (FLOW VERIFICATION SENSOR) FV SENSOR ONLY	T4	3	(+) POSITIVE		BLUE-WHITE FVS SENSOR
	T4	4	SIGNAL		
	T4	5	(-) NEGATIVE		
INPUT: FVS SYSTEM (FLOW VERIFICATION SENSOR) MS6 FLOW METER ONLY	T4	4	SIGNAL		BLUE-WHITE MICRO-FLO FLOWMETER PULSE OUTPUT
	T4	5	(-) NEGATIVE		
	T4	5	(-) NEGATIVE		
INPUT: REMOTE START / STOP (DRY CONTACT C.)	T3	1	(+) POSITIVE	NO VOLTAGE	NOTE: USE ONLY DRY CONTACT FOR REMOTE S/S WHEN USING 4-20mA INPUT
	T3	2	(-) NEGATIVE		
INPUT: REMOTE START / STOP (WET CONTACT C.)	T3	2	(+) POSITIVE	6 TO 30 VOLT DC 1 AMP MAX.	EXTERNAL DEVICE 6 TO 30V DC
	T3	3	(-) NEGATIVE		
OUTPUT: 4-20 mA * Option on pumps made prior to 01/01/2023	T6*	2	(+) POSITIVE	120 OHM RESISTANCE ACTIVE LOOP	4-20mA RECEIVER 600 OHM LOAD MAX.
	T6*	1	(-) NEGATIVE		
OUTPUT: RELAY, 3 AMP (Triggers with DFD, or FVS, if enabled)	T7	1	NORM. CLOSED	Form C 3 AMP MAX AT 250 VAC, 3 AMP MAX AT 30 VOLT DC	SWITCH LOAD 3 AMP MAX @ 250V AC 3 AMP MAX @ 30V DC
	T7	2	COMMON		
	T7	3	NORM. OPEN		
OUTPUT: OPEN COLLECTOR MOTOR ACTIVE	T1	2	SIGNAL	5 TO 24 VDC	CLOSED WHILE MOTOR IS ENERGIZED
	T1	3	COMMON		
OUTPUT: MOTOR ACTIVE (CONTACT CLOSURE)	T8*	1	NORM. CLOSED	Form C 1 AMP MAX AT 125 VAC, 0.8 AMP MAX AT 30 VOLT DC	SWITCH LOAD 1 AMP MAX @ 125V AC 0.8 AMP MAX @ 30V DC
	T8*	2	COMMON		
	T8*	3	NORM. OPEN		
INPUT: POWER	T11	1	GROUND	115V OR 230V AC MANUAL SWITCH 50 / 60 HZ 100W	AC VOLTAGE
	T11	2	NEUTRAL		
	T11	3	LINE (HOT)		
FUSE	F1	N/A	5 AMP	5A SLOW BLOW (20 X 5MM)	POWER VOLTAGE SWITCH

Note: T6 & T8 terminals only available in Models with electrical option A "4-20mA output signal"

6.0 How to Operate CHEM-FEED® C2F - Control Pad



Press and release

To prime pump (60 seconds) --See page 27



Press and release

Press UP arrow to increase pump speed (output) in Manual Operation.
To increase value while in programming mode.



Press and release

Press DOWN arrow to decrease pump speed (output) in Manual Operation.
To decrease value while in programming mode.



Press and release

To Stop pump at any time.

Press and release

To Start pump.
To begin listening (reacting) to external signal, such as Remote Start/Stop.



Press and hold

To enter programming mode.

- Remote Start/Stop setup
- FVS (flow verification sensor) setup

Press and release

To save setting while in programming mode.
To move to **next** selection while in programming mode.

Time-out - CHEM-FEED® pumps have a time-out setting of approximately 20 seconds while in configuration menu. If built-in timer exceeds 20 seconds without a button being pressed, then pump will exit configuration menu. Changes will automatically be saved if programming mode is allowed to Time-Out.

6.1 C2F Set Remote Start/Stop

Used to remotely start and stop pump using a dry contact closure signal.
When activated; CLOSE = START and OPEN = STOP.

Set to NO = Remote Start / Stop is disabled

Set to Yes = Remote Start / Stop is enabled

Can be used with external foot pedal, PLC, contact closure or other similar external devices.

Default setting = No (disabled)

Step 1

Press and release STOP button

Note: Cannot enter programming mode while pump is running.



Step 2

Press and hold START | STOP button until 'Remote' icon begins flashing.

Default setting 'NO' will also be visible when entering remote start / stop setup.

Note: If 'YES' had been selected previously, then 'YES' will be displayed on screen.

Remote Icon



Step 3

Press and release DOWN arrow to change setting to 'YES.'

To change setting back to 'NO' press and release UP arrow.



Step 4

After you've made your selection, press and release START | STOP button. This saves your setting.

You can now modify FVS setting (see next page) or you can exit Setup by pressing and holding START | STOP button for a few seconds until you return to Run screen.



STANDBY - Waiting for Remote Signal

Runtime Screen Shot - Standby

Displays 'Stand-By' status with Remote start/stop enabled and waiting for signal to start.

Caution, pump can start up at anytime in this condition.
Press STOP button before performing maintenance.

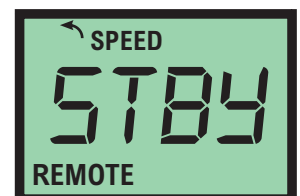

6.2 C2F - How to Set FVS (Flow Verification System)

Flow verification sensor sold separately.

Flow verification system is designed to stop pump in an event sensor does not detect flow during pump operation. Indicating an empty chemical tank, clogged injection fitting, loose tubing connection, etc.

To allow pump to clear any gasses that may have accumulated over time, an alarm delay time value from 1 to 255 seconds must be programmed.

Note: An alarm delay of 000 seconds disables FVS system.

Step 1

Press and release STOP button

Note: Cannot enter programming mode while pump is in running.



Step 2

Press and hold START | STOP button until 'Remote' icon begins flashing.

This indicates that you've entered Setup menu.

Remote
Icon



Step 3

Press and release START | STOP button to scroll through menu until you see FVS icon.

If you pass FVS screen, continue to press and release START | STOP button until FVS icon appears.



Step 4

FVS icon will appear for 1 second, followed by numbers.

These numbers indicate delay time setting for FVS.

Select a delay time in seconds. Delay time is amount of time pump will wait to receive a pulse from sensor until an alarm is triggered.

A delay time of 00 deactivates FVS feature.



Step 5

After you've made your selection, press and release START | STOP button. This saves your setting.

Press and hold START | STOP button to exit Setup menu and return to runtime screen.



Time-out - Chem-Pro pumps have a time-out setting of 20 seconds while in configuration menus. If built-in timer exceeds 20 seconds without a button being pressed, then pump will exit configuration menu. Changes will only be saved after RIGHT arrow button is pressed and released.

6.2 C2F - How to Set FVS (Flow Verification System) - Cont.

Flow Verification Sensors are designed to give you installation options.

MS6 Flow Sensor or Micro-Flo can be used with FVS System.

Sensor can be installed:

- Directly onto pump head of CHEM-FEED® pump, discharge side (MicroFlo only)
- discharge side of CHEM-FEED® pump, as directed by Micro-Flo and MS6 manuals.

Wiring for sensor can be connected directly to a CHEM-FEED® pump. Pump will stop pumping if sensor detects no flow. A relay will then close allowing for remote alarm indication or initiation of a back-up pump.

When installing MicroFlo directly onto pump 3/8" tube discharge fitting:

MixroFlo Sensor includes a PVC tubing insert, located inside sensors female thread connection, that is designed to seal sensor onto pump tube adapter. Thread sensor onto pump tube until tubing insert is snug against pump tube fitting - do not over-tighten.

Sensor Model Number	Published Flow Range	Actual Working Range with CHEM-FEED® Pump
	ML/Min	ML/Min
FV-100	30-300	30-200
FV-200	100-1000	50-900
FV-300	200-2000	100-1800
FV-400	300-3000	300-3000
FV-500	500-5000	500-5000
FV-600	700-7000	700-7000
MS61	10-5000	10-5000
MS62	50-10000	50-10000

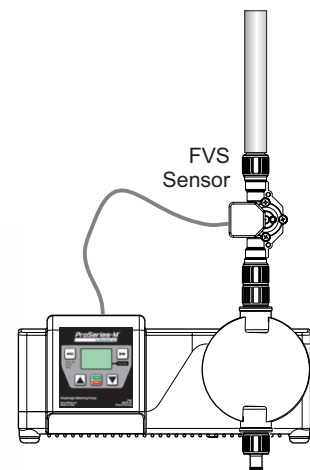
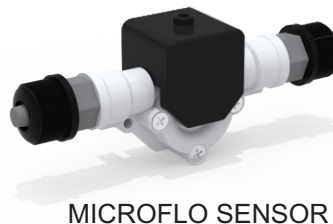

Confirm FVS flow range - Flow Verification Sensor (FVS) will only function within its operating range. See chart for available ranges.

NOTE: If pump output is less than minimum range, sensor will not detect chemical and a signal will not be sent to pump, resulting in an alarm condition.

NOTE: For low viscosity (water-like) fluids only. Consult factory if attempting to use with viscous fluids.

7.0 How to Operate CHEM-FEED® C2V - Control Pad

 **MODE**

Press and release
To select Run Mode
Mode 1: Manual
Mode 2: 4-20mA input
Mode 3: Frequency input
Mode 4: Pulse / Batch

Press and Hold
To configure selected Mode
Mode 0: Setup
Mode 1: Manual
Mode 2: 4-20mA input
Mode 3: Frequency input
Mode 4: Pulse / Batch

* MODE button only on "V" Model



Press and release
To prime pump (60 seconds) --See page 27



Press and release
Press UP arrow to increase pump speed (output) in Manual Operation.
To increase value while in programming mode.



Press and release
To Stop pump at any time.

Press and release
To Start pump.
To begin listening (reacting) to external signal, such as Remote Start/Stop.





Press and release
Press DOWN arrow to decrease pump speed (output) in Manual Operation.
To decrease value while in programming mode.



Press and hold
To enter programming mode.
• Remote Start/Stop setup
• FVS (flow verification sensor) setup

Press and release
To save setting while in programming mode.
To move to **next** selection while in programming mode.

Time-out - CHEM-FEED® pumps have a time-out setting of approximately 20 seconds while in configuration menu. If built-in timer exceeds 20 seconds without a button being pressed, then pump will exit configuration menu. Changes will automatically be saved if programming mode is allowed to Time-Out.

7.1 Mode Descriptions - C2V only

Mode 0 - Setup

Press and Hold to configure:

- Remote Start / Stop
- DFD (Diaphragm Failure Detection) sensitivity
- FVS (Flow Verification Sensor) time delay - requires sensor
- 4-20 mA output, available on certain models

Mode 0



Mode 1 - Manual

Run pump locally by selecting pump speed (1 - 100%).

- Control speed by using up or down arrows after start button is pressed.
- Control speed by entering Mode 1 setup and selecting desired pump speed (1 - 100%)

Mode 1



Mode 2 - 4-20 mA Input Signal

Run pump remotely via external 4-20 mA signal.

- Press and Hold "MODE" button with Mode 2 selected to configure settings.
- Select Mode 2 and press START button to allow pump to be controlled by external 4-20mA signal.

Mode 2

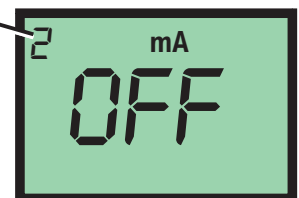

Mode 3 - Frequency (Hz) Input Signal

Run pump remotely via external high frequency (Hz) signal.

- Press and Hold "MODE" button with Mode 3 selected to configure settings.
- Select Mode 3 and press START button to allow pump to be controlled by external frequency (Hz) signal.

Mode 3



Mode 4 - Pulse Batch Input Signal (low speed pulse)

Run pump remotely via external low speed pulse signal.

- Press and Hold "MODE" button with Mode 4 selected to configure settings.
- Select Mode 4 and press START button to allow pump to be controlled by external low speed pulse signal.

Mode 4

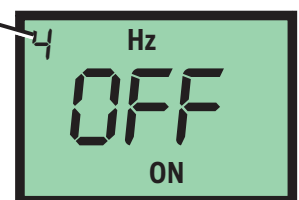

7.2 Mode 0 - Set Remote Start / Stop - C2V

Used to remotely start and stop pump using a dry contact closure signal.
When activated; CLOSE = START and OPEN = STOP.

Set to NO = Remote Start / Stop is disabled
Set to Yes = Remote Start / Stop is enabled

Can be used with external foot pedal, PLC, contact closure or other similar external devices.

Default setting = No (disabled)

Step 1

Ensure pump is stopped and LCD reads "OFF."

Note: Mode cannot be changed while pump is in running.

Press and release STOP button if pump is running.

Press and release MODE button multiple times until Mode 0 is selected.

Mode 0



Step 2

With Mode 0 selected, press and hold MODE button until 'Remote' icon begins flashing.

Default setting 'NO' will also be visible when entering remote start / stop setup.

Note: If 'YES' had been selected previously, then 'YES' will be displayed on screen.

Mode 0

Remote Icon



Step 3

Press and release DOWN arrow to change setting to 'YES.'

To change setting back to 'NO' press and release UP arrow.

Mode 0



Step 4

After you've made your selection, press and release MODE button. This saves your setting.

You can now modify other settings in Mode 0 or you can exit Setup by pressing and holding MODE button for a few seconds until you return to Run screen.

Mode 0



Running pump with Remote Start / Stop enabled, 'REMOTE' icon will always be visible on lower left side of screen. Pump will display 'STBY' (standby) if pump is in stop mode via contact closure signal. **Please use caution in this mode, pump can start at anytime. If you must perform maintenance to pump, press and release STOP button.**

7.3 Mode 0 - Set DFD Sensitivity - C2V

CHEM-FEED pump is equipped with a Diaphragm Failure Detection (DFD) system which is designed to stop pump in event diaphragm should rupture and chemical enters pump head. This system is capable of detection presence of a large number of chemicals including Sodium Hypochlorite (chlorine), Hydrochloric (muriatic) Acid, Sodium Hydroxide, and many others.

Minimum and Maximum setting = 75 % to 100%

Default Setting = 75% (75% is recommended; triggers with most water treatment chemicals without false alarms)

Important: 100% sensitivity setting may trigger false alarm by washdown or rain. 100% setting is only recommended when absolutely necessary.

Step 1

Ensure pump is stopped and LCD reads "OFF."

Note: Mode cannot be changed while pump is in running.

Press and release STOP button if pump is running.

Press and release MODE button multiple times until Mode 0 is selected.

Mode 0



Step 2

With Mode 0 selected, press and hold MODE button until 'Remote' icon begins flashing.

This indicates that you've entered Setup menu.

Mode 0

Remote
Icon



Step 3

Press and release MODE button to scroll through menu until you see DFD icon.

If you pass DFD screen, continue to press and release MODE button until DFD icon appears.

Mode 0



Step 4

DFD icon will appear for 1 second, followed by numbers.

Numbers indicate sensitivity value of DFD.

Press and release UP arrow button to increase sensitivity value.

Press and release DOWN arrow button to decrease sensitivity value.

Mode 0



Step 5

After you've made your selection, press and release MODE button. This saves your setting.

You can now modify other settings in Mode 0 or you can exit Setup by; press and hold MODE button for a few seconds until you return to Run screen.

Mode 0



7.4 Mode 0 - Set FVS (flow verification system) - C2V

Flow verification sensor sold separately.

Flow verification system is designed to stop pump in an event sensor does not detect flow during pump operation. Indicating an empty chemical tank, clogged injection fitting, loose tubing connection, etc.

To allow pump to clear any gasses that may have accumulated over time, an alarm delay time value from 1 to 255 seconds must be programmed.

Note: An alarm delay of 000 seconds disables FVS system.

Step 1

Ensure pump is stopped and LCD reads "OFF."

Note: Mode cannot be changed while pump is in running.

Press and release STOP button if pump is running.

Press and release MODE button multiple times until Mode 0 is selected.

Mode 0



Step 2

With Mode 0 selected, press and hold MODE button until 'Remote' icon begins flashing.

This indicates that you've entered Setup menu.

Mode 0

Remote
Icon



Step 3

Press and release MODE button to scroll through menu until you see FVS icon.

If you pass FVS screen, continue to press and release MODE button until FVS icon appears.

Mode 0



Step 4

FVS icon will appear for 1 second, followed by numbers.

These numbers indicate delay time setting for FVS.

Select a delay time in seconds. Delay time is amount of time pump will wait to receive a pulse from sensor until an alarm it triggered.

A delay time of 00 deactivates FVS feature.

Mode 0



Step 5

After you've made your selection, press and release MODE button. This saves your setting.

You can now modify other settings in Mode 0 or you can exit Setup by; press and hold MODE button for a few seconds until you return to Run screen.

Mode 0



Time-out - CHEM-FEED® pumps have a time-out setting of approximately 20 seconds while in configuration menu. If built-in timer exceeds 20 seconds without a button being pressed, then pump will exit configuration menu. Changes will automatically be saved if programming mode is allowed to Time-Out.

7.4 Mode 0 - Set FVS (flow verification system) - Continued

Flow Verification Sensors are designed to give you installation options.

MS6 Flow Sensor or Micro-Flo can be used with FVS System.

Sensor can be installed:

- Directly onto pump head of CHEM-FEED® pump, discharge side (MicroFlo only)
- discharge side of CHEM-FEED® pump, as directed by Micro-Flo and MS6 manuals.

Wiring for sensor can be connected directly to a CHEM-FEED® pump. Pump will stop pumping if sensor detects no flow. A relay will then close allowing for remote alarm indication or initiation of a back-up pump.

When installing MicroFlo directly onto pump 3/8" tube discharge fitting:

MixroFlo Sensor includes a PVC tubing insert, located inside sensors female thread connection, that is designed to seal sensor onto pump tube adapter. Thread sensor onto pump tube until tubing insert is snug against pump tube fitting - do not over-tighten.

Sensor Model Number	Published Flow Range	Actual Working Range with CHEM-FEED® Pump
	ML/Min	ML/Min
FV-100	30-300	30-200
FV-200	100-1000	50-900
FV-300	200-2000	100-1800
FV-400	300-3000	300-3000
FV-500	500-5000	500-5000
FV-600	700-7000	700-7000
S6A1	10-5000	10-5000
S6A2	50-10000	50-10000

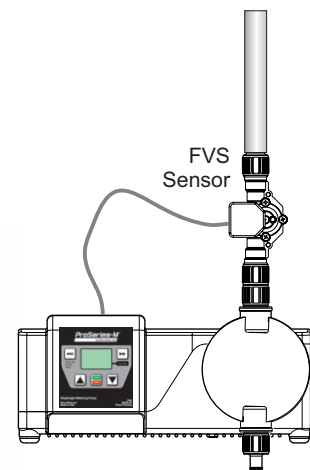
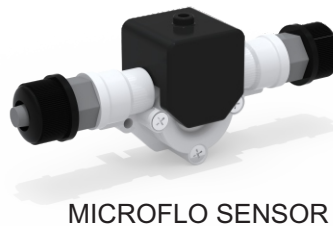

Confirm FVS flow range - Flow Verification Sensor (FVS) will only function within its operating range. See chart for available ranges.

NOTE: If pump output is less than minimum range, sensor will not detect chemical and a signal will not be sent to pump, resulting in an alarm condition.

NOTE: For low viscosity (water-like) fluids only. Consult factory if attempting to use with viscous fluids.

7.5 Mode 0 - Set 4-20mA Output - C2V only

Available on certain models.

Sends a configurable 4-20 mA signal, based on pump rotor speed, to an external device. This feature can be used to control other pumps (in sync / proportionally), data logging systems, and other external devices for plant automation.

Default setting: Minimum Speed = 4 mA signal output
Maximum Speed = 20 mA signal output

Set to NO = disabled

Set to Yes = enabled

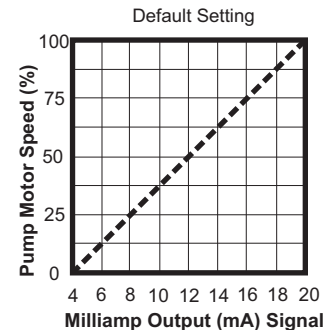

Step 1

Ensure pump is stopped and LCD reads "OFF."

Note: Mode cannot be changed while pump is in running.

Press and release STOP button if pump is running.

Press and release MODE button multiple times until Mode 0 is selected.

Mode 0



Step 2

With Mode 0 selected, press and hold MODE button until 'Remote' icon begins flashing.

This indicates that you've entered Setup menu.

Mode 0

Remote Icon



Step 3

Press and release MODE button to scroll through menu until you see 4-20 mA icon.

To select Yes, press and release DOWN arrow.

To select No, press and release UP arrow.

To begin configuring values, select Yes.

Then press and release MODE button.

Mode 0

4-20 mA Icon

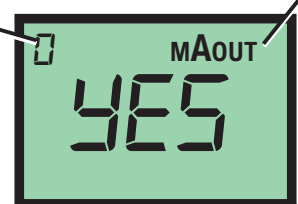

Only available on certain models

Step 4

Minimum pump speed will be displayed.

To increase value, press and release UP arrow.

To decrease value, press and release DOWN arrow.

To save value, press and release MODE button.

Mode 0

4-20 mA Icon

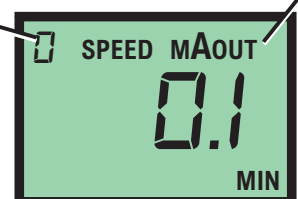

Time-out - CHEM-FEED® pumps have a time-out setting of approximately 20 seconds while in configuration menu. If built-in timer exceeds 20 seconds without a button being pressed, then pump will exit configuration menu. Changes will automatically be saved if programming mode is allowed to Time-Out.

7.5 Mode 0 - Set 4-20mA Output - Continued

Step 5

Output signal at minimum speed will now be displayed.
 To increase value, press and release UP arrow.
 To decrease value, press and release DOWN arrow.
 To save value, press and release MODE button.

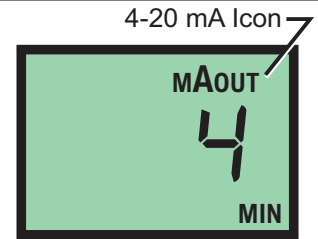

Step 6

Maximum pump speed will be displayed.
 To increase value, press and release UP arrow.
 To decrease value, press and release DOWN arrow.
 To save value, press and release MODE button.

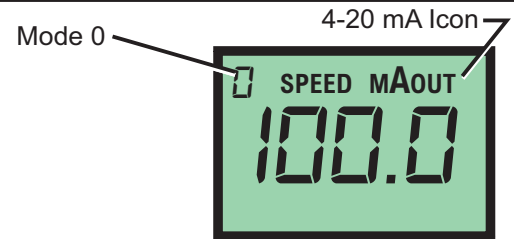

Step 7

Output signal at maximum speed will now be displayed.
 To increase value, press and release UP arrow.
 To decrease value, press and release DOWN arrow.
 To save value, press and release MODE button.

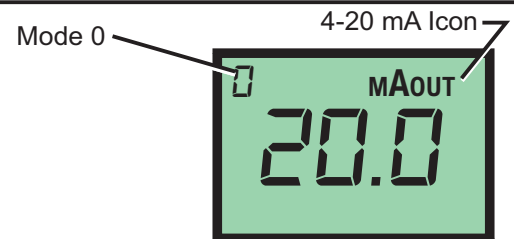

Step 8

You can now modify other settings in Mode 0 or you can exit Setup by; press and hold MODE button for a few seconds until you return to Run screen.

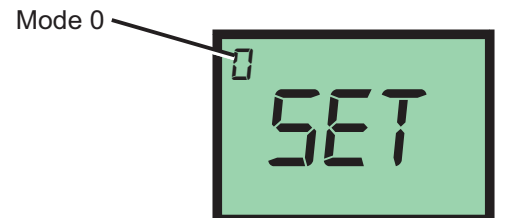

Example 1

0% Pump Output = 4 mA
 100 % Pump Output = 20 mA

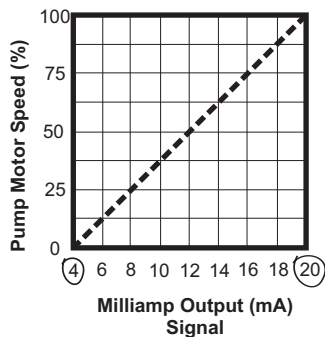

Example 2

0% Pump Output = 4 mA
 50% Pump Output = 16 mA

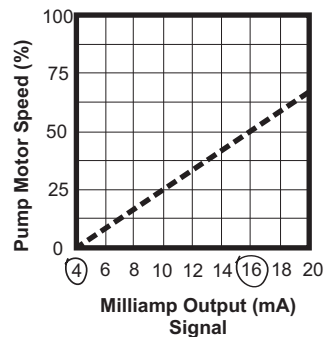

8.0 Mode 1 - Manual Operation - C2V

Used to manually control speed of pump.

Use UP and DOWN arrows to adjust speed while pump is running.

To select exact run speed, follow steps below.

Step 1

Ensure pump is stopped and LCD reads "OFF."

Note: Mode cannot be changed while pump is in running.

Press and release STOP button if pump is running.

Press and release MODE button multiple times until Mode 1 is selected.

Mode 1



Step 2

With Mode 1 selected, press and hold MODE button until 'Speed' icon begins flashing.

This indicates that you've entered Setup menu.

Mode 1



Step 3

Current pump speed will be displayed.

To increase value, press and release UP arrow.

To decrease value, press and release DOWN arrow.

To save value, press and hold MODE button until 'Speed' icon stop flashing.

Mode 1



Step 4

Pump will now operate at your pre-configured speed.

Press and release START button to start pump.

Press and release STOP button at anytime to stop pump.

Mode 1



With pump operating in manual mode (Mode 1), pump speed can be changed at anytime by using UP or DOWN arrows during operation.

8.1 Mode 1 - Manual Operation Screen Shots

Runtime Screen Shot 1

Display motor speed percentage.
Pump Running in Manual Operation



Runtime Screen Shot 2

Display 4-20mA output (select models only)
Press and release MODE button to view mA output value
in real-time.

Please note: 4-20mA output is only available on select models. If included in
your model; 4-20mA output must be enabled in Mode 0 (see page 16).

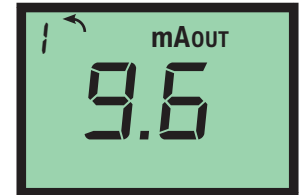

Runtime Screen Shot 3

Display motor speed percentage.
Press and release MODE button to view percentage of
motor speed.

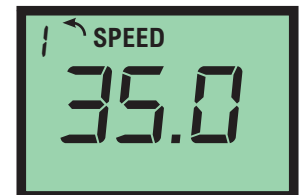

9.0 Mode 2 - 4-20mA Input Operation - C2V

Used to remotely control pump with an incoming 4-20 mA signal.

Default setting: 4 mA signal = 0.1% motor speed
20 mA signal = 100.0% motor speed

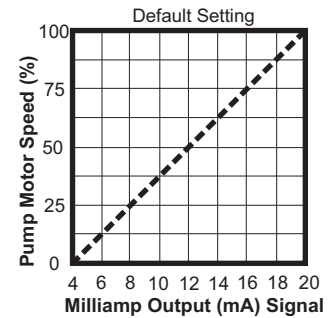

Step 1

Ensure pump is stopped and LCD reads "OFF."

Note: Mode cannot be changed while pump is in running.

Press and release STOP button if pump is running.

Press and release MODE button multiple times until Mode 2 is selected.

Mode 2

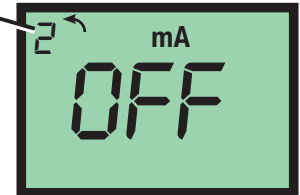

Step 2

With Mode 2 selected, press and hold MODE button until 'Speed' icon begins flashing.

This indicates that you've entered Setup menu.

Mode 2

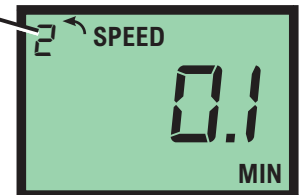

Step 3

Minimum pump speed will be displayed.

To increase value, press and release UP arrow.

To decrease value, press and release DOWN arrow.

To save value, press and release MODE button.

Mode 2

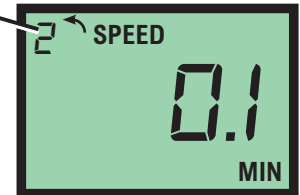

Step 4

mA value linked to minimum pump speed will be displayed.

To increase value, press and release UP arrow.

To decrease value, press and release DOWN arrow.

To save value, press and release MODE button.

Mode 2

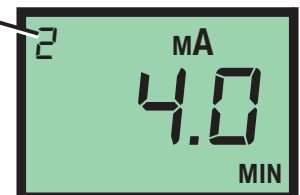

Step 5

Maximum pump speed will be displayed.

To increase value, press and release UP arrow.

To decrease value, press and release DOWN arrow.

To save value, press and release MODE button.

Mode 2



Time-out - CHEM-FEED® pumps have a time-out setting of approximately 20 seconds while in configuration menu. If built-in timer exceeds 20 seconds without a button being pressed, then pump will exit configuration menu. Changes will automatically be saved if programming mode is allowed to Time-Out.

9.0 Mode 2 - 4-20mA Input Operation - Continued

Step 6

mA value linked to minimum pump speed will now be displayed.
 To increase value, press and release UP arrow.
 To decrease value, press and release DOWN arrow.
 To save value, press and release MODE button.

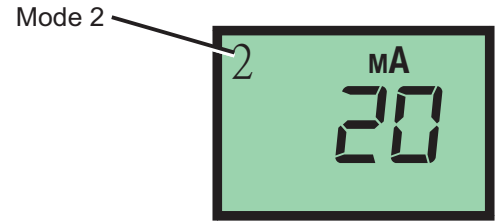

Step 7

To exit Setup, press and hold MODE button for a few seconds until you return to Run screen.

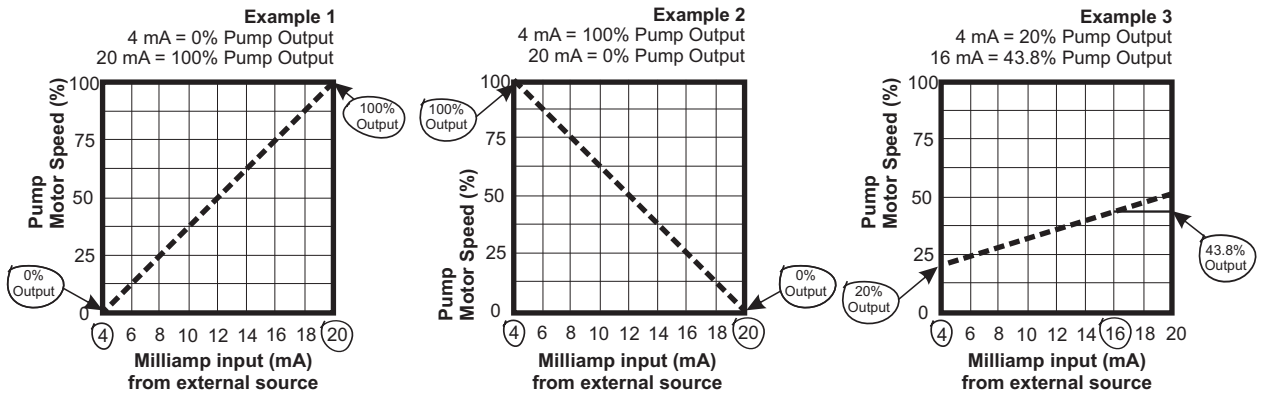
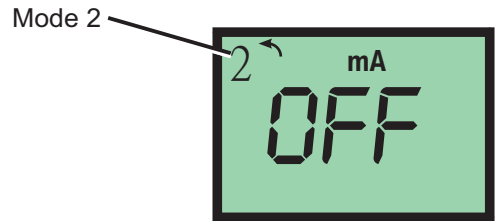

9.1 Mode 2 - 4-20mA Input Screen Shots

Runtime Screen Shot 1

Display **motor speed percentage**.
 Pump Running in 4-20mA Input Operation

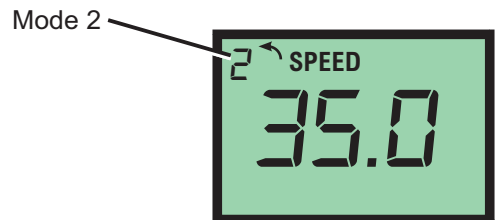

Runtime Screen Shot 2

Display current 4-20mA input signal
 Press and release MODE button to view **mA input** value in real-time.

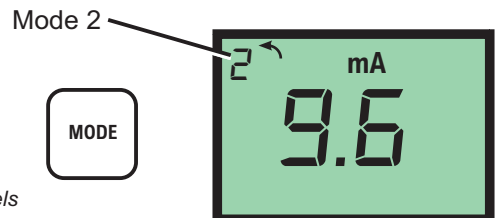

Only available on certain models

Runtime Screen Shot 3

Press and release MODE button again to view **mA output** value in real-time (available on select models only).
 Press and release MODE button again to view **motor speed percentage**, as in Screen Shot 1.

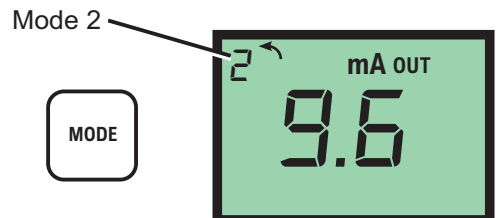

10.0 Mode 3 - Frequency Input (Hz) Operation - C2V

Used to remotely control pump with an incoming high speed frequency signal. Typically used with flow meters or other external devices.

Default setting: 0 Frequency (Hz) = 0% motor speed
1000 Frequency (Hz) = 100% motor speed

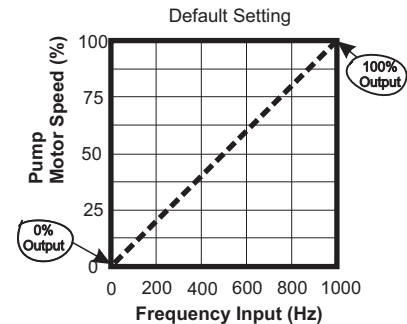

Step 1

Ensure pump is stopped and LCD reads "OFF."

Note: Mode cannot be changed while pump is in running.

Press and release STOP button if pump is running.

Press and release MODE button multiple times until Mode 3 is selected.

Mode 3



Step 2

With Mode 3 selected, press and hold MODE button until 'Speed' icon begins flashing.

This indicates that you've entered Setup menu.

Mode 3

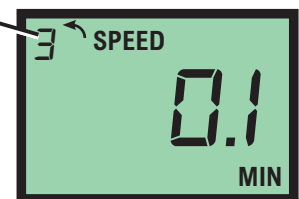

Step 3

Pump speed at minimum Frequency will be displayed.

To increase value, press and release UP arrow.

To decrease value, press and release DOWN arrow.

To save value, press and release MODE button.

Mode 3

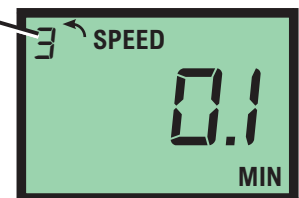

Step 4

Minimum Frequency (Hz) value will be displayed.

To increase value, press and release UP arrow.

To decrease value, press and release DOWN arrow.

To save value, press and release MODE button.

Mode 3

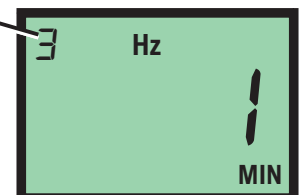

Time-out - CHEM-FEED® pumps have a time-out setting of approximately 20 seconds while in configuration menu. If built-in timer exceeds 20 seconds without a button being pressed, then pump will exit configuration menu. Changes will automatically be saved if programming mode is allowed to Time-Out.

10.0 Mode 3 - Frequency Input (Hz) Operation - Continued

Step 5

Pump speed at maximum Frequency will be displayed.
 To increase value, press and release UP arrow.
 To decrease value, press and release DOWN arrow.
 To save value, press and release MODE button.

Mode 3

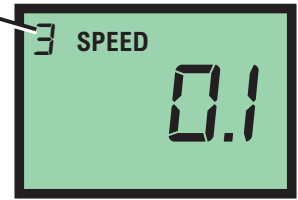

Step 6

Maximum Frequency value will now be displayed.
 To increase value, press and release UP arrow.
 To decrease value, press and release DOWN arrow.
 To save value, press and release MODE button.

Mode 3



Step 7

To exit Setup, press and hold MODE button for a few seconds until you return to Run screen.

Mode 3



Examples:

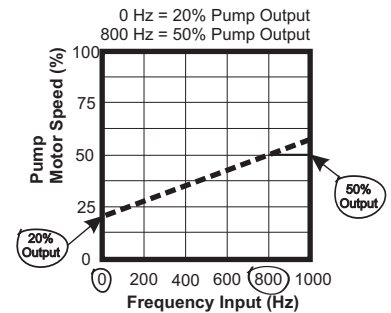
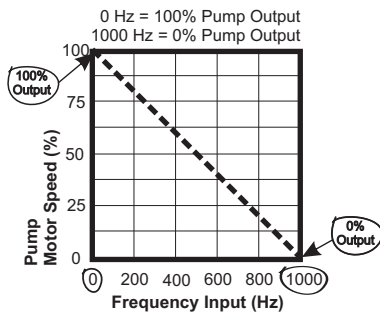
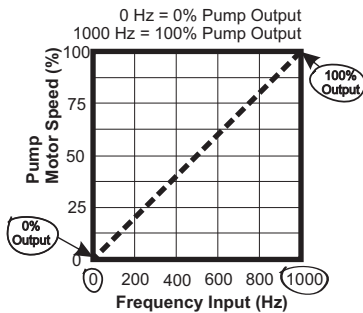

Example #1, Ultrasonic flow meter

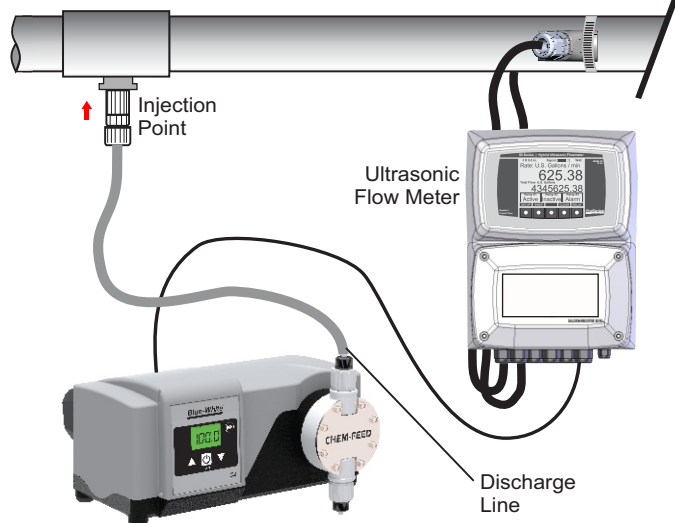

Example #2, Paddlewheel flow meter

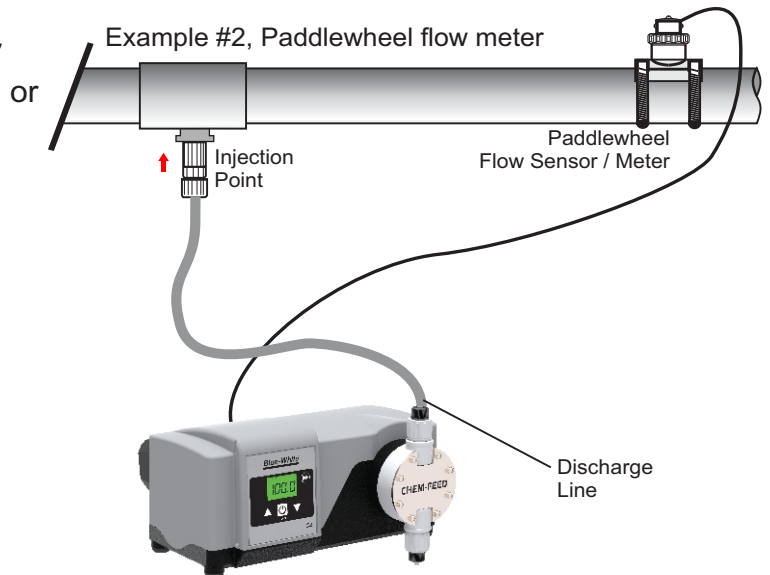

11.0 Mode 4 - Pulse Batch (low speed pulse) Operation - C2V

Used to remotely control pump with an incoming pulse signal. Can be used with an external foot pedal, a water meter, a PLC, contact closure, or other low speed pulse devices.

Default setting: 1 Pulse = 100% motor speed for 2.5 seconds

Step 1

Ensure pump is stopped and LCD reads "OFF."

Note: Mode cannot be changed while pump is in running.

Press and release STOP button if pump is running.

Press and release MODE button multiple times until Mode 4 is selected.

Mode 4

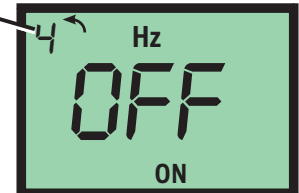

Step 2

With Mode 4 selected, press and hold MODE button until 'On' icon begins flashing.

This indicates that you've entered Setup menu.

Mode 4



Step 3

Pump on-time will be displayed in either MIN (minutes) or SEC (seconds).

To increase value, press and release UP arrow.

To decrease value, press and release DOWN arrow.

To save value, press and release MODE button.

Mode 4



Step 4

MIN (minutes) or SEC (seconds) will be displayed in lower right hand corner. This value will be linked to Pump on-time number in previous screen.

To change this setting, press and release either UP arrow or DOWN arrow.

To save value, press and release MODE button.

Mode 4

MIN or SEC

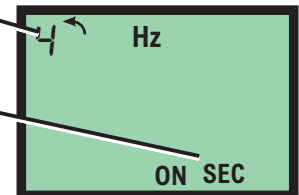

Time-out - CHEM-FEED® pumps have a time-out setting of approximately 20 seconds while in configuration menu. If built-in timer exceeds 20 seconds without a button being pressed, then pump will exit configuration menu. Changes will automatically be saved if programming mode is allowed to Time-Out.

11.0 Mode 4 - Pulse Batch (low speed pulse) Operation - Continued

Step 5

Number of pulses to trigger pump start will be displayed.
 To increase value, press and release UP arrow.
 To decrease value, press and release DOWN arrow.
 To save value, press and release MODE button.

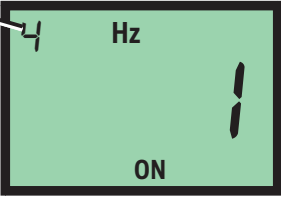

Step 6

Pump speed during on-time will now be displayed.
 Pump will run at this speed after selected number of pulses is reached from previous menu.
 To increase value, press and release UP arrow.
 To decrease value, press and release DOWN arrow.
 To save value, press and release MODE button.



Step 7

To exit Setup, press and hold MODE button for a few seconds until you return to Run screen.

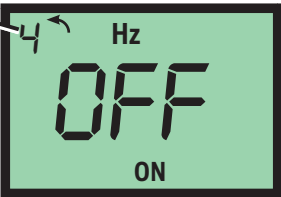

11.1 Mode 4 - Pulse Batch Operation Screen Shots

Runtime Screen Shot 1

Display **motor speed percentage**.
 Pump Running in Pulse Batch Operation



Runtime Screen Shot 2

Display current number of pulses received
 Press and release MODE button to view number of **pulses received** in real-time.

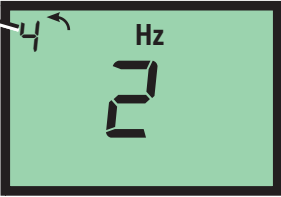
Runtime Screen Shot 3

Press and release MODE button again to view **mA output** value in real-time (available on select models only).
 Press and release MODE button again to view **motor speed percentage**, as in Screen Shot 1.

Only available on certain models

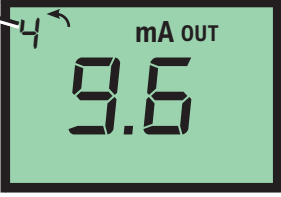
12.0 Alarm Relay

Pump has a built in 3 amp alarm output relay. Relay is pre-configured to energize on diaphragm failure detection (DFD) and on Flow Verification Sensor (FVS).

A Flow Verification Sensor must be installed and configured for relay to trigger on no-flow conditions. See page 9 for wiring details.

13.0 Volumetric Test - Calibration

This volumetric test will take into account individual installation factors such as line pressure, fluid viscosity, suction lift, etc. This test is most accurate for measuring injector's output in an individual installation.

1. Be sure Injection Fitting and Footvalve / Strainer are clean and working properly.
2. Fill a large graduated cylinder with solution to be injected.
3. With pump installed under normal operating conditions, place suction tubing with Footvalve / Strainer installed in graduated cylinder.
4. Run pump until all air is removed from suction line and solution enters discharge tubing.
5. Remove suction tubing from graduated cylinder and refill graduated cylinder if necessary. Note amount of solution in graduated cylinder.
6. Place suction tubing with Footvalve / Strainer installed back into graduated cylinder.
7. Run injector for a measured amount of time. A longer testing time will produce more accurate results.
8. Remove suction tubing from graduated cylinder. Measure amount of chemical injected.

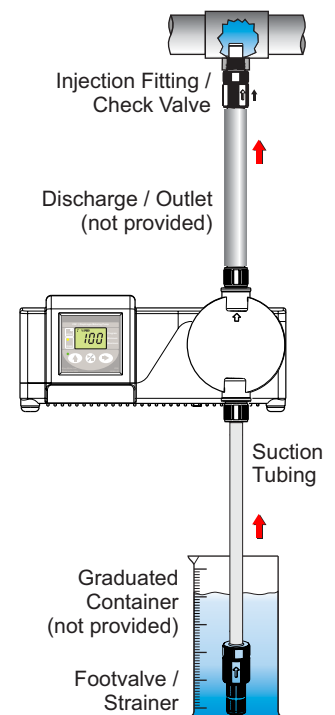

Example:

During your 1 minute calibration period, say CHEM-FEED pumped 1000 Milliliters in 1 minute.

$$1 \text{ US Gallon} = 3.785 \text{ Liters} = 3785 \text{ Milliliters}$$



$$\left(\frac{1000 \text{ ML/Min}}{3785} \right) 60 = 15.85 \text{ GPH (US gallons per hour)}$$

Minutes per hour

Milliliters in a US gallon

Note: All diagrams are strictly for guideline purposes only. Always consult an expert before installing pump into specialized systems. Pump should be **serviced by qualified persons only.**

14.0 Pump Maintenance

CAUTION 	Prior to service, pump clean water through pump and suction / discharge line to remove chemical.
CAUTION 	Always wear protective clothing, face shield, safety glasses and gloves when working on or near your metering pump. Additional precautions should be taken depending on solution being pumped. Refer to MSDS precautions from your solution supplier.

14.1 Routine Inspection and Maintenance

Pump requires very little maintenance. However, pump and all accessories should be checked weekly. This is especially important when pumping chemicals. Inspect all components for signs of leaking, swelling, cracking, discoloration or corrosion. Replace worn or damaged components immediately.

Cracking, crazing, discoloration during first week of operation are signs of severe chemical attack. If this occurs, immediately remove chemical from pump. Determine which parts are being attacked and replace them with parts that have been manufactured using more suitable materials. Manufacturer does not assume responsibility for damage to pump that has been caused by chemical attack.

14.2 Cleaning Pump

Pump will require occasional cleaning, especially Injection fitting, Footvalve / Strainer, and pump head valves. Frequency will depend on type and severity of service.

- ☑ Inspect and replace pump head valves as required.
- ☑ Periodically clean injection / check valve assembly, especially when injecting fluids that calcify such as sodium hypochlorite. These lime deposits and other build ups can clog fitting, increase back pressure and interfere with check valve operation.
- ☑ Periodically clean suction strainer.
- ☑ **Periodically inspect pump housing (enclosure) for chemical attack. Protect pump housing from continuous exposure to chemicals, such as drips or fumes from surrounding equipment and plumbing.**

14.3 Replacing the Pump Diaphragm

When a leak occurs, or a diaphragm needs to be replaced, follow the below steps (read all instruction before starting):

1. Safety First! Wear safety glasses, gloves, and appropriate gear for the chemical being serviced. Follow site safety instructions without exception.
2. Press the Stop key to stop the pump.
3. Relieve system pressure. Disconnect the system plumbing from the pump adapters.
4. Remove the pump head by loosening the allen screws. (Note: Now may be a good time to inspect and clean ball check cartridges.)
5. When changing the diaphragm, the pump head chamber and pump head cover should be wiped free of any dirt and debris.
6. The pump stroke must be FORWARD when removing diaphragm and installing the new diaphragm. Unscrew the diaphragm to remove. Note order of back-up washer and PTFE ring.
7. Screw on new diaphragm and PTFE ring. Hand tighten only. Note order of parts on diagram below.
8. Run pump slowly so the diaphragm is in BACK position when installing and tightening the pump head. Press the Start and Stops buttons to adjust the stroke position.
9. Tighten pump head bolts in a star-shaped pattern, so as to not over-tighten one side. Tighten bolts to 38 in-lbs. (Note: Check bolts and torque after 1-2 hours, as material may soften after the initial break-in period.)
10. Reconnect adapter connections to system piping/tubing. Be sure all connections are tight and check for leaks immediately after putting the pump into service.

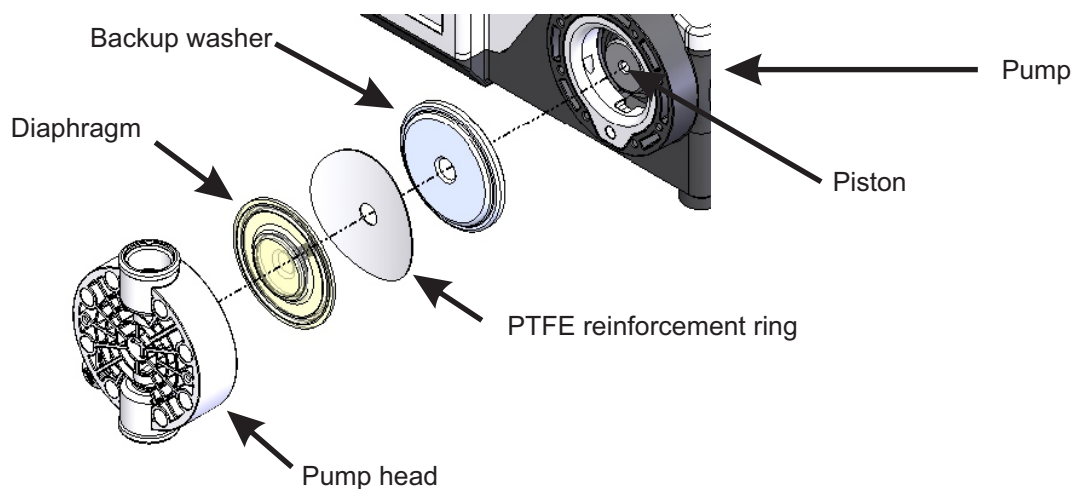

15.0 Output Versus Pressure

Micro Diaphragm, Max 150 PSig / 10.3 bar

Model: C2x2x5
166 RPM
Small Diaphragm
.040" Offset

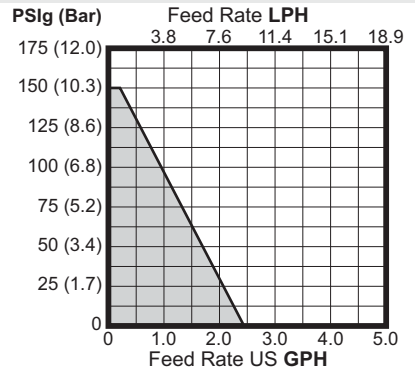

Micro Diaphragm, Max 150 PSig / 10.3 bar

Model: C2x2x6
166 RPM
Small Diaphragm
.060" Offset

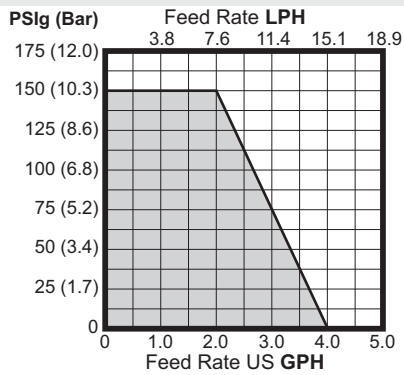

Small Diaphragm, Max 175 PSig / 12 bar

Model: C2x2x3
166 RPM
Small Diaphragm
.040" Offset

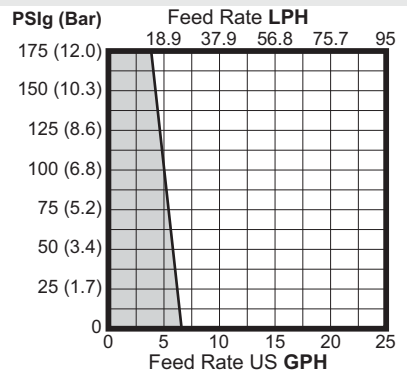

Small Diaphragm, Max 175 PSig / 12 bar

Model: C2x2x1
166 RPM
Small Diaphragm
.060" Offset

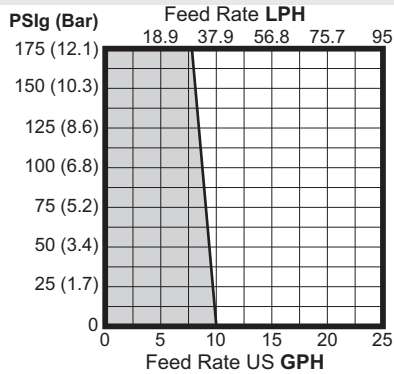

Large Diaphragm, Max 175 PSig / 12 bar

Model: C2x2x2
166 RPM
Large Diaphragm
.060" Offset

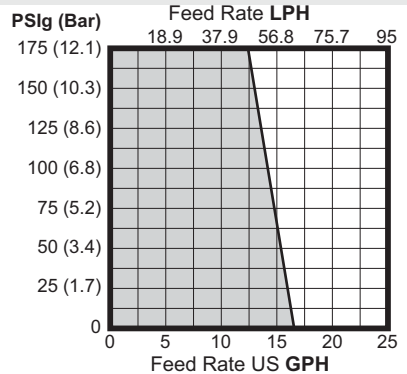

16.0 DFD (Diaphragm Failure Detection)

CHEM-FEED® is equipped with a Diaphragm Failure Detection System which is designed to stop pump and provide an output alarm in event diaphragm should rupture and chemical enters pump head. Pump will detect a chemical with a conductivity reading greater than 500 microsiemens. Chemicals with a conductivity of less than 500 microsiemens will not be detected.

This system is capable of detecting presence of a large number of chemicals including Sodium Hypochlorite (Chlorine), Hydrochloric (muriatic) Acid, Sodium Hydroxide, and many others. System will not be triggered by water (rain, condensation, etc.) or lubricants.

If system has detected chemical, pump diaphragm must be replaced and pump head must be thoroughly cleaned. Failure to clean pump head will void warranty.

If DFD alarm occurs, pump will stop, close an alarm output, and screen will flash DFD with an alarm icon.

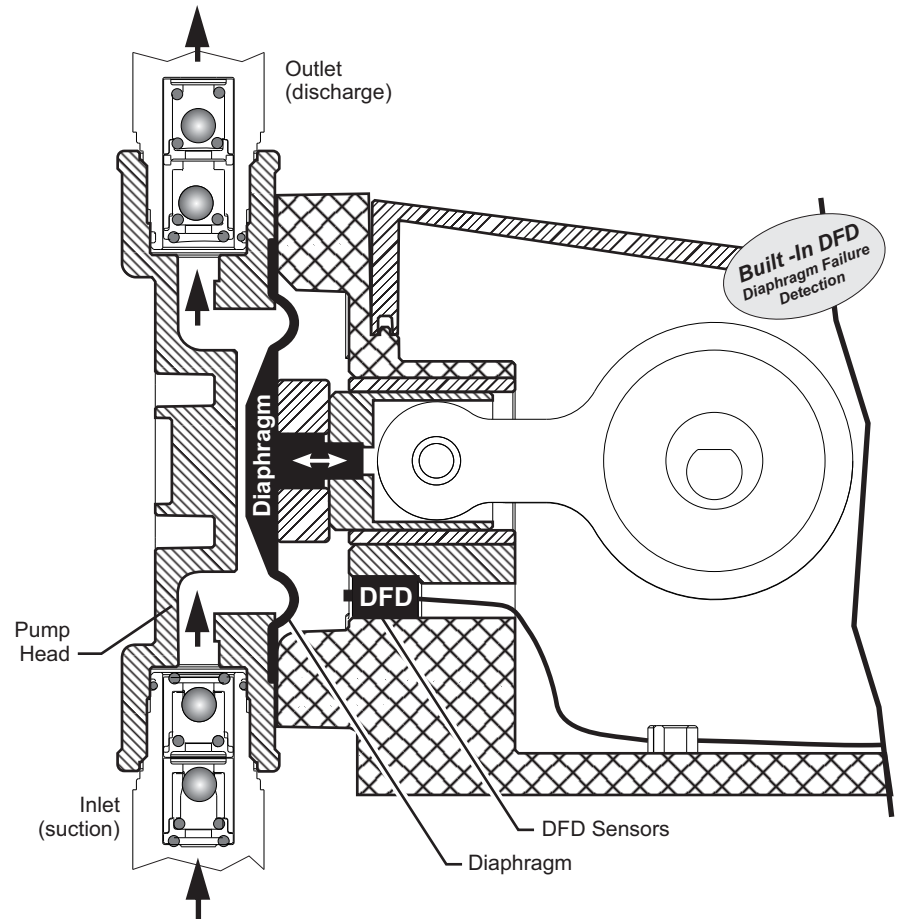

Typical Installation

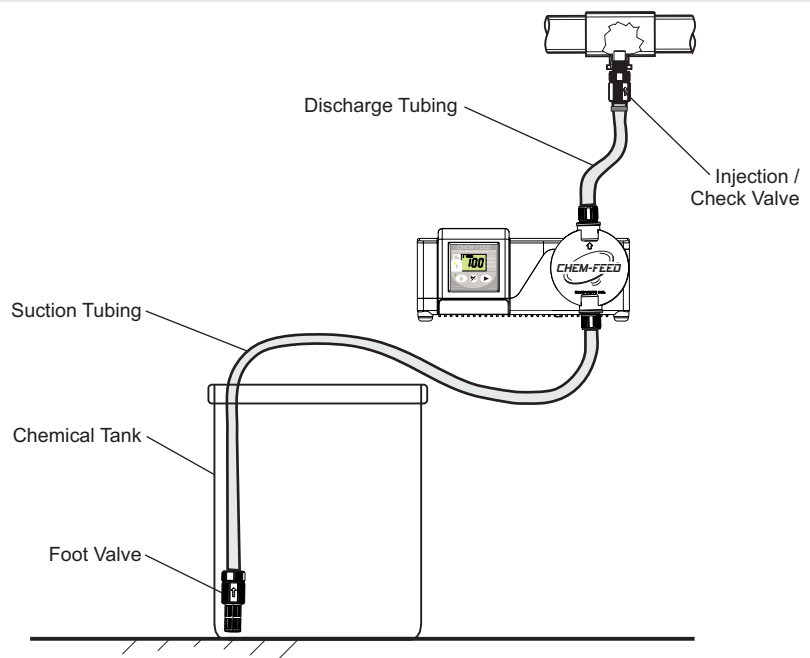

17.0 Replacement Parts List

17.1 C2 Exploded View

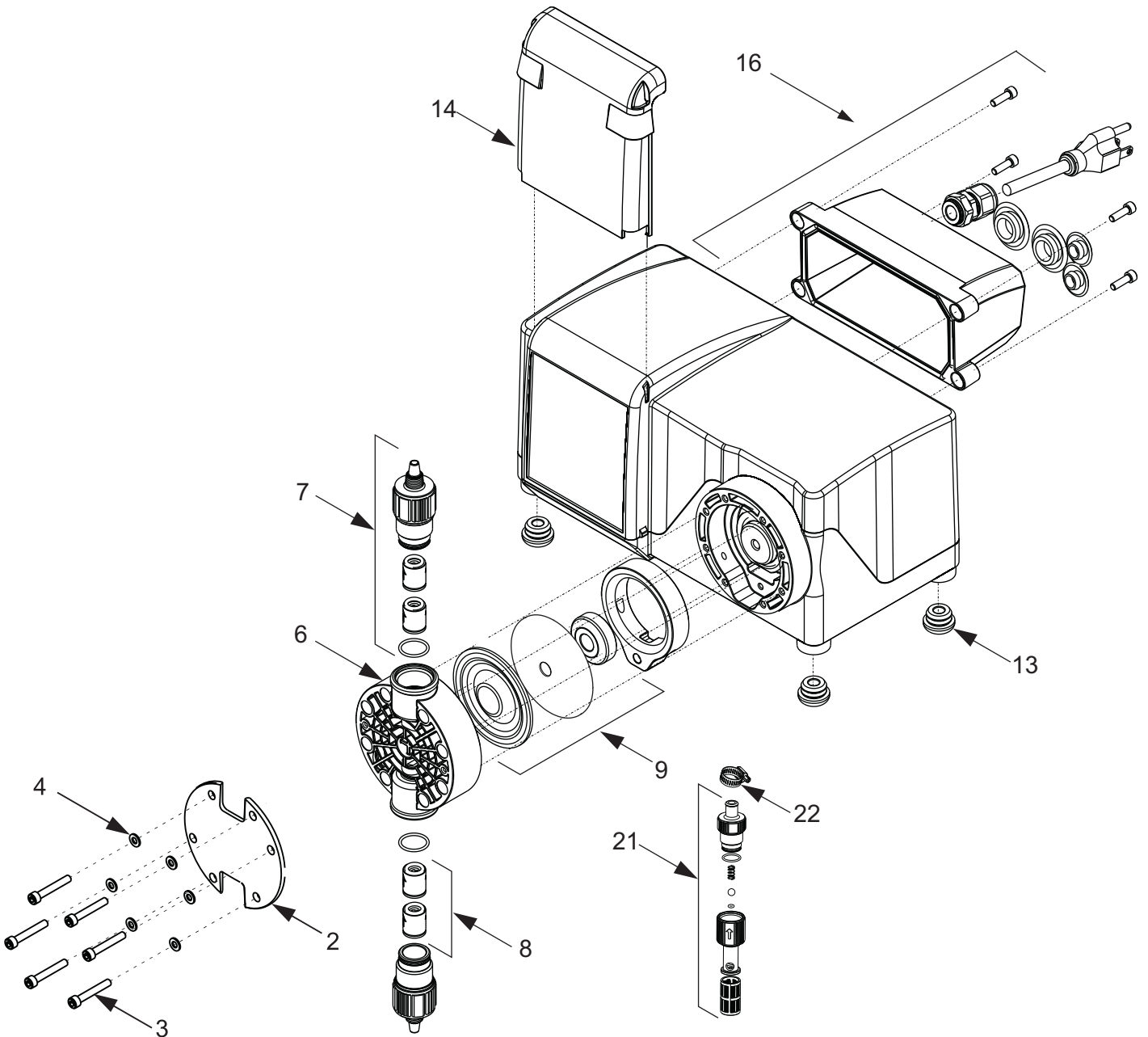

17.2 C2 Replacement Parts

ITEM	PART NO.	DESCRIPTION	QTY REQ.
2	70004-541	COVER P/H, CM-2, SS	1
3	90011-149	SCREW 10X32 X 1.25	8
4	90011-094	WASHER #10 P/H SS	8
6	71010-446	P/HEAD MICRO C2 PVDF	1
	90002-273	P/HEAD SM C2 PVDF	
	90002-272	P/HEAD LG C2 PVDF	
7	70001-349	VALVE .5 M/NPT AFLAS	2
	70001-350	VALVE .5 M/NPT EP	
	70001-351	VALVE .5 F/NPT AFLAS	
	70001-352	VALVE .5 F/NPT EP	
	70001-347	VALVE .5 T-BARB AFLAS	
	70001-348	VALVE .5 T-BARB EP	
	70001-372	VALVE .375 TUBE AFLAS	
8	20000-194	KIT 4 EA. VALVE AFLAS	1
	20000-195	KIT 4 EA. VALVE EP	
9	72000-551	MICRO DIAPHRAGM KIT	1
	72000-296	SMALL DIAPHRAGM KIT	
	72000-297	LARGE DIAPHRAGM KIT	
	72000-606	MICRO DIA KIT FLEX-A-PRENE	
	72000-607	SM DIA KIT FLEX-A-PRENE	
11	71001-002	FRAME INSERT LG. W/SEAL	1
	71001-003	FRAME INSERT SM. W/SEAL	
13	90003-561	BUMPER FEET	4
14	90002-326	UV LCD CVR PLYCRB	1
16	71010-027	J-BOX KIT W/ 115V	1
	71010-029	J-BOX KIT W/ 220V	1
	71010-028	J-BOX KIT W/ 230V	1
	71010-030	J-BOX KIT W/ 240V	1
21	71000-575	FOOTVALVE .5 BRR VIT/AF	1
	71000-447	FTVALVE .5 BRB VT/AF NO SP	
	71000-325	FOOTVALVE .5 BRB EP NO SP	
22	90008-043	CLAMP SS .5"	1

**PAGE INTENTIONALLY
LEFT BLANK**

**PAGE INTENTIONALLY
LEFT BLANK**

19.0 WARRANTY

19.1 Limited Warranty

Your Blue-White product is a quality product and is warranted for a specific time from date of purchase (proof of purchase is required). The product will be repaired or replaced at our discretion. Failure must have occurred due to defect in material or workmanship and not as a result of operation of the product other than in normal operation as defined in the product manual. Warranty status is determined by the product's serial label and the sales invoice or receipt. The serial label must be on the product and legible. The warranty status of the product will be verified by Blue-White or a factory authorized service center.

CHEM-FEED® C2 pumps are warranted for 2 years from date of purchase (proof of purchase is required). Pumps will be repaired or replaced at our discretion.

19.2 DIAFLEX® Warranty

DIAFLEX® diaphragms are warranted for the life of the pump. Blue-White will replace a damaged diaphragm at no cost to the customer provided the pump was at all times operated within the guidelines included in the pump's operation manual. This warranty only applies to DIAFLEX® diaphragms, not the pumps themselves. Blue-White pumps are separately covered by warranties specific to them.

19.3 What is not Covered

- > **Flex-A-Prene diaphragm and rubber components - They are perishable and require periodic replacement**
- > **Pump removal, or re-installation, and any related labor charge.**
- > **Freight to the factory, or service center**
- > **Pumps that have been tampered with, or in pieces.**
- > **Damage to the pump that results from misuse, carelessness (such as chemical spills on the enclosure), abuse, lack of maintenance, or alteration that is out of Blue-White control.**
- > **Pumps damaged by faulty wiring, power surges, or acts of nature.**

Blue-White does not assume responsibility for any loss, damage, or expense directly or indirectly related to or arising out of the use of its products. Failure must have occurred due to defect in material or workmanship and not as a result of operation of the product other than in normal operation as defined in the pump operation manual.

The warranty status is determined by the pump's serial label and the sales invoice or receipt. The serial label must be on the pump and be legible. The warranty status of the pump will be verified by Blue-White or a factory authorized service center.

19.4 Procedure for In-Warranty Repair

Warranty service must be performed by the factory or an authorized service center. Contact the factory or local repair center to obtain a RMA (Return Material Authorization) number. It is recommended to include foot strainer and injection/check valve fitting since these devices may be clogged and part of the problem. Decontaminate, dry, and carefully pack the product to be repaired. Please enclose a brief description of the problem and proof of purchase. Prepay all shipping and insurance cost. COD shipments will not be accepted. Damage caused by improper packaging is the responsibility of the sender. When In-Warranty repair is completed, the factory pays for return shipping to the dealer or customer.

19.5 Product Use Warning

Blue-White products are manufactured to meet the highest quality standards in the industry. Each product instruction manual includes a description of the associated product warranty and provides the user with important safety information. Purchasers, installers, and operators of Blue-White products should take the time to inform themselves about the safe operation of these products. In addition, Customers are expected to do their own due diligence regarding which products and materials are best suited for their intended applications. Blue-White is pleased to assist in this effort but does not guarantee the suitability of any particular product for any specific application as Blue-White does not have the same degree of familiarity with the application that the customer/end user has. While Blue-White will honor all of its product warranties according to their terms and conditions, Blue-White shall only be obligated to repair or replace its defective parts or products in accordance with the associated product warranties. **BLUE-WHITE SHALL NOT BE LIABLE EITHER IN TORT OR IN CONTRACT FOR ANY LOSS OR DAMAGE WHETHER DIRECT, INDIRECT, INCIDENTAL, OR CONSEQUENTIAL, ARISING OUT OF OR RELATED TO THE FAILURE OF ANY OF ITS PARTS OR PRODUCTS OR OF THEIR UNSUITABILITY FOR A GIVEN PURPOSE OR APPLICATION.**

19.6 Chemical Resistance Warning

Blue-White offers a wide variety of wetted parts. Purchasers, installers, and operators of Blue-White products must be well informed and aware of the precautions to be taken when injecting or measuring various chemicals, especially those considered to be irritants, contaminants or hazardous. Customers are expected to do their own due diligence regarding which products and materials are best suited for their applications, particularly as it may relate to the potential effects of certain chemicals on Blue-White products and the potential for adverse chemical interactions.

Blue-White tests its products with water only. The chemical resistance information included in this instruction manual was supplied to Blue-White by reputable sources, but Blue-White is not able to vouch for the accuracy or completeness thereof. While Blue-White will honor all of its product warranties according to their terms and conditions, Blue-White shall only be obligated to repair or replace its defective parts or products in accordance with the associated product warranties.

BLUE-WHITE SHALL NOT BE LIABLE EITHER IN TORT OR IN CONTRACT FOR ANY LOSS OR DAMAGE, WHETHER DIRECT, INDIRECT, INCIDENTAL, OR CONSEQUENTIAL, ARISING OUT OF OR RELATED TO THE USE OF CHEMICALS IN CONNECTION WITH ANY BLUE-WHITE PRODUCTS.

Model Number Matrix

Model Number

C2	Diaphragm metering pump							
Series								
F	Single manual output control (manual/local control only)							
V	Multiple automatic input output control and alarm modes (remote control)							
Input Voltage								
4	115V / 60Hz, power cord NEMA 5/15 plug (US)			8	240V / 50HZ, power cord AS 3112 plug (AU/New Zealand)			
5	230V / 60Hz, power cord NEMA 6/15 plug (US)			9	230V / 50HZ, power cord BS 1363 plug (UK)			
6	220V / 50HZ, power cord CEE 7/II plug (EU)							
CAM Stroke Length and Diaphragm Size								
1	.060" (1.52 mm) stroke with small diaphragm .10–10 GPH 175 PSI							
2	.060" (1.52 mm) stroke with large diaphragm .165–16.5 GPH 175 PSI							
3	.040" (1.02 mm) stroke with small diaphragm .067–6.7 GPH 175 PSI							
5	.040" (1.02 mm) stroke with Micro-Feed .02–2.3 GPH 150 PSI							
6	.060" (1.52 mm) stroke with Micro-Feed .04–4.0 GPH 150 PSI							
Electrical Options								
X	Standard equipment							
Elastomer Material (o-rings)								
V	TFE/P			E	EP (Ethylene Propylene)			
Fitting Connection Types								
A	1/2" Hose Barb Inlet, 1/2" Male NPT Outlet, with 1/2" Male NPT Injection Fitting							
B	1/2" Hose Barb Inlet, 1/2" Female NPT Outlet, with 1/2" Male NPT Injection Fitting							
C	1/2" Hose Barb Inlet and Outlet, with 1/2" ID Hose Barb Injection Fitting							
D	3/8" OD Tube Compression Inlet, Outlet, and Injection Fitting							
E	1/2" Male NPT Inlet and Outlet, with 1/2" Male NPT Injection Fitting							
F	1/2" Female NPT Inlet and Outlet, with 1/2" Male NPT Injection Fitting							
Diaphragm Type								
(Blank)	Standard DiaFlex® Diaphragm							
S	Flex-A-Prene® Diaphragm (Caustic Soda resistant diaphragm)							
C2	F	2	4	1	X	V	A	Sample Model Number

Accessories

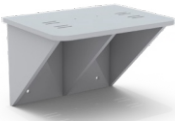

KIT-PSM
Wall Mount Bracket, HDPE



71000-555
PVDF INJECTOR, 1/4" ID tubing
71000-579
PVDF INJECTOR, 1/2" Hose Barb
71000-577
PVDF INJECTOR, 1/2" MNPT



C-334-6-10
Suction Tubing, Clear PVC 1/4"x 3/8", 10 ft
C-335-6-25
Discharge Tubing, PE, 1/4" x 3/8", 25 ft
76001-361
Suction Tubing, Clear PVC, 1/2" ID, 8ft
90008-437
Discharge Tubing, Braided PVC, 1/2" ID

Ball Check Cartridge Options

20000-228
Ball Check Cart. Hastelloy Balls
20000-229
Ball Check Cart. PTFE Balls
70001-409 (2 req.)
Ball Check Cart., Single Ceramic Ball with Hastelloy Spring

Visit Accessory Pages for More Options



Users of electrical and electronic equipment (EEE) with the WEEE marking per Annex IV of the WEEE Directive must not dispose of end of life EEE as unsorted municipal waste, but use the collection framework available to them for the return, recycle, recovery of WEEE and minimize any potential effects of EEE on the environment and human health due to the presence of hazardous substances. The WEEE marking applies only to countries within the European Union (EU) and Norway. Appliances are labeled in accordance with European Directive 2002/96/EC.

Contact your local waste recovery agency for a *Designated Collection Facility* in your area.

Blue-White[®]

5300 Business Drive
Huntington Beach, CA 92649
USA

TEL: 714-893-8529
FAX: 714-894-9492

www.blue-white.com
customerservice@blue-white.com