

PCA-A42KA7 & PUZ-A42NKA7
42,000 BTU/H CEILING-SUSPENDED INDOOR UNIT
42,000 BTU/H HEAT PUMP UNIVERSAL OUTDOOR



Job Name:

System Reference:

Date:



Indoor Unit.....PCA-A42KA7

Outdoor Unit.....PUZ-A42NKA7

INDOOR UNIT FEATURES

- Airflow settings for high and low ceiling applications
- Knock-out for outside-air intake
- Optional i-see Sensor™ for air distribution and energy saving
- Auto fan speed mode
- Filter status indicator
- Easy-to-clean, washable filter
- Suspends from ceiling for quick and easy installation
- Ideal for larger retail stores, classrooms, and restaurants
- Multiple control options available:
 - kumo cloud® smart device app for remote access
 - Third-party interface options
 - Wired or wireless controllers

OUTDOOR UNIT FEATURES

- Variable speed INVERTER-driven compressor
- Pre-charged with refrigerant volume for piping length up to 100 ft
- Low ambient cooling down to 0°F providing 100% capacity
- 24-hour continuous operation (cooling mode)
- High pressure protection
- Fast restart
- Superior energy and operational efficiency
- Seacoast protection*
 - External Outer Panel: Phosphate coating + Acrylic-Enamel coating
 - Fan Motor Support: Epoxy resin coating (at edge face)
 - Separator Assembly Valve Bed: Epoxy resin coating (at edge face)
 - Blue Fin treatment is an anti-corrosion treatment that is applied to the Heat exchanger coil to protect it against airborne contaminants.
 - Heat exchanger coil and base panel rated for 2,000 hours in accordance with ASTM B117 testing

*Seacoast protection standard from 2022 production

INDOOR UNIT ACCESSORIES: PCA-A42KA7

Control Interface	BACnet® and Modbus® Interface	PAC-UKPRC001-CN-1
	CN24 Relay Kit	CN24RELAY-KIT-CM3
	IT Extender	PAC-WHS01IE-E
	kumo station® for kumo cloud®	PAC-WHS01HC-E
	Remote Operation Adapter†	PAC-SF40RM-E
	Thermostat Interface	PAC-US444CN-1
	Thermostat Interface	PAC-US445CN-1
	USNAP Adapter	PAC-WHS01UP-E
	Wireless Interface for kumo cloud®	PAC-USWHS002-WF-2
Remote Sensor	Flush Mount Remote Temperature Sensor	PAC-USSEN002-FM-1
	Flush Mount Temperature Sensor	PAC-USSEN001-FM-1
	Remote Temperature Sensor	PAC-SE41TS-E
	Wireless temperature and humidity sensor for kumo cloud®	PAC-USWHS003-TH-1
Wired Remote Controller	Deluxe Wired MA Remote Controller†	PAR-40MAAU
	Simple Ductless Wired Remote Controller	PAC-SDW01RC-1
	Simple MA Remote Controller†	PAC-YT53CRAU-J
	Touch MA Controller†	PAR-CT01MAU-SB
Wireless Remote Controller	kumo touch™ RedLINK™ Wireless Controller	MHK2
	Lockdown bracket for remote controller	RCMKP1CB
	Wireless MA Receiver	PAR-FA32MA-W
	Wireless MA Remote Controller	PAR-FL32MA-E
	Wireless Receiver Kit	PAR-SL93B-E
	Wireless Receiver Kit with i-See sensor™	PAR-SA92MW-E
Condensate	Blue Diamond (Advanced) Mini Condensate Pump w/ Reservoir & Sensor (208/230V) [recommended]	X87-721
	Blue Diamond (MegaBlue Advanced) Condensate Pump w/ Reservoir & Sensor	X87-835
	Refco Condensate Pump (100-240 VAC) up to 120,000 BTU/H	COMBI
Disconnect Switch	(30A/600V/UL) [fits 2" X 4" utility box] - Black	TAZ-MS303
Lineset	10' x 3/8" x 10' x 5/8" Lineset (Twin-Tube Insulation)	MPLS385812T-10
	100' x 3/8" x 100' x 5/8" Lineset (Twin-Tube Insulation)	MPLS385812T-100
	15' x 3/8" x 15' x 5/8" Lineset (Twin-Tube Insulation)	MPLS385812T-15
	30' x 3/8" x 30' x 5/8" Lineset (Twin-Tube Insulation)	MPLS385812T-30
	50' x 3/8" x 50' x 5/8" Lineset (Twin-Tube Insulation)	MPLS385812T-50
	65' x 3/8" x 65' x 5/8" Lineset (Twin-Tube Insulation)	MPLS385812T-65

NOTES:

†PAC-SF40RM-E (Unable to use with wireless remote controller)

OUTDOOR UNIT ACCESSORIES: PUZ-A42NKA7

Air Outlet Guide	Air Outlet Guide (1 Piece)	PAC-SG59SG-E
	Air Outlet Guide (1 Piece)	PAC-SH96SG-E (two pieces are required)
Control/Service Tool	Control/Service Tool	PAC-SK52ST
	M- & P-Series Maintenance Tool Cable Set	M21EC0397
	USB/UART Conversion Cable (Required for all laptop connection)	M21EC1397
M-NET Converter	M-NET Converter	PAC-SJ85MA-E
	M-NET Converter	PAC-SJ95MA-E
Mini-Split Wire	14 Gauge, 4 wire MiniSplit Cable—250 ft. roll	S144-250
	14 Gauge, 4 wire MiniSplit Cable—50 ft. roll	S144-50
	16 Gauge, 4 wire MiniSplit Cable—250 ft. roll	S164-250
	16 Gauge, 4 wire MiniSplit Cable—50 ft. roll	S164-50
Mounting Pad	Condensing Unit Mounting Pad: 24" x 42" x 3"	ULTRILITE2
Stand	18" Dual Fan Stand	QSMS1802M
	24" Dual Fan Stand	QSMS2402M
	Condenser Wall Bracket	QSWB2000M-1
	Condenser Wall Bracket - Stainless Steel Finish	QSWBSS
	Outdoor Unit Stand — 12" High	QSMS1202M
Wind Baffle	Front Wind Baffle	WB-PA3 (two pieces are required)
	Rear Wind Baffle	WB-RE6
	Side Advanced Wind Baffle	WB-SD6

INDOOR UNIT DIMENSIONS: PCA-A42KA7

Unit: in (mm)

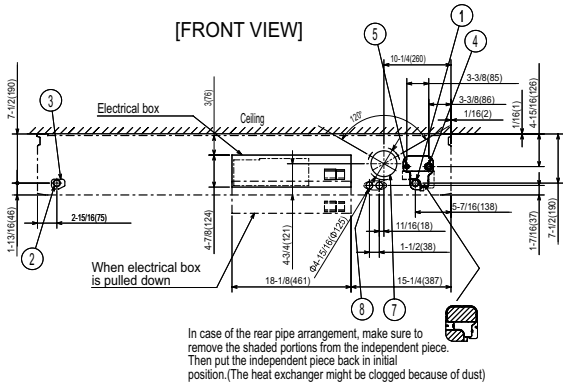

NOTES.
 1. Use M10 or W3/8 screw for anchor bolt.
 2. Please be sure when installing the drain pump (option parts), refrigerant pipe will be only upward.

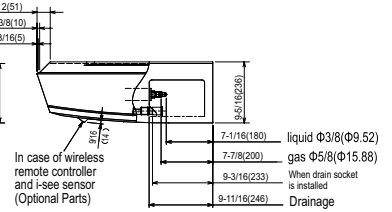
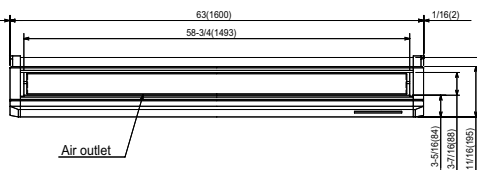
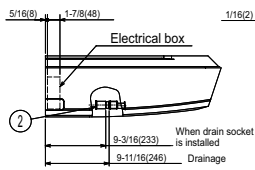
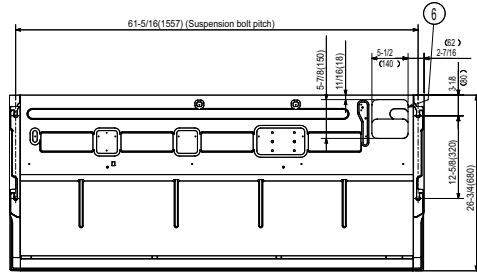

- ① Drainage pipe connection(1(26mm)I.D.)
- ② Drainage pipe connection(for the left arrangement)
- ③ Knockout hole for left drain-piping arrangement
- ④ Refrigerant-pipe connection (gas pipe side/flared connection)
- ⑤ Refrigerant-pipe connection (liquid pipe side/flared connection)
- ⑥ Knockout hole for upper drain pipe arrangement
- ⑦ Knockout hole for fresh air intake $\Phi 3-15/16(\Phi 100)$
- ⑧ Knockout hole for wiring arrangement $\Phi 7/8(\Phi 22)$ Accessory..Drain socket (1(26mm)I.D.)

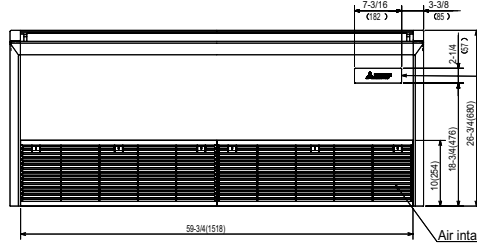

In case of wireless remote controller and i-see sensor(Optional Parts)

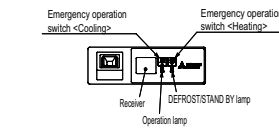

OUTDOOR UNIT DIMENSIONS: PUZ-A42NKA7

Unit: mm<in>

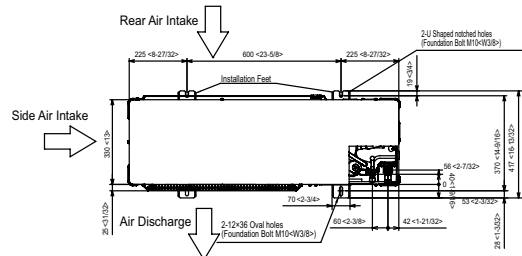
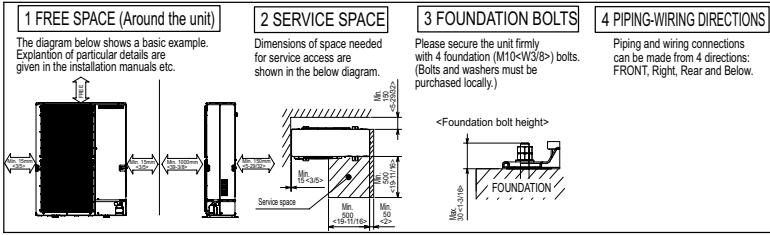

Example of Notes

- ① - Refrigerant GAS pipe connection (FLARE) ø15.88(5/8F)
- ② - Refrigerant LIQUID pipe connection (FLARE) ø9.52(3/8F)
- *1 ... Indication of STOP VALVE connection location.

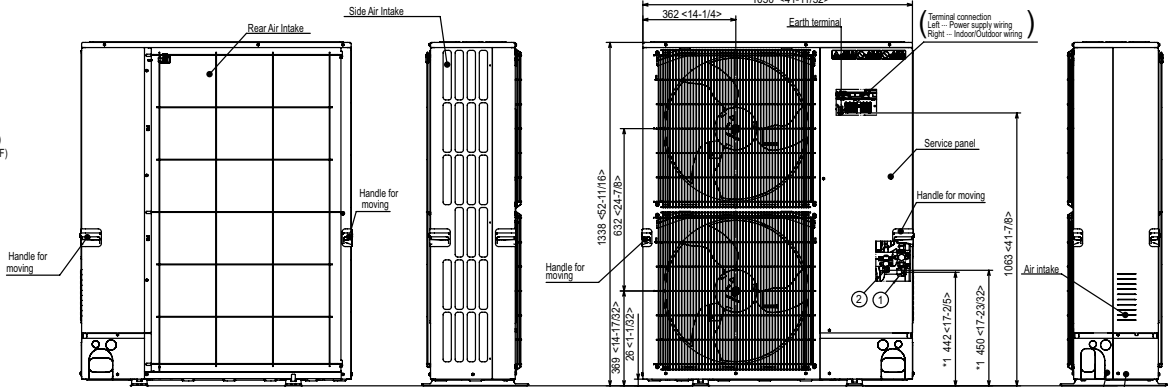

Piping Knockout Hole Details

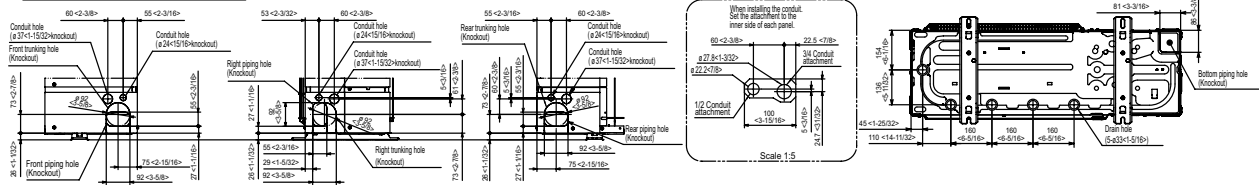

1340 Satellite Boulevard Suwanee, GA 30024
Toll Free: 800-433-4822 www.mehvac.com



FORM# PCA-A42KA7 & PUZ-A42NKA7 - 202304