

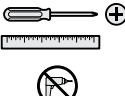

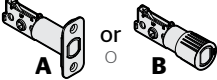



Required tools Herramientas necesarias	Parts in the box Piezas en la caja		
	Latch Pestillo 	Strike Placa 	Screws Tornillos 
Additional tools (if needed) Herramientas adicionales (si es necesario) 	Adapter Adaptador 	Interior assembly Ensamble interior 	

1 Prepare door and check dimensions Prepare la puerta y revise las dimensiones

If drilling a new door, use the supplied template and the complete door drilling instructions available at kwikset.com/doorprep

Si va a perforar una puerta nueva, utilice la plantilla suministrada y las instrucciones completas para la perforación de la puerta están disponibles en kwikset.com/doorprep

*If hole is drilled all the way through door, call Kwikset to order 664 conversion kit.

*Si el orificio se perfora en su totalidad a través de la puerta, llame a Kwikset para pedir un kit de conversión 664.

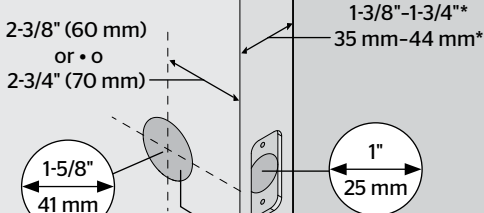

IMPORTANT: Hole is not drilled all the way through the door*.

IMPORTANTE: El orificio no se perfora en su totalidad a través de la puerta*.

2 Install latch Instale el pestillo

Latch with rectangular faceplate

Pestillo con la placa frontal rectangular

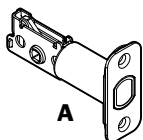

or

Latch with drive-in collar

Pestillo con el aro de empuje

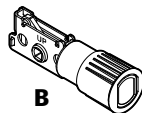

Make sure "UP" is on top.

Asegúrese de que "UP" este en la parte superior.

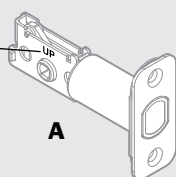

Make sure "UP" is on top.

Asegúrese de que "UP" este en la parte superior.

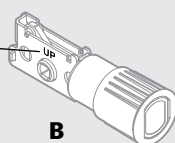

Position adapter on side of latch that will be visible from interior side of door.

Ubique el adaptador del lado del pestillo que estará visible del lado interior de la puerta.

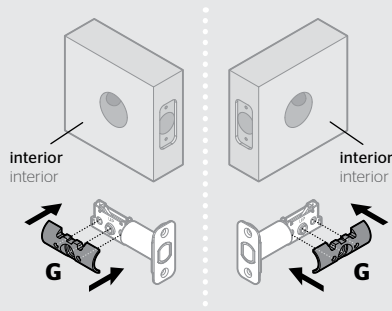

Position adapter on side of latch that will be visible from interior side of door.

Ubique el adaptador del lado del pestillo que estará visible del lado interior de la puerta.

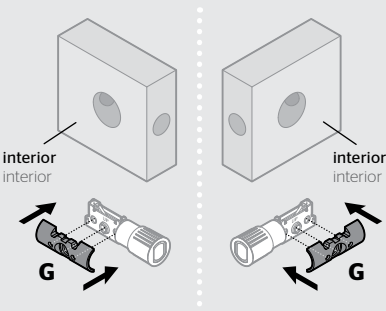

Install latch.
Instale el pestillo.

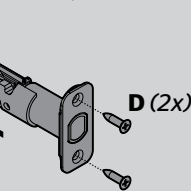

Install latch.
Instale el pestillo.

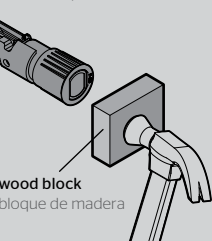

Make sure adapter is visible in hole.

Asegúrese de que el adaptador es visible en el orificio.

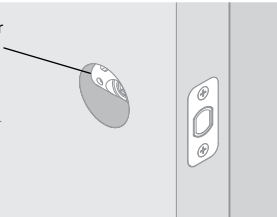

Make sure adapter is visible in hole.

Asegúrese de que el adaptador es visible en el orificio.

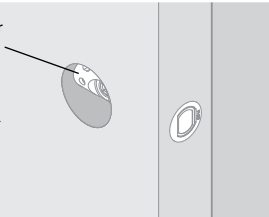

Instructions continue on reverse
Las instrucciones continúan en el reverso de la hoja

Drilling Template Plantilla de perforación

Template is only needed if a new hole must be drilled in the door.
La plantilla solo se necesita en caso de que deba perforarse un nuevo orificio en la puerta.

Edge of the door
Borde de la puerta

Face of the door
Frente de la puerta

Fold
Doble

Centerline
Línea central

2-3/8" (60 mm)

2-3/4" (70 mm)

Backset • Distancia al centro

1-3/4" (44 mm)
1-3/8" (35 mm)

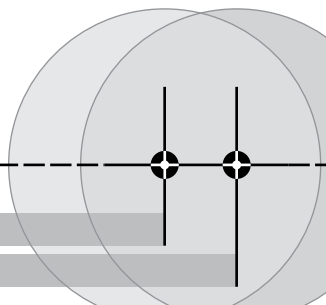

3

Install interior assembly Instale el ensamble interior

A Rotate turnpiece to horizontal position.

Gire la pieza de giro a la posición horizontal.

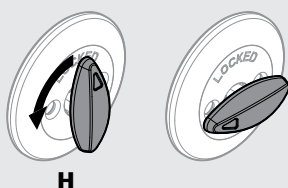

B Insert torque blade.

Inserte la paleta de torsión.

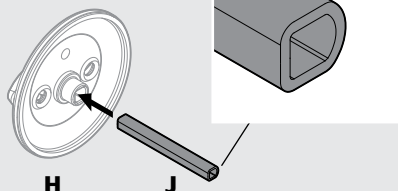

C Install interior assembly.

Instale el ensamble interior.

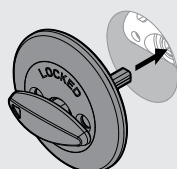

D Rotate turnpiece to vertical position.

Gire la pieza de giro a la posición vertical.

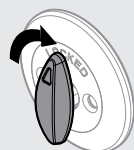

E Secure interior assembly with screws.

Fije el ensamble interior con los tornillos.

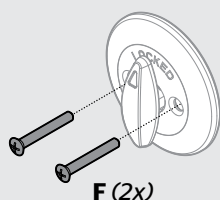

4

Install strike on door frame Instale la placa en el marco de la puerta

A

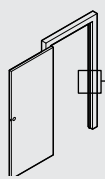

⚠ Make sure hole for strike is drilled a minimum of 1" (25 mm) deep.

Asegúrese de que el orificio de la placa se perfora un mínimo de 1" (25 mm) de profundidad.

B

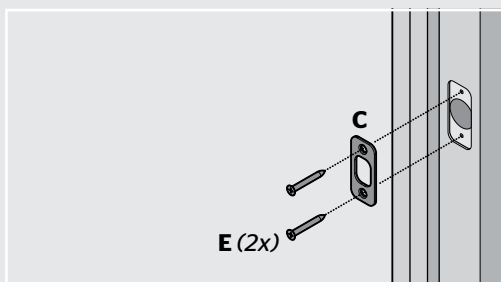

Register your product at www.kwikset.com/productregistration
Rate your product at www.kwikset.com/reviews

Registre su producto en www.kwikset.com/productregistration
Clasifique su producto en www.kwikset.com/reviews

⚠ WARNING: This Manufacturer advises that no lock can provide complete security by itself. This lock may be defeated by forcible or technical means, or evaded by entry elsewhere on the property. No lock can substitute for caution, awareness of your environment, and common sense. Builder's hardware is available in multiple performance grades to suit the application. In order to enhance security and reduce risk, you should consult a qualified locksmith or other security professional.

⚠ ADVERTENCIA: Este Fabricante hace saber que no hay cerrojos que puedan proporcionar completa seguridad por sí mismos. Puede hacerse que falle este cerrojo forzándolo o utilizando medios técnicos, o puede evadirse entrando por otra parte de la propiedad. No hay cerrojos que puedan hacer de sustitutos para la precaución, el estar al tanto del entorno, y el sentido común. Pueden obtenerse piezas de ferretería de constructor con diversos grados de rendimiento para ajustarse a la aplicación. Para realzar la seguridad y reducir los riesgos, debe consultar con un cerrajero capacitado u otro profesional de seguridad.