

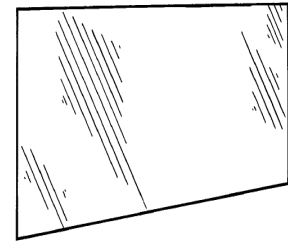

MEDICINE CABINETS

SPECIFICATION SHEET

**WM2436PEBP5
Wall Mirror**



FEATURES/TYPICAL SPECIFICATIONS

- Surface Mount Installation
- 5/32" thick float glass mirror with polished edge, 4 sides
- Silver mirror with IR cured, protective paint backing
- Overall Weight: 11.9lbs
- Manufactured in accordance with ASTM C 1036 and C 1503
- Point of Origin: USA
- Individually packaged
- Shipped as part of a 5 mirror bulk pack
- Mounting hardware available for purchase separately

Finishes:

- Housing: N/A
- Mirror: Polished Edge
- Frame: Frameless

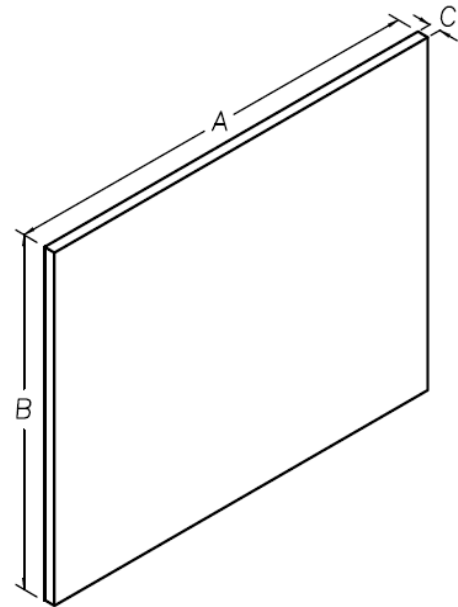

		Dimensions In Inches		
Model #	Description	A	B	C
WM2436PEBP5	WALL MIRROR 24X36 PE	35.875	23.875	0.156

REFERENCE	QTY.	REMARKS	Project
			Location
			Architect
			Engineer
			Contractor
			Submitted by Date

* All models and material specifications are subject to change or withdrawal without notice.

SWM2436PEBP5_A00