

Safgard™

Model 1100

Low Water Cut-Off For Residential Hot Water Boilers

24 VAC Operating Voltage

- ADVANCED SOLID STATE DESIGN
- TEST BUTTON FOR EASY DIAGNOSTICS
- POWER, LOW WATER AND SERVICE-NEEDED INDICATORS
- MOLEX CONNECTOR FOR EASY WIRING
- COMPACT SIZE ALLOWS FOR MOUNTING IN TIGHT SPACES

Step 1

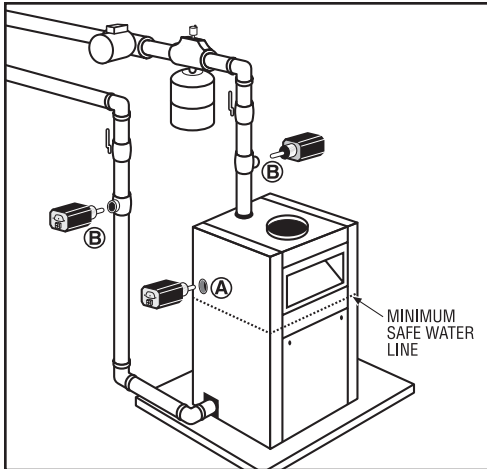

Determine Mounting Location

The Safgard 1100 must be installed at or above the minimum safe water level established by the boiler manufacturer. The 1100 can be installed directly into the boiler if a suitable tapping is available (A). The 1100 can also be installed in the boiler piping using a standard 3/4" tee (B).

Note: When installing in piping, select a location close to the boiler to ensure the 4' wiring harness will reach the 24-Volt transformer. The cut-off should be installed on the boiler side of the circulator or shut-off valves.

IMPORTANT: Check for adequate clearance (minimum 1/4") from metal probe sensor to any surface inside the boiler or pipe.

Do not install in a location that could hold or trap water in the event of a low water condition.

Step 2

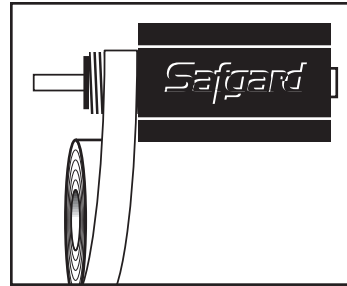

Apply Teflon® tape to the threads of the Model 1100. Do not use pipe dope or other pipe sealants.

Step 3

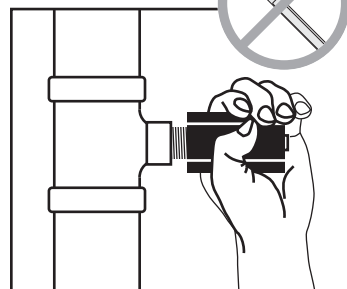

Hand tighten the control into boiler tapping or pipe tee. Be careful not to cross thread.

Note: Do not use a wrench. Hand tighten only.

Step 4

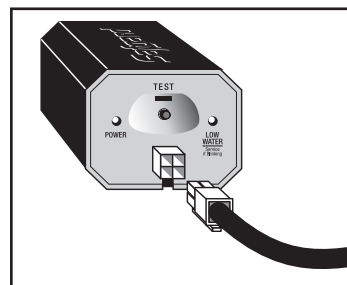

Plug wire harness into connector on face of control.



WARNING

Electrical shock hazard. To prevent electrical shock, death or equipment damage, disconnect power supply before installing or servicing control. Only qualified personnel may install or service this control in accordance with local codes and ordinances. Read instructions completely before proceeding.



CAUTION

To prevent serious burns, boiler should be thoroughly cooled before installing or servicing control.



WARNING

Frozen pipes/water damage. Central heating systems are prone to shut down as a result of power or fuel outages, safety related fault conditions or equipment failure. Installation of freeze protection monitoring or other precautions is recommended for unattended dwellings in climates subject to sustain below-freezing temperatures.

**HYDROLEVEL
COMPANY**

126 Bailey Road, North Haven, CT 06473 • Phone (203) 776-0473 • FAX (203) 764-1711 • www.hydrolevel.com

WIRING TO CONTROL CENTER

For boilers equipped with a Honeywell R8285 Control Center or equivalent

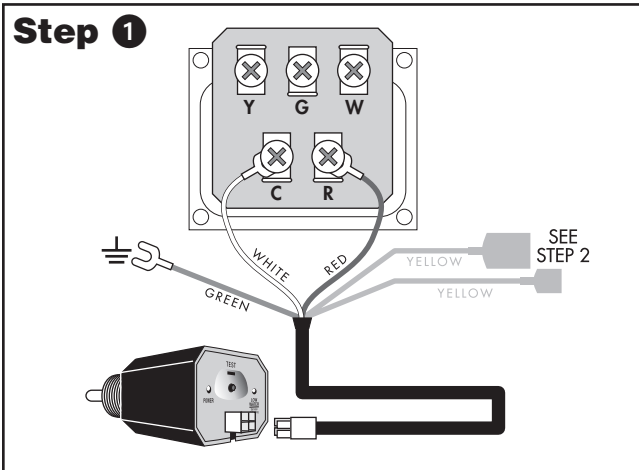

Connect the WHITE wire to **C** and the RED wire to **R** using the screw terminals on the control center. Connect the GREEN wire to any suitable, unpainted ground screw. **Note:** for operation of the control, the green wire must be connected to a ground source electrically common with boiler ground.

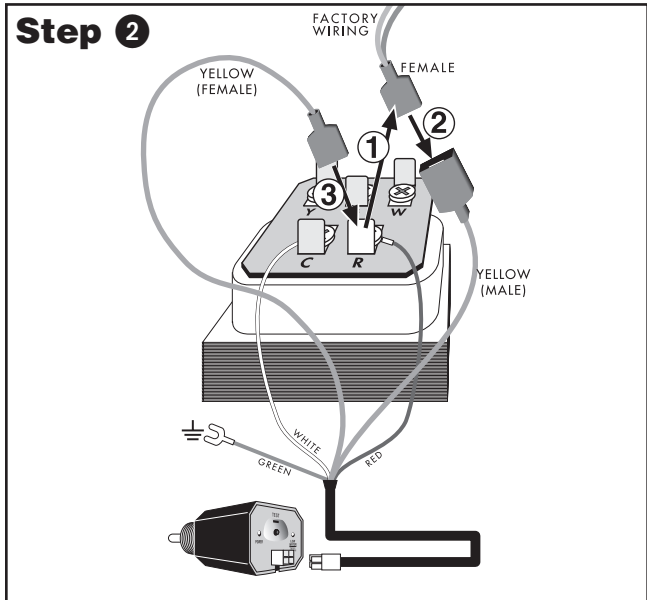

① Unplug the factory-wired quick connect from terminal **R** and ② plug into YELLOW wire with *male* connector. ③ Plug YELLOW wire with *female* connector into terminal **R**.

WIRING TO AN AQUASTAT

For boilers equipped with a Honeywell Model L8148E or L8124E Aquastat. Safgard Model 1100 is not to be used with Model L8148C or L8124C. Safgard Model 1150 should be used for oil-fired boilers.

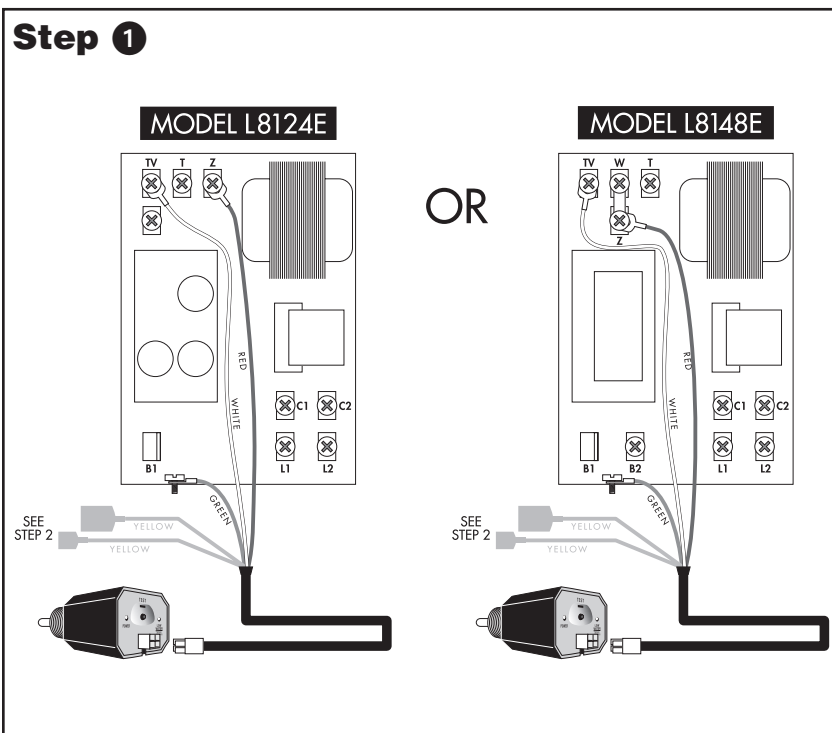

Connect the WHITE wire to **TV** and the RED wire to **Z**. Connect the GREEN wire to the ground screw on the bottom of the aquastat or any other suitable, unpainted ground screw. **Note:** for operation of the control, the green wire must be connected to a ground source electrically common with boiler ground.

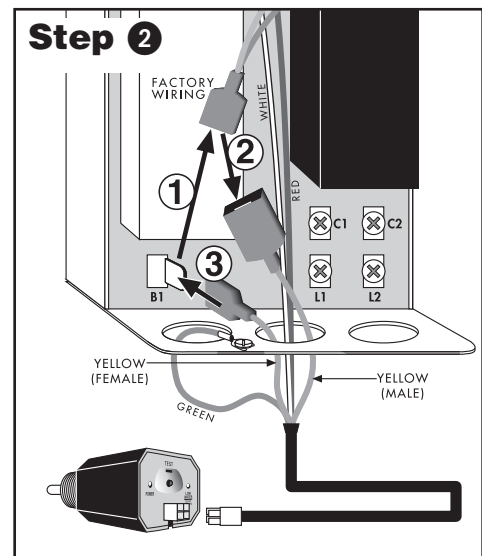

① Unplug the factory-wired quick connect from terminal **B1** and ② plug into YELLOW wire with *male* connector. ③ Plug YELLOW wire with *female* connector into terminal **B1**.

UPON COMPLETION OF WIRING, REPLACE COVER.

WIRING TO 24 VAC TRANSFORMER

For boilers using a standard 24 VAC transformer

Step 1

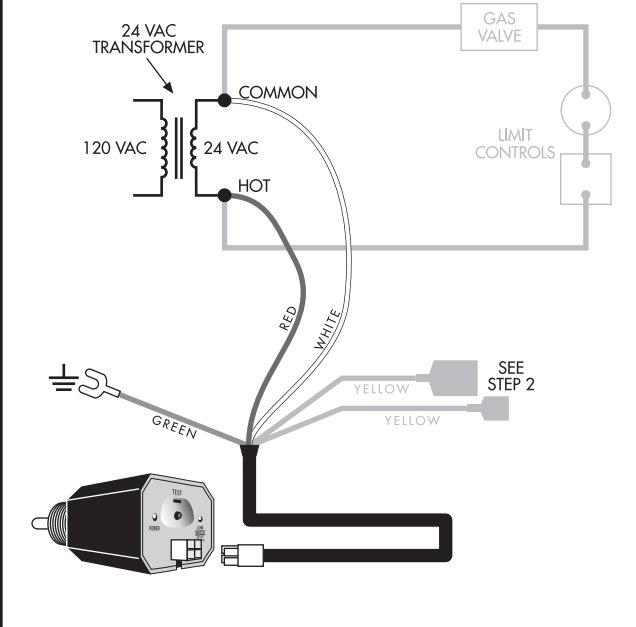

Connect RED wire to *hot* side of 24 Volt boiler transformer (R). Connect WHITE wire to common side of 24 Volt boiler transformer (C). Connect the GREEN wire to any suitable, unpainted ground screw.

Note: for operation of the control, the green wire must be connected to a ground source electrically common with boiler ground.

Step 2

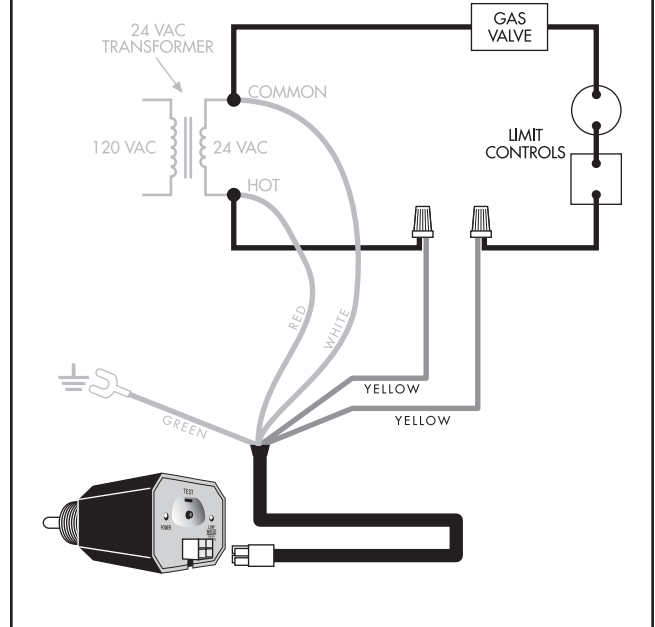

Cut-off the connectors and strip the ends of the two yellow wires of the Model 1100 harness. Break into the burner circuit between the *hot* side of the transformer (R) and other limit controls. Connect either YELLOW wire to the *hot* side. Connect the other YELLOW wire in series with other limit controls.

Important: The switch contacts of the low water cut-off (yellow wires) must be wired in series with all other limit and operating controls (as shown above).

BOILER SPECIFIC MODELS AND WIRE HARNESSSES

Part No.	Model	Description
45-1100	1100	1100 with standard wire harness (cable 45-531-54)
45-1102	1100H2	1100 with wire harness for UTC intergrated control module (cable 45-348)
45-1103	1100H3	1100 without wire harness
45-1105	1100H5	1100 with wire harness for Weil McLain Ultra, Lochinvar Knight & Solution (cable 45-349)

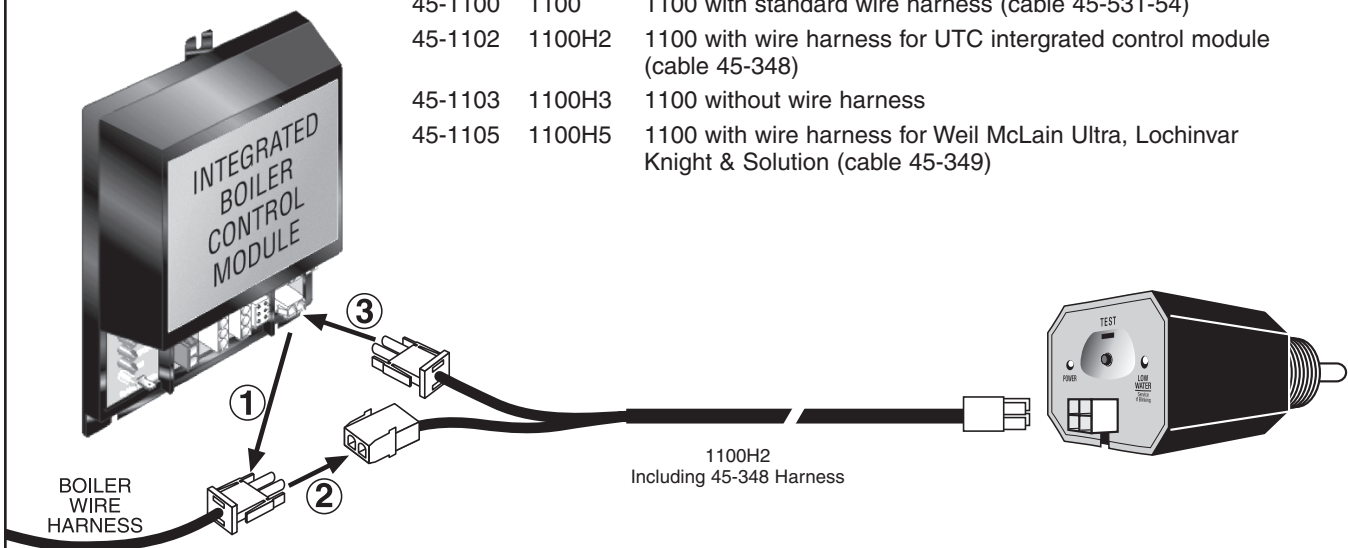

Note: Wire Harnesses are also sold separately (use cable part numbers above)

OPERATIONAL TEST PROCEDURE

IMPORTANT: Do not run boiler unattended until the following procedure is completed

1. Before raising the water level above the Model 1100, turn on power to the boiler and set the thermostat to call for heat. Both the green "POWER" LED and amber "LOW WATER" LED should illuminate. The burner should not fire. IMPORTANT: If the burner fires with no water at the probe, immediately shut down power to the boiler and refer to the Trouble Shooting instructions below.
2. Proceed to fill the boiler with water. When water reaches the LWCO position, the burner should fire. If the burner does not fire, refer to the Trouble Shooting instructions below.
3. Turn off the power to the boiler and finish filling the system.
4. Before leaving the job, power up the system and push the TEST button on the Model 1100 to simulate a low water condition. The amber "LOW WATER" LED should illuminate and the burner should shut down.

SERVICE & MAINTENANCE

- EVERY YEAR** Check control operation annually by pressing the TEST button. The amber "LOW WATER" LED should illuminate and the burner should shut down.
- 5 YEARS** Remove the low water cut-off every five years and clean all surfaces in contact with water.
- IF AMBER LED IS BLINKING** If the amber "LOW WATER" LED is blinking, the control should be removed and all surfaces in contact with water should be cleaned. The blinking LED indicates that the sensor may be getting coated with oil or other residues in the system. If left unchecked, this could result in a nuisance low water shutdown.

TROUBLE SHOOTING

IF THE BURNER DOES NOT SHUT DOWN

(when water is below the probe or when the TEST button is pressed)

1. Turn off boiler power immediately and re-check wiring.
2. Turn off boiler power and drain system. Remove low water cut-off and check for adequate clearance – no metal should be in contact with the control's metal probe tip.

IF THE BURNER DOES NOT FIRE

1. Make sure water has reached the level of the control.
2. Check green wire for proper ground. Make sure the wire is attached to an unpainted surface that is electrically common to the boiler.
3. Check to ensure the control's metal probe tip is not surrounded by an air pocket. Shut down power to the boiler and slowly loosen, but do not remove, the control. Allow any air to escape. When water begins to seep past threads, retighten the control.
4. Re-check wiring and check for correct incoming voltage.

DIMENSIONS

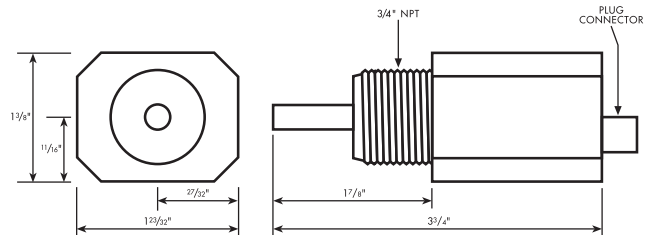

SPECIFICATIONS

VOLTAGE	24 VAC
POWER CONSUMPTION	1 VA
SWITCHING CAPACITY	50 VA
MAX LOAD	5 Amps
MAX PRESSURE	160 PSI (11.25 kg/cm ²)
MAX WATER TEMPERATURE	250°F (121°C)
MAX AMBIENT TEMPERATURE	170°F (77°C)



LIMITED MANUFACTURER'S WARRANTY

We warrant products manufactured by Hydrolevel Company to be free from defects in material and workmanship for a period of two years from the date of manufacture or one year from the date of installation, whichever occurs first. In the event of any claim under this warranty or otherwise with respect to our products which is made within such period, we will, at our option, repair or replace such products or refund the purchase price paid to us by you for such products. In no event shall

Hydrolevel Company be liable for any other loss or damage, whether direct, indirect, incidental or consequential. This warranty is your EXCLUSIVE remedy and shall be IN PLACE OF any other warranty or guarantee, express or implied, including, without limitation, any warranty of MERCHANTABILITY or fitness for a particular purpose. This warranty may not be assigned or transferred and any unauthorized transfer or assignment thereof shall be void and of no force or effect.

**HYDROLEVEL
COMPANY**

126 Bailey Road, North Haven, CT 06473 • Phone (203) 776-0473 • FAX (203) 764-1711 • www.hydrolevel.com