



SUBMITTAL

(Current Revisions for All Standards Apply)



C153 Mechanical Joint Compact Fittings

SIZES: 3" through 48"

MATERIAL: Ductile Iron ASTM A536

PRESSURE: 350 PSI rating for 3"-24", 250 PSI rating for 30"-48"

TESTING: In accordance with ANSI/ AWWA C153/A21.53 and UL requirements

LAYING LENGTH: In accordance with ANSI/ AWWA C153/A21.53

CEMENT LINING: In accordance with ANSI/AWWA C104/A21.4

COATING: In accordance with ANSI/AWWA C104/A21.4 ASPHALTIC SEAL COATED IN & OUT

GASKET: SBR in accordance with ANSI / AWWA C111 / A21.11

STANDARDS: ANSI / AWWA C153 / A21.53 UL Listed

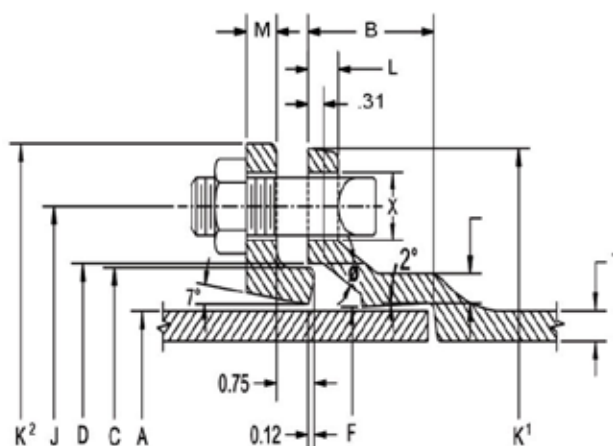

Size	Mechanical Joint Dimensions													Bolts	
	A Dia.	B	C Dia.	D Dia.	F Dia.	J Dia.	K ¹ Dia.	K ² Dia.	L	M	S	T	X	Size	No.
3	3.96	2.50	4.84	4.94	4.06	6.19	7.62	7.69	.58	.62	.39	.33	¾	5/8x3	4
4	4.80	2.50	5.92	6.02	4.90	7.50	9.06	9.12	.60	.75	.39	.34	7/8	3/4x3 ½	4
6	6.90	2.50	8.02	8.12	7.00	9.50	11.06	11.12	.63	.88	.43	.36	7/8	3/4x3 ½	6
8	9.05	2.50	10.17	10.27	9.15	11.75	13.31	13.37	.66	1.00	.45	.38	7/8	3/4x4	6
10	11.10	2.50	12.22	12.34	11.20	14.00	15.62	15.62	.70	1.00	.47	.40	7/8	3/4x4	8
12	13.20	2.50	14.32	14.44	13.30	16.25	17.88	17.88	.73	1.00	.49	.42	7/8	3/4x4	8
14	15.30	3.50	16.40	16.54	15.44	18.75	20.31	20.25	.79	1.25	.55	.47	7/8	3/4x4 ½	10
16	17.40	3.50	18.50	18.64	17.54	21.00	22.56	22.50	.85	1.31	.58	.50	7/8	3/4x4 ½	12
18	19.50	3.50	20.60	20.74	19.64	23.25	24.83	24.75	1.00	1.38	.68	.54	7/8	3/4x4 ½	12
20	21.60	3.50	22.70	22.84	21.74	25.50	27.08	27.00	1.02	1.44	.69	.57	7/8	3/4x4 ½	14
24	25.80	3.50	26.90	27.04	25.94	30.00	31.58	31.50	1.02	1.56	.75	.61	7/8	3/4x5	16
30	32.00	4.00	33.29	33.46	32.17	36.88	39.12	39.12	1.31	2.00	.82	.66	1 1/8	1x6	20
36	38.30	4.00	39.59	39.76	38.47	43.75	46.00	46.00	1.45	2.00	1.00	.74	1 1/8	1x6	24
42	44.50	4.00	45.79	45.96	44.67	50.62	53.12	53.12	1.45	2.00	1.25	.82	1 3/8	1 1/4x6 ½	28
48	50.80	4.00	52.09	52.26	50.97	57.50	60.00	60.00	1.45	2.00	1.35	.90	1 3/8	1 1/4x6 ½	32

Mechanical Joint Bends C153
Class 350 (4"-36")
Class 250 (42"-48")

MJ x MJ

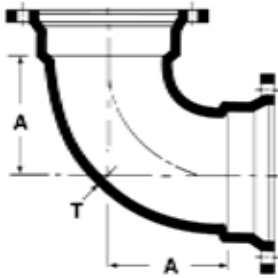

90 ° Bend

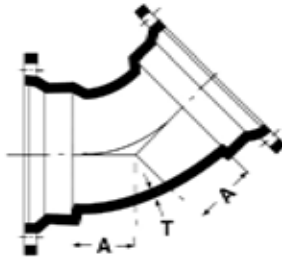

45 ° Bend

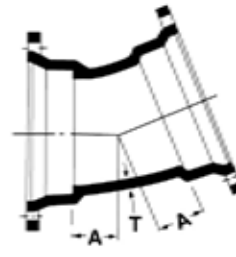

22 ½ ° Bend

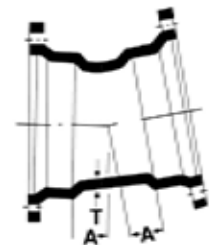

11 ¼ ° Bend

Fitting Size (in.)	T _{nominal}	90°	45°	22 ½°	11 ¼°	90°	45°	22 ½°	11 ¼°
		"A" Dimension (in.)				Weight (lbs.)			
4"	0.34	4.00	2.00	1.50	1.25	25	22	18	16
6"	0.36	5.00	3.00	2.00	1.50	39	32	31	30
8"	0.38	6.50	3.50	2.50	1.75	57	46	46	42
10"	0.40	7.50	4.50	3.00	2.00	89	70	64	58
12"	0.42	9.00	5.50	3.50	2.25	108	86	80	67
14"	0.47	11.50	5.00	3.75	2.50	210	160	136	93
16"	0.50	12.50	5.50	3.75	2.50	264	202	172	148
18"	0.54	14.00	6.00	4.50	3.00	335	250	255	205
20"	0.57	15.00	7.00	4.50	3.00	400	305	310	245
24"	0.61	16.75	7.50	4.50	3.00	565	405	412	315
30"	0.66	21.50	10.50	6.75	4.75	930	780	665	600
36"	0.74	24.50	11.50	7.75	5.00	1450	1135	960	820
42"	0.82	29.25	14.00	9.00	6.00	2205	1610	1350	1180
48"	0.90	33.25	15.00	10.00	6.50	2990	2090	1760	1475

Weight shown is the approximate weight for fittings with minimum "A" dimension.

Weight does not include cement lining or accessories.

PROTECTO 401

Gray iron pipe preceded Ductile Iron pipe by well over 100 years. Its intended use was to convey water as well as wastewater. Continuous tests and field experience have brought the production and use of Ductile Iron pipe to maturity. It has replaced gray iron pipe in practically all applications. Ductile Iron is a high-strength, tough material used in water and sewer systems in all states within the U.S. and in many other areas of the world. Because of this inherent strength, U.S. Ductile Iron pipe is ideally suited to deep buries prevalent in gravity sewer systems. In addition to the elimination of infiltration/exfiltration, TR FLEX® Pipe and Fittings and FIELD LOK 350® Gaskets used with TYTON JOINT® Pipe will provide restraint to prevent joint separation.

U.S. Pipe's PROTECTO 401 Lined Ductile Iron Pipe and Fittings provide excellent protection and the strength necessary to do the job in tough sewer pipe applications. PROTECTO 401 has been successfully used in thousands of sanitary sewer applications and has been proven with both laboratory testing and two decades of actual sewer service on all sizes of Ductile Iron pipe and fittings.

PROTECTO 401 Ceramic Epoxy Lining was designed specifically for protection of Ductile Iron for sanitary sewer service by providing a reliability similar to cement mortar lining in drinking water service but having the excellent chemical resistance of a novalac epoxy for septic sewer service. Easily recognized brownish red bells and spigots, as well as stenciling showing "for sewer only", ensure that the correct lined pipe is used for sewer service. This concentration of design and formulation effort has resulted in a Ductile Iron pipe lining system with excellent durability, resistance to undercutting, and resistance to chemical attack.

PROTECTO 401 Ceramic Epoxy Lined Ductile Iron Pipe may be diametrically deflected up to 5% without damage to either the pipe or the lining



TR FLEX® & FIELD LOK 350® are Registered Trademarks of U.S. Pipe and Foundry Company.

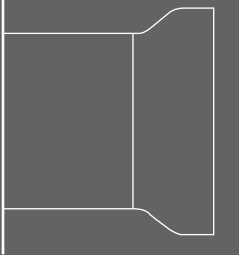

PROTECTO 401 (CONT.)

PROTECTO 401 Has Been Tested and Withstood the Following:

Salt Spray

Two years with no undercutting on a scribed Ductile Iron panel when measured using ASTM B 117 and when rated using ASTM D 714 evaluating degrees of blistering.

20% Sulfuric Acid

Two years with no effect when rated using ASTM D 714 evaluating degree of blistering.

25% Sodium Hydroxide Immersion

At 140°F two years with no effect when rated using ASTM D 714 evaluating degree of blistering.

Distilled Water Immersion

At 160°F two years with no effect when rated using ASTM D 714 evaluating degree of blistering.

Abrasion Resistance

Less than .075mm (3 mils) loss after one million cycles on a plus 22.5° to minus 22.5° sliding aggregate slurry abrasion tester using a sharp natural siliceous gravel with a particle size between 2 mm and 10 mm. This text conforms with European Standard EN598, Section 7.8.

PROTECTO 401 is also resistant to a wide range of oils, greases, solvents, detergents and fuels which may be introduced into a sewer line.

PROTECTO 401 is applied to the interior of Ductile Iron pipe and fittings utilizing specialized application equipment and a stringent specification. The lining is designed to be applied at a nominal 40 mils thickness. A non-destructive pinhole detection test and a thickness test are performed to ensure a sound, chemically resistant protective lining for U.S. Pipe's Ductile Iron pipe and fittings.

PROTECTO 401 is intended for use in domestic sanitary sewage lines. Chemical injection for odor control may damage pipe, gaskets and/or protective linings. Requests for individual recommendations for industrial sewer applications of PROTECTO 401 Lined Pipe and Fittings should be made to a U.S. Pipe Sales Representative.

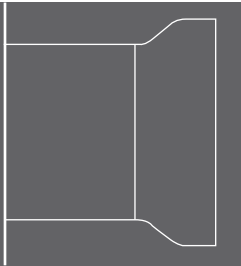

PROTECTO 401™

2017 EDITION

P 5

SUGGESTED SPECIFICATION FOR PROTECTO 401 INTERIOR LINING FOR DUCTILE IRON PIPE AND FITTINGS

I. Condition of Ductile Iron Prior to Surface Preparation

All Ductile Iron pipe and fittings shall be delivered to the application facility without asphalt, cement lining, or any other lining on the interior surface. Because complete removal of old linings may not be possible, the intent of this specification is that the entire interior of the Ductile Iron pipe and fittings shall not have been lined with any substance prior to the application of the specified lining material and no coating shall have been applied to the first six inches of the exterior of the spigot ends.

II. Lining Material

The standard of quality is PROTECTO 401 Ceramic Epoxy. The material shall be an amine cured novalac epoxy containing at least 20% by volume of ceramic quartz pigment. Any request for substitution must be accompanied by a successful history of lining pipe and fittings for sewer service, a test report verifying the following properties and a certification of the test results.

- A. A permeability rating of 0.00 when tested according to the procedure described in Method A of ASTM 96, Procedure A with a test duration of 30 days.
- B. The following tests must be run on coupons from factory-lined Ductile Iron pipe.
 - 1. **ASTM B 117 Salt Spray (scribed panel)**
Results to equal 0.0 undercutting after two years.
 - 2. **ASTM G 95 Cathodic Disbondment (1.5 volts at 77°F)**
Results to equal no more than 0.5 mm undercutting after 30 days.
 - 3. **Immersion Testing**
Rated using ASTM D 714.
 - a. **20% Sulfuric Acid**
No effect after two years.
 - b. **140°F 25% Sodium Hydroxide**
No effect after two years.
 - c. **160°F Distilled Water (scribed panel)**
No effect after two years.
 - d. **120°F Tap Water (scribed panel)**
0.0 undercutting after two years with no effect.

C. Abrasion Resistance

Less than .075 mm (3 mils) loss after one million cycles on a $\pm 22.5^\circ$ sliding aggregate slurry abrasion tester using a sharp natural siliceous gravel with a particle size between 2 mm and 10 mm (European Standard SN598).

*TR FLEX® & FIELD LOK 350® are Registered
Trademarks of U.S. Pipe and Foundry Company.*

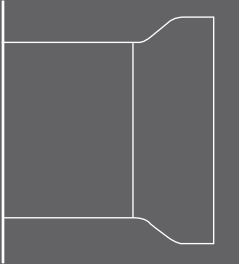

SUGGESTED SPECIFICATION FOR PROTECTO 401 INTERIOR LINING FOR DUCTILE IRON PIPE AND FITTINGS (CONT.)

III. Application

A. Applicator

The lining shall be applied by a certified firm with a successful history of applying linings to the interior of Ductile Iron pipe and fittings.

B. Surface Preparation

Prior to abrasive blasting, the entire area to receive the protective compound shall be inspected for oil, grease, etc. Any areas where oil or grease is present, or any substance which can be removed by solvent, shall be solvent cleaned to remove these substances. After the surface has been made free of grease, oil or other substances, all areas to receive the protective compounds shall be abrasive blasted using compressed air nozzles with sand or grit abrasive material. The entire surface to be lined shall be struck with the blast media so that all rust, loose oxides, etc., are removed from the surface. Only slight stains and tightly adhering oxide may be left on the surface. Any area where rust reappears before lining must be reblasted.

C. Lining

After surface preparation, the interior of the pipe shall receive 40 mils nominal dry film thickness of PROTECTO 401. No lining shall be applied when the substrate or ambient temperature is below 40°F. The surface also must be dry and dust free. If flange pipe or fittings are included in the project, the lining shall not be used on the face of the flange.

D. Coating of Bell Sockets and Spigot Ends

Due to the tolerances involved, bell interior and spigot exterior up to 6 inches back from the end of the spigot end must be coated with 6 mils nominal, 10 mils maximum PROTECTO Joint Compound. The Joint Compound shall be applied by brush to ensure coverage. Care should be taken that the Joint Compound is smooth without excess buildup in the gasket seat or on the spigot ends. Coating of the gasket seat and spigot ends shall be done after the application of the linings.

E. Number of Coats

The number of coats of lining material applied shall be as recommended by the lining manufacturer. However, in no case shall this material be applied above the dry thickness per coat recommended by the lining manufacturer in printed literature. The maximum or minimum time between coats shall be that time recommended by the lining material manufacturer. No material shall be used for lining which is not indefinitely recoatable with itself without roughening of the surface.

F. Touch-Up & Repair

PROTECTO Joint Compound shall be used for touch-up or repair in accordance with manufacturer's recommendations.

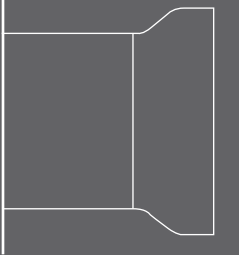

SUGGESTED SPECIFICATION FOR PROTECTO 401 INTERIOR LINING FOR DUCTILE IRON PIPE AND FITTINGS (CONT.)

G. High Pressure Cleaning

Guidelines for Pressure Cleaning the Internal Diameter of Ductile Iron Pipe

The Ductile Iron Pipe Research Association (and its Member Companies), Federal Signal Corporation (and its subsidiaries Vactor, Elgin, Guzzler, Jetstream & Ravo), and Induron Coatings Inc. participated in a pressure cleaning research program that was conducted by the Missouri University of Science and Technology – High Pressure Waterjet Laboratory.

The test program included asphaltic seal coated cement-mortar lined and Protecto 401 lined Ductile Iron pipe which resulted in guidelines for the pressure cleaning of the inside diameters of Ductile Iron pipe. Through a collaborative effort with the organizations above and the City of Moline, Illinois, field tests were conducted and the guidelines verified as effective and safe for cement-mortar and Protecto 401 lined ductile iron pipe.

Guidelines are as follows:

1. The nozzle shall be configured with fan jets only (no round jets).
2. The fan jets should be oriented at a maximum angle of 30 degrees to the pipe wall.
3. The nozzle shall be a minimum of 2 inches standoff from the pipe surface.
4. The nozzle assembly shall be self-rotating and incorporate a rotational control mechanism - target speed of 30 rpm.
5. The water pressure at the nozzles shall be no more than 2,500 psi.
6. The nozzle assembly shall have non-abrasive wheels and/or UHMW (ultra-high molecular weight) polyethylene skids positioned so that at no time does the nozzle assembly contact the lining of the pipe.
7. The nozzle assembly shall continually move when pressure washing with no hesitation in the pipe.
8. All hose couplings, hoses, etc. shall be smooth so as to facilitate movement across the pipe joints without creating damage to the lining.

Pipe diameters of 24-inch and larger may require additional passes for effective cleaning.

Vactor Blue Twister Nozzle (or equal) and appropriate assembly

Although research shows no significant damage in testing, the decision to pressure wash, if made by the customer, engineer, or installer, may present some risk of damage to the Protecto 401.

Any such risk is dependent on water pressure, speed, jet design and angle to the lining, distance of the jet from the lining, type of lining, and other factors. DIPRA does not warrant or guarantee the result or assume any risk associated with pressure washing.

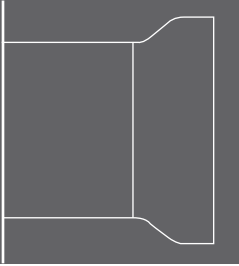

SUGGESTED SPECIFICATION FOR PROTECTO 401 INTERIOR LINING FOR DUCTILE IRON PIPE AND FITTINGS (CONT.)

IV. Inspection And Certification

A. Inspection

1. All Ductile Iron pipe and fitting linings shall be checked for thickness using a magnetic film thickness gauge. The thickness testing shall be done using the method outlined in SSPC PA-2 Film Thickness Rating.
2. The interior lining of all pipe and barrels and fittings shall be tested for pinholes with a nondestructive 2,500 volt test. Any defects found shall be repaired prior to shipment.
3. Each pipe joint and fitting shall be marked with the date of application of the lining system along with its numerical sequence of application on that date and records maintained by the applicator of his work.

B. Certification

The pipe or fitting manufacturer must supply a certificate attesting to the fact that the applicator met the requirements of this specification and that the material used was as specified.

C. Handling

PROTECTO 401 Lined Pipe and Fittings must be handled only from the outside of the pipe and fittings. No forks, chains, straps, hooks, etc. shall be placed inside the pipe and fittings for lifting, positioning or laying.