

Installation Support • Soporte de instalación • Support d'installation

Personal Assistance, Product Specs, & "How-to" Questions:

Asistencia personal, especificaciones del producto y preguntas sobre "cómo hacerlo":

Aide personnelle, spécifications du produit et questions « pratique-pratiques » :

1-800-PFAUCET (732-8238)

pfisterfaucets.com/support

Installation Videos Available
Videos de instalación a disposición
Vidéos d'installation disponibles



pfisterfaucets.com/videos

▲ WARNING / AVERTENCIA / AVERTISSEMENT

To reduce the risk of injury or property damage, read all instructions before installing product. Wear safety goggles. Product must be installed in accordance with all state & local plumbing & building codes. Call a professional if you are uncertain about installing this product.

Para disminuir el riesgo de lesiones o daños a la propiedad, lea todas las instrucciones antes de instalar el producto. Utilice gafas de seguridad. El producto deberá instalarse de acuerdo con la normativa de plomería y construcción estatal y local. Llame a un profesional si no está seguro sobre cómo instalar este producto.

Pour réduire le risque de blessures ou de dommages, lire toutes les instructions avant d'installer l'appareil. Porter des lunettes de sécurité. Il faut installer l'appareil en respectant tous les codes de construction et de plomberie locaux et d'État. Appelez un professionnel si vous n'êtes pas certain de la façon d'installer cet appareil.

**Required Tools
Herramientas necesarias
Outils nécessaires**



Channel Lock
Bloqueo de Canal
Blocage des Canaux



Safety Goggles
Anteojos de seguridad
Lunettes de sûreté



PTFE plumber's tape
Cinta para plomería PTFE
Ruban PTFE de plombier

**Additional Helpful Tools
Otras herramientas útiles
Outils supplémentaires utiles**

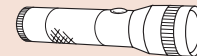

Flashlight
Linterna
Lampe-torche



Cloth
Paño de limpieza
Chiffon

**Parts in the Box
Piezas en la caja
Pièces dans la boîte**

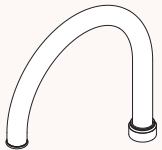

A



C



D



E (x2)

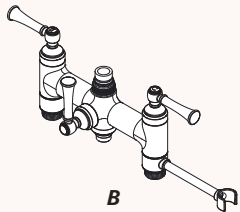

B

Note: Your box will contain one of the below
Nota: El cuadro contendrá uno de los siguientes
Remarque: Votre boîte contiendra un des ci-dessous

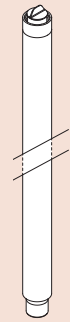

LG6-1TB
F1 (x2)

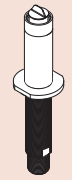

LG6-2TB
F2 (x2)



LG6-3TB
F3 (x2)



LG6-2TB
F2a (x2)



LG6-2TB
F2b (x2)



Strap Wrench
Llave de correa
Clé à sangle

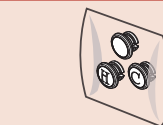

Optional Ceramic Cap
(refer to included Flyer)
Cubierta de Cerámica opcional
(refiere al folleto incluido)
Couverture Céramique option
(voir petit livret inclus)

OX6-340R and 931-132 sold separately
OX6-340R o 931-132 Válvula se vende por separado
OX6-340R ou 931-132 Valve vendu séparément

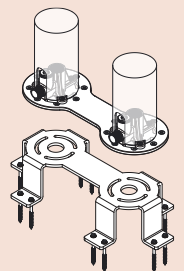

Optional Extension Kit
Kit de extensión opcional
Kit d'extension option

Order • Orden • Commande
910-065*

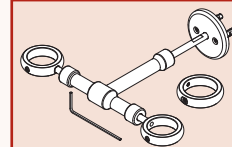

Optional Support Kit
Kit de soporte opcional
Kit de support option

Order • Orden • Commande
931-133*

1 Turn Off Water Supply • Cierre el suministro de agua • Couper l'alimentation en eau

Locate the water supply inlets & shut off the water supply valves. These are usually found near the water meter. If you are replacing an existing unit, remove the old unit & clean mounting surface thoroughly.

Ubique las entradas del suministro de agua y cierre las válvulas de suministro. Estas se encuentran generalmente cerca del medidor de agua. Si reemplaza una unidad existente, retírela y limpie completamente la superficie de montaje.

Repérez les entrées d'alimentation d'eau et fermez les robinets d'arrêt. Ils sont normalement trouvés près du compteur d'eau. Si vous remplacez un appareil existant, enlevez le vieil appareil et nettoyez soigneusement la surface de montage.

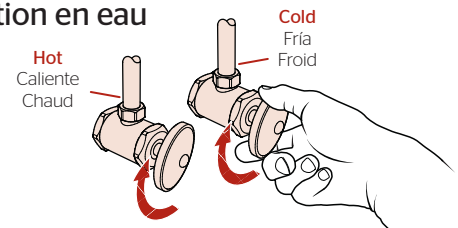

Installation of LG6-1TB: Floor Mount. For LG6-2TB proceed to Page 4. For LG6-3TB proceed to Page 5.

La instalación de LG6-1TB: Montaje del Piso. Para LG6-2TB proceder a la página 4. Para LG6-3TB proceder a la página 5.

Installation LG6-1TB: Monter le plancher. Pour LG6-2TB procéder à la page 4. Pour LG6-3TB procéder à la page 5

2 Spout Orientation

Prepare la tubería empotrada y configure la rotación del vástago

Préparez la plomberie brute et réglez la rotation

Pick where Faucet will be installed

Recogida en donde se instalará el grifo

Choisissez où le robinet sera installé

A (in inches)	B (in inches)
3	37-1/2
3-1/2	37
4	36-1/2
4-1/2	36
5	35-1/2
5-1/2	35
6	34

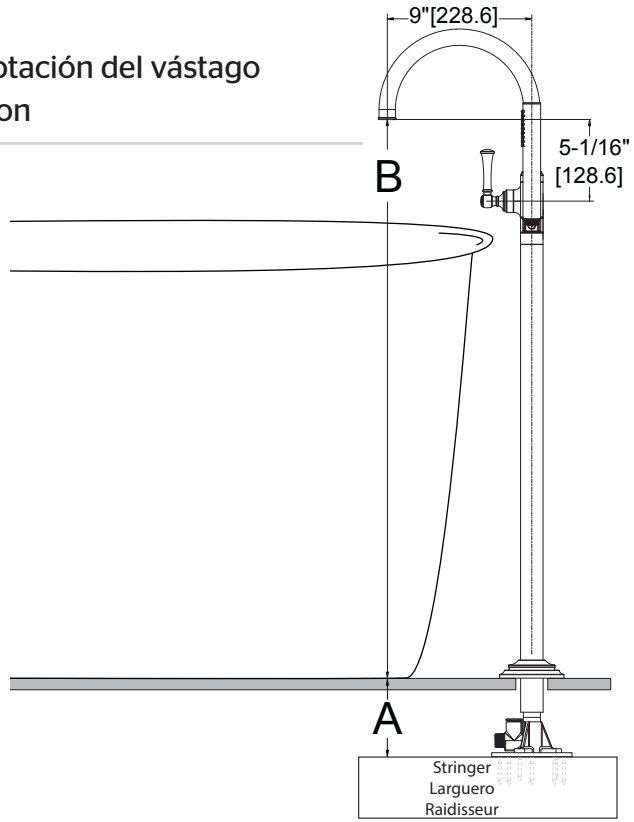

3 Prepare the Valve

Instale la Válvula

Installez la Soupape



PTFE plumber's tape
Cinta para plomería PTFE
Ruban PTFE de plombier

OX6-340R and 931-132 sold separately
OX6-340R o 931-132 Válvula se vende por separado
OX6-340R ou 931-132 Valve vendu séparément

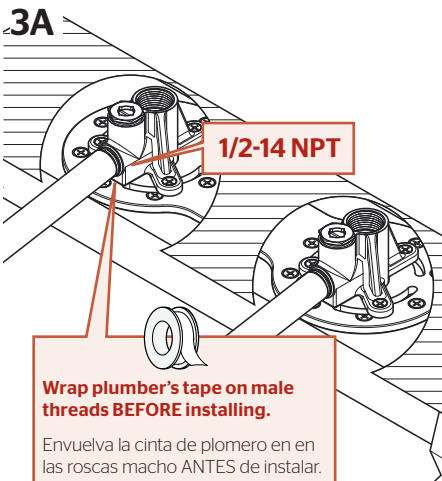
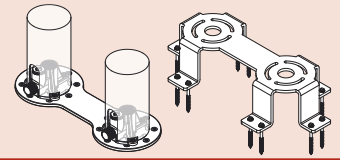

Wrap plumber's tape on male threads BEFORE installing.

Envuelva la cinta de plomero en en las roscas macho ANTES de instalar.

Enveloppez le ruban de plombier sur les filets mâles AVANT d'installer.

3A

For deep concrete application

Para aplicaciones concretas profundas
Pour application concrète profonde

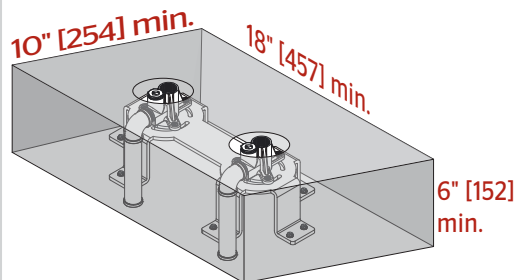

OX6-340R and 931-132 required
OX6-340R y 931-132 requerido
OX6-340R et 931-132 requis

3A

For shallow concrete or wood application

Para aplicaciones concretas o madera fina
Pour application concrète ou bois mince

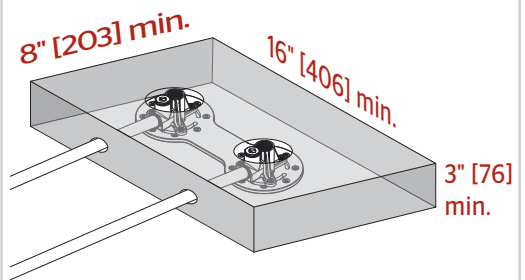

OX6-340R required
OX6-340R requerido
OX6-340R requis

4

Install Risers

Instale el Risers

Installez les Risers



Channel Lock
Bloqueo de Canal
Blocage des Canaux



PTFE plumber's tape
Cinta para plomería PTFE
Ruban PTFE de plombier



E (x2)



F1 (x2)

OX6-340R and 931-132 sold separately
OX6-340R o 931-132 Válvula se vende por separado
OX6-340R ou 931-132 Valve vendu séparément

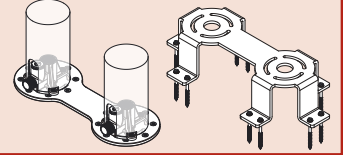

4A

F1

Use Wrench no more than 1" above finished floor.

Use la llave no más de 25.4 mm encima del piso terminado.

Utiliser une clé d'au plus 25.4 mm au-dessus du plancher fini.

E

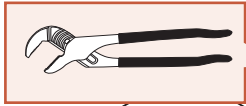

4B

For additional support order the Support Kit 931-133*

Para obtener soporte adicional, orden el Kit de Soporte 931-133*

Pour support supplémentaire, commander Kit de support 931-133*

Proceed to Step 7A.

Proceda con el paso 7A.

Passez à l'étape 7A.

Installation of LG6-2TB: Deck Mount. For LG6-3TB proceed to Step 5.

La instalación de LG6-2TB: Cubierta de Monte. Para LG6-3TB proceder a la página 5.

Installation LG6-2TB: Pont du Mont. Pour LG6-3TB procéder à la page 5

5 Install Risers

Instale el Risers

Installez les Risers



Channel Lock
Bloqueo de Canal
Blocage des Canaux



E (x2)



F2 (x2)



F2a (x2)



F2b (x2)

5A

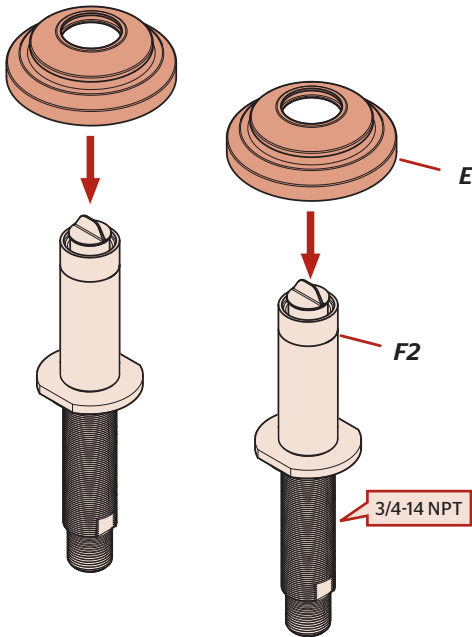

5C

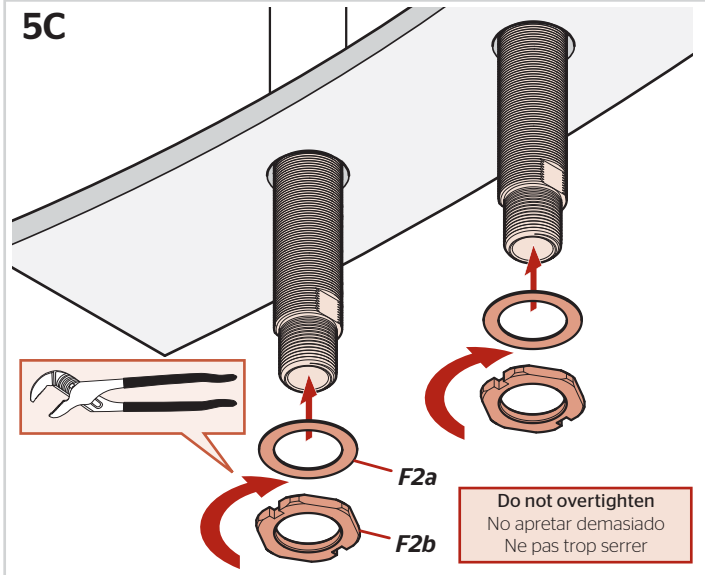

5B

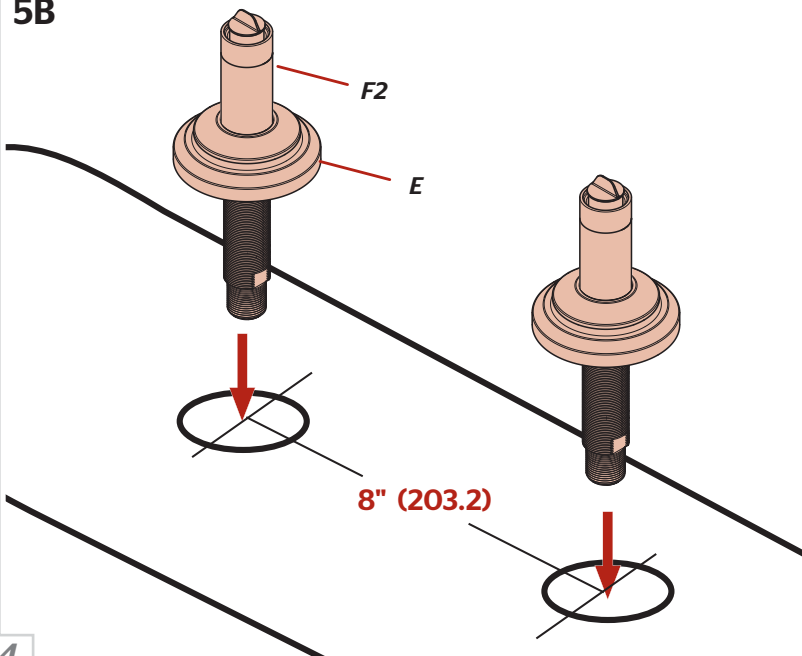

Connect into water supply line (not included) and secure per manufacturer's instructions.
Conectarse a la línea de suministro de agua (no incluido) y seguro según las instrucciones del fabricante.
Connectez dans la ligne d'alimentation en eau (non inclus) et sécurisé selon les instructions du fabricant.

Proceed to Step 7A.

Proceda con el paso 7A.

Passez à l'étape 7A.

Installation of LG6-3TB: Wall Mount

La instalación de LG6-3TB: Montaje en pared

Installation LG6-3TB: Montage mural

6 Install Risers

Instale el Risers

Installez les Risers



Channel Lock
Bloqueo de Canal
Blocage des Canaux



PTFE plumber's tape
Cinta para plomería PTFE
Ruban PTFE de plombier



E (x2)

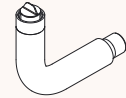

F3 (X2)

6A

Connect into water supply line

Conectarse a la línea de suministro de agua
Connectez dans la ligne d'alimentation en eau

Ensure supply lines are securely fastened

Asegúrese de que las líneas de suministro estén firmemente sujetas
Assurez-vous que les conduites d'alimentation sont fermement fixées

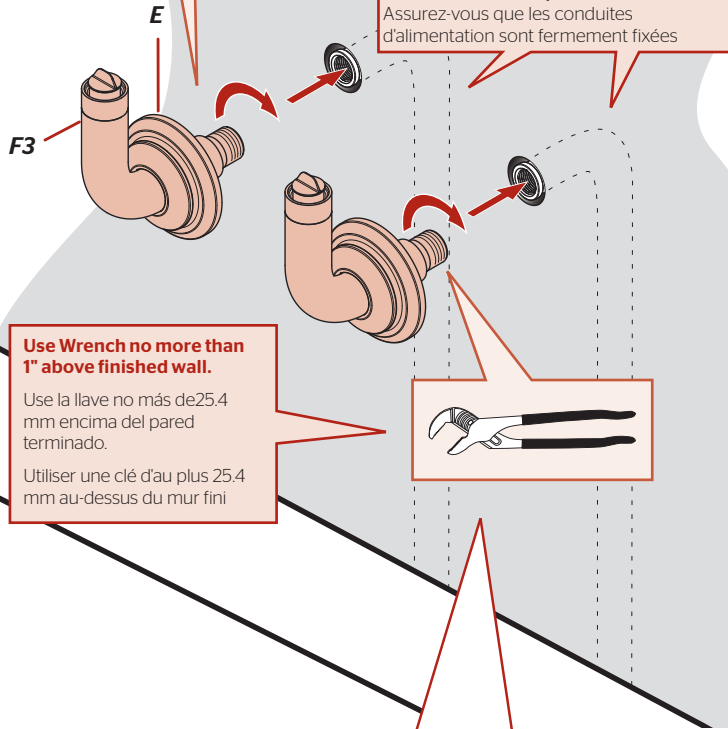

Use Wrench no more than 1" above finished wall.

Use la llave no más de 25.4 mm encima del pared terminado.

Utiliser une clé d'au plus 25.4 mm au-dessus du mur fini

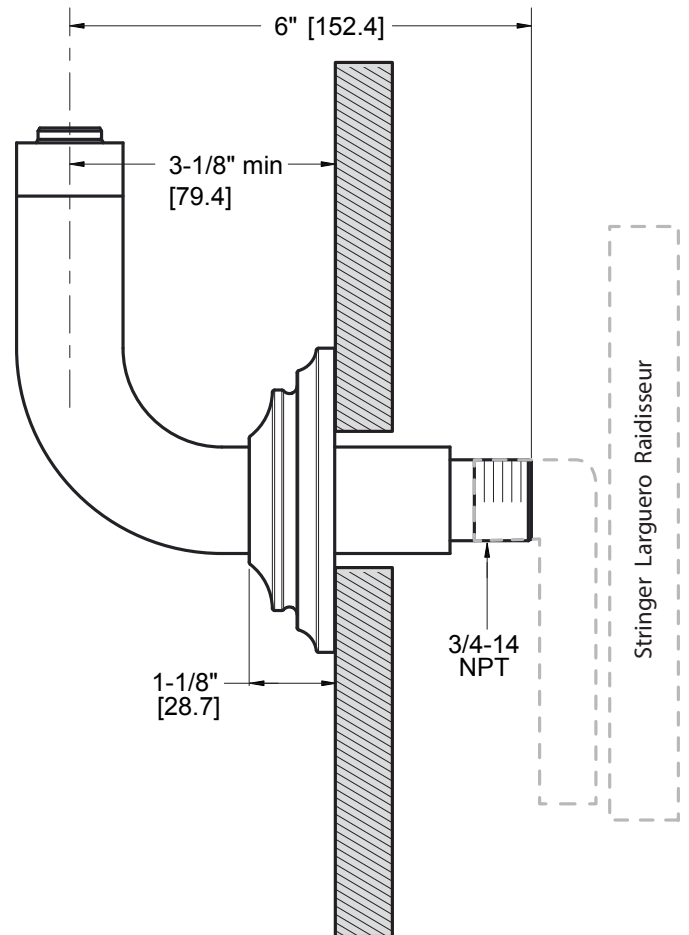

6B

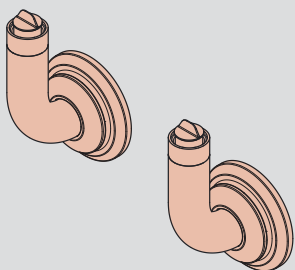

Proceed to Step 7C.

Proceda con el paso 7C.

Passez à l'étape 7C.

7

Install Spout

Instale el surtidor

Installer le bec



Strap Wrench
Llave de correa
Clé à sangle

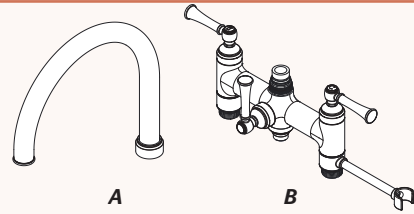

7A

Floor Mount and Deck Mount

Montaje del Piso y Cubierta de Monte

Monter le plancher et Pont du Mont

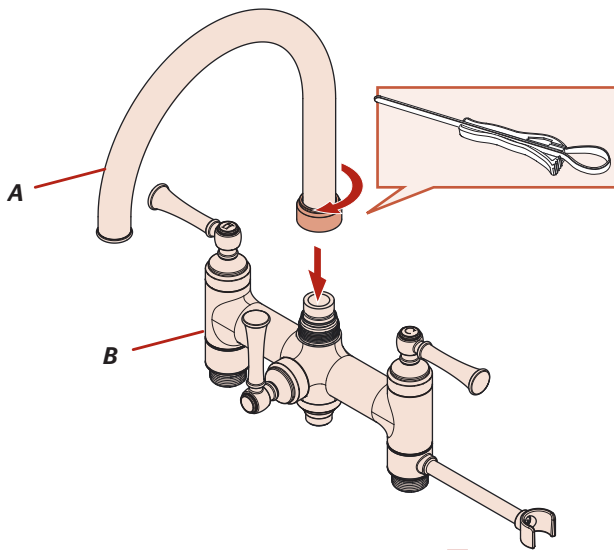

7A

Wall Mount

Montaje en pared

Montage mural

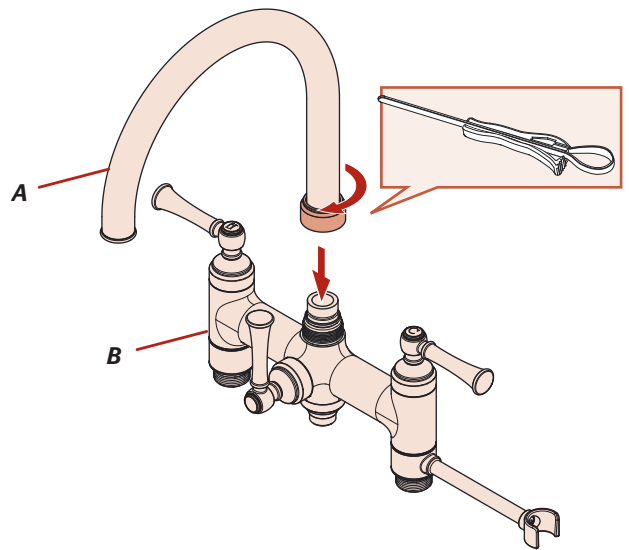

7B

Extension Kit 910-065 offers an additional 4" if spout height is too low.

Kit de Extensión de 910-065 ofrece un adicional de 4" Si la altura del pico es demasiado baja.

910-065 kit d'extension offre 4" Si la hauteur du bec est trop basse.

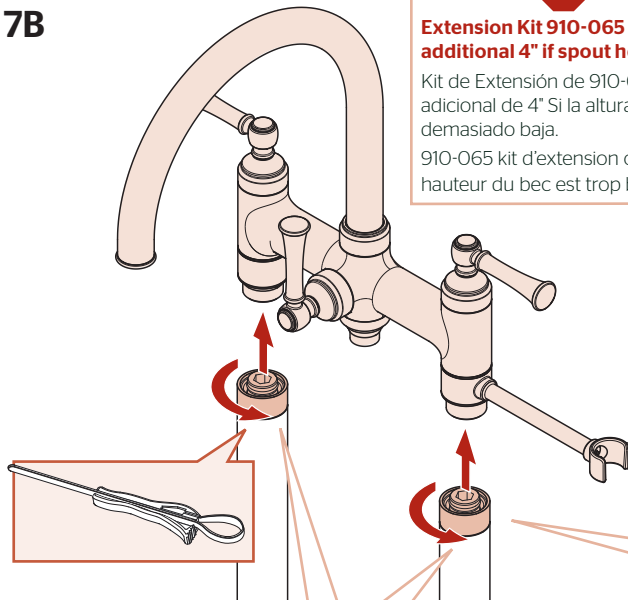

Hand tighten both nuts simultaneously then use strap wrench for final tightening

Apriete a mano ambas tuercas simultáneamente y luego use la llave de la correa para el apriete final

Serrer à la main les deux écrous simultanément puis utiliser la clé à sangle pour le serrage final

Trash
Basura
Poubelle



7B

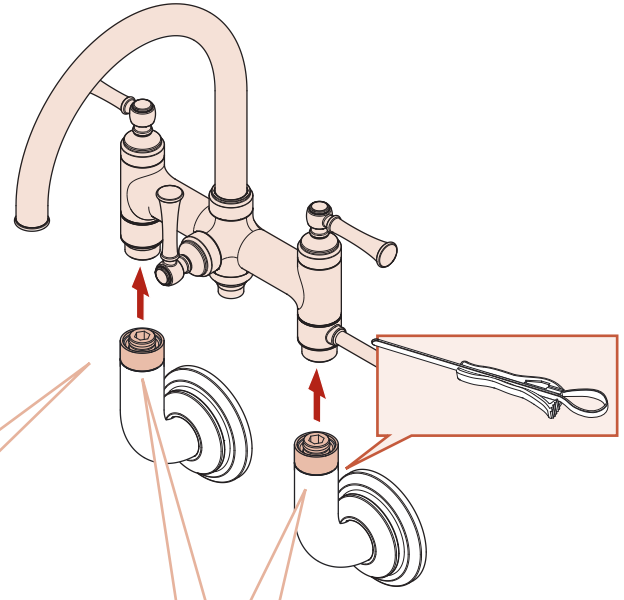

Hand tighten both nuts simultaneously then use strap wrench for final tightening

Apriete a mano ambas tuercas simultáneamente y luego use la llave de la correa para el apriete final

Serrer à la main les deux écrous simultanément puis utiliser la clé à sangle pour le serrage final

8

Install Hand shower

Instale la ducha de mano

Installez la douchette

No Tools Required for This Step
No se necesitan herramientas para este paso
Aucun outil n'est nécessaire pour cette étape



D



C

8A

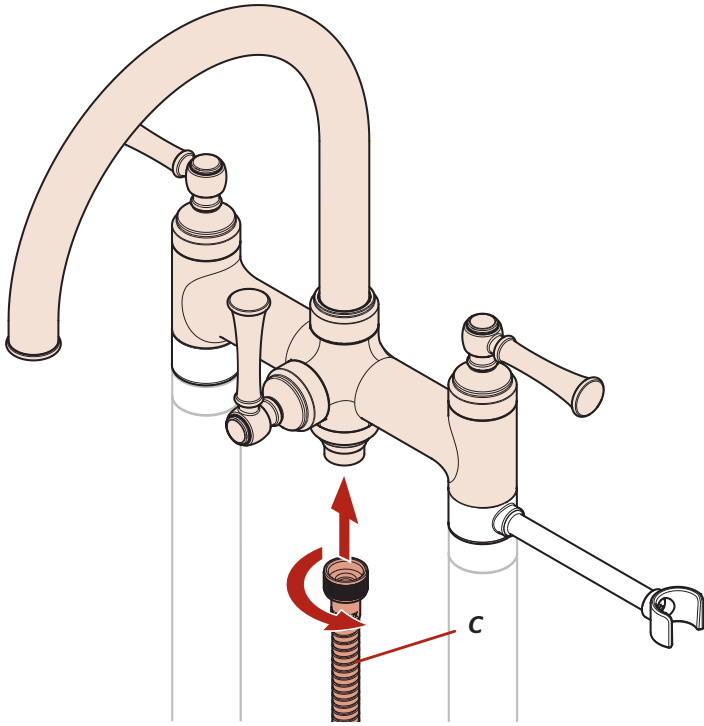

8C

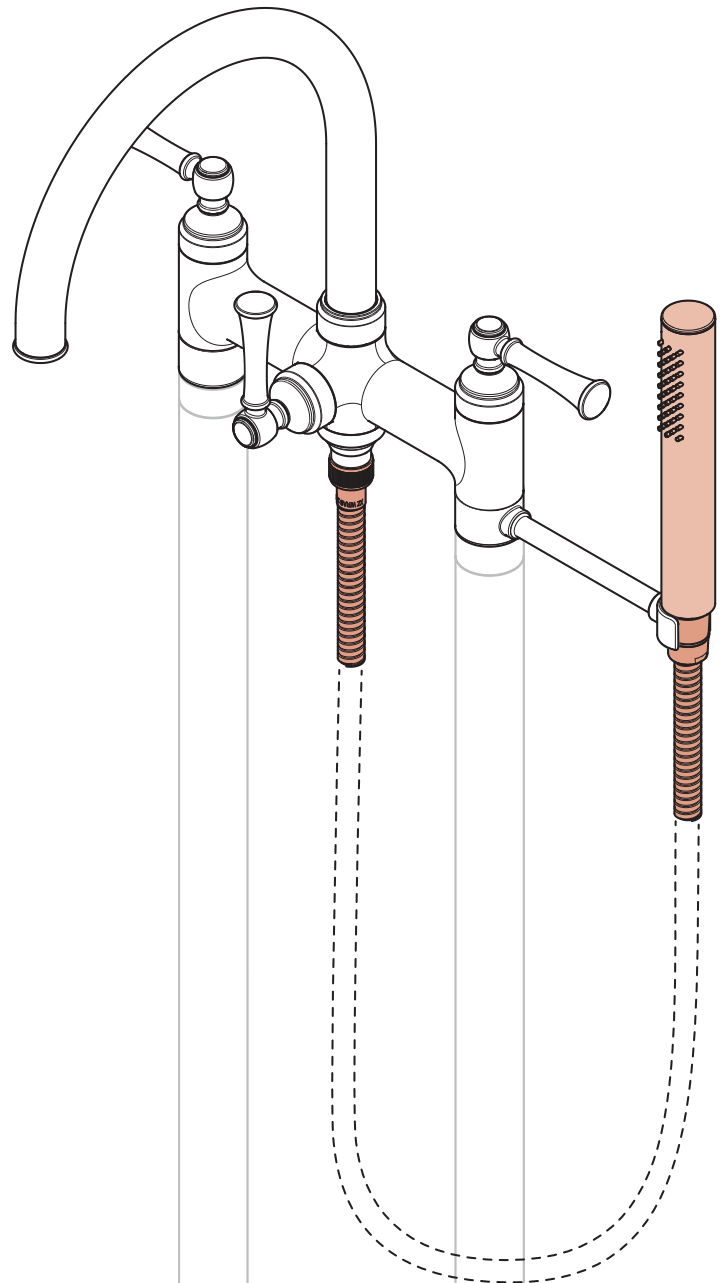

8B

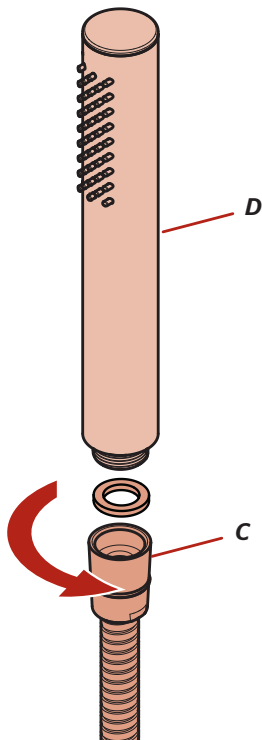

9 Turn On Water & Flush the Faucet

Active el suministro de agua y Enjuague el grifo

Ouvrez l'eau et Vidanger l'robinet

9A

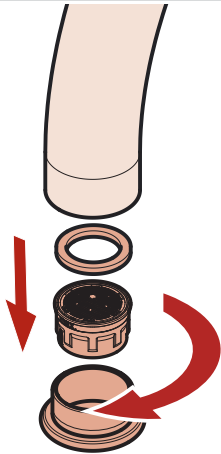

Remove Aerator
Retire el aereador
Retirez l'aérateur

Hot
Caliente
Chaud

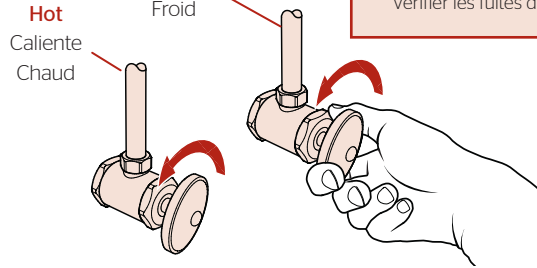

Cold
Fría
Froid



Check for leaks at water supply source.

Revise si hay fugas en la fuente de suministro de agua.

Vérifier les fuites dans la source d'approvisionnement en eau.

9B



Allow full hot & full cold water to run for at least 15 seconds each.

Deje correr el agua caliente y fría durante al menos 15 segundos cada una.

Permettez à l'eau chaude et l'eau froide de couler au moins 15 secondes chacun.

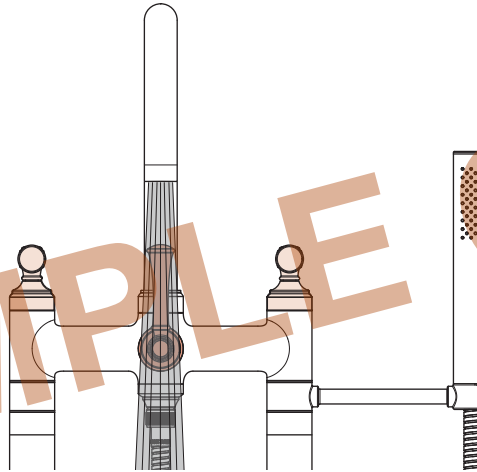

9C



Reinstall Aerator
Reinstale el aereador
Réinstallez l'aérateur

Hand Tighten

Apriete con la mano

Serrez manuellement

10 Faucet Functions

Funciones del Grifo

Fonctions du Faucet

10A

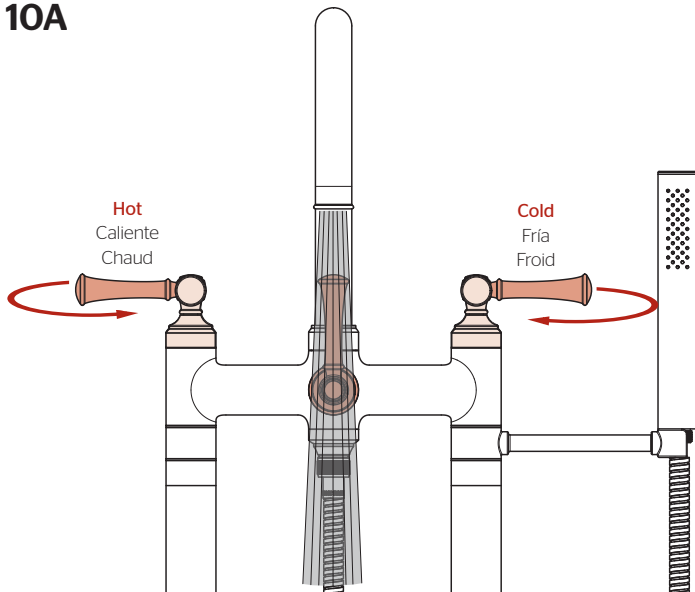

10B

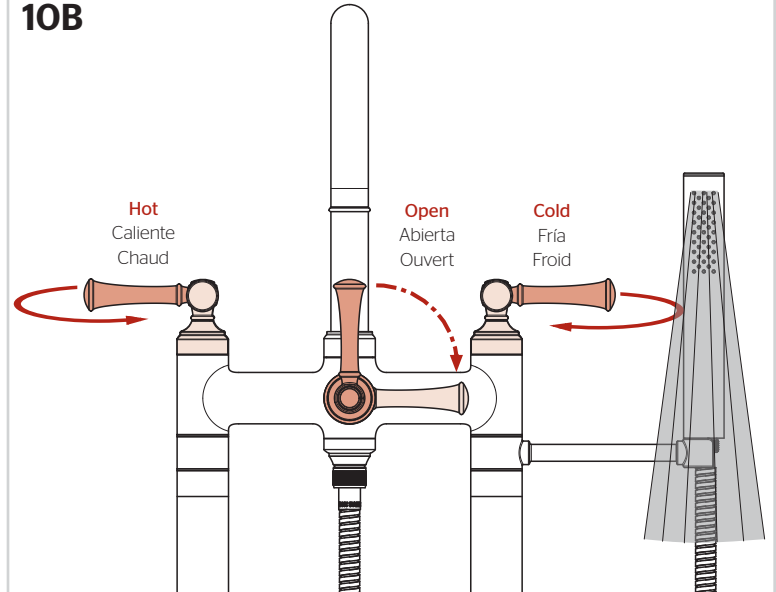

For Additional Installation Help:

Para la instalación adicionales de ayuda:

Pour aider à l'installation supplémentaires:

Pfister

1-800-PFAUCET (732-8238)

pfisterfaucets.com