

Eldon

ELD-N-xx-NO / ELD-N-xx-OF



Contemporary back-to-wall bath

- Made from ENGLISHCAST™
 - One piece casting of Volcanic Limestone™ and resin
 - Harder & more durable than acrylic
- Easy clean high gloss finish
- Exterior can be painted
- A full width tap deck hides all waste pipework and a moulded upstand allows tiles to be easily installed
- 25 year warranty
- Available in seven color finishes



La baignoire murale contemporaine

- Fabriquée en ENGLISHCAST™
 - Ensemble d'une pièce en pierre volcanique rare et résine
 - Matériau plus dur et plus résistant que l'acrylique
- Fini ultra brillant, facile à nettoyer
- L'extérieur peut être peint
- Un robinet à poser sur toute la largeur cache toute la tuyauterie et la credence moulée permet aux carreaux d'être facilement installés
- Garantie de 25 ans
- Disponible en sept couleurs

* ENGLISHCAST™ white products only. Paint finish exterior warranty for 2 years.

* Uniquement pour les produits en ENGLISHCAST™ blanc. Pour les finitions extérieures peintes la garantie est de 2 ans.

* Solo sobre productos en ENGLISHCAST™ blanco. Acabados de pintura exterior tienen una garantía de 2 años



Bañera de estilo contemporáneo

- Hecho de ENGLISHCAST™
 - Hecho en una pieza de piedra volcánica y resina
 - Más resistente y duradero que acrílico
- Fácil de limpiar y acabado brillante
- El exterior se puede pintar
- Con una grifería del ancho de la banera, todas las tuberías de desagüe quedan completamente ocultas y, además, su reborde moldeado permite colocar fácilmente las baldosas de alrededor
- 25 años de garantía
- Disponible en siete colores distintos de acabado



Warranty for residential use for 25 years*
25 ans de garantie pour un usage domestique*
Garantía de 25 años para uso domestico*



Warranty for commercial use for 8 years*
8 ans de garantie pour un usage commercial*
Garantía de 8 años para uso comercial*

Eldon

ELD-N-xx-NO / ELD-N-xx-OF

victoria  albert®

volcanic limestone baths

Special Options/Options spéciales/Opciones especiales



External finish

Use codes on right to determine SKU. The colors shown here are not exact representations.

Utiliser le code à droite pour déterminer la référence produit. La couleur présentée n'est pas la nuance réelle.

Utiliza el código a la derecha para determinar el SKU. Los colores presentados aquí, pueden variar a la realidad.



ELD-N-SW-xx



ELD-N-MW-xx



ELD-N-BK-xx



ELD-N-GR-xx



ELD-N-MB-xx



ELD-N-AN-xx



ELD-N-SG-xx

SW ENGLISHCAST™ White / ENGLISHCAST™ blanc / ENGLISHCAST™ blanco

MW Matt white / Blanc mat / Blanco mate

BK Gloss black / Noir brillant / Negro brillante

GR Light grey / Gris clair / Gris claro

MB Matt black / Noir mat / Negro mate

AN Anthracite / Gris anthracite / Antracita

SG Stone grey / Gris pierre / Gris piedra

Overflow

Available with or without an overflow hole. The new Kit 40 'intelli-waste' (pending IAPMO approval) offers proven flood protection without an unsightly overflow hole.

Disponible avec ou sans trou de trop-plein. Le nouveau Kit 40 intelligent (en cours d'approbation par l'IAPMO) offre une protection homologuée contre les débordements, et ce, sans trou de trop-plein disgracieux.

Disponible con o sin agujero rebosadero. El nuevo Kit40 "intelli waste" (pendiente certificación IAPMO) ofrece una protección aprobada contra rebosar la bañera sin un agujero rebosadero.



ELD-N-xx-NO

No overflow hole
Sans trop-plein
Sin agujero rebosadero



ELD-N-xx-OF

Overflow hole
Avec trop-plein
Con agujero rebosadero



K36 



K40 

Recommended: K36/K40/K60/K61

Conseillé / Recomendado



K60 



K61 

Related collections

Collections connexes / Colecciones relacionadas



Tubo faucet - TU-21

Eldon

ELD-N-xx-NO / ELD-N-xx-OF

victoria  albert®

volcanic limestone baths

Top view

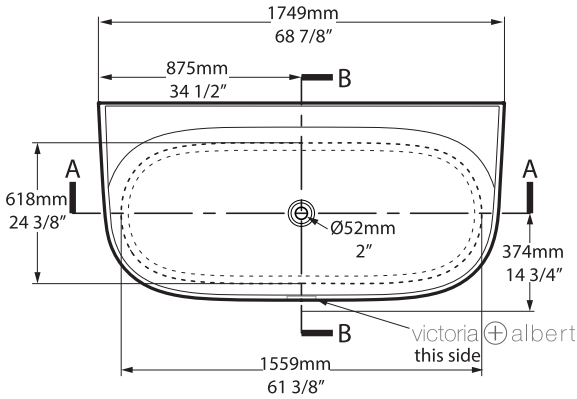

Section BB

Shown with K61 CBR waste kit

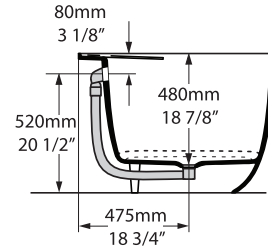

Section BB

Shown with K60/K61ABS-PVC waste kit

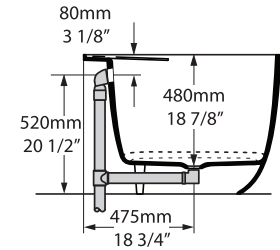

Front view

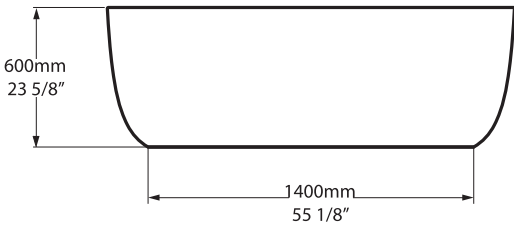

Side view

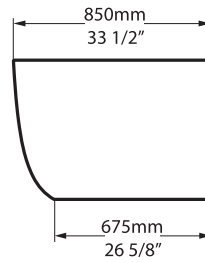





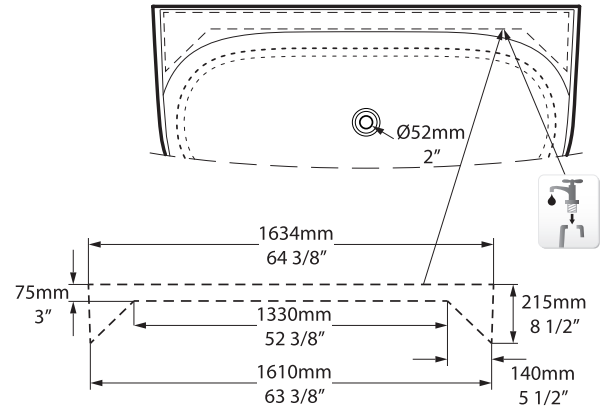
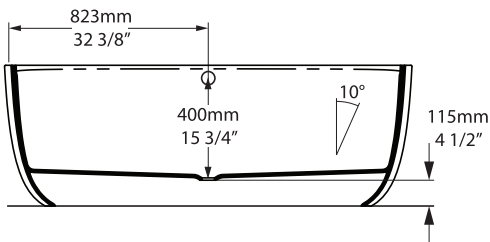

Tap holes can be drilled by installer
 Les trous de robinetterie peuvent être percés par l'installateur
 Pueden ser perforados por el instalador

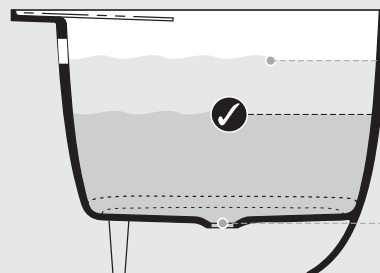
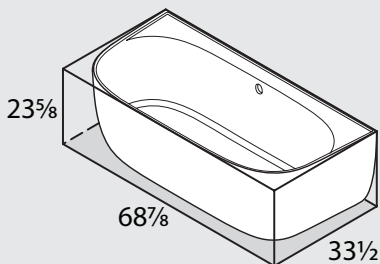
Section AA



*All measurements subject to +/-5% tolerance



-  96  86 3/4 US gal
-  73  59 1/4 US gal
-  240  0 US gal



.dwg | .dxf | .skp www.vandabaths.com



Massachusetts Code: Approved
 cUPC listing by IAPMO: File No. 6574



VA/1181/06/July18