

APPROVED APPLICATIONS

Engineering Specifications



"Apollo" Piping Systems

POWERPRESS

Type of Service	System Operating Conditions			PowerPress	PowerPress Gas
	Comments	Pressure	Temperature	EPDM	HNBR
Fluids/Water					
Chilled Water	Ethylene Glycol ProPylene Glycol	200 psi	Down to -40°F	✓	
Hydronic Heating	Ethylene Glycol ProPylene Glycol	200 psi	0°F - 302°F	✓	
Fire Sprinkler (Coming Soon)	Compliant with UL and FM for NFPA 13, 13D and 13R	175 psi	Ambient	✓	
Low Pressure System		Up to 15 psi	max. 302°F	✓	
Oil and Lubricant					
Heating Fuel Oil		125 psi	-40°F - 180°F		✓
Diesel Fuel	Compliant with NFPA 30 and 30A	125 psi			✓
Engine Oil		150 psi	Ambient		✓
Gear Grease		150 psi	104°F		✓
Hydraulic Fluid	Mineral Based	200 psi	Ambient		✓
Transmission Fluid		200 psi	Ambient		✓
Gases					
Natural Gas, LP Gas and Fuel Oil		125 psi max.	-40°F - 180°F		✓
Compressed Air	Oil Concentrate <25mg/m ³	200 psi	up to 140°F	✓	✓
	Oil Concentrate >25mg/m ³	200 psi	up to 140°F		✓
Vacuum		Max. 29.2in Hg	up to 140°F	✓	✓
Oxygen Non-medical	Keep oil and fat free/non liquid	140 psi	up to 140°F	✓	✓
Nitrogen		200 psi	up to 140°F	✓	✓
Argon		200 psi	up to 140°F	✓	✓
Carbon Dioxide		200 psi	up to 140°F	✓	✓
1. Consult the Apollo Technical Support Department for information on applications not listed and applications outside the temperature and pressure ranges listed above.					
2. All systems are recommended to be clearly labeled with the fluid or gas being conveyed.					

"Apollo" POWERPRESS Sealing Elements

Apollo PowerPress EPDM Sealing Element
Operating Temperature: -40°F to 302°F (-40°C to 150°C)

This sealing element is used mainly in the applications of hydronic heating, chilled water and fire sprinkler installations. EPDM, or ethylene-propylene-diene monomer, is shiny black in color. The EPDM sealing element is a synthetically manufactured and periodically cross-linked general purpose elastomer with a wide range of applications.

The EPDM sealing element possesses excellent resistance to aging, ozone, sunlight, weathering, environmental influences, alkalis and most alkaline solutions and chemicals used in a broad range of applications.

Apollo PowerPress Gas HNBR Sealing Element
Operating Temperature: -40°F to 194°F (-40°C to 90°C)

This sealing element is used mainly for fuel gas applications. HNBR, or Hydrogenated Nitrile Butadiene Rubber is yellow in color for easy identification.

With its excellent performance for the most demanding of applications, HNBR is the ideal choice for applications needing excellent physical properties, as well as oil and/or chemical resistance.

"Apollo" **POWERPRESS**

Steel



PWR7480000

PWR7480000

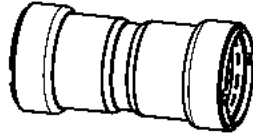

"Apollo" **POWERPRESS**

Steel



PWR7480000

PWR7480000

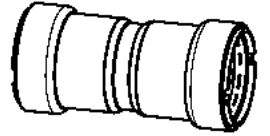

"Apollo" **POWERPRESS**

Steel



PWR7480066

PWR7480066

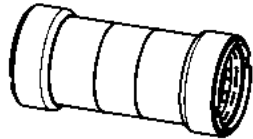

"Apollo" **POWERPRESS**

Steel



PWR7480066

PWR7480066

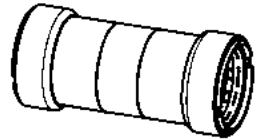

"Apollo" **POWERPRESS**

Steel



PWR7480121

PWR7480121

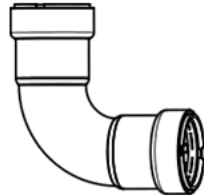

"Apollo" **POWERPRESS**

Steel



PWR7480121

PWR7480121

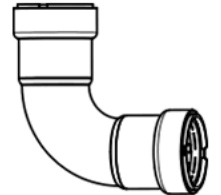

"Apollo" **POWERPRESS**

Steel



PWR7480187

PWR7480187

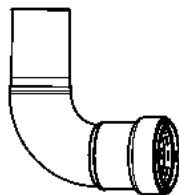

"Apollo" **POWERPRESS**

Steel



PWR7480187

PWR7480187

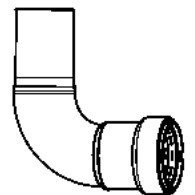

"Apollo" **POWERPRESS**

Steel



PWR7480242

PWR7480242

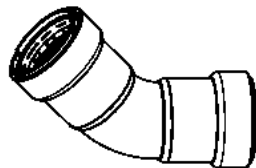

"Apollo" **POWERPRESS**

Steel



PWR7480242

PWR7480242

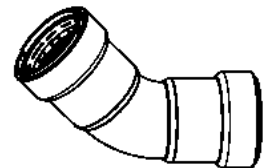

"Apollo" **POWERPRESS**

Steel



PWR7480308

PWR7480308

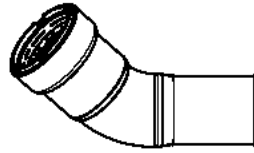

"Apollo" **POWERPRESS**

Steel



PWR7480308

PWR7480308

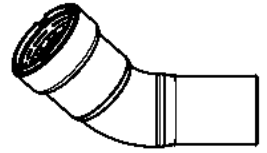

"Apollo" **POWERPRESS**

Steel



PWR7480363

PWR7480363

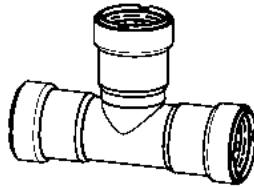

"Apollo" **POWERPRESS**

Steel



PWR7480363

PWR7480363

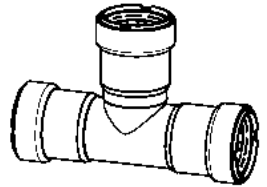

"Apollo" **POWERPRESS**

Steel



PWR7480429

PWR7480429

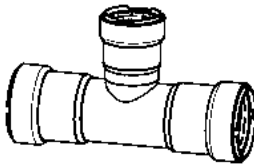

"Apollo" **POWERPRESS**

Steel



PWR7480429

PWR7480429

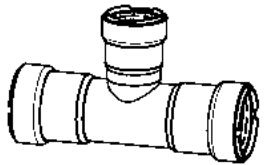

"Apollo" **POWERPRESS**

Steel



PWR7480550

PWR7480550

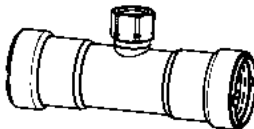

"Apollo" **POWERPRESS**

Steel



PWR7480550

PWR7480550

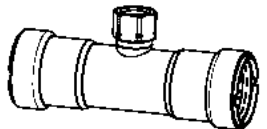

"Apollo" **POWERPRESS**

Steel



PWR7480693

PWR7480693

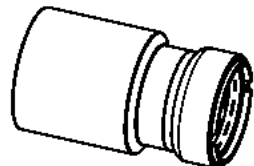

"Apollo" **POWERPRESS**

Steel



PWR7480693

PWR7480693

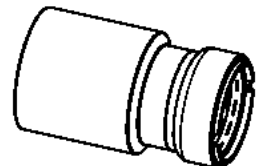

"Apollo" **POWERPRESS**

PWR7480759

"Apollo" **POWERPRESS**

PWR7480759



PWR7480759

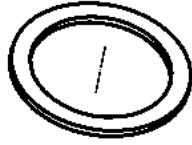

PWR7480759

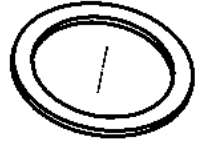

"Apollo" **POWERPRESS**

PWR7480847

"Apollo" **POWERPRESS**

PWR7480847

Steel



PWR7480847

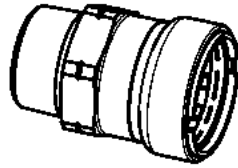

Steel



PWR7480847

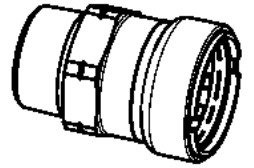

"Apollo" **POWERPRESS**

PWR7480902

"Apollo" **POWERPRESS**

PWR7480902

Steel



PWR7480902

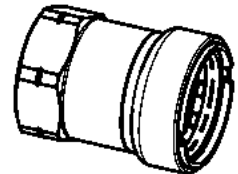

Steel



PWR7480902

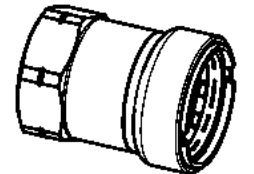

"Apollo" **POWERPRESS**

PWR7481111

"Apollo" **POWERPRESS**

PWR7481111

Steel



PWR7481111

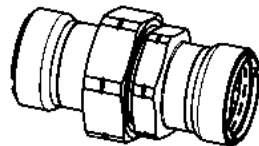

Steel



PWR7481111

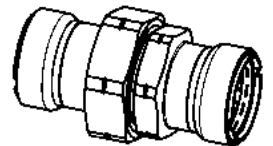

"Apollo" **POWERPRESS**

PWR7481177

"Apollo" **POWERPRESS**

PWR7481177

Steel



PWR7481177

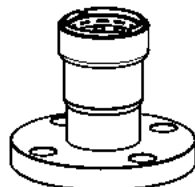

Steel



PWR7481177

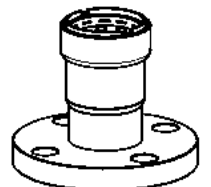

"Apollo" **POWERPRESS**

Steel



PWR7481232

PWR7481232

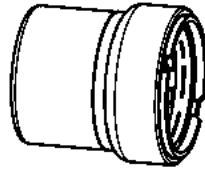

"Apollo" **POWERPRESS**

Steel



PWR7481232

PWR7481232

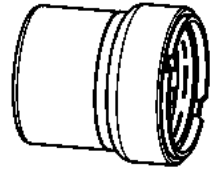

"Apollo" **POWERPRESS**

Steel Gas



PWR7481298

PWR7481298

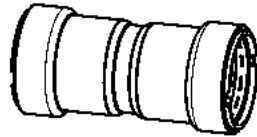

"Apollo" **POWERPRESS**

Steel Gas



PWR7481298

PWR7481298

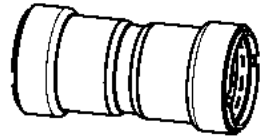

"Apollo" **POWERPRESS**

Steel Gas



PWR7481353

PWR7481353

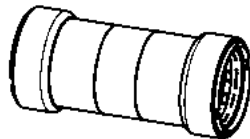

"Apollo" **POWERPRESS**

Steel Gas



PWR7481353

PWR7481353

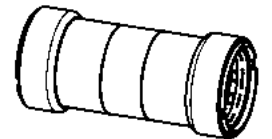

"Apollo" **POWERPRESS**

Steel Gas



PWR7481419

PWR7481419

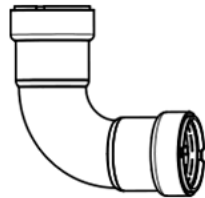

"Apollo" **POWERPRESS**

Steel Gas



PWR7481419

PWR7481419

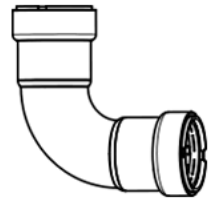

"Apollo" **POWERPRESS**

Steel Gas



PWR7481474

PWR7481474

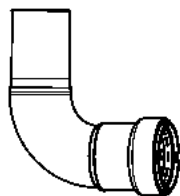

"Apollo" **POWERPRESS**

Steel Gas



PWR7481474

PWR7481474

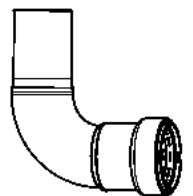

"Apollo" **POWERPRESS**

Steel Gas



PWR7481531

PWR7481531

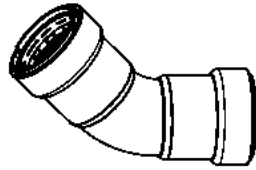

"Apollo" **POWERPRESS**

Steel Gas



PWR7481531

PWR7481531

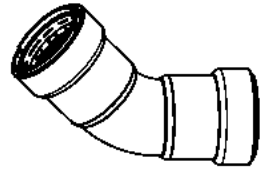

"Apollo" **POWERPRESS**

Steel Gas



PWR7481595

PWR7481595

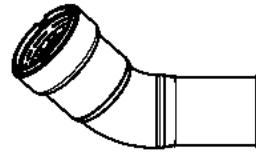

"Apollo" **POWERPRESS**

Steel Gas



PWR7481595

PWR7481595

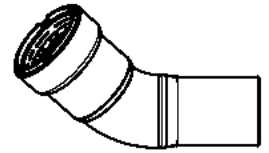

"Apollo" **POWERPRESS**

Steel Gas



PWR7481650

PWR7481650

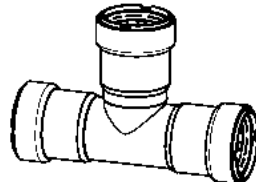

"Apollo" **POWERPRESS**

Steel Gas



PWR7481650

PWR7481650

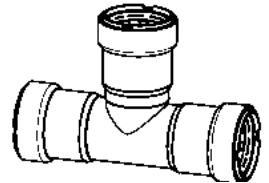

"Apollo" **POWERPRESS**

Steel Gas



PWR7481716

PWR7481716

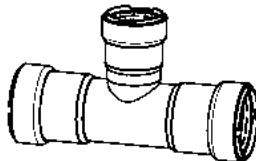

"Apollo" **POWERPRESS**

Steel Gas



PWR7481716

PWR7481716

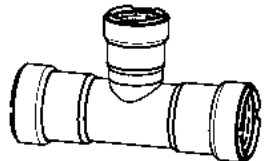

"Apollo" **POWERPRESS**

Steel Gas



PWR7481848

PWR7481848

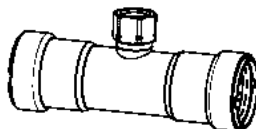

"Apollo" **POWERPRESS**

Steel Gas



PWR7481848

PWR7481848

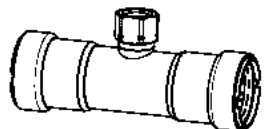

"Apollo" **POWERPRESS**

Steel Gas



PWR7481980

PWR7481980

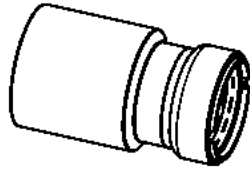

"Apollo" **POWERPRESS**

Steel Gas



PWR7481980

PWR7481980

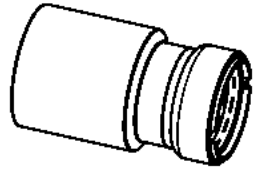

"Apollo" **POWERPRESS**



PWR7481983

PWR7481983

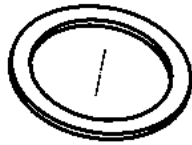

"Apollo" **POWERPRESS**



PWR7481983

PWR7481983

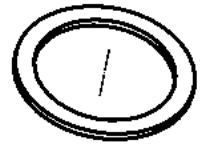

"Apollo" **POWERPRESS**

Steel Gas



PWR7482081

PWR7482081

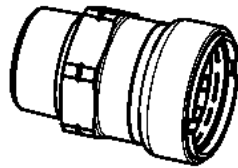

"Apollo" **POWERPRESS**

Steel Gas



PWR7482081

PWR7482081

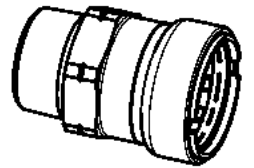

"Apollo" **POWERPRESS**

Steel Gas



PWR7482354

PWR7482354

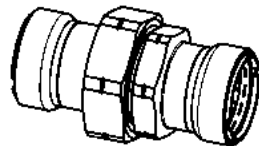

"Apollo" **POWERPRESS**

Steel Gas



PWR7482354

PWR7482354

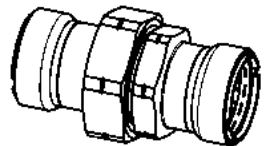

"Apollo" **POWERPRESS**

Steel Gas



PWR7482411

PWR7482411

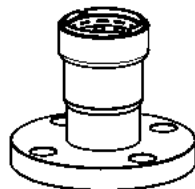

"Apollo" **POWERPRESS**

Steel Gas



PWR7482411

PWR7482411

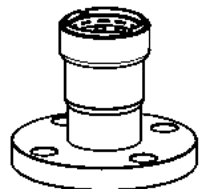

"Apollo" **POWERPRESS**

Steel Gas



PWR7482475

PWR7482475

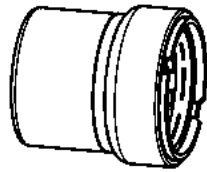

"Apollo" **POWERPRESS**

Steel Gas



PWR7482475

PWR7482475

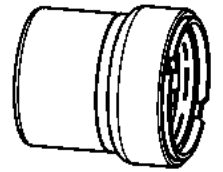

DIMENSIONAL DOCUMENTATION

Engineering Specifications

"Apollo" Piping Systems

"Apollo"[®]

POWERPRESS



ON
OFF
"Apollo"[®]
POWERPRESS
CONBRACO
IND., INC.
U.S.A.6.

© UPC

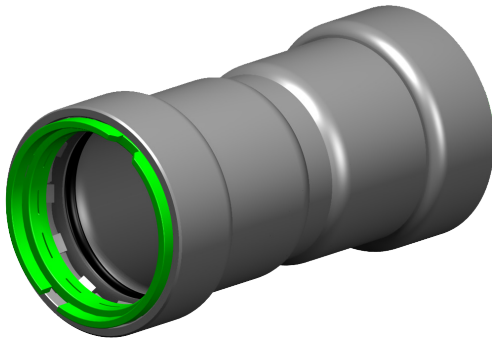

COUPLING WITH STOP
400 (2 x Press)

Part No.	Nom. Size (inches)	l1/l2	z1/z2
PWR7480000	1/2	1.34	0.20
PWR7480011	3/4	1.48	0.24
PWR7480022	1	1.67	0.24
PWR7480033	1-1/4	2.20	0.28
PWR7480044	1-1/2	2.28	0.33
PWR7480055	2	2.40	0.31

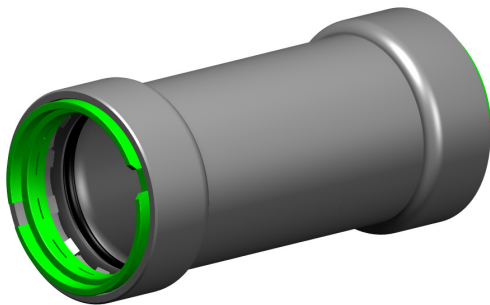
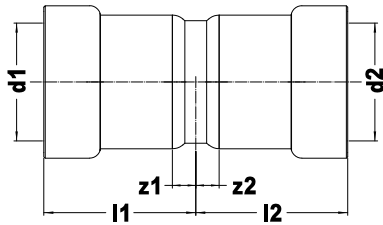

COUPLING WITHOUT STOP
401 (2 x Press)

Part No.	Nom. Size (inches)	l1/l2	es1/es2
PWR7480066	1/2	1.54	1.14
PWR7480077	3/4	1.63	1.24
PWR7480088	1	1.83	1.44
PWR7480099	1-1/4	2.32	1.93
PWR7480101	1-1/2	2.46	1.95
PWR7480110	2	2.56	2.09

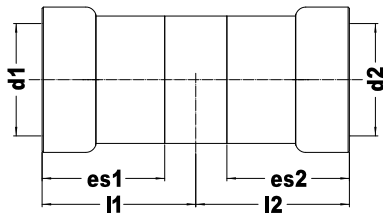



ELBOWS

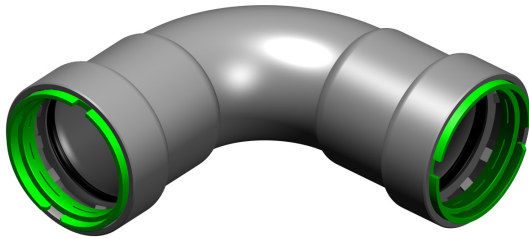

90° ELBOW
407 (2 x Press)

Part No.	Nom. Size (inches)	l1/l2	z1/z2	r
PWR7480121	1/2	2.17	1.02	0.98
PWR7480132	3/4	2.50	1.26	1.18
PWR7480143	1	3.01	1.57	1.50
PWR7480154	1-1/4	3.82	1.89	1.77
PWR7480165	1-1/2	4.09	2.15	1.97
PWR7480176	2	4.80	2.72	2.56

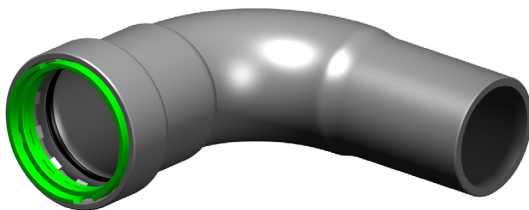
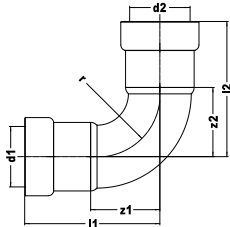

90° ELBOW
407-2 (Press x Male)

Part No.	Nom. Size (inches)	l1	l2	z1	z2	r
PWR7480187	1/2	2.17	2.70	1.02	1.56	0.98
PWR7480198	3/4	2.50	2.95	1.26	1.71	1.18
PWR7480209	1	3.01	3.56	1.57	2.13	1.50
PWR7480211	1-1/4	3.82	4.19	1.89	2.26	1.77
PWR7480220	1-1/2	4.09	4.27	2.15	2.32	1.97
PWR7480231	2	4.80	5.30	2.72	3.21	2.56

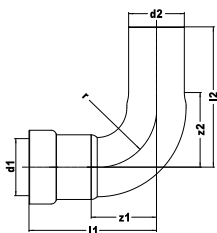

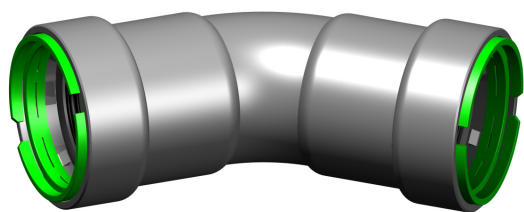

45° ELBOW
406 (2 x Press)

Part No.	Nom. Size (inches)	l1/l2	z1/z2	r
PWR7480242	1/2	1.59	0.45	0.98
PWR7480253	3/4	1.81	0.57	1.18
PWR7480264	1	2.13	0.69	1.50
PWR7480275	1-1/4	2.78	0.85	1.77
PWR7480286	1-1/2	2.93	0.98	1.97
PWR7480297	2	3.31	1.22	2.56

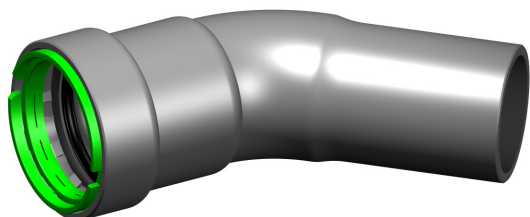
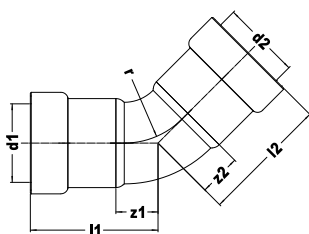

45° STREET ELBOW
406-2 (Press x Male)

Part No.	Nom. Size (inches)	l1	l2	z1	z2	r
PWR7480306	1/2 x 1/2	1.59	2.13	0.45	0.98	0.98
PWR7480319	3/4 x 3/4	1.81	2.26	0.57	1.02	1.18
PWR7480321	1 x 1	2.13	2.68	0.69	1.24	1.50
PWR7480330	1-1/4 x 1-1/4	2.78	3.15	0.85	1.22	1.77
PWR7480341	1-1/2 x 1-1/2	2.93	3.11	0.98	1.16	1.97
PWR7480352	2 x 2	3.31	3.80	1.22	1.71	2.56

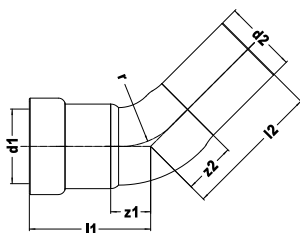

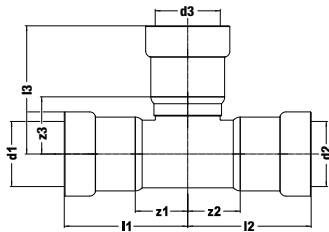
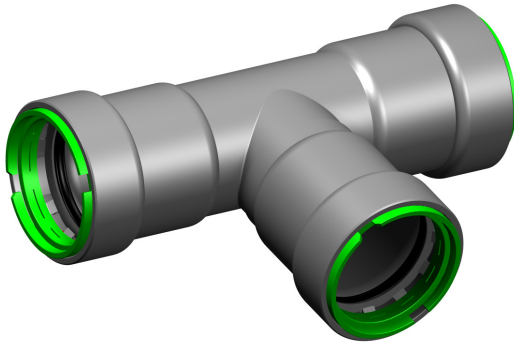

TEE
411 (3 x Press)

Part No.	Nom. Size (inches)	l1/l2	l3	z1/z2	z3
PWR7480363	1/2	2.05	2.09	0.91	1.02
PWR7480374	3/4	2.24	2.30	1.08	1.14
PWR7480385	1	2.60	2.66	1.24	1.30
PWR7480396	1-1/4	3.23	3.35	1.30	1.50
PWR7480407	1-1/2	3.48	3.50	1.61	1.63
PWR7480418	2	3.78	3.92	1.77	1.91

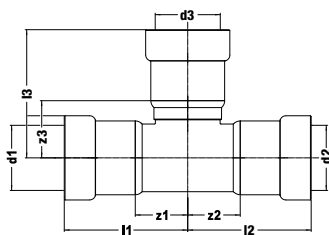
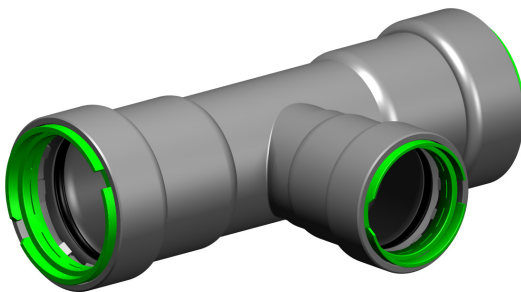

REDUCING OUTLET/BRANCH TEE
411R (3 x Press)

Part No.	Nom. Size (inches)	l1/l2	l3	z1/z2	z3
PWR7480429	3/4 x 3/4 x 1/2	2.24	2.19	1.08	1.12
PWR7480431	1 x 1 x 1/2	2.60	2.34	1.24	1.28
PWR7480440	1 x 1 x 3/4	2.60	2.46	1.24	1.30
PWR7480451	1-1/4 x 1-1/4 x 1	3.23	2.31	1.38	1.46
PWR7480462	1-1/2 x 1-1/2 x 1/2	3.48	2.58	1.61	1.52
PWR7480473	1-1/2 x 1-1/2 x 3/4	3.48	2.69	1.61	1.53
PWR7480484	1-1/2 x 1-1/2 x 1	3.48	2.89	1.61	1.54
PWR7480495	1-1/2 x 1-1/2 x 1-1/4	3.48	2.43	1.61	1.57
PWR7480506	2 x 2 x 1/2	3.78	2.87	1.77	1.81
PWR7480517	2 x 2 x 3/4	3.78	2.99	1.77	1.83
PWR7480528	2 x 2 x 1	3.78	3.19	1.77	1.83
PWR7480539	2 x 2 x 1-1/4	3.78	3.72	1.77	1.87
PWR7480541	2 x 2 x 1-1/2	3.78	3.80	1.77	1.93

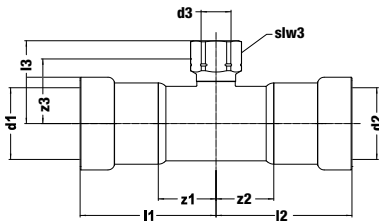
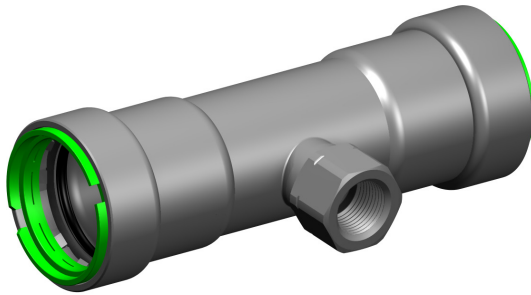

TEE w/ FEMALE THREAD OUTLET/BRANCH
4712 (Press x Female Thread x Press)

Part No.	Nom. Size (inches)	l1/l2	l3	z1/z2	z3	slw2
PWR7480550	3/4 x 3/4 x FPT 1/2	2.26	1.65	1.02	1.34	1.10
PWR7480561	3/4 x 3/4 x FPT 3/4	2.26	1.71	1.02	1.37	1.26
PWR7480572	1 x 1 x FPT 1/2	2.62	1.81	1.18	1.50	1.10
PWR7480583	1 x 1 x FPT 3/4	2.62	1.87	1.18	1.53	1.26
PWR7480594	1-1/4 x 1-1/4 x FPT 1/2	3.23	1.97	1.30	1.65	1.26
PWR7480605	1-1/2 x 1-1/2 x FPT 1/2	3.50	2.05	1.56	1.73	1.10
PWR7480616	1-1/2 x 1-1/2 x FPT 3/4	3.50	2.11	1.56	1.76	1.26
PWR7480627	1-1/2 x 1-1/2 x FPT 1	3.50	2.26	1.56	1.85	1.61
PWR7480638	1-1/2 x 1-1/2 x FPT 1-1/4	3.50	2.36	1.56	1.94	1.97
PWR7480649	2 x 2 x FPT 1/2	3.80	2.34	1.71	2.03	1.10
PWR7480651	2 x 2 x FPT 3/4	3.80	2.40	1.71	2.06	1.26
PWR7480660	2 x 2 x FPT 1	3.80	2.56	1.71	2.15	1.61
PWR7480671	2 x 2 x FPT 1-1/4	3.80	2.66	1.71	2.24	1.97
PWR7480682	2 x 2 x FPT 1-1/2	3.80	2.66	1.71	2.24	2.36

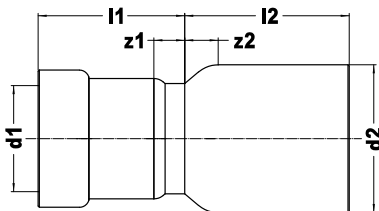
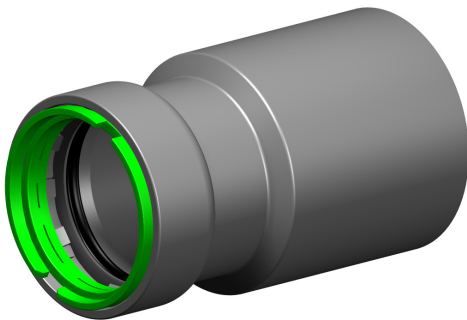

FITTING REDUCER
418 (Male x Press)

Part No.	Nom. Size (inches)	l1	l2	z1	z2
PWR7480693	3/4 x 1/2	1.26	1.26	0.12	0.02
PWR7480704	1 x 1/2	1.26	1.44	0.12	0.00
PWR7480715	1 x 3/4	1.42	1.30	0.18	-0.14
PWR7480748	1-1/4 x 1	1.63	1.73	0.20	-0.20
PWR7480761	1-1/2 x 3/4	1.87	2.42	0.63	0.47
PWR7480770	1-1/2 x 1	1.63	1.79	0.20	-0.16
PWR7480781	1-1/2 x 1-1/4	2.17	1.67	0.24	-0.28
PWR7480814	2 x 1	2.07	2.64	0.63	0.55
PWR7480825	2 x 1-1/4	2.17	1.79	0.24	-0.30
PWR7480836	2 x 1-1/2	2.13	1.81	0.18	-0.28

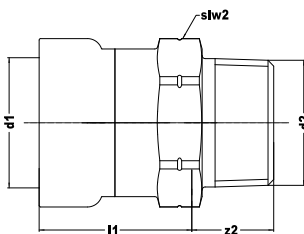
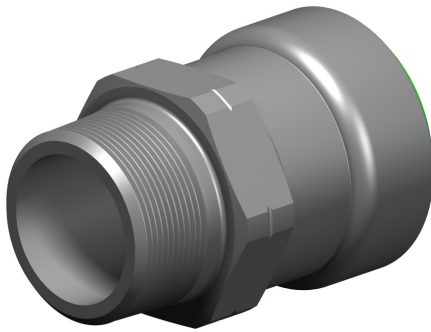

MALE THREAD ADAPTER
404 (Press x Male Thread)

Part No.	Nom. Size (inches)	l1	z2	slw2
PWR7480847	1/2 x MPT 1/2	1.12	0.98	1.10
PWR7480858	3/4 x MPT 3/4	1.22	0.98	1.42
PWR7480869	1 x MPT 1	1.42	1.10	1.61
PWR7480871	1-1/4 x MPT 1-1/4	1.91	1.14	1.97
PWR7480880	1-1/2 x MPT 1-1/2	1.93	1.12	2.36
PWR7480891	2 x MPT 2	2.07	1.16	2.76

FEMALE THREAD ADAPTER
403 (Press x Female Thread)

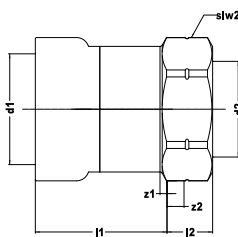
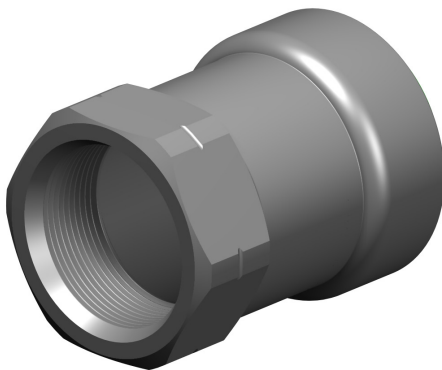

Part No.	Nom. Size (inches)	l1	l2	z1	z2	slw2
PWR7480902	1/2 x FPT 1/2	1.22	0.61	0.08	0.00	1.10
PWR7480913	3/4 x FPT 1/2	1.30	0.67	0.06	0.06	1.42
PWR7480924	3/4 x FPT 3/4	1.32	0.63	0.08	0.00	1.42
PWR7480935	1 x FPT 1/2	1.57	0.67	0.14	0.06	1.61
PWR7480946	1 x FPT 3/4	1.52	0.69	0.08	0.06	1.61
PWR7480957	1 x FPT 1	1.54	0.75	0.10	0.00	1.61
PWR7480968	1-1/4 x FPT 1/2	2.17	0.67	0.24	0.06	1.97
PWR7480979	1-1/4 x FPT 3/4	2.11	0.69	0.18	0.06	1.97
PWR7480981	1-1/4 x FPT 1	2.03	0.83	0.10	0.08	1.97
PWR7480990	1-1/4 x FPT 1-1/4	1.91	0.89	0.00	0.00	1.97
PWR7481001	1-1/2 x FPT 1/2	2.26	0.67	0.31	0.06	2.36
PWR7481012	1-1/2 x FPT 3/4	2.20	0.69	0.26	0.06	2.36
PWR7481023	1-1/2 x FPT 1	2.13	0.83	0.18	0.08	2.36
PWR7481034	1-1/2 x FPT 1-1/4	2.03	0.85	0.08	0.08	2.36
PWR7481045	1-1/2 x FPT 1-1/2	2.05	0.77	0.10	0.00	2.36
PWR7481056	2 x FPT 1/2	2.54	0.67	0.45	0.06	2.76
PWR7481067	2 x FPT 3/4	2.48	0.69	0.39	0.06	2.76
PWR7481078	2 x FPT 1	2.40	0.83	0.31	0.08	2.76
PWR7481089	2 x FPT 1-1/4	2.30	0.85	0.22	0.08	2.76
PWR7481091	2 x FPT 1-1/2	2.22	0.85	0.14	0.08	2.76
PWR7481100	2 x FPT 2	2.19	0.79	0.10	0.00	2.76

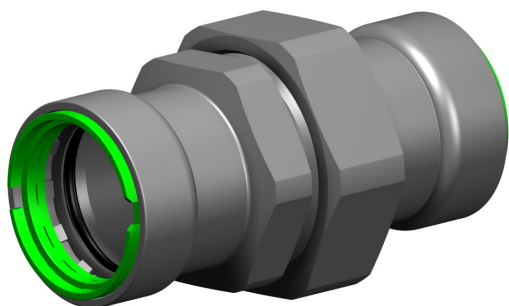

UNION
4733 (Press x Press)

Part No.	Nom. Size (inches)	l1	l2	z1	z2	slw1	slw2
PWR7481111	1/2	1.73	0.59	2.11	1.14	1.61	0.45
PWR7481122	3/4	1.93	0.69	2.17	1.24	1.61	0.49
PWR7481133	1	2.20	0.77	2.48	1.44	2.17	0.57
PWR7481144	1-1/4	2.17	0.24	2.85	1.93	2.76	0.76
PWR7481155	1-1/2	3.03	1.08	2.81	1.95	2.76	0.77
PWR7481166	2	3.31	1.22	3.23	2.09	3.35	0.82

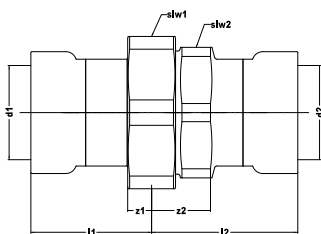

FLANGE ADAPTER CLASS 150
4771 (l x Press)

Part No.	Nom. Size (inches)	l1	l2	z1	z2	slw1	slw2	Holes
PWR7481177	1/2	2.44	0.39	1.30	0.40	3.54	0.63	4
PWR7481188	3/4	2.64	0.31	1.40	0.45	3.94	0.63	4
PWR7481199	1	2.95	0.22	1.52	0.51	4.33	0.63	4
PWR7481201	1-1/4	3.58	0.14	1.65	0.59	4.53	0.63	4
PWR7481210	1-1/2	3.82	0.10	1.87	0.65	4.92	0.63	4
PWR7481221	2	3.92	1.30	1.83	0.71	5.91	0.75	4

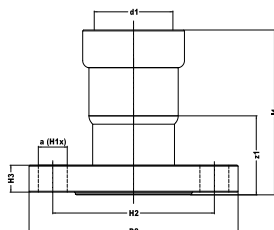

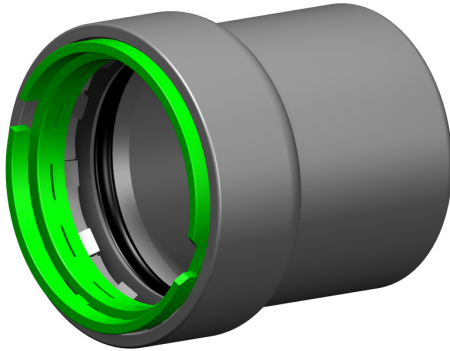

CAP
417 (1 x Press)

Part No.	Nom. Size (inches)	l1	z1
PWR7481232	1/2	1.40	0.26
PWR7481243	3/4	1.50	0.26
PWR7481254	1	1.71	0.28
PWR7481265	1-1/4	2.20	0.28
PWR7481276	1-1/2	2.28	0.33
PWR7481287	2	2.40	0.31

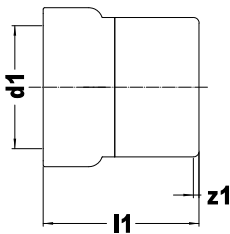

FLAT SEAL
PWR7452 (Black, EPDM)

Part No.	Nom. Size (inches)
PWR7480759	1/2 & 3/4
PWR7480803	1
PWR7480726	1-1/4 & 1-1/2
PWR7482596	2

The maximum working temperature of the flat seal is 302°F

DESCRIPTION

The Apollo PowerPress 89FV Ball Valve is ideal for installation in chilled water, compressed air, hydronic heating and fire sprinkler (coming soon) applications. This valve design significantly reduces installation time and helps maintain a clean working environment. The ApolloPowerPress is designed for steel pipe, schedules 10 to 40, as defined by ASTM A53, A106, A135 and A795 standards.



FEATURES

- Patented Visual Inspection Ring & Indicator
- Full-Port Flow
- Adjustable Stem Packing
- Fast, Reliable, Economical Press Installation
- Ridgid® & Milwaukee Press Tool Compatible
- Leak Before Press® Technology
- Blow-Out Proof Stem
- Corrosion Resistant Materials
- 100% Factory Tested
- Silicone Free Assembly
- Made in USA, ARRA Compliant

PERFORMANCE RATING

- Maximum Operating Pressure 200 psi
- Temperature Range: -40°F - 302°F

APPROVED APPLICATIONS

- Chilled Water
- Hydronic Heating (50% glycol max)
- Low Pressure Steam, 15 psi max
- Compressed Air
- Fire Sprinkler Applications (Coming Soon)
- Not suitable for flammable gas service

OPTIONS

- 01: Standard (PTFE Packing, RPTFE Body Seal)
- 02: Grounded Stem
- 04: 2-1/4 inch Stem Extension
- 11: THERMA-SEAL® Insulating Tee Handle
- 14: Side Vented Ball (Uni-Directional)
- 24: Graphite Stem Packing
- 27: SS Latch-Lock Lever and Nut
- 32: SS Tee Handle and Nut
- 39: SS Hi-Rise Locking Wheel Handle with SS Nut
- 45: Less Lever and Nut
- 47: SS Latch Lock Oval Handle
- 48: SS Oval Handle (No Latch)
- 49: Assembled Dry
- 60: Grounded Ball and Stem

DIMENSIONS (IN)

Part Number	Size	A	B	C	D	E	Wt (lbs.)
89FVE4301	1/2"	0.50	2.08	4.16	1.74	3.85	0.6
89FVE4401	3/4"	0.75	2.28	4.55	1.96	3.85	0.9
89FVE4501	1"	1.00	2.72	5.44	2.29	4.76	1.4
89FVE4601	1-1/4"	1.25	3.41	6.82	3.20	7.76	4.2
89FVE4701	1-1/2"	1.50	3.62	7.24	3.30	7.76	4.8
89FVE4801	2"	2.00	3.93	7.85	3.68	7.76	7.2

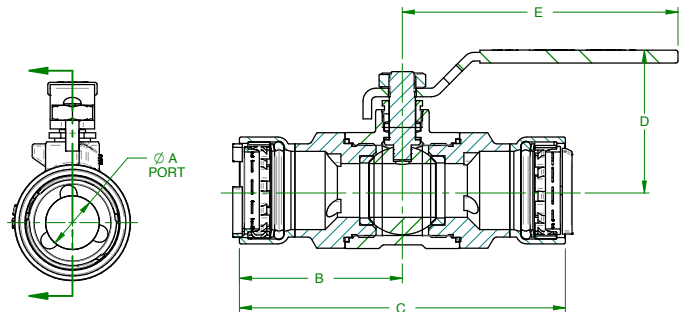

STANDARD MATERIAL SPECIFICATIONS:

Part Name	Material
Body	ASTM A216-WCB Carbon Steel
Seat	Reinforced PTFE
Ball	ASTM A276-316 Stainless Steel
Stem Packing	Multi-Fill PTFE
Nut	Corrosion Resistant Plated Steel
Stem	ASTM A276-316 Stainless Steel
Retainer	ASTM A108-12L14 Carbon Steel
O-Ring	EPDM
Handle	Plated Steel/Insulated Polyvinyl
Gland	ASTM A108-1215 Carbon Steel
Stem Bearing	Reinforced PTFE
Body Seal	PTFE



DESCRIPTION

The Apollo PowerPress 89FV Gas Ball Valve is ideal for installation in compressed air and fuel gas applications. This valve design significantly reduces installation time and helps maintain a clean working environment. The ApolloPowerPress is designed for steel pipe, schedules 10 to 40, as defined by ASTM A53, A106, A135 and A795 standards.



FEATURES

- Patented Visual Inspection Ring & Indicator
- Full-Port Flow
- Adjustable Stem Packing
- Fast, Reliable, Economical Press Installation
- Ridgid® & Milwaukee Press Tool Compatible
- Leak Before Press® Technology
- Blow-Out Proof Stem
- Corrosion Resistant Materials
- 100% Factory Tested
- Silicone Free Assembly
- Made in USA, ARRA Compliant

PERFORMANCE RATING

- Maximum Operating Pressure:
125 psi max for fuel gas applications
200 psi max for other approved applications
- Temperature Range: -40°F - 194°F

APPROVALS

- ANSI LC 4/CSA 6.32
- IAPMO LC 4

APPROVED APPLICATIONS

- Compressed Air
- Fuel Gas

OPTIONS

- 01: Standard (PTFE Packing, RPTFE Body Seal)
- 02: Grounded Stem
- 04: 2-1/4 inch Stem Extension
- 11: THERMA-SEAL® Insulating Tee Handle
- 14: Side Vented Ball (Uni-Directional)
- 24: Graphite Stem Packing
- 27: SS Latch-Lock Lever and Nut
- 32: SS Tee Handle and Nut
- 39: SS Hi-Rise Locking Wheel Handle with SS Nut
- 45: Less Lever and Nut
- 47: SS Latch Lock Oval Handle
- 48: SS Oval Handle (No Latch)
- 49: Assembled Dry
- 60: Grounded Ball and Stem

DIMENSIONS (IN)

Part Number	Size	A	B	C	D	E	Wt (lbs.)
89FVH4301	1/2"	0.50	2.08	4.16	1.74	3.85	0.6
89FVH4401	3/4"	0.75	2.28	4.55	1.96	3.85	0.9
89FVH4501	1"	1.00	2.72	5.44	2.29	4.76	1.4
89FVH4601	1-1/4"	1.25	3.41	6.82	3.20	7.76	4.2
89FVH4701	1-1/2"	1.50	3.62	7.24	3.30	7.76	4.8
89FVH4801	2"	2.00	3.93	7.85	3.68	7.76	7.2

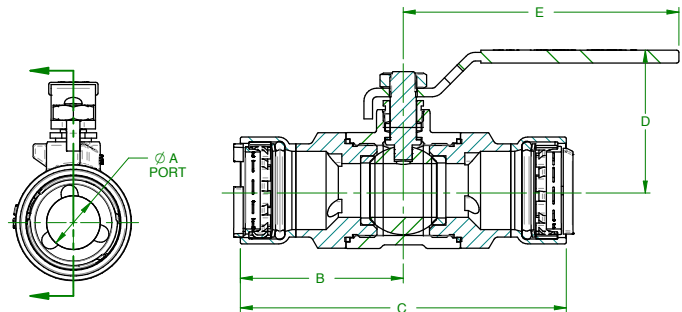

STANDARD MATERIAL SPECIFICATIONS:

Part Name	Material
Body	ASTM A216-WCB Carbon Steel
Seat	Reinforced PTFE
Ball	ASTM A276-316 Stainless Steel
Stem Packing	Multi-Fill PTFE
Nut	Corrosion Resistant Plated Steel
Stem	ASTM A276-316 Stainless Steel
Retainer	ASTM A108-12L14 Carbon Steel
O-Ring	HNBR (yellow)
Handle	Plated Steel/Insulated Polyvinyl
Gland	ASTM A108-1215 Carbon Steel
Stem Bearing	Reinforced PTFE
Body Seal	PTFE

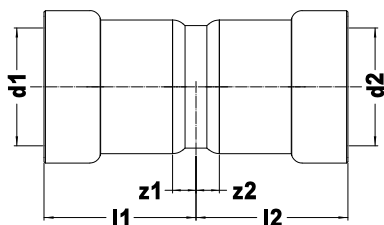
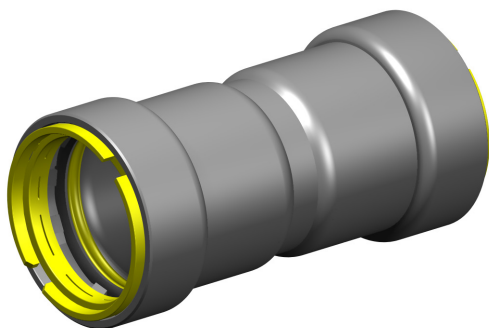

COUPLING WITH STOP
400G (2 x Press)

Part No.	Nom. Size (inches)	l1/l2	z1/z2
PWR7481298	1/2	1.34	0.20
PWR7481309	3/4	1.48	0.24
PWR7481311	1	1.67	0.24
PWR7481320	1-1/4	2.20	0.28
PWR7481331	1-1/2	2.28	0.33
PWR7481342	2	2.40	0.31

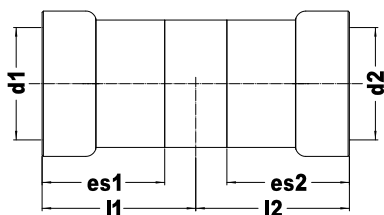
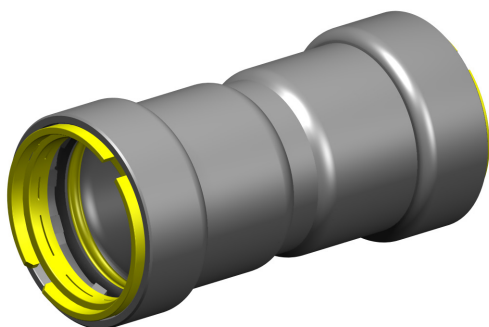

COUPLING WITHOUT STOP
401G (2 x Press)

Part No.	Nom. Size (inches)	l1/l2	es1/es2
PWR7481353	1/2	1.54	1.14
PWR7481364	3/4	1.63	1.24
PWR7481375	1	1.83	1.44
PWR7481386	1-1/4	2.32	1.93
PWR7481397	1-1/2	2.46	1.95
PWR7481408	2	2.56	2.09

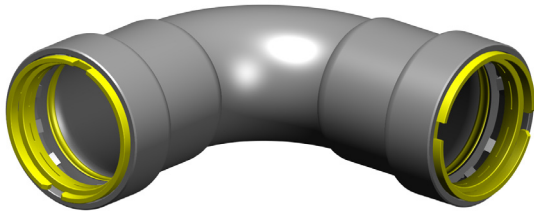

90° ELBOW
407G (2 x Press)

Part No.	Nom. Size (inches)	l1/l2	z1/z2	r
PWR7481419	1/2	2.17	1.02	0.98
PWR7481421	3/4	2.50	1.26	1.18
PWR7481430	1	3.01	1.57	1.50
PWR7481441	1-1/4	3.82	1.89	1.77
PWR7481452	1-1/2	4.09	2.15	1.97
PWR7481463	2	4.80	2.72	2.56

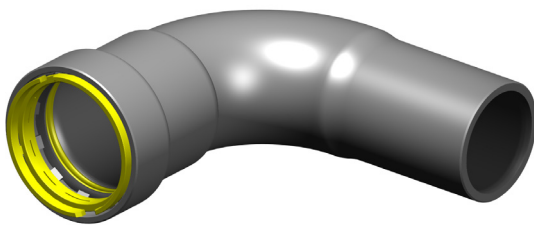
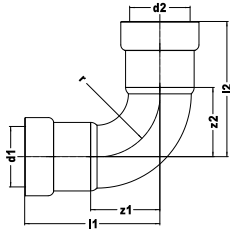

90° ELBOW
407-2G (Press x Male)

Part No.	Nom. Size (inches)	l1	l2	z1	z2	r
PWR7481474	1/2	2.17	2.70	1.02	1.56	0.98
PWR7481485	3/4	2.50	2.95	1.26	1.71	1.18
PWR7481496	1	3.01	3.56	1.57	2.13	1.50
PWR7481507	1-1/4	3.82	4.19	1.89	2.26	1.77
PWR7481518	1-1/2	4.09	4.27	2.15	2.32	1.97
PWR7481529	2	4.80	5.30	2.72	3.21	2.56

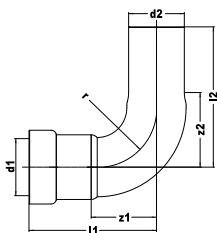

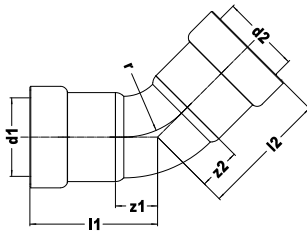
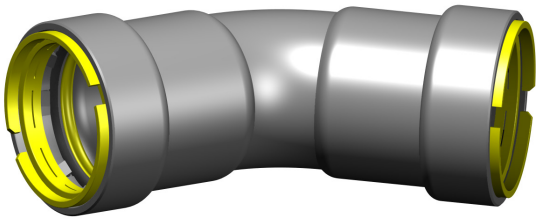

45° ELBOW
406G (2 x Press)

Part No.	Nom. Size (inches)	l1/l2	z1/z2	r
PWR7481531	1/2	1.59	0.45	0.98
PWR7481540	3/4	1.81	0.57	1.18
PWR7481551	1	2.13	0.69	1.50
PWR7481562	1-1/4	2.78	0.85	1.77
PWR7481573	1-1/2	2.93	0.98	1.97
PWR7481584	2	3.31	1.22	2.56

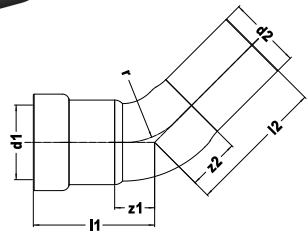
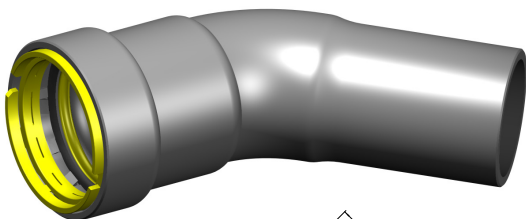

45° STREET ELBOW
406-2G (Press x Male)

Part No.	Nom. Size (inches)	l1	l2	z1	z2	r
PWR7481595	1/2 x 1/2	1.59	2.13	0.45	0.98	0.98
PWR7481606	3/4 x 3/4	1.81	2.26	0.57	1.02	1.18
PWR7481617	1 x 1	2.13	2.68	0.69	1.24	1.50
PWR7481628	1-1/4 x 1-1/4	2.78	3.15	0.85	1.22	1.77
PWR7481639	1-1/2 x 1-1/2	2.93	3.11	0.98	1.16	1.97
PWR7481641	2 x 2	3.31	3.80	1.22	1.71	2.56

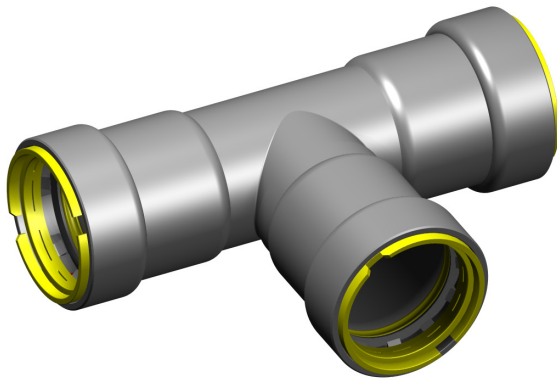

TEE
411G (3 x Press)

Part No.	Nom. Size (inches)	I1/I2	I3	z1/z2	z3
PWR7481650	1/2	2.05	2.09	0.91	1.02
PWR7481661	3/4	2.24	2.30	1.08	1.14
PWR7481672	1	2.60	2.66	1.24	1.30
PWR7481683	1-1/4	3.23	3.35	1.30	1.50
PWR7481694	1-1/2	3.48	3.50	1.61	1.63
PWR7481705	2	3.78	3.92	1.77	1.91

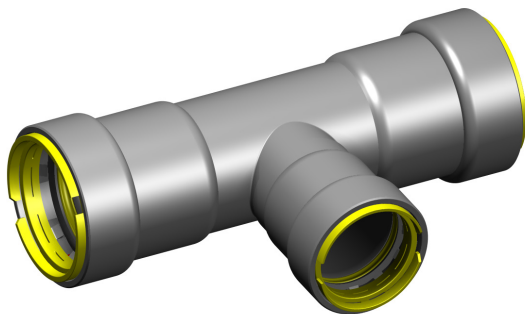
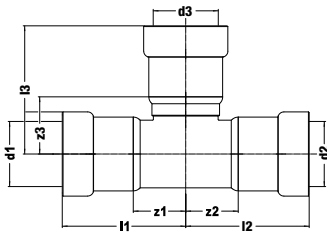

REDUCING OUTLET/BRANCH TEE
411RG (3 x Press)

Part No.	Nom. Size (inches)	I1/I2	I3	z1/z2	z3
PWR7481716	3/4 x 3/4 x 1/2	2.24	2.19	1.08	1.12
PWR7481727	1 x 1 x 1/2	2.60	2.34	1.24	1.28
PWR7481738	1 x 1 x 3/4	2.60	2.46	1.24	1.30
PWR7481749	1-1/4 x 1-1/4 x 1	3.23	2.31	1.38	1.46
PWR7481751	1-1/2 x 1-1/2 x 1/2	3.48	2.58	1.61	1.52
PWR7481760	1-1/2 x 1-1/2 x 3/4	3.48	2.69	1.61	1.53
PWR7481771	1-1/2 x 1-1/2 x 1	3.48	2.89	1.61	1.54
PWR7481782	1-1/2 x 1-1/2 x 1-1/4	3.48	2.43	1.61	1.57
PWR7481793	2 x 2 x 1/2	3.78	2.87	1.77	1.81
PWR7481804	2 x 2 x 3/4	3.78	2.99	1.77	1.83
PWR7481815	2 x 2 x 1	3.78	3.19	1.77	1.83
PWR7481826	2 x 2 x 1-1/4	3.78	3.72	1.77	1.87
PWR7481837	2 x 2 x 1-1/2	3.78	3.80	1.77	1.93

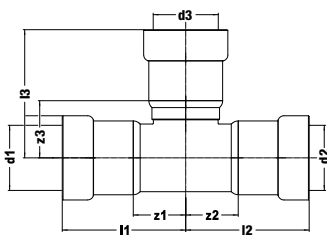

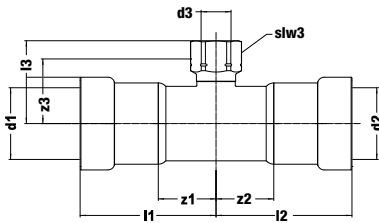
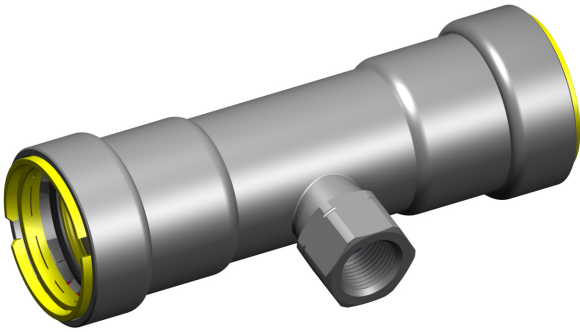

TEE w/ FEMALE THREAD OUTLET/BRANCH
4712G (Press x Female Thread x Press)

Part No.	Nom. Size (inches)	l1/l2	l3	z1/z2	z3	slw2
PWR7481848	3/4 x 3/4 x FPT 1/2	2.26	1.65	1.02	1.34	1.10
PWR7481859	3/4 x 3/4 x FPT 3/4	2.26	1.71	1.02	1.37	1.26
PWR7481861	1 x 1 x FPT 1/2	2.62	1.81	1.18	1.50	1.10
PWR7481870	1 x 1 x FPT 3/4	2.62	1.87	1.18	1.53	1.26
PWR7481881	1-1/4 x 1-1/4 x FPT 1/2	3.23	1.97	1.30	1.65	1.26
PWR7481892	1-1/2 x 1-1/2 x FPT 1/2	3.50	2.05	1.56	1.73	1.10
PWR7481903	1-1/2 x 1-1/2 x FPT 3/4	3.50	2.11	1.56	1.76	1.26
PWR7481914	1-1/2 x 1-1/2 x FPT 1	3.50	2.26	1.56	1.85	1.61
PWR7481925	1-1/2 x 1-1/2 x FPT 1-1/4	3.50	2.36	1.56	1.94	1.97
PWR7481936	2 x 2 x FPT 1/2	3.80	2.34	1.71	2.03	1.10
PWR7481947	2 x 2 x FPT 3/4	3.80	2.40	1.71	2.06	1.26
PWR7481958	2 x 2 x FPT 1	3.80	2.56	1.71	2.15	1.61
PWR7481971	2 x 2 x FPT 1-1/4	3.80	2.66	1.71	2.24	1.97
PWR7480682	2 x 2 x FPT 1-1/2	3.80	2.66	1.71	2.24	2.36

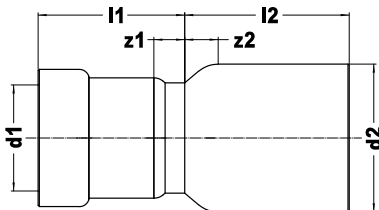
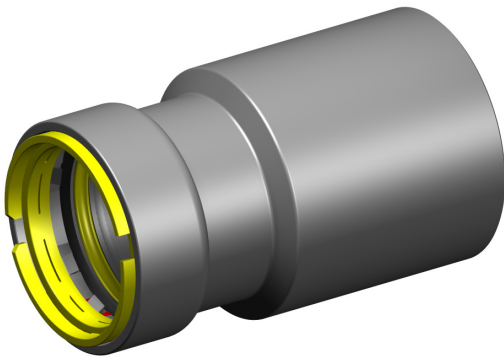

FITTING REDUCER
418G (Male x Press)

Part No.	Nom. Size (inches)	l1	l2	z1	z2
PWR7481980	3/4 x 1/2	1.26	1.26	0.12	0.02
PWR7481991	1 x 1/2	1.26	1.44	0.12	0.00
PWR7482002	1 x 3/4	1.42	1.30	0.18	-0.14
PWR7482013	1-1/4 x 1	1.63	1.73	0.20	-0.20
PWR7482024	1-1/2 x 3/4	1.87	2.42	0.63	0.47
PWR7482035	1-1/2 x 1	1.63	1.79	0.20	-0.16
PWR7482046	1-1/2 x 1-1/4	2.17	1.67	0.24	-0.28
PWR7482057	2 x 1	2.07	2.64	0.63	0.55
PWR7482068	2 x 1-1/4	2.17	1.79	0.24	-0.30
PWR7482079	2 x 1-1/2	2.13	1.81	0.18	-0.28

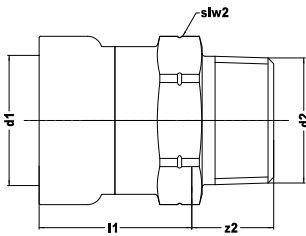
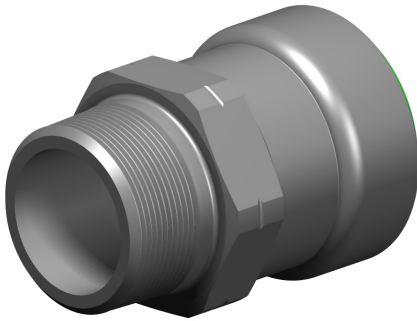

MALE THREAD ADAPTER
404G (Press x Male Thread)

Part No.	Nom. Size (inches)	l1	z2	slw2
PWR7482081	1/2 x MPT 1/2	1.12	0.98	1.10
PWR7482090	3/4 x MPT 3/4	1.22	0.98	1.42
PWR7482101	1 x MPT 1	1.42	1.10	1.61
PWR7482112	1-1/4 x MPT 1-1/4	1.91	1.14	1.97
PWR7482123	1-1/2 x MPT 1-1/2	1.93	1.12	2.36
PWR7482134	2 x MPT 2	2.07	1.16	2.76

FEMALE THREAD ADAPTER
403G (Press x Female Thread)

Part No.	Nom. Size (inches)	l1	l2	z1	z2	slw2
PWR7482145	1/2 x FPT 1/2	1.22	0.61	0.08	0.00	1.10
PWR7482156	3/4 x FPT 1/2	1.30	0.67	0.06	0.06	1.42
PWR7482167	3/4 x FPT 3/4	1.32	0.63	0.08	0.00	1.42
PWR7482178	1 x FPT 1/2	1.57	0.67	0.14	0.06	1.61
PWR7482189	1 x FPT 3/4	1.52	0.69	0.08	0.06	1.61
PWR7482191	1 x FPT 1	1.54	0.75	0.10	0.00	1.61
PWR7482200	1-1/4 x FPT 1/2	2.17	0.67	0.24	0.06	1.97
PWR7482211	1-1/4 x FPT 3/4	2.11	0.69	0.18	0.06	1.97
PWR7482222	1-1/4 x FPT 1	2.03	0.83	0.10	0.08	1.97
PWR7482233	1-1/4 x FPT 1-1/4	1.91	0.89	0.00	0.00	1.97
PWR7482244	1-1/2 x FPT 1/2	2.26	0.67	0.31	0.06	2.36
PWR7482255	1-1/2 x FPT 3/4	2.20	0.69	0.26	0.06	2.36
PWR7482266	1-1/2 x FPT 1	2.13	0.83	0.18	0.08	2.36
PWR7482277	1-1/2 x FPT 1-1/4	2.03	0.85	0.08	0.08	2.36
PWR7482288	1-1/2 x FPT 1-1/2	2.05	0.77	0.10	0.00	2.36
PWR7482299	2 x FPT 1/2	2.54	0.67	0.45	0.06	2.76
PWR7482301	2 x FPT 3/4	2.48	0.69	0.39	0.06	2.76
PWR7482310	2 x FPT 1	2.40	0.83	0.31	0.08	2.76
PWR7482321	2 x FPT 1-1/4	2.30	0.85	0.22	0.08	2.76
PWR7482332	2 x FPT 1-1/2	2.22	0.85	0.14	0.08	2.76
PWR7482343	2 x FPT 2	2.19	0.79	0.10	0.00	2.76

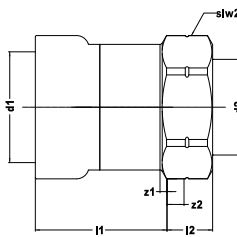
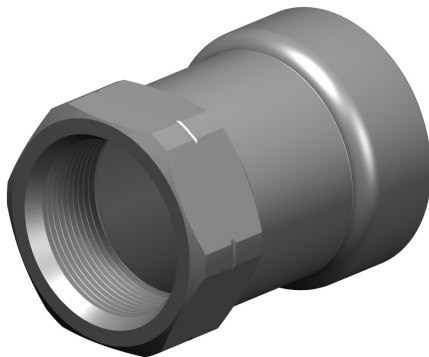

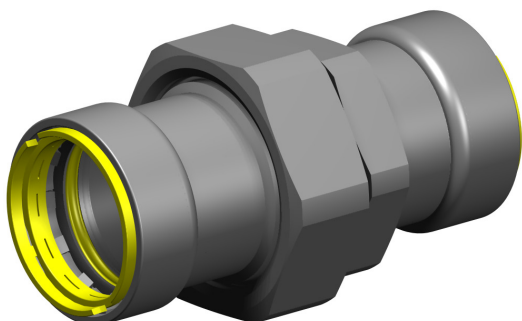

UNION
4733G (Press x Press)

Part No.	Nom. Size (inches)	l1	l2	z1	z2	slw1	slw2
PWR7482354	1/2	1.73	0.59	2.11	1.14	1.61	0.45
PWR7482365	3/4	1.93	0.69	2.17	1.24	1.61	0.49
PWR7482376	1	2.20	0.77	2.48	1.44	2.17	0.57
PWR7482387	1-1/4	2.17	0.24	2.85	1.93	2.76	0.76
PWR7482398	1-1/2	3.03	1.08	2.81	1.95	2.76	0.77
PWR7482409	2	3.31	1.22	3.23	2.09	3.35	0.82

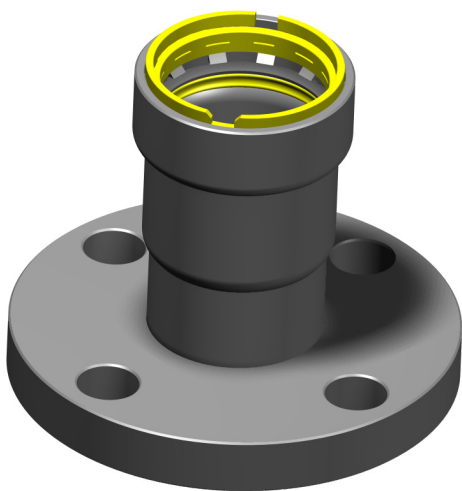
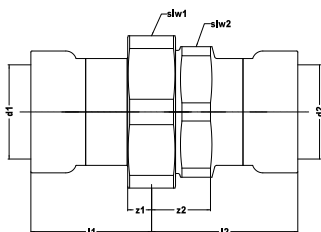

FLANGE ADAPTER CLASS 150
4771G (I x Press)

Part No.	Nom. Size (inches)	l1	l2	z1	z2	slw1	slw2	Holes
PWR7482411	1/2	2.44	0.39	1.30	0.40	3.54	0.63	4
PWR7482420	3/4	2.64	0.31	1.40	0.45	3.94	0.63	4
PWR7482431	1	2.95	0.22	1.52	0.51	4.33	0.63	4
PWR7482442	1-1/4	3.58	0.14	1.65	0.59	4.53	0.63	4
PWR7482453	1-1/2	3.82	0.10	1.87	0.65	4.92	0.63	4
PWR7482464	2	3.92	1.30	1.83	0.71	5.91	0.75	4

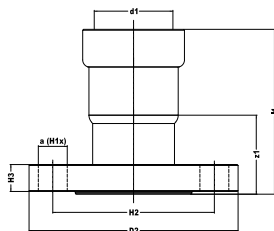

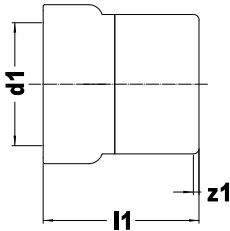
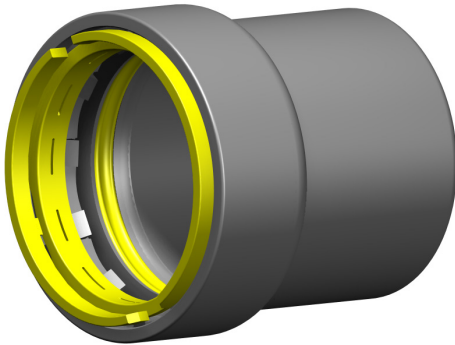

CAP
417G (1 x Press)

Part No.	Nom. Size (inches)	l1	z1
PWR7482475	1/2	1.40	0.26
PWR7482486	3/4	1.50	0.26
PWR7482497	1	1.71	0.28
PWR7482508	1-1/4	2.20	0.28
PWR7482519	1-1/2	2.28	0.33
PWR7482521	2	2.40	0.31

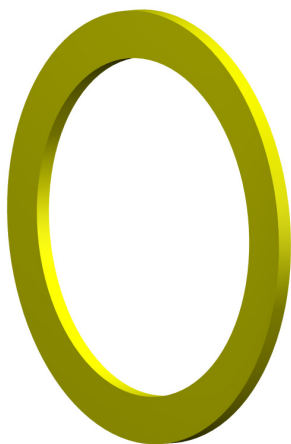

FLAT SEAL
PWR7452G (Yellow, HNBR)

Part No.	Nom. Size (inches)
PWR7481983	1/2 & 3/4
PWR7482004	1
PWR7482015	1-1/4 & 1-1/2
PWR7482037	2

The maximum working temperature of the flat seal is 194°F

Phone: (704) 841-6000

Fax: (704) 841-6020



SUBMITTAL PACKAGE

Dimensional Documentation

"Apollo" Piping Systems

"Apollo"®

POWERPRESS

Approved Applications



Hydronic Heating



Chilled Water



Compressed Air



Low Pressure Steam



Fire Sprinkler **(Coming Soon)**



Fuel Gas **(Gas Series Only | HNBR)**

**NON-
GAS**



FITTINGS

89FV Series

PowerPress Ball Valve

SUBMITTAL SHEET

"Apollo" POWERPRESS



Job Name:	
Job Location:	
Engineer:	
Contractor:	
Tag:	
PO#:	
Rep:	
Wholesale Dist.:	



DESCRIPTION

The Apollo PowerPress Ball Valve is ideal for installation in chilled water, compressed air, hydronic heating and fire sprinkler (coming soon) applications. This valve design significantly reduces installation time and helps maintain a clean working environment. The Apollo PowerPress is designed for steel pipe, schedules 10 to 40, as defined by ASTM A53, A106, A135 and A795 standards.

FEATURES

- Patented Visual Inspection Ring & Indicator
- Full-Port Flow
- Adjustable Stem Packing
- Fast, Reliable, Economical Press Installation
- Ridgid® & Milwaukee Press Tool Compatible
- Leak Before Press® Technology
- Blow-Out Proof Stem
- Corrosion Resistant Materials
- 100% Factory Tested
- Silicone Free Assembly
- Made in USA, ARRA Compliant

PERFORMANCE RATING

- Maximum Operating Pressure 200 psi
- Temperature Range: -40°F - 302°F

APPROVED APPLICATIONS

- Chilled Water
- Hydronic Heating (50% glycol max)
- Low Pressure Steam, 15 psi max
- Compressed Air
- Fire Sprinkler Applications (Coming Soon)
- Not suitable for flammable gas service

OPTIONS

- 01: Standard (PTFE Packing, RPTFE Body Seal)
- 02: Grounded Stem
- 04: 2-1/4 inch Stem Extension
- 11: THERMA-SEAL® Insulating Tee Handle
- 14: Side Vented Ball (Uni-Directional)
- 24: Graphite Stem Packing
- 27: SS Latch-Lock Lever and Nut
- 32: SS Tee Handle and Nut
- 39: SS Hi-Rise Locking Wheel Handle with SS Nut
- 45: Less Lever and Nut
- 47: SS Latch Lock Oval Handle
- 48: SS Oval Handle (No Latch)
- 49: Assembled Dry
- 60: Grounded Ball and Stem

DIMENSIONS (IN)

Part Number	Size	A	B	C	D	E	Wt (lbs.)
89FVE4301	1/2"	0.50	2.08	4.16	1.74	3.85	0.6
89FVE4401	3/4"	0.75	2.28	4.55	1.96	3.85	0.9
89FVE4501	1"	1.00	2.72	5.44	2.29	4.76	1.4
89FVE4601	1-1/4"	1.25	3.41	6.82	3.20	7.76	4.2
89FVE4701	1-1/2"	1.50	3.62	7.24	3.30	7.76	4.8
89FVE4801	2"	2.00	3.93	7.85	3.68	7.76	7.2

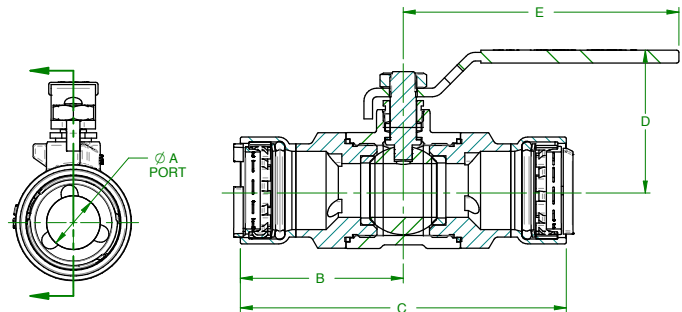

STANDARD MATERIAL SPECIFICATIONS:

Part Name	Material
Body	ASTM A216-WCB Carbon Steel
Seat	Reinforced PTFE
Ball	ASTM A276-316 Stainless Steel
Stem Packing	Multi-Fill PTFE
Nut	Corrosion Resistant Plated Steel
Stem	ASTM A276-316 Stainless Steel
Retainer	ASTM A108-12L14 Carbon Steel
O-Ring	EPDM
Handle	Plated Steel/Insulated Polyvinyl
Gland	ASTM A108-1215 Carbon Steel
Stem Bearing	Reinforced PTFE
Body Seal	PTFE

Customer Service (704) 841-6000
www.apolloflowcontrols.com

This specification is provided for reference only. Apollo Flow Controls reserves the right to change any portion of this specification without notice and without incurring obligation to make such changes to Apollo products previously or subsequently sold. Please visit apolloflowcontrols.com for the most current information.



SUBMITTAL PACKAGE

Dimensional Documentation

"Apollo" Piping Systems

"Apollo"®

POWERPRESS

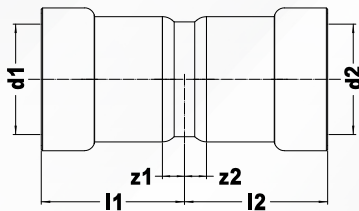

COUPLING WITH STOP
400 (2 x Press)

Part No.	Nom. Size (inches)	l1/l2	z1/z2
PWR7480000	1/2	1.34	0.20
PWR7480011	3/4	1.48	0.24
PWR7480022	1	1.67	0.24
PWR7480033	1-1/4	2.20	0.28
PWR7480044	1-1/2	2.28	0.33
PWR7480055	2	2.40	0.31

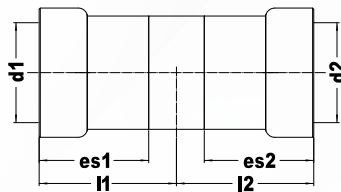

COUPLING WITHOUT STOP
401 (2 x Press)

Part No.	Nom. Size (inches)	l1/l2	es1/es2
PWR7480066	1/2	1.54	1.14
PWR7480077	3/4	1.63	1.24
PWR7480088	1	1.83	1.44
PWR7480099	1-1/4	2.32	1.93
PWR7480101	1-1/2	2.46	1.95
PWR7480110	2	2.56	2.09

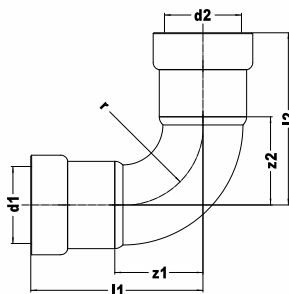

90° ELBOW
407 (2 x Press)

Part No.	Nom. Size (inches)	l1/l2	z1/z2	r
PWR7480121	1/2	2.17	1.02	0.98
PWR7480132	3/4	2.50	1.26	1.18
PWR7480143	1	3.01	1.57	1.50
PWR7480154	1-1/4	3.82	1.89	1.77
PWR7480165	1-1/2	4.09	2.15	1.97
PWR7480176	2	4.80	2.72	2.56

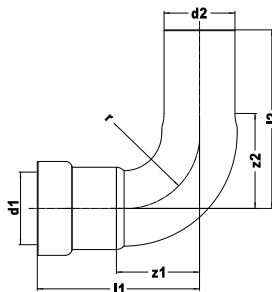

90° ELBOW
407-2 (Press x Male)

Part No.	Nom. Size (inches)	l1	l2	z1	z2	r
PWR7480187	1/2	2.17	2.70	1.02	1.56	0.98
PWR7480198	3/4	2.50	2.95	1.26	1.71	1.18
PWR7480209	1	3.01	3.56	1.57	2.13	1.50
PWR7480211	1-1/4	3.82	4.19	1.89	2.26	1.77
PWR7480220	1-1/2	4.09	4.27	2.15	2.32	1.97
PWR7480231	2	4.80	5.30	2.72	3.21	2.56

SUBMITTAL PACKAGE

Dimensional Documentation

"Apollo" Piping Systems

"Apollo"®

POWERPRESS

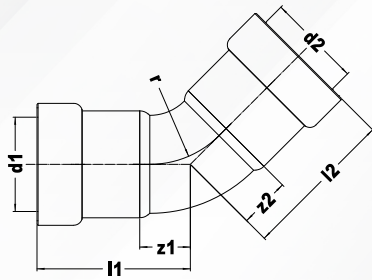

45° ELBOW
406 (2 x Press)

Part No.	Nom. Size (inches)	l1/l2	z1/z2	r
PWR7480242	1/2	1.59	0.45	0.98
PWR7480253	3/4	1.81	0.57	1.18
PWR7480264	1	2.13	0.69	1.50
PWR7480275	1-1/4	2.78	0.85	1.77
PWR7480286	1-1/2	2.93	0.98	1.97
PWR7480297	2	3.31	1.22	2.56

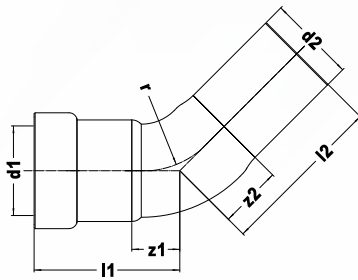

45° STREET ELBOW
406-2 (Press x Male)

Part No.	Nom. Size (inches)	l1	l2	z1	z2	r
PWR7480306	1/2 x 1/2	1.59	2.13	0.45	0.98	0.98
PWR7480319	3/4 x 3/4	1.81	2.26	0.57	1.02	1.18
PWR7480321	1 x 1	2.13	2.68	0.69	1.24	1.50
PWR7480330	1-1/4 x 1-1/4	2.78	3.15	0.85	1.22	1.77
PWR7480341	1-1/2 x 1-1/2	2.93	3.11	0.98	1.16	1.97
PWR7480352	2 x 2	3.31	3.80	1.22	1.71	2.56

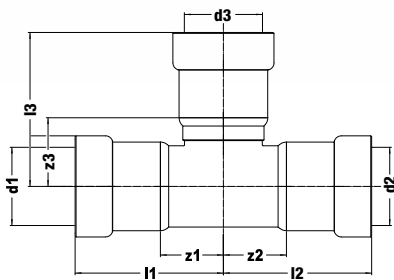

TEE
411 (3 x Press)

Part No.	Nom. Size (inches)	l1/l2	l3	z1/z2	z3
PWR7480363	1/2	2.05	2.09	0.91	1.02
PWR7480374	3/4	2.24	2.30	1.08	1.14
PWR7480385	1	2.60	2.66	1.24	1.30
PWR7480396	1-1/4	3.23	3.35	1.30	1.50
PWR7480407	1-1/2	3.48	3.50	1.61	1.63
PWR7480418	2	3.78	3.92	1.77	1.91

SUBMITTAL PACKAGE

Dimensional Documentation

"Apollo" Piping Systems

"Apollo"®

POWERPRESS

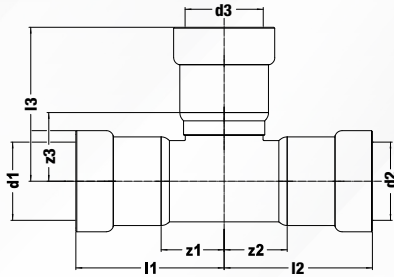

REDUCING OUTLET/BRANCH TEE
411R (3 x Press)

Part No.	Nom. Size (inches)	l1/l2	l3	z1/z2	z3
PWR7480429	3/4 x 3/4 x 1/2	2.24	2.19	1.08	1.12
PWR7480431	1 x 1 x 1/2	2.60	2.34	1.24	1.28
PWR7480440	1 x 1 x 3/4	2.60	2.46	1.24	1.30
PWR7480451	1-1/4 x 1-1/4 x 1	3.23	2.31	1.38	1.46
PWR7480462	1-1/2 x 1-1/2 x 1/2	3.48	2.58	1.61	1.52
PWR7480473	1-1/2 x 1-1/2 x 3/4	3.48	2.69	1.61	1.53
PWR7480484	1-1/2 x 1-1/2 x 1	3.48	2.89	1.61	1.54
PWR7480495	1-1/2 x 1-1/2 x 1-1/4	3.48	2.43	1.61	1.57
PWR7480506	2 x 2 x 1/2	3.78	2.87	1.77	1.81
PWR7480517	2 x 2 x 3/4	3.78	2.99	1.77	1.83
PWR7480528	2 x 2 x 1	3.78	3.19	1.77	1.83
PWR7480539	2 x 2 x 1-1/4	3.78	3.72	1.77	1.87
PWR7480541	2 x 2 x 1-1/2	3.78	3.80	1.77	1.93

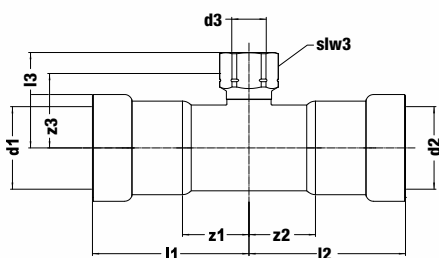

TEE w/ FEMALE THREAD OUTLET/BRANCH
4712 (Press x Female Thread x Press)

Part No.	Nom. Size (inches)	l1/l2	l3	z1/z2	z3	slw2
PWR7480550	3/4 x 3/4 x FPT 1/2	2.26	1.65	1.02	1.34	1.10
PWR7480561	3/4 x 3/4 x FPT 3/4	2.26	1.71	1.02	1.37	1.26
PWR7480572	1 x 1 x FPT 1/2	2.62	1.81	1.18	1.50	1.10
PWR7480583	1 x 1 x FPT 3/4	2.62	1.87	1.18	1.53	1.26
PWR7480594	1-1/4 x 1-1/4 x FPT 1/2	3.23	1.97	1.30	1.65	1.26
PWR7480605	1-1/2 x 1-1/2 x FPT 1/2	3.50	2.05	1.56	1.73	1.10
PWR7480616	1-1/2 x 1-1/2 x FPT 3/4	3.50	2.11	1.56	1.76	1.26
PWR7480627	1-1/2 x 1-1/2 x FPT 1	3.50	2.26	1.56	1.85	1.61
PWR7480638	1-1/2 x 1-1/2 x FPT 1-1/4	3.50	2.36	1.56	1.94	1.97
PWR7480649	2 x 2 x FPT 1/2	3.80	2.34	1.71	2.03	1.10
PWR7480651	2 x 2 x FPT 3/4	3.80	2.40	1.71	2.06	1.26
PWR7480660	2 x 2 x FPT 1	3.80	2.56	1.71	2.15	1.61
PWR7480671	2 x 2 x FPT 1-1/4	3.80	2.66	1.71	2.24	1.97
PWR7480682	2 x 2 x FPT 1-1/2	3.80	2.66	1.71	2.24	2.36

SUBMITTAL PACKAGE

Dimensional Documentation

"Apollo" Piping Systems

"Apollo"®

POWERPRESS

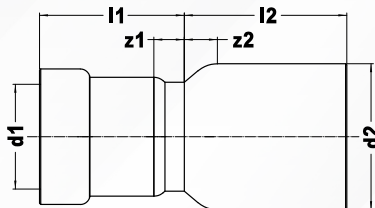

FITTING REDUCER
418 (Male x Press)

Part No.	Nom. Size (inches)	l1	l2	z1	z2
PWR7480693	3/4 x 1/2	1.26	1.26	0.12	0.02
PWR7480704	1 x 1/2	1.26	1.44	0.12	0.00
PWR7480715	1 x 3/4	1.42	1.30	0.18	-0.14
PWR7480748	1-1/4 x 1	1.63	1.73	0.20	-0.20
PWR7480761	1-1/2 x 3/4	1.87	2.42	0.63	0.47
PWR7480770	1-1/2 x 1	1.63	1.79	0.20	-0.16
PWR7480781	1-1/2 x 1-1/4	2.17	1.67	0.24	-0.28
PWR7480814	2 x 1	2.07	2.64	0.63	0.55
PWR7480825	2 x 1-1/4	2.17	1.79	0.24	-0.30
PWR7480836	2 x 1-1/2	2.13	1.81	0.18	-0.28

FEMALE THREAD ADAPTER
403 (Press x Female Thread)

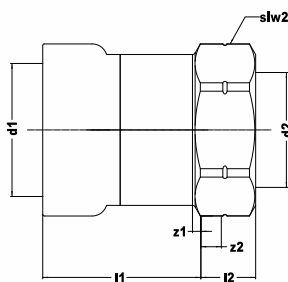

Part No.	Nom. Size (inches)	l1	l2	z1	z2	slw2
PWR7480902	1/2 x FPT 1/2	1.22	0.61	0.08	0.00	1.10
PWR7480913	3/4 x FPT 1/2	1.30	0.67	0.06	0.06	1.42
PWR7480924	3/4 x FPT 3/4	1.32	0.63	0.08	0.00	1.42
PWR7480935	1 x FPT 1/2	1.57	0.67	0.14	0.06	1.61
PWR7480946	1 x FPT 3/4	1.52	0.69	0.08	0.06	1.61
PWR7480957	1 x FPT 1	1.54	0.75	0.10	0.00	1.61
PWR7480968	1-1/4 x FPT 1/2	2.17	0.67	0.24	0.06	1.97
PWR7480979	1-1/4 x FPT 3/4	2.11	0.69	0.18	0.06	1.97
PWR7480981	1-1/4 x FPT 1	2.03	0.83	0.10	0.08	1.97
PWR7480990	1-1/4 x FPT 1-1/4	1.91	0.89	0.00	0.00	1.97
PWR7481001	1-1/2 x FPT 1/2	2.26	0.67	0.31	0.06	2.36
PWR7481012	1-1/2 x FPT 3/4	2.20	0.69	0.26	0.06	2.36
PWR7481023	1-1/2 x FPT 1	2.13	0.83	0.18	0.08	2.36
PWR7481034	1-1/2 x FPT 1-1/4	2.03	0.85	0.08	0.08	2.36
PWR7481045	1-1/2 x FPT 1-1/2	2.05	0.77	0.10	0.00	2.36
PWR7481056	2 x FPT 1/2	2.54	0.67	0.45	0.06	2.76
PWR7481067	2 x FPT 3/4	2.48	0.69	0.39	0.06	2.76
PWR7481078	2 x FPT 1	2.40	0.83	0.31	0.08	2.76
PWR7481089	2 x FPT 1-1/4	2.30	0.85	0.22	0.08	2.76
PWR7481091	2 x FPT 1-1/2	2.22	0.85	0.14	0.08	2.76
PWR7481100	2 x FPT 2	2.19	0.79	0.10	0.00	2.76

SUBMITTAL PACKAGE

Dimensional Documentation

"Apollo" Piping Systems

"Apollo"®

POWERPRESS

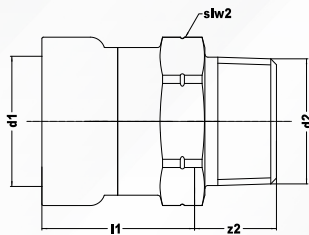

MALE THREAD ADAPTER
404 (Press x Male Thread)

Part No.	Nom. Size (inches)	l1	z2	slw2
PWR7480847	1/2 x MPT 1/2	1.12	0.98	1.10
PWR7480858	3/4 x MPT 3/4	1.22	0.98	1.42
PWR7480869	1 x MPT 1	1.42	1.10	1.61
PWR7480871	1-1/4 x MPT 1-1/4	1.91	1.14	1.97
PWR7480880	1-1/2 x MPT 1-1/2	1.93	1.12	2.36
PWR7480891	2 x MPT 2	2.07	1.16	2.76

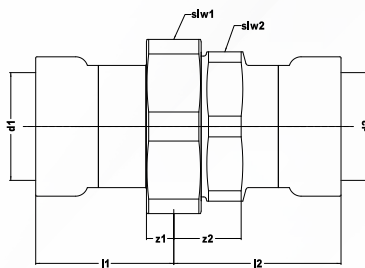

UNION
4733 (Press x Press)

Part No.	Nom. Size (inches)	l1	l2	z1	z2	slw1	slw2
PWR7481111	1/2	1.73	0.59	2.11	1.14	1.61	0.45
PWR7481122	3/4	1.93	0.69	2.17	1.24	1.61	0.49
PWR7481133	1	2.20	0.77	2.48	1.44	2.17	0.57
PWR7481144	1-1/4	2.17	0.24	2.85	1.93	2.76	0.76
PWR7481155	1-1/2	3.03	1.08	2.81	1.95	2.76	0.77
PWR7481166	2	3.31	1.22	3.23	2.09	3.35	0.82

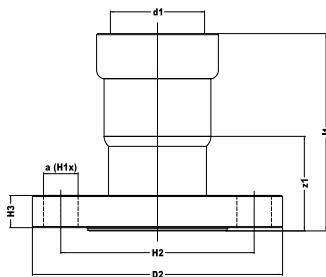

FLANGE ADAPTER CLASS 150
4771 (l x Press)

Part No.	Nom. Size (inches)	l1	l2	z1	z2	slw1	slw2	Holes
PWR7481177	1/2	2.44	0.39	1.30	0.40	3.54	0.63	4
PWR7481188	3/4	2.64	0.31	1.40	0.45	3.94	0.63	4
PWR7481199	1	2.95	0.22	1.52	0.51	4.33	0.63	4
PWR7481201	1-1/4	3.58	0.14	1.65	0.59	4.53	0.63	4
PWR7481210	1-1/2	3.82	0.10	1.37	0.65	4.92	0.63	4
PWR7481221	2	3.92	1.30	1.83	0.71	5.91	0.75	4

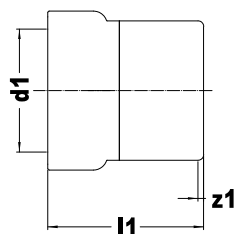

CAP
417 (l x Press)

Part No.	Nom. Size (inches)	l1	z1
PWR7481232	1/2	1.40	0.26
PWR7481243	3/4	1.50	0.26
PWR7481254	1	1.71	0.28
PWR7481265	1-1/4	2.20	0.28
PWR7481276	1-1/2	2.28	0.33
PWR7481287	2	2.40	0.31

GAS



FITTINGS

89FV Series | Gas

PowerPress Ball Valve

SUBMITTAL SHEET

"Apollo" POWERPRESS



Job Name:	
Job Location:	
Engineer:	
Contractor:	
Tag:	
PO#:	
Rep:	
Wholesale Dist.:	



DESCRIPTION

The Apollo PowerPress 89FV Gas Ball Valve is ideal for installation in compressed air and fuel gas applications. This valve design significantly reduces installation time and helps maintain a clean working environment. The Apollo PowerPress is designed for steel pipe, schedules 10 to 40, as defined by ASTM A53, A106, A135 and A795 standards.

FEATURES

- Patented Visual Inspection Ring & Indicator
- Full-Port Flow
- Adjustable Stem Packing
- Fast, Reliable, Economical Press Installation
- Ridgid® & Milwaukee Press Tool Compatible
- Leak Before Press® Technology
- Blow-Out Proof Stem
- Corrosion Resistant Materials
- 100% Factory Tested
- Silicone Free Assembly
- Made in USA, ARRA Compliant

PERFORMANCE RATING

- Maximum Operating Pressure:
125 psi max for fuel gas applications
200 psi max for other approved applications
- Temperature Range: -40°F - 194°F

APPROVALS

- ANSI LC 4/CSA 6.32
- IAPMO LC 4

APPROVED APPLICATIONS

- Compressed Air
- Fuel Gas

OPTIONS

- 01: Standard (PTFE Packing, RPTFE Body Seal)
- 02: Grounded Stem
- 04: 2-1/4 inch Stem Extension
- 11: THERMA-SEAL® Insulating Tee Handle
- 14: Side Vented Ball (Uni-Directional)
- 24: Graphite Stem Packing
- 27: SS Latch-Lock Lever and Nut
- 32: SS Tee Handle and Nut
- 39: SS Hi-Rise Locking Wheel Handle with SS Nut
- 45: Less Lever and Nut
- 47: SS Latch Lock Oval Handle
- 48: SS Oval Handle (No Latch)
- 49: Assembled Dry
- 60: Grounded Ball and Stem

DIMENSIONS (IN)

Part Number	Size	A	B	C	D	E	Wt (lbs.)
89FVH4301	1/2"	0.50	2.08	4.16	1.74	3.85	0.6
89FVH4401	3/4"	0.75	2.28	4.55	1.96	3.85	0.9
89FVH4501	1"	1.00	2.72	5.44	2.29	4.76	1.4
89FVH4601	1-1/4"	1.25	3.41	6.82	3.20	7.76	4.2
89FVH4701	1-1/2"	1.50	3.62	7.24	3.30	7.76	4.8
89FVH4801	2"	2.00	3.93	7.85	3.68	7.76	7.2

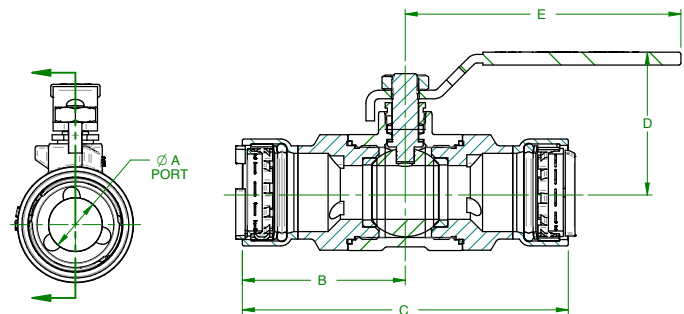

STANDARD MATERIAL SPECIFICATIONS:

Part Name	Material
Body	ASTM A216-WCB Carbon Steel
Seat	Reinforced PTFE
Ball	ASTM A276-316 Stainless Steel
Stem Packing	Multi-Fill PTFE
Nut	Corrosion Resistant Plated Steel
Stem	ASTM A276-316 Stainless Steel
Retainer	ASTM A108-12L14 Carbon Steel
O-Ring	HNBR (yellow)
Handle	Plated Steel/Insulated Polyvinyl
Gland	ASTM A108-1215 Carbon Steel
Stem Bearing	Reinforced PTFE
Body Seal	PTFE

Customer Service (704) 841-6000
www.apolloflowcontrols.com

This specification is provided for reference only. Apollo Flow Controls reserves the right to change any portion of this specification without notice and without incurring obligation to make such changes to Apollo products previously or subsequently sold. Please visit apolloflowcontrols.com for the most current information.



SUBMITTAL PACKAGE

Dimensional Documentation

"Apollo" Piping Systems

"Apollo"®

POWERPRESS

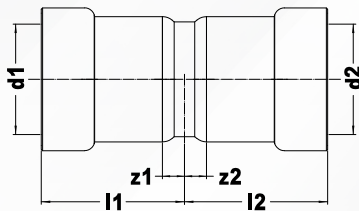

COUPLING WITH STOP
400G (2 x Press)

Part No.	Nom. Size (inches)	l1/l2	z1/z2
PWR7481298	1/2	1.34	0.20
PWR7481309	3/4	1.48	0.24
PWR7481311	1	1.67	0.24
PWR7481320	1-1/4	2.20	0.28
PWR7481331	1-1/2	2.28	0.33
PWR7481342	2	2.40	0.31

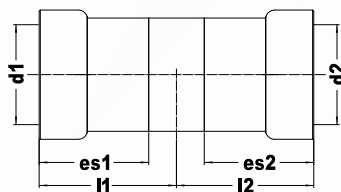

COUPLING WITHOUT STOP
401G (2 x Press)

Part No.	Nom. Size (inches)	l1/l2	es1/es2
PWR7481353	1/2	1.54	1.14
PWR7481364	3/4	1.63	1.24
PWR7481375	1	1.83	1.44
PWR7481386	1-1/4	2.32	1.93
PWR7481397	1-1/2	2.46	1.95
PWR7481408	2	2.56	2.09

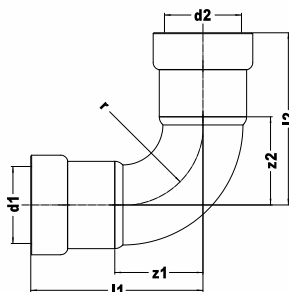

90° ELBOW
407G (2 x Press)

Part No.	Nom. Size (inches)	l1/l2	z1/z2	r
PWR7481419	1/2	2.17	1.02	0.98
PWR7481421	3/4	2.50	1.26	1.18
PWR7481430	1	3.01	1.57	1.50
PWR7481441	1-1/4	3.82	1.89	1.77
PWR7481452	1-1/2	4.09	2.15	1.97
PWR7481463	2	4.80	2.72	2.56

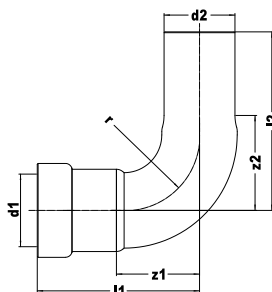

90° ELBOW
407-2G (Press x Male)

Part No.	Nom. Size (inches)	l1	l2	z1	z2	r
PWR7481474	1/2	2.17	2.70	1.02	1.56	0.98
PWR7481485	3/4	2.50	2.95	1.26	1.71	1.18
PWR7481496	1	3.01	3.56	1.57	2.13	1.50
PWR7481507	1-1/4	3.82	4.19	1.89	2.26	1.77
PWR7481518	1-1/2	4.09	4.27	2.15	2.32	1.97
PWR7481529	2	4.80	5.30	2.72	3.21	2.56

SUBMITTAL PACKAGE

Dimensional Documentation

"Apollo" Piping Systems

"Apollo"®

POWERPRESS

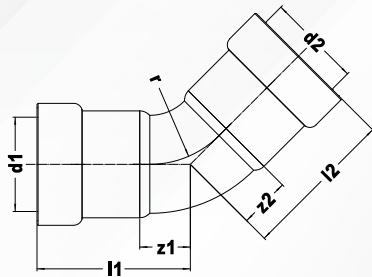

45° ELBOW
406 (2 x Press)

Part No.	Nom. Size (inches)	l1/l2	z1/z2	r
PWR7481531	1/2	1.59	0.45	0.98
PWR7481540	3/4	1.81	0.57	1.18
PWR7481551	1	2.13	0.69	1.50
PWR7481562	1-1/4	2.78	0.85	1.77
PWR7481573	1-1/2	2.93	0.98	1.97
PWR7481584	2	3.31	1.22	2.56

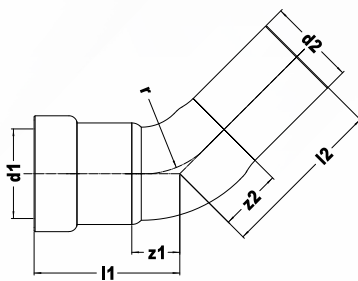

45° STREET ELBOW
406-2G (Press x Male)

Part No.	Nom. Size (inches)	l1	l2	z1	z2	r
PWR7481595	1/2 x 1/2	1.59	2.13	0.45	0.98	0.98
PWR7481606	3/4 x 3/4	1.81	2.26	0.57	1.02	1.18
PWR7481617	1 x 1	2.13	2.68	0.69	1.24	1.50
PWR7481628	1-1/4 x 1-1/4	2.78	3.15	0.85	1.22	1.77
PWR7481639	1-1/2 x 1-1/2	2.93	3.11	0.98	1.16	1.97
PWR7481641	2 x 2	3.31	3.80	1.22	1.71	2.56

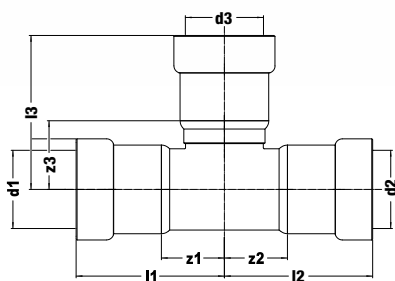

TEE
411G (3 x Press)

Part No.	Nom. Size (inches)	l1/l2	l3	z1/z2	z3
PWR7481650	1/2	2.05	2.09	0.91	1.02
PWR7481661	3/4	2.24	2.30	1.08	1.14
PWR7481672	1	2.60	2.66	1.24	1.30
PWR7481683	1-1/4	3.23	3.35	1.30	1.50
PWR7481694	1-1/2	3.48	3.50	1.61	1.63
PWR7481705	2	3.78	3.92	1.77	1.91

SUBMITTAL PACKAGE

Dimensional Documentation

"Apollo" Piping Systems

"Apollo"®

POWERPRESS

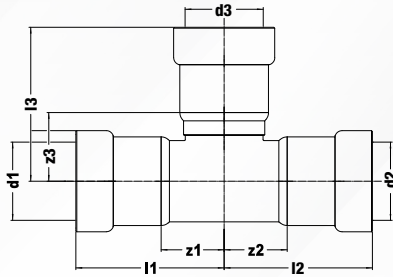

REDUCING OUTLET/BRANCH TEE 411RG (3 x Press)

Part No.	Nom. Size (inches)	l1/l2	l3	z1/z2	z3
PWR7481716	3/4 x 3/4 x 1/2	2.24	2.19	1.08	1.12
PWR7481727	1 x 1 x 1/2	2.60	2.34	1.24	1.28
PWR7481738	1 x 1 x 3/4	2.60	2.46	1.24	1.30
PWR7481749	1-1/4 x 1-1/4 x 1	3.23	2.31	1.38	1.46
PWR7481751	1-1/2 x 1-1/2 x 1/2	3.48	2.58	1.61	1.52
PWR7481760	1-1/2 x 1-1/2 x 3/4	3.48	2.69	1.61	1.53
PWR7481771	1-1/2 x 1-1/2 x 1	3.48	2.89	1.61	1.54
PWR7481782	1-1/2 x 1-1/2 x 1-1/4	3.48	2.43	1.61	1.57
PWR7481793	2 x 2 x 1/2	3.78	2.87	1.77	1.81
PWR7481804	2 x 2 x 3/4	3.78	2.99	1.77	1.83
PWR7481815	2 x 2 x 1	3.78	3.19	1.77	1.83
PWR7481826	2 x 2 x 1-1/4	3.78	3.72	1.77	1.87
PWR7481837	2 x 2 x 1-1/2	3.78	3.80	1.77	1.93

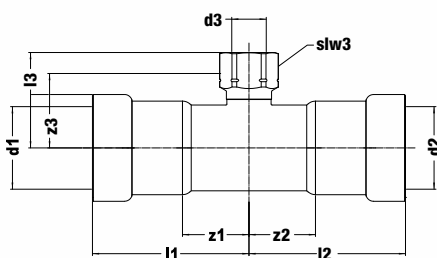

TEE w/ FEMALE THREAD OUTLET/BRANCH 4712G (Press x Female Thread x Press)

Part No.	Nom. Size (inches)	l1/l2	l3	z1/z2	z3	slw2
PWR7480550	3/4 x 3/4 x FPT 1/2	2.26	1.65	1.02	1.34	1.10
PWR7480561	3/4 x 3/4 x FPT 3/4	2.26	1.71	1.02	1.37	1.26
PWR7480572	1 x 1 x FPT 1/2	2.62	1.81	1.18	1.50	1.10
PWR7480583	1 x 1 x FPT 3/4	2.62	1.87	1.18	1.53	1.26
PWR7480594	1-1/4 x 1-1/4 x FPT 1/2	3.23	1.97	1.30	1.65	1.26
PWR7480605	1-1/2 x 1-1/2 x FPT 1/2	3.50	2.05	1.56	1.73	1.10
PWR7480616	1-1/2 x 1-1/2 x FPT 3/4	3.50	2.11	1.56	1.76	1.26
PWR7480627	1-1/2 x 1-1/2 x FPT 1	3.50	2.26	1.56	1.85	1.61
PWR7480638	1-1/2 x 1-1/2 x FPT 1-1/4	3.50	2.36	1.56	1.94	1.97
PWR7480649	2 x 2 x FPT 1/2	3.80	2.34	1.71	2.03	1.10
PWR7480651	2 x 2 x FPT 3/4	3.80	2.40	1.71	2.06	1.26
PWR7480660	2 x 2 x FPT 1	3.80	2.56	1.71	2.15	1.61
PWR7480671	2 x 2 x FPT 1-1/4	3.80	2.66	1.71	2.24	1.97
PWR7480682	2 x 2 x FPT 1-1/2	3.80	2.66	1.71	2.24	2.36

SUBMITTAL PACKAGE

Dimensional Documentation

"Apollo" Piping Systems

"Apollo"®

POWERPRESS

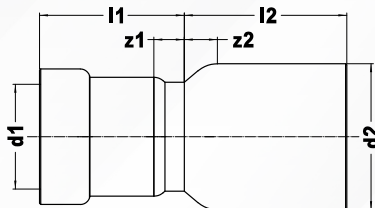

FITTING REDUCER 418G (Male x Press)

Part No.	Nom. Size (inches)	l1	l2	z1	z2
PWR7481980	3/4 x 1/2	1.26	1.26	0.12	0.02
PWR7481991	1 x 1/2	1.26	1.44	0.12	0.00
PWR7482002	1 x 3/4	1.42	1.30	0.18	-0.14
PWR7482013	1-1/4 x 1	1.63	1.73	0.20	-0.20
PWR7482024	1-1/2 x 3/4	1.87	2.42	0.63	0.47
PWR7482035	1-1/2 x 1	1.63	1.79	0.20	-0.16
PWR7482046	1-1/2 x 1-1/4	2.17	1.67	0.24	-0.28
PWR7482057	2 x 1	2.07	2.64	0.63	0.55
PWR7482068	2 x 1-1/4	2.17	1.79	0.24	-0.30
PWR7482079	2 x 1-1/2	2.13	1.81	0.18	-0.28

FEMALE THREAD ADAPTER 403G (Press x Female Thread)

Part No.	Nom. Size (inches)	l1	l2	z1	z2	slw2
PWR7482145	1/2 x FPT 1/2	1.22	0.61	0.08	0.00	1.10
PWR7482156	3/4 x FPT 1/2	1.30	0.67	0.06	0.06	1.42
PWR7482167	3/4 x FPT 3/4	1.32	0.63	0.08	0.00	1.42
PWR7482178	1 x FPT 1/2	1.57	0.67	0.14	0.06	1.61
PWR7482189	1 x FPT 3/4	1.52	0.69	0.08	0.06	1.61
PWR7482191	1 x FPT 1	1.54	0.75	0.10	0.00	1.61
PWR7482200	1-1/4 x FPT 1/2	2.17	0.67	0.24	0.06	1.97
PWR7482211	1-1/4 x FPT 3/4	2.11	0.69	0.18	0.06	1.97
PWR7482222	1-1/4 x FPT 1	2.03	0.83	0.10	0.08	1.97
PWR7482233	1-1/4 x FPT 1-1/4	1.91	0.89	0.00	0.00	1.97
PWR7482244	1-1/2 x FPT 1/2	2.26	0.67	0.31	0.06	2.36
PWR7482255	1-1/2 x FPT 3/4	2.20	0.69	0.26	0.06	2.36
PWR7482266	1-1/2 x FPT 1	2.13	0.83	0.18	0.08	2.36
PWR7482277	1-1/2 x FPT 1-1/4	2.03	0.85	0.08	0.08	2.36
PWR7482288	1-1/2 x FPT 1-1/2	2.05	0.77	0.10	0.00	2.36
PWR7482299	2 x FPT 1/2	2.54	0.67	0.45	0.06	2.76
PWR7482301	2 x FPT 3/4	2.48	0.69	0.39	0.06	2.76
PWR7482310	2 x FPT 1	2.40	0.83	0.31	0.08	2.76
PWR7482321	2 x FPT 1-1/4	2.30	0.85	0.22	0.08	2.76
PWR7482332	2 x FPT 1-1/2	2.22	0.85	0.14	0.08	2.76
PWR7482343	2 x FPT 2	2.19	0.79	0.10	0.00	2.76

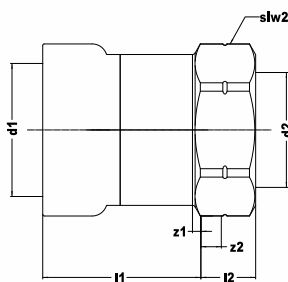

SUBMITTAL PACKAGE

Dimensional Documentation

"Apollo" Piping Systems

"Apollo"®

POWERPRESS

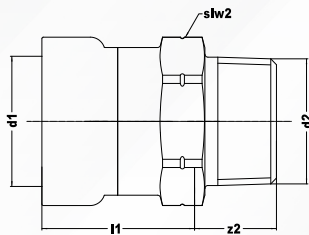

MALE THREAD ADAPTER 404G (Press x Male Thread)

Part No.	Nom. Size (inches)	l1	z2	slw2
PWR7482081	1/2 x MPT 1/2	1.12	0.98	1.10
PWR7482090	3/4 x MPT 3/4	1.22	0.98	1.42
PWR7482101	1 x MPT 1	1.42	1.10	1.61
PWR7482112	1-1/4 x MPT 1-1/4	1.91	1.14	1.97
PWR7482123	1-1/2 x MPT 1-1/2	1.93	1.12	2.36
PWR7482134	2 x MPT 2	2.07	1.16	2.76

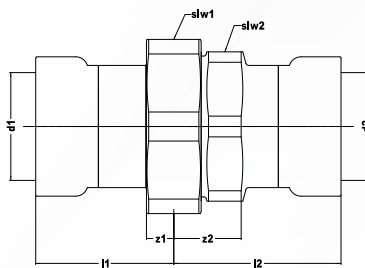

UNION 4733G (Press x Press)

Part No.	Nom. Size (inches)	l1	l2	z1	z2	slw1	slw2
PWR7482354	1/2	1.73	0.59	2.11	1.14	1.61	0.45
PWR7482365	3/4	1.93	0.69	2.17	1.24	1.61	0.49
PWR7482376	1	2.20	0.77	2.48	1.44	2.17	0.57
PWR7482387	1-1/4	2.17	0.24	2.85	1.93	2.76	0.76
PWR7482398	1-1/2	3.03	1.08	2.81	1.95	2.76	0.77
PWR7482409	2	3.31	1.22	3.23	2.09	3.35	0.82

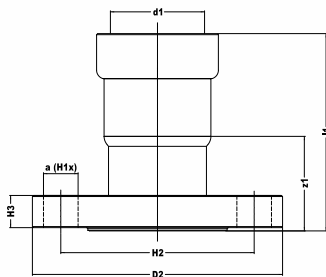

FLANGE ADAPTER CLASS 150 4771G (l x Press)

Part No.	Nom. Size (inches)	l1	l2	z1	z2	slw1	slw2	Holes
PWR7482411	1/2	2.44	0.39	2.38	0.40	3.54	0.63	4
PWR7482420	3/4	2.64	0.31	2.76	0.45	3.94	0.63	4
PWR7482431	1	2.95	0.22	3.13	0.51	4.33	0.63	4
PWR7482442	1-1/4	3.58	0.14	3.50	0.59	4.53	0.63	4
PWR7482453	1-1/2	3.82	0.10	3.88	0.65	4.92	0.63	4
PWR7482464	2	3.92	1.30	4.74	0.71	5.91	0.75	4

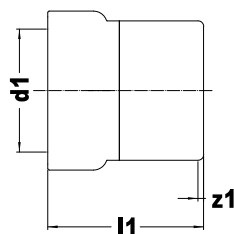

CAP 417G (l x Press)

Part No.	Nom. Size (inches)	l1	z1
PWR7482475	1/2	1.40	0.26
PWR7482486	3/4	1.50	0.26
PWR7482497	1	1.71	0.28
PWR7482508	1-1/4	2.20	0.28
PWR7482519	1-1/2	2.28	0.33
PWR7482521	2	2.40	0.31

SUBMITTAL PACKAGE

Installation Instructions

"Apollo" Piping Systems

"Apollo"®

POWERPRESS

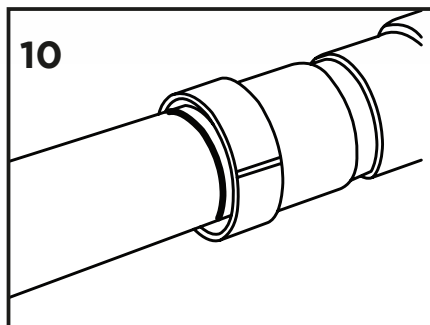
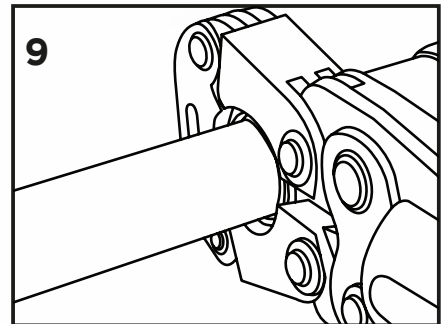
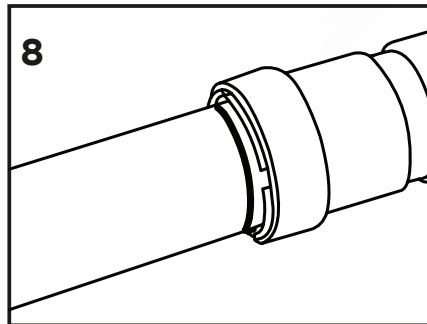
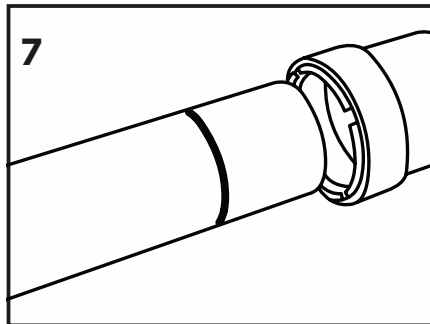
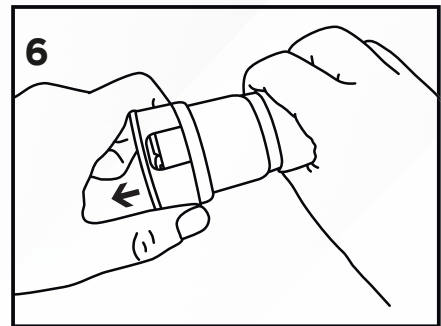
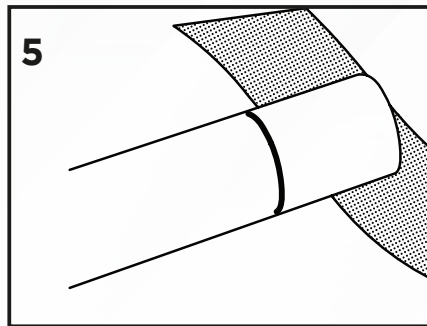
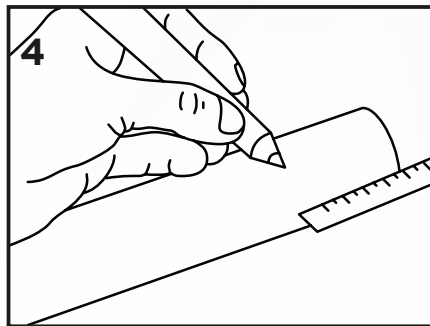
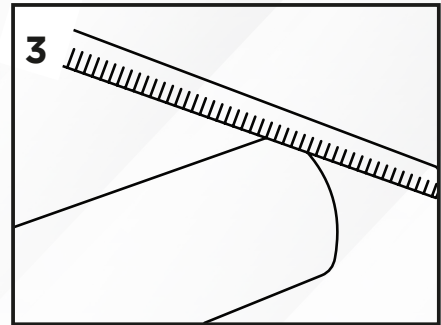
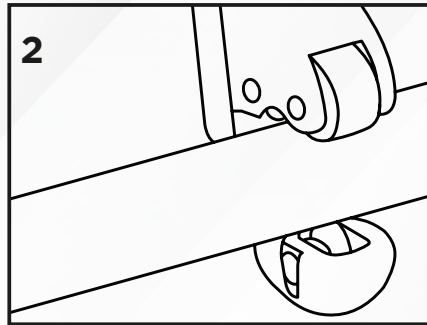
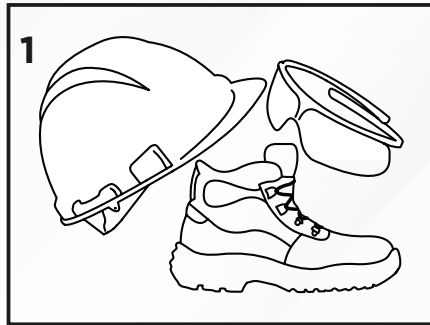

Always install in accordance with published instructions

TECHNICAL MANUAL

Engineering Specifications

"Apollo" Piping Systems

"Apollo"®

POWERPRESS

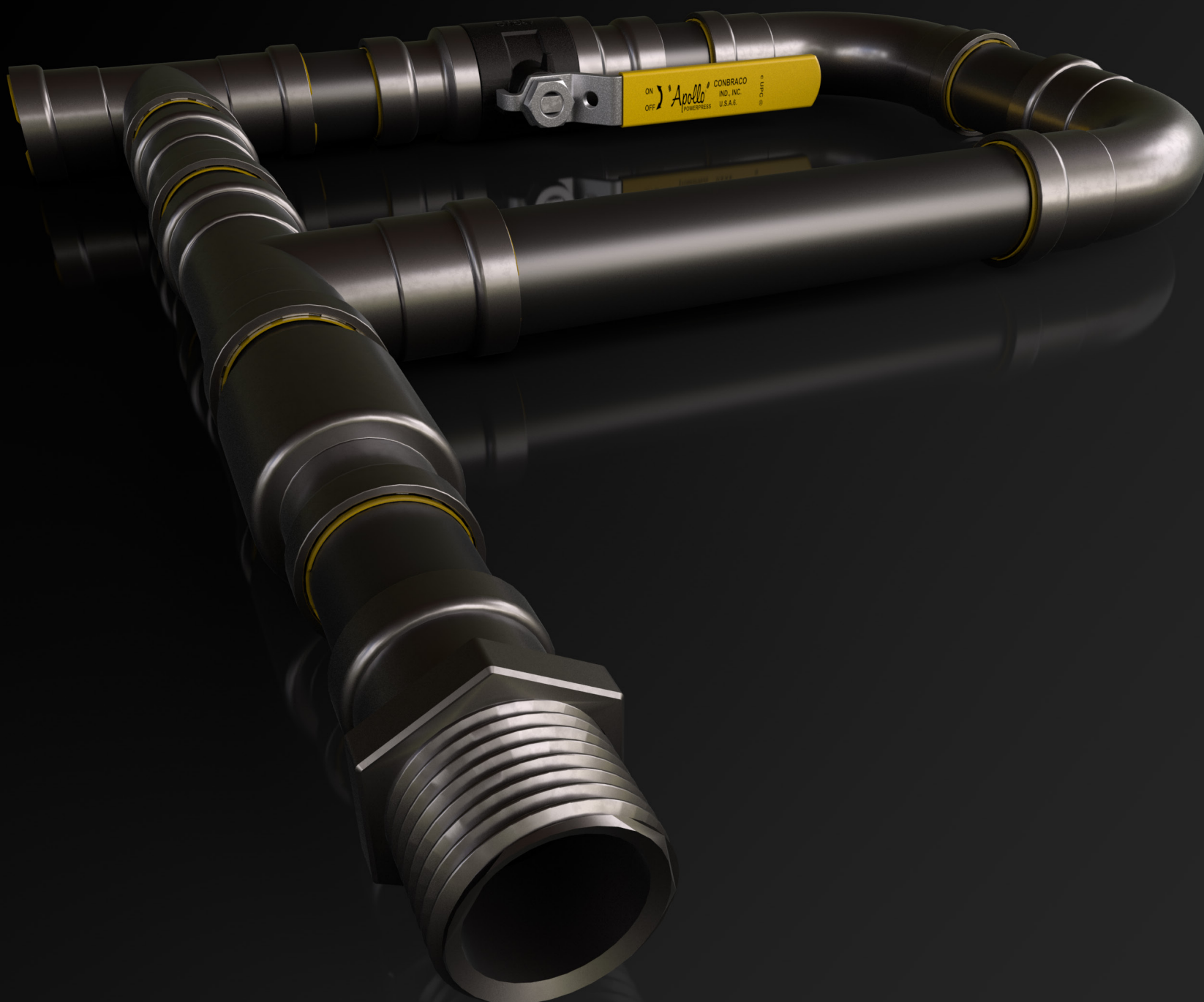

1 APOLLO POWERPRESS System

APOLLO POWERPRESS is a press and fitting system designed for thick wall steel pipe as defined by ASTM A53, A106, A135, A795 (schedule 10 to 40) standards. The APOLLO POWERPRESS system significantly reduces installation times and helps maintain a clean working environment.

APOLLO POWERPRESS products are manufactured using advanced fully automated modern machinery. This ensures a consistent, safe, high quality product. 100% of welded components undergo a leak test ensuring issue free installations in the field. In addition, all straight connectors with threaded ends are made from a single piece, thus eliminating potential leaks.

Fitting quality is validated per national and international standards. Quality certifications can be provided for gas and sprinkler installations.

We guarantee quality fittings with consistent dimensional measurements.

APOLLO POWERPRESS Advantages:

- Simple, fast connections
- Size ranges from 1/2" to 2"
- Compact fittings for recessed work
- Visual Press Indicator
- Clear identification of materials of construction
- Leak Before Press® feature (ensures visible leakage of non-pressed fittings)
- Suitable for heating, cooling, steam, sprinkler (coming soon) and gas installations
- Full line of integrated valves (eliminates need for adaptors)

The APOLLO POWERPRESS system offers a complete solution with a wide range of flexibility. The system can be utilized on standard steel pipe and can be used with different brands of press tools.

2 Advantages of APOLLO POWERPRESS

Reliable:

The integrity of the APOLLO POWERPRESS connection is determined by the tool and not the skill of the installer, thus installation errors are greatly reduced.

APOLLO POWERPRESS includes a Leak Before Press® feature (LBP). This feature ensures that unpressed fittings will visibly leak during the low pressure test, ensuring that the issue is resolved before commissioning.

All fittings also include a break-away ring: a visual control feature that will snap off when the fitting is properly pressed, giving immediate verification of a properly installed fitting. This feature eliminates the need to manually mark fittings as they are pressed, saving installation time and improving installation quality.

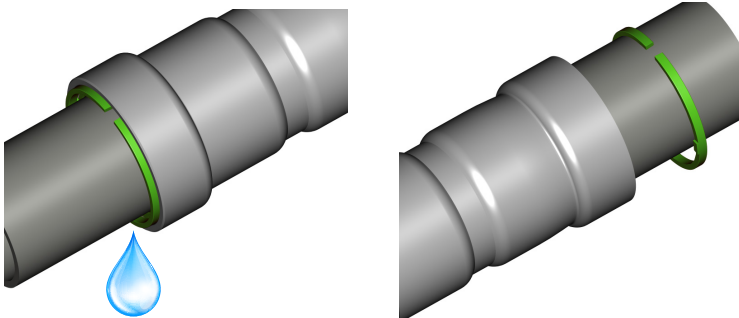

All O-ring sealing surfaces are designed to prevent leakage, even with uneven surfaces.



Easy and Clean:

When compared with other connection methods, APOLLO POWERPRESS is extremely user-friendly:

- Eliminating complicated clamping techniques
- Reducing preparation time
- Eliminating drying times
- Eliminating messy installations
- Eliminating threaded pipe connections
- Eliminating assembly lubrication
- Simplifying pipe insertion
- Eliminating issues associated with short bend radii

The simple process reduces the need for special skills and greatly improves the quality of the end product.

Safe:

Installations using the APOLLO POWERPRESS system do not require a heat source (as required with welding or soldering) and the tools utilized are not bulky and heavy as with some other systems. This makes APOLLO POWERPRESS the ideal solution for repair and renovation projects and ensures minimal disturbance to the existing piping system.

Fast:

The simple, fast connection technology results in considerable cost savings. The connections are made with a single press tool, thus eliminating the need for other materials such as gas, solder, adhesives, threading machines, etc.

3 Technical Data

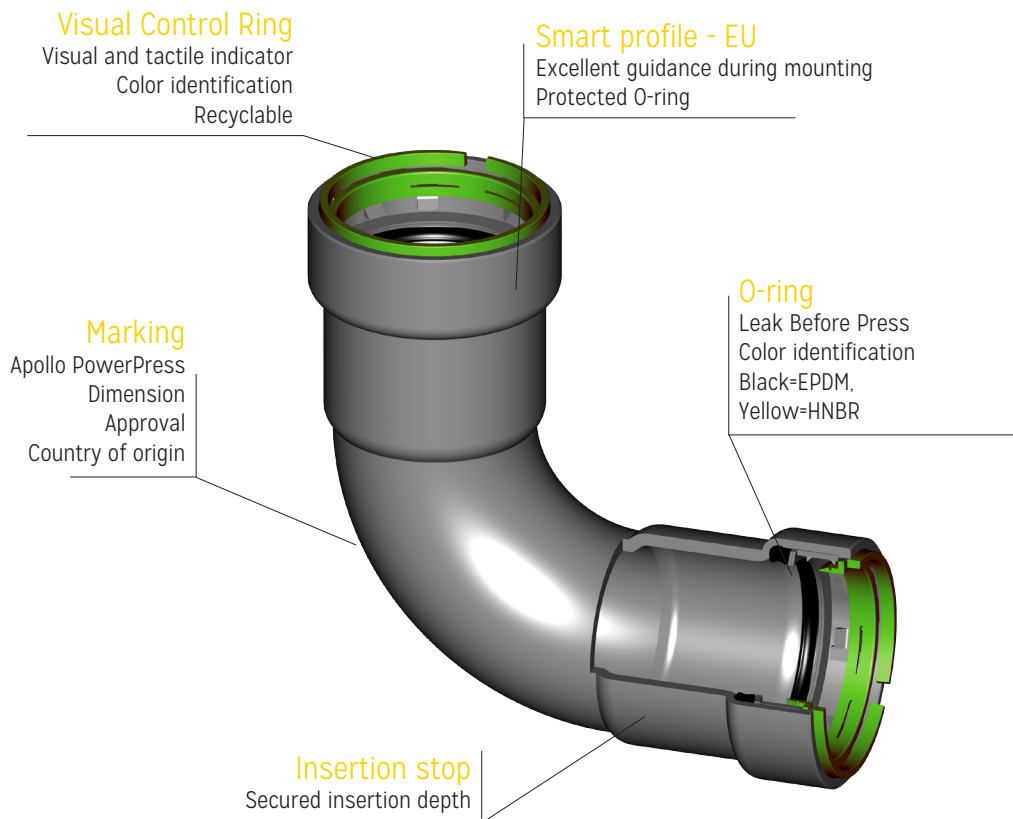

Approved Applications:

APOLLO POWERPRESS is approved for use in the following applications:



heating



cooling



compressed air



steam



sprinkler



gas

If your application is not listed, please contact Apollo Flow Controls regarding approval for your application. In all cases installations must comply with local regulations.

APOLLO POWERPRESS fittings possess the following industry approvals:

Approvals	Apollo PowerPress	Apollo PowerPress GAS
CSA LC-4	-	1/2" - 2"
FM 1630	3/4" - 2"	-
ICC-ES PMG1036	-	1/2" - 2"
ICC LC1002	1/2" - 2"	-
IAPMO LC-4	-	1/2" - 2"
IAPMO PSI17	1/2" - 2"	-
TSSA	1/2" - 2"	-
UL/ULc	1/2" - 2"	-

Table 1 - Industry Approvals

Material Selection and Operation Limits:

All APOLLO POWERPRESS fittings are produced from ASTM A106 Grade A steel and protected against corrosion by a zinc-nickel coating. The coating provides protection from condensation that can occur on cooling systems.

All fittings are offered with one of two O-ring options: EPDM (black) or HNBR (yellow). Reference Table 2 for proper O-ring and pipe selection as well as recommended operating limits. If your application is not shown in Table 2, please contact us to determine if the fittings are suitable for your application.

Application	O-rings	Operating Temperature (F°)	Max Intermittent Temperature (F°)	Max Operating Pressure (psig)	Steel Pipe Standards	Pipe Sizes (inch)
Central Heating	EPDM* (black)	-40 to 302	338	235	ASTM A53, A106, A135, A795 (Schedule 10-40)	1/2 - 2
Cooling Water						
Sprinkler	COMING SOON					
Compressed Air***	EPDM* (black)					
Gas	HNBR** (yellow)	-40 to 194	—	125	ASTM A53 (Schedule 40)	1/2 - 2

Table 2 - Apollo PowerPress Applications

*Ethylene Propylene Diene Monomer - For Hot and Cold Water, Circulation Pipes, Fire Mains, Compressed Air

**Hydrogenated Nitrile Butadiene Rubber - For Combustible Gases: Natural Gas and Liquid Gas

***Reference Table 3 For O-Ring Selection When Using Compressed Air

*Air Quality Class Per ISO 8573 Part 1	Water Content (mg/m ³)	Oil Content (mg/m ³)	O-Ring
1	3	0.01	EPDM
2	120	0.1	EPDM
3	880	1	EPDM
4	6000	5	EPDM
5	7800	25	EPDM
6	9400	>25	HNBR

Table 3 - O-Ring Selection for Compressed Air & ISO Class

When operating on Compressed Air:

Max allowed water content = 880 mg/m³ (Class 3 when tested per ISO8573 part 1)

Max allowed oil content = 25 mg/m³ (Class 5 when tested per ISO8573 part 1)

Compressed air systems must be properly tested when the installation is complete. The system designer and contractor must ensure that safe methods are selected for testing the system. The method must comply with all current health and safety regulations and may include pressure testing the system with fluids, compressed air or a combination of both. It is recommended that the maximum working pressure of the product never be exceeded under any circumstances during the process.

APOLLO POWERPRESS valves and fittings are suitable for both wet and dry fixed sprinkler systems. Always consult the corresponding approval for the latest release of APOLLO POWERPRESS for sprinkler installations.

The installation, inspection, testing and purging of gas installations should be in accordance with local codes or the authority having jurisdiction. In the absence of local codes, the installation should be in accordance with the International Fuel Gas Code, NFPA 54/ National Fuel Gas Code z2231, the Uniform Plumbing Code, NFPA 58 or CSA B 149.1.

Markings:

All APOLLO POWERPRESS fittings are clearly marked for easy identification and quality control. A color coding system is also employed to clearly identify the difference between standard fittings and gas fittings.

Apollo POWERPRESS fittings markings



Marking	Packaging label
Green Visual Control Ring	Type
Apollo POWERPRESS	Dimension
Approvals	Description
Dimension	Art. no.
Traceability code	Certificates
Country of origin	Quantity

Apollo POWERPRESS GAS fittings markings



Marking	Packaging label
Yellow Visual Control Ring	Type
Apollo POWERPRESS	Dimension
Approvals	Description
Working pressure	Art. no.
Dimension	Certificates
Traceability code	Quantity
Country of origin	

Threads:

The APOLLO POWERPRESS product range includes fittings with inner and outer threads. These threads are manufactured in accordance with DIN 2999/ISO 7/1 or ANSI/ASME B1.20.1. Hemp or other chloride-free sealants are suitable for sealing the threads of APOLLO POWERPRESS.

4 Installation Guidelines

Protective Equipment:

When installing APOLLO POWERPRESS always wear proper protective gear. At a minimum, safety shoes, hat, glasses and gloves should be worn.

Transportation and Storage:

When transporting and storing APOLLO POWERPRESS fittings, damage and contamination must be avoided. The optimal storage temperature for the fittings is between 50°F and 80°F. The products must be stored in a dry place (max. humidity 65%) in the original packaging until the time of installation.

Pipe Preparation:*Cutting Pipe To Length*

After measuring, the tubes can be cut to length using a tube cutter (see fig. 6), a fine-toothed handsaw or a mechanical saw with electrical motor suitable for the tube material. The tube must always be cut completely through. Never partially cut the tube and break it off as this could cause corrosion. When cutting already installed pipes, always take into account a minimum distance to weldings and bends. A minimum distance of 3 x outside pipe diameter is required (with a minimal length of 4").

DO NOT USE OIL-COOLED SAWS, GRINDING WHEELS OR FLAME CUTTERS.



FIGURE 6: CUTTING THE PIPE

Deburring Pipe

The tube ends must be carefully and thoroughly deburred inside and out after being cut to length. This prevents damage to the O-ring when inserting the tube into the press fitting. A file or hand deburrer suitable for the material or an electrical tube deburrer may be used. Burrs sticking to the tube must be removed.



FIGURE 7: DEBURRING THE PIPE

Marking Insertion Depth

The required insertion depth must be marked on the male end of the tube or the press fitting in order to guarantee a safe and proper joint. The marking on the tube must remain visible (but close to the fitting) after the connection is pressed. This is imperative to ensure the tensile strength of the joint.



FIGURE 8: MARKING INSERTION DEPTH

Surface Preparation

Pipe surfaces must be smooth, free of indentations, pits and deformations and must be clean and free of debris, rust, scale, paint, oil and grease. This can be achieved with a wire brush or fine grit sand paper. It is not necessary to completely remove protective coatings or to expose the bare steel material.

In order to prevent leaks, engraved or stamped pipe should not be used with the APOLLO POWERPRESS fitting system even if the engraving or stamping has been mechanically removed with a grinder or other means.

When using painted black (and lacquered) iron pipe, the pipes should be inspected for excessive paint runs. If runs exist, the surface of the pipe should be smoothed using a fine grit sand paper and wiped clean before installation.

Epoxy coatings on black steel pipe have the tendency to increase the outer dimension of the pipe. The thickness of the coating should be kept to a minimum to allow the installation of the APOLLO POWERPRESS fitting. The maximum allowed thickness of the epoxy coating is 0.0118 in. If the coating exceeds this dimension then the pipe can be sanded using a fine grit sand paper, but the surface of the pipe must be smooth.



Figure 1: Black Steel



Figure 2: Galvanized Steel

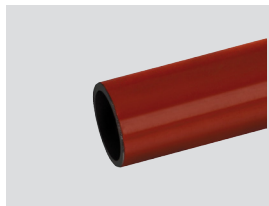

Figure 3: Epoxy Coated

After cleaning the surface you should see a clear metal surface.



FIGURE 9: CLEANING PIPE

Pre-Press Fitting Check:



Before assembly, remove the protective cap. The fitting must be checked to ensure that the O-rings are present and correctly positioned, and that the visual control ring is properly aligned. The pipe, fitting and O-ring must be examined for any foreign materials (e.g. dirt, burrs), which must be removed, if present.

FIGURE 9: SURFACE AFTER CLEANING



Pre-Press Assembly:

Insert the tube carefully into the press fitting up to the marked insertion depth, pushing it in the direction of the axis. Be careful not to cock or tilt the tube when inserting into the fitting. Failure to do so may result in damage to the O-ring seal. The insertion depth marking must remain visible. In the case of fittings without a stop, the fittings should be inserted at least as far as the marked insertion depth.

FIGURE 10: ASSEMBLY

If assembly is difficult due to snugness of fit, a lubricant such as water or soap may be used. Under no circumstances may oils, fats or grease be used as lubricants. Time may be saved by first assembling a number of connections and then pressing the various pipe connections one after the other. Before starting the final pressing process, it is important to check the minimum required distances for the installation to ensure that there is adequate room for the press tool to operate (See Table 4).

Fitting Size (in)	Insertion Depth e_s (in)	Minimum Distance d_{min} (in)	Minimum Pipe Length $2 \times e_s + d_{min}$ (in)
1/2	1.07	0.20/0.59*	2.48/2.87*
3/4	1.17	0.20/0.59*	2.68/3.07*
1	1.36	.2	3.07
1-1/4	1.85	0.39/0.59*	4.25/4.65*
1-1/2	1.87	0.39/0.59*	4.29/4.49*
2	2.01	0.39/0.59*	4.57/4.76*

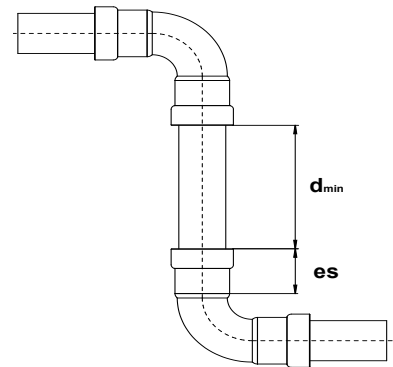

FIGURE 11

Outside ϕ (in)	Fig 12		Fig 13		Fig 14	
	a (in)	b (in)	a (in)	b (in)	c (in)	a_{min} (in)
1/2	2.76/2.95*	1.18/2.36*	3.15/2.95*	1.38/2.36*	1.97/3.15*	1.97/0.79*
3/4	3.15/3.35*	1.38/2.56*	3.54/3.35*	1.57/2.56*	2.17/3.15*	1.97/0.79*
1	3.74	1.77	4.13	1.97	2.56	1.97
1-1/4	4.92*	3.74*	4.92*	3.74*	3.15*	0.79*
1-1/2	5.31*	4.13*	5.31*	4.13*	3.15*	0.79*
2	5.51*	4.13*	5.51*	4.13*	3.15*	0.79*

Table 4 - Minimum Distance Between Press Joints (* For Slings)

Table 5 gives the minimum required working distance for correct tool operation as depicted in figures 12-14.

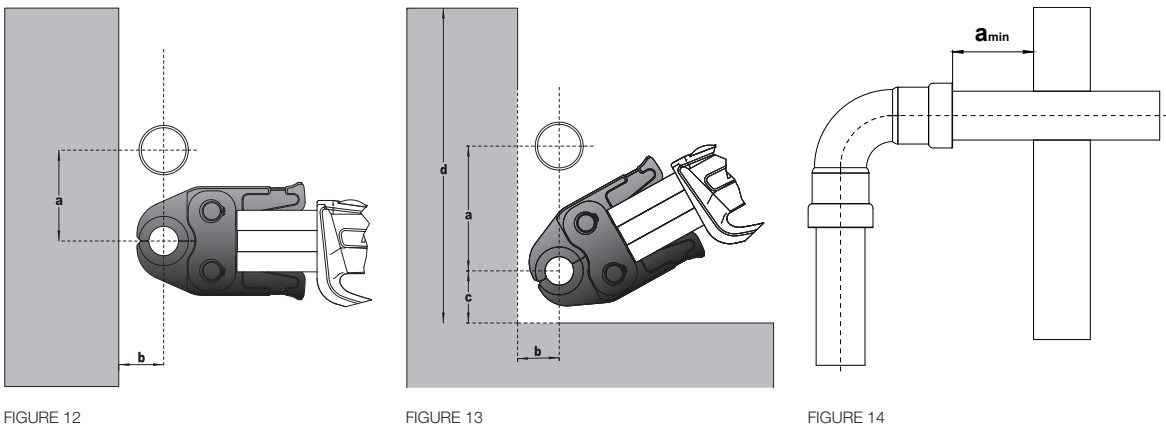

Table 5 - Space Needed For Installation

Pressing:

Press tools consist of a press machine and the corresponding press jaw or sling. Every joint in the system must be pressed in order to achieve a leak free system. Figure 5 shows a cross-section of the APOLLO POWERPRESS profile before and after pressing.

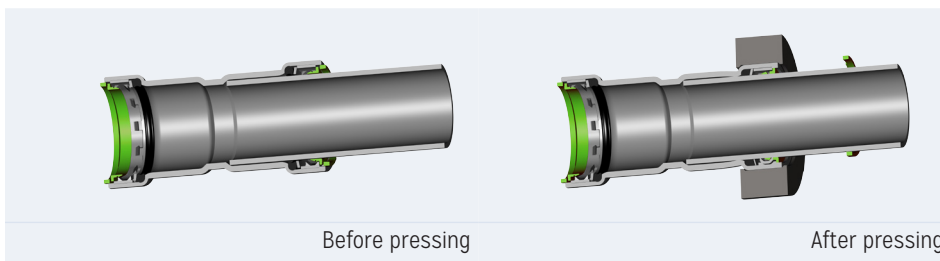

Figure 5: Before and After Pressing

Dimension	Manufacturer	Press Tool	Press jaws/slings
1/2"-2"	Novopress	EC01 Pressboy (230V) EC0201/202/203 (230V) AC01 Pressboy (12V) AC0202/203 (18V) EFP2 (230V) EFP201/202/203 (230V) AFP201/202 (14.4V) ACO202XL/203XL (18V)	Novopress jaws: 1/2"-1" Slings: 1-1/4"-2" with adapter ZB203
1/2"-2"	Milwaukee	M18 (18v)	Milwaukee M18 jaws: 1/2"-1" Milwaukee M18 Bip slings: 1-1/4"-2" with adapter V2
1/2"-2"	Ridgid	RP10-S (230V) RP10-B (12V) RP320 RP330C/330B RP340C/340B CT400	MegaPress jaws: 1/2"-1" (4299.9) MegaPress Slings: 1-1/4"-2" with adapter V2

Table 6 - Approved Press Tools for APOLLO POWERPRESS

Figure 15: Pressing



The sling profile that corresponds to the diameter of fitting being installed must be used. In some cases an adaptor may be required in addition to the press slings. Conbraco guarantees an excellent press connection, provided the tools are used correctly.

Before starting to press, the press jaws and slings must be checked for dirt, and cleaned if necessary. Furthermore, the press machine must be in good condition and the manufacturer's instructions must be observed.

In order to create a correctly pressed connection, the groove of the press tool must enclose the press fitting O-ring bead. Once the pressing has started, always complete the press cycle and under no circumstances interrupt the process. **It is not permitted to press a connection more than once.**

The pressing process can cause deflection (angular displacement). This behavior can be corrected by alternating the position of the press tool/jaw on each connection. For example place the machine first on the left side, then for the next connection the machine would be placed on the right side. The deflection of the joint is not something which can be prevented, but it can be minimized using the above method.

Press Tool Maintenance:

Regular maintenance and lubrication of the press jaws, slings and tools is necessary. Please observe the tool manufacturer's instructions for use and maintenance. Badly maintained and/or damaged press jaws pose a potential risk.

5 Post-Installation

Pressure Test:

Immediately after installation, the system should be checked for leaks prior to applying insulation, paint or other operations that may obstruct view of the piping joints.

Pressure tests must always be performed in accordance with local ordinances. The test medium and the results of the pressure test should be documented in a test report.

When testing an APOLLO POWERPRESS installation using water as the test media, make sure that no water remains in the system afterwards, in order to avoid the risk of corrosion.

Pressure test for natural gas, heating & cooling systems, and air

Pressure test for natural gas and liquid gas systems must be performed in accordance with local regulations.

Pressure test of sprinkler systems

Sprinkler system piping must be tested in accordance with local regulations such as NFPA 13 for at least two hours. NFPA 13 requires:

- Test Pressure to the greater of 200 psi or 50 psi above working pressure, measured at low point in the system.

Dry sprinkler systems must also be tested pneumatically to:

- A pressure of not less than 36 psi for at least 24 hours.
- Any leakage, which results in a pressure drop of more than 2 psi over the 24 h, must be corrected.

Any faults identified, such as permanent deformations, ruptures or leakages must be corrected and the above test must be repeated.

Flushing:

After installation, the system must be flushed thoroughly before being placed into service. This ensures that any foreign matter is removed from the system and helps prevent hygiene problems and corrosion damage.

In exceptional cases, it may be necessary to flush the system with a disinfecting substance.

When flushing with a disinfectant substance, special care must be taken to ensure that no chlorides remain on the inside of the pipes. Always make sure to flush with clean potable water.

Insulation:

The following must be observed when insulating steel piping systems:

- Cold water lines should be protected against condensation and overheating in accordance with DIN 1988, Part 200.
- Hot water lines must be insulated to prevent heat loss in accordance with the Energy-Conservation Act (EnEG).

Adequate measures should be employed to limit heat loss. Consult local authorities for regulations on minimum insulation thickness and standards.

Electric Heat Tracing:

APOLLO POWERPRESS may be used with electrical heat tracing in order to maintain the temperature of the piping. Sealed pipes should not be heated because of the danger posed by excessive increase in pressure.

(Main) Equipotential Bonding:

All metal piping systems using equipotential bonding must comply with equipotential bonding requirements as dictated by local ordinances. Continuity checks must be conducted by a qualified electrician once the installation work has been finished. APOLLO POWERPRESS in combination with the respective pipes are electrical conductive pipe systems due to the metal-to-metal contact between the fitting and pipe. Therefore, they must be included in the equipotential bonding assessment.

Corrosion Protection:

In cases where full corrosion protection is needed (such as cooling installations), always take care to protect the pipe surface that was sanded or polished during installation.

6 General Information

Thermal Expansion In Piping System:

The level of thermal expansion within piping systems depends on the type of materials used. This linear expansion needs to be taken into account during the piping design and installation. Small changes in length can be accommodated by having adequate space for expansion as well as by the elastic properties of the piping system itself. More substantial changes in length need to be offset by other means; e.g. installation of special expansion compensation devices, fixed anchoring points and brackets.

The effects of expansion can be offset by the use of a pipe segment (figure 15), U-bend (figure 17) or compensators. The level of expansion to be offset can be determined beforehand by calculating the changes in length. The equation for calculating the changes in length is as follows:

$$\Delta l = l \times \alpha \times \Delta T$$

Where:

Δl =Total Linear Expansion (in)

l =Length of Segment In Question (in)

ΔT =Change in Temperature (°F)

α =Thermal Expansion Coefficient (in/(in-°F))

In the case where major expansion occurs, expansion compensators are required, or in complicated cases, Ω -shaped compensation loops may be required. In these cases the compensation amount can be calculated as shown below:

$$B_d = k \times \sqrt{(d_e \times l)}$$

Where:

B_d =Expansion Length To Be Allowed (in)

k =Material Constant

d_e =External Diameter of Pipe (in)

Δl =Linear Expansion that Must Be Allowed (in)

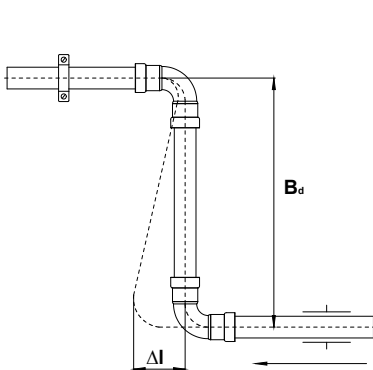

FIGURE 15

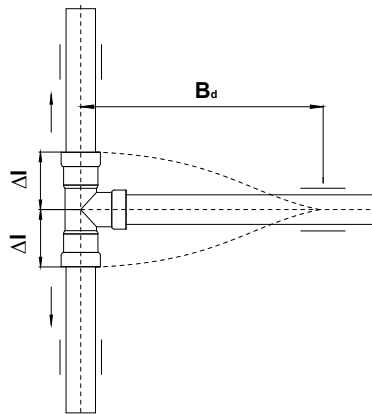

FIGURE 16

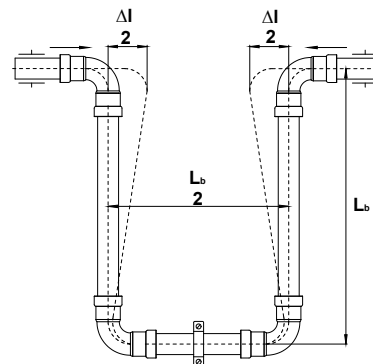

FIGURE 17

As shown in figures 15-17, the correct compensation of the expansion depends also on the placement of fixing devices, such as brackets and anchoring points. Never plan to or place fixed pipe mounting clips close to a pipe connection. The clips should be positioned so that they do not act as a fixed restraint. When there are straight segments of pipe, without expansion compensation, use only one saddle clip to prevent possible deformation. Position it as close to the middle of the straight segment as possible. This allows expansion in both directions and the length of the expansion equalizer required will be halved. It is recommended that pipe clips with a rubber inlay be used as this will muffle any possible noise and vibrations and better distribute stresses.

Pressure Drop:

Every fluid that flows through a piping system experiences continuous and local flow resistances or pressure drops. There is a difference between the continuous and the local pressure drop. A continuous pressure drop is mainly caused by the flow resistance in straight pipe sections, which is a result of the friction between the fluid and the pipe wall. Local pressure drops are those flow resistances that are created by a change in the internal pipe diameter, a pipe branch, an elbow, a valve, etc.

Continuous Pressure Drop

Continuous pressure drop in a straight section of pipe with a constant inside diameter can be calculated using the Darcy-Weisbach formula shown below:

$$\Delta_p = (f \times L \times v^2 \times \rho) / (2 \times D) + \rho \times g \times \Delta h$$

Where:

Δ_p = Pressure Drop Across Entire Length of Straight Pipe (Pa)

f = friction factor (unitless)

L = Total Length of Straight Pipe (m)

v = Velocity of Fluid Inside of Pipe (m/sec)

ρ = Density of Fluid (kg/m³)

d = Inside Diameter of Pipe (m)

g = Acceleration Due To Gravity (m/(sec²)) = 9.806 (m/(sec²))

Δh = Total Change In Elevation From One End of Pipe To Other (m)

The friction factor f is calculated via one of two methods depending on the value of the Reynolds Number Re.

If the calculated Reynolds Number Re is less than 2300 then the friction factor is calculated as follows:

$$f = 64 / Re$$

If the calculated Reynolds number is greater than 2300 but less than 100,000 then the friction factor can be calculated using the Blasius Correlation shown below:

$$f = (0.3164) / R_e^{0.25}$$

Reynolds number Re is calculated as follows:

$$R_e = (\rho \times v \times d) / \mu$$

Where:

Re = Reynolds Number (unitless)

ρ = Density of Fluid (kg/m³)

v = Fluid Velocity Inside of Pipe (m/sec)

d = Inside Diameter of Pipe (m)

μ = Dynamic Viscosity of the Fluid (kg/(sec m))

$$\mu = \nu \times \rho$$

Where:

ν = Kinematic Viscosity of the Fluid (m²/sec)

Common values for the viscosity of water are shown in Table 7. If using a fluid other than water, consult the published viscosity curves for the fluid you are using.

Fluid Type (@ °F)	Viscosity (cst)	Viscosity (m ² /sec)	Density (kg/m ³)
Water @ 32	1.792322618	1.7923E-06	999.82
Water @ 41	1.52	0.00000152	1000
Water @ 50	1.308300909	1.3083E-06	999.77
Water @ 60.8	1.110076774	1.1101E-06	999.03
Water @ 71.6	0.957048083	9.5705E-07	997.86
Water @ 80.6	0.854915261	8.5492E-07	996.59
Water @ 91.4	0.752945434	7.5295E-07	994.76
Water @ 100.4	0.682779456	6.8278E-07	993
Water @ 111.2	0.612735201	6.1274E-07	990.64
Water @ 120.2	0.562485457	5.6249E-07	988.47
Water @ 131	0.511337696	5.1134E-07	985.65
Water @ 140	0.475013477	4.7501E-07	983.13
Water @ 150.8	0.436779263	4.3678E-07	979.9
Water @ 161.6	0.403494219	4.0349E-07	976.47
Water @ 170.6	0.379060259	3.7906E-07	973.46
Water @ 181.4	0.352690035	3.5269E-07	969.69
Water @ 190.4	0.333191916	3.3319E-07	966.41
Water @ 201.2	0.312789018	3.1279E-07	962.31
Water @ 210.2	0.297252759	2.9725E-07	958.78
Water @ 212	0.294347894	2.9435E-07	958.05

Table 7

Velocity through the pipe is dependent on the Pipe Inner Diameter and volumetric flow rate and can be calculated as shown below:

$$V = Q/A$$

$$A = (\pi \times d^2)/4$$

$$V = (4 \times Q)/(\pi \times d^2)$$

Where:

A=Cross Sectional Area of Pipe Inner Diameter (m²)

Q=Volumetric Flow Rate (m³/sec)



Local Pressure Drop

A local pressure drop is the resistance to flow that results from changes in the flow direction, changes in cross-sectional area or flow splitting over several channels. There are two ways of calculating such pressure drops: the direct analytical method and the method that uses "equivalent lengths".

Unit Type	Measured Units	Multiply By	Resulting Units
Pressure	Atm	101325	Pa
	Bar	100000	
	In-Hg	3386.388	
	Kpa	1000	
	Mpa	1000000	
	PSI	6894.757	
Length	cm	0.01	m
	ft	0.3048	
	in	0.0254	
	km	1000	
	yards	0.9144	
Velocity	ft/hr	8.46667E-05	m/sec
	ft/min	0.00508	
	ft/sec	0.3048	
	km/hr	0.277778	
	km/min	16.66667	
	km/sec	1000	
	m/hr	0.000277778	
	m/min	0.01666667	
Density	g/cm ³	1000	kg/m ³
	g/m ³	0.001	
	lb/ft ³	16.01846	
	lb/in ³	27679.9	
Acceleration	cm/sec ²	0.01	m/sec ²
	ft/sec ²	0.3048	
	free fall g	9.80665	
	in/sec ²	0.0254	
Dynamic Viscosity	cP	0.001	kg/sec m
	Poise	0.1	
	lbf sec/ft ²	47.880259	
	lbf sec/in ²	6894.75729	
	reyn	6894.75729	
	slug/foot sec	47.880259	
Flow	N sec/m ²	1	m ³ /sec
	ft ³ /hr	7.86579E-06	
	ft ³ /min	0.000471947	
	ft ³ /sec	0.02831685	
	gal/day	4.38126E-08	
	gal/hr	1.0515E-06	
	gal/min	6.30902E-05	
	gal/sec	0.003785412	
	l/day	1.15741E-08	
	l/hr	2.7778E-07	
	l/min	1.66667E-05	
	l/sec	0.001	
	m ³ /day	1.12741E-05	
m ³ /hr	0.000277778		
m ³ /min	0.01666667		

Equivalent Length Method

The Equivalent Length method assumes that the pressure drop across a fitting or valve can be equated to a length of straight pipe of "equivalent length". This "equivalent length" or the sum of all of the equivalent lengths in the system can be added to the total length "l" from the Darcy-Weisbach formula listed above in order to calculate a total pressure drop for the system or the "equivalent length" can be plugged into the equation independently to determine the local pressure drop across the single fitting or valve. The equivalent lengths for APOLLO POWERPRESS fittings can be found in Table 9.

Pressure drop for entire system would be:

$$\Delta p = (f \times (l + \sum l_e) \times v^2 \times \rho) / (2 \times d) + \rho \times g \times \Delta h$$

Local Pressure drop for a single fitting would be:

$$\Delta p = (f \times l_e \times v^2 \times \rho) / (2 \times d)$$

Where:

l_e = Equivalent Length of Fitting (m)

Δp = Pressure Drop (Pa)

direct analytical method / equivalent length method (m)

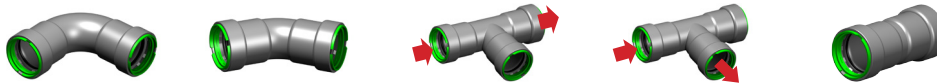

OD	DN	ζ	(m)	ζ	(m)	ζ	(m)	ζ	(m)	ζ	(m)
1/2"	10										
3/4"	12	0.61	0.37	0.51	0.32	0.38	0.24	0.96	0.59	0.32	0.20
1"	15	0.64	0.53	0.54	0.46	0.42	0.35	1.06	0.89	0.29	0.24
1 1/4"	20	0.51	0.62	0.38	0.47	0.32	0.39	0.93	1.13	0.26	0.31
1 1/2"	25	0.45	0.65	0.32	0.47	0.29	0.42	0.83	1.22	0.22	0.33
2"	32	0.48	0.94	0.35	0.69	0.29	0.57	0.93	1.82	0.22	0.44

Resistance Coefficient Method

Alternately the resistance coefficient method can be used to calculate the pressure drop across a fitting or valve. This method is often preferred since it is independent of pipe roughness and material type. However, this method assumes that the “local flow resistance coefficient” is independent of velocity. This is normally a safe assumption for domestic installations where the Reynolds number is relatively low and does not change significantly. Values for the “local flow resistance coefficient” for APOLLO POWERPRESS fittings can be found in Table 9. The local pressure drop formula using this method is shown below.

Combining the Darcy-Weisbach formula from above, the total pressure drop for the entire system would be:

$$\Delta p = (f \times l \times v^2 \times \rho) / (2 \times D) + \rho \times g \times \Delta h + ((\sum \zeta \times v^2 \times \rho) / 2)$$

Local Pressure drop for a single fitting would be:

$$\Delta p = ((\zeta \times v^2 \times \rho) / 2)$$

Where:

ζ = Local Flow Resistance Coefficient (unitless)

Δp = Pressure Drop (Pa)

Welding Requirements:

When welding adjacent to an installed APOLLO POWERPRESS connection, the installer must remain at least 4 inches away from the connection to prevent damage to the O-ring. When welding inline to an APOLLO POWERPRESS connection, the installer must remain at least 3 feet away from the connection to prevent damage to the O-ring. The installer should take the following precautions to keep the APOLLO POWERPRESS connection cool while welding:

- Wrap the connection with a cold wet rag.
- Protect the connection with a weld blanket.
- When possible, fabricate weld connections prior to installing the pressed fitting (make sure the pipe has cooled before installing the fitting).
- Constantly apply “spray type” spot freezing.
-

Mounting Bracket Guidelines:

Pipe Hangers, supports and their installation should conform to the requirements of ANSI/MSS SP58. The installer should ensure that sliding hangers are installed such that they allow free movement of the piping in the intended direction.

The spacing of mounting brackets is critical and the recommendations of ANSI/MSS SP58 should be followed as a minimum. In addition to this standard, the movement associated with thermal expansion of the system should also be considered and mounting bracket spacing should be adjusted accordingly.

In all cases, mounting brackets should be sized sufficiently to handle the full weight of the piping system. They should be designed to handle torsion and expansion loads occurring during operation.

Brackets should never be installed onto fittings or valves. They should only be installed onto straight sections of piping.

Corrosion Information:

There are different kinds of corrosion: chemical corrosion, electro-chemical corrosion, internal and external local corrosion, stray current corrosion, etc. All types of corrosion have very particular chemical or mechanical causes. The following provides some simple hints on how to avoid such problems.

Electro-chemical corrosion

Electro-chemical corrosion occurs under the following circumstances:

- An electrochemical potential difference between parts
- The presence of a conductive fluid (electrolyte), such as water
- The presence of oxygen (O₂)

There are no significant amounts of oxygen in heating installations, thus these installations have few corrosion issues. In potable water installations, however, the oxygen content is very high, nearly at the saturation point. Therefore it is important that the APOLLO POWERPRESS System be installed only downstream of other, less noble components. For example, it is possible to install stainless steel pipe branches downstream from a pipe system consisting of galvanized steel pipes; however, in such cases, a non-ferrous metal or synthetic connection piece should be utilized between the two materials (see DIN1988).

Another important factor to consider is the ratio between the surface area of the noble metal and that of the less noble metal. The higher this ratio, the greater the corrosion potential.

Stray Current Corrosion

Corrosion by stray currents rarely occurs in practice. When it does occur, it is immediately recognizable, appearing as a cone-shaped crater on the outside of the pipe.

Stray current corrosion requires a direct current that turns the metal into an anode. The stray current jumps to a section of the piping and then back to ground farther down the system. In order to penetrate into the piping system, the ground current must have an entry point where the normal protective cover of the pipe or connection is damaged or missing.

This is why metal pipe systems must be grounded. Stray current issues are more prominent in direct current installations, however direct current is not commonly used in domestic households. Stray current issues are not very common with alternating current installations. Research has shown that problems by stray currents occur sporadically and do not depend on the type of metal.

Internal Corrosion

Internal corrosion cannot occur with closed-loop water heating systems during operation. The oxygen in the water in closed-loop systems creates a layer of iron oxide on the inside of the pipe thus preventing further corrosion. However, when the heating system is not in use, it must be kept full at all times or be completely drained and dried.

Approved additives, oxygen scavengers and corrosion inhibitors can be added to prevent frost damage, calcification and corrosion. Please contact Conbraco concerning the use of additives. Always observe the applicable legislation, regulations and local rules regarding anti-corrosion additives.

Galvanized Steel pipes and fittings are not permitted in potable water installations. Contact corrosion will occur with galvanized steel if it enters into direct contact with stainless steel.

In addition, piping systems should be properly sized to minimize the risk of erosion corrosion resulting from excessive velocities.

External Corrosion

Steel pipe systems are generally installed in such a way that the outer surfaces do not come into contact with corrosive media. However, if they do come in contact with corrosive media appropriate measures should be taken to minimize corrosion.

In some cases, pipes are exposed for a long period to rain, humidity or dampness which leads to corrosion. One way of combatting this is to use "closed cell" insulation. This insulation can prevent corrosion, but it must be applied in a guaranteed waterproof condition if corrosion is to be prevented.

Galvanized steel only offers corrosion protection for short term exposure to humidity or dampness. APOLLO POWERPRESS fittings that are exposed to long term humidity or dampness are subject to electrolytic outer corrosion and should be protected in accordance with NFPA 54 Section 404.8, NACE Standard RP0169-2002 Section 5, 2009 UPC Chapter 6 section 609.3.1, 2009 UMC Chapter 13 Section 1312.1.3. Local codes and ordinances should always be observed when applying corrosion protection techniques.

Care should also be taken to select hangers of suitable material that is galvanically compatible with the piping system.

Suitable primers - or metallic paints offer some corrosion protection. It is advisable to always use some form of corrosion protection on piping in situations where corrosion is likely to occur (damp room, crawl spaces, etc.).

Application Concerns:

Heat transfer (e.g. with a heating band)

Heat transfer from outside inwards must be prevented as this can lead to a build-up of film on the inside of the pipe wall. This film can cause an increase in the concentration of chloride ions, which cause pitting in critical concentrations.

Underground Installations

APOLLO POWERPRESS fitting systems and black iron pipe are approved for underground installations. However, any installations must meet all local codes.

Stainless steel - Galvanized Steel - Copper

With all 3 materials - stainless steel, galvanized steel, copper - waterline corrosion can occur as a result of interaction between three actors (water, metal and air). This corrosion can be prevented if the piping installation remains permanently filled.

Partial filling can occur if the pipes are emptied after a pressure test with water, therefore pressure testing with gas/air may be preferred.

Sprinkler Certificates:

Design of Sprinkler Installation

Sprinkler installations must be designed and installed in accordance with the standard NFPA13 and/or local regulations. The following steps must be carried out:

- Planning
- Installation
- Maintenance

All bodies involved up to the last test before commissioning the system must take part in the entire process from project planning to delivery. Depending on the approvals, a range of different operating pressures is permitted. For FM and UL/cUL, the maximum working pressure is 175 psi.

FM Certificate

The APOLLO POWERPRESS system has an FM certificate for fittings in accordance with FM standard I630 for use in wet and dry sprinkler installations with a maximum operating pressure of 175 psi (12.1 bar). The certificate applies to the APOLLO POWERPRESS Sprinkler system in sizes 3/4"-2" (DN20 to DN50).

Mounting and Installation of FM-Certified Sprinkler Installations

The mounting and installation of the APOLLO POWERPRESS system may only be carried out by trained and qualified technicians.

UL/cUL Certificate

The APOLLO POWERPRESS system has a UL/cUL certificate (VIZM/VIZY) for fittings and tubes for use in above ground sprinkler installations with a maximum operating pressure of 175 psi for sizes 1" to 2" (DN20-DN50). In accordance with NFPA13, at least DN25 (1") should be used for steel branch and distributor lines. The use of APOLLO POWERPRESS under UL requirements is limited to a maximum ambient temperature of 150°F(120°F under cUL). Only machines fitted with a battery are permitted under the UL/cUL certificate.

Mounting and Installation for UL/cUL-Certified Sprinkler Installations

The mounting and installation of the APOLLO POWERPRESS system may only be carried out by trained and qualified technicians.

Phone: (704) 841-6000

Fax: (704) 841-6020

