



**HVAC
PRODUCT CATALOG**

MESSAGE FROM OUR PRESIDENT

Dear Valued Customer,

Each year as we commence upon the new year, it becomes a time of reflection, appreciation, warm memories, and happiness. While we all try to carry this theme throughout the year, for some it occasionally gets lost in our daily routine and we forget for a moment what is truly precious; family, friends, health and happiness.

As 2020 winds to an end, we think about all we are appreciative for and our relationship with you is one. We are grateful to you for your tremendous efforts, dedication and loyalty you have shared with Capital Hardware whether just joining us in 2020 or having traveled this wonderful adventure with us over the past years, you have all made Capital Hardware a thriving company.

Reflecting on 2020, needless to say it was a challenging year for all of us, COVID-19 impacted the world, our families, and friends together with, our growth plans. As a team we persevered through and made good strides in rebuilding the company's foundational basis, gained market share in other parts of the country while bringing on new team members to foster a foundation that will propel the company into the next decade.

Looking forward to 2021, we are poised to embark upon one of the most successful years for Capital. Our growth strategies and marketing plans will set us apart from our competitors while keeping our entrepreneurial spirit and unique culture intact. We are excited for 2021 and are ready and able to embrace this journey together with you.

In closing, we'd like to take this opportunity to thank you for your continued support and unwavering dedication, it is customers like you who make our jobs a pleasure and keep our company successful.

We are ecstatic to have you as a customer and look forward to meeting your every need in 2021!

Matthew Alberti
President Capital Hardware Supply LLC
an Elgen Manufacturing Company

MISSION STATEMENT

“At Elgen, we strive to make high quality products at extremely competitive prices for the sheet metal fabricators and installers who are installing our ductwork in homes, buildings, hospitals, and entertainment centers around the world.”

Our Products

We are dedicated to bringing new and creative ideas to the market place, adhering to high design standard, and ensuring product quality.

Our Service

We have a team committed to assessing our entire work flow, from order entry to invoicing. We are constantly evaluating this process, making improvements when necessary to keep up with the market trends.

Our Values

At Elgen, we govern ourselves by our morals, ethics, and character. As a team, our integrity produces a harmonious and a very successful work environment. These traits have guided our everyday practices for over 50 years.

CONTENTS

Page 6-13



Fittings, Elbows & Pipe

Snap Lock Pipe & Elbows	6
Press on Collars	7
Conicals	8
Heto's	9
Bellmouth's	10
Damper Sleeve, End Cap & Reducers	11
Saddle Taps	12
Cable Operated Fittings	13

Page 14-22



Duct Connectors and Components

Elgen Flange	14
J Flange	15
H Flange & Gasket	16
C & F Corners	17-18
C & F Cleats	19
Flexible & Connector	20-21
Slip & Drive	22

Page 23



Duct Protection Film

Duct Protection Film	23
----------------------	----

Page 24-25

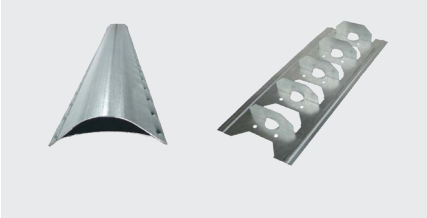

Vane and Rail

Vane	24
Rail	25

Page 26-30



Hanging Systems & Reinforcements

Strut	26
Strut Accessories	27
Grippers & Wire	28
Threaded Rod, Couplings,	29
Punched Angle, Hanger Strap,	29
Beam Clamps & Strap Hangers	29
Anchors	30

Page 31-33



Sealants & Adhesives

Precision Adhesives Duct Sealers	31
Sealants & Adhesives	32
De-Galve, Duct Butter & Brushes	33

Page 34-35



Spiral Connectors, Fittings & Components

Spiral Elbows	34
Spiral Rings & Couplings	35

CONTENTS

Page 36-40



Access Doors

Tab & Press on Doors	36
Round & Ductboard Doors	37
Casing, Flush Mount & Window Doors	38
Hi-Temp Doors	39
Access Door Gasket & Hardware	40

Page 41-45

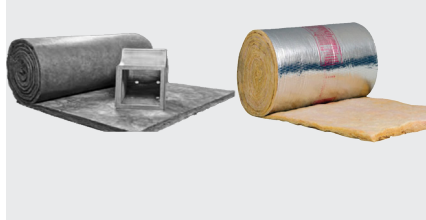

Insulation & Components

Duct Liner	41
Insulation Components	42
Tape	43
Duct Wrap & Board	44
Flex & Components	45

Page 46

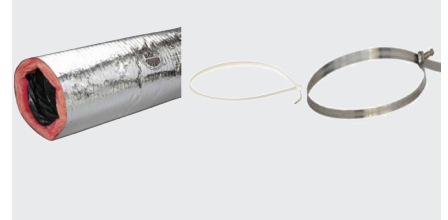

Flex Duct & Components

Flex Duct & Components	46
------------------------	----

Page 47-50



Fasteners & Hardware Components

Screws & Magnetic Chucks	47
Rivets	48
Nuts & Bolts	49
Washers	50

Page 51-66



Damper Hardware & Blades

Damper Blades & Bushings	51
Standoffs & Hardware	52
End Bearings	53-54
Bearing Straps &	55-56
Damper Regulator Parts	55-56
Regulator Sets	57
Quadrants	58-59
Speedy Damper Regulator	60
Brackets	61
Pivots, Bearing Pin & Lollipop	62
Air Control Damper Hardware	63-65
Seals	66

Page 67-69



Shop Products & Components

Conduit & Stud Inserts	67
Laser Labels	68
Shop Supplies	69

Page 70-76



Safety, Tool, & Accessories

KN95	70
Safety Supplies	71
Lifts	72-73
Hand Tools	74
Power Tools	75
Tool Accessories	76

FITTINGS, ELBOWS & PIPE

Snap Lock Pipe

- Elgen's Snap Lock Pipe is used for low pressure applications
- Reeves Lock and Button Lock come standard on every piece
- Manufactured from 26 GA ASTM A-653 & ASTM A-924 G60 material. 60" length
- Optional Construction Available

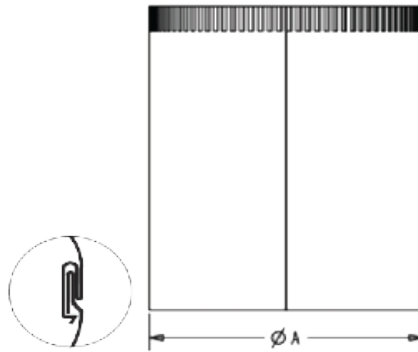

Item #	Size	Length	Bundle Qty
SMP3-5	3"	60"	10 PCS
SMP4-5	4"	60"	10 PCS
SMP5-5	5"	60"	10 PCS
SMP6-5	6"	60"	10 PCS
SMP7-5	7"	60"	10 PCS
SMP8-5	8"	60"	10 PCS
SMP9-5	9"	60"	10 PCS
SMP10-5	10"	60"	5PCS
SMP12-5	12"	60"	5PCS
SMP14-5	14"	60"	5PCS
SMP16-5	16"	60"	5PCS
SMP18-5	18"	60"	5PCS
SMP20-5	20"	60"	5PCS

Adjustable Elbow

- Elgen's adjustable elbow is used for low pressure applications and can be adjusted to any degree
- Welded Seam for added strength and low leakage
- Meets SMACNA requirements 3rd Edition Section 3.29 Figure 3-4
- Optional Construction Available

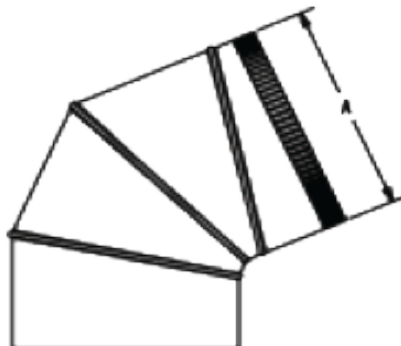

Item #	Size	Box Qty
SME4-90	4"	36PCS
SME5-90	5"	25PCS
SME6-90	6"	16PCS
SME7-90	7"	12PCS
SME8-90	8"	9PCS
SME9-90	9"	6PCS
SME10-90	10"	5PCS
SME12-90	12"	4PCS
SME14-90	14"	1PC
SME16-90	16"	1PC
SME18-90	18"	1PC
SME20-90	20"	1PC

FITTINGS, ELBOWS & PIPE

Press On Collar N/D

- Made From a Single Piece of 24 GA Metal
- Stitch welded Seam for Added Strength & Low Leakage
- Used for Low & Medium Pressure Applications
- Meets SMACNA Requirements - 2005 3rd Edition Section 4.8 Figure 4-6
- Optional Construction Available
- MADE IN USA

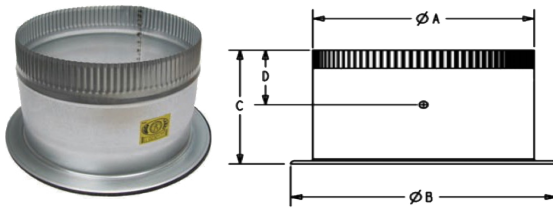

Item #	Description	Dimension A (in)	Dimension B (in)	Dimension C (in)	Dimension D (in)
SF0005	PRESS ON 4" N/D (24GA)	4"	6"	6"	3"
SF0015	PRESS ON 5" N/D (24GA)	5"	7"	6"	3"
SF0025	PRESS ON 6" N/D (24GA)	6"	8"	6"	3"
SF0035	PRESS ON 7" N/D (24GA)	7"	9"	6"	3"
SF0045	PRESS ON 8" N/D (24GA)	8"	10"	6"	3"
SF0055	PRESS ON 9" N/D (24GA)	9"	11"	6"	3"
SF0065	PRESS ON 10" N/D (24GA)	10"	12"	6"	3"
SF0075	PRESS ON 12" N/D (24GA)	12"	14"	6"	3"
SF0085	PRESS ON 14" N/D (24GA)	14"	16"	6"	3"
SF0095	PRESS ON 16" N/D (24GA)	16"	18"	6"	3"
SF0105	PRESS ON 18" N/D (24GA)	18"	20"	6"	3"
SF0115	PRESS ON 20" N/D (24GA)	20"	22"	6"	3"

Press On Collar W/D

- Made From a Single Piece of 24 GA Metal
- Stitch welded Seam for Added Strength & Low Leakage
- Used for Low Pressure Applications
- Meets SMACNA Requirements - 2005 3rd Edition Section 4.8 Figure 4-6
- Optional Construction Available
- MADE IN USA

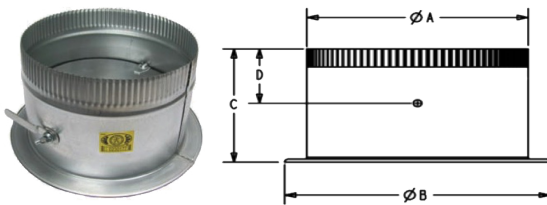

Item #	Description	Dimension A (in)	Dimension B (in)	Dimension C (in)	Dimension D (in)
SF0010	PRESS ON 4" W/D (24GA)	4"	6"	6"	3"
SF0020	PRESS ON 5" W/D (24GA)	5"	7"	6"	3"
SF0030	PRESS ON 6" W/D (24GA)	6"	8"	6"	3"
SF0040	PRESS ON 7" W/D (24GA)	7"	9"	6"	3"
SF0050	PRESS ON 8" W/D (24GA)	8"	10"	6"	3"
SF0060	PRESS ON 9" W/D (24GA)	9"	11"	6"	3"
SF0070	PRESS ON 10" W/D (24GA)	10"	12"	6"	3"
SF0080	PRESS ON 12" W/D (24GA)	12"	14"	6"	3"
SF0090	PRESS ON 14" W/D (24GA)	14"	16"	6"	3"
SF0100	PRESS ON 16" W/D (24GA)	16"	18"	6"	3"
SF0110	PRESS ON 18" W/D (24GA)	18"	20"	6"	3"
SF0120	PRESS ON 20" W/D (24GA)	20"	22"	6"	3"

Press on Collar W/Super Standoff

- Made From a Single Piece of 24 GA Metal
- Stitch welded Seam for Added Strength & Low Leakage
- Used for Low Pressure Applications
- Meets SMACNA Requirements - 2005 3rd Edition Section 4.8 Figure 4-6
- Optional Construction Available
- MADE IN USA

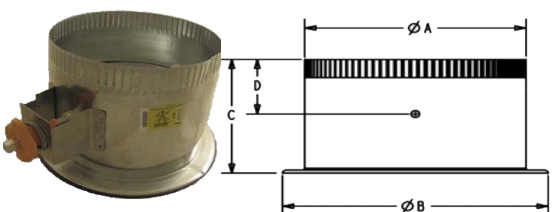

Item #	Description	Dimension A (in)	Dimension B (in)	Dimension C (in)	Dimension D (in)
SF0010-HD	PRESS ON 4" W/D (24GA) H.D W/3/8" SQ ROD & SUPER STANDOFF	4"	6"	6"	3"
SF0020-HD	PRESS ON 5" W/D (24GA) H.D W/3/8" SQ ROD & SUPER STANDOFF	5"	7"	6"	3"
SF0030-HD	PRESS ON 6" W/D (24GA) H.D W/3/8" SQ ROD & SUPER STANDOFF	6"	8"	6"	3"
SF0040-HD	PRESS ON 7" W/D (24GA) H.D W/3/8" SQ ROD & SUPER STANDOFF	7"	9"	6"	3"
SF0050-HD	PRESS ON 8" W/D (24GA) H.D W/3/8" SQ ROD & SUPER STANDOFF	8"	10"	6"	3"
SF0060-HD	PRESS ON 9" W/D (24GA) H.D W/3/8" SQ ROD & SUPER STANDOFF	9"	11"	6"	3"
SF0070-HD	PRESS ON 10" W/D (24GA) H.D W/3/8" SQ ROD & SUPER STANDOFF	10"	12"	6"	3"
SF0080-HD	PRESS ON 12" W/D (24GA) H.D W/3/8" SQ ROD & SUPER STANDOFF	12"	14"	6"	3"
SF0090-HD	PRESS ON 14" W/D (24GA) H.D W/3/8" SQ ROD & SUPER STANDOFF	14"	16"	6"	3"
SF0100-HD	PRESS ON 16" W/D (24GA) H.D W/3/8" SQ ROD & SUPER STANDOFF	16"	18"	6"	3"
SF0110-HD	PRESS ON 18" W/D (24GA) H.D W/3/8" SQ ROD & SUPER STANDOFF	18"	20"	6"	3"
SF0120-HD	PRESS ON 20" W/D (24GA) H.D W/3/8" SQ ROD & SUPER STANDOFF	20"	22"	6"	3"

FITTINGS, ELBOWS & PIPE

Conical N/D

- Elgen's Conical is used for Low Pressure Applications
- Stitch welded Seam for Added Strength & Low Leakage
- Body is made with one piece of metal
- Meets SMACNA Requirements - 2005 3rd Edition Section 4.8 Figure 4-6
- Optional Construction Available
- MADE IN USA

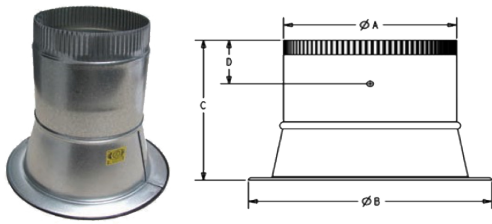

Item #	Description	Dimension A (in)	Dimension B (in)	Dimension C (in)	Dimension D (in)
SF0776	CONICAL N/D 4"	4"	8"	9.75"	3"
SF0782	5" CONICAL N/D	5"	9"	9.75"	3"
SF0788	6" CONICAL N/D	6"	10"	9.75"	3"
SF0792	7" CONICAL N/D	7"	11"	9.75"	3"
SF0797	8" CONICAL N/D	8"	12"	9.75"	3"
SF0802	9" CONICAL N/D	9"	13"	9.75"	3"
SF0807	10" CONICAL N/D	10"	14"	9.75"	3"
SF0813	12" CONICAL N/D	12"	16"	9.75"	3"
SF0817	14" CONICAL N/D	14"	18"	10.5"	3"
SF0823	16" CONICAL N/D	16"	20"	10.5"	3"
SF0827	18" CONICAL N/D	18"	22"	10.5"	3"
SF0833	20" CONICAL N/D	20"	24"	10.5"	3"

Conical W/D

- Elgen's Conical is used for Low Pressure & Medium Applications
- Stitch welded Seam for Added Strength & Low Leakage
- Body is made with one piece of metal
- Meets SMACNA Requirements - 2005 3rd Edition Section 4.8 Figure 4-6
- Optional Construction Available
- MADE IN USA

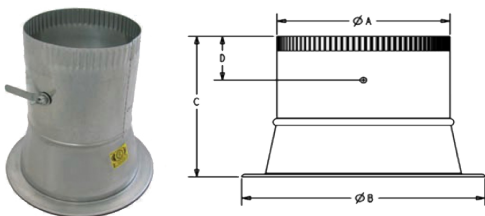

Item #	Description	Dimension A (in)	Dimension B (in)	Dimension C (in)	Dimension D (in)
SF0775	CONICAL W/D 4"	4"	8"	9.75"	3"
SF0780	CONICAL W/D 5"	5"	9"	9.75"	3"
SF0785	CONICAL W/D 6"	6"	10"	9.75"	3"
SF0790	CONICAL W/D 7"	7"	11"	9.75"	3"
SF0795	CONICAL W/D 8"	8"	12"	9.75"	3"
SF0800	CONICAL W/D 9"	9"	13"	9.75"	3"
SF0805	CONICAL W/D 10"	10"	14"	9.75"	3"
SF0810	CONICAL W/D 12"	12"	16"	9.75"	3"
SF0815	CONICAL W/D 14"	14"	18"	10.5"	3"
SF0820	CONICAL W/D 16"	16"	20"	10.5"	3"
SF0825	CONICAL W/D 18"	18"	22"	10.5"	3"
SF0830	CONICAL W/D 20"	20"	24"	10.5"	3"

Conical W/Super Standoff

- Elgen's Conical is used for Low Pressure Applications
- Stitch welded Seam for Added Strength & Low Leakage
- Body is made with one piece of metal
- Meets SMACNA Requirements - 2005 3rd Edition Section 4.8 Figure 4-6
- Optional Construction Available
- MADE IN USA

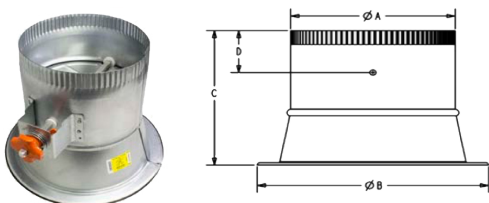

Item #	Description	Dimension A (in)	Dimension B (in)	Dimension C (in)	Dimension D (in)
SF0775-HD	CONICALS W/D 4" W/3/8" SQ ROD & SUPER STANDOFF	4"	8"	9.75"	3"
SF0780-HD	CONICALS W/D 5" W/3/8" SQ ROD & SUPER STANDOFF	5"	9"	9.75"	3"
SF0785-HD	CONICALS W/D 6" W/3/8" SQ ROD & SUPER STANDOFF	6"	10"	9.75"	3"
SF0790-HD	CONICALS W/D 7" W/3/8" SQ ROD & SUPER STANDOFF	7"	11"	9.75"	3"
SF0795-HD	CONICALS W/D 8" W/3/8" SQ ROD & SUPER STANDOFF	8"	12"	9.75"	3"
SF0800-HD	CONICALS W/D 9" W/3/8" SQ ROD & SUPER STANDOFF	9"	13"	9.75"	3"
SF0805-HD	CONICALS W/D 10" W/3/8" SQ ROD & SUPER STANDOFF	10"	14"	9.75"	3"
SF0810-HD	CONICALS W/D 12" W/3/8" SQ ROD & SUPER STANDOFF	12"	16"	9.75"	3"
SF0815-HD	CONICALS W/D 14" W/3/8" SQ ROD & SUPER STANDOFF	14"	18"	10.5"	3"
SF0820-HD	CONICALS W/D 16" W/3/8" SQ ROD & SUPER STANDOFF	16"	20"	10.5"	3"
SF0825-HD	CONICALS W/D 18" W/3/8" SQ ROD & SUPER STANDOFF	18"	22"	10.5"	3"
SF0830-HD	CONICALS W/D 20" W/3/8" SQ ROD & SUPER STANDOFF	20"	24"	10.5"	3"

FITTINGS, ELBOWS & PIPE

Heto N/D

- Elgen's HETO (High Efficiency Take Off) without damper is used for low & medium pressure applications
- Welded Seam for Added Strength
- Meets SMACNA Requirements - 2005 3rd Edition Section 4.8 Figure 4-6
- Optional Construction Available
- MADE IN USA

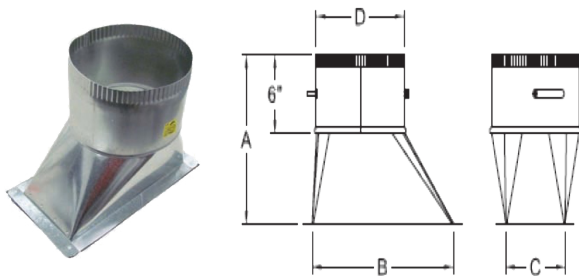

Item #	Description	Dimension D (in)	Dimension BxC (in)	Dimension A (in)
SF1056	HETO N/D 4" (26GA)	4" Round	10"x5"	11.75"
SF1061	HETO N/D 5" (26GA)	5" Round	10"x5"	11.75"
SF1066	HETO N/D 6" (26GA)	6" Round	12"x6"	11.75"
SF1071	HETO N/D 7" (26GA)	7" Round	12"x6"	11.75"
SF1076	HETO N/D 8" (26GA)	8" Round	12"x6"	11.75"
SF1081	HETO N/D 9" (26GA)	9" Round	15"x6"	12.75"
SF1086	HETO N/D 10" (26GA)	10" Round	16"x6.75"	12.75"
SF1091	HETO N/D 12" (26GA)	12" Round	18"x8.5"	12.75"
SF1096	HETO N/D 14" (26GA)	14" Round	20"x9.5"	12.75"
SF1101	HETO N/D 16" (24GA)	16" Round	22"x14"	13.75"
SF1106	HETO N/D 18" (24GA)	18" Round	22"x16"	13.75"
SF1111	HETO N/D 20" (24GA)	20" Round	24"x18"	14"

Heto W/D

- Elgen's HETO (High Efficiency Take Off) with damper is used for low pressure applications
- Welded Seam for Added Strength
- Meets SMACNA Requirements - 2005 3rd Edition Section 4.8 Figure 4-6
- Optional Construction Available
- MADE IN USA

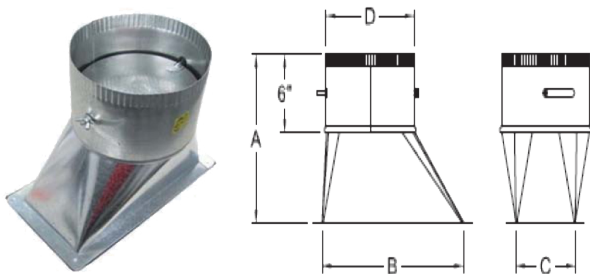

Item #	Description	Dimension D (in)	Dimension BxC (in)	Dimension A (in)
SF1055	HETO 4" W/D (26GA)	4" Round	10"x5"	11.75"
SF1060	HETO 5" W/D (26GA)	5" Round	10"x5"	11.75"
SF1065	HETO 6" W/D (26GA)	6" Round	12"x6"	11.75"
SF1070	HETO 7" W/D (26GA)	7" Round	12"x6"	11.75"
SF1075	HETO 8" W/D (26GA)	8" Round	12"x6"	11.75"
SF1080	HETO 9" W/D (26GA)	9" Round	15"x6"	12.75"
SF1085	HETO 10" W/D (26GA)	10" Round	16"x6.75"	12.75"
SF1090	HETO 12" W/D (26GA)	12" Round	18"x8.5"	12.75"
SF1095	HETO 14" W/D (26GA)	14" Round	20"x9.5"	12.75"
SF1100	HETO 16" W/D (24GA)	16" Round	22"x14"	13.75"
SF1105	HETO 18" W/D (24GA)	18" Round	22"x16"	13.75"
SF1110	HETO 20" W/D (24GA)	20" Round	24"x18"	14"

Heto W/Super Standoff

- Elgen's HETO (High Efficiency Take Off) with super standoff is used for low & medium pressure applications
- Welded Seam for Added Strength
- Meets SMACNA Requirements - 2005 3rd Edition Section 4.8 Figure 4-6
- Optional Construction Available
- MADE IN USA

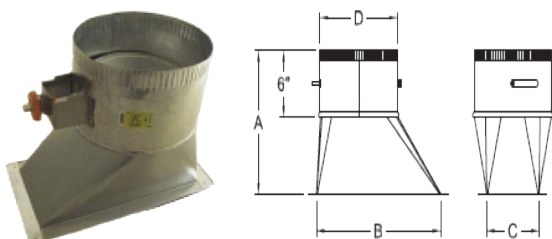

Item #	Description	Dimension D (in)	Dimension BxC (in)	Dimension A (in)
SF1055-HD	HETO 4" W/D (26GA) H.D. W/3/8" SQ ROD & SUPER STANDOFF	4" Round	10"x5"	11.75"
SF1060-HD	HETO 5" W/D (26GA) H.D. W/3/8" SQ ROD & SUPER STANDOFF	5" Round	10"x5"	11.75"
SF1065-HD	HETO 6" W/D (26GA) H.D. W/3/8" SQ ROD & SUPER STANDOFF	6" Round	12"x6"	11.75"
SF1070-HD	HETO 7" W/D (26GA) H.D. W/3/8" SQ ROD & SUPER STANDOFF	7" Round	12"x6"	11.75"
SF1075-HD	HETO 8" W/D (26GA) H.D. W/3/8" SQ ROD & SUPER STANDOFF	8" Round	12"x6"	11.75"
SF1080-HD	HETO 9" W/D (26GA) H.D. W/3/8" SQ ROD & SUPER STANDOFF	9" Round	15"x6"	12.75"
SF1085-HD	HETO 10" W/D (26GA) H.D. W/3/8" SQ ROD & SUPER STANDOFF	10" Round	16"x6.75"	12.75"
SF1090-HD	HETO 12" W/D (26GA) H.D. W/3/8" SQ ROD & SUPER STANDOFF	12" Round	18"x8.5"	12.75"
SF1095-HD	HETO 14" W/D (26GA) H.D. W/3/8" SQ ROD & SUPER STANDOFF	14" Round	20"x9.5"	12.75"
SF1100-HD	HETO 16" W/D (24GA) H.D. W/3/8" SQ ROD & SUPER STANDOFF	16" Round	22"x14"	13.75"
SF1105-HD	HETO 18" W/D (24GA) H.D. W/3/8" SQ ROD & SUPER STANDOFF	18" Round	22"x16"	13.75"
SF1110-HD	HETO 20" W/D (24GA) H.D. W/3/8" SQ ROD & SUPER STANDOFF	20" Round	24"x18"	14"

FITTINGS, ELBOWS & PIPE

Bellmouth Collar N/D

- Elgen's Bellmouth Collar is used for High Pressure Applications
- Meets SMACNA Requirements - 2005 3rd Edition Section 4.8 Figure 4-6
- Optional Construction Available
- MADE IN USA

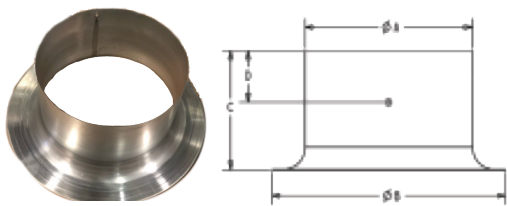

Item #	Description	Dimension A (in)	Dimension B (in)	Dimension C (in)	Dimension D (in)
SF0355	BELLMOUTH COLLAR N/D 4" W/GASKET	4"	7"	6"	2.75"
SF0365	BELLMOUTH COLLAR N/D 5" W/GASKET	5"	8"	6"	2.75"
SF0375	BELLMOUTH COLLAR N/D 6" W/GASKET	6"	9"	6"	2.75"
SF0385	BELLMOUTH COLLAR N/D 7" W/GASKET	7"	10"	6"	2.75"
SF0395	BELLMOUTH COLLAR N/D 8" W/GASKET	8"	11"	6"	2.75"
SF0405	BELLMOUTH COLLAR N/D 9" W/GASKET	9"	12"	6"	2.75"
SF0415	BELLMOUTH COLLAR N/D 10" W/GASKET	10"	13"	6"	2.75"
SF0425	BELLMOUTH COLLAR N/D 12" W/GASKET	12"	15"	6"	2.75"
SF0435	BELLMOUTH COLLAR N/D 14" W/GASKET	14"	17"	6"	2.75"
SF0445	BELLMOUTH COLLAR N/D 16" W/GASKET	16"	19"	6"	2.75"
SF0455	BELLMOUTH COLLAR N/D 18" W/GASKET	18"	21"	6"	2.75"
SF0465	BELLMOUTH COLLAR N/D 20" W/GASKET	20"	23"	6"	2.75"

Bellmouth Collar W/D

- Elgen's Bellmouth Collar is used for High Pressure Applications
- Meets SMACNA Requirements - 2005 3rd Edition Section 4.8 Figure 4-6
- Optional Construction Available
- MADE IN USA

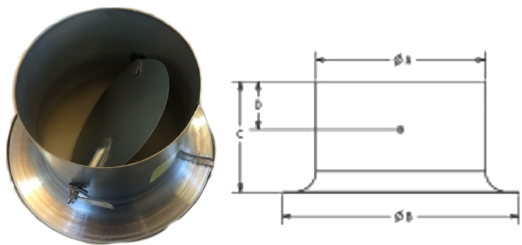

Item #	Description	Dimension A (in)	Dimension B (in)	Dimension C (in)	Dimension D (in)
SF0360	BELLMOUTH COLLAR W/D 4"	4"	7"	6"	2.75"
SF0370	BELLMOUTH COLLAR W/D 5"	5"	8"	6"	2.75"
SF0380	BELLMOUTH COLLAR W/D 6"	6"	9"	6"	2.75"
SF0390	BELLMOUTH COLLAR W/D 7"	7"	10"	6"	2.75"
SF0400	BELLMOUTH COLLAR W/D 8"	8"	11"	6"	2.75"
SF0410	BELLMOUTH COLLAR W/D 9"	9"	12"	6"	2.75"
SF0420	BELLMOUTH COLLAR W/D 10"	10"	13"	6"	2.75"
SF0430	BELLMOUTH COLLAR W/D 12"	12"	15"	6"	2.75"
SF0440	BELLMOUTH COLLAR W/D 14"	14"	17"	6"	2.75"
SF0450	BELLMOUTH COLLAR W/D 16"	16"	19"	6"	2.75"
SF0460	BELLMOUTH COLLAR W/D 18"	18"	21"	6"	2.75"
SF0470	BELLMOUTH COLLAR W/D 20"	20"	23"	6"	2.75"

Bellmouth Collar HD W/Super Standoff

- Elgen's Bellmouth Collar is used for High Pressure Applications
- Meets SMACNA Requirements - 2005 3rd Edition Section 4.8 Figure 4-6
- Optional Construction Available
- MADE IN USA

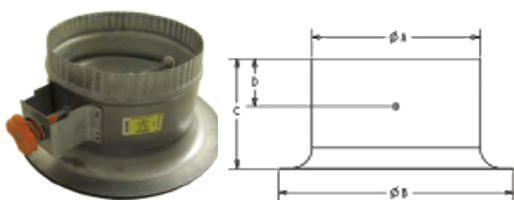

Item #	Description	Dimension A (in)	Dimension B (in)	Dimension C (in)	Dimension D (in)
SF0360-HD	BELLMOUTH COLLAR W/D 4" W/3/8" SQ ROD & SUPER STANDOFF	4"	7"	6"	2.75"
SF0370-HD	BELLMOUTH COLLAR W/D 5" W/3/8" SQ ROD & SUPER STANDOFF	5"	8"	6"	2.75"
SF0380-HD	BELLMOUTH COLLAR W/D 6" W/3/8" SQ ROD & SUPER STANDOFF	6"	9"	6"	2.75"
SF0390-HD	BELLMOUTH COLLAR W/D 7" W/3/8" SQ ROD & SUPER STANDOFF	7"	10"	6"	2.75"
SF0400-HD	BELLMOUTH COLLAR W/D 8" W/3/8" SQ ROD & SUPER STANDOFF	8"	11"	6"	2.75"
SF0410-HD	BELLMOUTH COLLAR W/D 9" W/3/8" SQ ROD & SUPER STANDOFF	9"	12"	6"	2.75"
SF0420-HD	BELLMOUTH COLLAR W/D 10" W/3/8" SQ ROD & SUPER STANDOFF	10"	13"	6"	2.75"
SF0430-HD	BELLMOUTH COLLAR W/D 12" W/3/8" SQ ROD & SUPER STANDOFF	12"	15"	6"	2.75"
SF0440-HD	BELLMOUTH COLLAR W/D 14" W/3/8" SQ ROD & SUPER STANDOFF	14"	17"	6"	2.75"
SF0450-HD	BELLMOUTH COLLAR W/D 16" W/3/8" SQ ROD & SUPER STANDOFF	16"	19"	6"	2.75"
SF0460-HD	BELLMOUTH COLLAR W/D 18" W/3/8" SQ ROD & SUPER STANDOFF	18"	21"	6"	2.75"
SF0470-HD	BELLMOUTH COLLAR W/D 20" W/3/8" SQ ROD & SUPER STANDOFF	20"	23"	6"	2.75"

FITTINGS, ELBOWS & PIPE

HD Damper Sleeve

- Elgen's "Heavy Duty" Damper Sleeve is designed to go in between two pieces of spiral pipe, where a damper is needed to regulate the air flow. It is for Low & Medium Pressure Applications
- Meets SMACNA Requirements - 2005 3rd Edition Section 4.8 Figure 4-6
- Optional Construction Available
- MADE IN USA



Item #	Description	Dimension A (in)	Dimension C (in)	Dimension D (in)
SF0398	4" DAMPER SLEEVE W/3/8" SQ ROD & SUPER STANDOFF*CRIMPED 1 END*	4"	9.25"	4.625"
SF0399	5" DAMPER SLEEVE W/3/8" SQ ROD & SUPER STANDOFF*CRIMPED 1 END*	5"	9.25"	4.625"
SF4000	6" DAMPER SLEEVE W/3/8" SQ ROD & SUPER STANDOFF*CRIMPED 1 END*	6"	9.25"	4.625"
SF4005	7" DAMPER SLEEVE W/3/8" SQ ROD & SUPER STANDOFF*CRIMPED 1 END*	7"	9.25"	4.625"
SF4010	8" DAMPER SLEEVE W/3/8" SQ ROD & SUPER STANDOFF*CRIMPED 1 END*	8"	9.25"	4.625"
SF0415	9" DAMPER SLEEVE W/3/8" SQ ROD & SUPER STANDOFF*CRIMPED 1 END*	9"	9.25"	4.625"
SF4020	10" DAMPER SLEEVE W/3/8" SQ ROD & SUPER STANDOFF*CRIMPED 1 END*	10"	9.25"	4.625"
SF4030	12" DAMPER SLEEVE W/3/8" SQ ROD & SUPER STANDOFF*CRIMPED 1 END*	12"	9.25"	4.625"
SF4040	14" DAMPER SLEEVE W/3/8" SQ ROD & SUPER STANDOFF*CRIMPED 1 END*	14"	9.25"	4.625"
SF4050	16" DAMPER SLEEVE W/3/8" SQ ROD & SUPER STANDOFF*CRIMPED 1 END*	16"	9.25"	4.625"
SF4060	18" DAMPER SLEEVE W/3/8" SQ ROD & SUPER STANDOFF*CRIMPED 1 END*	18"	9.25"	4.625"
SF4070	20" DAMPER SLEEVE W/3/8" SQ ROD & SUPER STANDOFF*CRIMPED 1 END*	20"	9.25"	4.625"

Smoke End Cap

- Elgen's End Cap is designed for low, medium, and high pressure applications
- Formed from one piece of ASTM A-653 G60 material
- Optional Construction Available
- MADE IN USA



Item #	Description	Dimension A (in)	Dimension H (in)
SM1000	END CAP 4"	4"	2.5"
SM1005	END CAP 5"	5"	2.5"
SM1010	END CAP 6"	6"	2.5"
SM1015	END CAP 7"	7"	2.5"
SM1020	END CAP 8"	8"	2.5"
SM1025	END CAP 9"	9"	2.5"
SM1030	END CAP 10"	10"	2.5"
SM1035	END CAP 12"	12"	2.5"
SM1040	END CAP 14"	14"	2.5"
SM1045	END CAP 16"	16"	2.5"
SM1050	END CAP 18"	18"	2.5"
SM1055	END CAP 20"	20"	2.5"

Smoke Reducer

- Elgen's reducer is designed for reducing the duct size to maintain air pressure
- Welded Seam for added strength and low leakage
- Optional Construction Available
- MADE IN USA

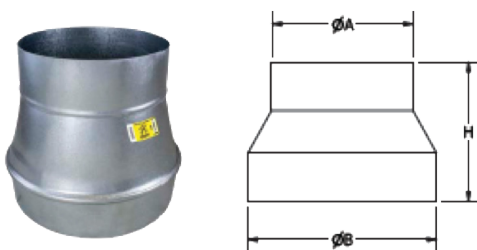

Item #	Description	Dimension A (in)	Dimension B (in)	Dimension H (in)
SM0800	4X3 SMOKE REDUCER	4"	6"	8"
SM0803	6X4 SMOKE REDUCER	6"	8"	8"
SM0820	8X6 SMOKE REDUCER	8"	10"	9"
SM0835	10X8 SMOKE REDUCER	10"	12"	9"
SM0850	12X10 SMOKE REDUCER	12"	14"	9"
SM0865	14X12 SMOKE REDUCER	14"	16"	9"
SM0885	16X14 SMOKE REDUCER	16"	18"	9"
SM0900	18X16 SMOKE REDUCER	18"	20"	9"
SM0915	20X18 SMOKE REDUCER	20"	20"	9"

FITTINGS, ELBOWS & PIPE

Press on Saddle Tap

- Elgen's Round Saddle is used for Low & Medium Pressure applications on round pipe
- Optional Construction Available
- MADE IN THE USA

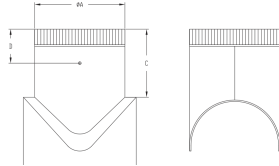

A (in)	B (in)	C (in)	D (in)
4"	6"	6"	3"
5"	7"	6"	3"
6"	8"	6"	3"
7"	9"	6"	3"
8"	10"	6"	3"
9"	11"	6"	3"
10"	12"	6"	3"
12"	14"	6"	3"
14"	16"	6"	3"
16"	18"	6"	3"

Press on For Multi Round

- Elgen's Round Saddle is used for Low & Medium Pressure applications on round pipe
- Optional Construction Available
- MADE IN THE USA

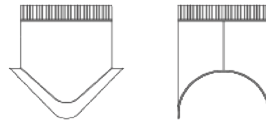

A (in)	B (in)	C (in)	D (in)
4"	6"	6"	3"
5"	7"	6"	3"
6"	8"	6"	3"
7"	9"	6"	3"
8"	10"	6"	3"
9"	11"	6"	3"
10"	12"	6"	3"
12"	14"	6"	3"
14"	16"	6"	3"
16"	18"	6"	3"

Large Flange Saddle Press On

- Elgen's Round Saddle is used for Low & Medium Pressure applications on round pipe
- Optional Construction Available
- MADE IN THE USA

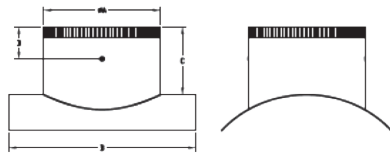

A (in)	B (in)	C (in)	D (in)
4"	10"	6"	3"
5"	11"	6"	3"
6"	12"	6"	3"
7"	13"	6"	3"
8"	14"	6"	3"
9"	15"	6"	3"
10"	16"	6"	3"
12"	18"	6"	3"
14"	20"	6"	3"
16"	22"	6"	3"

Conical Saddle

- Elgen's Round Saddle is used for Low & Medium Pressure applications on round pipe
- Optional Construction Available
- MADE IN THE USA

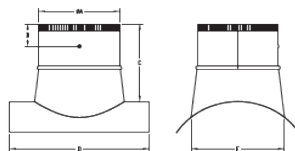

A (in)	B (in)	C (in)	D (in)	E (in)
4"	3"	10.75"	12"	6"
5"	3"	10.75"	12"	7"
6"	3"	10.75"	12"	8"
7"	3"	10.75"	12"	9"
8"	3"	10.75"	12"	10"
9"	3"	10.75"	12"	11"
10"	3"	10.75"	12"	12"
12"	3"	10.75"	12"	14"
14"	3"	10.75"	12"	16"
16"	3"	10.75"	12"	18"

Heto Saddle

- Elgen's Round Saddle is used for Low & Medium Pressure applications on round pipe
- Optional Construction Available
- MADE IN THE USA

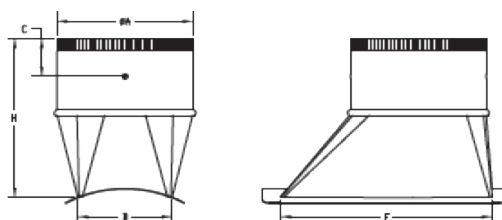

A (in)	B (in)	C (in)	H (in)	F (in)
4"	5"	3"	11.75"	10"
5"	5"	3"	11.75"	10"
6"	6"	3"	11.75"	12"
7"	6"	3"	11.75"	12"
8"	6"	3"	11.75"	12"
9"	6"	3"	12.75"	15"
10"	6.75"	3"	12.75"	16"
12"	8.5"	3"	12.75"	18"
14"	9.5"	3"	12.75"	20"
16"	14"	3"	13.75"	22"
18"	16"	3"	13.75"	22"
20"	18"	3"	14"	24"

FITTINGS, ELBOWS & PIPE



Cable Operated Press-On Collar

- Elgen's Cable operated Press-On Collars are a Convenient way to maintain airflow adjustment after installation. Airflow can be easily adjusted by pushing or pulling on the cable to alter the damper blade position. All Volume Damper for air control
- 5ft, 10ft, and 15ft Cable Lengths
- Internal and External Cable mounting
- Optional Construction Available
- MADE IN USA



Cable Operated Conical

- Elgen's Cable operated Conicals are a Convenient way to maintain airflow adjustment after installation. Airflow can be easily adjusted by pushing or pulling on the cable to alter the damper blade position. All Volume Damper for air control
- 5ft, 10ft, and 15ft Cable Lengths
- Internal and External Cable mounting
- Optional Construction Available
- MADE IN USA



Cable Operated Heto

- Elgen's Cable operated Heto's are a Convenient way to maintain airflow adjustment after installation. Airflow can be easily adjusted by pushing or pulling on the cable to alter the damper blade position. All Volume Damper for air control
- 5ft, 10ft, and 15ft Cable Lengths
- Internal and External Cable mounting
- Optional Construction Available
- MADE IN USA



Cable Operated Damper Sleeve

- Elgen's Cable operated Damper Sleeves are a Convenient way to maintain airflow adjustment after installation. Airflow can be easily adjusted by pushing or pulling on the cable to alter the damper blade position. All Volume Damper for air control
- 5ft, 10ft, and 15ft Cable Lengths
- Internal and External Cable mounting
- Optional Construction Available
- MADE IN USA

DUCT CONNECTORS AND COMPONENTS

Elgen Flange

- Designed to provide external duct reinforcement and to provide a joining system between two similar size joints of duct
- Butyl in pocket for an energy efficient seal
- Sealing Materials meet NFPA 90A & B Class 1 requirements
- Optional Construction Available
- MADE IN USA

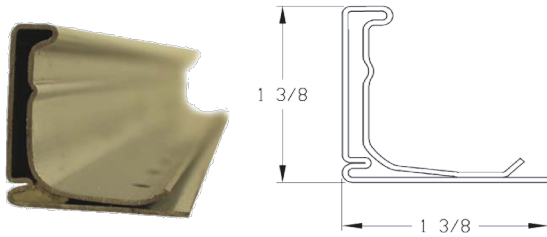

Item #	Description	Bundle QTY
EG0680	ELGEN FLANGE 10FT *WITH HOLES*	750ft
EG0695	ELGEN FLANGE 20FT WITH HOLES	1500ft
EG0695-500	ELGEN FLANGE 20FT) WITH HOLES	500ft
EG0695NH	ELGEN FLANGE 20FT *NO HOLES*	1500ft
EG0700	ELGEN FLANGE 20FT ST/ST#304 WITH HOLES	500ft
EG0685	ELGEN FLANGE 20FT ST/ST#316	500ft
EG0704	ELGEN FLANGE 20FT *GALVANEAL* w/HOLES	500ft
EG0705	ELGEN FLANGE 20FT *ALUM* NO HOLES	500ft

Elgen Flange Corners

- The Elgen Flange Corner is Designed to be used with the Elgen Flange System for rectangular ductwork
- Provides a sealing surface for the Elgen 440 Butyl gasket
- Optional Construction Available
- MADE IN USA

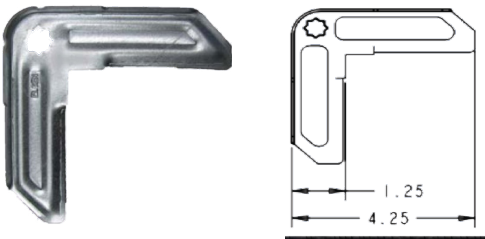

Item #	Description	Box QTY
EG0080	ELGEN FLANGE CORNER **BOLT TYPE**	300/BOX
EG0081	ELGEN FLANGE CORNER **CLIP TYPE** SPECIAL **WITH CORNER CLIPS**	300/BOX
EG0080PCD	ELGEN FLANGE CORNER*PCD COATED	300/BOX
EG0082	ELGEN FLANGE CORNER *GALVANEAL	300/BOX
EG0085	ELGEN FLANGE CORNER ST/ST#304	300/BOX
EG0086	ELGEN FLANGE CORNER ST/ST#316	300/BOX
EG0090	ELGEN FLANGE CORNER *ALUMINUM*	300/BOX

Cleats for Elgen Flange

- The Elgen Flange Cleats is used in conjunction with the Elgen Flange
- It is used on the perimeter of the Elgen Flange, four bolt rectangular system
- Meets SMACNA Requirements for 6" length.
- MADE IN USA



Item #	Description	Box QTY
EG0495	CLEATS FOR ELGEN FLANGE METAL	500/BOX
EG0495-316	CLEATS FOR ELGEN FLANGE METAL316 ST /ST	500/BOX
EG0510	CLEAT FOR ELGEN FLANGE **PVC**	500/BOX

DUCT CONNECTORS AND COMPONENTS

J Flange

- Designed to provide external duct reinforcement and to provide a joining system between two similar size joints of duct. Butyl in pocket for an energy efficient seal
- Sealing Materials meet NFPA 90A & B Class 1 requirements
- Optional Construction Available
- MADE IN USA

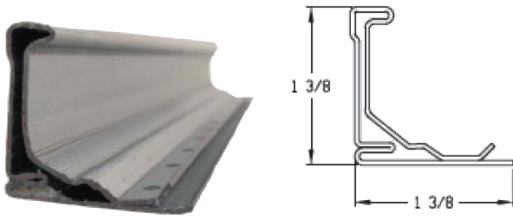

Item #	Description	Bundle QTY
EG0790	J ANGLE 10FT*** *WITH HOLES*	750FT
EG0791	J ANGLE 20FT --*WITH HOLES*	1500FT
EG0791-500	J ANGLE 20FT --*WITH HOLES*	500FT
EG0794	J ANGLE 20FT *NO HOLES*	1500FT
EG07912	J ANGLE 20FT **PCD COATED**	500FT
EG0796	J ANGLE 20FT **ST/ST#304	500FT
EG0795	J ANGLE 20FT **ST/ST#316**	500FT
EG07965	J ANGLE 20FT **GALVANEAL** PAINT-GRIP	500FT
EG0801	J ANGLE 20FT **ALUM** NO HOLES	500FT
EG1012	J FLANGE X20FT **AGION**	500FT

J Flange Corners

- The Elgen J Corner is designed to be used with the Elgen J Flange System for rectangular ductwork
- Tapered ends for easy insertion into flange
- Provides a sealing surface for the Elgen 440 Butyl Gasket
- MADE IN USA

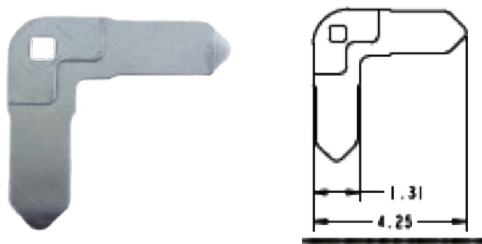

Item #	Description	Box QTY
EG0480	J CORNER	250/BOX
EG0485	J CORNER **ST/ST#304**	250/BOX
EG0486	J CORNER **ST/ST#316**	250/BOX
EG0490	J CORNER **ALUM**	250/BOX
EG04905	J CORNER *GALVANEAL*	250/BOX
EG0481	J CORNER **PCD COATED**	250/BOX

J Flange Cleat

- The Elgen J & C Cleat is used on the perimeter of the Elgen J Flange, four bolt rectangular system. Can also be used for Transverse Duct Connection
- Meets SMACNA Requirements for 6" length
- MADE IN USA

Item #	Description	Box Qty
EG0635	CLEAT METAL FOR J & C (W-C CLEAT)	500/BOX
EG0620	CLEAT *PVC* FOR J & C	500/BOX
EG06055	J+C CLEAT "316 ST/ST"	500/BOX



DUCT CONNECTORS AND COMPONENTS

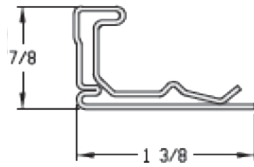

H Flange

- Designed to provide external duct reinforcement and to provide a joining system between two similar size joints of duct.
- Butyl in pocket for an energy efficient seal
- Sealing Materials meet NFPA 90A & B Class 1 requirements
- Optional Construction Available
- MADE IN USA

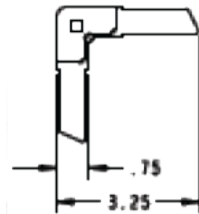

H Flange Corners

- The Elgen H Corner is designed to be used with the Elgen H Flange System for rectangular ductwork
- Provides a sealing surface for the Elgen 440 Butyl Gasket
- Optional Construction Available
- MADE IN USA

Item	Description	Box QTY
EG0451	H CORNER	500/BOX



Butyl Gasket

- Elgen's UL 723 Listed 440 Butyl Gasket is a high quality gray butyl gasket tape
- It is designed for use with 4 bolt duct connection systems.
- It is non-curing and adheres extremely well to metal surfaces
- UL 723 Listed - R27308
- Meets USDA and FDA Regulations and Standards
- LEEDS requirements
- Contains no Solvent - 0 VOC's
- MADE IN USA

Item	Description	Box QTY	Skid QTY
EG0810	440 BUTYL GASKET	500Ft	30,000FT



Neoprene Gasket

- Elgen's neoprene Gasket is designed for use with 4 bolt duct connection systems
- This is most commonly used for breakaway connections near all Fire Dampers
- Meets ASTM-84 (UL-723)
- MADE IN USA

Item #	Description	Box QTY
ST0005	SC-41 1/8 X 1/2 NEOPRENE GASKET	5,400FT
ST0050	SC-41 5/16 X 3/4 X 34' NEOPRENE	680FT
ST0087	SC-41 1/4 X 1/2 X 34' BLK MED DEN NEOPRENE GASKET	1,632FT
ST0090	SC-41 1/4 X 3/4 X 34' NEOPRENE	1,088FT
ST0095	SC-41 1/4 X 1 NEOPRENE	816FT
ST0100	SC-41 1/4 X 1-1/2 NEOPRENE	544FT
ST0140	SC-41 1/8 X 1 TWO SIDED GASKET	2,700FT
ST0145	SC-41 1/8 X 1-1/2 TWO SIDED GASKET	1,836FT

DUCT CONNECTORS AND COMPONENTS

Stackable TDC Corner

• Corner pieces are used to add rigidity to the flange, hold duct work together and provide a sealing surface for the gasket. Add rigidity to the Transverse Duct Flange. Provides a sealing surface for the Elgen 440 Butyl Gasket. Tabs on the legs allow for the corners to stack

- Optional Construction Available
- MADE IN USA



Item #	Description	Box QTY
EG00040	STACKABLE C CORNER FOR AUTOMATIC INSERTION	250/BOX
EG00041	STACKABLE C CORNER ST/ST#304 FOR AUTOMATIC INSERTION	250/BOX
EG00042	STACKABLE C CORNER ST/ST#316 FOR AUTOMATIC INSERTION	250/BOX
EG00043	STACKABLE C CORNER ALUMINUM FOR AUTOMATIC INSERTION	250/BOX
EG00044	STACKABLE C CORNER **SPECIAL GALVANEAL**	250/BOX

Stackable TDF Corner

• Corner pieces are used to add rigidity to the flange, hold duct work together and provide a sealing surface for the gasket. Add rigidity to the Transverse Duct Flange. Provides a sealing surface for the Elgen 440 Butyl Gasket. Tabs on the legs allow for the corners to stack

- Optional Construction Available
- MADE IN USA



Item #	Description	Box QTY
EG00045	STACKABLE F CORNER FOR AUTOMATIC INSERTION	250/BOX
EG00046	STACKABLE F CORNER ST/ST#304 FOR AUTOMATIC INSERTION	250/BOX
EG00047	STACKABLE F CORNER ST/ST#316 FOR AUTOMATIC INSERTION	250/BOX
EG00048	STACKABLE F CORNER ALUMINUM FOR AUTOMATIC INSERTION	250/BOX
EG00049	STACKABLE F CORNER **SPECIAL GALVANEAL**	250/BOX

Auto Elgen Corner for C & F

• The Elgen Auto Corner for C & F is used in conjunction with the Transverse Duct Connection and Transverse Duct Flange formed on Flange. Holds ductwork together. Provides a Sealing surface for the Elgen 440 Butyl Gasket

- Optional Construction Available
- MADE IN USA



Item #	Description	Box Qty
EG0065	AUTO ELGEN CORNER FOR C AND F	300/BOX
EG0142	AUTO CORNER *GALVANEAL* FOR C AND F	250/BOX
EG0152	AUTO CORNER *PCD COATED* FOR C AND F	250/BOX
EG0145	AUTO CORNER ST/ST#304 FOR C AND F	250/BOX
EG0148	AUTO CORNER *ST/ST#316** FOR C AND F	300/BOX

DUCT CONNECTORS AND COMPONENTS



C-W Corner

- The Elgen C-W corner is used in conjunction with the Transverse Duct Connection and Transverse Duct Flange formed on Flange. Holds ductwork together. Provides a Sealing surface for the Elgen 440 Butyl Gasket
- Optional Construction Available
- MADE IN USA

Item #	Description	Box QTY
EG0491	C-W CORNER	300/BOX
EG0492	C-W CORNER ST/ST#304	300/BOX
EG0492A	C-W CORNER *ALUM*	300/BOX



F-W Corner

- The Elgen F-W corner is used in conjunction with the Transverse Duct Connection and Transverse Duct Flange formed on Flange. Holds ductwork together. Provides a Sealing surface for the Elgen 440 Butyl Gasket
- Optional Construction Available
- MADE IN USA

Item #	Description	Box QTY
EG0493	F-W CORNER	300/BOX
EG0494	F-W CORNER ST/ST#304	300/BOX
EG0494A	F-W CORNER *ALUM*	300/BOX



F-Elgen Corner

- The F-Elgen corner is used in conjunction with the Transverse Duct Connection and Transverse Duct Flange formed on Flange. Holds ductwork together. Provides a Sealing surface for the Elgen 440 Butyl Gasket
- Optional Construction Available
- MADE IN USA

Item #	Description	Box QTY
EG0155	F ELGEN CORNER	225/BOX
EG0160	F ELGEN CORNER 304 ST/ST	225/BOX
EG0165	F-E CORNERS ALUMINUM	225/BOX



C/F Corner with Teeth

- The Elgen C/F Corner with Teeth is used in Conjunction with the Transverse Duct Connection formed on Flange. Adds rigidity to the Transverse Duct Flange. Provides a sealing surface for the Elgen 440 Butyl Gasket
- Optional Construction Available
- MADE IN USA

Item #	Description	Box QTY
EG0064	C CORNER ** WITH TEETH**	300/BOX
EG00645	F CORNER ** WITH TEETH**	300/BOX

DUCT CONNECTORS AND COMPONENTS

E55 Cleats

- Elgen's E-55 Cleat is compatible on all flange systems except for H. The E-55 Cleat is used on the perimeter of the Flange, four bolt rectangular system. It provides uniform compression for the 440 Butyl Gasket between the Flange's for an energy efficient Seal
- Easy to Install
- Meets SMACNA requirements 6" length
- Optional Construction available
- MADE IN USA



Item #	Description	Box QTY
EG0540	#E55 CLEAT (F/C)	250/BOX
EG0542	#E55 CLEAT *SPECIAL* 20GA	250/BOX
EG0543	#E55 CLEAT **GALVANEAL**	250/BOX
EG0544	#E55 CLEAT "PCD COATED*SPECIAL	250/BOX
EG0545	#E55 CLEAT *ST/ST#304* 22GA	250/BOX
EG0546	#E55 CLEAT *ST/ST#316*	250/BOX
EG0548	#E55 CLEAT *ALUMINUM*	250/BOX
EG0540-PVC	#E55 CLEAT *PVC*	250/BOX

Universal Cleat

- Elgen's Universal Cleat is compatible on all flange systems except for H. The Universal Cleat is used on the perimeter of the Flange, four bolt rectangular system. It provides uniform compression for the 440 Butyl Gasket between the Flange's for an energy efficient Seal
- Easy to Install
- Meets SMACNA requirements 6" length
- Optional Construction available
- MADE IN USA

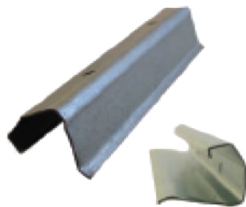

Item #	Description	Box QTY
EG05505	UNIVERSAL CLEAT	250/BOX
EG05506	UNIVERSAL CLEAT *SPECIAL 20GA*	250/BOX
EG05507	UNIVERSAL CLEAT ST/ST#304	250/BOX
EG05508	UNIVERSAL CLEAT ST/ST#316	250/BOX
EG05509	UNIVERSAL CLEAT *ALUMINUM*	250/BOX
EG05505PCD	UNIVERSAL CLEAT **PCD COATED**	250/BOX

Cleat Metal F

- The Elgen F-Cleat is used on TDF formed on Flange
- The Elgen F-Cleat is used on the perimeter of the TDF Flange, four bolt rectangular system
- The use of the Elgen-F Cleat provides uniform compression for the 440 Butyl Gasket between the TDF Flange's for an energy efficient seal
- Meets SMACNA requirements 6" length
- Optional Construction available
- MADE IN USA



Item #	Description	Box Qty
EG0640	CLEAT METAL *F* (W-F CLEAT)	500/BOX
EG0615	CLEAT *PVC* FOR F - 7/8" I.D.	500/BOX
EG0641	F CLEAT" GALVANEAL"	500/BOX

DUCT CONNECTORS AND COMPONENTS

Notch Lock Flex Connector

- Elgen's Notch Lock eliminates duct system noises and vibrations. It attaches to a fan source on one side and ductwork on the other
- All Elgen fabrics are designed to meet NFPA-701 (formerly UL-214)
- Tested in accordance with LEEDS
- Requirements Meets SMACNA
- Optional Construction Available
- MADE IN USA



Item #	Description	Box QTY
GA1910	ZLL 3x3x3 VINLON	100 FT
GA1616	ZLL 4X4X4 VINLON	100 FT
GA1910A	ZLL-AL 3X3X3 ALUMINUM	100 FT
GA1902	ZLL-AL 4x4x4 VINLON ALUMINUM	100 FT
GA1510	ZLN 3x3x3 NEOPRENE	100 FT
GA1516	ZLN 4X4X4 NEOPRENE CONNECTOR	100 FT
GA1510A	ZLN-AL 3x3x3 ALUMINUM	100 FT
GA1516A	ZLN-AL 4x4x4 ALUMINUM	100 FT
GA1510G	ZLN 3X3X3 *GALVANEAL* PAINT GRIP	100 FT
GA1516G	ZLN 4X4X4 *GALVANEAL* PAINT GRIP	100 FT
GA1510-AG	ZLN 3x3x3 AGION INSIDE	100 FT
GA1516-AG	ZLN 4X4X4 SPECIAL AGION NEOPRENE CONNECTOR ** INSIDE**	100 FT
GA2110	ZLSG 3x3x3 SILGUARD	100 FT
GA2116	ZLSG 4X4X4 SILGUARD	100 FT
GA1310	ZLH 3x3x3 HYPALON	100 FT
GA1316	ZLH 4x4x4 HYPALON	100 FT
GA1650A	ZLH-AL 3X3X3 HYPALON ALUMINUM	100 FT
GA1652A	ZLH-AL 4X4X4 HYPALON ALUMINUM	100 FT
GA1310-AG	ZLH 3x3x3 HYPALON **AGION**	100 FT
GA1316-AG	ZLH 4x4x4 HYPALON **AGION**	100 FT
GA15105	ZLN-HD 3X3X3 **40oz. NEOPRENE	100 FT
GA15165	ZLN-HD 4X4X4 **40oz NEOPRENE **SPECIAL	100 FT
GA4000	ZLTF 3x3x3 TEFLON	100 FT
GA4010	ZLTF 4x4x4 TEFLON	100 FT

Silent Duct With Rope

- Elgen's Silent Duct with Rope eliminates duct system noises and vibrations. It attaches to a fan source on one side and ductwork on the other
- All Elgen fabrics are designed to meet NFPA-701 (formerly UL-214)
- Tested in accordance with LEEDS
- Requirements Meets SMACNA
- Optional Construction Available
- MADE IN USA

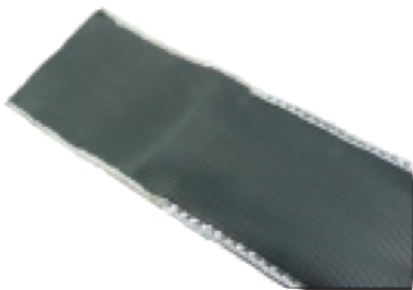

Item #	Description	Box QTY
GA1900	SDL 3x3x3 VINLON	100 FT
GA1909	SDL 4x4x4 VINLON	100 FT
GA1501	SDN 3x3x3 NEOPRENE	100 FT
GA1535	SDN 4X4X4 NEOPRENE	100 FT
GA1590	SDN-AL 3x3x3 NEOPRENE ALUMINUM	100 FT
GA1574	SDN-AL 4x4x4 NEOPRENE ALUMINUM	100 FT
GA1592	SDN-SS 3x3x3 NEOPRENE 304STST	100 FT
GA1572	SDN-SS 4x4x4 NEOPRENE 304STST	100 FT
GA1596	SDN-SS 3x3x3 NEOPRENE 316STST	100 FT
GA1550	SDN-SS 4x4x4 NEOPRENE 316STST	100 FT
GA1501PCD	SDN 3X3X3 *PCD COATED* SPECIAL	100 FT
GA1535PCD	SDN 4X4X4 *PCD COATED* SPECIAL	100 FT
GA2100	SDSG 3x3x3 SILGUARD	100 FT
GA2101	SDSG 4x4x4 SILGUARD	100 FT
GA1300	SDH 3x3x3 HYPALON	100 FT
GA1324	SDH 4x4x4 HYPALON	100 FT
GA1582	SDH-AL 3X3X3 HYPALON *ALUM	100 FT
GA1583	SDH-AL 4x4x4 HYPALON *ALUM	100 FT
GA1650	SDH-SS 3x3x3 HYPALON 304STST	100 FT
GA1652	SDH-SS 4X4X4 HYPALON 304STST	100 FT
GA1651	SDH-SS 3X3X3 HYPALON 316STST	100 FT
GA1653	SDH-SS 4X4X4 HYPALON 316STST	100 FT
GA15015	SDN-HD 3X3X3 **40 oz NEOPRENE **SPECIAL	100 FT
GA1535X40	SDN-HD 4x4x4 **40 oz NEOPRENE SPECIAL	100 FT
GA5000	SDHT 3X3X3 **1800 DEG. FABRIC WHITE SIDE MUST BE IN AIRFLOW	100 FT
GA5010	SDHT 4X4X4 **1800 DEG FABRIC WHITE SIDE MUST BE IN AIRFLOW	100 FT
GA5025	SDHT-SS 3X3X3 **1800 DEG ST/ST WHITE SIDE MUST BE IN AIRFLOW	100 FT
GA5030	SDHT-SS 4X4X4 *1800 DEG. ST/ST WHITE SIDE MUST BE IN AIRFLOW	100 FT
GA4080	SDTF-SS 3x3x3 TEFLON ST/ST#304	100 FT
GA4100	SDTF-SS 4x4x4 TEFLON ST/ST#304	100 FT

DUCT CONNECTORS AND COMPONENTS

Residential Connector

• Elgen's Residential 1-3/4"x3"x1-3/4" duct connector eliminates duct system noises and vibrations. This is done with an airtight flexible connection consisting of a fabric that attaches to sheet metal on both sides

• All Elgen fabrics are designed to meet NFPA-701 (formerly UL-214)

• Tested in accordance with LEEDS

• Requirements Meets SMACNA

• Optional Construction Available

• MADE IN USA

Item #	Description	Box QTY
GA1932	SLRL 100 FT ROLL VINLON	100 FT
GA1835	SLRN CONNECTOR	100 FT

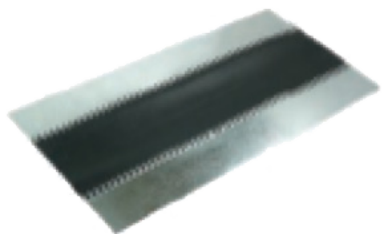

DUCT CONNECTORS AND COMPONENTS

1" Flat Drive

- The Elgen 1" Flat Drive is used for making a connection between two rectangular duct walls. The Elgen 1" Flat Drive is used in Low Pressure applications
- Meet 2005 SMACNA Standards
- Optional Construction Available
- MADE IN USA



Item #	Description	Bundle QTY
EG0952	DRIVE MATERIAL 1"26GA* X10FT -BLUE-	100FT
EG09505	DRIVE MATERIAL 1"24GA. X10FT -ORANGE-	100FT
EG0906	DRIVE MATERIAL 1" 22GA X10FT -GREEN-	100FT
EG0955	DRIVE MATERIAL 1" **ALUM** X10FT	100FT
EG0951A	DRIVE MATERIAL 1" **ST/ST** X10FT	100FT
EG0951-316	DRIVE MATERIAL 1" 24GA **#316 ST/ST** X10FT	100FT
EG0951	DRIVE MATERIAL 1"24GA X10FT**GALVANEAL**	100FT
EG0953	DRIVE MATERIAL 1" **PVC** X10FT	100FT
EG0950-AG	DRIVE MATERIAL 1"24GA. X10FT *AGION*	100FT

1" Flat-S Slip

- The Elgen 1" Flat S is used for making a connection between two rectangular duct walls. It is used in Low Pressure applications
- Meets 2005 SMACNA Standards
- Optional Construction Available
- MADE IN USA

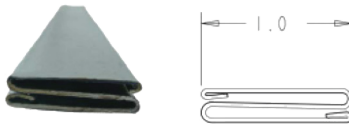

Item #	Description	Bundle QTY
EG0935	SLIP FLAT"S" 26GA. 1" X10FT -BLUE-	100FT
EG09205	SLIP FLAT"S" 24GA. 1" X10FT **GALVANEAL**	100FT
EG0931	SLIP FLAT "S" **22GA** 1" X10FT -GREEN-	100FT
EG0930	SLIP FLAT"S" 26GA. 1" X10FT -BLUE-	100FT
EG0925A	SLIP FLAT "S" 1" **ALUM** X10FT	100FT
EG0920	SLIP FLAT"S" 24GA. 1" X10FT -ORANGE-	100FT
EG0920-AG	SLIP FLAT"S" 24GA. 1" X10FT *AGION*	100FT
EG0925	SLIP FLAT "S" 1" **ST/ST** X10FT	100FT
EG0926	SLIP FLAT "S" 1" **PVC** X10FT	100FT

1" Standing S Slip

- The Elgen 1" Standing-S is used for making a connection between two rectangular duct walls. It is used in Low Pressure applications
- Meets 2005 SMACNA Standards
- Optional Construction Available
- MADE IN USA

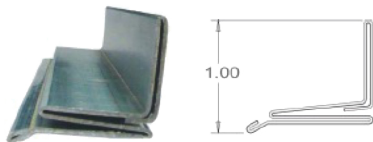

Item #	Description	Bundle QTY
EG0950	SLIP STANDING "S" *26GA* 1" X10FT -BLUE-	225/BOX
EG0900	SLIP STANDING"S" 24GA.1" X10FT -ORANGE-	225/BOX
EG0901	SLIP STAND."S" 1"22GA SPECIAL X10FT -GREEN-	225/BOX
EG0903	SLIP STAND."S" 1"20GA SPECIAL X10FT	225/BOX
EG0900A	SLIP STANDING "S" **ALUM** X10FT	225/BOX
EG0900S	SLIP STANDING "S" **ST/ST** X10FT 24GA	225/BOX
EG0900S-316	SLIP STANDING "S" #316 ST/ST** X10FT 24GA	225/BOX
EG09005	SLIP STANDING"S" 24GA.1" X10FT *GALVANEAL*	225/BOX
EG0904	SLIP STANDING "S" **PVC** X10FT	225/BOX
EG0900-AG	SLIP STANDING"S" 24GA.1" X10FT *AGION*)	225/BOX
EG0905	STANDING "S" 1-5/8" 20GA SPEC*	50FT

1/2" Standing-S Slip

- The Elgen 1/2" Standing-S is used for making a connection between two rectangular duct walls. It is used in Low Pressure applications
- Meets 2005 SMACNA Standards
- Optional Construction Available
- MADE IN USA



Item #	Description	Bundle QTY
EG0902	SLIP STANDING"S"24GA **1/2** X10FT *100FT/BNDL*	100FT
EG0902A	SLIP STANDING"S"24GA **1/2** X10FT *100FT/BNDL**ALUMINUM**	100FT

1" Standing Drive

- The Elgen 1" Flat Drive is used for making a connection between two rectangular duct walls. The Elgen 1" Flat Drive is used in Low Pressure applications
- Meet 2005 SMACNA Standards
- Optional Construction Available
- MADE IN USA



Item #	Description	Bundle QTY
EG0907	DRIVE "STANDING" SPEC* 1" 24GA X10FT (100FT/BDL)	100FT
EG0907	DRIVE "STANDING" SPEC* 1" 24GA X10FT (100FT/BDL)	100FT
EG0920	DRIVE "STANDING" SPEC* 1" 22GA X10FT(100FT/BDL)	100FT
EG0906-AG	DRIVE "STANDING" SPEC* 1" 24GA X10FT *AGION* (100FT/BDL)	100FT

DUCT PROTECTION FILM



Shrink Wrap W/PSA

• Elgen's Shrink Wrap with PSA is used on any exposed sections of the duct work
 • It prevents outside debris from entering the ductwork and contaminating the duct work

- No Need to tape
- No Loose ends flapping
- Does not leave any residue
- No VOC's - Meets LEEDS Requirements
- UV Resistant
- Waterproof
- MADE IN USA

• Available Roll sizes
 2' - 3' - 4' - 5'

• Available Thickness
 2mil - 3mil - 4.5mil

• Available Colors
 Blue - Clear - Black - Green - Orange
 Red- Brown - Purple - Yellow

CUSTOMIZABLE WITH YOUR LOGO

Part #	Description
PF0010	SHRINK WRAP 24"X200FT *3MIL* (300/SKID) BLUE - ADHESIVE IN*
PF0010-HT	SHRINK WRAP 24"X200FT *3MIL* (300/SKID) BLUE - ADHESIVE IN**High Tack*
PF0020	SHRINK WRAP 24"X200FT *3MIL* (300/SKID) BLUE - ADHESIVE OUT
PF0030	SHRINK WRAP 24"X200FT *3MIL* (300/SKID) GREEN - ADHESIVE IN
PF0070	SHRINK WRAP 24"X200FT *3MIL* (300/SKID) RED - ADHESIVE IN
PF0090	SHRINK WRAP 24"X200FT *3MIL* (300/SKID) CLEAR - ADHESIVE IN
PF0092	SHRINK WRAP 24"X200FT *3.5MIL* (300/SKID) CLEAR - ADHESIVE IN
PF0110	SHRINK WRAP 24"X200FT *4.5MIL* (216/SKID) BLUE - ADHESIVE INSIDE
PF0130	SHRINK WRAP 24"X200FT W/PSA **BLACK 4.5MIL** *OUTSIDE TACK*
PF0150	SHRINK WRAP 24"X600FT *3MIL* (100/SKID) BLUE - ADHESIVE IN*
PF0205	SHRINK WRAP 36"X200FT *3MIL* (200/SKID) BLUE - ADHESIVE IN*
PF0205-HT	SHRINK WRAP 36"X200FT *3MIL* (300/SKID) BLUE - ADHESIVE IN**High Tack*
PF0215	SHRINK WRAP 36"X200FT *3MIL* (200/SKID) BLUE - ADHESIVE OUT
PF02851	SHRINK WRAP 36"X200FT *3.5MIL* (200/SKID) CLEAR - ADHESIVE IN
PF0305	SHRINK WRAP 36"X200FT *4.5MIL* (144/SKID) BLUE - ADHESIVE INSIDE
PF0325	SHRINK WRAP 36"X200FT W/PSA **BLACK 4.5MIL** OUTSIDE TACK**
PF0405	SHRINK WRAP 48"X200FT *3MIL* (100/SKID) BLUE - ADHESIVE IN*
PF0415	SHRINK WRAP 48"X200FT *3MIL* (100/SKID) BLUE - ADHESIVE OUT
PF0486	SHRINK WRAP 48"X200FT *3.5MIL* (100/SKID) CLEAR - ADHESIVE IN
PF0505	SHRINK WRAP 48"X200FT *4.5MIL* (80/SKID) BLUE - ADHESIVE INSIDE
PF0525	SHRINK WRAP 48"X200FT W/PSA **BLACK 4.5MIL** OUTSIDE TACK
PF0605	SHRINK WRAP 60"X200FT *3MIL* (100/SKID) BLUE - ADHESIVE IN*
PF06851	SHRINK WRAP 60"X200FT *3.5MIL* (100/SKID) CLEAR - ADHESIVE IN
PF0705	SHRINK WRAP 60"X200FT *4.5MIL* BLUE - ADHESIVE INSIDE

VANE

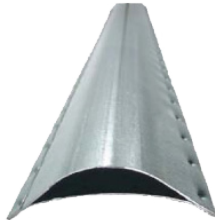

Double Wall Vane

- Elgen’s Double Wall Turning Vane is used in conjunction with Elgen’s Double Wall Vane Rail, for directing air flow through a rectangular elbow
- Meets SMACNA Requirements
- MADE IN USA

Item #	Description	Bundle QTY
GC1009	AV-7 GALV 2" TURNING VANE X10F	100FT
GC1011	AV-11 ALUM 2" TURNING VANE X10FT	100FT
GC1012	AV-15 ALUM 4" TURNING VANE X10FT	50FT
GC1013	AV-9 GALV 4" TURNING VANE X10FT	50FT
GC1014	AV-19 STST#304 4" TURNING VANE X10FT	50FT
GC1024	AV-17 STST#304 2" TURNING VANE X10FT	100FT
GC1027	AV-17** 316SS 2" TURNING VANE X10FT	100FT
GC10145	AV-19** 316SS 4" TURNING VANE X10FT *	50FT



4” Insulated Acoustical Vane

- Elgen’s 4” Insulated Acoustical Turning Vane is used in conjunction with Elgen’s Double Wall Vane Rail, for directing air flow through a rectangular elbow
- Insulation provides sound deadening properties
- Meets SMACNA Requirements
- MADE IN USA

Item #	Description	Bundle Qty
VR0160	ACCOUSTICAL VANE #ACC-14 4" X10FT	50FT
VR0165	ACCOUSTICAL VANE 4" ST#304 X10FT	50FT
VR0170	ACCOUSTICAL VANE 4" ST#316 X10FT	50FT
VR0175	ACCOUSTICAL VANE 4" ALUMINUM X10FT	50FT

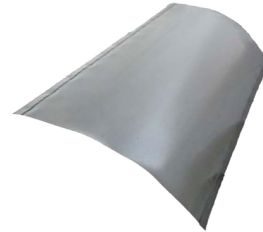

4” Single Wall Vane

- Elgen’s Single Wall Turning Vane is used in conjunction with Elgen’s Single Wall Vane Rail, for directing air flow through a rectangular elbow
- Meets SMACNA Requirements
- MADE IN USA

Item #	Description	Bundle QTY
VR0200	4" SINGLE WALL VANE* SPECIAL X10FT	50FT



Nipple for Vane

- Elgen’s Nipple for Vane is Designed to hold the vane in position inside the ductwork
- Can be used with other vane systems

Item #	Description	Box Qty
DH5060	NIPPLE FOR VANE (100/BOX)	100/BOX

RAIL

2" & 4" Double Wall Vane Rail

- Elgen's Double Wall Vane Rail is used in conjunction with Elgen's Double Wall Vane
- Used for securing and aligning Vane to direct airflow through rectangular elbows
- Conforms to SMACNA Spacing requirements
- Refer to 2005 SMACNA Figure 4-3
- MADE IN USA



Item #	Description	Bundle QTY
VR0065	ELGEN RAIL 2" X10FT (200FT/BOX)	200FT
VR0070	ELGEN RAIL 2" ST/ST#304 X10FT (200FT/BOX)	200FT
VR0075	ELGEN RAIL 2" ALUMINUM X10FT(200FT/BOX)	200FT
VR0080	ELGEN RAIL 4" X10FT(100FT/BOX)	100FT
VR0085	ELGEN RAIL 4" ST/ST#304 X10FT(100FT/BOX)	100FT
VR0090	ELGEN RAIL 4" ALUMINUM X10FT (100FT/BOX)	100FT
VR0065-AG	ELGEN RAIL 2" AGION (200FT/BOX)	200FT
VR0080-AG	ELGEN RAIL 4" AGION (100FT/BOX)	100FT
VR0072	ELGEN RAIL 2" ST/ST#316 X10FT (200FT/BOX)	200FT
VR0088	ELGEN RAIL 4" ST/ST#316 X10FT (100ft/BDL)	100FT

2" & 4" Elgen Super Rail

- Elgen's Double Wall Vane Rail is used in conjunction with Elgen's Double Wall Vane
- Used for securing and aligning Vane to direct airflow through rectangular elbows
- Conforms to SMACNA Spacing requirements
- Refer to 2005 SMACNA Figure 4-3
- MADE IN USA



Item #	Description	Bundle QTY
VR0066	ELGEN SUPER RAIL 2" X10FT *NEW RAIL*	100FT
VR0068	ELGEN SUPER RAIL 4" X10FT *NEW RAIL*	100FT

Single Wall Vane Rail

- Elgen's Single Wall Vane Rail is used for securing and aligning Double Wall or Single Wall Turning Vane
- This process directs the airflow through rectangular duct elbows

Item #	Description	Box QTY
GC1000	EVR-1 GALV VANE RUNNER	100FT
GC1001	EVR-2 GALV TWINSTRIP VANE RUN	100FT
GC1003	EVR-1 ALUM VANE RUNNER	100FT
GC1004	EVR-2 ALUM TWINSTRIP VANE RUN	100FT
GC1006	EVR-1 ST/ST VANE RUNNER	100FT
GC1007	EVR-2 ST/ST TWINSTRIP VANE RUN	100FT
GC1025	EVR-2 316SS TWINSTRIP VANE RUN	100FT
GC1200	EVR-1 316SS VANE RUNNER	100FT



EVR-1 4" Single Wall Rail



EVR-2 2" Single Wall Rail

HANGING SYSTEMS & REINFORCEMENTS

Strut

- Elgen Strut Channel is used primarily as a trapeze hanger for commercial construction
- Meets SMACNA table 5-4 in the 2005 3rd Edition for load requirements
- Meets MFMA-4
- Optional Construction Available
- MADE IN USA



Item #	Description	Bundle QTY
EG0815	STRUT 1-5/8" X12GA X10FT** *SLOTTED*	500FT
EG0815-250	STRUT 1-5/8" X12GA X10FT** *SLOTTED*	250FT
EG0820	STRUT 1-5/8" 14GA X10FT** *SLOTTED*	500FT
EG0820-250	STRUT 1-5/8" X14GA X10FT** *SLOTTED*	250FT
EG0840	STRUT 1-5/8" X12GA **X20FT** *SLOTTED*	500FT
EG0840S	STRUT 1-5/8" X14GA **ST/ST#304 X20FT *SLOTTED*	500FT
EG0845	STRUT 1-5/8" X14GA **X20FT** *SLOTTED*	500FT
EG0845S	STRUT 1-5/8" X12GA **ST/ST#304 X20FT *SLOTTED*	500FT
EG0816S	STRUT 1-5/8" X14GA **ST/ST#304 X10FT *SLOTTED*	500FT
EG0818S-250FT	STRUT 1-5/8" X12GA **ST/ST#304 X10FT *SLOTTED*	250FT
EG0815-B	BACK-TO-BACK STRUT 1-5/8" 12GA SLOTTED HOLES **X20FT**	400FT
EG0830	STRUT 13/16" X14GA X10FT** *SLOTTED*	500FT
EG0830-20	STRUT 13/16" X14GA **X20FT** *SLOTTED*	1000FT
EG0830-250	STRUT 13/16" X14GA X10FT** *SLOTTED*	250FT
EG0831	STRUT 13/16" X12GA X10FT** *SLOTTED*	500FT
EG0831-20	STRUT 13/16" X12GA **X20FT** *SLOTTED*	1000FT
EG0836	STRUT 3-1/4" X12GA X10FT** *SLOTTED*	200FT
EG0836-20	STRUT 3-1/4" X12GA **X20FT** *SLOTTED*	400FT
EG0839	STRUT 2-7/16"X12GA X10FT** *SLOTTED*	300FT
EG0839-20	STRUT 2-7/16" X12GA **X20FT** *SLOTTED*	600FT

Back to Back Strut

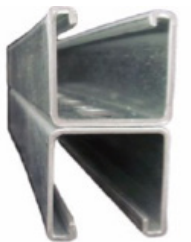

3-1/4" x 1-5/8"

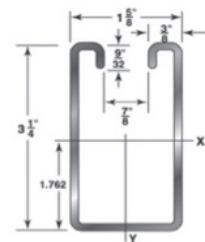

2-7/16" x 1-5/8"

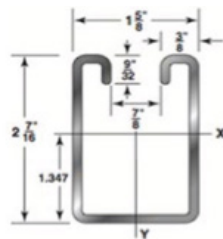
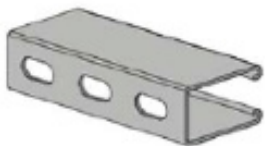

1-5/8" x 1-5/8"

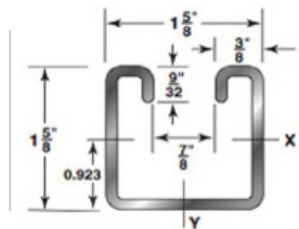

13/16" x 1-5/8"

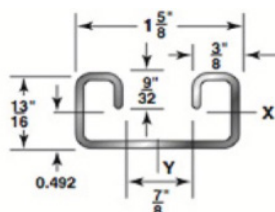

HANGING SYSTEMS & REINFORCEMENTS

90 Degree Brackets



Item #	Description	Box QTY	# of Holes	A Dimension	B Dimension	C Dimension
EG08388	90DEG ANGLE BRACKET - 4-HOLE	50/BOX	4	9/16"	3-1/2"	4-1/8"
EG08389	90DEG ANGLE BRACKET - 3-HOLE	25/BOX	3	9/16"	1-5/8"	4-1/8"

Saddle Washer



Item #	Description	Box Qty
WA1050-C	SADDLE WASHER 1/2" *WITH NUT* FOR STRUT**NUT ATTACHED*	100/BOX
WA1030	SADDLE WASHER 1/2" **NO NUT** FOR STRUT	100/BOX
WA1040	SADDLE WASHER 3/8" *WITH NUT* FOR STRUT**NUT ATTACHED*	100/BOX
WA1020-C	SADDLE WASHER 3/8" **NO NUT** FOR STRUT	100/BOX

Spring Nuts



Item #	Description	Box QTY
EG0815N	UNISTRUT NUT W/ SPRING 3/8" N-821 FOR 1-5/8" STRUT	100/BOX
EG0815N2	UNISTRUT NUT W/SPRING 1/2" N-822 FOR 1-5/8" STRUT	100/BOX
EG0815N1	UNISTRUT NUT W/SPRING 1/4" VSN-1025 FOR 1-5/8" STRUT	100/BOX

Square Washers

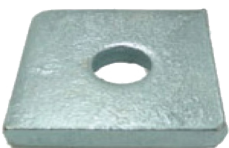

Item #	Description	Box QTY
WA1000	F201 SQUARE WASHER FOR 1/2"RD 1-5/8"X1-5/8"(W/ 9/16" HOLE)	100/BOX
WA1010	F201 SQUARE WASHER FOR 3/8"RD 1-5/8"X1-5/8"(W/ 7/16" HOLE)	100/BOX

U-Clamps



Item #	Description	Box QTY
EG08375	UNISTRUT #VX-7038-A U-BRACKET FOR1-5/8" STRUT45 Degrees	50/BOX
EG08375-S	UNISTRUT #VX-7038-A U-BRACKET FOR 1-5/8" STRUT 45 Degrees *ST/ST 304*	50/BOX

HANGING SYSTEMS & REINFORCEMENTS

Two Way Gripper

- Elgen's Two Way Gripper is a steel cable hanging system, intended to add a simpler way of suspending ductwork
- ASTM E8 & A370 Approved
- Complies with SMACNA upper and lower attachment standards if used in strict accordance with manufacturer's installation instructions
- 5 to 1 Safety Factor
- Open Bore for ease of use
- Extra hanging configurations and angle
- Effortless hand adjustment
- Extra wire holes provide clean aesthetics

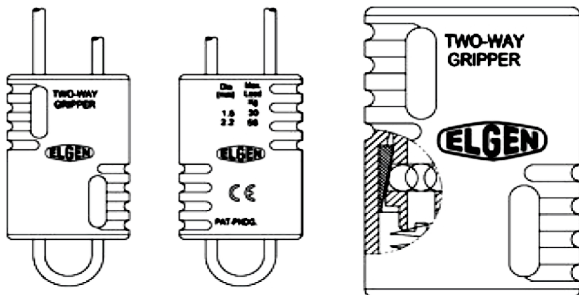

Item #	Description	Box Qty	Working Load
RC5200	TWG-125 - 5/64"/125#	500	125 LBS
RC5200-10	TWG-125 - 5/64"/125#	10	125 LBS
RC5300	TWG-250 1/8"/250#	400	250 LBS
RC5300-10	TWG-250 1/8"/250#	10	250 LBS
RC5400	TWG-650 3/16"/650#	120	650 LBS
RC5400-4	TWG-650 3/16"/650#	4	650 LBS

Item #	Description	Pack Qty
RC5250	WR10 FOR TWG 125 - 2.2MM (5/64) X 500' - 7X7 GALV	500FT
RC5350	WR20 FOR TWG-250 - 3.2MM (1/8) X 500' - 7X7 GALV	500FT
RC5450	WR30 FOR TWG-650 - 4.8MM (3/16) X 500' - 7X19 GALV	500FT
RC5201	WR10310 FORTWG-125 - 2.2MM (5/64) X 3" X 10' - 7X7 GALV	10/Pack
RC5202	WR10315 FOR TWG-125 - 2.2MM (5/64) X 3" X 15' - 7X7 GALV	10/Pack
RC5203	WR10330 FORTWG-125 - 2.2MM (5/64) X 3" X 30' - 7X7 GALV	10/Pack
RC5301	WR20310 FOR TWG-250 - 3.2MM (1/8) X 3" X 10' - 7X7 GALV	10/Pack
RC5302	WR20315 FOR TWG-250 - 3.2MM (1/8) X 3" X 15' - 7X7 GALV	10/Pack
RC5303	WR20330 FOR TWG-250 - 3.2MM (1/8) X 3" X 30' - 7X7 GALV	10/Pack
RC5500	WRC - WIRE ROPE CUTTER	1
RC5700-KIT	100 TWG-125, 1 500' SPOOL WR10 WIRE, 1 WRC WIRE ROPE CUTTER, & 5 GAL BKT W/COUNTER LID	1
RC5800-KIT	100 TWG-250, 1 500' SPOOL WR20 WIRE, 1 WRC WIRE ROPE CUTTER, & 5 GAL BKT W/COUNTER LID	1

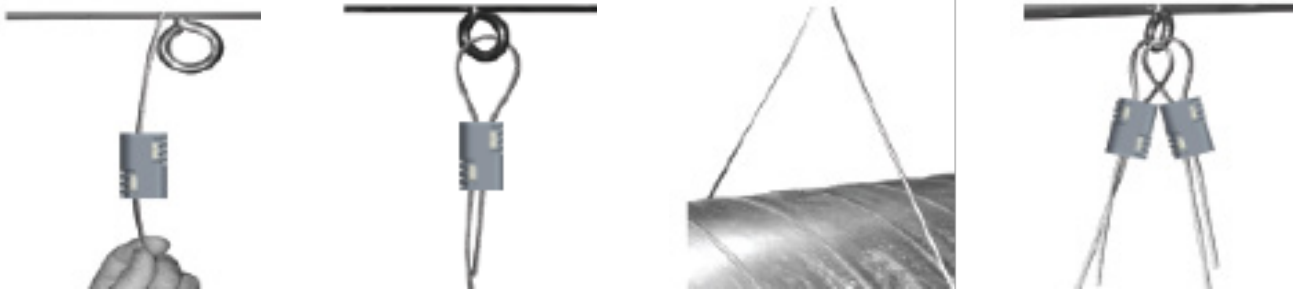

Degrees from Vertical	TWG 10 Load Ability	TWG 20 Load Ability	TWG 30 Load Ability
0	125 lbs	250 lbs	650 lbs
15	115 lbs	235 lbs	625 lbs
25	105 lbs	220 lbs	575 lbs
30	100 lbs	210 lbs	555 lbs
45	85 lbs	175 lbs	455 lbs
50	80 lbs	155 lbs	410 lbs

HANGING SYSTEMS & REINFORCEMENTS



Threaded Rod

- Threaded Rod is used in conjunction with strut channel and other misc hardware to hang ductwork where it requires a heavy application
- Material meets ASTM A307 Grade A
- Zinc Plating meets ASTM F1941 FeZn3A
- Tensile Strength 60,000 PSI Min

Item #	Description	Bundle QTY
TR0005	1/4X6 THREADED ROD Z/P	300FT
TR0010	1/4X10 THREADED ROD Z/P	500FT
TR0015	3/8X6 THREADED ROD Z/P	150FT
TR0015-BLK	3/8X6 THREADED ROD BLACK	150FT
TR0020	3/8X10 THREADED ROD Z/P	250FT
TR0020-US	3/8X10 THREADED ROD Z/P AMERICAN MADE	250FT
TR0035	1/2X6 THREADED ROD Z/P	72FT
TR0035-BLK	1/2X6 THREADED ROD BLACK	90FT
TR0040	1/2X10 THREADED ROD Z/P	120FT
TR0045	3/4X6 THREADED ROD Z/P	30FT
TR0045-BLK	3/4X6 THREADED ROD BLACK	30FT
TR0115	3/8X6 THREADED ROD ST/ST#304	150FT
TR0135	1/2X6 THREADED ROD ST/ST#304	90FT



Threaded Rod Couplings

Item #	Description	Box QTY
TR0160	COUPLING 3/8" FOR ROD x 1-1/8" LONG	1,250/BOX
TR0160-C	COUPLING 3/8" FOR ROD x 1-1/8" LONG	100/BOX



Punched Angle

- Punched angle is designed for reinforcing ductwork
- Optional Construction Available
- MADE IN USA

Item #	Description	Bundle QTY
EG0645	ANGLE IRON 1-1/2X1-1/2 X10FT 16 GAUGE PUNCHED	MTO
EG0645-20	ANGLE IRON 1-1/2X1-1/2 X20FT 16 GAUGE PUNCHED	MTO
EG0646	ANGLE IRON 1-1/2X1-1/2 X10FT 14 GAUGE PUNCHED	MTO
EG0646-20	ANGLE IRON 1-1/2X1-1/2 X20FT 14 GAUGE PUNCHED	MTO
EG0647	ANGLE IRON 2X2 X10 FT 16 GAUGE PUNCHED	MTO
EG0647-20	ANGLE IRON 2X2 X20 FT 16 GAUGE PUNCHED	MTO
EG0648	ANGLE IRON 2X2X10 FT 14 GAUGE PUNCHED	MTO
EG0648-20	ANGLE IRON 2X2X20 FT 14 GAUGE PUNCHED	MTO



1" Hanger Strap

- Elgen's hanger strap is used for hanging round or rectangular ductwork
- Optional construction available
- MADE IN USA

Item #	Description	Bundle QTY	Skid QTY
HS16	16 GA HANGER STRAP X10FT	100FT	10,000FT
HS18	18 GA HANGER STRAP X10FT	100FT	10,000FT
HS20	20 GA HANGER STRAP X10FT	100FT	15,000FT
HS22	22 GA HANGER STRAP X10FT	100FT	15,000FT
HS24	24 GA HANGER STRAP X10FT	100FT	20,000FT



Beam Clamps

Item #	Description	Bundle QTY
BC0050	3/8" BEAM CLAMP *Z/P* W/LN	100/BOX
BC0090	1/2" BEAM CLAMP Z/P W/LN	100/BOX
BC0034	3/8" BEAMCLAMP*ST/ST#304* W/LN	25/BOX
BC0061	38T *Z/P* BEAM CLAMP MALL. SMALL-MOUTH (X 3/4")	100/BOX
BC0066	38W *Z/P*WIDE MOUTH CLAMP WIDE-MOUTH (X 1-1/4")	100/BOX
BC0134	12W BEAM CLAMP W/M 1/2" *Z/P* WIDE-MOUTH	100/BOX
BC0131	12T BEAM CLAMP S/M 1/2" *Z/P* SMALL-MOUTH	50/BOX



Strap Hangers

- Designed for supporting air duct
- Made from galvanized steel

Item #	Description	Box QTY
BC0430	PSF516 MINERL. 5/16" TO 1/2"	100/BOX
BC0435	PSF516R MINERL. 5/16" TO 1/2"	100/BOX
BC0440	PSF18 MINERL. 1/8" TO 1/4"	100/BOX
BC0460	PSF18R MINERL. 1/8" TO 1/4"	100/BOX
BC0470	PSF916R MINERL. 9/16" TO 3/4"	100/BOX
BC0480	PSF916 MINERL. 9/16" TO 3/4"	100/BOX
BC0640	4H58 ERICO CADDY HANGER SFC516	100/BOX
BC0650	4H912 ERICO CADDY HGR SFC916	100/BOX
BC0664	4H24 ERICO CADDY HANGER SFC18	100/BOX

HANGING SYSTEMS & REINFORCEMENTS

Double Expansion Anchor

- Double Expansion Anchors fix machine bolts in materials of indeterminate strength
- They can be used in poured concrete or concrete block, as well as brick and stone based materials



Item #	Description	Box QTY
AN0740	1/4" DOUBLE EXPANSION SHIELD #9510	50/BOX
AN0770	3/8" DOUBLE EXPANSION SHIELD #9520	50/BOX

Drop-In Anchor

- Drop in Anchor is an all-steel, machine bolt anchor
- They can be used in solid concrete, hard stone, and solid block



Item #	Description	Box QTY
AN0320	#6304 1/4" DROP-IN ANCHOR	100/BOX
AN0325	#6308 1/2" DROP-IN ANCHOR	50/BOX
AN0330B	#6306 3/8" DROP-IN ANCHOR	50/BOX
AN1380	3/8" DROP-IN SETTING TOOL	MTO

Nail-In Anchor

- Nail-Ins are designed for general anchoring to concrete, brick, stone, and masonry



Item #	Description	Box QTY
AN1065	1/4X3/4 NAILINS #2806	100/BOX
AN1075	1/4X1 NAILINS POWERS #2808	100/BOX
AN1081	1/4X1-1/4 NAILINS **POWERS** #02814	100/BOX
AN1086	1/4X1-1/2 NAILINS **POWERS** #2820	100/BOX
AN1095	1/4X2 NAILINS POWERS #2826	100/BOX

Stud Anchor

- Stud Anchors are designed for use in solid concrete
- The drill bit diameter for the pilot hole is the same as the anchor diameter



Item #	Description	Box QTY
AN0275	1/4X1-3/4 STUD #7400	100/BOX

Toggle Bolt

- Toggle bolts are anchors for use in hollow walls and hollow masonry applications
- The wing spreads the force over a larger load bearing surface and comes attached to a machine screw



Item #	Description	Box QTY
AN0490-K	1/4X3 TOGGLE BOLT	100/BOX
AN0500-K	1/4X4 TOGGLE BOLT	100/BOX
AN0505-C	1/4X6 TOGGLE BOLT	100/BOX
AN0460-K	3/8X3 TOGGLE BOLT	100/BOX
AN0466-K	3/8X4 TOGGLE BOLT	100/BOX
AN0531-C	1/4" TOGGLE WING ONLY	100/BOX
AN0532-C	3/8" TOGGLE WING ONLY	100/BOX

Wedge Anchor

- Wedge anchors are pre-assembled single unit sleeve anchors to be used in concrete, block, brick, and stone



Item #	Description	Box QTY
AN1040	5/16X1-1/2 SLEEVE ANCHOR #05005S POWERS LOKBOLT	100/BOX
AN10405	5/16X2-1/2 SLEEVE ANCHOR #05010S POWERS LOKBOLT	100/BOX

SEALANTS & ADHESIVES



Precision Adhesives Duct Seal Pro

- A top quality water based, high pressure/high velocity duct sealant for commercial and residential ductwork
- LEED V4 Qualified
- Qualifies for LEED Credit
- Noncombustible/Nonflammable
- Paintable
- Tested in accordance with and meets requirements of NFPA 90A & 90B
- Meets Requirements of UL 723/ASTM E-84/ UL-181
- MADE IN USA

Item #	Description	Box QTY
SL1505	PRECISION ADHESIVE'S W/B DUCT-SEAL PRO *GRAY SMOOTH	4 Gal/Box
SL1511	PRECISION ADHESIVE'S W/B DUCT-SEAL PRO *GRAY SMOOTH 10.3 OZ TUBES	24 Tubes/Box
SL1525	PRECISION ADHESIVE'S W/B DUCT-SEAL PRO *GRAY FIBER	4 Gal/Box
SL1531	PRECISION ADHESIVE'S W/B DUCT-SEAL PRO *FIBER 10.3 OZ TUBES	24 Tubes/Box



Precision Adhesive 6010-A

- Premium Grade UL listed duct sealant with zero reportable VOC
- Forms an air-tight and water-tight seal
- Flexes with expansion and contraction of the sheet metal
- Bonds well to aluminum, galvanized, or stainless steel
- Red Color makes it easy to see where sealant has been applied

Item #	Description	Box QTY
SL0015A	6010-A SPECIAL SEALER TUBES	24/Box



Precision Adhesives Duct-Solv-0

- Precision Adhesives Duct-Solv-0 is a premium grade solvent duct sealant with ZERO reported VOCs
- Applicable for high pressure/high velocity systems in both commercial and residential ductwork
- Mold and mildew resistant
- Conforms to the requirements of NFPA 90A and 90B
- Meets all SMACNA seal classes

Item #	Description	Box QTY
SL1600	ELGEN DUCT - SOLV 0 - TUBES	24 Tubes/Box
SL1610	ELGEN DUCT - SOLV 0	4 Gal/Box



Precision Adhesive 2084-A

- Premium Grade UL listed duct sealant with zero reportable VOC
- Forms an air-tight and water-tight seal
- Flexes with expansion and contraction of the sheet metal
- Bonds well to aluminum, galvanized, or stainless steel
- Aluminum color blends well with either aluminum or galvanized sheet metal

Item #	Description	Box QTY
SL0025A	2084-A *SPECIAL* TUBES	24 Tubes/Box

SEALANTS & ADHESIVES



Pumpable Sealer

• Pumpable Sealant is a one component, non-drying, permanently flexible material designed for sealing rigid and expansion joints between all combinations of wood, glass, metals, and masonry surfaces without the need or requirement of a primer

Item #	Description	Gallons
AH0695	PUMPABLE SEALANT 5-GAL	5 Gal Bucket
AH0700	PUMPABLE SEALANT **55 GAL DRUM** **NO BAGS IN THE DRUMS**	55Gal Drum



100% Silicone Tubes

• Elgen's 100% Silicone is a mildew resistant, acetoxy-based high performance silicone designed for many applications

- Qualifies for LEED Credit
- 100% Anti-Microbial Formula
- Food Grade Compliant
- FDA/USDA Compliant

Item #	Description	Box QTY
SL0345	ALUM SILICONE TUBE	24/BOX
SL0360	CLEAR SILICONE TUBE	24/BOX
SL0365	WHITE SILICONE TUBE	24/BOX
SL0355	BLACK SILICONE TUBE	24/BOX



Precision Water Based Liner Adhesive

• Precision's water based liner adhesive is an economical, water based product for bonding insulation to metal surfaces

- This adhesive can be sprayed, brushed, or rolled
- Designed for both manual and automatic applications
- Non-Flammable
- Fast drying with high tack
- Contains zero VOC
- Meets Requirements for Iowa Precision Coil Lines
- Lead Compliant
- Meets requirements for NFPA 90A & 90B
- Meets requirements of ASTM C-916

Item #	Description	QTY
AH0565	410 ELGEN A-410WB WHITE*	5Gal Bucket
AH0570	410 ELGEN A-410WB WHITE*	55Gal Drum



Spray on Liner Adhesive

• California Compliant

- Formulated for rapid application
- Bond can withstand heat and humidity
- Adheres to various substances
- Contains no PCB's, CFC's, Asbestos
- Contains a non-flammable adhesive and a patent pending non-flammable propellant

Item #	Description	QTY
SE00035	SPRAY ADHESIVE 40# NON-FLAMMABLE	1/Box
SE00037	SPRAY ADHESIVE 200# CANISTER NON-FLAMMABLE	1
SE00037-BLACK	SPRAY ADHESIVE *BLACK* 200# CANISTER	1
AH0256	SPRAY ADHESIVE - CAN #AE-77 (12/PACK)	12/Box
SE0044	SPRAY GUN FOR SPRAY TANKS *SPRAY TIP NOT INCLUDED*	1
SE0042	12' HOSE FOR SPRAY TANKS	1
SE00445	TIP FOR SPRAY GUN	1

SEALANTS & ADHESIVES



Elgen Super De-Galv

- Elgen De-Galv removes galvanized buildup from machinery rollers and other areas where galvanized deposits may appear.
- Contains no CFCs

Item #	Description	Box QTY
PL0190	DE-GALV ELGEN SPRAY	12/Box



AE-88 Duct Butter

- Easy Application
- Quick Drying
- Tack Free
- Convenient
- Flexible
- Durable
- Encapsulates
- California Compliant
- Formulated for rapid application
- Bond can withstand heat and humidity
- Adheres to various substances
- Contains no PCB's, CFC's, Asbestos
- Contains a non-flammable adhesive and a patent pending non-flammable propellant

Item #	Description	Box QTY
AH5000	AE-88 SPRAY-ON EDGE COATING	12/Box



AE-40

- AE-40 is an unusually fast penetrant that can be used to loosen frozen threads or parts that have rusted together
- Acts to penetrate, lubricate, prevent rust and corrosion
- Protects bare metal against rust and corrosion up to 6 months

Item #	Description	Box QTY
PL0201	WD-40 CAN *AE-40*	12/Box



Paint Brushes

Item #	Description	Box QTY
PL0249	BRUSH 1" FOR PAINT	36/Box
PL0250	BRUSH 1-1/2" FOR PAINT	24/Box
PL0255	BRUSH 2" FOR PAINT	24/Box
PL0260	BRUSH 3" FOR PAINT	12/Box
PL0265	BRUSH 4" FOR PAINT	12/Box

SPIRAL CONNECTORS, FITTINGS & COMPONENTS

Spiral Elbows

- Elgen's spiral elbow features quick and easy installation due to a "fitting size" 3" straight in and straight out along with a raised bead for coupling with spiral pipe
- Compared to stamped elbows, construction time and installation time is reduced drastically, giving the contractor significant savings in job costing
- Quality Control tested to meet a perfect 90 Degree
- Meets all SMACNA required pressure ratings
- Complies with ASTM A525
- Optional Construction Available
- MADE IN USA



Item #	Description
ESP4-45-1.5	4" 45 DEGREE SPIRAL ELBOW 1-1/2 X RADIUS
ESP4-90-1.5	4" 90 DEGREE SPIRAL ELBOW 1-1/2 X RADIUS
ESP5-45-1.5	5" 45 DEGREE SPIRAL ELBOW 1-1/2 X RADIUS
ESP5-90-1.5	5" 90 DEGREE SPIRAL ELBOW 1-1/2 X RADIUS
ESP5-45-1.5	5" 45 DEGREE SPIRAL ELBOW 1-1/2 X RADIUS
ESP6-45-1	6" 45 DEGREE SPIRAL ELBOW 1 X RADIUS
ESP6-45-1.5	6" 45 DEGREE SPIRAL ELBOW 1-1/2 X RADIUS
ESP6-90-1	6" 90 DEGREE SPIRAL ELBOW 1 X RADIUS
ESP6-90-1.5	6" 90 DEGREE SPIRAL ELBOW 1-1/2 X RADIUS
ESP7-45-1.5	7" 45 DEGREE SPIRAL ELBOW 1-1/2 X RADIUS
ESP7-90-1	7" 90 DEGREE SPIRAL ELBOW 1 X RADIUS
ESP7-90-1.5	7" 90 DEGREE SPIRAL ELBOW 1-1/2 X RADIUS
ESP8-45-1	8" 45 DEGREE SPIRAL ELBOW 1 X RADIUS
ESP8-45-1.5	8" 45 DEGREE SPIRAL ELBOW 1-1/2 X RADIUS
ESP8-90-1	8" 90 DEGREE SPIRAL ELBOW 1 X RADIUS
ESP8-90-1.5	8" 90 DEGREE SPIRAL ELBOW 1-1/2 X RADIUS
ESP9-45-1.5	9" 45 DEGREE SPIRAL ELBOW 1-1/2 X RADIUS
ESP9-90-1.5	9" 90 DEGREE SPIRAL ELBOW 1-1/2 X RADIUS
ESP10-45-1	10" 45 DEGREE SPIRAL ELBOW 1 X RADIUS
ESP10-45-1.5	10" 45 DEGREE SPIRAL ELBOW 1-1/2 X RADIUS
ESP10-90-1	10" 90 DEGREE SPIRAL ELBOW 1 X RADIUS
ESP10-90-1.5	10" 90 DEGREE SPIRAL ELBOW 1-1/2 X RADIUS
ESP12-45-1	12" 45 DEGREE SPIRAL ELBOW 1 X RADIUS
ESP12-45-1.5	12" 45 DEGREE SPIRAL ELBOW 1-1/2 X RADIUS
ESP12-90-1	12" 90 DEGREE SPIRAL ELBOW 1 X RADIUS
ESP12-90-1.5	12" 90 DEGREE SPIRAL ELBOW 1-1/2 X RADIUS
ESP14-45-1.5	14" 45 DEGREE SPIRAL ELBOW 1-1/2 X RADIUS
ESP14-90-1.5	14" 90 DEGREE SPIRAL ELBOW 1-1/2 X RADIUS
ESP16-45-1.5	16" 45 DEGREE SPIRAL ELBOW 1-1/2 X RADIUS
ESP16-90-1.5	16" 90 DEGREE SPIRAL ELBOW 1-1/2 X RADIUS
ESP18-90-1.5	18" 90 DEGREE SPIRAL ELBOW 1-1/2 X RADIUS
ESP20-90-1.5	20" 90 DEGREE SPIRAL ELBOW 1-1/2 X RADIUS
ESP22-90-1	22" 90 DEGREE SPIRAL ELBOW 1 X RADIUS

SPIRAL CONNECTORS, FITTINGS & COMPONENTS

Elgen Spiral Ring

- Elgen's Spiral Flange is a product for joining sections of spiral pipe
- Can be installed in shop or on site
- Durable hemmed edge prevents damage
- Available in welded and split construction
- Long inner leg for easier installation
- Single wall and double wall options available
- All ring 1/4" Undersized to easily fit pipe
- Sizes available - 4" - 50" and 50" - 96"
- Optional Construction Available
- MADE IN USA



Item #	Description
SP100651	6" SW ELGEN SPIRAL RING
SP100652	8" SW ELGEN SPIRAL RING
SP10065	10" SW ELGEN SPIRAL RING
SP10066	12" SW ELGEN SPIRAL RING
SP10067	14" SW ELGEN SPIRAL RING
SP10068	16" SW ELGEN SPIRAL RING
SP10069	18" SW ELGEN SPIRAL RING
SP10070	20" SW ELGEN SPIRAL RING
SP10071	22" SW ELGEN SPIRAL RING
SP10072	24" SW ELGEN SPIRAL RING
SP10073	26" SW ELGEN SPIRAL RING
SP10074	28" SW ELGEN SPIRAL RING
SP10075	30" SW ELGEN SPIRAL RING
SP10076	32" SW ELGEN SPIRAL RING
SP10077	34" SW ELGEN SPIRAL RING
SP10078	36" SW ELGEN SPIRAL RING
SP10079	38" SW ELGEN SPIRAL RING
SP10080	40" SW ELGEN SPIRAL RING

Spiral Coupling

- Elgen's coupling for spiral pipe is designed for low, medium, and high pressure applications
- Made from one piece of metal
- Welded Seam for added strength and low leakage
- Optional Construction Available
- MADE IN USA



Item #	Description
SP0245	COUPLING 4" 24GA
SP0250	COUPLING 5" 24GA
SP0255	COUPLING 6" 24GA
SP0260	COUPLING 7" 24GA
SP0265	COUPLING 8" 24GA
SP0270	COUPLING 9" 24GA
SP0275	COUPLING 10" 24GA
SP0280	COUPLING 12" 24GA
SP0285	COUPLING 14" 24GA
SP0290	COUPLING 16" 24GA
SP0295	COUPLING 18" 24GA
SP0300	COUPLING 20" 24GA
SP0305	COUPLING 22" 24GA
SP0310	COUPLING 24" 24GA
SP0245A	COUPLING 4" **ALUMINUM**
SP0245S	COUPLING 4" **STAINLESS STEEL**
SP0250A	COUPLING 5" **ALUMINUM**
SP0250S	COUPLING 5" **STAINLESS STEEL**
SP0255A	COUPLING 6" **ALUMINUM**
SP0255S	COUPLING 6" **STAINLESS STEEL**
SP0260A	COUPLING 7" **ALUMINUM**
SP0260S	COUPLING 7" **STAINLESS STEEL**
SP0265A	COUPLING 8" **ALUMINUM**
SP0265S	COUPLING 8" **STAINLESS STEEL**
SP0270A	COUPLING 9" **ALUMINUM**
SP0270S	COUPLING 9" **STAINLESS STEEL**
SP0275A	COUPLING 10" **ALUMINUM**
SP0275S	COUPLING 10" **STAINLESS STEEL**
SP0280A	COUPLING 12" **ALUMINUM**
SP0280S	COUPLING 12" **STAINLESS STEEL**
SP0285A	COUPLING 14" **ALUMINUM**
SP0285S	COUPLING 14" **STAINLESS STEEL**
SP0290A	COUPLING 16" **ALUMINUM**
SP0290S	COUPLING 16" **STAINLESS STEEL**
SP0295A	COUPLING 18" **ALUMINUM**
SP0295S	COUPLING 18" **STAINLESS STEEL**
SP0300A	COUPLING 20" **ALUMINUM**
SP0300S	COUPLING 20" **STAINLESS STEEL**
SP0305A	COUPLING 22" **ALUMINUM**
SP0305S	COUPLING 22" **STAINLESS STEEL**
SP0310A	COUPLING 24" **ALUMINUM**
SP0310S	COUPLING 24" **STAINLESS STEEL**

ACCESS DOORS

Type "A" Access door with Hinge & Cam

- Elgen's access door with hinge and cam lock frame is used to access the inside of rectangular ductwork
- Meets 2005 SMACNA Standards for pressure class & gauges.
- Optional Construction Available
- MADE IN USA



Item #	Description
AD0010	6X6 DOOR "A" GAL
AD0020	8X8 DOOR "A" GAL
AD0030	10X10 DOOR "A" GAL
AD0040	12X12 DOOR "A" GAL
AD0050	14X14 DOOR "A" GAL
AD0070	16X16 DOOR "A" GAL
AD0080	18X18 DOOR "A" GAL
AD0090	20X20 DOOR "A" GAL
AD0110	24X24 DOOR "A" GAL

Type "B" Access door with Cam Lock

- Elgen's access door tab lock frame is used to access the inside of rectangular ductwork
- Meets 2005 SMACNA Standards for pressure class & gauges
- Optional Construction Available
- MADE IN USA



Item #	Description
AD0140	6X6 DOOR "B" GAL
AD0150	8X8 DOOR "B" GAL
AD0160	10X10 DOOR "B" GAL
AD0165	12X12 DOOR "B" GAL
AD0170	14X14 DOOR "B" GAL
AD0172	16X16 DOOR "B" GAL
AD0204	18X18 DOOR "B" GAL
AD0205	20X20 DOOR "B" GAL
AD0218	24X24 DOOR "B" GAL

Type "H" Press on Door with Hinge & Cam

- Elgen's Press on access door with hinge and cam lock frame is used to access the inside of rectangular ductwork
- Meets 2005 SMACNA Standards for pressure class & gauges
- Optional Construction Available
- MADE IN USA



Item #	Description
AD1340	6X6 PRESS ON "H"
AD1345	8X8 PRESS ON "H"
AD1347	10X10 PRESS ON "H"
AD1380	12X12 PRESS ON "H"
AD1385	14X14 PRESS ON "H"
AD1387	16X16 PRESS ON "H"
AD1389	18X18 PRESS ON "H"
AD1405	24X24 PRESS ON "H"

Type "C" Press on Access Door with Cam

- Elgen's Press on access door with cam lock frame is used to access the inside of rectangular ductwork
- Meets 2005 SMACNA Standards for pressure class & gauges.
- Optional Construction Available
- MADE IN USA



Item #	Description
AD1420	6X6 PRESS ON "C"
AD1425	8X8 PRESS ON "C"
AD1430	10X10 PRESS ON "C"
AD1435	12X12 PRESS ON "C"
AD1440	14X14 PRESS ON "C"
AD1450	16X16 PRESS ON "C"
AD1460	18X18 PRESS ON "C"
AD1465	20X20 PRESS ON "C"
AD1475	24X24 PRESS ON "C"

ACCESS DOORS

Round Access Doors

- Elgen's Round Access Door is used to provide easy access into round ductwork.
- Meets 2005 SMACNA Standards for pressure class & gauge.
- Optional Construction Available
- MADE TO ORDER
- MADE IN USA



Item #	Description
AD1238	8X4 DOOR FOR FLAT**
AD1115	12X8 DOOR FOR FLAT**
AD1238A	16X12 DOOR FOR FLAT**
AD1218	8X4 DOOR FOR 4" ROUND
AD1220	8X4 DOOR FOR 6" ROUND
AD1235	8X4 DOOR FOR 8" ROUND
AD1236	8X4 DOOR FOR 10" ROUND
AD1237	8X4 DOOR FOR 12" ROUND
AD12371	8X4 DOOR FOR 14" ROUND
AD12372	8X4 DOOR FOR 16" ROUND
AD1104	12X8 DOOR FOR 12" ROUND
AD1105	12X8 DOOR FOR 14" ROUND
AD1110	12X8 DOOR FOR 16" ROUND
AD1111	12X8 DOOR FOR 18" ROUND
AD1112	12X8 DOOR FOR 20" ROUND
AD12387	16X12 DOOR FOR 16" ROUND
AD12391	16X12 DOOR FOR 22" ROUND
AD12392	16X12 DOOR FOR 24" ROUND
AD12393	16X12 DOOR FOR 26" ROUND
AD12394	16X12 DOOR FOR 28" ROUND
AD12396	16X12 DOOR FOR 30" ROUND
AD12397	16X12 DOOR FOR 32" ROUND
AD12398	16X12 DOOR FOR 34" ROUND
AD12399	16X12 DOOR FOR 36" ROUND
AD123991	16X12 DOOR FOR 38" ROUND
AD12400	16X12 DOOR FOR 40" ROUND
AD12401	16X12 DOOR FOR 42" ROUND
AD12402	16X12 DOOR FOR 44" ROUND
AD12403	16X12 DOOR FOR 46" ROUND
AD12404	16X12 DOOR FOR 48" ROUND

Duct Board Doors

- Elgen's access door with tab lock frame is used to access the inside of rectangular ductwork
- Meets 2005 SMACNA Standards for pressure class & gauge
- 2.5" long tabs for ductboards
- Optional Construction Available
- MADE TO ORDER
- MADE IN USA



Item #	Description
AD013811	4X4 DOOR "B" WITH 2-1/2" LONG TABS FOR DUCT BOARD
AD0144	6X6 DOOR "B" WITH 2-1/2" LONG TABS FOR DUCT BOARD
AD0153	8X8 DOOR "B" WITH 2-1/2" LONG TABS FOR DUCT BOARD
AD0028	8X8 DOOR "A" WITH 2-1/2" LONG TABS FOR DUCT BOARD
AD0161	10X10 DOOR "B" WITH 2-1/2" LONG TABS FOR DUCT BOARD
AD1212DB	12X12 DOOR "B" WITH 2-1/2" LONG TABS FOR DUCT BOARD
AD1414DB	14X14 DOOR "B" WITH 2-1/2" LONG TABS FOR DUCT BOARD
AD0169	16X16 DOOR "B" WITH 2-1/2" LONG TABS FOR DUCT BOARD
AD1818DB	18X18 DOOR "B" WITH 2-1/2" LONG TABS FOR DUCT BOARD
AD02051	20X20 DOOR "B" WITH 2-1/2" LONG TABS FOR DUCT BOARD
AD2424DB	24X24 DOOR "B" WITH 2-1/2" LONG TABS FOR DUCT BOARD

ACCESS DOORS



Casing Doors

- Elgen's casing door with hinge & latches is used to access the inside of plenums
- Available with or without a window
- Meets SMACNA Standards for pressure class & gauges
- Optional Construction Available
- Available 1", 2", or 4" Thick
- MADE TO ORDER
- MADE IN USA



Flush Mount Access Door with press on Frame

- Elgen's Access Door with cam lock only frame is used inside of rectangular duct work
- Meets 2005 SMACNA standards for pressure class & gauges
- Optional Construction Available
- MADE TO ORDER
- MADE IN USA

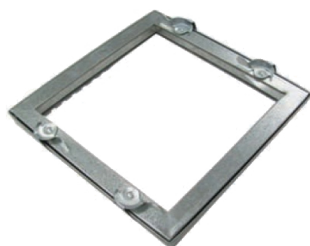

Access Door with Full Window

- Elgen's access door with full window is used to access the inside of rectangular ductwork
- See Through Panel is made of 2 layers of 3/16" thick plexiglass, sealed with silicone
- Meets 2005 SMACNA Standards for pressure class & gauges
- MADE TO ORDER
- Optional Construction Available
- MADE IN USA



Access Door with Round Window

- Elgen's access door with full window is used to access the inside of rectangular ductwork
- See Through Panel is made of 2 layers of 3/16" thick plexiglass, sealed with silicone
- Meets 2005 SMACNA Standards for pressure class & gauges
- MADE TO ORDER
- Optional Construction Available
- MADE IN USA

ACCESS DOORS



High Temp Fiberglass Gasket

- Elgen's High Temp Fiberglass Gasket is used for high temp applications in or around boilers, ovens, and most commonly used for welded black iron grease exhaust
- Type E Glass knitted and coated with a high temperature flame resistant silicon rubber
- Manufactured in accordance with ASTM D-578
- High temp applications up to 1000 Deg Fahrenheit
- MADE IN USA

Item #	Description	Roll QTY
ST0945	FIBERGLASS 1/8 X 1 *SOLID	100FT
ST0955	FIBERGLASS 1/8 X 1-1/2 *SOLID	100FT
ST0975	FIBERGLASS 1/8 X 1-1/2 *LADDER	100FT
ST0960	FIBERGLASS 1/8 X 2 *SOLID	100FT



#10 Amerloc Latch

Item #	Description	Stud Size	Box QTY
BC0901	#10 AMERLOCLATCH	1/4" x 2-1/4"	100/BOX



#15 Amerloc Latch

Item #	Description	Stud Size	Box QTY
BC0910-25	#15 AmerlocLatch	3/8" x 3-3/8"	25/BOX
BC0910	#15 AmerlocLatch	3/8" x 3-3/8"	100/BOX



#20 Amerloc Latch

Item #	Description	Stud Size	Box QTY
BC0920	#20 AmerlocLatch	1/2" x 4"	60/BOX



#20L Amerloc Latch

Item #	Description	Stud Size	Box QTY
BC0923	#20L AmerlocLatch	1/2" x 6"	35/BOX
BC0923-10	#20L AmerlocLatch	1/2" x 6"	10/BOX

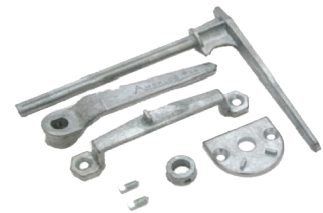

#30 Amerloc Latch

Item #	Description	Stud Size	Box QTY
BC0930	#30 L6.5 AmerlocLatch	1/2" x 6-1/2"	25/BOX

ACCESS DOORS

Grease Duct Doors 2300 DEG

- Elgen Grease Duct Access Door is used for grease duct applications
- Meets NFPA 96 standards
- Use with temperatures up to 2300DEG F
- No frame needed to install and seal
- Easy to open and close

Item #	Description
AD8x4-2300	8X4 ELGEN GREASE DUCT DOOR 2300DEG
AD10x6-2300	10X6 ELGEN GREASE DUCT DOOR 2300DEG
AD12x8-2300	12X8 ELGEN GREASE DUCT DOOR 2300DEG
AD16x12-2300	16X12 ELGEN GREASE DUCT DOOR 2300DEG

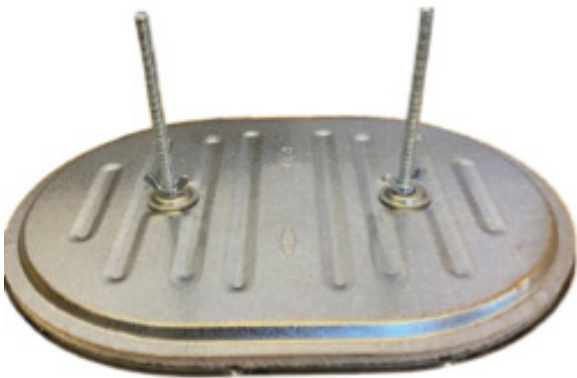

INSULATION & COMPONENTS

Owens Corning Duct Liner



Typical Physical Properties

Property	Test Method	Value
Operating Temperature	ASTM C 411	250°F (121°C)
Maximum Air Velocity	UL 181 Erosion Test ASTM C 1071	6,000 fpm (30.5 m/sec)
Water Vapor Sorption (by weight)	ASTM C 1104	<3% at 120°F (49°C), 95% R.H.
Fungi Resistance	ASTM C 1338	Meets requirements
Fungi Resistance	ASTM G 21	Meets requirements
Bacteria Resistance	ASTM G 22	Meets requirements
Corrosiveness	ASTM C 665 (Corrosiveness Test)	Will not cause corrosion greater than caused by sterile cotton on aluminum or steel*
Thermal Conductivity k at 75°F (λ at 24°C mean)	ASTM C 518	Btu·in/hr·ft ² ·°F W/m·°C
Type 200		0.23 0.034
R-4.2		0.24 0.035
R-6.3		0.24 0.035
R-8		0.24 0.035
Surface Burning Characteristics	ASTM E 84, UL 723, CAN/ULC S102	25 50
Flame Spread		
Smoke Developed		

- Duct Liner absorbs noise within sheet metal ducts, and contributes to indoor comfort by lowering heat loss or gain through duct walls
- Qualifies for LEED Credit
- GREENGUARD CERTIFIED
- Absorbs fan and A/C turbulence noise and reduces popping noises within sheet metal ducts
- Outstanding thermal and acoustical performance
- Bacterial and fungal growth resistant with an EPA registered biocide that helps protect the airstream surface from microbial growth
- Additional sizes available upon request

Item #	Description
DL0040	1/2X47 LINER #200 X100FT
DL0042	1/2X48 LINER #200 X100FT
DL0051	1/2X56-1/4 LINER #200 X100FT
DL0055	1/2X59 LINER #200 X100FT
DL0100	1X47 LINER #150 X100FT
DL01035	1X48" LINER #150 X100FT
DL0111	1X56-1/4 LINER #150 X100FT
DL0115	1X59 LINER #150 X100FT
DL0197	1-1/2X48 LINER 1.5# X50FT
DL0198-100	1-1/2X56-1/4" LINER 1.5# X100FT #634468
DL0200-100	1-1/2X59 LINER #150 X100FT #769768
DL0340	2X47 LINER #150 X50FT
DL0285	2X48 LINER #150 X50FT
DL0291	2X56-1/4 LINER #150 X50FT
DL0295	2X59 LINER #150 X50FT

Knauf Duct Liner



TECHNICAL DATA

Property (Unit)	Test	Performance
Corrosiveness	ASTM C665	Does not accelerate corrosion of steel
Corrosion	ASTM C1617	Pass
Maximum Service Temperature	ASTM C411	250° F (121° C)
Maximum Air Velocity	ASTM C1071, UL 181 Erosion Test	Max. 6,000 ft./min. (30.5 m/sec.) Tested to 15,000 ft./min. (76.2 m/sec.)
Water Vapor Sorption (by weight)	ASTM C1104	Less than 3%
Mold Growth	ASTM C1338, UL 2824, ASTM G21, ASTM G22	Pass
Surface Burning Characteristics (flame spread/smoke developed)	ASTM E84, UL 723, CAN/ULC S102	FHC 25/50; UL Classified

- Duct Liner absorbs noise within sheet metal ducts, and contributes to indoor comfort by lowering heat loss or gain through duct walls
- Qualifies for LEED Credit
- GREENGUARD CERTIFIED
- Absorbs fan and A/C turbulence noise and reduces popping noises within sheet metal ducts
- Outstanding thermal and acoustical performance
- Bacterial and fungal growth resistant with an EPA registered biocide that helps protect the airstream surface from microbial growth

* Additional sizes available upon request

Item #	Description
DL000021	1/2X47" KNAUF 2# X100FT
DL000022	1/2X48" KNAUF 2# X100FT
DL00003	1/2X56-1/4" KNAUF 2# X100FT
DL00004	1/2X59" KNAUF 2# X100FT
DL00005	1/2X60" KNAUF 2# X100FT
DL000052	1X47 KNAUF 1.5# X100FT
DL000061	1X48 KNAUF 1.5# X100FT
DL00007	1X56-1/4"KNAUF 1.5# *X100FT*
DL00008	1X59 KNAUF 1.5# *X100FT*
DL000081	1X60 KNAUF 1.5# *X100FT*
DL000085	1-1/2X47 KNAUF 1.5# X50FT
DL000086	1-1/2X48 KNAUF 1.5# X50FT
DL000087	1-1/2X56-1/4 KNAUF 1.5# X50FT
DL00009	1-1/2X59 KNAUF 1.5# X50FT
DL000012	2X47 KNAUF 1.5# X50FT
DL000013	2X48 KNAUF 1.5# X50FT
DL000014	2X56-1/4 KNAUF 1.5# X50FT
DL000015	2X59 KNAUF 1.5# X50FT
DL000016	2X60 KNAUF 1.5# X50FT

INSULATION & COMPONENTS

Weld Pins

- Elgen Superpoint Weld Pins are used for fastening Fiberglass Duct Liner to the inside of the Duct Wall
- Raised Head which allows better movement through the hopper
- Can be used in any Insulation Weld Pin machine
- Rings in the nail head provide more consistent welds
- Beveled edge prevents tearing of the fiberglass liner
- Meets SMACNA Standards
- MADE IN USA



Item #	Description	Bucket QTY
WP0010	1/2" SUPERPOINT WELD PINS	6,000
WP0020	3/4" SUPERPOINT WELD PINS	5,000
WP0040	1" SUPERPOINT WELD PINS	4,000
WP0050	1-1/8" SUPERPOINT WELD PINS	4,000
WP0060	1-1/4" SUPERPOINT WELD PINS	4,000
WP0070	1-1/2" SUPERPOINT WELD PINS	3,500

Bang on Pins

- Bang-On Pins is used to attach insulation to sheet metal
- Specifically designed to fasten acoustical duct liner to the inside of heating, ventilating and air conditioning ductwork
- Function properly over normally accepted operating range of temperature 32 degrees F to 250 degrees F and are not adversely affected at temperatures of 0 degrees F to 550 degrees F
- Exceeds current SMACNA standards for corrosion resistance



Item #	Description	Bucket QTY
MF0005	050 GRIPNAIL 1/2"	5,000
MF0015	100 GRIPNAIL 1" 1.5#	5,000
MF0005	050 GRIPNAIL 1/2"	5,000

Insulation Hangers

- Elgen's insulation hangers are used to secure fiberglass insulation to the inside or outside of the ductwork
- Baseplate is coated with adhesive and covered with silicone release paper



Item #	Description	Box QTY
MF0084	SAH-1-1/4" PEEL&PRESS STEEL	100
MF0086	SAH-1-3/4" PEEL&PRESS STEEL	100
MF0090	SAH-2-1/2" PEEL&PRESS STEEL	100
MF0129-G	MS WASHERS FOR SAH *GALV*	1000

INSULATION & COMPONENTS

Aluminum Foil Tape

- High tensile strength aluminum foil backing, combined with a high performance solvent acrylic adhesive, protected by an easy release silicon release paper
- Aluminum backing provides excellent reflection of both heat and light
- Good aging resistance both indoors and outdoors
- Low moisture vapor transmission rate offers excellent sealing and patching performance



Item #	Description	Box QTY
TA0120	3"x50 YDS - ALUM FOIL TAPE (ARTIC WEATHER APPROVED)	16/BOX
TA0277	FASSON 0800 - 2.5" 2 MIL FOIL TAPE UL 181A-P/B-FX	16/BOX
TA0278	FASSON 0817 - 2" 2 MIL FOIL TAPE	24/BOX
TA0279	FASSON 0817 - 3" 2 MIL FOIL TAPE	16/BOX
TA0280	FASSON 0817 - 4" 2 MIL FOIL TAPE	12/BOX
TA0281	FASSON 0827 - 3" FOIL SCRIM TAPE	16/BOX

Duct Tape

- High quality polyethylene coated cloth tape which conforms well to irregular surfaces and adheres to a wide variety of surfaces
- Conforms well to irregular surfaces
- Tested in accordance with UL 723

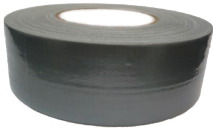

Properties	Metric	English	Test Method
Total Thickness	152.4 Micron 254 Micron	6.0 Mil 10.0 Mil	ASTM D 1000
Adhesion to Steel	5.14 N/cm	47 Oz./In.	PSTC-101
Tensile Strength	47.28 N/cm	27 Lb/In	ASTM D 1000
Max Performance Temperature	93 °C	200 °F	
Surface Burning Characteristics	0 Flame 0 Smoke		

Item #	Description	Box QTY
TA0030	2" X 60 YDS - 10 MIL DUCT TAPE SILVER - HEAVY DUTY	24/BOX
TA0104	2" X 60 YDS - 6 MIL DUCT TAPE SILVER	24/BOX

FSK Tape

- High Performance solvent acrylic adhesive, protected by an easy-release silicone release paper
- 3-way Foil-Scrim-Kraft backing provides excellent reflection of both heat and light
- Low moisture vapor transmission rate makes our FSK tape an excellent vapor barrier



Properties	Value	Test Method
Backing Thickness	4.5 Mil	PSTC-133 / ASTM D 3652
Total Thickness	6.5 Mil	PSTC-133 / ASTM D 3652
Adhesion to Steel	90 Oz./In.	PSTC-101 / ASTM D 3330
Tensile Strength	30 Lb/In	PSTC-131 / ASTM D 3759
Elongation	1%	PSTC-131 / ASTM D 3759
Minimum Application Temperature	-25 ° F	Internal
Surface Burning Characteristics	0 Flame 0 Smoke	UL 723

Item #	Description	Box QTY
TA0110	3"x50 YDS - FSK TAPE ARCTIC WEATHER APPROVED	16/BOX
TA0111	4"x50 YDS - FSK TAPE ARCTIC WEATHER APPROVED	12/BOX

INSULATION & COMPONENTS

Owens Corning Duct Wrap

- Absorbs noise and reduces popping noises caused by expansion, contraction, and vibration
- Assured thermal R-Value performance
- Bacterial and fungal growth resistant with an EPA registered biocide that helps protect the air stream surface from microbial growth
- Thermal/Acoustical insulation board plus jacket forms a single component duct system, thus reducing inspection time
- Virtually eliminates air leakage thus saving energy and removing the need for system overdesign
- GREENGUARD Certified



Item #	Description
DL1504	1-1/2X48 *DUCT WRAP* x100FT
DL15041	1-1/2X48 *DUCT WRAP* 1 LB X100FT
DL1510	2.2"X48" *DUCT WRAP* X75FT
DL1540	3X48 *DUCT WRAP* X50FT

Knauf Duct Wrap

- Absorbs noise and reduces popping noises caused by expansion, contraction, and vibration
- Assured thermal R-Value performance
- Bacterial and fungal growth resistant with an EPA registered biocide that helps protect the air stream surface from microbial growth
- Thermal/Acoustical insulation board plus jacket forms a single component duct system, thus reducing inspection time
- Virtually eliminates air leakage thus saving energy and removing the need for system overdesign
- GREENGUARD Certified



Item #	Description
DL1503	1-1/2X48 KNAUF *DUCT WRAP* x100FT
DL1509	2"X48" KNAUF *DUCT WRAP* X75FT
DL15401	3X48 KNAUF *DUCT WRAP* X50FT
DL1540	3X48 *DUCT WRAP* X50FT

Rubber Liner

- Mold Resistant: Made with Microban antimicrobial product protection
- Indoor Air Quality-friendly: Fiber free, formaldehyde free, low VOCs, nonparticulating
- Quiet: Noise blocking and vibration damage
- Durable: No fragile vapor retarder

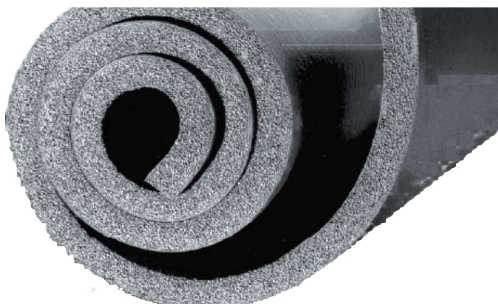

Item #	Description
DL1490	1/2X59 RUBBER LINER (X100FT)
DL1492	1X56-1/4 RUBBER LINER(X50FT)
DL14925	1X59 RUBBER LINER (X50FT)
DL14927	2X60 RUBBER LINER (X25FT)
DL14928	1-1/2X60 RUBBER LINER (X35FT)

INSULATION & COMPONENTS

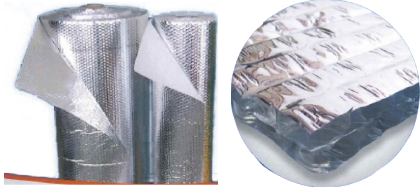

Foil Bubble Wrap

- Can yield a thermal resistance of R-6 around HVAC ducts installed with spacers
- Minimizes the risk of condensation
- Resists growth of fungi, mold, and mildew
- Greatly reduces operating noise transfer
- Safe and easy to install, no special tools required
- Non-toxic; itch and fiber free
- Improves interior comfort

Item #	Description
DL5510-100	FOIL BUBBLE WRAP 5ft X 100ft



FireWrap

- Thinnest, lightest system available
- Saves weight, space, labor
- High temperature, biosoluble insulation
- 1 and 2 hour fire endurance rating
- Zero clearance to combustibles at the overlap or collar
- Alternate to fire-rated shaft enclosure

Item #	Description
DL7500	24"X25"X1.5"X6PCF FYREWWRAP ELITE 1.5 GREASE DUCT - UL

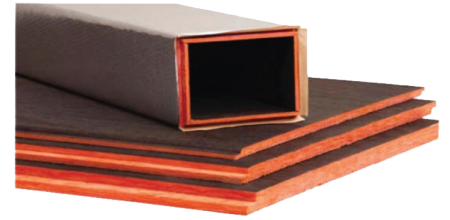

Duct Board

- Duct board is a rigid, resin bonded fibrous glass board with a tough, damage resistant, flame retardant, reinforced aluminum foil facing
- Absorbs noise and reduces popping noises caused by expansion, contraction and vibration
- Assured thermal R-Value performance
- Bacterial and fungal growth resistant with an EPA registered biocide that helps protect the air stream surface from microbial growth
- Virtually eliminates air leakage, thus saving energy and removing the need for system oversize

Item #	Description
DL6400	DUCT BOARD 1"X48"X120" T0475 (EACH)

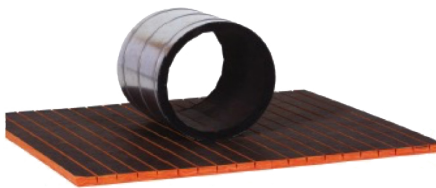

Spiral Board

- Outstanding thermal and acoustical performance
- Economical, cost effective alternative to round double-wall configuration air ducts
- Bacterial and fungal growth resistant with an EPA registered biocide that protects the airstream surface from microbial growth

Property	Test Method	Value
Maximum Temperature Limits Internal External	UL 181	250°F (121°C) 150°F (66°C)
Maximum Air Velocity	UL 181 Erosion Test	6,000 fpm (30.5 m/s)
Water Vapor Sorption	ASTM C1104	<3% by weight at 120°F (49°C), 95% R.H.
Mold Growth	UL 181	Meets Requirements
Mold Growth	ASTM C1338	Meets Requirements
Fungi Resistance	ASTM G21	Meets Requirements
Bacteria Resistance	ASTM G22	Meets Requirements
Surface Burning Characteristics Flame Spread Smoke Developed	UL 723 ¹	<25 <50

Item #	Description
DL6500	SPIRAL BOARD 1" X-SMALL SIZE FOR 8"-14" ID ROUND (GROOVED 10FT WAY)
DL6500-4	SPIRAL BOARD 1" X-SMALL SIZE FOR 8"-14" ID ROUND (GROOVED 4FT WAY)
DL6500-4-1.6	SPIRAL BOARD 1" X-SMALL SIZE FOR 8"-14" ID ROUND (1.6 SPACE) (GROOVED 4FT WAY)
DL6500-1	SPIRAL BOARD 1" X-SMALL SIZE FOR 8"-14" ID ROUND (1" SPACE) (GROOVED 10FT WAY)
DL6500-1.3	SPIRAL BOARD 1" X-SMALL SIZE FOR 8"-14" ID ROUND (1.3" SPACE) (GROOVED 10FT WAY)
DL6500-1.6	SPIRAL BOARD 1" X-SMALL SIZE FOR 8"-14" ID ROUND (1.6 SPACE) (GROOVED 10FT WAY)
DL6510	SPIRAL BOARD 1" - SMALL SIZE FOR 16"-30" ID ROUND (1.6") (GROOVED 4FT WAY)
DL6510-10	SPIRAL BOARD 1" - SMALL SIZE FOR 16"-30" ID ROUND (1.6") (GROOVED 10FT WAY)
DL6520	SPIRAL BOARD 1" LARGE SIZE FOR 32" ID AND LARGER (3.2") (GROOVED 4FT WAY)
DL6501-10	SPIRAL BOARD 1-1/2" X-SMALL SIZE FOR 8"-14" ID ROUND (GROOVED 10FT WAY)
DL6501-4	SPIRAL BOARD 1-1/2" X-SMALL SIZE FOR 8"-14" ID ROUND (GROOVED 4FT WAY)
DL6510-4	SPIRAL BOARD 1-1/2" X48" X 120" (GROOVED 4FT WAY)
DL6502	SPIRAL BOARD 1-1/2" SMALL SIZE FOR 16"-30" ID ROUND (GROOVED 4FT WAY)
DL6510-2	SPIRAL BOARD 2" X48" X 120" (GROOVED 4FT WAY)

FLEX DUCT & COMPONENTS

Insulated Flex Duct

- Air-tight Inner Core - Energy efficient/No Fiberglass erosion into air stream
- Encapsulated Wire Helix - No unraveling when cut to length
- Thick Blanket of Fiberglass Insulation - Energy efficient/Excellent thermal characteristics
- Tough Reinforced metalized Polyester Jacket - Tear and puncture resistant/Low maintenance
- Uninsulated available upon request (Non Stock Items)



Item #	Description
FL0180	070 FLEX VINYL INSUL.4" (25FT/CARTON)
FL0190	070 FLEX VINYL INSUL. 6" (25FT/CARTON)
FL0195	070 FLEX VINYL INSUL.7" (25FT/CARTON)
FL0200	070 FLEX VINYL INSUL. 8" (25FT/CARTON)
FL0210	070 FLEX VINYL INSUL. 10"(25FT/CARTON)
FL0215	070 FLEX VINYL INSUL.12" (25FT/CARTON)
FL0220	070 FLEX VINYL INSUL.14"(25FT/CARTON)
FL0225	070 FLEX VINYL INSUL.16" (25FT/CARTON)
FL0230	070 FLEX VINYL INSUL.18" (25FT/CARTON)
FL0235	070 FLEX VINYL INSUL.20" (25FT/CARTON)
FL0950	030 SILVER FOIL FLEX 4" (25FT/CARTON)
FL0955	030 SILVER FOIL FLEX 5" (25FT/CARTON)
FL0960	030 SILVER FOIL FLEX 6" (25FT/CARTON)
FL0965	030 SILVER FOIL FLEX 7" (25FT/CARTON)
FL0970	030 SILVER FOIL FLEX 8"(25FT/CARTON)
FL0980	030 SILVER FOIL FLEX 10"(25FT/CARTON)
FL0985	030 SILVER FOIL FLEX 12"(25FT/CARTON)
FL0990	030 SILVER FOIL FLEX 14"(25FT/CARTON)
FL0995	030 SILVER FOIL FLEX 16"(25FT/CARTON)
FL1000	030 SILVER FOIL FLEX 18"(25FT/CARTON)
FL1005	030 SILVER FOIL FLEX 20"(25FT/CARTON)

Nylon Flex Straps

- Nylon Straps used for duct strapping
- Smooth insertion and a locking mechanism that gives ductwork a firm hold
- Manufactured from filtered nylon reducing particulate contamination
- 175 LBS tensile strength



Item #	Description	Box QTY
RC0016	36" NYLON STRAP (10" MEDIUM) (50 / PACK)	500/BOX
RC0016-50	36" NYLON STRAP (10" MEDIUM)	50/BOX
RC0016-B	36" BLACK NYLON STRAP (10" MEDIUM)	500/BOX
RC0016-B-50	36" BLACK NYLON STRAP (10" MEDIUM)	50/BOX
RC0017	48" NYLON STRAP (14" LARGE)	500/BOX
RC0017-50	48" NYLON STRAP (14" LARGE)	50/BOX
RC0017-B	48" BLACK NYLON STRAP (14" LARGE)	500/BOX
RC0017-B-50	48" BLACK NYLON STRAP (14" LARGE)	50/BOX

ST/ST Flex Ties

- Mold Resistant: Made with Microban antimicrobial product protection
- Indoor Air Quality-friendly: Fiber free, formaldehyde free, low VOCs, nonparticulating
- Quiet: Noise blocking and vibration damage
- Durable: No fragile vapor retarder



Item #	Description	Box QTY
FC0010	ST/ST 6" STRAP (22" LONG)	200/BOX
FC0020	ST/ST 8" STRAP (28.5" LONG)	200/BOX
FC0025	ST/ST 10" STRAP (35" LONG)	200/BOX
FC0030	ST/ST 12" STRAP (39" LONG)	200/BOX
FC0040	ST/ST 16" STRAP (55" LONG)	200/BOX
FC0050	ST/ST 20" STRAP (72" LONG)	100/BOX

FASTENERS & HARDWARE COMPONENTS

Self Drill Tek Screw

• Elgen's Self Drilling Screw is designed for fastening to aluminum and steel with a drill point tip

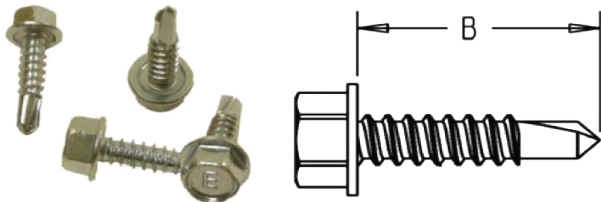

Size	Across Flats (in)	Socket Size (in)	Washer Diameter
#8	1/4	7/16	0.322-0.348
#10	5/16	1/2	0.384-0.414
#12	5/16	1/2	0.398-0.432
#14	3/8	9/16	0.480-0.520

Item #	Description	Box QTY
TK0415-M	8X1/2" TEK ELGEN	1,000/BOX
TK0420-M	8X3/4" TEK ELGEN	1,000/BOX
TK0425-M	8X1" TEK ELGEN	1,000/BOX
TK0430-M	8X1-1/4" TEK ELGEN	1,000/BOX
TK0435-M	8X1-1/2" TEK ELGEN	1,000/BOX
TK0470-M	10X1/2" TEK ELGEN	1,000/BOX
TK04701-M	10X1/2" TEK ELGEN STST	1,000/BOX
TK0475HH	10X3/4 *HIGH HAT* ELGEN TEK *BULK*	5,000/BOX
TK0475HH-M	10X3/4" HIGH HAT ELGEN	1,000/BOX
TK06555-M	10X3/4 HI-HAT TEK W/STEEL BONDED WASHER	1,000/BOX
TK1630	10X3/4 TEK ELGEN** *BULK*	8,000/BOX
TK1630-M	10X3/4 TEK ELGEN	1,000/BOX
TK0265-S-M	10X3/4 TEK #410 ST/ST	1,000/BOX
TK0265-M	10X3/4 HI-HAT TEK #410 ST/ST *	1,000/BOX
TK1200-M	10X3/4 TEK HI-HAT *ALUM*	1,000/BOX
TK0490-M	10X1" HI HAT ELGEN TEK	1,000/BOX
TK0270-M	10X1 TEK #410 ST/ST	1,000/BOX
TK0500-M	10X1-1/2" HI HAT TEK ELGEN	1,000/BOX
TK0280-M	10X1-1/2 TEK #410 ST/ST	1,000/BOX
TK0505-M	10X2" TEK HI HAT ELGEN	1,000/BOX
TK1020-M	10X2 ELGEN TEK	1,000/BOX
TK0285-M	10X2 TEK #410 ST/ST	1,000/BOX
TK0520-M	10X3" TEK ELGEN	1,000/BOX
TK0540-M	12X3/4" TEK ELGEN	1,000/BOX
TK0545-M	12X1" TEK ELGEN	1,000/BOX
TK1250-M	12X1 BONDED SEALING TEKS	1,000/BOX
TK0320-M	12X1 TEK #410 ST/ST	1,000/BOX
TK0550-M	12X1-1/4" TEK ELGEN	1,000/BOX
TK0644-M	12X1-1/4" TEK ELG.#5PT	1,000/BOX
TK0555-M	12X1-1/2 TEK ELGEN	1,000/BOX
TK0565-M	12X2 TEK W/NEOPRENE WASHER	1,000/BOX
TK0560-M	12X2" TEK ELGEN	1,000/BOX
TK0575-M	12X3" TEK ELGEN	1,000/BOX
TK0585-M	12X4" TEK ELGEN	1,000/BOX
TK0590-M	14X3/4" TEK ELGEN	1,000/BOX
TK0365-M	14X3/4" TEK #410	1,000/BOX
TK0600-M	14X1" TEK ELGEN	1,000/BOX
TK0370-M	14X1 TEK #410 ST/ST	1,000/BOX
TK0605-M	14X1-1/4" TEK ELGEN	1,000/BOX
TK0610-M	14X1-1/2" TEK ELGEN	1,000/BOX
TK0615-M	14X2" TEK ELGEN	1,000/BOX
TK0630-M	14X3" TEK ELGEN	1,000/BOX
TK0640-M	14X4" TEK ELGEN	1,000/BOX

Sharp Point Drill Screws

• Elgen's Self Drilling Screw is designed for fastening to aluminum and steel

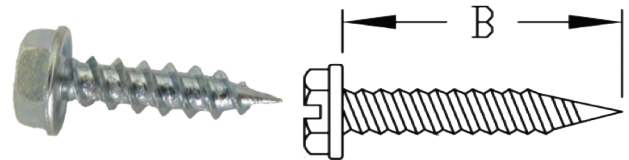

Size	Across Flats (in)	Socket Size (in)	Washer Diameter (in)
#8	1/4	7/16	0.322-0.348
#10	5/16	1/2	0.384-0.414
#12	5/16	1/2	0.398-0.432
#14	3/8	9/16	0.480-0.520

Item #	Description	Box QTY
DS0005-M	8X1/2 DRILL SCREW	1,000/BOX
DS0007-M	8X5/8 DRILL SCREW	1,000/BOX
DS0010-M	8X3/4 DRILL SCREW	1,000/BOX
DS0015-M	8X1 DRILL SCREW	1,000/BOX
DS0025-M	8X1-1/2 DRILL SCREW	1,000/BOX
DS0030-M	8X2 DRILL SCREW	1,000/BOX
DS0030-C	8X2 DRILL SCREW	1,000/BOX
DS0040-M	10X1/2 DRILL SCREW	1,000/BOX
DS0045-M	10X3/4 DRILL SCREW W/5/16 HEAD	1,000/BOX
DS0046-M	10X3/4 DRILL SCREW #410 STST	1,000/BOX
DS0052-M	10X3/4 DRILL SCREW W/1/4" HEAD	1,000/BOX
DS0050-M	10X1 DRILL SCREW W-5/16 HEAD	1,000/BOX
DS0060-M	10X1-1/2 DRILL SCREW	1,000/BOX
DS0065-M	10X2 DRILL SCREW	1,000/BOX
DS0077-M	10X3 DRILL SCREW	1,000/BOX

Magnetic Chucks

• Elgen's magnetic chucks are designed to drive hex-head fasteners



Item #	Description	Box QTY
CH0012	1/4X6 MAGNETIC CHUCK	6/BOX
CH0015	210 MAGNETIC CHUCK 5/16"X1-3/4	12/BOX
CH0020	210L MAG. CHUCK 5/16"X2-9/16"	12/BOX
CH0023	5/16X6 MAGNETIC CHUCK	6/BOX
CH0025	212 MAGNETIC CHUCK 3/8"X1-3/4"	12/BOX
CH0030	212L MAG. CHUCK 3/8"X2-9/16"	12/BOX
CH0032	3/8X6 MAGNETIC CHUCK	6/BOX
CH0035	214 MAGNETIC CHUCK 7/16"X1-3/4	12/BOX
CH0040	214L MAG. CHUCK 7/16"X2-9/16"	12/BOX
CH0050	216L MAG. CHUCK *1/2"X2-9/16"	12/BOX
CH0005	208 MAGNETIC CHUCK 1/4"X1-3/4"	12/BOX
CH0010	208L MAG. CHUCK 1/4"X2-9/16"	12/BOX

FASTENERS & HARDWARE COMPONENTS

Rivets



Steel Rivets						
Item	Diameter (nominal) (in)	Grip Range (in)	Drill# & Hole Size(in)	Rivet Length (in)	Typical Ultimate Strength (lbs)	
					Shear	Tensile
SS-42	1/8 (.125)	.063-.125	# 30 (.129-.133)	.275	305	410
SS-44		.188-.250		.400		
SS-46		.313-.375		.525		
SS-48		.376-.500		.650		
SS-52	5/32" (.156)	.020-.125	# 20 (.160-.164)	.300	420	600
SS-54		.188-.250		.425		
SS-56		.251-.375		.550		
SS-58		.376-.500		.675		
SS-62	3/16" (.187)	.020-.125	# 11 (.192-.196)	.325	610	870
SS-64		.126-.250		.450		
SS-66		.251-.375		.575		
SS-68		.376-.500		.700		
Stainless Steel Rivets (Grade 51)						
ST-42	1/8 (.125)	.063-.125	# 30 (.129-.133)	.275	520	600
ST-44		.188-.250		.400		
ST-46		.313-.375		.525		
ST-48		.376-.500		.650		
ST-52	5/32" (.156)	.020-.125	# 20 (.160-.164)	.300	785	1040
ST-54		.188-.250		.425		
ST-56		.251-.375		.550		
ST-62		.020-.125		.325		
ST-64	3/16" (.187)	.126-.250	# 11 (.192-.196)	.450	1150	1300
ST-66		.251-.375		.575		
ST-68		.376-.500		.700		
AL-42		1/8 (.125)		.063-.125		
AL-44	.188-.250		.400			
AL-46	.313-.375		.525			
AL-48	.376-.500		.650			
AL-52	5/32" (.156)	.020-.125	# 20 (.160-.164)	.300	230	340
AL-54		.188-.250		.425		
AL-56		.251-.375		.550		
AL-62		.020-.125		.325		
AL-64	3/16" (.187)	.126-.250	# 11 (.192-.196)	.450	330	515
AL-66		.251-.375		.575		
AL-68		.376-.500		.700		

Item #	Description	Box QTY
RV0195-M	SS56 STEEL RIVET	1,000/BOX
RV0200-M	SS58 STEEL RIVET	1,000/BOX
RV0210-M	SS62 STEEL RIVET	1,000/BOX
RV0215-M	SS64 STEEL RIVET	1,000/BOX
RV0010-M	AA42 ALUM.RIVET	1,000/BOX
RV0016-M	AA44LF ALUM.RIVET	1,000/BOX
RV0020-M	AA44 ALUM.RIVET	1,000/BOX
RV0025-M	AA46 ALUM.RIVET	1,000/BOX
RV0030-M	AA48 ALUM.RIVET	1,000/BOX
RV0040-M	AA52 ALUM.RIVET	1,000/BOX
RV0045-M	AA54 ALUM. RIVET	1,000/BOX
RV0160-M	SS42 STEEL RIVET	1,000/BOX
RV0165-M	SS44 STEEL RIVE	1,000/BOX
RV0170-M	SS46 STEEL RIVET	1,000/BOX
RV0175-M	SS48 STEEL RIVET	1,000/BOX
RV0185-M	SS52 STEEL RIVET	1,000/BOX
RV0190-M	SS54 STEEL RIVET	1,000/BOX
RV0220-M	SS66 STEEL RIVE	1,000/BOX
RV0225-M	SS68 STEEL RIVET	1,000/BOX
RV0050-M	AA56 ALUM RIVET	1,000/BOX
RV0065-M	AA62 ALUM.RIVET	1,000/BOX
RV0070-M	AA64 ALUM.RIVET	1,000/BOX
RV0075-M	AA66 ALUM. RIVET	1,000/BOX
RV0080-M	AA68 ALUM.RIVET	1,000/BOX
RV0085-M	STST42 RIVET	1,000/BOX
RV0090-M	STST44 RIVET	1,000/BOX
RV0095-M	STST46 RIVET	1,000/BOX
RV0100-M	STST48 RIVET	1,000/BOX
RV0115-M	STST54 RIVET	1,000/BOX
RV0120-M	STST56 RIVE	1,000/BOX
RV0135-M	STST62 RIVET	1,000/BOX
RV0140-M	STST64 RIVET	1,000/BOX
RV0145-M	STST66 RIVET	1,000/BOX

FASTENERS & HARDWARE COMPONENTS

Hex Nuts



Item #	Description	Box QTY
HN0010	1/4 HEX NUT *BULK*	6,000/BOX
HN0010-C	1/4" HEX NUT	100/BOX
HN0010-M	1/4" HEX NUT	1,000/box
HN0045-C	1/4 HEX NUT ST/ST#304	100/box
HN0155	3/8 HEX NUT HEAVY**	1,500/BOX
HN0015	3/8 HEX NUT *BULK*	3,000/BOX
HN0015-C	3/8" HEX NUT	100/BOX
HN0015-MP	3/8" HEX NUT* IN PLASTIC CONTAINER	1,000/BOX
HN0050-C	3/8 HEX NUT ST/ST #304	100/BOX
HN0051-C	3/8 HEX NUT ST/ST #316	100/BOX
HN0061-C	3/8 HEX NUT ST/ST*HEAVY	100/BOX
HN0085-C	3/8 HEX NUT ALUM**	100/BOX
HN0155-C	3/8 HEX NUT HEAVY**	100/BOX
HN0120-C	3/8 HEX NUT **NYLON**	100/BOX
HN0025	1/2 HEX NUT *BULK*	1,000/BOX
HN0025-C	1/2 HEX NUT **	100/BOX
HN0165-C	1/2 HEX NUT HEAVY **	100/BOX
HN0060-C	1/2 HEX NUT ST/ST#304 *	100/BOX
HN0020-C	5/8 HEX NUT ** HEAVY	100/BOX
HN0055-C	5/8 HEX NUT ST/ST	100/BOX
HN0035-C	3/4 HEX NUT ** HEAVY	100/BOX
HN0036-C	7/8 HEX NUT ** HEAVY	100/BOX
HN0005-C	5/16 HEX NUT	100/BOX
HN0066-C	5/16 HEX NUT ST/ST	100/BOX
HN0030-C	3/16 HEX NUT **	100/BOX

Carriage Bolt



Item #	Description	Box QTY
CB0010	3/8X1 CARRIAGE BOLT *BULK*	1,000/BOX
CB0015	3/8X1-1/4 CARRIAGE BOLT *BULK*	875/BOX
CB0045-C	3/8X1 CARRIAGE BOLT ALUM	100/BOX
CB0080-C	3/8X1 CARRIAGE BOLT ST/ST#304	100/BOX
CB0082-C	3/8X1 CARRIAGE BOLT*ST/ST#316*	100/BOX
CB0025-C	3/8x2 CARRIAGE BOLT *	100/BOX
CB0085-C	3/8X1-1/4 CARRIAGE BOLT ST/S	100/BOX
CB0115-C	5/16X1 CARRIAGE BOLT	100/BOX
CB0120-C	5/16X1-1/4 CARRIAGE BOLT	100/BOX
CB0321-C	1/4X1-1/4 CARRIAGE BOLT	100/BOX
CB0322-C	1/4X1-1/2 CARRIAGE BOLT	100/BOX
CB0323-C	1/4x2 CARRIAGE BOLT	100/BOX
CB0010-C	3/8x1 CARRIAGE BOLT **10	100/BOX
CB0015-C	3/8X1-1/4 CARRIAGE BOLT	100/BOX
CB0319A-C	1/4X3/4 CARRIAGE BOLT	100/BOX
CB0320-C	1/4X1 CARRIAGE BOLT	100/BOX

Hex Head Tap Bolts



Item #	Description	Box QTY
TB0003-C	1/4 X 1/2" TAP BOLT	100/BOX
TB0005-C	1/4 X 3/4" TAP BOLT	100/BOX
TB0010-C	1/4 X 1" TAP BOLT	100/BOX
TB0015-C	1/4 X 1-1/4" TAP BOLT	100/BOX
TB0020-C	1/4 X 1-1/2" TAP BOLT	100/BOX
TB0025-C	1/4 X 2" TAP BOLT	100/BOX
TB0035-C	1/4X 2-1/2" TAP BOLT	100/BOX
TB0035-S-C	1/4X2-1/2 TAP BOLT ST/ST	100/BOX
TB0040-C	1/4 X 3" TAP BOLT	100/BOX
TB0050-C	1/4X 4" TAP BOLT	100/BOX
TB0055-C	1/4 X 4-1/2" TAP BOLT	100/BOX
TB0062-C	1/4 X 6" TAP BOLT	100/BOX
TB0065-C	3/8 X 3/4" TAP BOLT	100/BOX
TB0070-C	3/8 X 1" TAP BOLT	100/BOX
TB0075-C	3/8X1-1/4" TAP BOLT	100/BOX
TB0080-C	3/8X1-1/2" TAP BOLT	100/BOX
TB0085-C	3/8 X 2" TAP BOLT	100/BOX
TB0095-C	3/8 X 2-1/2" TAP BOLT	100/BOX
TB0100-C	3/8 X 3" TAP BOLT	100/BOX
TB0110-C	3/8 X 4" TAP BOLT	100/BOX
TB0120-C	3/8 X 5" TAP BOLT	100/BOX
TB0123-C	3/8 X 6" TAP BOLT	100/BOX
TB0240-C	5/16 X 3/4" TAP BOLT	100/BOX
TB0245-C	5/16 X 1" TAP BOLT	100/BOX
TB0250-C	5/16 X1-1/4" TAP BOLT	100/BOX
TB0255-C	5/16 X1-1/2" TAP BOLT	100/BOX
TB0260-C	5/16 X 2" TAP BOLT	100/BOX
TB0275-C	5/16 X 3" TAP BOLT	100/BOX
TB0305-C	1/2 X 1" TAP BOLT	100/BOX
TB0310-C	1/2 X1-1/4" TAP BOLT	100/BOX
TB0315-C	1/2 X1-1/2" TAP BOLT	100/BOX
TB0320-C	1/2 X 2" TAP BOLT	100/BOX
TB0330-C	1/2 X2-1/2" TAP BOLT	100/BOX
TB0335-C	1/2 X 3" TAP BOLT	100/BOX
TB0425-C	1/4X3/4 TAP BOLT ST/ST	100/BOX
TB0430-C	1/4X1 TAP BOLT ST/ST **	100/BOX
TB0440-C	1/4X1-1/2 TAP BOLT ST/ST	100/BOX
TB0445-C	1/4X2 TAP BOLT ST/ST	100/BOX
TB0450-C	1/4X1-1/4 TAP BOLT ST/ST	100/BOX
TB0490-C	3/8X1 TAP BOLT ST/ST	100/BOX
TB0500-C	3/8X1-1/2 TAP BOLT ST/ST	100/BOX
TB0502	3/8X1-1/2 TAB BOLT ST/ST#316	100/BOX
TB05055-C	3/8X2 TAP BOLT ST/ST#316	100/BOX
TB0505-C	3/8X2 TAP BOLT ST/ST *100*	100/BOX
TB0565-C	5/8X2 TAP BOLT ST/ST	100/BOX
TB0675-C	5/16X1 TAP BOLT ST/ST	100/BOX
TB0685-C	5/16X1-1/2 TAP BOLT ST/ST	100/BOX
TB0735-C	1/2X1 TAP BOLT ST/ST	100/BOX
TB1340-C	3/8X1 TAP BOLT **NYLON**	100/BOX
TB1400-C	5/16X1 TAP BOLT NYLON	100/BOX

FASTENERS & HARDWARE COMPONENTS

Flat Washers



Item #	Description	Box QTY
WA0005	1/4" FLAT WASHER **BULK** (1 LB = 149 PCS)	50LBS
WA0005-C	1/4" FLAT WASHER (Approx 0.64lbs)	100/BOX
WA0035-C	1/4" FLAT WASHER ST/ST#304	100/BOX
WA0010	3/8" FLAT WASHER **BULK** (1 LB = 67 PCS)	50/LBS
WA0010-C	3/8" FLAT WASHER	100/BOX
WA0040-C	3/8" FLAT WASHER ST/ST#304	100/BOX
WA0010-5LB	3/8" FLAT WASHER *5 LBS*	5/LBS
WA0042-C	3/8" FLAT WASHER ST/ST#316	100/BOX
WA0025	1/2" FLAT WASHER **BULK** (1 LB = 26 PCS)	50/LBS
WA0025-C	1/2" FLAT WASHER **	100/BOX
WA0060-C	1/2" FLAT WASHER ST/ST#304	100/BOX
WA0062-C	1/2" FLAT WASHER ST/ST#316	100/BOX
WA0015-C	5/8" FLAT WASHER	100/BOX
WA0019-C	3/16" FLAT WASHER	100/BOX
WA0020-C	5/16" FLAT WASHER	100/BOX
WA0055-C	5/16" FLAT WASHER ST/ST	100/BOX
WA0030-C	3/4" FLAT WASHER	100/BOX
WA0031-C	7/8" FLAT WASHER	100/BOX
WA0033-C	1" FLAT WASHER	100/BOX

Fender Washers



Item #	Description	Box QTY
WA01051	1/4 X 1-1/4 FENDER WASHER **BULK**	50/LBS
WA01051-C	1/4 X 1-1/4 FENDER WASHER	100/BOX
WA0140-C	1/4X1-1/4" FENDER WASHER ST/ST	100/BOX
WA0105-C	1/4" FENDER WASHER X1-1/2"OD	100/BOX
WA0111	3/8 X 1-1/4 FENDER WASHER **BULK** (50LBS/BOX)	50/LBS
WA0113	3/8 X 1-1/2 FENDER WASHER	50/LBS
WA0111-C	3/8x 1-1/4 FENDER WASHER	100/BOX
WA0113-C	3/8x1-1/2 FENDER WASHER	100/BOX
WA0112-C	3/8 X 2 FENDER WASHER	100/BOX
WA01451-C	3/8X1-1/4" FENDER WASHER ST/ST	100/BOX
WA0146-C	3/8" X1-1/2 FENDER WASHER #316 ST/ST	100/BOX
WA01450-C	3/8X1-1/2" FENDER WASHER ST/ST	100/BOX
WA0145-C	3/8X2" FENDER WASHER ST/ST#304	100/BOX
WA013011-C	1/2x1-1/2 FENDER WASHER	100/BOX
WA01301-C	1/2x2 FENDER WASHER	100/BOX
WA0615-C	1/2X1-1/2" FENDER WASHER ST/ST	100/BOX

Lock Washers



Item #	Description	Box QTY
WA0210-C	1/4" LOCKWASHER	100/BOX
WA0215-C	3/8" LOCKWASHER	100/BOX
WA0220-C	5/8" LOCKWASHER	100/BOX
WA0230-C	5/16 LOCKWASHER	100/BOX
WA0235-C	1/2" LOCKWASHER	100/BOX
WA0240-C	3/4" LOCKWASHER	100/BOX
WA0243-C	7/8" LOCKWASHER	100/BOX
WA0245-C	1/4" LOCKWASHER ST/ST#304	100/BOX
WA0252	3/8" LOCKWASHER ST/ST#316	100/BOX
WA0250-C	3/8" LOCKWASHER ST/ST#304	100/BOX

DAMPER HARDWARE & BLADES



Standard Damper Blade

- Elgen's Damper Blades are designed for controlling airflow inside smoke fittings and round ductwork
- Corrosion resistant
- Pre-assembled with E-702 and E-708 for easy use
- Optional Construction Available
- MADE IN USA

Item #	Description	Box QTY
DBR4	4" DAMPER DOUBLE SIDED 1 SPRING END & 1 THREADED STUD	MTO
DBR5	5" DAMPER DOUBLE SIDED 1 SPRING END & 1 THREADED STUD	MTO
DBR6	6" DAMPER DOUBLE SIDED 1 SPRING END & 1 THREADED STUD	MTO
DBR7	7" DAMPER DOUBLE SIDED 1 SPRING END & 1 THREADED STUD	MTO
DBR8	8" DAMPER DOUBLE SIDED 1 SPRING END & 1 THREADED STUD	MTO
DBR9	9" DAMPER DOUBLE SIDED 1 SPRING END & 1 THREADED STUD	MTO
DBR10	10" DAMPER DOUBLE SIDED 1 SPRING END & 1 THREADED STUD	MTO
DBR12	12" DAMPER DOUBLE SIDED 1 SPRING END & 1 THREADED STUD	MTO
DBR14	14" DAMPER DOUBLE SIDED 1 SPRING END & 1 THREADED STUD	MTO
DBR16	16" DAMPER DOUBLE SIDED 1 SPRING END & 1 THREADED STUD	MTO
DBR18	18" DAMPER DOUBLE SIDED 1 SPRING END & 1 THREADED STUD	MTO
DBR20	20" DAMPER DOUBLE SIDED 1 SPRING END & 1 THREADED STUD	MTO



Super Snap-In Bushings

- Elgen's Super snap-in bushing is used in conjunction with Elgen's stand-off equipped fittings for low and high pressure applications
- Patent pending design
- Temperature Rating: -38DEG F to +247DEG F
- Tested to +40" W.G. and -10" W.G.
- 50 year lifespan

Item #	Description	Box QTY
GD10694-N	DP-9N 3/8 SQR * NEW RUBBER TYPE* **BULK* -US PATENT 10,488,074	5000/BOX
GD10694-N-C	DP-9N 3/8 SQR BUSHING ** NEW RUBBER TYPE -US PATENT 10,488,074	100/BOX
GD10693-N-C	DP-8N 1/4 SQR ** NEW RUBBER TYPE *	100/BOX
GD10692-N-C	DP-7N 3/8 RND ** NEW RUBBER TYPE	100/BOX
GD10692-N	DP-7N 3/8 RND ** NEW RUBBER TYPE **BULK**	500/BOX
GD10691-N-C	DP-6N 1/4 RND ** NEW RUBBER TYPE**	100/BOX

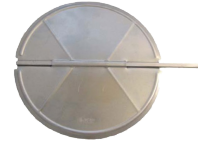

Heavy Duty Damper Blade

- Elgen's Damper Blades are designed for controlling airflow inside smoke fittings and round ductwork
- Accommodates 3/8" Square Rod
- Optional Construction Available
- MADE IN USA

Item #	Description	Box QTY
DHD4-R	4" DAMPER BLADE WITH 3/8"X8" SQUARE ROD ASSEMBLED IN PLACE	200/BOX
DHD5-R	5" DAMPER BLADE WITH 3/8"X 9" SQUARE ROD ASSEMBLED IN PLACE	120/BOX
DHD6-R	6" DAMPER BLADE WITH 3/8" SQR ASSEMBLED IN PLACE	90/BOX
DHD7-R	7" DAMPER BLADE WITH 3/8"X11" SQUARE ROD ASSEMBLED IN PLACE	110/BOX
DHD8-R	8" DAMPER BLADE WITH 3/8" SQR ASSEMBLED IN PLACE	80/BOX
DHD10-R	10" DAMPER BLADE WITH 3/8" SQR ASSEMBLED IN PLACE	33/BOX
DHD12-R	12" DAMPER BLADE WITH 3/8" SQR ASSEMBLED IN PLACE	36/BOX
DHD14-R	14" DAMPER BLADE WITH 3/8" SQR ASSEMBLED IN PLACE	34/BOX
DHD16-R	16" DAMPER BLADE WITH 3/8" SQR ASSEMBLED IN PLACE	28/BOX
DHD18-R	18" DAMPER BLADE WITH 3/8" SQR ASSEMBLED IN PLACE	MTO
DHD20-R	20" DAMPER BLADE WITH 3/8" SQR ASSEMBLED IN PLACE	MTO



Bronze Bushing

- Elgen's Bushings are used to provide support and lubrication for adapter and bearing pins in air-control dampers
- Corrosion resistant
- Self-Lubricating

Item #	Description	Box QTY
GD1066-C	DP-4 BRONZE BUSHING * 1/2" I.D 11/16" O.D.	100/BOX

DAMPER HARDWARE & BLADES



1-Piece Easy Handle

- Elgen's Patent-Pending 1-piece Easy Handle is used with conjunction with Damper Blades for controlling the airflow inside fittings and round ductwork
- Huge labor savings - cuts installation time by more than 50%
- Includes attached rubber washer to reduce air leakage

Item #	Description	Box QTY
GH1019	E-700 SERIES ALL-IN-ONE HANDLE	300



Damper Rod

- Elgen's Round Damper Rod is used to control the blades on air-control dampers
- Corrosion resistant

Item #	Description	Box QTY
TR0280	1/4X10 PLAIN ROD Z/P (DR-2)	300FT
TR0490A	3/8" SQUARE ROD *ALUMINUM* .370"-.373"	675PCS



Damper Shaft Extension

- Used to extend the handle when attached to the E-708
- Single Piece - all metal construction
- Allows for damper adjustment in insulated low pressure ductwork

Item #	Description	Box QTY
DH5050	1-PIECE DAMPER SHAFT EXTENSION	100/BOX

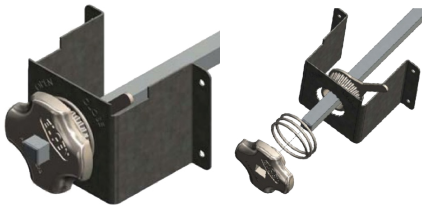

Elgen Super Standoff

- Elgen's patented Super Standoffs are used on rectangular and round duct work
- One Hand Operation - No wing-nut to loosen
- All Metal Construction
- Push and turn locking mechanism holds the rod firm to eliminate rattle noises
- Indicator shows the position of the damper blade

Item #	Description	Box QTY
GF2005	ELGEN SUPER STANDOFF 3/8"x2" HI PUSH BUTTON DESIGN ORANGE- US PATENT 9,835,354	240/BOX

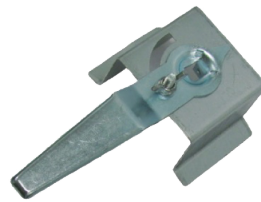

Economy Elevated Damper Regulator

- Elgen's Elevated Damper Regulators are used on rectangular and round duct work
- Using an elevated base allows for insulation to be flush with the handle
- All Metal Construction
- Raised handle for ease of pivoting
- Locking mechanism allows for any angle of damper blade

Item #	Description	Box QTY
GF1022E	EE-122 1/4" SHAFT 1-1/2"	100/BOX
GF1023E	EE-123 1/4" SHAFT 2" STANDOFF	100/BOX
GF1124E	EE-124 3/8" SHAFT 1" STANDOFF	100/BOX
GF1125E	EE-125 3/8" SHAFT 1-1/2"	100/BOX
GF1126ER	EE-126-R **BENT 45DEG**	120/BOX
GF1126ER-AL	EE-126-R **BENT 45DEG** BASE WITH HANDLE - ALUMINUM	100/BOX
GF1126E-A-10	EE-126R *ALUMINUM*	10/BOX
GF1126ER-SS	EE-126-R **BENT 45DEG** BASE WITH HANDLE -316 ST/ST	100/BOX
GF1126ER-SS-10	EE-126R **ST/ST#316**	10/BOX
GF1129E	EE-129 1/2" SHAFT 2" STANDOFF	100/BOX



Heavy Duty Elevated Damper Regulator

- Elgen's Elevated Damper Regulators are used on rectangular and round duct work
- Using an elevated base allows for insulation to be flush with the handle
- All Metal Construction
- Raised handle for ease of pivoting
- 14GA Handle for added durability

Item #	Description	Box QTY
GF1021	E-121 1/4" SHAFT 1" STANDOFF	100/BOX
GF1022	E-122 1/4" SHAFT 1-1/2" STANDOFF	100/BOX
GF1023	E-123 1/4" SHAFT 2" STANDOFF	100/BOX
GF1124	E-124 3/8" SHAFT 1" STANDOFF	100/BOX
GF1126	E-126 3/8" SHAFT 2" STANDOFF	100/BOX

DAMPER HARDWARE & BLADES

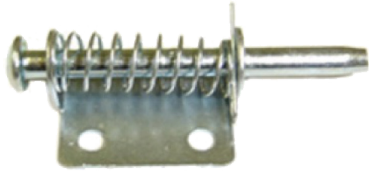

Spring End Bearings

- Elgen's Spring End Bearing is used in conjunction with damper blade or controlling the damper inside the ductwork
- Corrosion Resistant

Item #	Description	Box QTY
GE1031	RP-6 SPRING END BEARING	100/BOX
GE1007	RP-6XL SPRING END BEARING	100/BOX
GE1007ST	RP-6XL **ST/ST SPECIAL	100/BOX
GE1032-C	RP-7 SPRING END BEARING	100/BOX
GE1008	RP-7XL LONG SPRING BEARING	100/BOX
GE1008ST	RP-7XL **ST/ST SPECIAL	100/BOX



End Bearings (1/4")

- Elgen's End Bearings are used in conjunction with damper blade for controlling the damper inside the ductwork

Item #	Description	Box QTY
GE1034	RP-8X SQ END BEARING(X3" LONG)	100/BOX
GE1039	RP-8XL LONG BEARING (X3-3/4")	100/BOX
GE10395	RP-8XXL** EXTRA LONG (X5-5/8")	100/BOX
GE1039ST	RP-8XL **ST/ST SPECIAL	100/BOX



End Bearings (3/8")

- Elgen's End Bearings are used in conjunction with damper blade for controlling the damper inside the ductwork

Item #	Description	Box QTY
GE1035	RP-9 SQ END BEARING (X3" LONG)	100/BOX
GE1190	RP-9XL END BEARING (X5" LONG)	100/BOX
GE11905	RP-9XXL** EXTRA LONG (X5-5/8")	100/BOX
GE1190ST	RP-9XL **ST/ST SPECIAL	100/BOX
GE1190ST-C	RP-9XL **ST/ST SPECIAL	100/BOX



End Bearing (Heavy Duty)

- Elgen's End Bearings are used in conjunction with damper blade for controlling the damper inside the ductwork

Item #	Description	Box QTY
GE1036-C	RP-10 RD END BEARING	100/BOX
GE1037-C	RP-11 SQ END BEARING	100/BOX

DAMPER HARDWARE & BLADES



Engineered Open End Bearing

- Elgen's Engineered End Bearings are designed for low leakage applications
- Corrosion resistant
- Temperature Range: 728DEG F

Item #	Description	Box QTY
GF1000	E-100 1/4" (WASHER,BASE & BEARING)	100/BOX
GF1001	E-101 3/8" OPEN END BEARING SET(WASHER,BASE & BEARING)	100/BOX
GF1001ST	E-101 **ST/ST** SPECIAL	100/BOX
GF1002	E-102 1/2" (WASHER,BASE & BEARING)	100/BOX



Engineered Closed End Bearing

- Elgen's Engineered End Bearings are designed for low leakage applications
- Corrosion resistant
- Temperature Range: 728DEG F

Item #	Description	Box QTY
GF1003	E-103 1/4" (WASHER,BASE & BEARING)	100/BOX
GF1004	E-104 3/8"(WASHER,BASE & BEARING)	100/BOX
GF1004ST	E-104 **ST/ST** SPECIAL	100/BOX
GF1005	E-105 1/2" (WASHER,BASE & BEARING)	100/BOX



Engineered End Bearing Indicator Type Regulator-Acorn

- Elgen's Engineered End Bearings are designed for low leakage applications
- Corrosion resistant
- Temperature Range: 728DEG F

Item #	Description	Box QTY
GF1006	E-106 1/4" INDICATOR REGULATOR WITH ACORN NUT	100/BOX
GF1007	E-107 3/8" INDICATOR REGULATOR WITH ACORN NUT	100/BOX
GF1008	E-108 1/2" INDICATOR REGULATOR WITH ACORN NUT	100/BOX



Engineered End Bearing Indicator Type Regulator - Hex Nut

- Elgen's Engineered End Bearings are designed for low leakage applications
- Corrosion resistant
- Temperature Range: 728DEG F

Item #	Description	Box QTY
GF1009	E-109 1/4" INDICATOR REGULATOR WITH HEX NUT	100/BOX
GF1010	E-110 3/8" INDICATOR REGULATOR WITH HEX NUT	100/BOX
GF1011	E-111 1/2" INDICATOR REGULATOR WITH HEX NUT	100/BOX



Engineered End Bearing Handle Type Regulator - Acorn

- Elgen's Engineered End Bearings are designed for low leakage applications
- Corrosion resistant
- Temperature Range: 728DEG F

Item #	Description	Box QTY
GF1012	E-112 1/4" HANDLE REGULATOR WITH ACORN NUT	100/BOX
GF1013	E-113 3/8" HANDLE REGULATOR WITH ACORN NUT	100/BOX
GF1014	E-114 1/2" HANDLE REGULATOR WITH ACORN NUT	100/BOX



Engineered End Bearing Handle Type Regulator - Hex Nut

- Elgen's Engineered End Bearings are designed for low leakage applications
- Corrosion resistant
- Temperature Range: 728DEG F

Item #	Description	Box QTY
GF1015	E-115 1/4" HANDLE REGULATOR WITH HEX NUT (100/BOX)	100/BOX
GF1016	E-116 3/8" HANDLE REGULATOR WITH HEX NUT (100/BOX)	100/BOX
GF1017	E-117 1/2" HANDLE REGULATOR WITH HEX NUT (100/BOX)	100/BOX

DAMPER HARDWARE & BLADES

Bearing Straps

• Elgen's Bearing Straps is used to secure the adapter and bearing pins on air-control dampers



Item #	Description	Box QTY
GD1071-C	DA BEARING STRAP	100/BOX
GD1072-C	DA-AL ALUM BEARING STRAP	100/BOX
GD1074-C	DA-SS STST BEARING STRAP	100/BOX

Bearing Straps w/Set Screw



Item #	Description	Box QTY
GD1075	DA-1 STRAP W/SET SCREW	100/BOX
GD1076-C	DA-1AL STRAP ALUM W/SET SCREW	100/BOX
GD1077-C	DA-1SS STST STRAP W/SET SCREW	100/BOX

Set Screw

• Elgen's DAS set screw is used for securing the rod inside the pivot on air-control dampers



Item #	Description	Box QTY
GD1058-C	DAS 1/4X2/1/2 SET SCREW	100/BOX

3/8" Damper Clips - Saddle Type

• Elgen's 3/8" Damper Clips is used in conjunction with damper blade for controlling the damper inside the ductwork
• Corrosion resistant

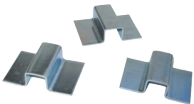

Item #	Description	Box QTY
GD1098	DAMPER CLIP 3/8"SADDLE TYPE	2000/BOX
GD1098-C	DAMPER CLIP 3/8"	100/BOX
GD1098A	DAMPER CLIP 3/8" **ALUMINUM**	MTO

Damper Rod Clips - U Bolt

• Elgen's Damper Rod Clips are used to secure a round damper rod on air-control dampers
• Accommodates a 3/8" or 1/2" Rod



Item #	Description	Box QTY
GD1096	RC-3 3/8" U-BOLT W/2 SQ.NUTS	100/BOX
GD1096ST-C	RC-3 3/8" U-BOLT W/2 SQ.NUTS *ST/ST	100/BOX

DAMPER HARDWARE & BLADES

Tip for Damper Blade Regulator - E-702

• Elgen's tip for Damper Blade Regulator is used with conjunction with Damper blade for controlling the airflow inside smoke fittings and round ductwork



Item #	Description	Box QTY
GH1000-C	E-702 HAMMER ON PART	100/BOX
GH1000-A	E-702 HAMMER ON PART ALUM	100/BOX

Washer for Damper Blade Regulator-E-704

• Elgen's Washer for Damper Blade Regulator is used with conjunction with Damper blade for controlling the airflow inside smoke-fittings and round ductwork



Item #	Description	Box QTY
GH1001-C	E-704 WASHER	100/BOX

Handle for Damper Blade Regulator-E-705

• Elgen's Handle for Damper Blade Regulator is used with conjunction with Damper Blade for controlling the airflow inside smoke fittings and round ductwork



Item #	Description	Box QTY
GH1002-C	E-705 HANDLE	100/BOX
GH1002-A	E-705 HANDLE **ALUMINUM**	100/BOX

Wing Nut for Damper Regulator-E-706

• Elgen's Wing Nut for Damper Blade Regulator is used with conjunction with Damper Blade for controlling the airflow inside smoke fittings and round ductwork



Item #	Description	Box QTY
HN0180-C	5/16" WING NUT (E-706) - FORGED	100/BOX

Bearing for Damper Blade Regulator-E-708

• Elgen's Bearing for Damper Blade Regulator is used with conjunction with Damper Blade for controlling the airflow inside smoke fittings and round ductwork



Item #	Description	Box QTY
GH1004-C	E-708 BEARING **100 PACK**	100/BOX
GH1004-A	E-708 BEARING **ALUMINUM**	100/BOX

DAMPER HARDWARE & BLADES



Hammer-on Regulator Sets

• Elgen’s Hammer-on Damper Regulator sets are used for controlling the damper inside the ductwork

Item #	Description	Box QTY
GH1014	E-69 REGULATOR SET	144/BOX
GH1015	E-70 REGULATOR SET	144/BOX
GH1016	E-71 REGULATOR SET	144/BOX
GH1016A	E-71 REGULATOR SET **ALUMINUM**	MTO



Dial Regulator 1/4” - RP-2X

• Elgen’s Dial Regulator is used in conjunction with Damper Blade for controlling the damper inside the ductwork
 • Corrosion resistant
 • Heavy gauge zinc plated steel regulators for low leakage applications

Item #	Description	Box QTY
GE1022	RP-2X 1/4" SQ DIAL REGULATOR **BULK**	100/BOX
GE1022ST	RP-2X *ST/ST*	100/BOX
GE1022ST-10	RP-2X **ST/ST	10/BOX



Dial Regulator 3/8” - RP-3

• Elgen’s Dial Regulator is used in conjunction with Damper Blade for controlling the damper inside the ductwork
 • Corrosion resistant
 • Heavy gauge zinc plated steel regulators for low leakage applications

Item #	Description	Box QTY
GE1023	RP-3 3/8" ROUND DIAL REGULATOR	100/BOX
GE1023ST	RP-3 *ST/ST*	100/BOX
GE1023ST-10	RP-3 **ST/ST	10/BOX



Dial Damper Regulator Set - 1/4”

• Elgen’s Dial Damper Regulator Set is used for controlling the damper inside the ductwork
 • 1/4” Regulator set for dampers up to 10”
 • Corrosion resistant
 • Quick and easy installation

Item #	Description	Box QTY
GE1015K	EDR-2X SQ REGULATOR SET of RP-2X, RP-8X, RP-6	100/BOX
GE1042K	EDR-2XL REGULATOR SET *	100/BOX
GE1042ST	EDR-2XL **ST/ST	100/BOX
GE1042ST-10	EDR-2XL **ST/ST	100/BOX

DAMPER HARDWARE & BLADES



Dial Damper Regulator Set 3/8"

- Elgen's Dial Damper Regulator Set is used for controlling the damper inside the ductwork
- 3/8" Regulator set for dampers up to 10"
- Corrosion resistant
- Quick and easy installation

Item #	Description	Box QTY
GE1016K	EDR-3 SQ REGULATOR SET of RP-3, RP-7, RP-9	100/BOX
GE1043	EDR-3XL REGULATOR SET GIVE RP-3, RP-7XL, RP-9XL	100/BOX
GE1043ST	EDR-3XL ST/ST**	100/BOX
GE1043ST-10	EDR-3XL ST/ST**	10/BOX



Quadrant Regulator 3/8" -RP-4 Stamped Handle

- Elgen's Quadrant Regulator is used in conjunction with Damper Blade for controlling the damper inside the ductwork
- Corrosion resistant
- Heavy gauge zinc plated steel regulators for low leakage applications
- Handle is stamped from 19GA ASTM A-653

Item #	Description	Box QTY
GE1024	RP-4 SQ QUADRANT	100/BOX



Quadrant Regulator 3/8" -RP-4C Diecast Handle

- Elgen's Quadrant Regulator is used in conjunction with Damper Blade for controlling the damper inside the ductwork
- Corrosion resistant
- Heavy gauge zinc plated steel regulators for low leakage applications
- Handle is manufactured from Zamac material

Item #	Description	Box QTY
GE1026	RP-4C SQ DIECAST QUADRANT	50/BOX
GE1075-10	RP-4C-SS QUADRANT ST/ST**	10/BOX



Quadrant Damper Regulator Set-3/8"

- Elgen's Quadrant Regulator is used in conjunction with Damper Blade for controlling the damper inside the ductwork
- Corrosion resistant
- Heavy gauge zinc plated steel regulators for low leakage applications
- Handle is manufactured from Zamac material

Item #	Description	Box QTY
GE1017	EQR-4 QUADRANT SET	100/BOX
GE1018	EQR-4C SQ DIECAST QUAD SET	100/BOX
GE1045	EQR-4CL REGULATOR SET	100/BOX
GE1044	EQR-4L REGULATOR SET	100/BOX

DAMPER HARDWARE & BLADES



Quadrant Regulator 1/2" - RP-5 Stamped Handle

- Elgen's Quadrant Regulator is used in conjunction with damper blade for controlling the damper inside the ductwork
- For 1/2" Square rod
- Corrosion resistant
- Stamped Handle from 19GA ASTM A-653

Item #	Description	Box QTY
GE1025	RP-5 SQ QUADRANT	100/BOX



Quadrant Regulator 1/2" - RP-5C Die Cast Handle

- Elgen's Quadrant Regulator is used in conjunction with Damper Blade for controlling the damper inside the ductwork
- Corrosion resistant
- Heavy gauge zinc plated steel regulators for low leakage applications
- Handle is manufactured from Zamac material

Item #	Description	Box QTY
GE1027	RP-5C DIECAST QUADRANT	50/BOX



Quadrant Regulator 1/2" Round - RP-5CR

- Elgen's Quadrant Regulator is used in conjunction with damper blade for controlling the damper inside the ductwork
- For 1/2" Round Rod
- Corrosion resistant
- Stamped Handle from 19GA ASTM A-653

Item #	Description	Box QTY
GE1029	RP-5CR RD DIECAST QUADRANT	100/BOX
GE1002-10	RP-5CR-SS ST/ST QUADRANT (WITH CAST HANDLE)	10/BOX
GE1002SS	RP-5CR-ST/ST SET *SPECIAL* W/ STAINLESS HANDLE PART	50/BOX
GE1002SS-10	RP-5CR-ST/ST *SPECIAL* W/ STAINLESS HANDLE PART	10/BOX



Quadrant Damper Regulator Set - 1/2"

- Elgen's Quadrant Damper Regulator Set is used for controlling the damper inside the duct work
- Corrosion resistant
- Quick and easy installation

Item #	Description	Box QTY
GE1019	EQR-5 QUADRANT SET	100/BOX
GE1020	EQR-5C DIECAST QUAD SET	50/BOX
GE1020-10	EQR-5C DIECAST QUAD SET	10/BOX
GE1077	EQR-5CR REGULATOR SET	100/BOX

DAMPER HARDWARE & BLADES



Threaded Bearings TB-1/TB-1XL

• Elgen's threaded bearings are used in conjunction with damper blade for controlling the damper inside the ductwork

Item #	Description	Box QTY
GE1052-C	TB-1 (THREADED BEARING)	100/BOX
GE1100-C	TB-1XL FULLY THREADED	100/BOX



Handle - RP-1

• Elgen's handle is used in conjunction with damper blade for controlling the damper inside the ductwork

Item #	Description	Box QTY
GE1030	RP-1 SPEEDY HANDLE	100/BOX



Washer - BW-1

• Elgen's Washer is used in conjunction with damper blade for controlling the damper inside the ductwork

Item #	Description	Box QTY
GE1050	BW-1 WASHER	100/BOX



Speedy Damper Regulator Set for Insulated Duct

• Elgen's Speedy Damper Regulator Set is used for controlling the damper inside the ductwork

Item #	Description	Box QTY
GE1013	ESR-1 SPEEDY REGULATOR SET	100/BOX
GE1013-10	ESR-1 SPEEDY REGULATOR SET	10/BOX
GE1101-10	ESR-1XL REGULATOR (10/PACK)	10/BOX
GE1101-C	ESR-1XL REGULATOR (100/PACK)	100/BOX

DAMPER HARDWARE & BLADES



MHB - Large Bracket

- Elgen's MHB Bracket is used for pivoting the blades on air-control dampers
- Can be used for both opposed or parallel blade dampers

Item #	Description	Box QTY
GD1050	MHB LARGE BRACKET WITH 7/32" HOLE	200/BOX
GD1051	MHB-AL LARGE ALUM BRACKET	200/BOX
GD1052	MHB-SS LARGE STST BRACKET	200/BOX



ALB-Medium Bracket

- Elgen's MHB Bracket is used for pivoting the blades on air-control dampers
- Can be used for both opposed or parallel blade dampers

Item #	Description	Box QTY
GD1127	ALB MEDIUM BRACKET	250/BOX
GD1073-C	ALB-SS MEDIUM STST BRACKET	100/BOX
GD1080	ALB-AL MEDIUM ALUM BRACKET	125/BOX



CB-Companion Bracket

- Elgen's MHB Bracket is used for pivoting the blades on air-control dampers
- Can be used for both opposed or parallel blade dampers

Item #	Description	Box QTY
GD1053-C	CB COMPANION BRACKET	100/BOX
GD1054	CB-AL ALUM COMPANION BRACKET	500/BOX
GD1055-C	CB-SS STST COMPANION BRACKET	100/BOX



Damper Brackets

- Elgen's Damper Rod Clips are used to secure a round damper rod on air-control dampers
- Accommodates a 3/8" or 1/2" Rod

Item #	Description	Box QTY
GD1038-KIT	DP-1 1/4"PIVT DAMPER BRKT	200/BOX
GD1501-KIT	DP-1 5/16" PIVOT DAMPER BRKT	200/BOX
GD1039	DP-1AL (1/4") ParallelBld B	100/BOX
GD1040	DP-1SS (1/4") ParallelBld B STAINLESS STEEL	100/BOX
GD1042	DP-1AL (5/16"PIVOT) DAMPER BK	100/BOX
GD1041-C	DP-1SS (5/16") PARR. BRACKET STAINLESS STEEL	100/BOX
GD1510	ALB-1 MED. BRACKET	100/BOX

DAMPER HARDWARE & BLADES



PV-Pivot

• Elgen's Pivot is used to accommodate pencil-rod, on air control dampers

Item #	Description	Box QTY
GD1056-C	PV 1/4" "BRASS PIVOT	100/BOX
GD2003-C	PV-5/16" PIVOT BRASS	100/BOX



Lollipop w/Spring

- Elgen's lollipop with spring is used in conjunction with a pivot to create a swivel for AL-1, OL-1, and SPL-10 Brackets
- Accommodates 1/4" or 5/16" rod
- The "tear-drop" design of the rod adaptor provides a multitude of threads allowing the set screw to firmly secure in the rod
- Corrosion resistant

Item #	Description	Box QTY
GD1128	LOLLIPOP ZAMAC	MTO



Conventional Bearing Pins

• Elgen's Bearing Pins is used to connect the blades to the frame on air-control dampers

Item #	Description	Box QTY
GD1082	DA-2X 1/2x2-1/2 Plated BearPin	100/BOX
GD1088-C	DA-3X 1/2x6 Plated Bearing Pin	100/BOX
GD1093	DA-4X 1/2SQx1/2RDx6" ADAPT	100/BOX



TL-1 Double Brass Twin Link Pivot

- Elgen's TL-1 Twin Link Pivot is used in conjunction with Twin Link Brackets for pivoting the blades on air-control dampers
- For opposed or parallel blade dampers

Item #	Description	Box QTY
GP1008-KIT	TL-1 DOUBLE BRASS TWIN LINK PIVOT	100/BOX

DAMPER HARDWARE & BLADES

PVC-1 Connector for Twin Link Pivot

• Elgen's PVC-1 is used in conjunction with a pivot and set screws to create double brass twin link pivot



Item #	Description	Box QTY
GD1501-C	PVC-1 CONNECTOR STUD	100/BOX

Twin Link Brackets



Item #	Description	Box QTY
GP1400	TLB-1 TWIN-LINK BRACKET	100/BOX
GP1400-10	TLB-1 TWIN-LINK BRACKET	10/BOX

Auto-Line Brackets

• Elgen' Auto-line Brackets are used for pivoting the blades on air-control dampers
 • For opposed or parallel blade dampers



AL-1		
Item	Size (in)	Qty
ALB	-	1
PV	1/4	1
Lollipop with spring	-	1

Item #	Description	Box QTY
GD1036-C	AL-1 ParallelBlde BRACKET	100/BOX
GD1061	AL-1AL ALUM ParallelBlade Brkt	MTO
GD1060	AL-1SS STST ParallelBlade Brkt	200/BOX

Link Ball Brackets

• Elgen's Link Ball Brackets are used for pivoting the blades on air-control damper
 • OB-1 Camperison Bracket
 • OB-45 - Small Center Bracket for Blades 4"-5"
 • OB-812 - Large Center Bracket for Blades 8"-12"



Item #	Description	Box QTY
GD1013	OB-45 OpposedBlde CenterBrkt	100/BOX
GD1015	OB-812 OpposedBlde CenterBrkt	100/BOX

Multi-Blade Damper Accessory Set

• Elgen's Multi Blade Damper Accessory Set is used for pivoting the blades on air-control dampers



DSC-550	
Item	Qty
AL-1	1
DA-2X	2
DA-1	2
DP-4	2

Item #	Description	Box QTY
GD1025	DSC-550 Parallel Blde Hdwr Set	100/BOX
GD1251	DSC-550-SS PARALLEL BLADE KIT	100/BOX
GD1251-1PC	DSC-550-SS PARALLEL BLADE KIT	1PC

DAMPER HARDWARE & BLADES

Oppo-Line Brackets

- Elgen's Oppo-Line Brackets are used for pivoting the blades on air-control dampers
- Used for opposed or parallel blade dampers



OL-1		
Item	Size (in)	Qty
MHB	-	1
PV	1/4	1
Lollipop with spring	-	1

Item #	Description	Box QTY
GD1037	OL-1 OpposedBld BRACKET	MTO
GD1063	OL-1AL ALUM OpposedBlade Brkt	MTO
GD1062	OL-1SS STST OpposedBlade Brkt	MTO

Oppon-Line Damper Accessory Set

- Elgen's Oppo-line Damper Accessory Set is used for pivoting the blades on air-control dampers

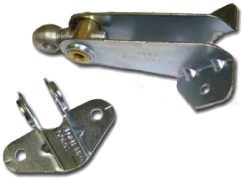

DOL-20	
Item	Qty
OL-1	1
DP-7	1

Item #	Description	Box QTY
GD1028-10	DOL-20 *10 PACK*	10/BOX
GD1028-C	DOL-20 *100 PACK*	100/BOX
GD1029	DOL-20-AL ALUMINUM (1 SET)	1PC
GD1231	DOL-20-SS STAINLESS STEEL (1SET)	1PC

Oppo-Line Damper Blade Set

- Elgen's Oppo-line Damper Blade Set is used for pivoting the blades on air-control dampers



DOL-1/2K	
Item	Qty
OL-1	1
DP-7	1
DA-2X	4
DA-1	4
DP-4	4

Item #	Description	Box QTY
GD1027	DOL-1/2K DAMPER BLADE SET	25/BOX
GD1234	DOL-1/2K-SS STAINLESS STEEL	MTO

Parallel Blade Damper Accessory Set

- Elgen's Parallel Blade Damper Accessory Set is used for pivoting the blades on air-control dampers

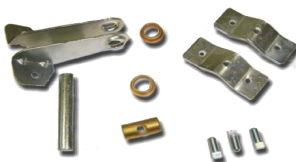

DSC-150	
Item	Qty
DP-1	1
DA-2X	2
DA-1	2
DP-4	2

Item #	Description	Box QTY
GD1134	DC-150 DAMPER ROD CASTING	100/BOX
GD1021	DSC-150-AL ParallelBld Hdwr	MTO
GD1022	DSC-150SS ParallelBld Hdwr Set	MTO

DAMPER HARDWARE & BLADES

Splitter Damper Brackets

• Elgen's Splitter Damper Brackets are used for easy control of the splitter damper



SPL-10		
Item	Size (in)	Qty
CB	-	1
PV	1/4	1
Lollipop with spring	-	1

Item #	Description	Box QTY
GD1136	SPL-10 SPLITTER DAMPER BRACKET	100/BOX
GD1139	SPL-10AL ALUM Splitter Bracket	MTO
GD1138	SPL-10SS STST Splitter Bracket	MTO

Swivel Splitter Damper Bracket

- Elgen's DC-15 Swivel Splitter Bracket is used in conjunction with SPL-10 Splitter Damper Bracket and round damper rod for easy control of the Splitter Damper Bracket and round damper rod for easy control of the
- Accommodates 1/4" rod
- Ball joint provides amooth acting, trouble free splitter damper
- Neoprene gasket prevents leakage



Item #	Description	Box QTY
GD1135	DC-15 SWIVEL SPLITTER BRACKET	100/BOX

Oppo-Line Brackets

- Elgen's Oppo-line Brackets are used for pivoting the blades on air-control dampers
- Used for opposed or parallel blade Dampers



DP-7		
Item	Size (in)	Qty
CB	-	1
PV	1/4	1
Des	1/4-28	1

Item #	Description	Box QTY
GD1045	DP-7 (1/4") CompanionBrkt"	100/BOX
GD1046	DP-7AL (1/4") CompanionBrkt	100/BOX
GD1047	DP-7SS STST CompanionBrkt	100/BOX
GD1181	DP-7 (5/16") CompanionBrkt"	100/BOX
GD10461	DP-7AL (5/16") COMPANION BRKT	100/BOX

DAMPER HARDWARE & BLADES

ESS-12 Side Seal

- Used for preventing leakage through frame sides
- High Temperature resistant
- Tempered stainless steel
- Permanent spring back
- Can be used in fire dampers

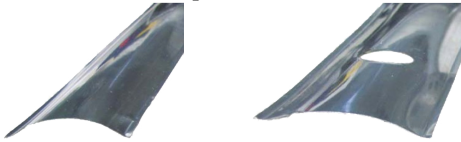

Item #	Description	Box QTY
GM1410	ESS-12 SIDE SL 1.5" (.0065)	6,000FT
GM1410-4920	ESS-12 SIDE SL 1.5" (.0065)	4,920FT
GM1413	ESS-12-5.75" CENTERS ST/ST SIDE SEAL	6,000FT
GM1413-58	ESS-12-5.75" CENTERS ST/ST SIDE SEAL **WTIH 5/8" HOLES**	6,(6000FT
GM1413-916	ESS-12-5.75" CENTERS ST/ST SIDE SEAL **WTIH 9/16" HOLES**	6,(6000FT
GM1414	ESS-12-6 SIDE SL 1.5"W"(.0065)	6,000FT

BES-2 Gripseal

- Blade-seal for new dampers and retrofitting existing dampers
- Easy to install
- Snap over lade edges
- Requires no adhesive
- Self Sealing



Item #	Description	Box QTY
GM1000	BES-2 GRIPSEAL 6/PC	1,800FT
GM1103	BES-2-SS-12' STAINLESS STEEL	600ft

Slide Pin

- Elgen's Link Ball Brackets are used for pivoting the blades on air-control damper
- OB-1 Comparison Bracket
- OB-45 - Small Center Bracket for Blades 4"-5"
- OB-812 - Large Center Bracket for Blades 8"-12"



Item #	Description	Box QTY
GP1001	SP-2X SLIDE PIN	500/BOX
GP1004	SP-2X-V SLIDE PIN "V" SHAPE	500/BOX

Drive Pin

- Elgen's Multi Blade Damper Accessory Set is used for pivoting the blades on air-control dampers



Item #	Description	Box QTY
GP1005	SP-3X-V SLIDE PIN	150/BOX
GP1021	SP-3X DRIVE PIN	250/BOX

SHOP PRODUCTS & COMPONENTS

Conduit Inserts

- Elgen's Conduit Inserts are used in conjunction with metal EMT or conduit to provide internal rectangular duct support
- Rf. SMACNA HVAC Duct Construction Sandards, PG 1-29 FIG. 1-2, Fig "B"



Item #	Description	Box QTY
EG0970	EZ-CONDUIT LOCKS 1/2"	1000/BOX
EG0970-C	EZ-CONDUIT LOCKS 1/2"	100/BOX
EG0975	EZ-CONDUIT LOCKS 3/4"	1000/BOX
EG0975-C	EZ-CONDUIT LOCKS 3/4"	100/BOX
EG0970S6	EZ-CONDUIT LOCKS 1/2" *ST/ST#316*	100/BOX
EG0975S6	EZ CONDUIT-LOCKS 3/4" *ST/ST#316*	100/BOX
EG0972-C	EZ-CONDUIT LOCKS 1/2" **NUT ONLY**	100/BOX
EG0974-C	EZ-CONDUIT LOCKS 3/4" **NUT ONLY**	100/BOX
EG0971	EZ-CONDUIT LOCKS **BOLT & WASHER ONLY**	1,500/BOX
EG0971-C	EZ-CONDUIT LOCKS **BOLT & WASHER ONLY**	100/BOX
EG0977-C	EZ-CONDUIT LOCKS 1.25", 2" HEX BOLT, STEEL/NEOPRENE WASHER	100/BOX
EG0980-C	WASHERS*ONLY* FOR CONDUIT Z/P 1/4"ID X 1-1/4"OD BONDED WASHER	100/BOX

Stud Inserts

- Elgen's Stud Inserts are used in conjunction with metal
- Neoprene/Metal washer to create airtight seal



Item #	Description	Box QTY
EG0995	STUD CONDUIT INSERTS 1/2"	1000/BOX
EG0995-C	STUD CONDUIT INSERTS 1/2"	100/BOX
EG0996	STUD CONDUIT INSERTS 3/4"	1000/BOX
EG0996-C	STUD CONDUIT INSERTS 3/4"	100/BOX

EZ-End

- EZ End is a duct stiffening adapter designed for transition duct
- Conforms to any angle from 1-90 Deg
- Made from UL rated, glass reinforced, nylon ULTRAMID 8233 GHS POLYAMIDE



Item #	Description	Box QTY
EG0985K	EZ-END INSERT W/WASHER AND NUT	100/BOX

Conduit Cross-Clamp

- Elgen's Conduit Cross Clamp is used in fastening the conduit together when they are near from two directions inside a rectangular ductwork



Item #	Description	Box QTY
EG0988	CONDU - CLAMP FOR 1/2" & 3/4"	250/BOX

Nylon Solid Inserts

- Elgen's Conduit Inserts are used in conjunction with metal EMT or conduit to provide internal rectangular duct support
- Easy installation and labor savings



Item #	Description	Box QTY
EG0991-C	CONDUPLUG 1/2" NYLON NO SPRING W/FLANGE NUT	100/BOX
EG0992-C	CONDUPLUG 3/4" NYLON **NO SPRING W/FLANGE NUT	100/BOX

Nylon Spring Inserts



Item #	Description	Box QTY
EG0993-C	CONDUPLUG SPRING-LOADED 1/2" NYLON (W/ FLANGE NUT)	100/BOX
EG0994-C	CONDUPLUG SPRING-LOADED 3/4" NYLON W/FLANGE NUT	100/BOX

SHOP PRODUCTS & COMPONENTS



Labels

- Solid White
- Colors with Full Bleed
- White w/Color Stripe
- Permanent
- Removable
- 6 labels to a sheet
- 1,000 sheets per box

Part #	Description	Part #	Description
LB0001	WHITE SOLID PERMANENT (1M/BOX)	LB1185	PINK FLUORESCENT STRIPE PERMANENT LABELS (1000 SHEETS/BOX)
LB0005	HOT PRINTED SOLID PERMANENT LABELS (1000SHEETS/BOX)	LB1999	WHITE SOLID REMOVABLE LABELS (1000SHEETS/BOX)
LB0010	RED SOLID PERMANENT LABELS (1000 SHEETS/BOX)	LB2000	ROSE STRIPE REMOVABLE LABELS (1000SHEETS/BOX)
LB0020	PINK SOLID PERMANENT LABELS (1000 SHEETS/BOX)	LB2010	BEIGE SOLID REMOVABLE LABELS (1000SHEETS/BOX)
LB0030	ORANGE SOLID PERMANENT LABELS (1000 SHEETS/BOX)	LB2020	BLUE SOLID REMOVABLE LABELS (1000SHEETS/BOX)
LB0040	YELLOW SOLID PERMANENT LABELS (1000 SHEETS/BOX)	LB2030	ORANGE FLUORESCENT SOLID REMOVABLE LABELS (1000SHEETS/BOX)
LB0050	ROSE SOLID PERMANENT LABELS (1000 SHEETS/BOX)	LB2040	GREEN FLUORESCENT SOLID REMOVABLE LABELS (1000SHEETS/BOX)
LB0060	GREEN SOLID PERMANENT LABELS (1000 SHEETS/BOX)	LB2050	PINK FLUORESCENT SOLID REMOVABLE LABELS (1000SHEETS/BOX)
LB0070	BLUE SOLID PERMANENT LABELS (1000 SHEETS/BOX)	LB2060	YELLOW FLUORESCENT SOLID REMOVABLE LABELS (1000SHEETS/BOX)
LB0080	LAVENDER SOLID PERMANENT LABELS (1000 SHEETS/BOX)	LB2070	RED FLUORESCENT SOLID REMOVABLE LABELS (1000SHEETS/BOX)
LB0090	BEIGE SOLID PERMANENT LABELS (1000 SHEETS/BOX)	LB2080	YELLOW STRIPE REMOVABLE LABELS (1000SHEETS/BOX)
LB0100	GRAY SOLID PERMANENT LABELS (1000 SHEETS/BOX)	LB2090	GRAY SOLID REMOVABLE LABELS (1000SHEETS/BOX)
LB0110	BROWN SOLID PERMANENT LABELS (1000 SHEETS/BOX)	LB2100	HOT PRINTED SOLID REMOVABLE LABELS (1000SHEETS/BOX)
LB0120	RED FLUORESCENT SOLID PERMANENT LABELS (1000 SHEETS/BOX)	LB2110	LAVENDER SOLID REMOVABLE LABELS (1000SHEETS/BOX)
LB0130	PINK FLUORESCENT SOLID PERMANENT LABELS (1000 SHEETS/BOX)	LB2120	GREEN SOLID REMOVABLE LABELS (1000SHEETS/BOX)
LB0140	ORANGE FLUORESCENT SOLID PERMANENT LABELS (1000 SHEETS/BOX)	LB2130	GREEN STRIPE REMOVABLE LABELS (1000SHEETS/BOX)
LB0150	GREEN FLUORESCENT SOLID PERMANENT LABELS (1000 SHEETS/BOX)	LB2140	ORANGE STRIPE REMOVABLE LABELS (1000SHEETS/BOX)
LB0160	YELLOW FLUORESCENT SOLID PERMANENT LABELS (1000 SHEETS/BOX)	LB2150	RED STRIPE REMOVABLE LABELS (1000SHEETS/BOX)
LB1000	BEIGE STRIPE REMOVABLE LABELS (1000SHEETS/BOX)	LB2160	RED SOLID REMOVABLE LABELS (1000SHEETS/BOX)
LB1050	RED STRIPE PERMANENT LABELS (1000 SHEETS/BOX)	LB2170	ORANGE SOLID REMOVABLE LABELS (1000SHEETS/BOX)
LB1060	PINK STRIPE PERMANENT LABELS (1000 SHEETS/BOX)	LB2180	LAVENDER STRIPE REMOVABLE LABELS (1000SHEETS/BOX)
LB1070	ORANGE STRIPE PERMANENT LABELS (1000 SHEETS/BOX)	LB2190	PINK STRIPE REMOVABLE LABELS (1000SHEETS/BOX)
LB1080	YELLOW STRIPE PERMANENT LABELS (1000 SHEETS/BOX)	LB2200	BROWN SOLID REMOVABLE LABELS (1000SHEETS/BOX)
LB1090	ROSE STRIPE PERMANENT LABELS (1000 SHEETS/BOX)	LB2210	PINK SOLID REMOVABLE LABELS (1000SHEETS/BOX)
LB1100	GREEN STRIPE PERMANENT LABELS (1000 SHEETS/BOX)	LB2220	BLUE STRIPE REMOVABLE LABELS (1000SHEETS/BOX)
LB1110	BLUE STRIPE PERMANENT LABELS (1000 SHEETS/BOX)	LB2230	YELLOW SOLID REMOVABLE LABELS (1000SHEETS/BOX)
LB1120	LAVENDER STRIPE PERMANENT LABELS (1000 SHEETS/BOX)	LB2240	ROSE SOLID REMOVABLE LABELS (1000SHEETS/BOX)
LB1130	BEIGE STRIPE PERMANENT LABELS (1000 SHEETS/BOX)	LB2250	GRAY STRIPE REMOVABLE LABELS (1000SHEETS/BOX)
LB1140	GRAY STRIPE PERMANENT LABELS (1000 SHEETS/BOX)	LB2260	BROWN STRIPE REMOVABLE LABELS (1000SHEETS/BOX)
LB1150	BROWN STRIPE PERMANENT LABELS (1000 SHEETS/BOX)	LB2270	RED FLUORESCENT STRIPE REMOVABLE LABELS (1000SHEETS/BOX)
LB1160	YELLOW FLUORESCENT STRIPE PERMANENT LABELS (1000 SHEETS/BOX)	LB2275	PINK FLUORESCENT STRIPE REMOVABLE LABELS (1000SHEETS/BOX)
LB1165	RED FLUORESCENT STRIPE PERMANENT LABELS (1000 SHEETS/BOX)	LB2280	ORANGE FLUORESCENT STRIPE REMOVABLE LABELS (1000SHEETS/BOX)
LB1175	ORANGE FLUORESCENT STRIPE PERMANENT LABELS (1000 SHEETS/BOX)	LB2285	GREEN FLUORESCENT STRIPE REMOVABLE LABELS (1000SHEETS/BOX)
LB1180	GREEN FLUORESCENT STRIPE PERMANENT LABELS (1000 SHEETS/BOX)	LB2290	YELLOW FLUORESCENT STRIPE REMOVABLE LABELS (1000SHEETS/BOX)

SHOP PRODUCTS & COMPONENTS

Wire Mesh

- Elgen's Wire Mesh is a versatile product that can be used in many commercial, residential and industrial applications
- Hole Size: 1/2" x 1/2"

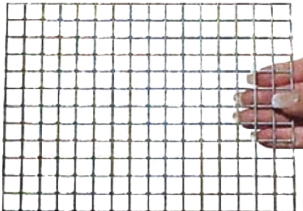

Item #	Description
HC0005	1/2X1/2X48" 16GA.WIRE MESH 100 FT
HC0010	1/2X1/2X48" 16GA. ST/ST#304 WIRE MESH (100FT/ROLL)
HC0011	1/2X1/2X48" 16GA.ALUM. WIRE MESH(100FT/ROLL)
HC0015	1/2X1/2X48" 19GA. WIRE MESH 100 FT
HC0020	1/2X1/2X48"19GA. ST/ST#304 WIRE MESH (100FT/ROLL)
HC0045	1/2X1/2X60" 16GA.WIRE MESH (100FT/ROLL)
HC0050	1/2X1/2X60"16GA. ST/ST#304 WIRE MESH (100FT/ROLL)
HC0051	1/2X1/2X60"16GA *ALUM* WIRE MESH (100FT/ROLL)
HC0055	1/2X1/2X60" 19GA. WIRE MESH - 100 FT
HC0060	1/2X1/2X60"19GA. ST/ST WIRE MESH (100FT/ROLL)
HC0009	1/2X1/2X36" 16GA. ST/ST#304 WIRE MESH (100FT/ROLL)

Spray Paint



Item #	Description	Box QTY
PL0005	BLACK GENERIC FLAT	6/BOX
PL0040	ALUM GENERIC SPRAY PAINT	6/BOX
PL0070	GRAY GENERIC PRIMER	6/BOX
PL0344	PCD SPRAY PAINT CAN	12/BOX

Zinc Rich Cold Galv Spray Paint

- Use to touch-up/repair galvanized ducts, storage tanks, ect. in moderate to sever environments
- Dries fast 20 minutes to the touch; withstands heat to 200deg F
- For Industrial applications
- Corrosion-resistance



Item #	Description	Box QTY
PL0185	ZINC RICH SPRAY CANS COLD GALV	6/BOX

AE-40 Rust Penetrant

- Rust Penetrant act to penetrate, lubricate, prevent rust and corrosion and displace moisture
- Protects against rust and corrosion for up to 6 months of indoor storage



Item #	Description	Box QTY
PL0201	WD-40 CAN *AE-40*	12/BOX

5/16" Prof Chain Coil



Item #	Description	Box QTY
RC0115	CHAIN 5/16" PROFF COIL	92/BUCKET

Black Elgen Marker



Item #	Description	Box QTY
PL0271	BLACK *ELGEN* MARKER	12/BOX

4MIL Clear Polyethylene Sheeting



Item #	Description	Box QTY
MC0056	4 MIL CLEAR POLYETHYLENE-10FT SHEETING 10' X 100' X 4 MIL	1 ROLL
MC0057	4 MIL CLEAR POLYETHYLENE-20FT SHEETING 20' X 100' X 4 MIL	1 ROLL

SAFETY, TOOL & ACCESSORIES

KN95

**KN95
Now
Available**



Protect yourself and others
with a mask that was
designed to be effective for
limiting the spread of
Covid-19.

SAFETY, TOOL & ACCESSORIES

Extension Cords



Item #	Description	Box QTY
EL0045	14/3 EX.CORD 50FT	6/BOX
EL0154	12/3 *GFCI* OSHA TRIPLE-TAP	6/BOX
EL0046	14/3 SJTW 50FT TRIPLE TAP EX.CORD - LIGHTED ENDS	6/BOX

Master Lock



Item #	Description	Box QTY
LK0085	#1 MASTERLOCK KEY # A-2401	6/BOX
LK0090	#5 MASTERLOCK KEY# A-383	6/BOX
LK0095	#5 MASTERLOCK KEY# A-453	6/BOX
LK0100	#5 MASTERLOCK KEY# A445	6/BOX
LK0101	#5 MASTERLOCK A-389	6/BOX

Hard Hat



Item #	Description	Box QTY
SA0015	HARD HAT WHITE	16/BOX

Dust Mask



Item #	Description	Box QTY
SA0107	KN95 MASK	25/BOX

Safety Glasses



Item #	Description	Box QTY
SA0086-20	SAFETY GLASSES	20/BOX
SA0080-300	SAFETY GOGGLES	300/BOX

Gloves



Item #	Description	Box QTY
SA0152	GLOVES RUBBER PALM	12/BOX
SA0156	GLOVES RUBBER PALM *SMALL*	12/BOX
SA0140	GLOVES LEATHER PALM #7512	12/BOX
SA0149	NITRILE GLOVE, BLUE, 10 BXS/CARTON, LARGE	100/BOX
SA01491	NITRILE GLOVE, BLACK 10 BXS/CARTON, MEDIUM	100/BOX

Ear Plugs



Item #	Description	Box QTY
SA0120	EAR PLUGS *FOAM*	200/BOX

Economy Rags



Item #	Description	Box QTY
MC0250	RAGS 50LBS.*ECONOMY	1 ROLL

SAFETY, TOOL & ACCESSORIES

Genie Lifts

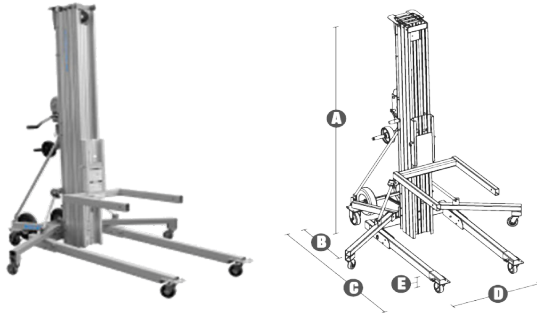

Item #	Description
LF0166	SLC-12 GENIE LIFT
LF0155	SLC-18 GENIE LIFT
LF0160	SLC-24 GENIE LIFT
LF0167	GENIE FORK EXTENSION #33366-S
LF0148	33984GT GENIE FORKS
LF0148P	48301 TOGGLE.PIN FOR FORK #SLC
LF0168	GENIE RETAIN.PIN FOR EXT#80679

MODELS	SLC™-12		SLC™-18		SLC™-24	
	US	Metric	US	Metric	US	Metric
MEASUREMENTS						
Working height:						
standard forks - forks down	11 ft 2 in	3.40 m	16 ft 9 in	5.10 m	22 ft 3 in	6.78 m
standard forks - forks up	12 ft 11 in	3.94 m	18 ft 6 in	5.64 m	24 ft	7.32 m
adjustable forks - forks down	11 ft 2 in	3.40 m	16 ft 9 in	5.10 m	22 ft 3 in	6.78 m
adjustable forks - forks up	12 ft 11 in	3.94 m	18 ft 6 in	5.64 m	24 ft	7.32 m
boom**	12 ft 2 in	3.70 m	17 ft 9 in	5.41 m	23 ft 3 in	7.10 m
A Height - stowed	7 ft 2 in	2.18 m	7 ft 2 in	2.18 m	7 ft 2 in	2.18 m
B Length - stowed	2 ft 10 in	.86 m	2 ft 10 in	.86 m	2 ft 10 in	.86 m
C - operating	5 ft 3 in	1.60 m	6 ft 1 in	1.85 m	6 ft 9 in	2.06 m
D Width - stowed*	2 ft 7.5 in	.80 m	2 ft 7.5 in	.80 m	2 ft 7.5 in	.80 m
- with stabilizers lowered	5 ft 6 in	1.68 m	5 ft 6 in	1.68 m	5 ft 6 in	1.68 m

PRODUCTIVITY						
Load capacity:						
14 in (36 cm) load center	650 lbs	295 kg	650 lbs	295 kg	650 lbs	295 kg
24 in (61 cm) load center	425 lbs	193 kg	425 lbs	193 kg	425 lbs	193 kg
42 in (107 cm) load center	180 lbs	82 kg	160 lbs	73 kg	160 lbs	73 kg
E Ground clearance	2 in	.05 m	2 in	.05 m	2 in	.05 m
Load height minimum	6 in	.15 m	6 in	.15 m	6 in	.15 m

Specifications

• One size fits all CO₂ bottle mounting bracket

MODELS	GH™-3.8		GH™-5.6	
	US	Metric	US	Metric
MEASUREMENTS				
A Height - stowed	3 ft 5 in	1.04 m	4 ft 6 in	1.37 m
- lifting height	12 ft 5.6 in	3.80 m	18 ft 4.5 in	5.60 m
B Length - platform	1 ft 7 in	.48 m	1 ft 7 in	.48 m
C Width - platform	2 ft	.61 m	2 ft	.61 m
D - base (corner to corner)	4 ft 5 in	1.35 m	4 ft 5 in	1.35 m
PRODUCTIVITY				
Load capacity	300 lbs	136 kg	250 lbs	113 kg
Storage/transport dimensions	14x14x39.5 in	.36x.36x1 m	14x14x39.5 in	.36x.36x1 m
POWER				
Recommended PSI	85 psi	5.86 bar	85 psi	5.86 bar
WEIGHT*				
	75 lbs	34 kg	82 lbs	37 kg

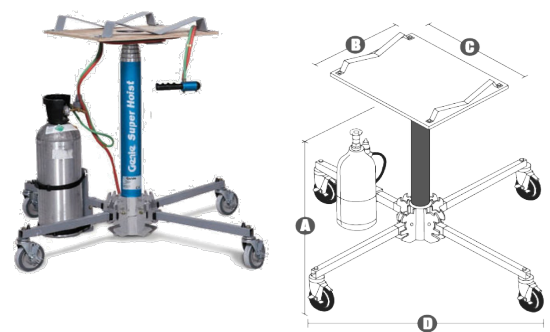

Item #	Description
LF0165	GH-5.6 GENIE LIFT
LF0164	GH-3.8 GENIE LIFT



SAFETY, TOOL & ACCESSORIES

Vermette Lifts

- Model 520
- Lifts 500LBS up to 20FT (22" with optional height extension)
- Sectional Design provides fast, easy set-up, take-down, and transport
- Two handle roller bearing which provides fast, smooth operation and a self energizing brake automatically locks the load in place
- Equipped with swivel casters, guy cables, outrigger bars with wing screw levelers

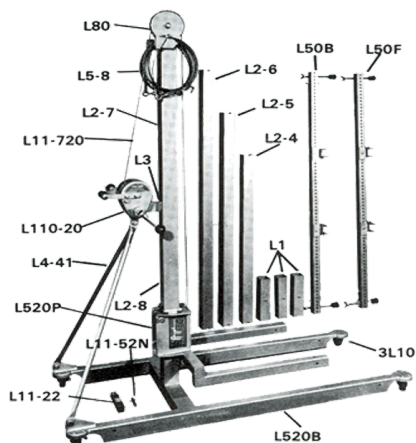

Item #	Description
LF0026	520 VERMETTE LIFT
LF0045	L7-HE VERMETTE PLATFORM (2/BOX)
LF0060	L-1 VERMETTE TONGUE
LF0070	L-2-2 VERMETTE POST(1/BOX)
LF0075	L-2-3 VERMETTE POST(1/BOX)
LF0080	L-2-4 VERMETTE POST(1/BOX)
LF0085	L-2-5 VERMETTE POST(1/BOX)
LF0090	L-2-6 VERMETTE POST(1/BOX)
LF0125	3L10 VERMETTE 3"CASTER (EACH)
LF0135	5L10 VERMETTE 5"CASTER

Item #	Description
LF0020	512M VERMETTE LIFT
LF0045	L7-HE VERMETTE PLATFORM (2/BOX)
LF0060	L-1 VERMETTE TONGUE
LF0070	L-2-2 VERMETTE POST(1/BOX)
LF0075	L-2-3 VERMETTE POST(1/BOX)
LF0080	L-2-4 VERMETTE POST(1/BOX)
LF0085	L-2-5 VERMETTE POST(1/BOX)
LF0090	L-2-6 VERMETTE POST(1/BOX)
LF0125	3L10 VERMETTE 3"CASTER (EACH)
LF0135	5L10 VERMETTE 5"CASTER

- The 512M Model will lift 500LBS up to 12ft high (14ft with optional height extension)
- The sectional design provides fast, easy set-up, take-down, and transport
- Two handle roller bearing winch provides fast, smooth operation and a self energizing brake automatically locks the load in place
- Equipped with four swivel casters to permit easy positioning

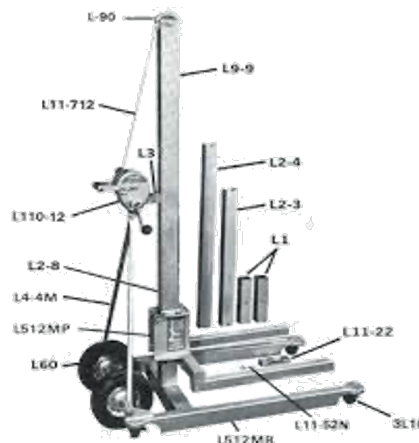

SAFETY, TOOL & ACCESSORIES

Hand Tools

- Elgen's Cleat tool improves installation of cleats the easy way



Item #	Description
HT0851	CLEAT TOOL *ELGEN* STRAIGHT (EACH)
HT0852	CLEAT TOOL *ELGEN* HEX HANDLE (EACH)
HT08525	CLEAT TOOL *ELGEN* HEX HANDLE SUPER THICK (EACH)

- Elgen's Corner tool is used to crimp corners into place in ductwork



Item #	Description
HT0844	CRIMP TOOL, GOLD, FOR CORNERS



Item #	Description	Box QTY
HT0260N	111 CAULK GUN **NEWBORN	12/BOX
HT0260	111 EZ THRUST CAULK GUN ELGEN	24/BOX

- Cable tie gun is used to secure panduit nylon cable ties up to 0.37" in width and has adjustable tensioning for differing tie sizes
- Features an automatic tie cut-off, a pistol-style grip for comfort, and metal case construction



Item #	Description
HT0102	FLEX TIE TENSION TOOL *RED TOOL*

- Heavy duty pliers staplers offer exceptional ease of operation
- Powerful clinching action makes the pliers staplers an excellent choice



Item #	Description
HTSTAPLER	STAPLER #P694
HTSTAPLES38	STAPLES FOR #P694/9 3/8" (5000/BOX)

- Hang Four Fabricator allows you to fabricate a wide variety of wall anchors, braces, hangers and more
- Punches/Bends/Twists/ Cuts to your specifications with no more costly delays



Item #	Description
HT0890	MULTI-TOOL WHITNEY 4-IN-1 (#8) *BLUE WITH 9/32 PUNCH&DIE
HT0555	ROPER WHITNEY#8 PUNCH 9/32" (SINGLE)
HT0675	ROPER WHITNEY#8 DIES 9/32" (SINGLE)



Item #	Description	Box QTY
HT0301-50	KNIFE - BREAKAWAY	50/BOX
HT0301	KNIFE - BREAKAWAY	25/BOX
HT0305	KNIFE - OSBORNE #76 W/WOOD HDL	10/BOX
HT0314	STRETCH FILM CUTTER	50/BOX
HT0315	KNIFE - RETRACTABLE METAL	25/BOX



- High quality air hammer for sealing Pittsburg lock seams (18GA and lighter)
- Best suited for floor mounted compressors
- Can run on air pressures from 30-100PSI



Item #	Description
PT0368	AIR HAMMER - NEW ELGEN MODEL



Item #	Description
HT0265	T3-T18 ESTWING TINNER HAMMER



Item #	Description
HT0877	HR-705 HAND OPERATED RIVET TOOL



Item #	Description
HT0958	STACKABLE CORNER HAND TOOL



Item #	Description
AN1380	3/8" DROP-IN SETTING TOOL

SAFETY, TOOL & ACCESSORIES

Power Tools



- 5.0 amp pistol grip, variable speed, 2500 RPM motor
- Replaceable A-2 tool steel shear blades
- Cuts C.R. mild steel 14-18GA
- Cuts at over 170 inches per minute

Item #	Description
PT0242	KD440# KETT SHEAR 14 GA. MAX
PT0395	60-20# KETT SHEAR HEAD
PT0400	60-21# KETT CENTER BLADE
PT0405	60-22R# KETT RT.BLADE
PT0410	60-22L# KETT LT.BLADE
PT0430	60-27# KETT SPACER BUSHING



Item #	Description
PT0013	#2850-22CT MILWAUKEE IMPACT DRIVER KIT
PT0470	#2635-22 MILWAUKEE M18 DOUBLE CUT SHEAR KIT 18GA
PT0065	#6509-31 MILWAUKEE SAWZALL KIT CORDED
PT0091	6176-20# MILW.CHOPSAW
PT0035	0375 MIL.DRILL 3/8"ANG.DRILL
PT0058	6519-22# MILW.SAWZALL ****
PT0061	MILW. 18V CORDLESS DRILL PART #2607-22
PT0070	6536-21# MILW.SAWZALL SUPERSAW
PT0080	6238# MILWAUKEE PORTA-BANDSAW DEEP CUT
PT0088	6790-20# MILW. TEK SCREW-GUN
PT0068	#2742-20 MILWAUKEE 16GA ANGLED FINISH NAILER (TOOL ONLY)
PT0472	#2712-22 MILWAUKEE M18 18V CORDLESS 1" SDS HAMMER KIT
PT0477	#0730-22 MILWAUKEE M28 28V CORDLESS 6-1/2" CIRCULAR SAW
PT0478	#2627-20 MILWAUKEE M18 CUT OUT TOLL
PT04791	#0882-20 MILWAUKEE M18 COMPACT VACUUM
PT0067	#2740-20 MILWAUKEE 18GA BRAD NAILER (TOOL ONLY)
PT04793	#6130-833 MILWAUKEE 4-1/2" GRINDER CORDED
PT0471	#2720-21 MILWAUKEE M18 FUEL SAWZALL KIT
PT0473	#2853-22 MILWAUKEE M18 1/4 IMPACT DRIVER KIT
PT0479	#48-59-1808 MILWAUKEE M18 & M12 RAPID CHARGER
PT04792	#48-11-1820 MILWAUKEE M18 18V 2.0 RED LITHIUM BATTERY
PT0476	#48-59-1890 MILWAUKEE M18 RED LITHIUM 9.0 HIGH DEMAND BATTERY STARTER KIT



Item #	Description
PT0125	DW100 DEWALT 3/8 DRILL KEYED NEW #D21002 OR #DWE1014
PT0130	DW106 DEWALT 3/8 DRILL KEYLESS NEW #DWD112
PT0160	DW292 DEWALT HEAVY DUTY REVERSING IMPACT DRILL
PT0241	#DW890 DEWALT 18 GA SHEAR
PT0166	#DCD740B DEWALT 20V MAX RIGHT ANGLE DRILL
PT0160	DW292 DEWALT HEAVY DUTY REVERSING IMPACT DRILL
PT0143	D25023K DEWALT SDS-HAMMR DRILL
PT0145	DW160V DEWALT RIGHT ANGLE DRILL REVERSIBLE / 90DEG
PT0147	DW309K DEWALT 12A SUPERSAWZALL
PT0149	D28710 DEWALT 14" CHOPSAW
PT0028	#DCH273P2DH DEWALT CORDLESS SDS W/HEPA
PT0020	DWE4011 4-1/2" DEWALT ANGLE GRINDER
PT0153	DCS371P1 DEWALT 20V BAND SAW KIT
PT00284	#DCH293R2DH DEWALT CORDLESS 1-1/8" SDS PLUS HAMMER W/ DUST COLLECTION
PT01491	DCS570P1 20V 7-1/4" CORDLESS CIRCULAR SAW KIT
PT0154	DEWALT 20-VOLT 1/4" CORDLESS IMPACT DRIVER # DCF885B
PT0152	#D28715 14" CHOPSAW
PT01461	#DCS367B 20V BRUSHLESS SAWZALL (TOOL ONLY)
PT0057	#DCF887B 20V IMPACT DRIVER (TOOL ONLY)
PT02683	DEWALT #DW892 14GA SHEAR
PT0163	D25263K DEWALT 1-1/2" D-HANDLE SDS HAMMER KIT
PT0164	DWE305 DEWALT 12 AMP RECIPROCATING SAW
PT0165	DWD110K DEWALT 3/8" PISTOL GRIP DRILL KIT W/KEYLESS CHUCK
PT00281	#DCH273P2 DEWALT CORDLESS SDS HAMMER DRILL
PT0036	#DCK299P2 HAMMER DRILL/IMPACT DRIVER COMBO KIT
PT0191	#DCD791B 20V COMPACT DRILL/DRIVER
PT02684	DEWALT #DCF885B 20V 1/4" IMPACT DRIVER (TOOL ONLY)
PT0010	#DCB205-2 20V LITHIUM ION BATTERY (2/PACK)
PT0016	#DCB204-2 20V LITHIUM ION BATTERY 2/PACK
PT0027	#DW8002 DEWALT 14" X 3/32 CHOP SAW BLADE
PT0093	14" CHOP SAW BLADE DW8500 DIAMOND EDGE - DeWALT
PT0022	DCK290L2 20V HAMMER DRILL KIT
PT0018	DCF885M2 DRIVER KIT
PT0017	DCD985M2 HAMMER DRILL KIT
PT0155	#DCG412P2 DEWALT GRINDER KIT



Item #	Description
PT02682	JS1602 MAKITA UNI-SHEAR
PT0291	HM0810# MAKITA HAMMER
PT0292	HK1810# MAKITA HAMMER
PT0295	2414NB MAKITA 14"CHOP SAW
PT0288	2455# MAKITA SDS HAMMER DRILL
PT0270	DA3010F# MAKITA RT.ANGLE DRILL REV/90DEG
PT0271	MAKITA 36V HAMMER DRILL CORDLESS 1" SDS PLUS
PT0272	N-9514B# MAKITA 4" GRINDER
PT02721	9005-B MAKITA 5"DISC GRINDER
PT0278	JR3070 15A SUPERSAWZALL MAKITA
PT0273	#XRH011TX MAKITA 18V ROTARY HAMMER W/HEPA VACUUM ATTACHMENT
PT0273	#XRH011TX MAKITA 18V ROTARY HAMMER W/HEPA VACUUM ATTACHMENT
PT02682-BLADES	#191383-0 MAKITA #JS1602 SHEAR BLADE SET

SAFETY, TOOL & ACCESSORIES

Tool Accessories



Item	Size (in) Length x Width x Thickness	Teeth per Inch	Primary Use
414	4 x 0.75 x 0.35	14	Metals over 1/8" thickness
418	4 x 0.75 x 0.35	18	Heavy gauge metals Fiberglass
424	4 x 0.75 x 0.35	24	Metals lighter than 18 GA
614	6 x 0.75 x 0.35	14	Metals over 1/8" thickness
618	6 x 0.75 x 0.35	18	Heavy gauge metals Fiberglass
624	6 x 0.75 x 0.35	24	Metals lighter than 18 GA
656	6 x 0.75 x 0.05	6	Wood
818	8 x 0.75 x 0.35	18	Heavy gauge metals Fiberglass
96	9 x 0.75 x 0.05	6	Wood Fast Cutting
126	12 x 0.75 x 0.05	6	Wood Fast Cutting
1210	12 x 0.75 x 0.05	10	Thin wood Metals up to 1/8" thickness
1218	12 x 0.75 x 0.35	18	Heavy gauge metals Fiberglass

Item #	Description	Box QTY
BL00016	618 DEWALT SAWZALL BLADE	100/BOX
BL0250	418 ELGEN SAWZALL BLADE	50/BOX
BL0264	656 ELGEN BLADE 6"6T (.050THK)	25/BOX
BL0280-25	624 ELGEN SAWZALL BLADE	25/BOX
BL02805	818 ELGEN BLADE	100/BOX
BL0284D-25	1218 ELGEN SAWZALL BLADE	25/BOX



Item #	Description	Box QTY
AB0406	#DWA8051 4-1/2"X.045"X7/8" CUTTING WHEEL	25/BOX



Item #	Description	Box QTY
BL0505	PORTA-BLADE 44-7/8X1/2X18T	1PC



Item #	Description	Box QTY
AB0071	CHOPSAW BLADE 14"	25/BOX



Item #	Description	Box QTY
AB0430	GRINDING WHEEL 4-1/2"	25/BOX



Item #	Description	Box QTY
HT0320	UTILITY BLADES	100/BOX



Item #	Description	Box QTY
MA0005	1/4" DRILL BIT *SDS* X4"	12/BOX
MA0006	1/4" DRILL BIT SDS SPECIAL X6"	12/BOX
MA0025	3/8" DRILL BIT *SDS* X6"	12/BOX
MA0040	1/2" DRILL BIT *SDS* X6"	12/BOX
MA0060	3/4" DRILL BIT *SDS* X10"	1PC
DB0045	7/16X3/8 DRILL BIT SHK.	6/BOX
DB0075	9/16X3/8 DRILL BIT SHK.	12/BOX
DB0320	1/4 DRILL HS BIT	12/PACK/BOX
DB0325	3/8 DRILL HS BIT	24/BOX
DB0250	5/32 DRILL HS BIT(12/PACK)	12/PACK/BOX
MA0066	3/16" DRILL BIT *SDS* X6"	12/BOX
MA0085	5/16" DRILL BIT *SDS* X6"	12/BOX
MA0100	7/16" DRILL BIT *SDS* X6"	12/BOX
MA0120	5/8" DRILL BIT *SDS* X6"	1PC
DB0235	#30DE DRILL BIT *DOUBLE END*	12/BOX
DB0241A	1/8 DRILL BIT HS	12/PACK/BOX
DB0242	3/16 DRILL HS BIT	12/PACK/BOX
DB0243	5/16 DRILL HS BIT	24/PACK/BOX
DB0255	7/32 DRILL HS BIT	12/PACK/BOX
DB0260	9/32 DRILL HS BIT	12/PACK/BOX
DB0325-12	3/8 DRILL HS BIT	12/BOX
DB0007-6	1/2X3/8 X6" L SHANKED DRILL BIT	6/BOX
MA0060-21	3/4" DRILL BIT *SDS* X 21" #S MTE2234	1PC
DB0045-JOBBER	7/16X3/8 DRILL BIT SHK. ** JOBBER DRILL BIT	6/BOX
DB0238	3/16" DRILL BIT *DOUBLE END* #211DE1264	12/BOX
DB0030	5/8X3/8 DRILL BIT SHK.	1PC



WHERE QUALITY MATTERS



The Contractor's Choice / America's Choice
Corporate: (800) 503-9805 Fax: (201) 964-9030
www.elgenmfg.com