

Firepower®

WELDING



PLASMA



OXYFUEL



ACCESSORIES



Check out the **NEW**
MST-200 & FP-200

Firepower

31
MIG STICK TIG

Cutting & Welding Products

FirepowerOnline.com





Advantage

Firepower® an ESAB® Company

Professional-Grade Performance, Value and Simplicity

Firepower®, an ESAB® brand, carries the assurance of more than 375 years of premiere global welding and cutting brands, including ESAB (founded 1904) and its family of products from Victor® (1913), Tweco® (1936) and Thermal Dynamics® (1957).

Through a refined portfolio of welding and cutting equipment, filler metals, personal protective equipment and accessories, users can take on just about any light- to medium-duty metalworking challenge. Firepower meets the needs of the general automotive repair industry, muffler and body shops, small fabricators, farmers, mobile contractors, maintenance technicians and Do-It-Yourself enthusiasts.

Firepower equipment combines industrial-level performance with versatility and value. Users who do not weld or cut every day can count on Firepower's reliability and ease-of-use to help them work efficiently. Professionals will appreciate technology and controls that enable them to work at their very best.

For product support, Firepower has the added advantage of utilizing ESAB's excellence in customer service and application know-how.

Visit FirepowerOnline.com for additional product information, literature, instructional videos and other helpful tools.



Contents

Part No. Index	2
Welding Range	
Welding Power Supply Selection Guide	5
MST 140i & MST 180i 3-in-1	6
MST 200 3-in-1	7
MST 220i 3-in-1	8
3-in-1 Selection Comparison	9
MIG Guns	10
MIG/Flux Cored Welders	12
Spool Guns	14
MIG Consumable Charts	15
MIG Consumables	16
TIG & Stick Welders	18
TIG Torches	20
TIG Consumable Charts	22
TIG Consumables	23
Welding Accessories	25
Oxy-Fuel Solutions	
Oxy-Fuel Outfits	30
Oxy-Fuel Regulators	32
Attachments, Handles & Torch	34
Accessories	35
Cutting Tips	36
Nozzles & Gauges	37
Adaptors, Tanks & Flowmeter	38
AirFuel Torches	40
Plasma Cutting	
Plasma Cutting Selection Guide	43
Cutting Machines	44
Plasma Carts & Accessories	48
Filler Metal & Accessories	
Stick Consumable Charts	51
Stick Electrode Overview	52
Arc Welding Electrodes	54
Electrodes Job Packs	55
Electrodes - Mild & Stainless Steel	56
Electrodes - Nickel Base	57
Electrodes - Aluminum	58
Welding & Brazing Rods	59
Solder, Fluxes & Soldering Paste	60
Welding Wire Steel & Aluminum	61
Safety Welding Helmets	62
Tools	67
Brushes & Abrasives	73

PART NO.	PAGE	PART NO.	PAGE	PART NO.	PAGE	PART NO.	PAGE	PART NO.	PAGE	PART NO.	PAGE
1-1110-1	44	0387-0489	38	1423-0051	66	1423-2107	75	1423-2192	80	1423-3191	79
0323-0270	37	0387-0490	38	1423-0052	69	1423-2108	75	1423-2197	79	1423-3193	79
0323-0271	37	0387-0491	38	1423-0081	73	1423-2109	75	1423-2198	79	1423-3199	80
0323-0272	37	0387-0492	38	1423-0082	73	1423-2110	75	1423-2202	77	1423-3201	80
0323-0360	37	0656-0000	35	1423-0083	73	1423-2111	76	1423-2213	79	1423-3203	80
0323-0361	37	0656-0008	35	1423-0084	73	1423-2113	76	1423-2220	82	1423-3208	79
0323-0362	37	0656-0016	35	1423-0086	68	1423-2115	75	1423-2221	82	1423-3211	79
0323-0363	37	0781-2733	38	1423-0087	73	1423-2116	75	1423-2224	77	1423-4100	63
0323-0364	37	0781-4238	33	1423-0093	73	1423-2117	74	1423-2226	77	1423-4107	65
0323-0365	37	0781-4239	33	1423-0094	71	1423-2118	74	1423-2232	80	1423-4133	66
0324-0112	37	0781-9726	33	1423-0095	71	1423-2120	76	1423-2305	79	1423-4175	64
0324-0143	37	0781-9727	33	1423-0096	71	1423-2121	76	1423-2310	81	1423-4181	64
0324-0146	37	0781-9826	32	1423-0097	71	1423-2122	76	1423-2311	81	1423-4204	74
0324-0150	37	0781-9827	32	1423-1101	60	1423-2123	76	1423-2312	81	1423-4209	76
0324-0151	37	0781-9828	33	1423-1102	60	1423-2124	76	1423-2327	76	1423-4210	75
0324-0152	37	0781-9829	32	1423-1108	60	1423-2125	76	1423-3142	79	1423-4211	74
0324-0153	37	0781-9830	32	1423-1109	60	1423-2140	84	1423-3143	79	1423-4213	76
0324-0154	37	0781-9832	32	1423-1110	60	1423-2141	84	1423-3144	79	1423-4214	75
0324-0155	37	0916-0003	35	1423-1111	60	1423-2143	84	1423-3145	79	1423-4215	73
0381-0751	34	0916-0028	35	1423-1112	60	1423-2151	85	1423-3146	79	1423-4216	73
0381-0759	34	0916-0032	35	1423-1113	60	1423-2152	85	1423-3147	79	1423-4217	73
0381-0760	34	0916-0122	38	1423-1114	60	1423-2154	85	1423-3148	79	1423-4219	67
0382-0358	34	1017-1338	10	1423-1209	69	1423-2155	85	1423-3149	79	1423-4222	67
0384-0977	31	1027-1397	14	1423-1400	73	1423-2157	85	1423-3150	79	1423-4223	67
0384-0978	31	1412-0012	35	1423-1402	73	1423-2158	85	1423-3151	80	1423-4224	67
0384-1260	40	1412-0020	35	1423-1404	66	1423-2160	85	1423-3152	80	1423-4225	67
0384-1280	40	1412-0021	35	1423-1408	70	1423-2161	85	1423-3153	80	1423-4226	67
0384-2571	30	1412-0022	35	1423-1419	68	1423-2164	83	1423-3155	79	1423-4228	84
0384-2572	30	1412-0128	35	1423-1423	69	1423-2165	83	1423-3157	79	1423-4229	84
0384-2573	31	1412-0134	35	1423-1425	72	1423-2166	83	1423-3158	75	1423-4230	84
0384-2682	30	1420-0296	71	1423-1426	72	1423-2171	83	1423-3159	75	1423-4231	84
0384-2684	30	1421-0062	72	1423-1428	69	1423-2172	83	1423-3162	82	1423-4232	77
0386-1226	35	1421-0085	35	1423-1432	68	1423-2173	83	1423-3163	82	1423-4234	77
0387-0400	40	1421-0098	26	1423-1435	71	1423-2178	79	1423-3164	82	1423-4235	77
0387-0436	38	1421-0099	26	1423-1442	73	1423-2180	79	1423-3177	77	1423-4236	82
0387-0463	41	1423-0016	70	1423-2100	74	1423-2185	77	1423-3181	79	1423-4237	82
0387-0464	41	1423-0017	64	1423-2101	74	1423-2186	80	1423-3182	79	1423-4240	77
0387-0465	41	1423-0018	64	1423-2102	74	1423-2187	80	1423-3184	79	1423-4241	77
0387-0470	40	1423-0019	64	1423-2103	74	1423-2188	80	1423-3185	79	1423-4242	77
0387-0471	40	1423-0026	69	1423-2104	74	1423-2189	80	1423-3186	80	1423-4244	79
0387-0487	70	1423-0032	69	1423-2105	74	1423-2190	80	1423-3188	79	1423-4246	79
0387-0488	38	1423-0050	69	1423-2106	75	1423-2191	80	1423-3189	79	1423-4247	80



Part No. Index

PART NO.	PAGE	PART NO.	PAGE	PART NO.	PAGE	PART NO.	PAGE	PART NO.	PAGE	PART NO.	PAGE
1423-4249	67	1440-0412	56	1442-0006	23	1444-0075	16	1444-1200	13	6700-2591	36
1423-4250	67	1440-0413	56	1442-0007	23	1444-0080	16	1444-3200	7	6700-2592	36
1424-0013	37	1440-0419	58	1442-0008	23	1444-0082	16	1445-1925	45	6700-2593	36
1424-0014	37	1440-0420	58	1442-0009	23	1444-0140	16	1445-1935	46	6700-2594	36
1424-0015	37	1440-0423	57	1442-0010	23	1444-0141	16	1445-1945	47	6700-2595	36
1424-0017	37	1440-0424	57	1442-0011	23	1444-0142	16	6700-2408	36	6700-2596	36
1424-0019	37	1440-0425	57	1442-0020	20	1444-0165	16	6700-2409	36	6700-2618	36
1435-0090RP	37	1440-0426	58	1442-0021	20	1444-0220	16	6700-2410	36	6700-2619	36
1435-0091RP	37	1440-0428	59	1442-0022	21	1444-0221	16	6700-2411	36	6700-2620	36
1435-0092RP	37	1440-0429	59	1442-0025	27	1444-0222	16	6700-2412	36	6700-2621	36
1435-0093RP	37	1440-0430	59	1442-0030	18	1444-0224	16	6700-2413	36	6700-2622	36
1440-0080	58	1440-0431	59	1442-0032	19	1444-0261	16	6700-2414	36	6700-2623	36
1440-0081	58	1440-0433	59	1442-0050	21	1444-0265	16	6700-2415	36	6700-2624	36
1440-0083	57	1440-0434	59	1442-0053	20	1444-0326	12	6700-2416	36	20891010	62
1440-0155	56	1440-0440	57	1442-0054	23	1444-0328	12	6700-2438	36	20891013	62
1440-0156	56	1440-0441	55	1442-0055	23	1444-0346	12	6700-2439	36	20891017	62
1440-0165	56	1440-0442	59	1442-0057	23	1444-0348	12	6700-2440	36	20891018	62
1440-0210	61	1440-0443	57	1442-0059	24	1444-0407	25	6700-2441	36	20891020	62
1440-0211	61	1440-0445	61	1442-0060	24	1444-0407	48	6700-2442	36	20891023	62
1440-0212	61	1440-0447	61	1442-0061	24	1444-0489	16	6700-2443	36	20891024	62
1440-0215	61	1440-0449	57	1442-0062	24	1444-0870	6	6700-2444	36	20891025	62
1440-0216	61	1440-0456	61	1442-0065	24	1444-0871	6	6700-2445	36	20891026	62
1440-0217	61	1440-0489	61	1442-0066	24	1444-0872	8	6700-2468	36	W4013802	21
1440-0220	61	1440-0496	56	1443-0003	68	1444-0876	17	6700-2469	36	W4014450	27
1440-0221	61	1440-0497	56	1443-0004	68	1444-0877	17	6700-2470	36		
1440-0222	61	1441-0004	63	1443-0005	68	1444-0878	17	6700-2471	36		
1440-0230	61	1441-0015	64	1443-0015	27	1444-0879	17	6700-2472	36		
1440-0231	61	1441-0023	63	1443-0016	27	1444-0881	10	6700-2473	36		
1440-0235	61	1441-0038	63	1443-0025	68	1444-0882	10	6700-2474	36		
1440-0236	61	1441-0042	63	1443-0026	68	1444-0885	17	6700-2475	36		
1440-0240	61	1441-0047	65	1443-0027	68	1444-0886	17	6700-2476	36		
1440-0241	61	1441-0048	65	1443-0490	27	1444-0887	17	6700-2498	36		
1440-0245	61	1441-0049	65	1443-0491	26	1444-0888	17	6700-2499	36		
1440-0296	60	1441-0050	65	1443-0494	27	1444-0889	17	6700-2500	36		
1440-0374	57	1441-0085	62	1443-0495	26	1444-0890	17	6700-2501	36		
1440-0400	55	1441-0086	62	1444-0025	16	1444-0891	17	6700-2502	36		
1440-0401	55	1441-0087	62	1444-0026	16	1444-0892	17	6700-2503	36		
1440-0402	55	1441-0088	62	1444-0027	16	1444-0893	17	6700-2504	36		
1440-0405	55	1442-0002	24	1444-0029	16	1444-0894	14	6700-2505	36		
1440-0406	55	1442-0003	23	1444-0050	16	1444-0900	25	6700-2588	36		
1440-0409	55	1442-0004	23	1444-0051	16	1444-0900	48	6700-2589	36		
1440-0411	55	1442-0005	23	1444-0052	16	1444-0902	26	6700-2590	36		

WELDING



MIG

Firepower® Welding Products

Performance, Value and Ease of Use

The latest Firepower Welding range offers superior performance, excellent value and ease-of-use that helps the craftsman get the job done right the first time.

Firepower draws on the heritage and quality of Tweco® equipment, and has the advantage of utilizing that excellence in product support, service, and application know-how.

This product range will perform a wide spectrum of welding tasks from thin gauge car panels to thick Industrial sections. Professionals from auto repair, construction, farm/ranch, skilled trades and serious do-it-yourselfers will find the superior solutions they need with Firepower.

The Firepower MST is the heart of the new line and has changed the game, setting a new standard for portable welding equipment. The 3-in-1 power supplies provide MIG, Stick, and TIG capability from one integrated portable system. They have been designed to provide users with total welding flexibility and optimized welding performance with each process. Firepower systems come complete with optimized accessories. These welding systems are ready to meet your needs right out of the box.



STICK



TIG

* Please see page 40 for a quick explanation of duty cycle.

Product Name	MAX. Thickness	Weld Process	Input Power	Output Range	Gas Usage	Weldable Metals	
ACDC TIG (GTAW) + STICK (SMAW)							
TIG 140 ACDC 1442-0030	MAX. THICKNESS 3/16" PLATE (4.8 mm) SINGLE PASS ↑	TIG HF START LIFT TIG	INPUT PLUG 15 AMP 115 VAC	MAX. OUTPUT 140 AMPS	CURRENT AC DC	DUTY CYCLE 20% @140 AMPS 15.6 VOLTS	
TIG 200 ACDC 1442-0032	MAX. THICKNESS 1/4" PLATE (6.4 mm) MULTI PASS ↑	TIG HF START LIFT TIG	INPUT PLUG 50 AMP 208/230 VAC	MAX. OUTPUT 200 AMPS	CURRENT AC DC	DUTY CYCLE 20% @200 AMPS 18 VOLTS	
MIG (GMAW)							
FP-95 1444-0322	MAX. THICKNESS 1/8" PLATE (3.2 mm) SINGLE PASS ↑	MIG FLUX CORED	INPUT PLUG 15 AMP 115 VAC	MAX. OUTPUT 90 AMPS	CURRENT DC	DUTY CYCLE 17% @85 AMPS 18.25 VOLTS	
FP-125 1444-0324	MAX. THICKNESS 3/16" PLATE (4.8 mm) SINGLE PASS ↑	MIG FLUX CORED	INPUT PLUG 15 AMP 115 VAC	MAX. OUTPUT 125 AMPS	CURRENT DC	DUTY CYCLE 19% @90 AMPS 18.5 VOLTS	
FP-135 1444-0326	MAX. THICKNESS 1/4" PLATE (6.4 mm) MULTI PASS ↑	MIG FLUX CORED	INPUT PLUG 15 AMP 115 VAC	MAX. OUTPUT 135 AMPS	CURRENT DC	DUTY CYCLE 28% @117 AMPS 19.85 VOLTS	
FP-165 1444-0328	MAX. THICKNESS 5/16" PLATE (7.9 mm) MULTI PASS ↑	MIG FLUX CORED	INPUT PLUG 50 AMP 208/230 VAC	MAX. OUTPUT 165 AMPS	CURRENT DC	DUTY CYCLE 18% @140 AMPS 21 VOLTS	
FP-200 <i>NEW</i> 1444-1200	MAX. THICKNESS 3/8" PLATE (9.5 mm) MULTI PASS ↑	MIG FLUX CORED	INPUT PLUG 15 AMP 115 VAC	INPUT PLUG 50 AMP 208/230 VAC	MAX. OUTPUT 200 AMPS	CURRENT DC	DUTY CYCLE 15% @200 AMPS 14 VOLTS
MST POWER SUPPLIES: 3-IN-1							
MST 140i 1444-0870	MAX. THICKNESS 1/8" PLATE (3.2 mm) SINGLE PASS ↑	MIG STICK TIG LIFT TIG	INPUT PLUG 15 AMP 115 VAC	INPUT PLUG 20 AMP 115 VAC	MAX. OUTPUT 140 AMPS	CURRENT DC	DUTY CYCLE 20% @90 AMPS 18.5 VOLTS
MST 180i 1444-0871	MAX. THICKNESS 1/4" PLATE (6.4 mm) MULTI PASS ↑	MIG STICK TIG LIFT TIG	INPUT PLUG 50 AMP 208/230 VAC	MAX. OUTPUT 180 AMPS	CURRENT DC	DUTY CYCLE 30% @145 AMPS 22.5 VOLTS	
MST 200 <i>NEW</i> 1444-3200	MAX. THICKNESS 3/8" PLATE (9.5 mm) MULTI PASS ↑	MIG STICK TIG LIFT TIG	INPUT PLUG 15 AMP 115 VAC	INPUT PLUG 50 AMP 208/230 VAC	MAX. OUTPUT 200 AMPS	CURRENT DC	DUTY CYCLE 15% @200 AMPS 14 VOLTS
MST 220i 1444-0872	MAX. THICKNESS 3/8" PLATE (9.5 mm) MULTI PASS ↑	MIG STICK TIG LIFT TIG	INPUT PLUG 15 AMP 115 VAC	INPUT PLUG 50 AMP 208/230 VAC	MAX. OUTPUT 210 AMPS	CURRENT DC	DUTY CYCLE 20% @210 AMPS 23.5 VOLTS

NEW
MST 200



MST 140i Multi-Process Welding System

Specifications

Part No.	Description
1444-0870	MST 140i, Multi-Process Welding System



MIG	STICK	TIG LIFT TIG	GAS/GASLESS	MAX. OUTPUT 140 AMPS	MAX. THICKNESS 1/8" PLATE (3.2 mm) SINGLE PASS ↑
INPUT PLUG 15 AMP 115 VAC	INPUT PLUG 20 AMP 115 VAC	OUTPUT DC	FLEXIBLE GASES ARGON CO₂	WARRANTY 3 YEAR	GENERATOR 3500 WATTS

INCLUDES

Firepower MST 140i Power Supply, Firepower 140 Amp MIG Gun, Firepower Flow Meter Regulator / Gauge & Hose, Electrode Holder & Ground Clamp, 2 Drive Rolls and Contact Tips, 15-20 Amps Power Adapter, Shoulder Strap, and CD with Multi-Language Operating Instructions

APPLICATIONS

Farms/Ranches, Auto Applications, On-Site Repair - Does not work with Spool Gun

MACHINE SPECIFICATIONS

Maximum Output	140 Amp
MIG (GMAW/FCAW)	140A / 19V @ 15% Duty Cycle
Welding Output @104° F (40° C)	90A / 18.5V @ 20% Duty Cycle
STICK (SMAW)	90A / 23V @ 15% Duty Cycle
Welding Output @104° F (40° C)	80A / 23.2V @ 35% Duty Cycle
TIG (GTAW)	140A / 15.6V @ 15% Duty Cycle
Welding Output @104° F (40° C)	100A / 14V @ 20% Duty Cycle
Current Range	10 – 140 Amp
MIG Welding Voltage Range	14.5 – 19 Volt
Wirefeed Speed Range	90 – 390 IPM (2.3 – 9.9 m/min)
Nominal OCV Volt/DC	53 Volt
Maximum Plate Thickness	1/8" (3.2 mm)*

* 30 Amp service required to obtain 3/16"

The Firepower MST 140i and MST 180i 3-in-1 machines come complete with all the necessary MIG & Stick components which gives even a beginner the capability to weld immediately, right out of the box. Both machines feature MIG, Stick, and TIG processes in a unit that weighs 33 pounds. The MST's both come with a Quick Start guide that walks you through the machine set-up in four simple steps. The MST 140i uses the 115 VAC, which allows you to weld virtually anywhere. The MST 180i comes with more power, using 208/230V and a maximum output of 180 Amps. The MST 180i is Spool Gun capable for Aluminum MIG welding. With the MST 140i and MST 180i you can be welding like a pro in no time.

MST 180i Multi-Process Welding System

Specifications

Part No.	Description
1444-0871	MST 180i, Multi-Process Welding System

INCLUDES

Firepower MST 180i Power Supply, Firepower 180 MIG Gun, Firepower Flow Meter Regulator / Gauge & Hose, Electrode Holder & Ground Clamp, 2 Drive Rolls & Contact Tips, Standard 230V Plug, Shoulder Strap, and CD with Multi-Language Operating Instructions

APPLICATIONS

Farms/Ranches, Auto Applications, On-Site and Maintenance Repair

MACHINE SPECIFICATIONS

Maximum Output	180 Amp
MIG (GMAW/FCAW)	180A / 23V @ 20% Duty Cycle
Welding Output @104° F (40° C)	145A / 22.5V @ 30% Duty Cycle
STICK (SMAW)	175A / 27V @ 20% Duty Cycle
Welding Output @104° F (40° C)	140A / 25.6V @ 30% Duty Cycle
TIG (GTAW)	175A / 17V @ 25% Duty Cycle
Welding Output @104° F (40° C)	160A / 16.4V @ 30% Duty Cycle
Current Range	10 – 180 Amp
MIG Welding Voltage Range	14.5 – 26 Volt
Wirefeed Speed Range	100 – 650 IPM (2.5 – 16.5 m/min)
Nominal OCV Volt/DC	62 Volt
Maximum Plate Thickness	1/4" (6.4 mm)

MIG	STICK	TIG LIFT TIG	GAS/GASLESS	MAX. OUTPUT 180 AMPS	MAX. THICKNESS 1/4" PLATE (6.4 mm) SINGLE PASS ↑
INPUT PLUG 50 AMP 208/230 VAC	OUTPUT DC	HERTZ 50/60	FLEXIBLE GASES ARGON CO₂	WARRANTY 3 YEAR	GENERATOR 9000 WATTS



MST 200 Multi-Process Welding System

Specifications

Part No.	Description
1444-3200	MST-200 System Package

NEW



ESAB Designed Firepower MST-200 inverter-based welding system is ready to tackle steel, stainless and aluminum projects. It's professional-grade arc characteristics and full-featured digital controls enable you to fine-tune arc performance to deliver superior welding results. It weighs just 29 lbs. and offers dual-voltage 120/230V flexibility. Take this welder wherever work takes you – around the shop, in the field or at home in your garage.

The Firepower MST-200 is a Multi-Process MIG/Flux Cored/Stick/Lift TIG welding system with a 10 – 200A output. Stable Lift TIG arc at low amperage for total control; power to run Stick electrodes up to 5/32- inches. Digital controls with large easy-to-read LED display enable fast, easy and more accurate operation. Improve welding results with advanced functions typically found on industrial machines: MIG wire run-in, burn-back, variable inductance, 2T/4T trigger control, Lift TIG arc starts, gas pre and post-flow, Stick hot start and arc force control.

INCLUDES

MST-200 package includes: Power Source, Tweco Fusion 180 Velocity MIG Gun with Tweco Connection & Velocity Consumables, Tweco 17V TIG Torch with 50 mm Dinse and Accessory Kit, Electrode Holder, Ground Clamp, Argon/CO2 Regulator, Power Adaptor and Sample Wire Spool.

APPLICATIONS

Automotive, Agricultural Equipment, Civil Constructio, Repair and Maintenance, Light Fabrication, Automotive Bodies, HVAC

MACHINE SPECIFICATIONS

Maximum Output	200 Amp
MIG (GMAW/FCAW)	90A/18.5V @40% Duty Cycle
Welding Output @104° F (40° C)	200A/24V @15% Duty Cycle
STICK (SMAW)	70A/22.8V @40% Duty Cycle
Welding Output @104° F (40° C)	170A/26.8V @20% Duty Cycle
TIG (GTAW)	90A/13.6V @40% Duty Cycle
Welding Output @104° F (40° C)	200A/18V @15% Duty Cycle
Current Range	10 – 200 Amps
MIG Welding Voltage Range	12 – 24 Volt
Wirefeed Speed Range	80 – 450 ipm (2 – 11 m/min)
Nominal OCV Volt/DC	
Maximum Plate Thickness	3/8 in. (9.5 mm) @ 230V

OPTIONS & ACCESSORIES

1027-1397	Tweco Spool Gun 160 A, 3.6 m (12 ft) (required for Al MIG welding)
1442-0025	Firepower TIG Foot Control 15' 8-Pin
W4014450	ESAB TIG Foot Control, 4.6 m (15 ft) cable and 8-pin
1442-0065	TIG Accessory Kit .040" & 1/16" (20-115A)
1442-0066	TIG Accessory Kit 3/32" & 1/8" (100-225A)
0781-9411	Victor Argon Flow Gauge Regulator GF-250-50-580
0781-9832	Firepower Argon/CO2 Flowgauge Regulator, 580 CGA, 10-150 PSIG
W4013900	Gas Hose, 3.8 m (12.5 ft), Male 5/8-18UNF
W4014000	Power Adapter, 230 V to 120 V, 15 A
1444-0900	Basic Utility Cart



WELDING

MST 220i Multi-Process Welding System

Specifications

Part No.	Description
1444-0872	MST 220i, Multi-Process Welding System



The Firepower MST 220i has it all. It's the only machine in the 3-in-1 line that offers 115 and 208/230V, and provides MIG, Stick and TIG welding outputs for use anywhere. Portable enough to take to the job site, yet with 210 Amps maximum output, it has the power to meet your large job demands. This welding system is perfect for automotive repair and customization, mechanical contractors, farms/ranches, maintenance and repair, and garage and job shops. The MST 220i allows you to choose the best process for your applications. The MIG process provides maximum productivity in the shop, while the Stick process works ideally outdoors, and TIG is for those welding applications that require more precise control. The MST 220i is also Spool Gun capable for Aluminum MIG welding. There is no other machine like the MST 220i, it's a "must have" powerhouse!



INCLUDES

Firepower MST 220i Power Supply, Firepower 220 Amp MIG Gun, Firepower Flow Meter Regulator / Gauge & Hose, Electrode Holder & Ground Clamp, 230V-115V Adapter Plug & Cable, 2 Drive Rolls & Contact Tips, Spring used for small 2 lb rolls, and CD with Multi-Language Operating Instructions

APPLICATIONS

Farms/Ranches, Auto Applications, On-Site and Maintenance Repair

MACHINE SPECIFICATIONS

Maximum Output	210 Amp
MIG (GMAW/FCAW)	110A / 19.5V @ 45% Duty Cycle (115V)
Welding Output @104°F (40°C)	210A / 23.5V @ 20% Duty Cycle (230V)
STICK (SMAW)	110A / 24.8V @ 35% Duty Cycle (115V)
Welding Output @104°F (40°C)	200A / 25V @ 25% Duty Cycle (230V)
TIG (GTAW)	150A / 16V @ 35% Duty Cycle (115V)
Welding Output @104°F (40°C)	200A / 18V @ 25% Duty Cycle (230V)
Current Range	10 – 150 Amp (115V), 10 – 210 Amp (230V)
MIG Welding Voltage Range	14 – 30 Volt
Wirefeed Speed Range	100 – 600 IPM (2.5 – 15.2 m/min) @ 230V
	100 – 400 IPM (2.5 – 10.2 m/min) @ 115V
Nominal OCV Volt/DC	62 Volt
Maximum Plate Thickness	3/8" (9.5 mm)



Which **MST** is Best for You?



WELDING DC	MST 140i	MST 180i	MST 200	MST 220i
Maximum Output	140 Amp	180 Amp	200 Amp	210 Amp
Order Information	Part No: 1444-0870 MST 140i System	Part No: 1444-0871 MST 180i System	Part No: 1444-3200 MST 200 System	Part No: 1444-0872 MST 220i System
MIG (GMAW/FCAW) Welding Output @104°F (40°C)	140A / 19V @ 15% Duty Cycle 90A / 18.5V @ 20% Duty Cycle	180A / 23V @ 20% Duty Cycle 145A / 22.5V @ 30% Duty Cycle	200A / 24V @ 15% Duty Cycle 90A / 18.5V @ 40% Duty Cycle	110A / 19.5V @ 45% Duty Cycle (115V) 210A / 23.5V @ 20% Duty Cycle (230V)
STICK (SMAW) Welding Output @104°F (40°C)	90A / 23V @ 15% Duty Cycle 80A / 23.2V @ 35% Duty Cycle	175A / 27V @ 20% Duty Cycle 140A / 25.6V @ 30% Duty Cycle	170A / 26.8V @ 20% Duty Cycle 70A / 22.8V @ 40% Duty Cycle	110A / 24.8V @ 35% Duty Cycle (115V) 200A / 25V @ 25% Duty Cycle (230V)
TIG (GTAW) Welding Output @104°F (40°C)	140A / 15.6V @ 15% Duty Cycle 100A / 14V @ 20% Duty Cycle	175A / 17V @ 25% Duty Cycle 160A / 16.4V @ 30% Duty Cycle	200A / 18V @ 15% Duty Cycle 90A / 13.6V @ 40% Duty Cycle	150A / 16V @ 35% Duty Cycle (115V) 200A / 18V @ 25% Duty Cycle (230V)
Current Range	10 – 140 Amp	10 – 180 Amp	10 – 200 Amps	10 – 150 Amp (115V), 10 – 210 Amp (230V)
MIG Welding Voltage Range	14.5 – 19 Volt	14.5 – 26 Volt	12 – 24 Volt	14 – 30 Volt
Wirefeed Speed Range	90 – 390 IPM (2.3 – 9.9 m/min)	100 – 650 IPM (2.5 – 16.5 m/min)	80 – 450 ipm (2 – 11 m/min)	100 – 600 IPM (2.5 – 15.2 m/min) @ 230V 100 – 400 IPM (2.5 – 10.2 m/min) @ 115V
Nominal OCV Volt/DC	53 Volt	62 Volt		62 Volt
Maximum Plate Thickness	1/8" (3.2 mm)	1/4" (6.4 mm)	3/8" (9.5 mm)	3/8" (12.7 mm @ 230V), 3/16" (4.8 mm @ 115V)
Wire Diameter Range				
Mild Steel:	.023" – .030" (0.6 – 0.8 mm)	.023" – .030" (0.6 – 0.8 mm)	.024" – .030" (0.6 – 0.8 mm)	.023" – .030" (0.6 – 0.9 mm)
Stainless Steel:	.023" – .030" (0.6 – 0.8 mm)	.023" – .030" (0.6 – 0.8 mm)	.024" – .030" (0.6 – 0.8 mm)	.023" – .030" (0.6 – 0.9 mm)
Aluminum:	N/A	.030" – .035" (0.8 – 0.9 mm) [†]	.030" – .035" (0.8 – 0.9 mm)	.030" – 3/64" (0.8 – 1.2 mm) [†]
Flux Cored:	.030" – .035" (0.8 – 0.9 mm)	.030" – .035" (0.8 – 0.9 mm)	.030" – .035" (0.8 – 0.9 mm)	.030" – .045" (0.8 – 1.14 mm)
Spool Size Capacity	4" & 8" (100 & 200 mm)	4" & 8" (100 & 200 mm)	4" & 8", (100 & 200 mm)	4", 8" & 12" (100, 200 & 300 mm)
Power Source Dimensions (H x W x D)	16.2" x 8.3" x 17.7" (410 mm x 210 mm x 450 mm)	16.2" x 8.3" x 17.7" (410 mm x 210 mm x 450 mm)	15" x 8.7" x 19.2" (381 x 221 x 487 mm)	17.3" x 10.2" x 23.6" (440 mm x 260 mm x 600 mm)
Power Source Weight	32.2 lbs (14.6 kg)	32.2 lbs (14.6 kg)	28.7 lbs (13 kg)	57.3 lbs (26 kg)
Warranty Period	3 Years*	3 Years*	3 Years*	3 Years*
Approvals	IEC 60974-1, CSA E60974-1, UL 60974-1, ETL	IEC 60974-1, CSA E60974-1, UL 60974-1, ETL	CSA	IEC 60974-1, CSA E60974-1, UL 60974-1, ETL
Protection Class	IP23S	IP23S	IP21S	IP23S
PRIMARY POWER				
Primary Voltage	115 VAC	208/230 VAC	115/230 VAC	115 VAC, 208/230 VAC
Supply Voltage Range	95 – 140 VAC	208 – 265 VAC	97 – 132 VAC / 195 – 265 VAC	103 – 126 VAC, 208 – 265 VAC
Number of Phases	Single Phase	Single Phase	Single Phase	Single Phase
Supply Frequency	50/60 Hz	50/60 Hz		50/60 Hz
Supply Plug	NEMA 5-20P	NEMA 6-50P	NEMA 5-20P	NEMA 6-50P
Rated kVA	5 kVA @ 140 Amp	9 kVA @ 180 Amp		4.5 kVA (115V), 7 kVA (230V)
Lead Cord Length	10 ft (3 m)	10 ft (3 m)	10 ft (3 m)	10 ft (3 m)
Maximum Input Current	28.4 Amp	35.7 Amp		30.1 Amp (115V), 31.6 Amp (230V)
OPTIONAL ACCESSORIES				
Spool Gun - 1444-0894		✓	✓	✓
Welding/Cutting Cart - 1444-0407	✓	✓	✓	
Basic Utility Cart - 1444-0900	✓	✓	✓	✓
Roll Cage - 1444-0902				✓
Welder Carry Bag - 1421-0099	✓	✓	✓	✓

* Limited Warranty, refer to warranty schedule on FirepowerOnline.com.

Firepower & Tweco MIG Guns with Velocity™ Consumables

Specifications

Part No.	Description	For Use With
1444-0881	Firepower MIG Gun & Lead 180 Amps	MST 140i / MST 180i
1444-0882	Firepower MIG Gun & Lead 220 Amps	MST 220i
1017-1338	Tweco MIG Gun & Lead 180 Amps	MST-200 / FP-200

NOTE: MIG Guns include .023", .030" & .035" Contact Tips and 1/2" Nozzle Flush



WELDING

- Ideal for light to medium gauge work in agriculture, architectural metal work, auto-body, DIY/hobbyist, HVAC, off-road vehicles, RV/campers, production welding, repair maintenance and general light fabrication.
- Operator appeal with ergonomic handle with diamond pattern for better grip and extended trigger length.
- Full range up to 220 Amps @ 40% Duty Cycle.
- Features new high performance Velocity™ Consumables.
- CE rated outputs and duty cycles.
- Rugged with steel spring strain relief.
- Built tough and designed to last.
- Best in class performance.

FIREPOWER MIG 220
220 Amp @ 40% Duty Cycle

FIREPOWER MIG 180
180 Amp @ 40% Duty Cycle

TWECO FUSION MIG 180
180 Amp @ 40% Duty Cycle

Firepower Velocity™ MIG Welding Consumables

- Easy to change Velocity tips – no threads, no tools required.
- No diffuser – lower cost of ownership.
- Fewer consumable parts to replace – less complexity.
- Optimized wire feedability with centered liner.
- Solid copper conductive path with fewer connections – smooth, stable arc.
- Smooth, superior arc performance with less spatter, less clean-up.

STANDARD VELOCITY NOZZLE

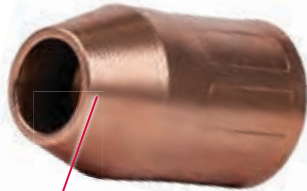

Heavy Duty Copper

VELOCITY CONTACT TIP

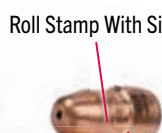

Large Copper to Copper Surface Contact for Superior Thermal and Electrical Efficiency

CONDUCTOR TUBE

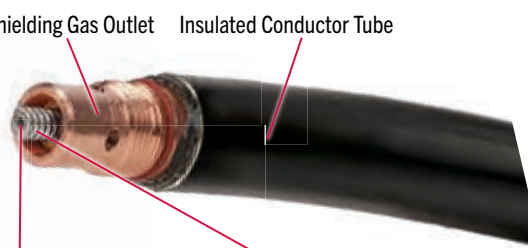

Perfectly Centered Liner

Conduit Liner Seats Inside the Tip for Superior Feedability

Roll Stamp With Size Shielding Gas Outlet Insulated Conductor Tube

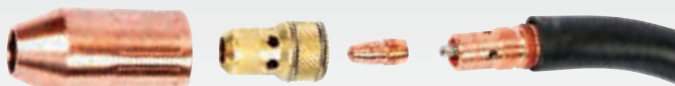

1444-0879

1444-0876

Velocity Slip Fit Assembly

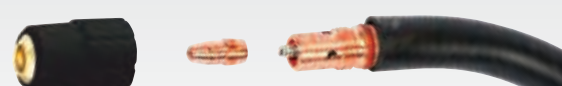

1444-0888

Velocity Flux Cored Assembly (Gasless)



FP-135 MIG/Flux Cored Welding System

Specifications

Part No.	Description
1444-0326	FP-135, MIG/Flux-Cored Welding System
1444-0346	FP-135, Welding Kit

FLUX CORED	FLUX CORED	135 AMPS	15 AMP 115 VAC	28 % @117 AMPS 19.85 VOLTS	1/4" PLATE (6.4 mm) SINGLE PASS ↑
STEEL STAINLESS STEEL	UP TO .035" (0.9 mm)	ARGON CO ₂		6000 WATTS	



FP-135, Welding Kit (1444-0346)

PACKAGE INCLUDES:

- FP135 MIG Welder
- Auto-Darkening Helmet
- MIG Welder Cart
- Chipping Hammer
- Wire Brush
- Regulator

FEATURES

- FP-135 MIG/Flux-Cored Welder delivers a versatile and effective welding performance.
- Simple operation and easy to use key set up chart
- Operates from standard 115V household outlet and delivers 135 Amps

INCLUDES

Tweco Gun, return cable & clamp, 6 ft (1.8 m) power cord and NEMA 5-15P 115V plug, .030" spool of flux-cored wire and an operating manual.

APPLICATIONS

Home DIY Hobbyist, Farm/Ranch, Maintenance & Repairs, General light duty fabrication & repair.

MACHINE SPECIFICATIONS

Maximum output	135 Amp
Duty cycle @ 140°F	40% @ 90 Amp at 18V
Current range	20-135 Amp
Number of voltage settings	4
Maximum plate thickness	1/4" (6.4 mm)
Wire diameter range	.023" - .035" (0.6 - 0.9 mm)
Dimensions (H x W x D)	12.75" x 9.75" x 17.35" (375 mm x 250 mm x 440 mm)
Weight	56 lbs (25.5 kg)
Maximum Input Current	50A
Approvals	CSA, ETL

FP-165 MIG/Flux Cored Welding System

Specifications

Part No.	Description
1444-0328	FP-165, MIG/Flux-Cored Welding System
1444-0348	FP-165, Welding Kit

FLUX CORED	FLUX CORED	165 AMPS	50 AMP 208/230 VAC	18 % @140 AMPS 21 VOLTS	5/16" PLATE (7.9 mm) SINGLE PASS ↑
STEEL STAINLESS STEEL	UP TO .035" (0.9 mm)	ARGON CO ₂			7000 WATTS



FP-165 Welding Kit (1444-0348)

PACKAGE INCLUDES:

- FP165 MIG Welder
- Auto-Darkening Helmet
- MIG Welder Cart
- Chipping Hammer
- Wire Brush
- Regulator

FEATURES

- FP-165 MIG/Flux-Cored Welder delivers a very versatile and effective welding performance
- Simple operation and easy to use key set up chart
- Operates from standard 230V outlet and delivers 165 Amps

INCLUDES

Tweco Gun, return cable & clamp, 6 ft (1.8 m) power cord and NEMA 6-50P 230V plug, .030" spool of flux-cored wire and an operating manual.

APPLICATIONS

Maintenance & Repairs, Farm/Ranch, Home DIY Hobbyist, General light duty fabrication & repair.

MACHINE SPECIFICATIONS

Maximum output	165 Amp
Duty cycle @ 140°F	20% @ 130 Amp at 30V
Current range	20-165 Amp
Number of voltage settings	4
Maximum plate thickness	5/16" (7.9 mm)
Wire diameter range	.023" - .035" (0.6 - 0.9 mm)
Dimensions (H x W x D)	12.75" x 9.75" x 17.35" (375 mm x 250 mm x 440 mm)
Weight	60 lbs (27.3 kg)
Maximum Input Current	35A
Approvals	CSA, ETL

FP-200 MIG/Flux Cored Welding System

Specifications

Part No.	Description
1444-1200	FP-200 System Package



ESAB Designed Firepower FP-200 inverter-based welding system is ready to tackle steel, stainless and aluminum projects. It's professional-grade arc characteristics and full-featured digital controls enable you to fine-tune arc performance to deliver superior welding results. It weighs just 29 lbs. and offers dual-voltage 120/230V flexibility. Take this welder wherever work takes you – around the shop, in the field or at home in your garage.

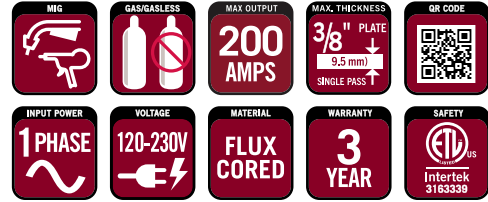

INCLUDES

FP-200 package includes: Power Source, Tweco Fusion 180 Velocity MIG Gun with Tweco Connection & Velocity Consumables, Ground Clamp, Argon/CO2 Regulator, Power Adaptor and Sample Wire Spool.

APPLICATIONS

Automotive, Agricultural Equipment, Civil Constructio, Repair and Maintenance, Light Fabrication, Automotive Bodies, HVAC

MACHINE SPECIFICATIONS

Maximum Output	200 Amp
MIG (GMAW/FCAW)	90A/18.5V @40% Duty Cycle
Welding Output @104°F (40°C)	200A/24V @15% Duty Cycle
Current Range	30 – 200 Amps
MIG Welding Voltage Range	115V: 12V-20V 230V: 12V-24V
Wirefeed Speed Range	80 – 450 ipm (2 – 11 m/min)
Nominal OCV Volt/DC	
Maximum Plate Thickness	3/8 in. (9.5 mm) @ 230V

OPTIONS & ACCESSORIES

1027-1397	Tweco Spool Gun 160 A, 3.6 m (12 ft) (required for Al MIG welding)
0781-9411	Victor Argon Flow Gauge Regulator GF-250-50-580
0781-9832	Firepower Argon/CO2 Flowgauge Regulator, 580 CGA, 10-150 PSIG
W4013900	Gas Hose, 3.8 m (12.5 ft), Male 5/8-18UNF
W4014000	Power Adapter, 230 V to 120 V, 15 A
1444-0900	Basic Utility Cart



MIG Spool Gun 160A Euro

Specifications

Part No.	Description	For Use With
1444-0894	MIG Spool Gun 160 Amps	MST 180i / MST 220i



Euro-Kwik Connector



MIG 	MAX OUTPUT 160 AMPS	MATERIALS ALUMINUM	FLEXIBLE GASES INERT ARGON
----------------	---	------------------------------	---

FEATURES

- Interfaces with Firepower MST 180i and 220i 3-in-1 Welders
- Rated 20% Duty Cycle at 160 Amps
- Uses 11-Series Tips and Nozzles

APPLICATIONS

The MIG Spool Gun allows the use of Aluminum in welding applications.

CONTENTS

Firepower Spool Gun 160A, Custom Carrying Case, 12 ft (4 m) Cable with Euro-Kwik Connector, Conductor Tube, 2 - 0.023" (0.6 mm) 11-Series Contact Tips, 4 - 0.035" (0.9 mm) 11-Series Contact Tips, 2 - 1/2" (12.7 mm) 11-Series Nozzle, 2 - Gas Diffusers

*Wire spool not included

MIG Spool Gun for MST-200 and FP-200

Specifications

Part No.	Description	For Use With
1027-1397	Tweco MIG Spool Gun 160 Amps	MST-200 / FP-200



MIG 	MAX OUTPUT 160 AMPS	MATERIALS ALUMINUM	FLEXIBLE GASES INERT ARGON
----------------	---	------------------------------	---

FEATURES

- Interfaces with Firepower MST-200 and FP-200 Welders
- Rated 20% Duty Cycle at 160 Amps
- Uses 11-Series Tips and Nozzles

APPLICATIONS

The MIG Spool Gun allows the use of Aluminum in welding applications.

CONTENTS

Tweco Spool Gun 160A, Custom Carrying Case, 12 ft (4 m) Cable with Euro-Kwik Connector, Conductor Tube, 2 - 0.023" (0.6 mm) 11-Series Contact Tips, 4 - 0.035" (0.9 mm) 11-Series Contact Tips, 2 - 1/2" (12.7 mm) 11-Series Nozzle, 2 - Gas Diffusers

MIG (GMAW) WELDING WIRE SELECTION

AWS Wire Class	Weld Material	Shield Gas Required	Wire Type	Polarity	Diameter
WIRE MIG ER 70S-6	Mild Steel	Yes	Solid Steel	DC Reverse (+)	.023 .030 .035 .045
WIRE MIG ER 308L	Stainless Steel	Yes	Solid Stainless	DC Reverse (+)	.030
WIRE MIG ER 4043 WIRE MIG ER 5356	Aluminum	Yes	Solid Aluminum	DC Reverse (+)	.030 .035
WIRE * MIG E71 T-GS	Mild Steel	No	Flux Cored Gasless	DC Straight (-)	.030 .035

MIG WIRE AMPERAGE RANGE

AWS Wire Class	Wire Diameter (in.)	Amperage Range							
		MIN.	50A	100A	150A	200A	250A	300A	MAX.
WIRE MIG ER 70S-6	SOLID WIRE .023			.025" - .050" †					
	MILD STEEL .030			.031" - 1/8" †					
	.035			.050" - 1/2" †					
	.045			.078" - 1/2" †					
WIRE MIG ER 308L	SOLID WIRE .030		.031" - 1/8" †						
	STAINLESS STEEL								
WIRE MIG ER 5356	SOLID WIRE .030			.031" - 1/8" †					
	ALUMINUM .035			.050" - 1/2" †					
WIRE * MIG E71 T-GS	FLUX CORED .030			.031" - .078" †					
	MILD STEEL .035			.037" - 3/16" †					

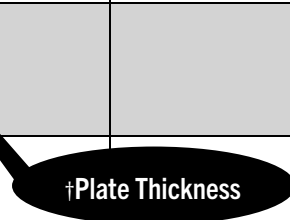

†(Recommend multi pass over 3/16" plate thickness)

*E71T-GS, Single Pass wire only.

WELDING TIPS

- Keep the torch handle at a 45° angle with respect to the metal. Maintain the nozzle about 1/4" (0.6 mm) from the surface.
- Move the torch handle with prudence and steadiness.
- Avoid MIG welding in areas with too much draft. Too much draft blows away the shielding gas from the weld pool and may cause porosity in the weld.
- Keep the wire and its cover clean. DO NOT use rusted wire.
- Avoid sharp bends and kinks on the MIG gun cable.
- If possible, clean the wire liner with compressed air when replacing the wire spool.
- Periodically, remove the dust using low pressure air or nitrogen (2-3 Bar/30-45 psi) from the inside of the power source, to assure adequate heat dissipation from power source during operation.

Tweco® MIG 11 & 14-Series Contact Tips

Specifications

Part No.	Description	Part No.	Description
1444-0025	MIG 11-Series .023" Contact Tip 10 PK	1444-0220	MIG 14-Series .023" Contact Tip 10 PK
1444-0026	MIG 11-Series .030" Contact Tip 10 PK	1444-0221	MIG 14-Series .030" Contact Tip 10 PK
1444-0027	MIG 11-Series .035" Contact Tip 10 PK	1444-0222	MIG 14-Series .035" Contact Tip 10 PK
1444-0029	MIG 11-Series .040" Contact Tip 10 PK	1444-0224	MIG 14-Series .045" Contact Tip 10 PK



FEATURES

- 10 Copper Tips Per Pack

Tweco MIG 11 & 14-Series Nozzles

Specifications

Part No.	Description	Part No.	Description
1444-0050	MIG 11-Series 3/8" Flush Nozzle	1444-0140	MIG 14-Series 1/2" Flush Nozzle
1444-0051	MIG 11-Series 1/2" Flush Nozzle	1444-0141	MIG 14-Series 5/8" Flush Nozzle
1444-0052	MIG 11-Series 5/8" Flush Nozzle	1444-0142	MIG 14-Series 5/8" Flush Arc Nozzle



FEATURES

- Heavy Duty Copper Nozzle

APPLICATIONS

Used with 11 & 14-Series MIG Guns for MIG Welding.

MIG Diffusers & Insulators

Specifications

Part No.	Description	Part No.	Description
1444-0080	MIG Diffuser – 51 for 180 Amp Gun 2 PK	1444-0265	MIG Diffuser – 54 for 400 Amp Gun 2 PK
1444-0082	MIG Diffuser – 35-50 Male Threads for Tweco Style Gun	1444-0489	MIG Diffuser – 35 Female Threads for Tweco Style Gun
1444-0165	MIG Diffuser – 52 for 250 Amp Gun 2 PK	1444-0075	MIG Insulator – For 250 Amp Gun 2 PK
		1444-0261	MIG Insulator – For 400 Amp Gun 2 PK



DIFFUSER FEATURES

- Strong Brass Construction

INSULATOR FEATURES

- Insulator Used by Slipping Over Nozzle

APPLICATIONS

Used with 11 & 14-Series MIG Guns for MIG Welding.

Tweco MIG Velocity™ Contact Tips

Specifications

Part No.	Description
1444-0890	MIG Velocity .023" Contact Tip 10 PK
1444-0891	MIG Velocity .030" Contact Tip 10 PK
1444-0892	MIG Velocity .035" Contact Tip 10 PK
1444-0893	MIG Velocity .045" Contact Tip 10 PK



FEATURES

- 10 Copper Tips Per Pack

APPLICATIONS

Used with Velocity® Series MIG Guns for MIG Welding.

Tweco MIG Velocity Nozzles

Specifications

Part No.	Description	Part No.	Description
1444-0885	MIG Velocity 3/8" Flush Nozzle	1444-0888	MIG Velocity Flux Cored Nozzle
1444-0886	MIG Velocity 1/2" Flush Nozzle	1444-0889	MIG Velocity 3/4" Spot Nozzle
1444-0877	MIG Velocity 1/2" Recess Nozzle	1444-0876	MIG Velocity Adjustable Slip Fit Tip Holder
1444-0887	MIG Velocity 5/8" Flush Nozzle	1444-0879	MIG Velocity Adjustable Slip Fit Nozzle
1444-0878	MIG Velocity 5/8" Recess Nozzle		



Flush & Recessed Nozzle



Spot Nozzle



Slip Fit Tip Holder



Slip Fit Nozzle



FEATURES

- Heavy Duty Copper Nozzle

APPLICATIONS

Used with Velocity Series MIG Guns for MIG Welding.

TIG 140 ACDC Welding System

Specifications

Part No.	Description
1442-0030	TIG 140 ACDC Welding System

WELDING



TIG HF START	STICK	CURRENT AC DC	GAS	INPUT PLUG 15 AMP 115 VAC	MAX. THICKNESS 3/16" PLATE (4.8 mm) SINGLE PASS
TIG 140 AMPS	STICK 90 AMPS	MATERIALS STEEL STAINLESS STEEL ALUMINUM	FLEXIBLE GASES INERT ARGON	WARRANTY 3 YEAR	GENERATOR 2800 WATTS

FEATURES

- HF TIG (GTAW), Lift TIG (GTAW), Stick (SMAW)
- 140 Amps of TIG Welding Output
- Smooth & Stable Arc Performance
- Includes 8-Pin Receptacle for On/Off & Amp Control at the TIG Torch
- Gas Solenoid Valve is Built-in
- Lightweight and Portable Inverter Design

INCLUDES

TIG 140 ACDC System, Ground Clamp & Electrode Holder, TIG Torch & Accessories, Flow Meter Regulator, 3 trigger Modules, Flow Gauge Hose 12.5 ft (3.8 m), 10 ft (3 m) Power Cord & NEMA 5-20P 115V AC Plug, Shoulder Strap and Operation Manual & CD

APPLICATIONS

TIG WELDING (GTAW) - The TIG 140 ACDC is capable of TIG welding on a wide range of materials from aluminum to mild and stainless steel. Delivering superior TIG welding performance with a smooth and stable arc down to 10 Amps.

STICK WELDING (SMAW) - The TIG 140 ACDC delivers up to 140 Amps of welding power and provides professional performances on a wide variety of materials. It's lightweight and portable with the ability to handle the toughest jobs.

MACHINE SPECIFICATIONS

Maximum output	140 Amp
STICK (SMAW) Welding	90A @ 20%, 23.6V
Output @104°F (40°C)	50A @ 60%, 22.0V; 40A @ 100%, 21.6V
TIG (GMAW) Welding	140A @ 20%, 15.6V
Output @104°F (40°C)	75A @ 60%, 13.0V; 60A @ 100%, 12.4V
Current Range	Stick: 10 - 90A TIG: 10 - 140A
Dimensions (H x W x D)	15.75"×9.45"×18.7" (400 mm×240 mm×475 mm)
Weight	48.4 lbs (22 kg)
Phase	1 PH
Maximum Input Current	20 Amp
Approvals	IP23S, EN 60974-1, CSA, ETL

TIG 200 ACDC Welding System

Specifications

Part No.	Description
1442-0032	TIG 200 ACDC Welding System



TIG HF START	STICK	CURRENT AC DC	GAS	INPUT PLUG 50 AMP 208/230 VAC	MAX. THICKNESS 1/4" PLATE (6.4 mm) SINGLE PASS ↑
200 AMPS	170 AMPS	MATERIALS STEEL STAINLESS STEEL ALUMINUM	FLEXIBLE GASES INERT ARGON	WARRANTY 3 YEAR	GENERATOR 9500 WATTS

FEATURES

- HF TIG (GTAW), Lift TIG (GTAW), Stick (SMAW)
- 200 Amps of TIG Welding Output
- Smooth & Stable Arc Performance
- Includes 8-Pin Receptacle for On/Off & Amp Control at the TIG Torch
- Gas Solenoid Valve is Built-in
- Lightweight and Portable Inverter Design

INCLUDES

TIG 200 ACDC System, Ground Clamp & Electrode Holder, TIG Torch & Accessories, Flow Meter Regulator, 3 trigger Modules, Flow Gauge Hose 12.5 ft (3.8 m), 10 ft (3 m) Power Cord & NEMA 6-50P 230V AC Plug, Shoulder Strap and Operation Manual & CD

APPLICATIONS

TIG WELDING (GTAW) - The TIG 200 ACDC is capable of TIG welding up to 200 Amps and a wide range of materials from aluminum to mild and stainless steel. Welding up to 1/4" plate, this machine can deliver superior TIG welding performance with a smooth and stable arc down to 10 Amps.

STICK WELDING (SMAW) - The TIG 200 ACDC delivers up to 170 Amps of welding power and provides professional performances on a wide variety of materials. With the 208/230V output it has more power to handle the biggest jobs.

MACHINE SPECIFICATIONS

Maximum output	200 Amp
STICK (SMAW) Welding Output @104°F (40°C)	170A / 26.6V @ 16% Duty Cycle 150A / 26V @ 25% Duty Cycle 150A / 26V @ 100% Duty Cycle
TIG (GMAW) Welding Output @104°F (40°C)	200A / 18V @ 20% Duty Cycle 180A / 17.2V @ 25% Duty Cycle 150A / 16V @ 35% Duty Cycle
Current Range	Stick: 5-170 Amps TIG: 10-200 AC 5-200 DC
Dimensions (H x W x D)	15.75" x 9.45" x 18.7" (400 mm x 240 mm x 475 mm)
Weight	48.4 lbs (22 kg)
Phase	1 PH
Maximum Input Current	35.6 Amp
Approvals	IP23S, EN 60974-1, CSA, ETL



TIG Torch

Specifications

Part No.	Description	For Use With
1442-0053	TIG Torch 17V	95 S & TIG 160S



FEATURES

- 50 mm Dinse Connector (TIG 160S) with 25 mm Dinse Adapter (95S)
- Includes Valve Knob for Shielding Gas
- 12.5' (3.8 m) Lead Length
- Gas Hose attached to Torch

APPLICATIONS

Designed for use with Thermal Arc® 95 S & FP TIG 160S.

Note: TIG accessories not included.



TIG Torch & Accessories

Specifications

Part No.	Description	For Use With
1442-0020	TIG Torch 17V (with 1442-0065 Accessories)	MST 140i & MST 180i
1442-0021	TIG Torch 26V (with 1442-0066 Accessories)	MST 220i



FEATURES

- 50 mm Dinse Connector (25 mm Dinse Adaptor on 1442-0020 for MST 140i)
- 12' (3.6 m) Lead Length
- Valve Knob for Shielding Gas
- On/Off Switch
- Includes Set of Accessories: 2 Collets, 2 Collet Bodies, 2 Cup Aluminas, 2 Tungsten Electrodes, and a Short and Long Back Cap

APPLICATIONS

Designed for use with MST 140i, MST 180i, MST 220i and Fabricator 141i, 181i & 211i.



TIG Torch SWCUR

Specifications

Part No.	Description	For Use With
1442-0022	TIG Torch 17 SWCUR	TIG 140 ACDC, 141 ACDC
1442-0050	TIG Torch 26 SWCUR	TIG 200 ACDC, 186 ACDC



FEATURES

- 50 mm Dinse Connector
- 12.5' (3.8 m) Lead Length
- No Shielding Gas Valve on Torch (Gas is controlled by power supply)
- Foot Switch Control Not Needed, but can be used
- TIG Torch 17: On/Off switch with current control
- TIG Torch 26: On/Off switch with current control and 2 additional interchangeable Amp modules

APPLICATIONS

Designed for use with TIG 140 ACDC, TIG 200 ACDC, and Fabricator 252i.

Note: TIG accessories not included.

TIG Torch MST-200

Specifications

Part No.	Description	For Use With
W4013802	Tweco® Tig Torch 17V	MST-200



FEATURES

- 50 mm Dinse Connector
- 12' (3.6 m) Lead Length
- Valve Knob for Shielding Gas
- On/Off Switch
- Includes Set of Accessories: 2 Collets, 2 Collet Bodies, 2 Cup Aluminas, 2 Tungsten Electrodes, and a Short and Long Back Cap

APPLICATIONS

Designed for use with MST-200.

ALUMINUM (NON FERROUS METALS) TIG (GTAW) WELDING PARAMETERS (AC OUTPUT)

Base Metal Thickness	Tungsten Type (recommended)	Tungsten Electrode Dia.	Filler Rod Dia. (if required)	AC Amps Aluminum	Argon Gas Flow Rate	Weld Joint Type
.040" (1.0 mm)	Ceriated	.040" (1.0 mm) 1442-0059	1/16" (1.6 mm)	30-45 40-60	10 CFM (5 LPM) 13 CFM (6 LPM)	Butt/Corner
.045" (1.2 mm)				35-50 45-70	13 CFM (6 LPM)	Lap/Fillet
1/16" (1.6 mm)	Ceriated	1/16" (1.6 mm) 1442-0060	1/16" (1.6 mm)	60-85	15 CFM (7 LPM)	Butt/Corner
1/8" (3.2 mm)				70-95		Lap/Fillet
1/8" (3.2 mm)	Ceriated	3/32" (2.4 mm) 1442-0061	3/32" (2.4 mm)	125-150	21 CFM (10 LPM)	Butt/Corner
						Lap/Fillet
3/16" (4.8 mm)	Ceriated	1/8" (3.2 mm) 1442-0062	1/8" (3.2 mm)	130-160	21 CFM (10 LPM)	Butt/Corner
				180-225		Lap/Fillet

(Requirements may vary slightly by power supply)

STEEL & STAINLESS STEEL (FERROUS METALS) TIG (GTAW) WELDING PARAMETERS (DC OUTPUT)

Base Metal Thickness	Tungsten Type (recommended)	Tungsten Electrode Dia.	Filler Rod Diameter	DC Amps Mild Steel	DC Amps Stainless Steel	Argon Gas Flow Rate	Weld Joint Type
.040" (1.0 mm)	Ceriated	.040" (1.0 mm) 1442-0059	1/16" (1.6 mm)	35-45	20-30 30-45	10 CFM (5 LPM) 13 CFM (6 LPM)	Butt/Corner
.045" (1.2 mm)				40-50	25-35 35-50	13 CFM (6 LPM)	Lap/Fillet
1/16" (1.6 mm)	Ceriated	1/16" (1.6 mm) 1442-0060	1/16" (1.6 mm)	60-70 80-100	40-60 65-85	15 CFM (7 LPM)	Butt/Corner
1/8" (3.2 mm)			3/32" (2.4 mm)	70-90 90-115	50-70 90-110		Lap/Fillet
3/16" (4.8 mm)	Ceriated	3/32" (2.4 mm) 1442-0061	1/8" (3.2 mm)	115-135	100-125	21 CFM (10 LPM)	Butt/Corner
				140-165	125-150		Lap/Fillet
1/4" (6.4 mm)	Ceriated	1/8" (3.2 mm) 1442-0062	5/32" (4.0 mm)	160-175	135-160	21 CFM (10 LPM)	Butt/Corner
				170-200	160-180		Lap/Fillet

(Requirements may vary slightly by power supply)

TIG Collets

Specifications

Part No.	Description
1442-0003	TIG Collet .040" 5 PK
1442-0004	TIG Collet 1/16" 5 PK
1442-0005	TIG Collet 3/32" 5 PK
1442-0054	TIG Collet 1/8" 5 PK



FEATURES

- Standard Grade Brass Collets

APPLICATIONS

Holds Tungsten electrode in place and creates electrical contact for current transfer in TIG Welding. Used with Collet Body.

TIG Collet Bodies

Specifications

Part No.	Description
1442-0006	TIG Collet Body .040" 5 PK
1442-0007	TIG Collet Body 1/16" 5 PK
1442-0008	TIG Collet Body 3/32" 5 PK
1442-0055	TIG Collet Body 1/8" 5 PK



FEATURES

- Standard Grade Brass Collet Bodies

APPLICATIONS

Fits its' respective size Collet and Tungsten electrode. Used with Collet.

TIG Cup Aluminas

Specifications

Part No.	Description
1442-0009	TIG Cup Alumina #4 10 PK
1442-0010	TIG Cup Alumina #5 10 PK
1442-0011	TIG Cup Alumina #6 10 PK
1442-0057	TIG Cup Alumina #7 10 PK



FEATURES

- Ceramic Quality Cup Aluminas

APPLICATIONS

Protects the Collet Body and directs gas flow when TIG Welding.

Tungsten 2% Ceriated

Specifications

Part No.	Description	Output Amps
1442-0059	Tungsten 2% .040" X 7" Ceriated, 10 PK	20-70†
1442-0060	Tungsten 2% 1/16" X 7" Ceriated, 10 PK	40-115†
1442-0061	Tungsten 2% 3/32" X 7" Ceriated, 10 PK	100-150†
1442-0062	Tungsten 2% 1/8" X 7" Ceriated, 10 PK	130-225†



FEATURES

- Best for DC Welding with Low Amperage

APPLICATIONS

Used when TIG Welding. Can be used for AC or DC Welding.



TIG Accessory Kits

Specifications

Part No.	Description	Output Amps
1442-0065	TIG Accessory Kit .040" & 1/16"	20-115†
1442-0066	TIG Accessory Kit 3/32" & 1/8"	100-225†



APPLICATIONS

The TIG Accessory Kit Comes with All Consumables Necessary for TIG Torch operation.

CONTENTS: 1442-0065 - .040" & 1/16"

- Collets .040" & 1/16"
- Collet Bodies .040" & 1/16"
- Cup Aluminas # 4 & 5
- Tungsten Ceriated .040" & 1/16"

CONTENTS: 1442-0066 - 3/32" & 1/8"

- Collets 3/32" & 1/8"
- Collet Bodies 3/32" & 1/8"
- Cup Aluminas # 6 & 7
- Tungsten Ceriated 3/32" & 1/8"



TIG Short Back Cap

Specifications

Part No.	Description
1442-0002	TIG Short Back Cap 2 PK



FEATURES

- Short Back Cap for TIG Welding in Smaller More Restricted Areas.

APPLICATIONS

Used to tighten the Collet which keeps the Tungsten electrode from moving while welding.



†Output Amps required depends on material type and thickness being welded.
SEE CHART ON PAGE 13

Welding/Cutting Cart

Specifications

Part No.	Description
1444-0407	Welding/Cutting Cart



FEATURES

- Fits Many Firepower Welders/Cutters (not MST 220i)
- Accommodates up to 9" (229 mm) diameter Cylinder with Included Chain
- Holds Welders/Cutters on Top Tray
- Sturdy and Durable Construction

FOR USE WITH

- MST 140i & 180i, FP-95, 125, 135, 165
Thermal Arc 95 S, TIG 160S, TIG 140 ACDC & 200 ACDC
Cutmaster 42, AirCut 15C, Fabricator 141i & 181i

Basic Utility Cart

Specifications

Part No.	Description
1444-0900	Basic Utility Cart



FEATURES

- Sturdy handle makes transporting welders/cutters easy
- Designed for most portable Welding/Cutting systems
- Rugged Solid Steel Construction
- Easy-rolling 8" (203 mm) diameter wheels
- 3" (76 mm) front-mounted casters
- Accommodates up to 9" (229 mm) diameter Cylinder with Included Chains

FOR USE WITH

- MST 140i, 180i, 220i, FP-95, 125, 135, 165
Thermal Arc 95 S, TIG 160S, TIG 140 ACDC & 200 ACDC
Cutmaster 42, 52, 82, CutSkill C-20A, C-35A, C-70A
AirCut 15C, Fabricator 141i, 181i, & 211i, Fabricator 186 ACDC

Roll Cage

Specifications

Part No.	Description	For Use With
1444-0902	Roll Cage (MST 220i Only)	MST 220i



FEATURES

- Rugged Steel Construction

APPLICATIONS

Roll Cage for MST 220i system, which protects and makes carrying the unit easier.

Welder Carry Bag

Specifications

Part No.	Description	For Use With
1421-0099	Welder Carry Bag	MST 140i, MST 180i & MST 220i



FEATURES

- High Quality Made Bag
- Clear See-Through Documentation Pouch
- Reinforced Comfortable Handle
- Large Rugged Zipper

APPLICATIONS

Fits all Firepower MST 3-in-1 Systems.

MIG/TIG Parts Storage Box

Specifications

Part No.	Description	For Use With
1421-0098	MIG/TIG Parts Storage Box	MIG/TIG Consumables



FEATURES

- Rugged Construction
- Easy-To-Use Snap Locking Closure System

APPLICATIONS

Customizable layout featuring removable storage dividers.



Ground Clamp & Lead

Specifications

Part No.	Description	For Use With
1443-0491	Ground Clamp & Lead 200 A 25 mm Dinse	MST 140i & TIG 95S
1443-0495	Ground Clamp & Lead 200 A 50 mm Dinse	MST 180i, MST 220i, TIG 160S, TIG 140 ACDC, TIG 200 ACDC



Steel Ground Clamp

FEATURES 1443-0491

- Steel Levers
- Heavy Duty Spring
- Attached to a 6' (1.8 m) Lead
- 25 mm Dinse Connector

Copper Ground Clamp

FEATURES 1443-0495

- Rugged and Reliable Design
- Copper Cast Jaws
- Attached to a 10' (3 m) Lead
- 50 mm Dinse Connector

APPLICATIONS

The industry standard for your stick electrode welding applications with 200 Amp capacity

Electrode Holder

Specifications

Part No.	Description	Use
1443-0015	Electrode Holder 200 Amps	Stick Welding
1443-0016	Electrode Holder 300 Amps	



FEATURES

- Reliable Tong Design
- Fiberglass Reinforced Insulators
- Copper Alloy Body
- Multi-Position Jaw Pattern
- Fully Insulated Spring

APPLICATIONS

The industry standard for your stick electrode welding applications with 200 or 300 Amp capacity.

Electrode Holder & Lead

Specifications

Part No.	Description	For Use With
1443-0490	Electrode Holder & Lead 200 Amps	MST 140i & TIG 95S
1443-0494	Electrode Holder & Lead 250 Amps	MST 180i, MST 220i, TIG 160S, TIG 140 ACDC, TIG 200 ACDC



Electrode Holder 200 Amps

Electrode Holder 250 Amps

FEATURES 1443-0490

- 25 mm Dinse Connector
- Reliable Tong Design
- Fully Insulated Spring
- Attached to a 9' (2.7 m) lead
- 200 Amp

FEATURES 1443-0494

- 50 mm Dinse Connector
- Reliable Tong Design
- Fully Insulated Spring
- Attached to a 9' (2.7 m) lead
- 250 Amp

APPLICATIONS

The industry standard for your stick electrode welding applications

TIG Foot Control

Specifications

Part No.	Description	For Use With
1442-0025	TIG Foot Control 15' 8-Pin	MST 140i, MST 180i, MST 220i, TIG 140 ACDC, TIG 200 ACDC, Fabricators 141i, 181i, 211i, 252i, & Thermal Arc 186 ACDC
W4014450	Tweco TIG Foot Control 8-pin	MST-200, FP-200



FEATURES

- Comes with 15' Cable and 8-Pin Amphenol Plug

APPLICATIONS

Provides On/Off contactor and amperage control for your Firepower MST 140i, 180i, and 220i systems, and TIG 140 ACDC & TIG 200 ACDC.

Firepower® Oxy-Fuel

Performance, Value and Ease of Use

The latest Firepower Oxy-Fuel range offers superior performance, excellent value and ease-of-use that helps the craftsman get the job done right the first time. The authentic Victor® torch and regulator range is the heart of this new family, with system solutions and components designed for individual needs.

This product range will perform a wide spectrum of tasks, from brazing sheet metal to cutting up to six inch thick steel. Professionals from auto repair, construction, farm/ranch, skilled trades and serious do-it-yourselfers will find the superior solutions they need.

Firepower draws on the heritage and quality of Victor gas equipment, and has the advantage of utilizing that excellence in product support, service, and application know-how.

OXY-FUEL



CUTTING

ACETYLENE CUTTING TIPS



OxyFuel 350
SERIES 1
or
OxyFuel 250
SERIES 3

NATURAL GAS CUTTING TIPS



OxyFuel 350
SERIES 1
or
OxyFuel 250
SERIES 3

*NOTE: For use with fuel gas other than Acetylene, proper tips, regulators or T-grade hoses may be required.



HEATING



#4 - 0323-0270



#6 - 0323-0271



WELDING



#0 - 0323-0360



#1 - 0323-0361



#3 - 0323-0363



#4 - 0323-0364

Oxy-Fuel Regulators

OXYGEN

0781-9829
350

0781-9826
250



ACETYLENE

0781-9830
350

0781-9827
250



Full range of Cutting, Heating and Welding products for multiple gas types.

A flexible and versatile platform catered to applications from brazing thin sheet metal to cutting six inch thick steel we have the solution...

PROPYLENE CUTTING TIPS

OxyFuel 350 SERIES 1
or
OxyFuel 250 SERIES 3

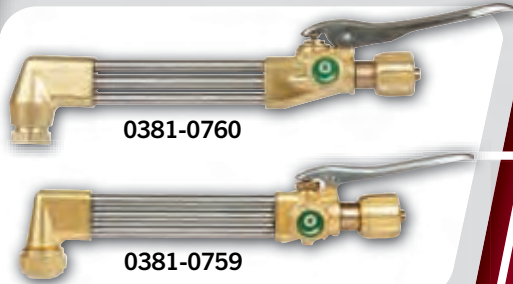

#8 - 0323-0272



Note:

1. "W" Nozzles Fits 7/8" Thread OxyFuel 250-350 Handles
2. "W-1" 5/8" Thread OxyFuel 150 Nozzles Also Available
3. Heating Nozzles Are Not Recommended For Use With Tote Outfits, and 0916-0032 and 0916-0033 Tanks.



#2 - 0323-0362

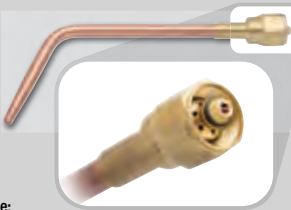

Note:

1. "W" Nozzles Fits 7/8" Thread OxyFuel 250-350 Handles
2. "W-1" 5/8" Thread OxyFuel 150 Nozzles Also Available

#5 - 0323-0365



0382-0358
OXYFUEL 250/350 HANDLE

0656-0008
FLASHBACK
ARRESTORS

OXY-FUEL

Oxy-Fuel Outfits

250 MEDIUM DUTY



0384-2571 BOX
0384-2572 CLAMSHELL

350 HEAVY DUTY



0384-2682 BOX
0384-2684 CLAMSHELL

OxyFuel 350 Heavy Duty Outfit

Specifications

Part No.	Description	Fuel Gas Type
0384-2682	OxyFuel 350 Heavy Duty Outfit (Box)	Acetylene
0384-2684	OxyFuel 350 Heavy Duty Outfit (Clamshell)	Acetylene



FEATURES

- High performance, complete system that meets or exceeds industry standards
- Superior 350 Series high flow color coded regulators
- Complete handle and cutting attachment optimized for multiple gases
- Up to 6" cutting capacity and 1/2" welding
- Flexible versatile platform
- Includes flashback arrestors
- Two year warranty

APPLICATIONS

The OxyFuel 350 Heavy Duty Outfit contains premium performance components for professional grade use. Optimized for 1" cut and 1/8" weld out of the box. Suitable for medium to heavy duty fusion welding, braze welding, brazing, heating and hand cutting applications.

CONTENTS

Oxygen/Acetylene 350 Series Regulators, 350 Series Cutting Attachment and Handle, Flashback Arrestors, Dual R-Grade Hose 3/16" x 12.5 ft., #1 Cutting Tip, #2 Welding Nozzle, Striker, Protective eyewear and Manual.



OxyFuel 250 Medium Duty Outfit

Specifications

Part No.	Description	Fuel Gas Type
0384-2571	OxyFuel 250 Medium Duty Outfit (Box)	Acetylene
0384-2572	OxyFuel 250 Medium Duty Outfit (Clamshell)	Acetylene



FEATURES

- High performance, complete system that meets or exceeds industry standards
- High performance 250 Series color coded regulators
- Complete handle and cutting attachment optimized for multiple gases
- Up to 5" cutting capacity and 1/2" welding
- Flexible versatile platform
- Two year warranty

APPLICATIONS

The OxyFuel 250 Medium Duty Outfit contains premium performance components for the value driven consumer. Optimized for 1/2" cut and 5/64" weld out of the box. Suitable for light to medium duty fusion welding, braze welding, brazing, heating and hand cutting applications.

CONTENTS

Oxygen/Acetylene 250 Series Regulators, 250 Series Cutting Attachment and Handle, Dual R-Grade Hose 3/16" x 12.5 ft., #0 Cutting Tip, #0 Welding Nozzle, Striker, Protective eyewear and Manual.



OxyFuel 150 Tote

Specifications

Part No.	Description	Fuel Gas Type
0384-0977	OxyFuel 150 Outfit, complete with carry tote and empty tanks*	Acetylene
0384-0978	OxyFuel 150 Outfit, complete with carry tote, no tanks*	Acetylene



FEATURES

- Complete portable system
- Cutting torch and handle are ready for multiple gas options; Oxy-Acetylene, Propane, Butane, Natural & LP Gases, & Propylene
- Simple to use rear-mount regulator with high contrast gauges
- Meets or exceeds industry safety standards
- Cut 1/8" (3.2 mm) to 3" (76.2 mm) steel
- Weld up to 1/4" (6.4 mm) Steel
- Constructed with high strength alloys, heavy duty stainless steel and durable brass
- Two year warranty

NOTE: TANKS ARE FOR EXCHANGE ONLY AND ARE EMPTY

APPLICATIONS

This OxyFuel 150 outfit complete with carry tote and empty tanks is the ideal entry level starter package. Optimized for 1/2" cut and 1/8" weld out of the box. Suitable for light duty fusion welding, braze welding, brazing and hand cutting applications.*

CONTENTS

Oxygen/Acetylene 150 Series Regulators, 250 Series Cutting Attachment and Handle, cylinder wrench with chain, Dual R-Grade Hose 3/16" x 12.5 ft., #0 Cutting Tip, #2 Welding Nozzle, Striker, Protective eyewear, Tote Carry Pak with storage and Manual. (with or without OX-20 cu. ft. Type "R" and AC-MC10 cu. ft. tanks depending on part no.)

*Not Recommended For Use With Heating Nozzles Due To Tank Size.

OxyFuel 250 Replacement Torch Kit

Specifications

Part No.	Description	Fuel Gas Type
0384-2573	OxyFuel 250 Torch Replacement Kit	All



*NOTE: For use with fuel gas other than Acetylene, proper tips, regulators or T-grade hoses may be required.

FEATURES

- Cutting torch and handle are ready for multiple gas options; Oxy-Acetylene, Propane, Butane, Natural & LP Gases, & Propylene
- Ergonomic color coded knobs (Acetylene & Oxygen)
- Meets or exceeds industry safety standards
- Cut 1/8" (3.2 mm) to 5" (127 mm) steel
- Heat using multiple heat nozzles
- Weld up to 1/2" (12.7 mm) steel
- Constructed with high strength alloys and heavy duty stainless steel and durable brass
- Two year warranty

APPLICATIONS

This OxyFuel 250 replacement torch kit delivers the latest generation of Victor® professional torch and handle design and operating platform.

CONTENTS

250 Series Cutting Attachment and Handle, #0 Cutting Tip, #0 Welding Nozzle, and Manual.

Oxy-Fuel Acetylene Regulator

Specifications

Part No.	Description	Gas Type
0781-9827	OxyFuel 250 Acetylene Regulator, 510 CGA, 2-15 PSIG	Acetylene
0781-9830	OxyFuel 350 Acetylene Regulator, 510 CGA, 2-15 PSIG	Acetylene



FEATURES

- High performance single stage regulator with precise pressure and flow control
- Large clear gauges enable both inlet and delivery pressures to be read at a glance
- Clear color coding for the correct gas usage
- Forged brass body and high strength alloy bonnet
- Meets or exceeds industry standards
- 9/16" -18 outlet connection (LH)
- Two year warranty

APPLICATIONS

The OxyFuel 250 and 350 Acetylene regulators are suitable for a wide range of cutting, heating and welding applications using Acetylene fuel gas only.*

*Other Fuels Gas Regulators available @ esab.com



OXY-FUEL

Oxy-Fuel Oxygen Regulator

Specifications

Part No.	Description	Gas Type
0781-9826	OxyFuel 250 Oxygen Regulator, 540 CGA, 10-150 PSIG	Oxygen
0781-9829	OxyFuel 350 Oxygen Regulator, 540 CGA, 10-150 PSIG	Oxygen



FEATURES

- High performance single stage regulator with precise pressure and flow control
- Large clear gauges enable both inlet and delivery pressures to be read at a glance
- Clear color coding for the correct gas usage
- Forged brass body and high strength alloy bonnet
- Meets or exceeds industry standards
- 9/16" -18 outlet connection (RH)
- Two year warranty

APPLICATIONS

The OxyFuel 250 and 350 Oxygen regulators are suitable for a wide range of cutting, heating and welding applications using Oxygen gas only.



Argon/CO₂ Mixes Flowgauge Regulator

Specifications

Part No.	Description	Gas Type
0781-9832	Argon/CO ₂ Flowgauge Regulator, 580 CGA, 10-150 PSIG	Argon/CO ₂



FEATURES

- High performance single stage regulator with precise pressure and flow control
- Large clear gauges enable both inlet and delivery pressures to be read at a glance
- Clear color coding for the correct gas usage
- Forged brass body and high strength alloy bonnet
- Meets or exceeds industry standards
- 9/16" -18 outlet connection (RH)
- Two year warranty

APPLICATIONS

The Argon/CO₂ Flowgauge Regulator is suitable for MIG and TIG welding applications using Argon and Argon/CO₂ gas mixtures.



OxyFuel G150 Tote Regulators

Specifications

Part No.	Description	Gas Type
0781-4238	OxyFuel G150 Tote Acetylene Regulator, 200 CGA, 2-15 PSIG	Acetylene
0781-4239	OxyFuel G150 Tote Oxygen Regulator, 540 CGA, 4-60 PSIG	Oxygen



FEATURES

- High performance single stage regulator with precise pressure and flow control
- Large clear gauges enable both inlet and delivery pressures to be read at a glance
- Forged brass body and high strength alloy bonnet
- Meets or exceeds industry standards
- 9/16" -18 outlet connection (LH)
- Standard CGA, rear mount gas connections for Oxygen tote kits
- Two year warranty

APPLICATIONS

The OxyFuel G150 Tote Regulators are suitable for a wide range of cutting, heating, and welding applications.

High Pressure Regulators

Specifications

Part No.	Description	Gas Type
0781-9726	1500 High Pressure Regulator, 580 CGA, 100-1500 PSIG	Helium, Argon, Nitrogen
0781-9727	3000 High Pressure Regulator, 680 CGA, 200-3000 PSIG	Helium, Argon, Nitrogen



FEATURES

- 0-4000 PSI cylinder gauge
- Max Inlet 3000
- 2-1/2" diameter gauges
- Brass construction, single stage regulator
- Two year warranty

APPLICATIONS

Heavy Duty, high pressure piston regulator.

Inert Regulator

Specifications

Part No.	Description	Gas Type
0781-9828	250 Inert Flow Regulator, 580 CGA, 5-200 PSIG	Inert



FEATURES

- High performance single stage regulator with precise pressure and flow control
- Large clear gauges enable both inlet and delivery pressures to be read at a glance
- Clear color coding for the correct gas usage
- Forged brass body and high strength alloy bonnet
- Meets or exceeds industry standards
- 9/16" -18 outlet connection (RH)
- Two year warranty

APPLICATIONS

The Inert Flowgauge Regulator is designed specifically for use with Nitrogen and Helium gases.

Oxy-Fuel Cutting Attachments

Specifications

Part No.	Description	Fuel Gas Type
0381-0759	OxyFuel 250 Cutting Attachment, "W" Series, 7/8" Handle Thread	All
0381-0760	OxyFuel 350 Cutting Attachment, "W" Series, 7/8" Handle Thread	All

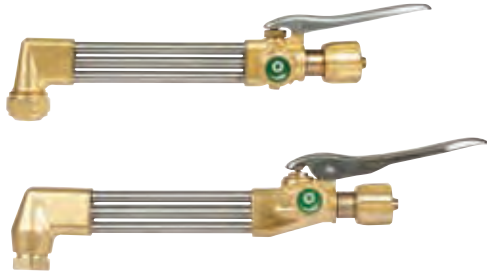

FEATURES

- Meets or exceeds Industry Standards
- Attaches quickly and easily to Oxy-Fuel handle (no tools required), 7/8" thread
- Cutting oxygen lever securely fitted to the body for ease of operation
- High strength triple stainless steel tube construction with good cutting visibility
- Multi gas operation: Oxy-Acetylene, Propane, Butane, Natural & LP Gases, & Propylene
- Cutting capacity up to 6" (350), up to 5" (250)
- Two year warranty

APPLICATIONS

Suitable for the following processes: hand cutting.

Oxy-Fuel Cutting/Welding Handles

Specifications

Part No.	Description	Hose Connection	Fuel Gas Type
0382-0358	OxyFuel 250-350 Torch Handle, "W" Series, 7/8" Handle Thread	"B" 9/16"-18	All



NOTE: For use with Fuel Gas other than Acetylene. Proper Tips, Regulators or T-Grade Hoses may be required.

FEATURES

- Meets or exceeds Industry Standards
- High strength durable brass and alloy handle, "W" nozzle connection 7/8" thread
- High precision valves for sensitive control for delicate welding jobs
- Easy light up for high flow heating applications
- Multi gas operation: Oxy-Acetylene, Propane, Butane, Natural & LP Gases, & Propylene
- Left and right hand threads prevent incorrect hose connection, 1/4" thread
- Color coded control knobs for maximum safety and ease of use, even when wearing gloves
- Two year warranty

APPLICATIONS

The Oxy-Fuel Cutting and Welding Handle connects to Oxy-Fuel Cutting attachments and a complete line of Heating and Welding nozzles. Suitable for the following processes: Fusion welding, braze welding, brazing, soldering, heating, hand cutting.

Oxy-Fuel Straight Cutting Torch

Specifications

Part No.	Description	Hose Connection	Fuel Gas Type
0381-0751	350 OxyFuel ST900 Straight Cutting Torch	"B" 9/16"-18	All



FEATURES

- Cutting torch and handle are ready for multiple gas options; Oxy-Acetylene, Propane, Butane, Natural & LP Gases, & Propylene
- Labeled knobs (Acetylene & Oxygen)
- Meets or exceeds industry safety standards
- Cut 1/8" (3.2 mm) to 6" (152.4 mm) steel
- Constructed with high strength alloys, heavy duty stainless steel and durable brass
- Includes built-in patented flash back arrestors
- Two year warranty

APPLICATIONS

Suitable for the following processes: hand cutting.

Oxy-Fuel Hoses

Specifications

Part No.	Description	Fitting	Fuel Gas Type
1412-0012	3/16" x 12.5 ft. Dual R-Grade	"A" 3/8"-24	Acetylene
1412-0020	3/16" x 25 ft. Dual R-Grade	"A" 3/8"-24	Acetylene
1412-0021	1/4" x 25 ft. Dual R-Grade	"B" 9/16"-18	Acetylene
1412-0022	1/4" x 50 ft. Dual R-Grade	"B" 9/16"-18	Acetylene
1412-0134	3/16" x 12.5 ft. Dual T-Grade	"A" 3/8"-24	All
1412-0128	1/4" x 25 ft. Dual T-Grade	"B" 9/16"-18	All



FEATURES

- Premium quality hose that meets or exceeds the requirements of RMA and CGA
- Secure, specifically designed hose fittings ensure operator safety
- Color coded for easy identification
- Precut to length with fitted connections
- 12.5 ft., 25 ft. and 50 ft. lengths in 3/16" and 1/4" thread connector
- R-Grade hose recommended for use with Acetylene

KEY INFORMATION

It is important to use the correct type of hose for the required gas(es) to be used. Any non-standard application should always be checked and approved before being put into operation. Pressure drops will occur through hoses and hose fittings, therefore allowances must be made to compensate for this when setting up equipment and adjusting regulators. Color coding of hoses and different threads for fuel and Oxygen prevents incorrect connections of hoses to the wrong gas type. Dual hoses help to keep the work area tidy, which reduces the risk of hose damage.



Oxy-Fuel hoses are Grade "R" recommended for Oxygen and Acetylene, available in pre fitted lengths from 12.5 ft. to 50 ft. Compatible with all the Oxy-Fuel range and suitable for light to heavy duty fusion welding, braze welding, brazing, heating and hand cutting applications.

Oxy-Fuel Flashback Arrestors

Specifications

Part No.	Description	Fuel Gas Type
0656-0008	OxyFuel 250-350 FBT-2 Torch Flashback arrestors set with check valves	All
0656-0000	KC-1 Kwik Connect™ Pair Pak (Oxygen and Fuel)	All
0656-0016	OxyFuel 250-350 FPRA Regulator Flashback arrestor set with check valves	All



FEATURES

- Provide ultimate protection against "Flashback" and premature failure of system components
- High flow capacity
- Non-return valve
- Large cylindrical stainless steel flame arrestor

APPLICATIONS

Designed for connection to the inlet of the torch handle and used for all cutting, heating and welding applications.



Oxy-Fuel Tanks & Totes

Specifications

Part No.	Description	Fuel Gas Type
0916-0003	OX-20 Type "R" Oxygen Cylinder, 20 cu. ft. Capacity*	Oxygen
0916-0032	AC-MC Type "MC" Acetylene Cylinder, 10 cu. ft. Capacity* ISO/DOT/TC	Acetylene
1421-0085	Cylinder Tote Only	All
0916-0028	NT-40 Nitrogen Cylinder, 40 cu. ft. (For Nitrogen Purging) ISO/DOT/TC	Nitrogen
0386-1226	TK Tank Key	-



FEATURES AC-MC*

- Type "MC" Acetylene Cylinder, 10 cu. ft. Capacity
- CGA 200 Connection
- DOT, TC Certified

FEATURES NT-40

- 40 cu. ft. Nitrogen Cylinder
- CGA 580 Connection
- DOT, TC Certified

FEATURES OX-20*

- Type "R" Oxygen Cylinder, 20 cu. ft. Capacity
- CGA 540 Connection
- DOT, TC Certified

APPLICATIONS

Tote and small tanks designed for smaller cutting and welding jobs allowing easy transport with this highly portable system.



*Not Recommended To Use Heating Nozzles With The 0916-0033 and 0916-0032 Tanks.

Oxy-Fuel Cutting Tips

Refer to Table Below



ACETYLENE

NATURAL GAS

PROPYLENE



Type 101



Type GPN



Type GPP



FEATURES

- Longer Nozzle life – high grade copper and advanced manufacturing techniques give the Firepower Oxy-Fuel superior cutting life.
- Better quality cutting – the mirror smooth finish of the gas ports assures stable gas flow and superior cutting oxygen stream. Cuts are clean and smooth with the narrowest kerf.
- Less slag adhesion – copper content conducts heat away from the nozzle face. The nozzle keeps cooler and slag adherence to the nozzle face is reduced.
- Consistent manufacture batch testing ensures Oxy-Fuel nozzles will consistently deliver the highest quality performance

APPLICATIONS

Used for cutting steel 1/8" to 6" thick.

*NOTE: For use with fuel gas other than Acetylene, proper tips, regulators or T-grade hoses may be required.

OXY-FUEL



- ACETYLENE TYPE CUTTING TIPS (TYPE 101)



TIP SIZE	PLATE THICKNESS	OXYFUEL 250 SERIES 3 - PART NO.	OXYFUEL 350 SERIES 1 - PART NO.	FUEL GAS FLOW (SCFH)	FUEL GAS PRESSURE (PSIG)	OXYGEN FLOW (TOTAL SCFH)	CUTTING OXYGEN PRESSURE (PSIG)
000	1/8" - 3 mm	6700-2438	6700-2408	3/5	3/5	20/25	20/25
00	1/4" - 6 mm	6700-2439	6700-2409	4/6	3/5	30/35	20/25
0	1/2" - 13 mm	6700-2440	6700-2410	6/10	3/5	60/65	30/35
1	3/4" - 19 mm	6700-2441	6700-2411	8/13	3/5	80/85	30/35
2	1" - 25 mm	6700-2442	6700-2412	10/16	3/6	140/150	35/40
3	2" - 51 mm	6700-2443	6700-2413	14/22	4/9	210/225	40/45
4	3" - 76 mm	6700-2444	6700-2414	18/30	5/10	270/320	40/50
5	5" - 127 mm	6700-2445	6700-2415	26/38	5/13	425/450	50/55
6	6" - 152 mm	-	6700-2416	30/44	7/13	500/600	45/40



+ NATURAL GAS TYPE CUTTING TIPS (TYPE GPN)

*NOTE: To use these GPN tips, a T-grade hose and GPN regulators are required.



TIP SIZE	PLATE THICKNESS	OXYFUEL 250 SERIES 3 - PART NO.	OXYFUEL 350 SERIES 1 - PART NO.	FUEL GAS FLOW (SCFH)	FUEL GAS PRESSURE (PSIG)	OXYGEN FLOW (TOTAL SCFH)	CUTTING OXYGEN PRESSURE (PSIG)
000	1/8" - 3 mm	6700-2498	6700-2468	5/6	3/5	12/14	20/25
00	1/4" - 6 mm	6700-2499	6700-2469	5/7	3/5	22/26	20/25
0	1/2" - 13 mm	6700-2500	6700-2470	8/10	3/5	50/55	30/35
1	3/4" - 19 mm	6700-2501	6700-2471	10/12	4/6	70/80	30/35
2	1" - 25 mm	6700-2502	6700-2472	12/15	4/8	115/125	35/40
3	2" - 51 mm	6700-2503	6700-2473	14/18	5/9	150/175	40/45
4	3" - 76 mm	6700-2504	6700-2474	16/20	8/12	210/250	45/50
5	5" - 127 mm	6700-2505	6700-2475	20/30	8/12	330-360	50/55
6	6" - 152 mm	-	6700-2476	25/35	10/15	400/500	45/55



+ PROPYLENE GAS TYPE CUTTING TIPS (TYPE GPP)

*NOTE: To use these GPP tips, a T-grade hose and GPP regulators are required.



TIP SIZE	PLATE THICKNESS	OXYFUEL 250 SERIES 3 - PART NO.	OXYFUEL 350 SERIES 1 - PART NO.	FUEL GAS FLOW (SCFH)	FUEL GAS PRESSURE (PSIG)	OXYGEN FLOW (TOTAL SCFH)	CUTTING OXYGEN PRESSURE (PSIG)
000	1/8" - 3 mm	6700-2618	6700-2588	5/6	3/5	12/14	20/25
00	1/4" - 6 mm	6700-2619	6700-2589	5/7	3/5	22/26	20/25
0	1/2" - 13 mm	6700-2620	6700-2590	8/10	3/5	50/55	30/35
1	3/4" - 19 mm	6700-2621	6700-2591	10/12	4/6	70/80	30/35
2	1" - 25 mm	6700-2622	6700-2592	12/15	4/8	115/125	35/40
3	2" - 51 mm	6700-2623	6700-2593	14/18	5/9	150/175	40/50
4	3" - 76 mm	6700-2624	6700-2594	16/20	8/12	210/250	45/50
5	5" - 127 mm	-	6700-2595	20/30	8/12	330/360	50/55
6	6" - 152 mm	-	6700-2596	25/35	10/15	400/500	45/55

Oxy-Fuel Heating Nozzles

Specifications

Part No.	Description	Fuel Gas Type	Size	Oxygen Pressure (PSIG)	Acetylene Pressure (PSIG)	Oxygen Consumption (SCFH)	Acetylene Consumption (SCFH)
0323-0270	250-350 Series Multi-flame Nozzle (Clamshell)	Acetylene	4	8/12	6/10	7/22	6/20
0324-0143	150 Series Multi-flame Nozzle (Clamshell)	Acetylene	4	8/12	6/10	7/22	6/20
0323-0271	250-350 Series Multi-flame Nozzle (Clamshell)	Acetylene	6	10/15	8/12	15/44	14/40
0324-0146	150 Series Multi-flame Nozzle (Clamshell)	Acetylene	6	10/15	8/12	15/44	14/40
0323-0272	250-350 Series Multi-flame Nozzle (Clamshell)	Acetylene	8	20/30	10/15	33/88	30/80
0324-0112	150 Series Multi-flame Nozzle (Clamshell)	Acetylene	8	20/30	10/15	33/88	30/80



FEATURES

- Concentrated high temperature flame
- Wide range for different applications
- Connects directly to the Oxy-Fuel torch handle platform*

APPLICATIONS

Used for concentrated heating of steel and other materials.

*Heating Nozzles Are Not Recommended For Use With Tote Outfits, and 0916-0032 and 0916-0033 Tanks.



Oxy-Fuel Welding Nozzles

Specifications

Part No.	Description	Fuel Gas Type	Metal Inches	Thickness Mm	Drill Size	Oxygen (PSIG)	Acetylene (PSIG)	Acetylene (SCFH)
0323-0360	#0 Acetylene Welding Nozzle	Acetylene	5/64"	1.9	65 (0.035)	3/5	3/5	2/4
0324-0150	#0 Acetylene 150 Welding Nozzle	Acetylene	5/64"	1.9	65 (0.035)	3/5	3/5	2/4
0323-0361	#1 Acetylene Welding Nozzle	Acetylene	3/32"	2.4	60 (0.040)	3/5	3/5	3/6
0324-0151	#1 Acetylene 150 Welding Nozzle	Acetylene	3/32"	2.4	60 (0.040)	3/5	3/5	3/6
0323-0362	#2 Acetylene Welding Nozzle	Acetylene	1/8"	3.2	56 (0.046)	3/5	3/5	5/10
0324-0152	#2 Acetylene 150 Welding Nozzle	Acetylene	1/8"	3.2	56 (0.046)	3/5	3/5	5/10
0323-0363	#3 Acetylene Welding Nozzle	Acetylene	1/16"	4.8	53 (0.060)	4/7	3/6	8/18
0324-0153	#3 Acetylene 150 Welding Nozzle	Acetylene	1/16"	4.8	53 (0.060)	4/7	3/6	8/18
0323-0364	#4 Acetylene Welding Nozzle	Acetylene	1/4"	6.4	49 (0.073)	5/10	4/7	10/25
0324-0154	#4 Acetylene 150 Welding Nozzle	Acetylene	1/4"	6.4	49 (0.073)	5/10	4/7	10/25
0323-0365	#5 Acetylene Welding Nozzle	Acetylene	1/2"	12.7	43 (0.089)	6/12	5/8	15/35
0324-0155	#5 Acetylene 150 Welding Nozzle	Acetylene	1/2"	12.7	43 (0.089)	6/12	5/8	15/35



FEATURES

- Concentrated high temperature flame
- Wide range for different applications
- Connects directly to the Oxy-Fuel torch handle platform

APPLICATIONS

Used for fusion welding, braze welding, brazing, and soldering of thin steel and other weldable materials.



Replacement Gauges

Specifications

Part No.	G-150 Series 1.5" Gauges	Max PSI	Thread Size	Part No.	250 Series 2" Gauges	Max PSI	Thread Size
1435-0090RP	Acetylene Only	15	1/8" NPT	1424-0013	Acetylene Only	30	1/4" NPT
1435-0091RP	All Gases	87	1/8" NPT	1424-0014	All Gases	60	1/4" NPT
1435-0092RP	All Gases	580	1/8" NPT	1424-0015	All Gases	100	1/4" NPT
1435-0093RP	All Gases	4568	1/8" NPT	1424-0017	All Gases	400	1/4" NPT
				1424-0019	All Gases	4000	1/4" NPT



Adaptors

Specifications

Part No.	Description	Fuel Gas Type
0387-0490	FP Adaptor CGA 300Tank/510Reg.	ALL
0387-0492	FP Adaptor CGA 510Tank/300Reg.	ALL
0387-0488	FP Adaptor CGA 510Tank/520Reg.	ALL
0387-0491	FP Adaptor CGA 520Tank/200Reg.	ALL
0387-0489	FP Adaptor CGA 520Tank/510Reg.	ALL



FEATURES

- Adapts different sized cylinders to the regulator
- Forged brass body

APPLICATIONS

0387-0490 - Allows the connection between a CGA 300 Tank to a 510 Regulator.
 0387-0492 - Allows the connection between a CGA 510 Tank to a 300 Regulator.
 0387-0488 - Allows the connection between a CGA 510 Tank to a 520 Regulator.
 0387-0491 - Allows the connection between a CGA 520 Tank to a 200 Regulator.
 0387-0489 - Allows the connection between a CGA 520 Tank to a 510 Regulator.



OXY-FUEL

AirFuel Tanks

Specifications

Part No.	Description	Fuel Gas Type
0387-0436	Firepower FP 1 lb. Propane Tank	Propane
0916-0122	MAP//Pro™, 600 CGA	MAP//Pro

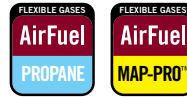

FEATURES

- Contains 14.1 oz. propane

APPLICATIONS

Replacement tank for use with all Firepower hand torches.



Welding Flowmeter Regulator

Specifications

Part No.	Description	Fuel Gas Type
0781-2733	Weld Gas Flowmeter, HRF 1480-580 FPH, 580 CGA	Argon/CO ₂



FEATURES

- Maximum inlet pressure 3,000 PSIG, outlet pressure is present for 80 PSIG
- Flow range is 10-50/Argon gas, 580 CGA male threaded connection
- Model includes 10" gas hose
- Easy to read flow tube for accurate adjustments
- Specifically designed for MIG, TIG and other inert gas welding applications
- Two year warranty

APPLICATIONS

The Flowmeter Regulator is used with most MIG or TIG welding applications.



Firepower[®]



AirFuel Pencil Tip Torch & Kit

Specifications

Part No.	Description	Fuel Gas Type
0387-0470	Firepower P-10 Pencil Tip Propane Torch	Propane
0387-0471	Firepower FP PK-10 Pencil Tip Propane	Propane



FEATURES

- For use with 14.1 oz. or 16 oz.
- Solid Brass burn tube construction.
- Two year warranty

APPLICATIONS

The Manual Light Propane Pencil Tip Torch is suitable for Brazing, Heating and Soldering.

AirFuel Hand Torch Kit

Specifications

Part No.	Description	Fuel Gas Type
0387-0400	Firepower AirFuel Manual Light Hand Torch	Propane, MAP//PRO™



FEATURES

- Silver solder copper tubing or Bronze braze steel pipe
- Swirl combustion tip maximizes heat and reduces brazing time by 30%
- For 14.1 oz. or 16 oz. disposable Propane or MAP//Pro
- Two year warranty

APPLICATIONS

The Manual Light Hand Torch is suitable for Brazing, Heating and Soldering.

AirFuel Vers-A-Flame Torch Kits

Specifications

Part No.	Description	Fuel Gas Type
0384-1280	Firepower Vers-A-Flame 350K BTU 1 Ea	Propane
0384-1260	Firepower Vers-A-Flame 500K BTU 1 Ea	Propane



FEATURES

- Durable Brass Control Knob
- Tough 10' Hose
- Meets or exceeds Industry Safety Standards
- For use with LP Tanks 20 lbs. or Larger
- Two year warranty

APPLICATIONS

The Vers-A-Flame is suitable for a wide range of uses.
 Auto/Farm & Home use: Burns weeds, removes paint and melts ice.
 Construction uses: Preheat asphalt & tar, remove road markings and reheat large castings for welding.

AirFuel Hand Torch

Specifications

Part No.	Description	Fuel Gas Type
0387-0463	Firepower AirFuel SMP-31 Hand Torch	Propane, MAP//Pro™

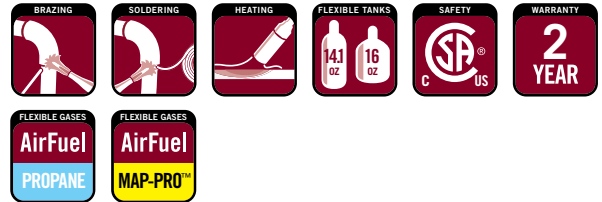

FEATURES

- Auto Igniter for Instant Flame
- Trigger lock on button
- For 14.1 oz. or 16 oz. disposable Propane or MAP//Pro
- Two year warranty

APPLICATIONS

The Auto Igniting Hand Torch is suitable for Brazing, Heating and Soldering.

AirFuel Torch Kit

Specifications

Part No.	Description	Fuel Gas Type
0387-0464	Firepower AirFuel SMPK-31 Torch Kit	Propane, MAP//Pro

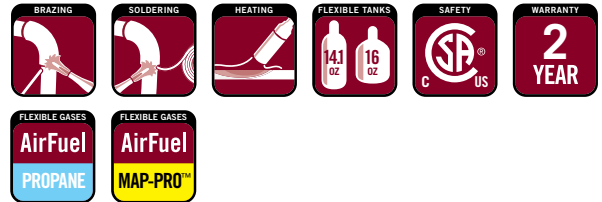

FEATURES

- Auto Igniter for Instant Flame
- Trigger lock on button
- For 14.1 oz. or 16 oz. disposable Propane or MAP//Pro
- Two year warranty

APPLICATIONS

The Auto Igniting Hand Torch is suitable for Brazing, Heating and Soldering.

AirFuel Hand Torch

Specifications

Part No.	Description	Fuel Gas Type
0387-0465	Firepower AirFuel SMP-41 Hand Torch	Propane, MAP//Pro

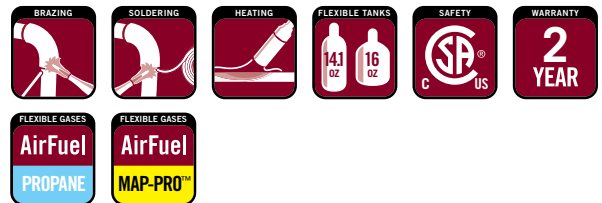

FEATURES

- Auto Igniter for Instant Flame
- Trigger lock on button
- For 14.1 oz. or 16 oz. disposable Propane or MAP//Pro
- Two year warranty

APPLICATIONS

The Auto Igniting Hand Torch is suitable for Brazing, Heating and Soldering.

OXY-FUEL



AIR CUT

Firepower® Plasma Products

Powerful Portable Cutting Technology

Firepower FP-25i, FP-35i and FP-45i feature an advanced LCD interface that simplifies set-up and operation. Operators make all adjustments with just one knob, viewing process information on the generous, full-color 2.8 in. screen. These easy-to-use, compact plasma cutters are perfect for garage, car care, body shop, maintenance, farm/range, metal art and do-it-yourself applications.

The plasma cutting process delivers a precise cut, makes it easy to follow templates, creates almost no distortion and can cut through painted, dirty or rusty material. Firepower plasma units cut steel, stainless, aluminum or brass like a hot knife through butter. In addition to their rated cut thickness — that's a quality cut at good speed — they can also sever thicker material. They weigh less than 30 lbs., packing an amazing amount of cutting power in a compact package.



FP SERIES

Duty Cycle Information

The duty rating defines how long the machine can be used before work must be stopped, in order to let the machine cool down. Duty cycle ratings are expressed as a percentage of a ten-minute period. It represents the maximum welding and cutting time allowed at the specified amperage setting. The remaining balance of the ten-minute period is required for cooling down the machine. For example, if the machine has a 40% duty cycle at 150 amps, it can weld up to 4 minutes and then needs to cool off for the remaining 6 minutes. If a machine is operated below its rated output, the duty cycle typically increases.

Product Name	Clean Cut Thickness	Max. Thickness	Input Power		Output Range				Material	Gas Usage
AirCut™ 15C 1-1110-1	CC THICKNESS 1/8" (3 mm)	MAX THICKNESS 3/16" (5 mm) WITH OPTIONAL TIPS	INPUT POWER 15 AMP 115 VAC	GENERATOR 2000 WATTS	OUTPUT 15 AMPS	PHASE 1 PH	CURRENT DC	DUTY CYCLE 35% @15 AMPS	MATERIALS STEEL STAINLESS STEEL BRASS ALUMINUM	COMPRESSOR INCLUDED
FP-25i	CC THICKNESS 5/16" (8 mm)	MAX THICKNESS 3/8" (10 mm)	INPUT POWER 20 Amp 115 VAC	GENERATOR 8,000 WATTS	OUTPUT 25 AMPS	PHASE 1 PH	CURRENT DC	DUTY CYCLE 25% @25 AMPS	MATERIALS STEEL STAINLESS STEEL BRASS ALUMINUM	GAS 75 PSI (5.2 bar) 32 CFM (91 l/m)
FP-35i	CC THICKNESS 1/2" (12 mm)	MAX THICKNESS 5/8" (16 mm)	INPUT POWER 50 Amp 208/230 VAC	GENERATOR 9,000 WATTS	OUTPUT 35 AMPS	PHASE 1 PH	CURRENT DC	DUTY CYCLE 35% @35 AMPS	MATERIALS STEEL STAINLESS STEEL BRASS ALUMINUM	GAS 75 PSI (5.2 bar) 32 CFM (91 l/m)
FP-45i	CC THICKNESS 5/8" (16 mm)	MAX THICKNESS 1" (25 mm)	INPUT POWER 50 Amp 208/230 VAC	GENERATOR 12,000 WATTS	OUTPUT 45 AMPS	PHASE 1 PH	CURRENT DC	DUTY CYCLE 35% @45 AMPS	MATERIALS STEEL STAINLESS STEEL BRASS ALUMINUM	GAS 75 PSI (5.2 bar) 32 CFM (91 l/m)



Thermal Dynamics® AirCut™ 15C

Specifications

Part No.	Description
1-1110-1	Victor Thermal Dynamics AirCut 15C <i>*Available in USA only</i>

FEATURES

- Comes standard with a built-in air compressor.
- Weighs only 29 lbs (13.2 kg), almost 50% lighter than the competition.
- 1/8" (3 mm) Recommended Cut, 3/16" (5 mm) maximum capability.
- 120V, 15 Amp plug standard. Plug it in anywhere!
- 25% more cutting power provides 25% faster cut speeds than the competition.

CUT THICKNESS 1/8" (3 mm)	MAX THICKNESS 3/16" (5 mm) <small>WITH OPTIONAL TIPS</small>	OUTPUT 15 AMPS	INPUT POWER 15 AMP 115 VAC
PHASE 1 PH	DUTY CYCLE 35% @15 AMPS	MATERIALS STEEL STAINLESS STEEL BRASS ALUMINUM	GENERATOR 2000 WATTS

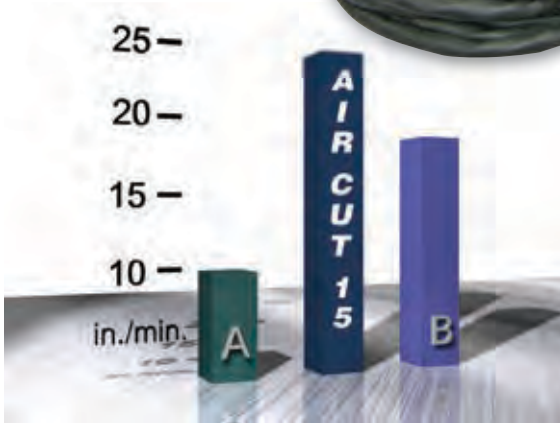

Cut Speed Comparison 1/8" (3 mm)

MACHINE SPECIFICATIONS	
Cut Capacity	1/8" (3 mm) Recommended Cut
Output Current	15 Amps Fixed
Input Power	120V (± 10%), Single Phase, 60 Hz, 12 Amps
Duty Cycle	35% @ 15A
Dimensions	Length 18" (457 mm) Width 6.5" (165 mm) Height 9.5" (241 mm)
Weight	29 lbs (13.2 kg)
Ship Weight	38 lbs (17.2 kg) (includes Unit, Power Cable, Torch and Leads)
Work Cable	19.5 ft (5.9 m)
Input Cable	8.5 ft. (2.6 m)
Gas Type	Air from Built-In Air Compressor
Pilot	CD Start
Control	Hand Torch Switch
Torch	PCH-10
Torch Configuration	Hand 70°, 20' (6.1 m) Leads

AirCut 15C Parts and Accessories

Specifications

Part No.	Accessories
2-1020	PCH-10 70° Torch / 20' (6.1 m) Leads
7-8910	Cutting Guide Kit
9-1260	20 ft (6.1 m) Leather Leads Cover
9-6003	Shield Cup
9-6099	Tip
9-6007	Gas Distributor
9-6006	Electrode

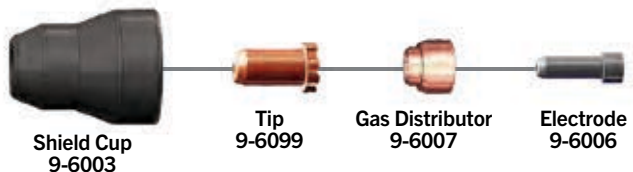

Firepower FP-25i

Specifications

Part No.	Description
1445-1925	Firepower FP-25i Plasma Cutting System (includes 60A torch, two (2) tips, two (2) electrodes, electrode wrench and user manual)

The new light and portable Firepower plasma cutting system has arrived, utilizing a 115V 50/60Hz power supply.

The FP-25i unit is user friendly and incorporates the latest technology, making adjustments easy for everyday cutting needs. The system automatically displays and regulates to a set pressure.

A complete line of long-life consumables has been developed specifically for this unit, so you are always ready for work. Each system comes with the torch included – ergonomically designed with a trigger lock for greater safety.

FEATURES

- Light and portable, weighing only 29.7 lbs. (13.5 kg) including torch
- Easy to use 2.8" color LCD panel, with all adjustments in just one knob
- Torch trigger 2T/4T function
- Torch trigger lock for greater safety
- Grate or plate cutting functions
- Three-year warranty for the power source and three months for the torch

APPLICATIONS

- General Manufacturing
- Furniture Manufacturing
- Transportation
- Autobody Work
- Artisan Metalwork
- General Contracting
- HVAC Duct Cutting
- Fence Repair
- and more!

MACHINE SPECIFICATIONS

Cut Capacity (Mild Steel)	5/16" (8 mm) Recommended Cut
MAX Cut Capacity (Mild Steel)	3/8" (10 mm)
Output Range	20-25 Amps
Input Power	115V (± 10%), Single Phase, 50/60Hz
Duty Cycle	25A @ 25%
Dimensions	Length 16.3" (425 mm) Width 6.9" (176 mm) Height 12.8" (324 mm)
Weight	29.7 lbs (13.5 kg)
Input Air Pressure	80-110 psi (5.5-7.6 bar)
Air Flow	3.9 cfm (110 l/min)
Torch Air Pressure	67 psi (4.6 bar)
Approvals	IP21C, EN 60974-1, CSA, ETL

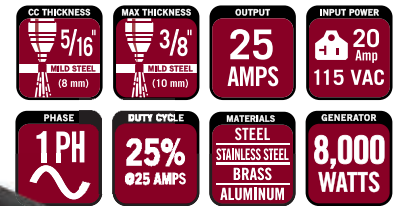

2.8" LCD DISPLAY



SWITCH SELECTION:
2T: ON / OFF
4T: LOCK ON

SELECT PLATE OR GRID

AIR PURGE

Consumables and Accessories

Ordering Information

Part No.	60A Torch Consumables	Part No.	Accessories
1445-1901	Cutting Tip, 25A / 35A, 0.8mm (5 pk)	1445-1900	Plasma Torch, 60A, with 25A/35A and 45A Tips
1445-1902	Cutting Tip, 45A, 0.8mm (5 pk)	1445-1908	Inline Air Filter
1445-1903	Electrode, 60A (5 pk)	1445-1909	Inline Air Filter Cartridge
1445-1904	Stand Off Guide, 60A	1445-1910	Circle Cutting Guide
1445-1905	Shield Cup, 60A	1444-0900	Utility Cart
1445-1906	O-Ring, 60A (3 pk)		
1445-1907	Gas Diffuser, 60A		

Firepower FP-35i

Ordering Information

Part No.	Description
1445-1935	Firepower FP-35i Plasma Cutting System (includes 60A torch, two (2) tips, two (2) electrodes, electrode wrench and user manual)

The new light and portable Firepower plasma cutting system has arrived, utilizing a 208/230V 50/60Hz power supply.

The FP-35i unit is user friendly and incorporates the latest technology, making adjustments easy for everyday cutting needs. The system automatically displays and regulates to a set pressure.

A complete line of long-life consumables has been developed specifically for this unit, so you are always ready for work. Each system comes with the torch included – ergonomically designed with a trigger lock for greater safety.

CUT THICKNESS 1/2" (12 mm) MILD STEEL	MAX THICKNESS 5/8" (16 mm) MILD STEEL	OUTPUT 35 AMPS	INPUT POWER 50 Amp 208/230 VAC
PHASE 1 PH	DUTY CYCLE 35% @ 35 AMPS	MATERIALS STEEL STAINLESS STEEL BRASS ALUMINUM	GENERATOR 9,000 WATTS



FEATURES

- Light and portable, weighing only 29.7 lbs. (13.5 kg) including torch
- Easy to use 2.8" color LCD panel, with all adjustments in just one knob
- Torch trigger 2T/4T function
- Torch trigger lock for greater safety
- Grate or plate cutting functions
- Three-year warranty for the power source and three months for the torch

APPLICATIONS

- General Manufacturing
- Furniture Manufacturing
- Transportation
- Autobody Work
- Artisan Metalwork
- General Contracting
- HVAC Duct Cutting
- Fence Repair
- and more!

MACHINE SPECIFICATIONS

Cut Capacity (Mild Steel)	1/2" (12 mm) Recommended Cut
MAX Cut Capacity (Mild Steel)	5/8" (16 mm)
Output Range	20-35 Amps
Input Power	208/230V (± 10%), Single Phase, 50/60Hz
Duty Cycle	35A @ 35%
Dimensions	Length 16.3" (415 mm) Width 6.9" (176mm) Height 12.8" (324 mm)
Weight	29.7 lbs (13.5 kg)
Input Air Pressure	80-110 psi (5.5-7.6 bar)
Air Flow	3.9 cfm (110 l/min)
Torch Air Pressure	67 psi (4.6 bar)
Approvals	IP21C, EN 60974-1, CSA, ETL

2.8" LCD DISPLAY

SWITCH SELECTION:
2T: ON / OFF
4T: LOCK ON

SELECT PLATE OR GRID

AIR PURGE

Consumables and Accessories

Ordering Information

Part No.	60A Torch Consumables	Part No.	Accessories
1445-1901	Cutting Tip, 25A / 35A, 0.8mm (5 pk)	1445-1900	Plasma Torch, 60A, with 25A/35A and 45A Tips
1445-1902	Cutting Tip, 45A, 0.8mm (5 pk)	1445-1908	Inline Air Filter
1445-1903	Electrode, 60A (5 pk)	1445-1909	Inline Air Filter Cartridge
1445-1904	Stand Off Guide, 60A	1445-1910	Circle Cutting Guide
1445-1905	Shield Cup, 60A	1444-0900	Utility Cart
1445-1906	O-Ring, 60A (3 pk)		
1445-1907	Gas Diffuser, 60A		

Firepower FP-45i

Ordering Information

Part No.	Description
1445-1945	Firepower FP-45i Plasma Cutting System (includes 60A torch, two (2) tips, two (2) electrodes, electrode wrench and user manual)

The new light and portable Firepower plasma cutting system has arrived, utilizing a 208/230V 50/60Hz power supply.

The FP-45i unit is user friendly and incorporates the latest technology, making adjustments easy for everyday cutting needs. The system automatically displays and regulates to a set pressure.

A complete line of long-life consumables has been developed specifically for this unit, so you are always ready for work. Each system comes with the torch included – ergonomically designed with a trigger lock for greater safety.

FEATURES

- Light and portable, weighing only 29.7 lbs. (13.5 kg) including torch
- Easy to use 2.8" color LCD panel, with all adjustments in just one knob
- Torch trigger 2T/4T function
- Torch trigger lock for greater safety
- Grate or plate cutting functions
- Three-year warranty for the power source and three months for the torch

APPLICATIONS

- General Manufacturing
- Furniture Manufacturing
- Transportation
- Autobody Work
- Artisan Metalwork
- General Contracting
- HVAC Duct Cutting
- Fence Repair
- and more!

MACHINE SPECIFICATIONS

Cut Capacity (Mild Steel)	5/8" (16 mm) Recommended Cut
MAX Cut Capacity (Mild Steel)	1" (25 mm)
Output Range	20-45 Amps
Input Power	208/230V (± 10%), Single Phase, 50/60Hz
Duty Cycle	45A @ 35%
Dimensions	Length 16.3" (415 mm) Width 6.9" (176 mm) Height 12.8" (324 mm)
Weight	29.7 lbs (13.5 kg)
Input Air Pressure	80-110 psi (5.5-7.6 bar)
Air Flow	3.9 cfm (110 l/min)
Torch Air Pressure	67 psi (4.6 bar)
Approvals	IP21C, EN 60974-1, CSA, ETL



2.8" LCD DISPLAY



SWITCH SELECTION:
2T: ON / OFF
4T: LOCK ON

SELECT PLATE OR GRID

AIR PURGE

PLASMA

Consumables and Accessories

Ordering Information

Part No.	60A Torch Consumables	Part No.	Accessories
1445-1901	Cutting Tip, 25A / 35A, 0.8mm (5 pk)	1445-1900	Plasma Torch, 60A, with 25A/35A and 45A Tips
1445-1902	Cutting Tip, 45A, 0.8mm (5 pk)	1445-1908	Inline Air Filter
1445-1903	Electrode, 60A (5 pk)	1445-1909	Inline Air Filter Cartridge
1445-1904	Stand Off Guide, 60A	1445-1910	Circle Cutting Guide
1445-1905	Shield Cup, 60A	1444-0900	Utility Cart
1445-1906	O-Ring, 60A (3 pk)		
1445-1907	Gas Diffuser, 60A		

Welding/Cutting Cart

Specifications

Part No.	Description
1444-0407	Welding/Cutting Cart



FEATURES

- Fits Many Firepower Welders/Cutters (not MST 220i)
- Accommodates up to 9" (229 mm) diameter Cylinder with Included Chain
- Holds Welders/Cutters on Top Tray
- Sturdy and Durable Construction

FOR USE WITH

MST 140i & 180i, FP-95, 125, 135, 165
 Thermal Arc 95 S, TIG 160S, TIG 140 ACDC & 200 ACDC
 Cutmaster 42, AirCut 15C, Fabricator 141i & 181i

Basic Utility Cart

Specifications

Part No.	Description
1444-0900	Basic Utility Cart



FEATURES

- Sturdy handle makes transporting welders/cutters easy
- Designed for most portable Welding/Cutting systems
- Rugged Solid Steel Construction
- Easy-rolling 8" (203 mm) diameter wheels
- 3" (76 mm) front-mounted casters
- Accommodates up to 9" (229 mm) diameter Cylinder with Included Chains

FOR USE WITH

MST 140i, 180i, 220i, FP-95, 125, 135, 165
 Thermal Arc 95 S, TIG 160S, TIG 140 ACDC & 200 ACDC
 Cutmaster 42, 52, 82, CutSkill C-20A, C-35A, C-70A
 AirCut 15C, Fabricator 141i, 181i, & 211i, Fabricator 186 ACDC

Firepower[®]



Filler Metal



Firepower® Products

Performance, Value and Ease of Use

Firepower welding and safety products cover a full range of metalworking equipment needs. When you choose Firepower, you can be sure you're getting premium, quality tools and equipment with a proven record of performance and dependability. With Firepower's full line of accessories, you've got everything you need in welding, cutting and safety.

Safety



Accessories



STICK WELDING (SMAW)

AWS CLASS	POSITION	POLARITY	USAGE
	All	AC, DCEP	All-purpose stick electrode; used for carbon and galvanized steel; deep penetration and ideal for welding light to medium amounts of dirty, rusty or painted materials; 60,000 PSI tensile strength.
	All	AC, DCEN, DCEP	Light to medium penetrating all-purpose stick electrode; for use on carbon steel; good for general all-purpose applications and joints with poor fit-up; 60,000 PSI tensile strength.
	All	AC, DCEN, DCEP	For higher-deposition requirements; ideal for applications requiring light penetration and faster travel speeds; 70,000 PSI tensile strength.
	All	DCEP	Low-hydrogen electrode; for low, medium and high-carbon steels; ideal for out-of-position welding and tacking; not recommended for low-voltage AC Welders; 70,000 PSI tensile strength.

ELECTRODE AMPERAGE CHART

AWS CLASS	DIA. (IN.)	AMPERAGE RANGE					
		MIN.	50A	100A	150A	200A	MAX.
	3/32		1/16" - 1/4" *				
	1/8			1/8" - 1/2" *			
	5/32				1/4" - Up *		
	5/64	Min. - 1/8" *					
	3/32		1/16" - 1/4" *				
	1/8			1/8" - 1/2" *			
	5/32				1/4" - Up *		
	3/32			1/16" - 1/4" *			
	1/8				1/8" - 1/2" *		
	5/32					1/4" - Up *	
	3/32			1/16" - 1/4" *			
	1/8				1/8" - 1/2" *		

*Plate Thickness

FILLER METAL

Carbon Steel

Carbon steel, or plain-carbon steel, is mostly iron and carbon with other elements in quantities too small to affect their properties. A low carbon content means it is similar to iron, soft, and easily formed. The more carbon content, the harder and stronger the metal becomes, but it is also less moldable and harder to weld. At a higher carbon content, the metal's melting point is lower and it has less resistance to higher temperatures. Such steel should not be used in an environment where sparks would pose a potential safety problem.

Stainless Steel

Stainless steel contains a high chromium and low carbon content, and upon contact with oxygen creates a chromium oxide layer that gives passive protection against corrosion from moisture. When certain high-strength alloys such as aluminum come into contact with carbon steel, such as being brushed by carbon steel wire, a deposit of carbon steel is left behind that can cause rust. That same carbon steel transfer can happen in the other direction, which is why once a stainless steel brush is used on carbon steel it should never be used on stainless steel again. Also, stainless steel brushes should be stored away from any area that might contain carbon steel particles, such as a steel workbench. Stainless steel wire brushes should be degreased before operation, and if they are stored after use they should be degreased and wrapped in plastic. If they are stored without protection, their magnetic properties could allow particles to be collected that lead to after-rust.

ELECTRODE PART NUMBER CHART

Rod Size	1 lb Box	5 lb Box	10 lb Box	50 lb Box
TYPE 6010 STICK ELECTRODE				
3/32"		1440-0474		
1/8"		1440-0473		
5/32"		1440-0475		
TYPE 6011 STICK ELECTRODE				
3/32"	1440-0115	1440-0116	1440-0117	1440-0118
1/8"	1440-0105	1440-0106	1440-0107	1440-0108
5/32"	1440-0095	1440-0096	1440-0097	1440-0098
TYPE 6013 STICK ELECTRODE				
3/32"	1440-0145	1440-0146	1440-0147	1440-0148
1/8"	1440-0134	1440-0135	1440-0136	1440-0137
5/32"	1440-0124	1440-0125	1440-0126	1440-0127
TYPE 7014 STICK ELECTRODE				
3/32"	1440-0205	1440-0206	1440-0207	1440-0208
1/8"	1440-0200	1440-0201	1440-0202	1440-0203
5/32"	1440-0150	1440-0151	1440-0152	1440-0153
TYPE 7018 STICK ELECTRODE				
3/32"	1440-0195	1440-0196	1440-0197	1440-0198
1/8"	1440-0185	1440-0186	1440-0187	1440-0188
5/32"	1440-0180	1440-0181	1440-0182	1440-0183
Rod Size	1 lb Box	5 lb Box	10 lb Box	Job Pack [†]
E6024 QUICK START ELECTRODE				
1/16"	1440-0412	1440-0413		
308 STAINLESS STEEL ELECTRODE				
3/32"	1440-0165			
1/8"	1440-0155	1440-0156		
E-309L STAINLESS STEEL ELECTRODE				
3/32"			1440-0497	
1/8"			1440-0496	
NICKEL 55 CAST IRON				
3/32"				1440-0440
1/8"	1440-0083			
NICKEL 99 CAST IRON				
3/32"				1440-0423
1/8"	1440-0425	1440-0374		1440-0424
E4043 ALUMINUM ARC ELECTRODE				
1/8"	1440-0419	1440-0420		

[†]See Page 59 for Job Packs Available
[‡]For 230V Operation Only

ELECTRODE DESCRIPTIONS

TYPE 6010 Mild Steel Current: AC/DC

All position electrode. Use when you are unable to prepare a welding surface. Its deep penetration allows welds through rust, scale, oil and dirt.



TYPE 6011 Mild Steel Current: AC/DC

All position electrode. Use when you are unable to prepare a welding surface. Its deep penetration allows welds through rust, scale, oil and dirt.



TYPE 6013 Mild Steel Current: AC/DC

All position electrode. Best used with clean or prepared welding surface. Excellent for low heat applications designed for general purpose.



TYPE 7014 Iron Powder Current: AC/DC

All position electrode. Best used with clean or prepared welding surface with Medium to Low penetration. Designed for high deposition and high electrode travel speed.



TYPE 7018 Low Hydrogen Current: AC/DC

All position electrode. Best used with clean or prepared welding surface with Medium penetration. Designed to produce X-ray quality welds.



E6024 Quick Start Mild Steel Current: AC/DC

Best used with clean or prepared welding surface and excellent for low heat applications. Flat & horizontal fillet only.



308 Stainless Steel Current: AC/DC

Used for all 200 and 300 series stainless up to and including 308. Provides equal or better corrosion resistance than base metal and can also be used to fabricate and repair austenitic manganese steel.



E-309L Current: AC/DC

Used for welding/joining of 300 series stainless to mild steel. Provides equal or better corrosion resistance than base metal.



Nickel 55 Cast Iron Current: AC/DC*

Best used for repairing cast iron/ heavy cast iron selections. Repairs cylinder blocks, exhaust manifold, and machines bases. Smooth arc characteristics produce strong welds at low amps.



Nickel 99 Cast Iron Current: AC/DC*

All position electrode. Best used on cast iron parts that are subject to heating and cooling, such as engine blocks, cylinder heads, exhaust manifolds.



E4043 Aluminum Arc Current: DC

Best used for weld with strength ductility and corrosion resistance equal to parent metal. Applications include aluminum, sheet metal, plates, castings, tanks and piping.



*DC Recommended

ELECTRODES	MST 140i	MST 180i	MST 220i	TIG 140 ACDC	TIG 200 ACDC	TIG 160S
	Up to 3/32"	Up to 5/32"	Up to 5/32"	Up to 3/32"	Up to 5/32"	Up to 5/32"
Type 6010 Mild Steel	EXPERT	EXPERT	EXPERT	EXPERT	EXPERT	EXPERT
Type 6011 Mild Steel	NO	EXPERT	EXPERT	NO	EXPERT	EXPERT
Type 6013 Mild Steel	NOVICE	NOVICE	NOVICE	NOVICE	NOVICE	NOVICE
Type 7014 Iron Powder	NOVICE	NOVICE	NOVICE	NOVICE	NOVICE	NOVICE
Type 7018 Low Hydrogen	SKILLED	SKILLED	SKILLED	SKILLED	SKILLED	SKILLED
E6024 Quick Start	NOVICE	NOVICE	NOVICE	NOVICE	NOVICE	NOVICE
308 Stainless Steel	NOVICE	NOVICE	NOVICE	NOVICE	NOVICE	NOVICE
E-309L Stainless Steel	NOVICE	NOVICE	NOVICE	NOVICE	NOVICE	NOVICE
Nickel 55 Cast Iron	NOVICE	NOVICE	NOVICE	NOVICE	NOVICE	NOVICE
Nickel 99 Cast Iron	NOVICE	NOVICE	NOVICE	NOVICE	NOVICE	NOVICE
E4043 Aluminum Arc	EXPERT	EXPERT	EXPERT	EXPERT	EXPERT	EXPERT

Each electrode is unique and when working with different materials (Steel, Stainless Steel, Cast Iron, etc.) they require different preparations. We recommended researching the proper welding preparation guidelines for the materials before welding.



These easy-to-use electrodes are multi-position electrodes and are simple to use when welding. Little preparation time, forgivable arc lengths, and wide range of techniques are possible with these electrodes.



Using the intermediate electrodes will require some skill. The electrodes and metals you're working with will require more preparation before welding and require you to maintain the Arc Length.



Professional welding skills are needed to use these electrodes. These electrodes require precision while welding, as there is minimal leeway for operator error, and unique techniques may be required.

Arc Welding Electrodes



Type 6010	1 lb Box	5 lb Box	10 lb Box	50 lb Box
ROD SIZE	PART NO.	PART NO.	PART NO.	PART NO.
3/32"	N/A	1440-0474	N/A	N/A
1/8"	N/A	1440-0473	N/A	N/A
5/32"	N/A	1440-0475	N/A	N/A

Type 6011	1 lb Box	5 lb Box	10 lb Box	50 lb Box
ROD SIZE	PART NO.	PART NO.	PART NO.	PART NO.
3/32"	1440-0115	1440-0116	1440-0117	1440-0118
1/8"	1440-0105	1440-0106	1440-0107	1440-0108
5/32"	1440-0095	1440-0096	1440-0097	1440-0098

Type 6013	1 lb Box	5 lb Box	10 lb Box	50 lb Box
ROD SIZE	PART NO.	PART NO.	PART NO.	PART NO.
3/32"	1440-0145	1440-0146	1440-0147	1440-0148
1/8"	1440-0134	1440-0135	1440-0136	1440-0137
5/32"	1440-0124	1440-0125	1440-0126	1440-0127

Type 7014	1 lb Box	5 lb Box	10 lb Box	50 lb Box
ROD SIZE	PART NO.	PART NO.	PART NO.	PART NO.
3/32"	1440-0205	1440-0206	1440-0207	1440-0208
1/8"	1440-0200	1440-0201	1440-0202	1440-0203
5/32"	1440-0150	1440-0151	1440-0152	1440-0153

Type 7018	1 lb Box	5 lb Box	10 lb Box	50 lb Box
ROD SIZE	PART NO.	PART NO.	PART NO.	PART NO.
3/32"	1440-0195	1440-0196	1440-0197	1440-0198
1/8"	1440-0185	1440-0186	1440-0187	1440-0188
5/32"	1440-0180	1440-0181	1440-0182	1440-0183

6010 FEATURES

- Premium AWS Class E-6010
- Mild steel type
- Deep penetration, welds through rust, scale, oil and dirt
- Excellent for pipe welding, root
- DC, reverse polarity
- 60,000 PSI tensile strength
- All position electrode

6011 FEATURES

- Premium AWS Class E-6011
- Mild steel type
- Deep penetration, welds through rust, scale, oil and dirt
- Use when you are unable to prepare the welding surface
- AC or DC, reverse polarity
- 60,000 PSI tensile strength
- All position electrode

6013 FEATURES

- Premium AWS Class E-6013
- Mild steel type
- Designed for General Purpose
- Excellent for low heat applications
- Best used with clean or prepared welding surface
- AC or DC, reverse polarity
- 60,000 PSI tensile strength
- All position electrode

7014 FEATURES

- Premium AWS Class E-7014
- Iron powder type
- Designed for high deposition and high electrode travel speed
- Medium to low penetration
- Best used with clean or prepared welding surface
- AC or DC, reverse polarity
- 70,000 PSI tensile strength
- All position electrode

7018 FEATURES

- Premium AWS Class E-7018
- Low Hydrogen Type
- Designed to produce X-Ray quality welds
- Medium penetration
- Best used with clean or prepared welding surface
- AC or DC, either polarity
- 70,000 PSI tensile strength
- All position electrode

Job Packs

Specifications

Part No.	Description	No. Rods
1440-0400	Bronze Flux Coated Brazing Rods, 3/32" diameter x 14" long; No brazing flux needed	4
1440-0401	Bronze Bare Brazing Rods, 3/32" diameter x 14" long; Requires brazing flux	4
1440-0402	E4043 Aluminum Welding Electrodes, 1/8" diameter x 14" long; Use with ANY Aluminum Application	3
1440-0405	6013 General Purpose Electrodes, 1/16" x 10" long	4
1440-0406	6013 General Purpose Electrodes, 3/32" diameter x 14" long; Excellent for use with all types of Arc Welders	4
1440-0409	6011 Welding Electrodes, 1/8" diameter x 14" long; Excellent for Maintenance & Repair Applications	3
1440-0411	Nickel 55 Welding Electrodes, 1/8" diameter x 14" long	4
1440-0441	6011 Mild Steel 3/32" diameter x 14" long	4



Mild Steel / E6024 Quick Start Electrodes

Specifications

Part No.	Description
1440-0412	1/16" 1 lb
1440-0413	1/16" 5 lbs

APPLICATIONS

Mild steel type electrode has a special quick start tip. Stable arc and automatic action that makes it easy to use on thin metals requiring low amperage. Features self-cleaning action that works well in all positions. Tensile Strength 60,000 PSI.

CURRENT	AC/DC	
	AMPS	DIAMETER
AMPERAGE RECOMMENDATIONS	25-90	1/16"



Stainless Steel / 308 Stainless Steel Electrodes

Specifications

Part No.	Description
1440-0165	3/32" x 14" 1 lb box
1440-0155	1/8" x 14" 1 lb box
1440-0156	1/8" x 14" 5 lbs box

FEATURES

- For welding all 200 and 300 series stainless up to and including 308
- Provides equal or better corrosion resistance than the base metal
- Can be used for fabricating and repairing austenitic manganese steel



Stainless Steel / E-309L

Specifications

Part No.	Description
1440-0497	3/32" x 14" 10 lb box
1440-0496	1/8" x 14" 10 lb box

FEATURES

- For welding/joining of 300 series stainless to mild steel.
- Provides equal or better corrosion resistance than the base metal



Nickel Base / Est Cast Iron Electrodes (Non-Machinable, Steel Core)

Specifications

Part No.	Description
1440-0449	1/8" 1 lb
1440-0443	1/8" 5 lbs

APPLICATIONS

This cast iron electrode is specifically developed for dirty and oil soaked cast iron applications. It is also ideal for heat affected cast iron repairs. This electrode offers the least expensive method of repairing cast iron. Great for repairing castings, transmission housings, etc. Non-Machinable. Tensile strength 62,000 PSI. Elongation 20%

CURRENT	AC/DC - DC+ recommended
AMPERAGE RECOMMENDATIONS	70-125 AMPS



Nickel Base / ENiFeCl Nickel 55 Cast Iron Electrodes (Machinable)

Specifications

Part No.	Description
1440-0440	3/32" Job pack (3 rods)
1440-0083	1/8" 1 lb

APPLICATIONS

The most versatile cast iron electrode. The best solution for repairing cast iron, heavy cast iron sections. The smooth arc characteristics produce strong, sound welds at low amps. Repairs cylinder blocks, exhaust manifold, and machine bases. Tensile strength 70,000 PSI. Elongation 12%

CURRENT	AC/DC - DC+ recommended	
AMPERAGE RECOMMENDATIONS	AMPS	DIAMETER
	70-90	3/32"
	80-120	1/8"



Nickel Base / ENiCl Pure Nickel 99% Cast Iron Electrodes (Machinable)

Specifications

Part No.	Description
1440-0423	3/32" Job pack (5 rods)
1440-0424	1/8" Job pack (3 rods)
1440-0425	1/8" 1 lb
1440-0374	1/8" 5 lbs

APPLICATIONS

The highest quality nickel electrode available. Welds well in all positions. The high (99%) nickel content has a natural attraction to cast iron giving it superior performance when welding cast iron material. Nickel 99 can be used on cast iron parts that are subject to heating and cooling, such as engine blocks, cylinder heads, exhaust manifolds, etc. Excellent machinability. Tensile strength 55,000 PSI. Elongation 10%

CURRENT	AC/DC - DC+ recommended	
AMPERAGE RECOMMENDATIONS	AMPS	DIAMETER
	70-90	3/32"
	70-110	1/8"



FILLER METAL

Aluminum / E4043 Aluminum Arc Electrodes

Specifications

Part No.	Description
1440-0419	1/8" 1 lb
1440-0420	1/8" 5 lbs

APPLICATIONS

This flux coated aluminum electrode is designed to give a weld with strength ductility and corrosion resistance equal to parent metal. Applications include aluminum, sheet metal, plates, castings, tanks and piping. Tensile strength 34,000 PSI. Elongation 18%.

CURRENT	DC+	
AMPERAGE RECOMMENDATIONS	AMPS	DIAMETER
	70-120	1/8"



Hardfacing Electrodes

Specifications

Part No.	Description
1440-0080	1/8" 1 lb tube, #35 High Abrasion/Hardfacing
1440-0081	1/8" 5 lbs box, #35 High Abrasion/Hardfacing

APPLICATIONS

This high quality, all purpose electrode produces outstanding impact and abrasion resistance. The high deposition rate prolongs surface life of new and worn parts. Ideal for repairing all types of agriculture, construction equipment, auger, buckets, concrete mixers, etc.

AMPERAGE RECOMMENDATIONS	AMPS	DIAMETER
	110-140	1/8"



Cutting Electrodes

Specifications

Part No.	Description
1440-0426	1/8" 1 lb

APPLICATIONS

A special heavy duty coating produces 7000° heat at high-arc velocity. Use this electrode for a fast, low-cost means of cutting cast iron and stainless steel without special equipment.

CURRENT	AC
----------------	----



Oxygen / Acetylene Mild Steel (Copper Coated)

Specifications

Part No.	Description
1440-0442	1/16" x 18" 5 lbs
1440-0433	3/32" x 36" 10 lbs

APPLICATIONS

Low carbon steel rod manufactured to the highest quality standards. Copper coating prevents rusting and improves corrosion resistance. A great rod for shop, home, commercial and maintenance repairs. 65,000 PSI tensile strength.



Manganese Bronze Flux Coated Gas Rods

Specifications

Part No.	Description
1440-0431	3/32" x 36" 1 lb
1440-0429	3/32" x 36" 5 lbs
1440-0430	1/8" x 36" 5 lbs

APPLICATIONS

Flux coated, low fuming brazing rod. Provides all properties for best tensile strength and ductility. Rod fuses well with cast iron, malleable iron, galvanized iron, steel, brass and copper. 65,000 PSI tensile strength.



Manganese Bronze Bare Gas Rods

Specifications

Part No.	Description
1440-0428	1/8" x 36" 5 lbs

APPLICATIONS

Bare brazing rod low fuming highest quality. Balanced zinc and copper alloy. Excellent for brazing fenders, radiators, water tanks and sheet metal. 63,000 PSI tensile strength.



Easy-Flo Aluminum Brazing Rods

Specifications

Part No.	Description
1440-0434	1/8" x 18" 1 lb

APPLICATIONS

Aluminum rod is excellent for all types of sheet or cast aluminum. This product greatly simplifies the process and requires no flux. Applications include aluminum boats, lawn equipment, outboard motors and castings.



Solders and Fluxes / Acid Flux Core Solder

Specifications

Part No.	Description
1423-1102	Acid Flux Core, Comm.; 1/8" x 1 lb
1423-1109	Acid Flux Core, 30/70; 1/8" x .5 lb
1423-1108	Acid Flux Core, 40/60; 1/8" x .25 lb

APPLICATIONS

Is used for non-electrical applications. Applications include, Sheet Metal joint and fitting connections, works well on many types of metals (Copper, Brass, Nickel and Galvanized Steel).



Solders and Fluxes / Rosin Flux Core Solder

Specifications

Part No.	Description
1423-1114	Rosin Flux Core, 40/60; 1/8" x 1 lb
1423-1113	Rosin Flux Core, 30/70; 3/32" x .5 lb
1423-1110	Rosin Flux Core, 40/60; 1/16" x .25 lb
1423-1112	Rosin Flux Core, 40/60; 3/32" x .25 lb

APPLICATIONS

Used for electrical applications. Completely non-corrosive and electrically non-conductive.



Soldering Flux and Paste

Specifications

Part No.	Description
1423-1111	2 oz. Soldering Flux
1423-1101	2 oz. Soldering Paste

APPLICATIONS

Soft Soldering/Tinning Flux that is active between 200°F and 600°F. Very effective on copper and repairing automotive radiators.



Arcair® Protex Plus Anti-Spatter Nozzle Shield

Specifications

Part No.	Description
1440-0296	Arcair Protex Plus Anti-Spatter Spray, 16 oz

FEATURES

- Prevents spatter adhesion on surface - reduces clean-up time
- Non-flammable - contains no silicones



Mild Steel Solid Wire / ER70S-6 MIG Wire Solid

Specifications

Part No.	Spool Size	Wire Size
1440-0210	2 lbs	.023"
1440-0211	11 lbs	.023"
1440-0212	33 lbs	.023"
1440-0215	2 lbs	.030"
1440-0216	11 lbs	.030"
1440-0217	33 lbs	.030"
1440-0220	2 lbs	.035"
1440-0221	11 lbs	.035"
1440-0222	33 lbs	.035"
1440-0447	33 lbs	.045"

FEATURES

- Premium AWS CLASS ER70S-6
- For general purpose MIG welding
- Designed to be used on mild steel
- Best used with clean or prepared welding surface
- Requires a shielding gas
- DC reverse polarity



Flux Cored Wire / E71T-GS Fluxed Cored

Specifications

Part No.	Spool Size	Wire Size
1440-0230	2 lbs	.030"
1440-0231	10 lbs	.030"
1440-0235	2 lbs	.035"
1440-0236	10 lbs	.035"

FEATURES

- Premium AWS CLASS E 71T-GS
- Also called "Self-Shielding" or "Gasless"
- For general purpose MIG welders
- Designed to be used on mild steel
- Best used with clean or prepared welding surface
- Requires no shielding gas
- DC straight polarity



Stainless Steel Solid Wire / ER 308L MIG Wire

Specifications

Part No.	Spool Size	Wire Size
1440-0245	2 lbs	.030"
1440-0489	10 lbs	.030"

FEATURES

- Premium AWS CLASS ER308L
- For stainless steel MIG welding
- Best when used with a clean or prepared welding surface
- Requires a shielding gas
- DC reverse polarity



Aluminum Solid Wire / ER5356 MIG Wire

Specifications

Part No.	Spool Size	Wire Size	AWS Class
1440-0240	1 lb	.030"	ER 5356
1440-0241	1 lb	.035"	ER 5356
1440-0445	3 lbs	.035"	ER 5356
1440-0456	1 lb	.030"	ER 4043

FEATURES

- For aluminum MIG welding
- Best when used with a clean or prepared welding surface
- Requires a shielding gas
- DC reverse polarity



Premium Firepower Auto-Darkening Welding Helmets

Specifications

Part No.	Description
1441-0085	Firepower Pinstripes Auto-Darkening Welding Helmet
1441-0086	Firepower Piston & Plug Auto-Darkening Welding Helmet
1441-0087	Firepower Stars & Stripes Auto-Darkening Welding Helmet
1441-0088	Firepower Skull & Fire Auto-Darkening Welding Helmet



FEATURES

- Four Arc Sensors for High Response
- Automatically Turns from Light to Dark and Dark to Light
- Adjustable Welding Shade Levels from 9 to 13
- Light Shade DIN Level
- "Sensitivity" Control Range
- Selection for Process Mode
- Solar-Powered
- HELMET meets standards EN175, ANSI Z87.1-2010 and CSA Z94.3
- "Delay" Adjustable Controls



SMAW – 60 Amps or less PAW – 20 Amps or less PAC – 300 Amps or less	SHADE #9
SMAW – 60-160 Amps or less GMAW / FCAW – 60 Amps or less GTAW – 60 Amps or less PAW – 20-100 Amps or less	SHADE #10
GMAW / FCAW – 60-160 Amps or less	SHADE #11
SMAW – 160-250 GMAW / FCAW – 160-250 Amps or less GTAW – 50-150 Amps CAC-A – 500 Amps or less PAW – 100-400 Amps PAC – 300-400 Amps	SHADE #12
SMAW – 250-550 Amps GMAW / FCAW – 250-550 Amps GTAW – 150-500 Amps CAC-A – 500-1000 Amps PAW – 400-800 PAC – 400-800	SHADE #13

Replacement Parts

Specifications

#	Part No.	Description
1	20891010	Front Cover Lens, WH41001-FL
2	20891026	Inside Cover Lens, WH41001-IL4
3	20891013	Shade/Sensitivity Knob, WH41001-KB
4	20891017	Headgear Knob, WH41001-BN
5	20891018	Filter Frame w/Screws, WH41001-FF
6	20891020	Headband, WH41001-HB
7	20891023	Headgear Assembly, WH41001-HG
Not Shown	20891024	Hard Hat Fixtures, WH41001-HH
Not Shown	20891025	Magnifying Lens Kit (2X Magnification), WH41001-ML

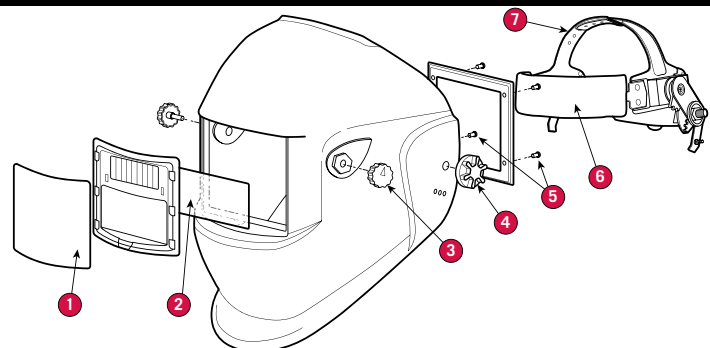

Protective Eyewear

Specifications

Part No.	Description		FEATURES
1441-0042	Adjustable Ratchet Headgear		<ul style="list-style-type: none"> Streamlined, compact design allows welders to get into tight places Meets or Exceeds: ANSI Z87-1, CE and various International Standards
1441-0023	Fixed Front Helmet, 2" x 4.25" Economy, Black		<ul style="list-style-type: none"> Streamlined, compact design allows welders to get into tight places Meets or Exceeds: ANSI Z87-1, CE and various International Standards
1441-0038	Fixed Front Helmet, 4.5" x 5.25" Economy, Black		<ul style="list-style-type: none"> Streamlined, compact design allows welders to get into tight places Meets or Exceeds: ANSI Z87-1, CE and various International Standards
1441-0004	Lift/Fixed Front Combo Helmet, 4.5" x 5.25", Black		<ul style="list-style-type: none"> Streamlined, compact design allows welders to get into tight places Meets or Exceeds: ANSI Z87-1, CE and various International Standards
1423-4100	Hand Welding Shield, 2" x 4.25"		<ul style="list-style-type: none"> Streamlined, compact design allows welders to get into tight places Meets or Exceeds: ANSI Z87-1, CE and various International Standards

Welder's Goggles

Specifications

Part No.	Description		FEATURES	
1423-4181	Shade 5 Protective Eyewear		Rubber arm tips assure comfort and non-slip use, ultra-light frames allow comfortable protection and eliminates 99.9% Ultraviolet light. Hard-coated polycarbonate lens with tilting arms and a contoured frame.	  
1423-0017	Fixed Front, Welder's Goggle Soft Frame		Filter Lens Shade 5 with soft vinyl frame to fit over corrective glasses and adjustable elastic headband.	   
1423-0018	Lift Front, Welder's Goggle Soft Frame		Filter Lens Shade 5 raises easily for on-the-job versatility. Made soft vinyl frame to fit over corrective glasses and adjustable elastic headband.	  
1423-0019	Cup-Type Goggle, 50 mm		Hard Plastic with Shade 5 polycarbonate lens and adjustable elastic headband and nose piece.	   
1423-4175	Grinding Shield with Clear Visor, 8" x 12" x .040"		Ratchet quickly adjusts headband to various sizes.	 
1441-0015	Clear visor for face shield, 8" x 12" x .040"		High grade PETG for excellent protection against paints and mild chemicals. Wide flare for maximum protection and universal hole pattern fits most brand name headgear.	 

Glass Filter Plates

Specifications

Part No.	Description	Size
1441-0047	Filter Plate, Shade #10	2" x 4.25"
1441-0049	Filter Plate, Shade #10	4.5" x 5.25"

FEATURES

- Hardened glass is heat-treated for strength.
- Meets or Exceeds: ANSI Z87-1, all current applicable Federal Specs., CSA Z94.3, CE and various International Standards.

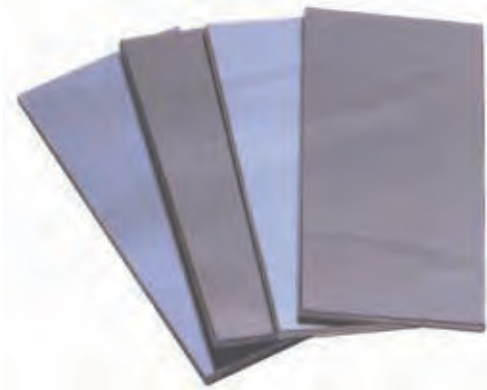

2" x 4-1/4"

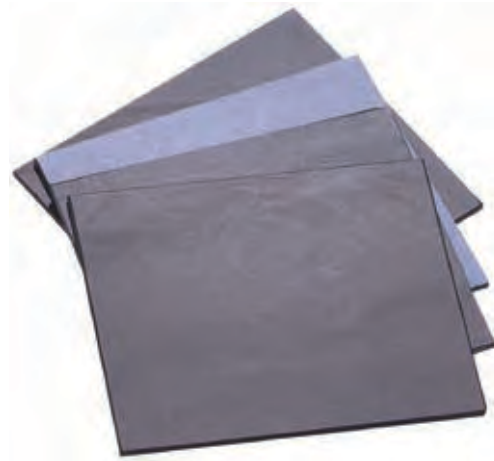

4-1/2" x 5-1/4"

Polycarbonate Cover / Safety Plates

Specifications

Part No.	Description	Size
1441-0048	Polycarbonate Cover/Safety Plate	2" x 4.25"
1423-4107	Polycarbonate Cover/Safety Plate, 3 pc./pk.	2" x 4.25"
1441-0050	Polycarbonate Cover/Safety Plate	4.5" x 5.25"

FEATURES

- Polycarbonate clear safety or cover plates, as components of welding goggles or helmets exceed the high velocity.
- Functions as either cover or safety plate
- Eliminates the accidental use of a cover plate in instances where a safety plate is necessary.



1441-0050



1441-0048

Welding Protective Blanket and Equipment Cover

Specifications

Part No.	Description
1423-1404	Welding Blanket (38" x 24")

FEATURES

- Use our exclusive fiberglass fabric to protect equipment during welding, cutting, grinding and other potentially hazardous operations
- Service range up to 1000° F / 538° C, 20% higher than conventional welding fabrics
- Resistant to abrasion
- Fiberglass fabric can be draped over equipment or used as a curtain to isolate hazardous operations
- Grommets (36"-Centers) for versatility



Welder's Gloves

Specifications

Part No.	Description
1423-0051	Durable Suede Leather Welder's Gloves

FEATURES

- Wing Thumb
- Partially Weltded Seams
- Full Sock Lining
- 14" Flared Gauntlet Cuff
- Self Hem
- Size: L



Premium Welder's Gloves

Specifications

Part No.	Description
1423-4133	Sturdy Suede Leather Welder's Gloves

FEATURES

- Wing Thumb
- Fully Weltded Seams
- 100% Cotton Lining
- 14" Flared Gauntlet Cuff
- Self Hem
- Size: L



Emery Cloth Rolls

Specifications

Part No.	Description
1423-4223	Emery Cloth Roll 1" x 25 Yards, 80-Grit
1423-4224	Emery Cloth Roll 1" x 25 Yards, 120-Grit
1423-4225	Emery Cloth Roll 1" x 25 Yards, 180-Grit
1423-4226	Emery Cloth Roll 1" x 25 Yards, 320-Grit



Files

Specifications

Part No.	Description
1423-4249	Half-Round File
1423-4250	Round Rat-Tail File



Battery/Welding Clamp Pair

Specifications

Part No.	Description
1423-4219	Battery/Welding Clamps, 600 amp



C-Clamp

Specifications

Part No.	Description
1423-4222	C-Clamp 6" Adjustable



Locking Pliers / Clamps

Specifications

Part No.	Description
1423-1419	C-Clamp, 4" Throat Capacity up to 4"
1423-1432	Locking Pliers, 11"

1423-1419



1423-1432

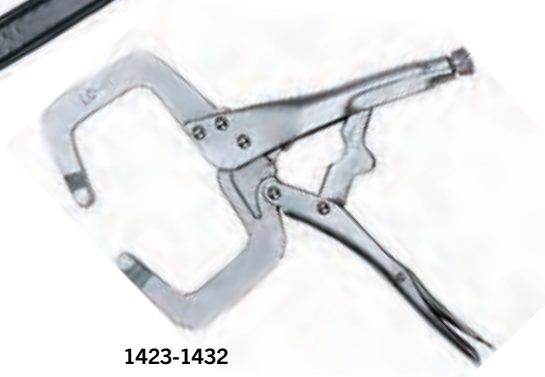

Steel Ground Clamps

Specifications

Part No.	Amperage Capacity	Jaw Opening	Cable Capacity	Length
1443-0025	200	Up to 1"	1/0	6"
1443-0026	300	Up to 2"	2-1	8"
1443-0027	500	Up to 2"	1/0-4/0	10"

FEATURES

- Large contact area assures positive grounding
- Zinc plated
- Large hex screw cable connection assures safe cable connection every time
- Pure copper braided shunts on 1443-0027 allows both jaws to carry welding current

1443-0025



1443-0026



1443-0027



Cable Lugs

Specifications

Part No.	Cable Capacity	Amperage	Stud Hole	ID of Socket	Pack
1443-0003	4-6	100	21/64"	11/32"	2 pc./pk.
1443-0004	6-2	150	17/32"	1/2"	2 pc./pk.
1443-0005	1-2/0	200	17/32"	35/64"	2 pc./pk.

FEATURES

- Copper Alloy Lugs



1443-0003



1443-0004



1443-0005

Chipping Hammer

Specifications

Part No.	Description
1423-0086	Cone and Chisel, 12", 14 oz.

FEATURES

- Hammer heads are hardened to precisely controlled temperatures for durability and strength
- Wide-blade design removes slag faster and adds to life of the tool



Crimper™ Heavy Duty Lug/Splicer Crimping Tool

Specifications

Part No.	Jaw Opening	Cable Capacity
1423-1209	Up to 1"	6-4/0

FEATURES

- Durable spring loaded mechanism holds Terminal/Lug in place
- Delivers 1400-1800 lbs pull-out resistance (Terminal To Cable)



Welper® MIG Pliers (8 tools in one!)

Specifications

Part No.	Description
1423-1428	Welper, MIG Pliers

FEATURES

- Designed for hammering, wire cutting, insulator bushing removal and installation and drawing out wire
- Perfect for removal and installation of contact tips and nozzles

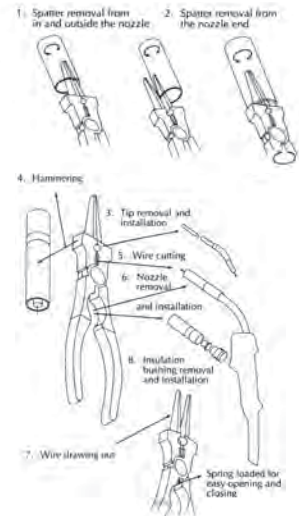

Lightnin' Bug® Torch Lighter

Specifications

Part No.	Description
1423-1423	Lightnin' Bug, Torch Lighter

FEATURES

- Tested to 300,000 Strikes!
- Easy and accurate ignition insured by multi-spark discharge
- Zinc Plated body resists rust and corrosion



Single Flint, Triple Flint and Flint Replacements

Specifications

Part No.	Description
1423-0026	Single Flint Spark Lighter
1423-0032	Flints for Single Flint Spark Lighter, 1 Holder/pk. (5 pcs.)
1423-0050	Triple Flint Spark Lighter
1423-0052	Flints for Triple Flint Spark Lighter, 2 per Pack



Tip Cleaners

Specifications

Part No.	Description
1423-0016	Standard Tip Cleaner
0387-0487	King Size Tip Cleaner

APPLICATIONS

Standard

Set of 13 cleaners with file.
Sizes #6 through #26 for cleaning Drill Size 77-49.

King Size

Set of 13 cleaners Extra Long with file.
Sizes #6 through #26 for cleaning Drill Size 77-49.

Clean Hole

Gauge	Wire Dia.	Ridge Dia.	Diameter Inch	Drill Size
6	0.014	0.016	.018-.020	77-76
7	0.018	0.020	.021-.022	75-74
8	0.021	0.023	.024-.026	73-71
10	0.024	0.026	.028-.031	70-68
12	0.028	0.030	.032-.035	67-65
14	0.032	0.034	.036-.038	64-62
15	0.035	0.038	.039-.040	61-60
16	0.037	0.040	.041-.042	59-58
17	0.039	0.042	.043-.046	57
18	0.042	0.044	.046-.051	56
22	0.048	0.050	.052-.055	55-54
24	0.055	0.057	.060-.064	53-52
26	0.062	0.065	.067-.073	51-49



King Size



Standard

Tip Drill Cleaner Kit (12 piece)

Specifications

Part No.	Description
1423-1408	Tip Drill Kit, 12 pc., Drill sizes: #52-74

FEATURES

- Cleans and Trues most Standard Orifices
- Contains most commonly used 12 drills (#57-74) in assorted sizes
- Complete with Built-in Chuck and Pocket Clip
- Drills are stored inside



Tip Drill Cleaner

Soapstones & Soapstone Holders

Specifications

Part No.	Description
1423-0095	Flat Soapstone, 6 pcs./pk.
1423-0094	Round Soapstone, 5 pcs./pk.
1423-0097	Flat Soapstone Holder
1423-0096	Round Soapstone Holder



Flat Soapstone



Round Soapstone

Oxy-Fuel Gas Hose Repair Kit

Specifications

Part No.	Description
1420-0296	DK-FP; Complete Dealer Kit*



*Includes: "A" and "B" size hose fittings with KI2B vise-grip type crimping tool. Contains nuts, nipples, couplers, splicers and ferrules for 1/4" and 3/16" I.D. hose.

4-Way Pick Set

Specifications

Part No.	Description
1423-1435	4-Way Pick Set

FEATURES

- Knurled 5" aluminum handle
- Four tempered steel picks 3" long – screw into handle



Mag Tool™ Multi-Purpose Magnetic Holders

Specifications

Part No.	Size	Dimensions
1423-1425	Medium	4.7" x 3.4" x 0.56"
1423-1426	Large	6.3" x 4" x 0.63"

FEATURES

- Mag Tool will hold both sheet and tube at angles of 45°, 90° and 135° Clip

Magnet: Anisotropic Ferrite

** In contact with ferrous objects of adequate thickness and smooth surface finish.

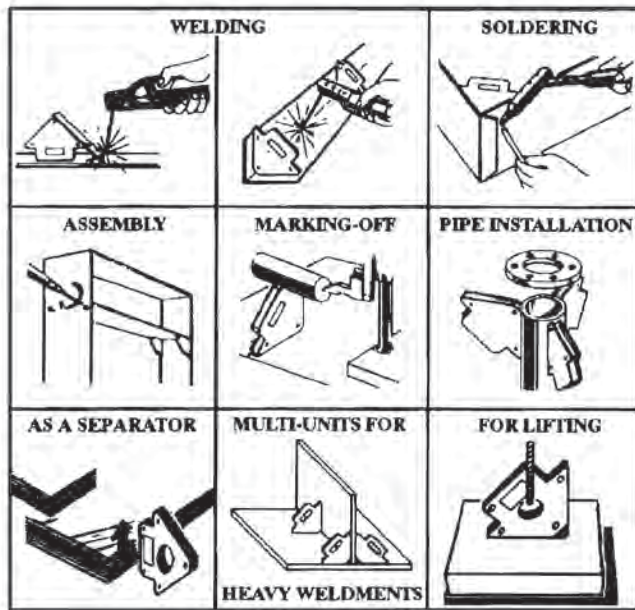

1423-1425

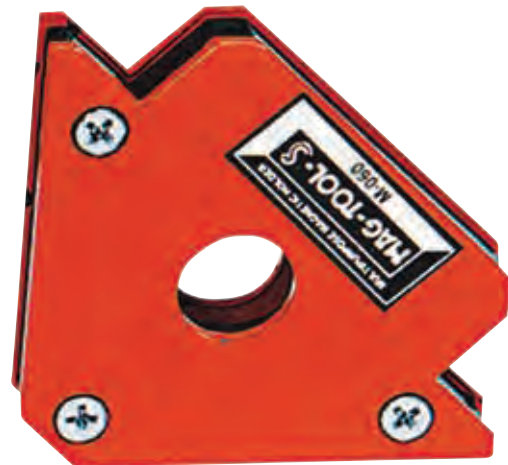

1423-1426

Handyguard™, Welding Rod Storage Tube

Specifications

Part No.	Description
1421-0062	Handy Guard, Weld Rod Storage Tube

APPLICATIONS

Weld rod storage tubes provide great storage for all your welding electrodes, rods and filler metals. Chloride-free and features a threaded cap with long lasting neoprene seal to keep electrodes airtight-preventing them from being contaminated with atmospheric moisture.

- Holds up to 10 lbs of 12" or 14" Electrodes



Scratch Brushes / Curved Long Handle Brushes

Specifications

Part No.	Wire	No. of Rows
1423-0087	Carbon Steel	3 x 19
1423-0082	Stainless Steel	3 x 19

Carbon Steel Hand Brushes can be used to prepare and clean weldments on mild steel and ferrous metals. Stainless Steel Hand Brushes can be used to prepare and clean weldments on stainless steel and aluminum.

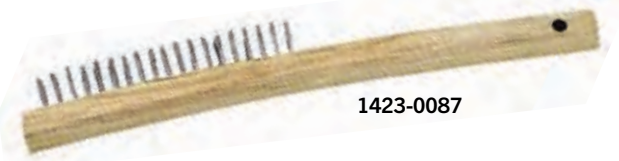

1423-0087

Scratch Brushes / Shoe Handle Brushes

Specifications

Part No.	Wire	No. of Rows
1423-0083	Carbon Steel	4 x 16
1423-1442	Stainless Steel	4 x 16

Carbon Steel Hand Brushes can be used to prepare and clean weldments on mild steel and ferrous metals. Stainless Steel Hand Brushes can be used to prepare and clean weldments on stainless steel and aluminum.

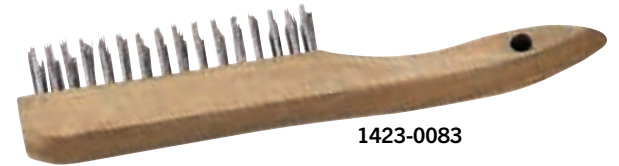

1423-0083

Scratch Brushes / Welders Toothbrush Style

Specifications

Part No.	Wire	No. of Rows
1423-0081	Stainless Steel Tinning	3 x 7
1423-0084	Brass	3 x 7
1423-1400	Brass	2 x 9

Stainless Steel Hand Brushes can be used to prepare and clean weldments on stainless steel and aluminum. Brass Hand Brushes can be used to prepare and clean solder joints on copper and brass.



1423-0081

1423-0084

Scratch Brushes / Carbon Steel

Specifications

Part No.	Wire
1423-4215	Carbon Steel

Carbon Steel Hand Brushes can be used to prepare and clean weldments on mild steel and ferrous metals.



Scratch Brushes / Small Scratch Brush

Specifications

Part No.	Wire	No. of Rows
1423-4216	Brass	
1423-4217	Stainless Steel	

Stainless Steel Hand Brushes can be used to prepare and clean weldments on stainless steel and aluminum. Brass Hand Brushes can be used to prepare and clean solder joints on copper and brass.



1423-4217

Flux Brushes

Specifications

Part No.	Trim Width	Trim Length	Total Length	Pack
1423-0093	1/2"	3/4"	5.75"	3 pc./pk.

Flux Brush can be used to apply liquid or paste fluxes. Do not use a single brush with multiple fluxes. Brass Hand Brushes can be used to prepare and clean solder joints on copper and brass.



Parts Cleaning Brush

Specifications

Part No.	Handle	Length
1423-1402	Plastic	10.5"

Parts Cleaning Brush can be used in nearly any solvent. See page 49 for more brush information.



End Brushes

Specifications

Part No.	Wheel Diameter	Type	Wire Size	Max. RPM
CIRCULAR TYPE: 1/4" SHANK, CARBON STEEL WIRE				
1423-2100	1.5"	Coarse	.014"	4,500
1423-2101	2"	Coarse	.014"	4,500
1423-2102	3"	Coarse	.014"	4,500
1423-2103	3"	Fine	.008"	4,500

1423-2100



CRIMP TYPE: 1/4" SHANK, CARBON STEEL WIRE				
1423-2104	3/4"	Coarse	.014"	4,500
1423-4204	3/4"	Coarse	.020"	20,000
1423-2117	1"	Coarse	.014"	4,500
1423-4211	1"	Coarse	.020"	20,000

1423-2104



KNOT TYPE: 1/4" SHANK, CARBON STEEL WIRE				
1423-2105	3/4"	-	.020"	20,000
1423-2118	1.5"	-	.020"	20,000

1423-2105



Firepower® small diameter wire brushes are designed for use in restricted or hard-to-reach areas. They are excellent for deburring, blending and cleaning of surfaces. Small diameter brushes are especially designed for use on portable air and electric tools. Applications include deburring, blending, removal of rust, cleaning. End brushes are great for cylinder heads, pistons and valve ports, rubber and plastic flash removal, removal of rust, paint scale, tool polishing, and weld cleaning.

Safety First - Always Grind Safely!

Warning! Failure to Observe Safety Procedures May Result in Serious Injury:

Complies with Safety Standards of the Industrial Division of the American Brush Manufacturers Association and the American National Standards Institute ANSI B165.1-1985 "Safety Requirements for the Design, Care and Use of Power Driven Brushing Tools".

Always Wear Protective Equipment:

Impact resistant Safety Glasses or Goggles, Full Face Shield, Safety shoes, Arm Guards, Leather Gloves, Apron and other appropriate protective clothing must be worn by all operators and other employees working in the area of power brush operations. Always wear a respirator to avoid inhalation of dust particles.

Machine Guards Must Be Used:

Power brushes should be used only on machines that are equipped with Safety Guards, and they must be in place at all times.

Check Specifications On Mounting Brushes:

Check appropriate RPM before mounting any brush on a power tool. Arbor hole and spindle diameter should be a free fit. Spindle length should be sufficient to accept a full-nut mounting. Direction of spindle nut thread should be opposite to the direction of the spindle rotation so that the nut will tighten as the spindle revolves.

Always Inspect Before Use:

Carefully check all brushes in the original carton. Do Not Use if they are rusty or damaged. Brushes should be stored in the original cartons and should not be exposed to high humidity or other detrimental environmental conditions.

Always Observe Speed Limitations:

Observe all speed restrictions indicated on the brushes, containers, labels, or printed in pertinent literature. For reasons of safety, the "Max. RPM" Must Not be exceeded under any circumstances.

Wire Cup Type

Specifications

Part No.	Cup Diameter	Wire Size	Max. RPM
CRIMP TYPE: 1/4" SHANK, CARBON STEEL WIRE			
1423-2106	1.5"	.014"	4,500
1423-2107	2.5"	.014"	4,500
1423-2108	2.5"	.008" (Fine)	4,500
CRIMP TYPE: 5/8" - 11 NC THREADED ARBOR, CARBON STEEL WIRE			
1423-2109	3"	.014"	12,500
1423-3158	4"	.014"	8,500
1423-4210	5"	.020"	6,500
KNOT TYPE: 3/8" - 24 NF THREADED ARBOR, CARBON STEEL WIRE			
1423-3159	3"	.020"	12,500
KNOT TYPE: 5/8" - 11 NC THREADED ARBOR, CARBON STEEL WIRE			
1423-2110	3"	.020"	12,500
1423-2115	4"	.020"	8,500
1423-2116	6"	.020"	6,500
KNOT TYPE: 5/8" - 11 NC THREADED ARBOR, STAINLESS STEEL WIRE			
1423-4214	2 3/4"	.014"	12,500

Firepower® wire cup brushes are designed for use on portable power tools. Made with high quality tempered wire, Firepower brushes provide fast cutting action for removal of light encrustation of scale, rust, paint or weld splatter. The relative high flexibility of Firepower wire cup brushes allows cleaning on irregular surfaces as well as flat surfaces.

Cup Brushes with 1/4" Stem: Small diameter cup brushes are designed for use in restricted or hard to reach areas. They are excellent for carbon cleaning, polishing, removal of scale, slag, rust and paint.

Cup Brushes Crimped Wire: Heavy-duty cup brushes with arbor adapters and threads to fit most grinders.

Cup Brushes Stainless Steel Knotted Wire: Heavy-duty cup brushes with arbor adapters and threads for most grinders. Stainless steel wire brushes are used to reduce discoloration and corrosion on stainless and aluminum alloys. Stainless steel wire brushes are highly corrosion resistant and should be used where contamination or after rust is a problem.



1423-2106



1423-2109



1423-3159



1423-2110

Crimped and Knot Style

Specifications

Part No.	Wheel Diameter/Width	Wire Size	Arbor Hole	Max. RPM
CIRCULAR TYPE: 1/4" SHANK, CARBON STEEL WIRE				
1423-2327	4" dia. x 1/2" wide	.014"	5/8"-11 NC	8,000
1423-2121	6" dia. x 1/2" wide	.014"	5/8"-1/2"	6,000
1423-2122	6" dia. x 1" wide	.014"	5/8"-1/2"	6,000
1423-2123	8" dia. x 1.25" wide	.014"	5/8"-1/2"	4,500

CIRCULAR TYPE: STAINLESS STEEL WIRE

1423-4213	8" dia. X 1.50" wide	.012"	5/8"-1/2"	4,500
-----------	----------------------	-------	-----------	-------

CRIMP TYPE: 1/4" SHANK, CARBON STEEL WIRE

1423-2111	4" dia.	.020"	5/8"-11 NC	12,500
-----------	---------	-------	------------	--------

KNOT TYPE: 1/4" SHANK, CARBON STEEL WIRE

1423-2113	4" dia.	.020"	5/8"-11 NC	12,500
1423-4209	4" dia.	.020"	5/8"-11 NC	20,000
1423-2120	6" dia.	.020"	5/8"-1/2"	9,000

Firepower® knot-style wire wheel brushes are designed for tough jobs. Each individual knot contains an equal number of top quality high carbon tempered wires, which gives the wheel an exact balance and long-life. Firepower brushes can be furnished in either standard twist in carbon and stainless steel. Firepower brushes are well-suited for use in the welding and fabricating industries. They are used for surface preparation prior to welding and brazing and for removing weld scale and spatter after the welding operation.



1423-2121



1423-2113



1423-2111

Arbor Reducing Adaptors

Specifications

Part No.	Description
1423-2124	Arbor Reducing Adaptor, 5/8"-11 to M10 x 1.25
1423-2125	Arbor Reducing Adaptor, 5/8"-11 to M10 x 1.5

APPLICATIONS

For both cup and wheel brushes - the fixed 5/8"-11 arbor hole of each brush can be adapted to M10 x 1.25, M10 x 1.50 and 3/8-24 NF by using arbor reducing adapter.



1423-2124

Mandrel Set

Specifications

Part No.	Size
1423-2185	1/4" Diameter Shank

FEATURES

- Made of high strength alloy steel
- Ideal for small diameter cut-off wheels with a thickness of 1/32" to 1/4"
- For cut-off wheels with an inner diameter of 1/4" or 3/8"

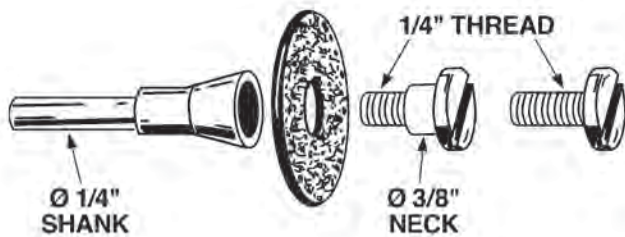

CAUTION! Rotary files are for use on electrical power drills only. They are not recommended for use on pneumatic or hydraulic tools.

Steel Rotary Files

Specifications

Part No.	Size	Shape
1423-2224	1/2" x 7/8"	Cylindrical
1423-2226	1/2" x 1/2"	Ball
1423-4240	1/2" x 7/8"	Round Tree
1423-4241	1/2" x 7/8"	Cylindrical Ball Nose
1423-4242	1/2" x 7/8"	14 Degree Angle

FEATURES

- Rotary files offer perfect solutions for the welding jobs: Trimming welds, grinding smooth fillets & preparation for welds
- Repairs can be easily done because of a variety of shapes and sizes available
- All rotary files have a standard shank of 1/4" (6 mm)
- Note: use lower speeds when cutting harder ferrous materials and higher speeds for softer non-ferrous materials



Steel Rotary Rasps

Specifications

Part No.	Size	Shape
1423-3177	1/2" x 7/8"	Cylindrical

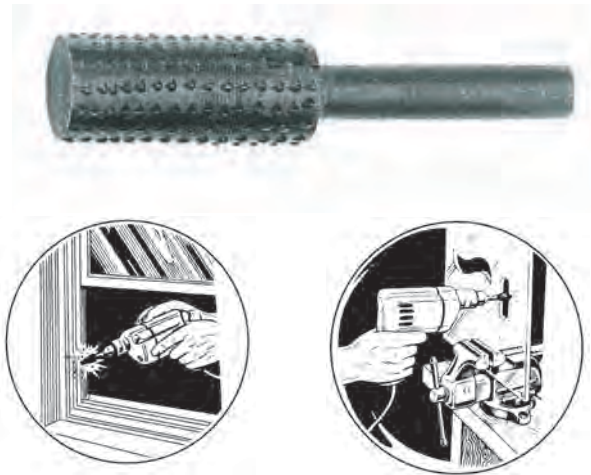

Mounting Points

Specifications

Part No.	Type & Shape	Size	Max. RPM
		(Dia. x Length x Shank)	
1423-2202	A11	7/8" x 2.75" x 1/4"	19,000
1423-4232	A5	3/4" x 1 1/8" x 1/4"	30,000
1423-4234	W218	1" x 1/2" x 1/4"	30,000
1423-4235	W220	1" x 1" x 1/4"	30,000

FEATURES

- Offer maximum performance for grinding of ferrous and non-ferrous metals. For use with horizontal or straight shaft, die and pencil grinders on jobs where larger cones and plugs won't fit
- Excellent for medium to heavy duty applications in metal fabrication, foundries, steel mills. Used for grinding ferrous and non-ferrous metals
- Ideal for rapid stock removal on high alloy steel, castings and special steel



CAUTION
Abrasive users and others in area must wear goggles or face shields over safety glasses

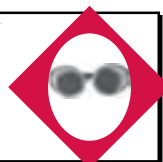

Abrasive

Specification Example: A-36-S-B-2 FG

ABRASIVE	GRIT	GRADE	BOND TYPE	REINFORCEMENT
A	36	S	B	2 FG

Legend: Select one from each column.

ABRASIVE	GRIT	GRADE	BOND TYPE	REINFORCEMENT
A = Aluminum Oxide	Coarse: #16-24	Soft: H, I, J, K	B = Resinoid	1 FG = Inter-woven
	Medium: #30-60	Medium: L, M, N, O, P		
C = Silicon Carbide	Fine: #80-220	Hard: Q, R, S, T	V = Vitrified	2 FG = Double Reinforced

Safety First - Always Grind Safely!

Safety: Always DO the following:

1. Always handle and store abrasives in a careful manner.
2. Always visually inspect all abrasives before mounting for possible damage in transit, storage, or prior use.
3. Always "Ring Test" the wheel by tapping gently with a light metallic implement such as the handle of a screwdriver for light wheels, or Wooden or Plastic Mallet for heavier wheels. An undamaged wheel will give a clear tone.
4. Always make sure the operating speed established for the equipment does not exceed the wheel speed.
5. Always check mounting flanges for equal and correct diameter.
6. Always use mounting blotters when supplied with abrasives.
7. Always keep work rest properly adjusted within 1/8" (3 mm) of wheel face.
8. Always direct grinding sparks downward and away from the face and body.
9. Always wear protective equipment such as, impact resistant safety glasses or goggles, full face shield, safety shoes, arm guards, leather gloves and apron must be used for operator protection for all grinding operations. Always wear a respirator to avoid inhalation of dust particles.
10. Always use a safety guard covering at least one-half of the wheel diameter.
11. Always allow newly mounted wheels to run at operating speed, with the guard in place, for at least one minute before starting to grind.
12. Always observe all safety recommendations supplied by the Equipment Manufacturer.

DO NOT attempt the following:

1. Do Not use a wheel that has been dropped.
2. Do Not use wheels that have been soaked in water
3. Do Not use wheels without guards for grinding or cutoff work.
4. Do Not force a wheel onto the spindle or alter the hole of size the wheel.
5. Do Not use a wheel that fits the arbor too loosely.
6. Do Not exceed maximum operation speed established for the wheel.
7. Do Not use dirty, nicked, warped or sprung mounting flanges.
8. Do Not tighten the mounting nut excessively.
9. Do Not grind on the side of the wheel unless the wheel is specifically designed for that purpose.
10. Do Not start machine unless the machine guard is in place.
11. Do Not jam work into the wheel. Let the wheel do the work.
12. Do Not apply excessive pressure.
13. Do Not stand directly in front of a grinding wheel whenever a grinder is started.
14. Do Not grind near flammable material.
15. Do Not grind or cut material for which the wheel is not designed.
16. Do Not flat grind. Minimum grinding angle is 15°.
17. Do Not use relieved or recessed flanges with threaded hole cup wheels, cone or plugs.
18. Never use a wheel or a disc that has been dropped, chipped, mishandled or appears defective.

Cut-Off & Chop-Saw Abrasive Wheels, Type 1 (For Metal)

Specifications

Part No.	Size	Max. RPM	Grade
TYPE 1, ABRASIVE CUT-OFF WHEELS			
1423-3149	3" x 1/32" x 3/8"	25,000	A60T2FG
1423-3181	3" x 1/32" x 3/8" (5 pc./pk.)	25,000	A60T2FG
1423-3142	3" x 1/16" x 1/4"	25,000	A46T2FG
1423-3143	3" x 1/16" x 3/8"	25,000	A46T2FG
1423-3155	3" x 1/16" x 3/8" (5 pc./pk.)	25,000	A46T2FG
1423-2178	3" x 1/16" x 3/8" (10 pc./pk.)	25,000	A46T2FG
1423-3208	3" x 1/8" x 1/4"	25,000	A46T2FG
1423-3144	3" x 1/8" x 3/8"	25,000	A46T2FG
1423-2180	3" x 1/8" x 3/8" (5 pc./pk.)	25,000	A46T2FG
1423-3150	4" x 1/32" x 3/8"	18,000	A60T2FG
1423-3182	4" x 1/32" x 3/8" (5 pc./pk.)	18,000	A60T2FG
1423-3145	4" x 1/16" x 3/8"	18,000	A46T2FG
1423-4246	4" x 1/16" x 3/8" (5 pc./pk.)	18,000	A46T2FG
1423-3147	4" x 1/16" x 5/8"	18,000	A46T2FG
1423-3157	4" x 1/16" x 5/8" (5 pc./pk.)	18,000	A46T2FG
1423-3146	4" x 1/8" x 3/8"	18,000	A46T2FG
1423-3148	4.5" x 1/16" x 7/8"	13,300	A46T2FG
1423-3184	4.5" x 1/16" x 7/8" (5 pc./pk.)	13,300	A46T2FG
1423-3185	4.5" x 1/8" x 7/8"	13,300	A46T2FG
1423-4244	4.5" x 3/32" x 7/8" (5 pc./pk.)	13,300	A46T2FG
1423-3188	6" x .045" x 7/8"	10,200	A60T2FG
1423-3211	6" x 1/16" x 5/8"	10,200	A60T2FG
1423-2213	7" x 1/8" x 5/8" Diamond Hole	8,500	A36S 2FG

FOR STATIONARY CHOP-SAWS ONLY

1423-2305	10" x 1/8" x 5/8"	6,100	A36S 2FG
1423-3189	10" x 3/32" x 1"	6,100	A46S 1FG
1423-2197	12" x 3/32" x 1"	5,100	A46S 1FG
1423-2198	14" x 3/32" x 1"	4,400	A46S 1FG

FOR PORTABLE HIGH SPEED CHOP-SAWS

1423-3191	12" x 5/32" x 1"	6,300	A36S 2.5FG
1423-3193	14" x 5/32" x 1"	5,400	A36S 2.5FG

Firepower® Double Reinforced Cut-Off Wheels are designed for heavy duty cut-off jobs using circular saws, chop-saws and straight grinding machines. They ensure optimum effectiveness for dry applications on a broad

range of ferrous and non-ferrous metals, soft ceramics, masonry materials, reinforced plastic and fiber glass. Most Firepower cut-off wheels are double reinforced with two layers of fiber glass.



Use Tips for Firepower Cut-Off Wheels:

1. When using cut-off wheels, a soft pressure should be used for initial contact with the workpiece - cutting should be done with even constant pressure.
2. For stationary cut-off machinery, it is important to have good stability and steadiness to prevent vibration. Also, the motor should be powerful enough to keep the cutting time as short as possible to prevent burning or discoloring the material
3. Material being cut or ground should always be clamped or securely positioned, especially in cutting-off operations.
4. Proper machine speed is essential for maximum efficiency. Low speed causes "Jumping" of the disc, and can cause the circumference to wear unevenly.
5. Flat cut-off wheels can be brushed, if required.

Firepower® Cut-Off Wheel Safety and Cutting Procedures:

1. Cut-off wheels should never be stored on edges. They should be laid on a solid flat surface and away from excessive heat to prevent warpage.
2. Machines must have adequate power transmission and capacity, spindle speeds and proper guarding of the wheel. It is best to have extra power to insure good cutting efficiency. Check the speed of the machine spindle against the maximum speed specified for the wheel by the manufacturer. The maximum specified speed for the wheel should never be exceeded.
3. Flanges should be clean, straight and of the same diameter, so the wheel can turn true. For wheel diameters above 10" (250 mm) it is highly recommended that the flange be a least 1/3 the diameter of the wheel.
4. The bore size of the wheel is so constructed that the wheel should fit freely on the machine spindle without any slack. Never attempt to force a wheel on the spindle! Always use blotters, when supplied with the wheel. Be sure the flanges are tightened securely but not too tightly to avoid springing the flanges and change the pressure area.
5. Be sure work-piece is securely held down, including both sides of the cut, if practical. Cut-off wheels withstand a great deal of radial stress but not any side stress. Even reinforced wheels are not completely unbreakable. Side pressure must be avoided to insure straight cuts and avoid possible wheel breakage. The wheel must be brought into contact with the work without "Bumping" or impact. The wheel should cut freely without forcing and the speed of the wheel should not be reduced by the cutting operation.
6. Abrasive cutting generates a great deal of localized heat, which causes rapid expansion of the piece being cut. Wheels operated at speeds significantly below efficient speed or if fed through the cut to slowly will generate excessive heat. Result: rapid wheel wear, fraying around the edge of reinforced wheels and wheel breakage. Always use at the "efficient speed" as specified for the wheel by the manufacturer.

Depressed Center Grinding Wheels, Type 27

Specifications

Part No.	Size	Max. RPM	Grade
WITHOUT HUBS			
1423-3151	4" x 1/8" x 5/8"	13,700	A36S
1423-2186	4" x 1/8" x 5/8" (5 pc./pk.)	13,700	A36S
1423-3152	4" x 1/4" x 5/8"	13,700	A24R
1423-2187	4" x 1/4" x 5/8" (5 pc./pk.)	13,700	A24R
1423-3186	4.5" x .045" x 7/8"	13,300	A36S
1423-3199	4.5" x 1/8" x 7/8"	13,300	A36S
1423-3153	4.5" x 1/4" x 7/8"	13,300	A36S
1423-2188	4.5" x 1/4" x 7/8" (5 pc./pk.)	13,300	A36S
1423-2189	5" x 1/4" x 7/8"	12,000	A24R
1423-2191	7" x 1/4" x 7/8"	8,500	A24R
1423-4247	4.5" x .05" x 7/8" (5 pc./pk.)	13,300	A46T2FG
WITH HUBS			
1423-3201	4.5" x 1/8" x 5/8"-11 NC	13,300	A24R
1423-2232	4.5" x 1/4" x 5/8"-11 NC	13,300	A24R
1423-3203	7" x 1/8" x 5/8"-11 NC	8,500	A24S
1423-2190	7" x 1/4" x 5/8"-11 NC	8,500	A24S
1423-2192	9" x 1/4" x 5/8"-11 NC	6,500	A24S



Firepower® depressed center wheels are fully reinforced with resin bonded aluminum oxide to ensure safety at high speed and to increase bonding and impact strength. Designed for use on air or electric powered right angle or vertical shaft grinders. Available with or without hubs.



Techniques/Tips for proper Firepower Grinding Wheels:

1. Use this method to achieve the desired aggressiveness of stock removal and quality finish - for fast material removal increase the grinding angle between the wheel and the workpiece. For blending and finishing decrease the grinding angle and apply light pressure in a fluid motion.
2. For maximum efficiency, Type 27 Depressed Center Wheels should be used with an approach angle of 30°-35° to the workpiece.
3. Material being cut or ground should always be clamped or securely positioned, especially in cutting-off operations.
4. Proper machine speed is essential for maximum efficiency. Low speed causes "Jumping" of the disc, and can cause the circumference to wear unevenly.
5. Only flat cut-off wheels can be brushed, not depressed center wheels. Only 7/8" arbors can be made to 5/8"-11.

Bench Grinding Wheels, Type 1

Specifications

Part No.	Size	Grit
1423-2311	6" x 3/4"	36
1423-2310	6" x 3/4"	60
1423-2312	6" x 3/4"	80

FEATURES

- Wheels are individually precision balanced, trued and faced for smooth operation
- Each wheel is individually boxed so they stay clean and undamaged until use
- Designed for versatile off-hand grinding in deburring barstock after cutting and touching up, reconditioning and sharpening tools where precision grinding is not required
- Grinding is done on the wheel periphery only
- Aluminum oxide wheel grinds metal of high tensile strength, like steel and steel alloy



Safety First - Always Grind Safely!

Always ensure grinding wheels and machines are in good working condition. Damaged or improperly used grinding wheels are dangerous. Machine guards are for protection - use them. Wear adequate personal protection. All Firepower® abrasives are manufactured under rigid quality conditions to ensure product strength and safety. However, approved guards and protective equipment,

such as, impact resistant safety glasses, full face shield, safety shoes, arm guards, leather gloves and apron must be used for operator protection for all grinding operations. Always wear a respirator to avoid inhalation of dust particles. For information on product safety, please ask us for ANSI B7.1 "Safety Requirements for the use, Care and Protection of Abrasive Wheels".

Techniques/Tips for proper Firepower Grinding Wheels:

1. Use this method to achieve the desired aggressiveness of stock removal and quality finish - for fast material removal increase the grinding angle between the wheel and the workpiece. For blending and finishing decrease the grinding angle and apply light pressure in a fluid motion.
2. For maximum efficiency, Type 27 Depressed Center Wheels should be used with an approach angle of 30°-35° to the workpiece.
3. Material being cut or ground should always be clamped or securely positioned, especially in cutting-off operations.
4. Proper machine speed is essential for maximum efficiency. Low speed causes "Jumping" of the disc, and can cause the circumference to wear unevenly.
5. Only flat cut-off wheels can be brushed, not depressed center wheels. Only 7/8" arbors can be made to 5/8"-11.

Flap Discs Aluminum Oxide, Type 27

Specifications

Part No.	Grit
4.5" X 7/8" (WITHOUT HUB) MAX RPM: 13,300	
1423-4236	A0 36
1423-4237	A0 60

Flap Discs Zirconia, Type 29

Specifications

Part No.	Grit
4.5" X 7/8" (WITHOUT HUB) MAX RPM: 13,300	
1423-3162	ZA 36
1423-3163	ZA 60
1423-3164	ZA 80

4.5" X 5/8" -11 NC (WITH HUB) MAX RPM: 13,300

1423-2220	ZA 36
1423-2221	ZA 60

Firepower® flap discs durability over the conventional fibre disc results in reduction of both labor and material costs. They are designed to wear away evenly and present a constantly fresh working surface.

- Cut and finish at the same time with consistent finish - for coarse and intermediate grinding and machining of welds, deburring, rust removal, snagging, removal of paint, etc. This means fewer change-overs
- Suitable for almost all materials: ferrous and non-ferrous metals, wood, leather, glass, marble and plastics
- No loading-up, as new sharp abrasive particles are constantly exposed
- No backing pad required - comes with fiberglass backing plate with higher RPM rating than resin fiber discs
- Firepower flap discs have the ideal operating angle of 10°. This allows for maximum use of the laminates and guarantees optimum stock removal produced by a continuously free cutting abrasive
- Excessive pressure leads to a higher wheel-wear, without increasing performance



Recommendation:

- We recommend using the following grit sizes to attain a maximum stock removal rate
 - Grit 36*: For all alloyed and low-alloyed steels
 - Grits 60 & 80*: For high alloyed steel, stainless steel, high-temperature and heat treatable steel and high tensile, non-ferrous metals
- * **A coarser grit offers the advantage of a higher stock removal rate and service life**

Safety First - Always Grind Safely!

To avoid injury always wear complete body protection at all times: Impact-resistant protective glasses, full face shield, safety shield, safety shoes, arm guards, leather gloves and apron for all grinding operations. Always wear

a respirator to avoid inhalation of dust particles. Persons entering an area where grinding is taking place, must always wear adequate and approved face and body protection.

For Abrasive Disc Grinding:

1. Never use larger diameter disc than specified by the manufacturer
2. Never exceed maximum RPM
3. Always check the pad for concentricity.
4. Always check for snug fit and full-thread contact.
5. Always use the grinders safety pad.
6. Always check the spindle for wobble.
7. Always check the disc retainer nut for thread wear.

Resin Fiber Sanding Discs and Hand Pads

Specifications

Part No.	Grit
5" X 7/8" (3 PC./PACK) MAX RPM: 11,000	
1423-2164	A.C 24
1423-2165	A.C 36
1423-2166	A.C 50

7" X 7/8" (3 PC./PACK) MAX RPM: 7,600	
1423-2171	A.C 24
1423-2172	A.C 36
1423-2173	A.C 50

Firepower® resin fibre discs have the best combination of the highest quality aluminum oxide grains and heavy-duty vulcanized fibre-cloth backing bonded with strong, heat resistant resin.

- Excellent for removing rust, oxides and surface imperfections
- Maximum performance on portable right angle grinders
- Firepower resin fibre discs should be mounted on a rubber backing pad, for optimum performance



Safety First - Always Grind Safely!

To avoid injury always wear complete body protection at all times: Impact-resistant protective glasses, full face shield, safety shield, safety shoes, arm guards, leather gloves and apron for all grinding operations. Always wear

a respirator to avoid inhalation of dust particles. Persons entering an area where grinding is taking place, must always wear adequate and approved face and body protection.

For Abrasive Disc Grinding:

1. Never grind without a proper back-up pad
2. Never exceed maximum RPM
3. Never use larger diameter disc than specified by the manufacturer
4. Never use back pad without first inspecting it for signs of irregularities such as fractures, excessive wear, nicks, cuts at the edges or the center hole.
5. Always check the pad for concentricity. Always check the grinder spindle for wobble. Always check the disc retainer nut for thread wear. Install the pad on the tool securely. Check for snug fit and full-thread contact.
6. Direct grinding sparks downward and away from the face and body. Do Not Grind near any flammable material.
7. Never use another grinding disc as a back-up pad.
8. Never exceed maximum RPM.
9. Always use the grinders safety pad.
10. Operate grinder with disc and pad inclined approximately 5°-15° from the work surface. Grind depressions, moulding, lips and heavy welds with the grinder moving away from the work area and not into it. Avoid grinding near the edge, corner or projections that can snag the edge of the pad or disc.
11. Always observe all safety recommendations supplied by the equipment manufacturer.

Quick Change and Surface Conditioning Discs, Type III

Specifications

SURFACE CONDITION DISCS, 3"

Part No.	Grit/Color	Type	Pcs./pk.
1423-2140	Brown	Coarse	10
1423-2141	Maroon	Medium	10

SURFACE CONDITION DISCS, 2"

1423-4228	Gray	Fine	10
1423-4229	Maroon	Medium	10
1423-4230	Brown	Coarse	10

QUICK CHANGE BACKING PAD

1423-4231		Ø 2" x 1/4" Shank	
1423-2143		Ø 3" x 1/4" Shank	

- Provide low vibration, less tool down time, and longer disc life
- Designed for quick disc and grit changes
- These time saving discs are quickly and firmly mounted on a special reusable 1/4" mandrel
- Surface conditioning discs provide superior performance for: Scratch removal, Removing flash, rust and oxidation, light deburring, blending welds, blending and conditioning metal surfaces and removing heat discoloration
- Maximum RPM: 5,000



1423-4230



1423-4231

CAUTION

Abrasive users and others in area must wear goggles or face shields over safety glasses

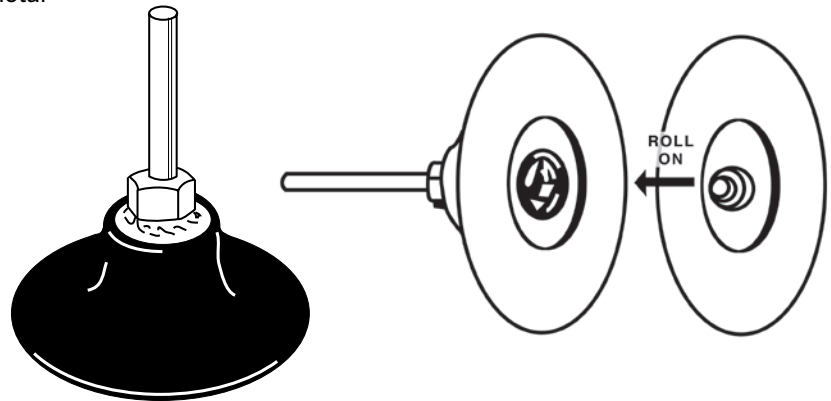
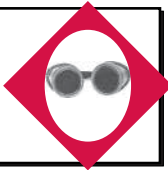

Mounted Flap Wheels

Specifications

Part No.	Wheel Dimensions	Grit	Max. RPM
1423-2160	1" x 1" x 1/4"	60	25,000
1423-2161	1" x 1" x 1/4"	80	25,000
1423-2157	1.5" x 1/2" x 1/4"	60	25,000
1423-2158	1.5" x 1/2" x 1/4"	80	25,000
1423-2154	2" x 1" x 1/4"	60	20,000
1423-2155	2" x 1" x 1/4"	80	20,000
1423-2151	3" x 1" x 1/4"	60	18,000
1423-2152	3" x 1" x 1/4"	80	18,000

Firepower® flap wheels are constructed of hundreds of resin bonded cloth abrasive sheets firmly attached to a balanced core. During use, each flexible sheet adapts quickly to the contours of the workpiece - continuously exposing fresh, sharp grit for extended product life. The controllable aggressiveness, working speed, and low cost of the wheels make them superior to wire brush, grit-impregnated plastic, fibrous and setup wheels in a wide range of applications.



Tips for Firepower Abrasive Flap Wheels:

1. Make sure flap wheel is run in correct direction of rotation. For automatic in-feeding of workpiece, the direction of flap wheel rotation should be contrary to the feed direction.
2. For a given finish, choose a grit one or two sizes coarser compared to abrasive belts.
3. Coarse grit sizes used at high speeds work finer. Fine grit sizes used at lower speeds work coarser.
4. Grinding oil or grease may be used for improved finish and the flap wheel life.
5. Use light pressure at low speeds, added pressure at high speeds. Do Not use excessive pressure or allow the flaps to bend back too far. If more stock removal is necessary, choose a coarser grit.
6. Abrasive flap wheels can be shaped to fit contours and other configurations by using a file, abrasive stone, or other cutting tool to cut the mop face. Always use proper safety equipment.
7. Make sure that mounting plates are of the proper size and are correctly fitted when used. Never over tighten fastening nuts or hub damage may result. Always use proper machine guards.



Visit the Website

FirepowerOnline.com

Contact your Firepower representative for Merchandising Solutions.

PRODUCTS



LITERATURE

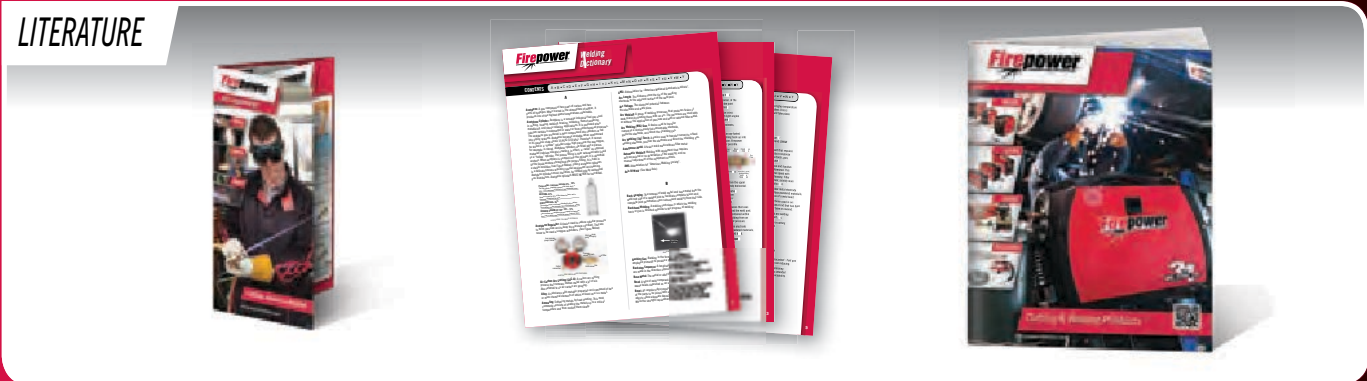

Firepower
INSTRUCTIONAL VIDEOS



Firepower
SELECTION TOOL



U.S. Customer Care: 800-858-4232 • Canada Customer Care: 905-827-4515 • International Customer Care: 940-381-1212