



ALPHA™ RESTRAINED JOINT

Features
PAGE 1-2



Wide Range Restrained Coupling

ORIGINALLY RELEASED IN THE SUMMER OF 2013, THE ALPHA COUPLING INSTALLS IN ABOUT THREE MINUTES, AND ACCOMMODATES UP TO 8 DEGREES OF DEFLECTION (4 DEGREES ON EACH END).

PAGE 1-4



Wide Range Restrained End Cap

THE ALPHA EC CAPS PLAIN-END PIPE FOR TESTING, BLOW-OFF OR LINE FLUSHING. THE ALPHA END CAP CAN ALSO BE USED AS A RELIABLE PIPE END SEAL FOR PERMANENT INSTALLATION.

PAGE 1-6



Wide Range Restrained Flanged Coupling

THE ALPHA FLANGED COUPLING QUICKLY ADAPTS PLAIN-END PIPE TO FLANGED FITTINGS. THE ALPHA FLANGED COUPLING ALSO ACCOMMODATES FLANGED SPOOL PIECES FOR CONNECTING TO VALVES AND OTHER FITTINGS.

PAGE 1-8

ALPHA™

WIDE RANGE RESTRAINED JOINT

ROMAC
INDUSTRIES, INC.

ALPHA™

WIDE RANGE RESTRAINED JOINT

ALPHA ADVANTAGES

- Standard Alpha covers IPS PVC through Ductile Iron pipe diameters.
- Alpha XL accommodates Ductile Iron through Oversize Cast Iron pipe sizes.
- Alpha can be configured to transition from IPS PVC up to Oversize Cast Iron pipe diameters.
- One piece, stab-fit installation.
- Cast components are high strength ductile iron.
- Working pressure: up to 350 PSI.
- Manufactured in the U.S.A.
- US Patent: 8,894,100
- Alpha products are approved for use on:
 - Ductile iron
 - Cast iron (Classes A, B, C & D)
 - PVC IPS size (Sch 40, Sch 80 & SDR 21)
 - PVC C900 and C909
 - HDPE: SDR 9, 11, 13.5 & 17, no pipe stiffeners required.







For other pipe materials, contact Romac.

NOTE: The original Alpha (with black grippers) is not compatible with HDPE pipe.

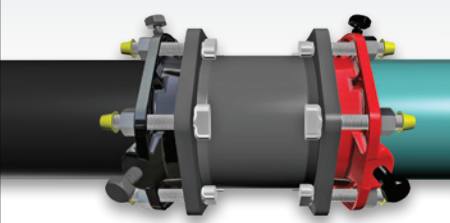
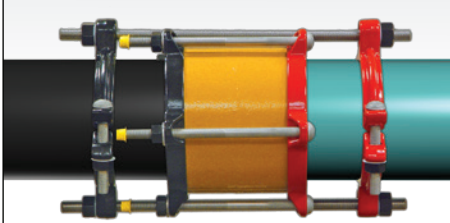

Certified to
NSF/ANSI 61 & 372

INSTALLATION TIME IS A FRACTION OF OTHER RESTRAINT METHODS

6" SLEEVE AND TWO MJ RESTRAINERS	6" COUPLING PLUS RESTRAINT SYSTEM	ALPHA
		
		
30 MINUTES TO INSTALL 29 TOTAL PARTS TO ASSEMBLE 12 T-BOLTS TO TORQUE 9 RADIAL BOLTS TO TORQUE 2 GASKETS TO SEAT	35 MINUTES TO INSTALL 33 TOTAL PARTS TO ASSEMBLE 5 COUPLING BOLTS TO TORQUE 4 CLAMPING BOLTS TO TORQUE 2 GASKETS TO SEAT	3 MINUTES TO INSTALL 2 NUTS TO TORQUE 1 PIECE (STAB-FIT) 0 GUESS-WORK

KEY ALPHA COMPONENTS

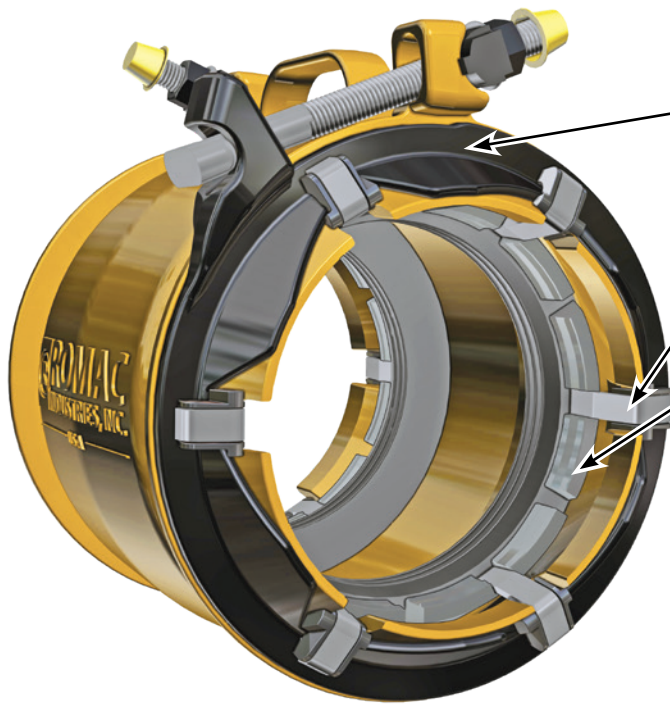

ROTATING END RINGS

- During installation, the end rings rotate and slide the draw hooks, gasket and grippers outward, against the pipe surface.

DRAW HOOK FASTENERS

- Stainless steel draw hooks are integrated into the gasket.

INDIVIDUAL GRIPPERS

- Individual ductile iron grippers compensate for angular deflection and out-of-round pipe.
- The grippers distribute the load evenly around the pipe circumference.

HOW ALPHA WORKS

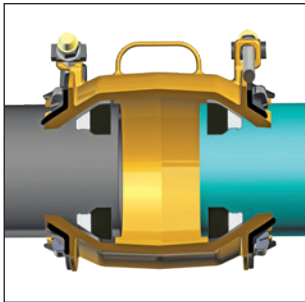

1 • Alpha is positioned over the pipe gap.

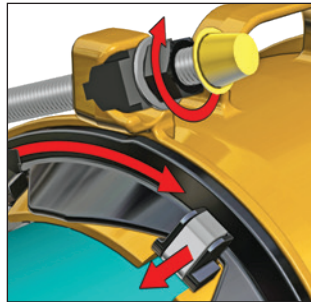

2 • Nuts are tightened, rotating the end ring.

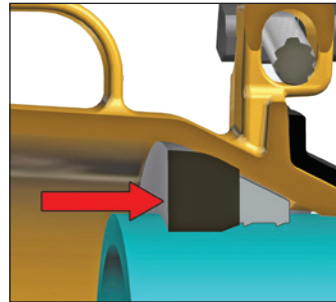

3 • Draw hooks pull gasket and grippers outward and against the pipe.

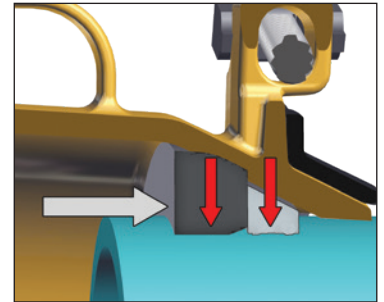

4 • Gaskets compress and seal against the pipe surface. Gripper teeth are set.

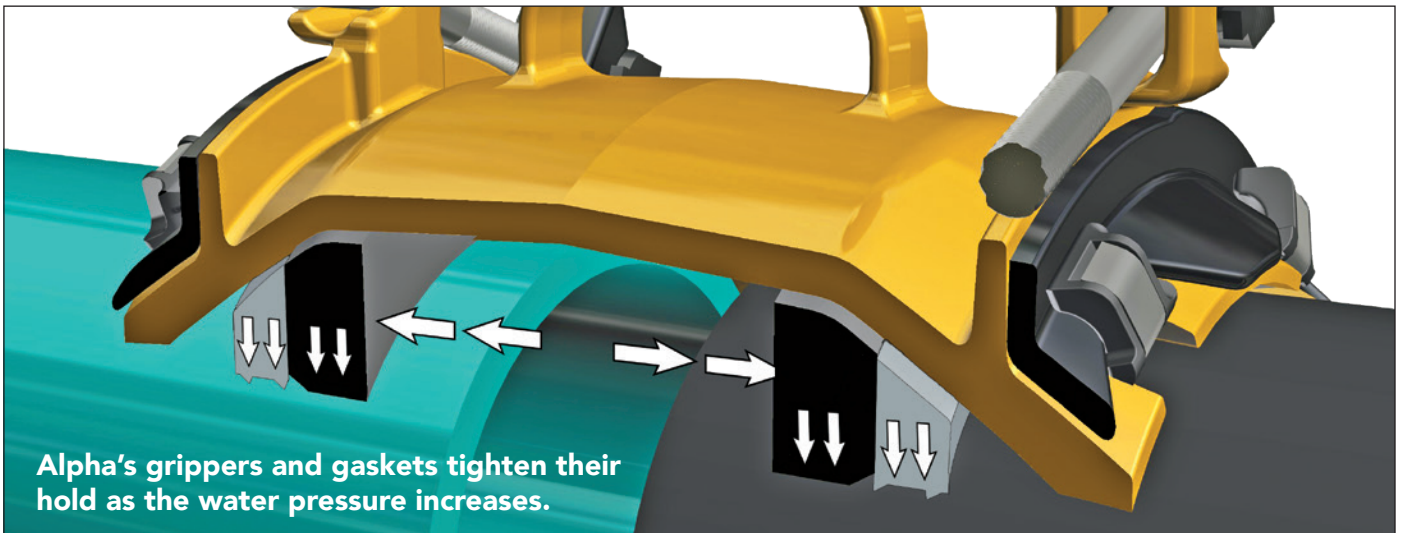

Alpha's grippers and gaskets tighten their hold as the water pressure increases.

ALPHA™ WIDE RANGE RESTRAINT COUPLING



MATERIAL SPECIFICATIONS

CASTINGS: All cast components (end rings, center ring and bolt guides) are ductile iron, meeting or exceeding the requirements of ASTM A 536, grade 65-45-12.

GRIPPERS: Ductile (nodular) iron, meeting or exceeding ASTM A 536, grade 65-45-12. Machine sharpened and heat treated. Xylan 1424 coated for corrosion protection.

GASKET: SBR compounded for water and sewer service in accordance with ASTM D2000. NBR available upon request. NSF/ANSI 61 & 372 Certified.

DRAW-HOOK FASTENERS: 304L stainless steel.

RAMP RUNNERS: Reinforced nylon.

BOLTS & NUTS: 304 stainless steel, 5/8-11 bolts with heavy hex e-coated nuts. Fasteners provided with anti-galling protection.

COATINGS: Center ring fusion bonded epoxy Romacoat, NSF 61 certified. End rings are Romabond polyester.

WORKING PRESSURE: up to 350 PSI.



STANDARD ALPHA
FITS IPS PVC THROUGH
DUCTILE IRON PIPE OD'S.



Certified to
NSF/ANSI 61 & 372



ALPHA™

RESTRAINED JOINT

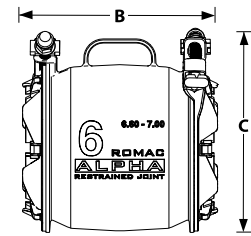
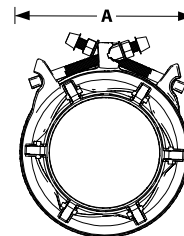

NOM. PIPE SIZE	O.D. RANGE (inches)	CATALOG NUMBER	DIMENSIONS			LIST PRICE	APPROX. WEIGHT (lbs)
			A O.D.	B LENGTH	C HEIGHT		
4"	4.50 - 4.90	ALPHA-A - 4.90	9.18	11.85	10.53	\$395.90	40
6"	6.60 - 7.00	ALPHA-A - 7.00	10.33	11.98	12.77	513.60	50
8"	8.60 - 9.10	ALPHA-A - 9.10	13.45	13.19	15.67	583.15	75
10"	10.75 - 11.20	ALPHA-A - 11.20	15.54	12.74	17.61	754.35	95
12"	12.75 - 13.30	ALPHA-A - 13.30	17.59	13.30	19.73	888.10	100

TO ORDER: Determine the O.D. of the pipes to be coupled, and select coupling size which covers the pipe diameters of both pipe ends. Specify Alpha Catalog Number [in table above]. Example: To couple 8" DI and 8" IPS PVC Pipe order **ALPHA-A-9.10**



ALPHA™ XL WIDE RANGE RESTRAINT COUPLING

MATERIAL SPECIFICATIONS

CASTINGS: All cast components (end rings, center ring and bolt guides) are ductile iron, meeting or exceeding the requirements of ASTM A 536, grade 65-45-12.

GRIPPERS: Ductile (nodular) iron, meeting or exceeding ASTM A 536, grade 65-45-12. Machine sharpened and heat treated. Xylan 1424 coating for corrosion protection.

GASKETS: NBR compounded for water and sewer service in accordance with ASTM D2000. NSF/ANSI 61 & 372 Certified.

DRAW-HOOK FASTENERS: 304L stainless steel.

RAMP RUNNERS: Reinforced nylon.

BOLTS & NUTS: 304 stainless steel, 5/8-11 bolts with heavy hex e-coated nuts. Fasteners provided with anti-galling protection.

COATINGS: Center ring fusion bonded epoxy Romacoat, NSF 61 certified. End rings are Romabond polyester.

WORKING PRESSURE: up to 350 PSI.

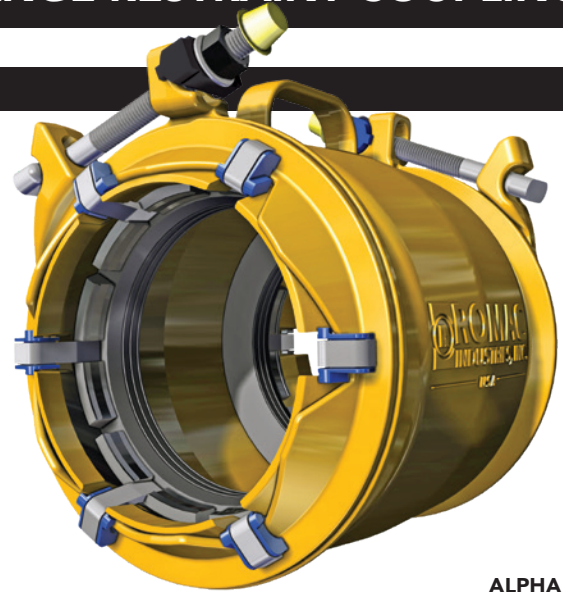

**ALPHA XL
FITS DUCTILE IRON THROUGH
OVERSIZE CAST IRON PIPE OD'S.**



Certified to
NSF/ANSI 61 & 372



ALPHA XL™ RESTRAINED JOINT

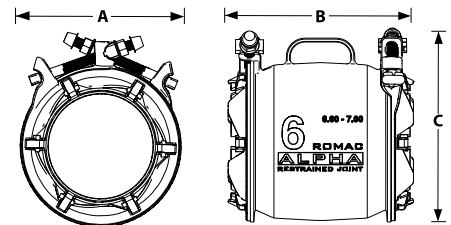

NOM. PIPE SIZE	O.D. RANGE (inches)	CATALOG NUMBER	DIMENSIONS			LIST PRICE	APPROX. WEIGHT (lbs)
			A O.D.	B LENGTH	C HEIGHT		
4"	4.80 - 5.10	ALPHA XL - 5.10	9.18	11.85	10.53	\$412.49	40
6"	6.90 - 7.10	ALPHA XL - 7.10	10.33	11.98	12.77	534.47	50
8"	9.05 - 9.40	ALPHA XL - 9.40	13.45	13.19	15.67	607.23	75
10"	11.10 - 11.45	ALPHA XL - 11.45	15.54	12.74	17.61	784.85	95
12"	13.20 - 13.60	ALPHA XL - 13.60	17.59	13.30	19.73	923.95	100

TO ORDER: Determine the O.D. of the pipes to be coupled, and select coupling size which covers the pipe diameters of both pipe ends. Example: To couple 8" Oversize Cast Iron Pipe and 8" C900 PVC pipe, order **ALPHA-XL- 9.40**.

ALPHA™ END CAP RESTRAINED END CAP



MATERIAL SPECIFICATIONS

CASTINGS: All cast components (end rings, center ring and bolt guides) are ductile iron, meeting or exceeding the requirements of ASTM A 536, grade 65-45-12.

GRIPPERS: Ductile (nodular) iron, meeting or exceeding ASTM A 536, grade 65-45-12. Machine sharpened and heat treated. Xylan 1424 coated for corrosion protection.

GASKET: SBR compounded for water and sewer service in accordance with ASTM D2000. NBR available upon request. NSF/ANSI 61 & 372 Certified.

DRAW-HOOK FASTENERS: 304L stainless steel.

RAMP RUNNERS: Reinforced nylon.

BOLT & NUT: R-Blue. HSLA. Xylan coated to reduce friction and provide corrosion resistance. For details, see catalog page 10-3.

WASHER: 304 Stainless steel.

COATINGS: End cap fusion bonded epoxy Romacoat, NSF 61 certified. End rings are Romabond polyester.

WORKING PRESSURE: up to 350 PSI.



ALPHA™

RESTRAINED END CAP



Certified to
NSF/ANSI 61 & 372

STANDARD ALPHA END CAP
FITS IPS PVC THROUGH
DUCTILE IRON PIPE OD'S.

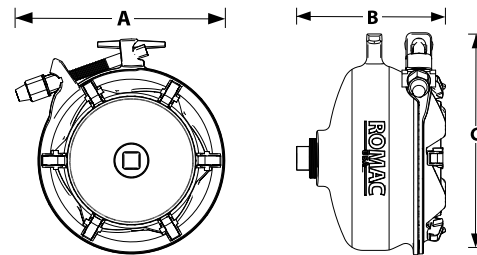

NOM. PIPE SIZE	O.D. RANGE (inches)	CATALOG NUMBER	DIMENSIONS			LIST PRICE	APPROX. WEIGHT (lbs)
			A O.D.	B LENGTH	C HEIGHT		
4"	4.50 - 4.90	ALPHA-EC - 4.90	10.20	7.15	9.70	\$241.82	21
6"	6.60 - 7.00	ALPHA-EC - 7.00	11.35	7.75	11.90	310.30	30
8"	8.60 - 9.10	ALPHA-EC - 9.10	13.40	9.45	15.00	425.86	52
10"	10.75 - 11.20	ALPHA-EC - 11.20	15.45	9.75	17.10	678.38	63
12"	12.75 - 13.30	ALPHA-EC - 13.30	17.50	10.10	19.15	758.63	78

TO ORDER: Determine the O.D. of the pipe to be capped, and select end cap size which covers the pipe diameter. Specify Catalog Number. **EXAMPLE:** To cap an 8" DI or 8" IPS PVC pipe, order **ALPHA-EC -9.10**



ALPHA™ XL END CAP RESTRAINED END CAP

MATERIAL SPECIFICATIONS

CASTINGS: All cast components (end rings, center ring and bolt guides) are ductile iron, meeting or exceeding the requirements of ASTM A 536, grade 65-45-12.

GRIPPERS: Ductile (nodular) iron, meeting or exceeding ASTM A 536, grade 65-45-12. Machine sharpened and heat treated. Xylan 1424 coated for corrosion protection.

GASKETS: NBR compounded for water and sewer service in accordance with ASTM D2000. NSF/ANSI 61 & 372 Certified.

DRAW-HOOK FASTENERS: 304L stainless steel.

RAMP RUNNERS: Reinforced nylon.

BOLT & NUT: R-Blue. HSLA. Xylan coated to reduce friction and provide corrosion resistance. For details, see catalog page 10-3.

WASHER: 304 Stainless steel.

COATINGS: End cap fusion bonded epoxy Romacoat, NSF 61 certified. End rings are Romabond polyester.

WORKING PRESSURE: up to 350 PSI.

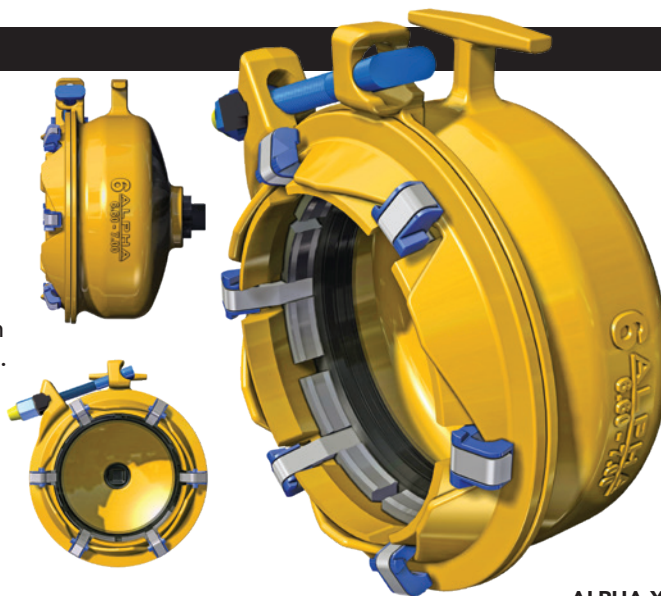

ALPHA XL
FITS DUCTILE IRON THROUGH
OVERSIZE CAST IRON PIPE OD'S.



Certified to
NSF/ANSI 61 & 372



ALPHA XL™ RESTRAINED END CAP

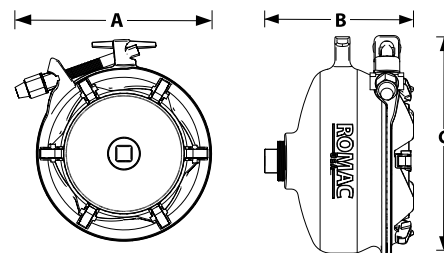

NOM. PIPE SIZE	O.D. RANGE (inches)	CATALOG NUMBER	DIMENSIONS			LIST PRICE	APPROX. WEIGHT (lbs)
			A O.D.	B LENGTH	C HEIGHT		
4"	4.80 - 5.10	ALPHA EC XL - 5.10	10.20	7.15	9.70	\$251.99	21
6"	6.90 - 7.10	ALPHA EC XL- 7.10	11.35	7.75	11.90	323.68	30
8"	9.05 - 9.40	ALPHA EC XL - 9.40	13.40	9.45	15.00	443.52	52
10"	11.10 - 11.45	ALPHA EC XL - 11.45	15.45	9.75	17.10	705.67	63
12"	13.20 - 13.60	ALPHA EC XL - 13.60	17.50	10.10	19.15	789.13	78

TO ORDER: Determine the O.D. of the pipe to be capped, and select end cap size which covers the pipe diameter. Specify Catalog Number. **EXAMPLE:** To cap an 8" DI or 8" Cast Iron pipe, order **ALPHA-EC-XL -9.40**

ALPHA™ FC RESTRAINED FLANGED COUPLING



MATERIAL SPECIFICATIONS

CASTINGS: All cast components (end rings, center ring and bolt guides) are ductile iron, meeting or exceeding the requirements of ASTM A 536, grade 65-45-12.

FLANGE: Compatible with flat face flanges with ANSI Class 125 and 150 bolt circles.

GRIPPERS: Ductile (nodular) iron, meeting or exceeding ASTM A 536, grade 65-45-12. Machine sharpened and heat treated. Xylan 1424 coated for corrosion protection.

GASKET: SBR compounded for water and sewer service in accordance with ASTM D2000. NBR available upon request. NSF/ANSI 61 & 372 Certified.

DRAW-HOOK FASTENERS: 304L stainless steel.

RAMP RUNNERS: Reinforced nylon.

BOLT & NUT: 304 stainless steel, 5/8-11 bolts with heavy hex e-coated nuts. Fasteners provided with anti-galling protection.

WASHER: 304 Stainless steel.

COATINGS: Flanged coupling body fusion bonded epoxy Romacoat, NSF 61 certified. End rings are Romabond polyester.

WORKING PRESSURE: up to 350 PSI.

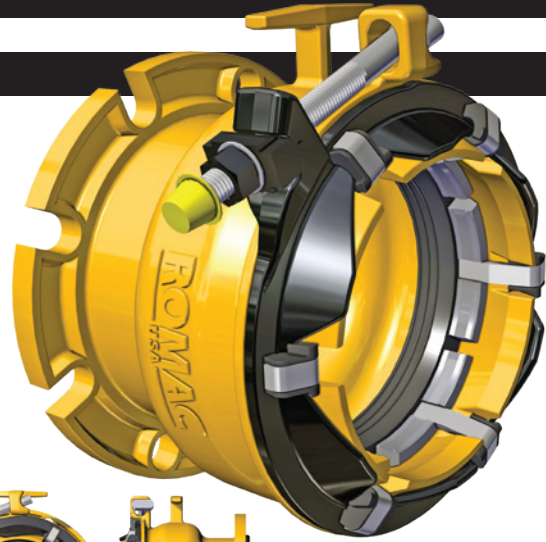

**STANDARD ALPHA FC
FITS IPS PVC THROUGH
DUCTILE IRON PIPE OD'S.**



ALPHA™ FC

RESTRAINED FLANGED COUPLING

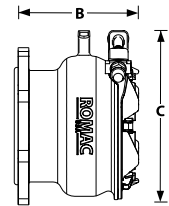
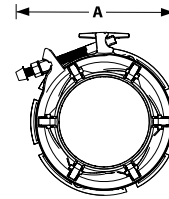

NOM. PIPE SIZE	O.D. RANGE (inches)	CATALOG NUMBER	DIMENSIONS			LIST PRICE	APPROX. WEIGHT (lbs)
			A O.D.	B LENGTH	C HEIGHT		
4"	4.50 - 4.90	ALPHA-FC - 4.90	11.20	8.15	10.25	\$269.64	29
6"	6.60 - 7.00	ALPHA-FC - 7.00	11.35	8.24	12.45	344.54	40
8"	8.60 - 9.10	ALPHA-FC - 9.10	13.40	9.96	15.55	462.24	57
10"	10.75 - 11.20	ALPHA-FC - 11.20	15.45	10.18	17.65	746.86	82
12"	12.75 - 13.30	ALPHA-FC - 13.30	17.50	10.28	19.70	836.74	105

TO ORDER: Determine the O.D. of the pipes to be coupled. Specify Catalog Number.

EXAMPLE: To couple an 8" DI or 8" IPS PVC pipe, order **ALPHA-FC -9.10**



ALPHA™ XL FC RESTRAINED FLANGED COUPLING

MATERIAL SPECIFICATIONS

CASTINGS: All cast components (end rings, center ring and bolt guides) are ductile iron, meeting or exceeding the requirements of ASTM A 536, grade 65-45-12.

FLANGE: Compatible with flat face flanges with ANSI Class 125 and 150 bolt circles.

GRIPPERS: Ductile (nodular) iron, meeting or exceeding ASTM A 536, grade 65-45-12. Machine sharpened and heat treated. Xylan 1424 coated for corrosion protection.

GASKETS: NBR compounded for water and sewer service in accordance with ASTM D2000. NSF/ANSI 61 & 372 Certified.

DRAW-HOOK FASTENERS: 304L stainless steel.

RAMP RUNNERS: Reinforced nylon.

BOLT & NUT: 304 stainless steel, 5/8-11 bolts with heavy hex e-coated nuts. Fasteners provided with anti-galling protection.

WASHER: 304 Stainless steel.

COATINGS: Flanged coupling body fusion bonded epoxy Romacoat, NSF 61 certified. End rings are Romabond polyester.

WORKING PRESSURE: up to 350 PSI.

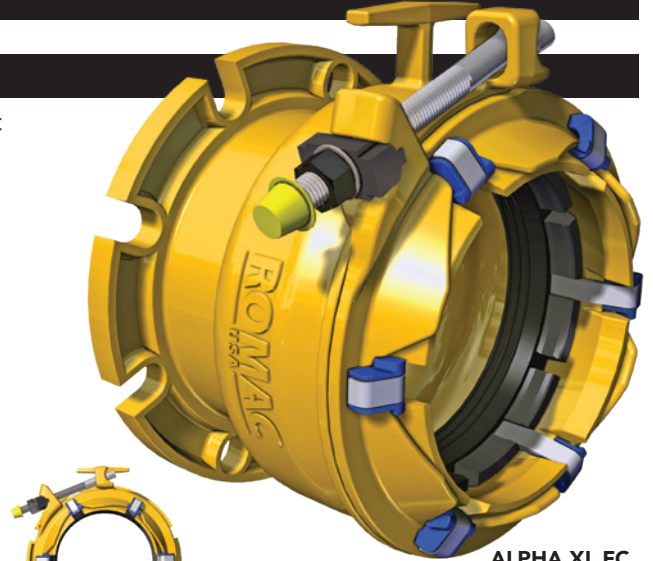

ALPHA XL FC
FITS DUCTILE IRON THROUGH
OVERSIZE CAST IRON PIPE OD'S.



Certified to
NSF/ANSI 61 & 372



ALPHA™ FC

RESTRAINED FLANGED COUPLING

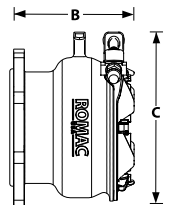
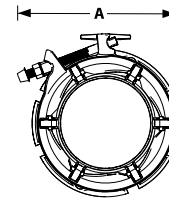

NOM. PIPE SIZE	O.D. RANGE (inches)	CATALOG NUMBER	DIMENSIONS			LIST PRICE	APPROX. WEIGHT (lbs)
			A O.D.	B LENGTH	C HEIGHT		
4"	4.80 - 5.10	ALPHA FC XL - 5.10	11.20	8.15	10.25	\$280.88	29
6"	6.90 - 7.10	ALPHA FC XL- 7.10	11.35	8.24	12.45	358.99	40
8"	9.05 - 9.40	ALPHA FC XL - 9.40	13.40	9.96	15.55	480.97	57
10"	11.10 -11.45	ALPHA FC XL - 11.45	15.45	10.18	17.65	777.36	82
12"	13.20 -13.60	ALPHA FC XL - 13.60	17.50	10.28	19.70	870.45	105

TO ORDER: Determine the O.D. of the pipes to be coupled. Specify Alpha Catalog Number.

EXAMPLE: To couple an 8" DI or 8" cast iron pipe, order **ALPHA-FC-XL-9.40**

