

Approvals & Certifications

- ASME B16.51
- IAPMO PS-117
- NSF/ANSI 61
- NSF/ANSI 372
- CSA TIL-MSE-13

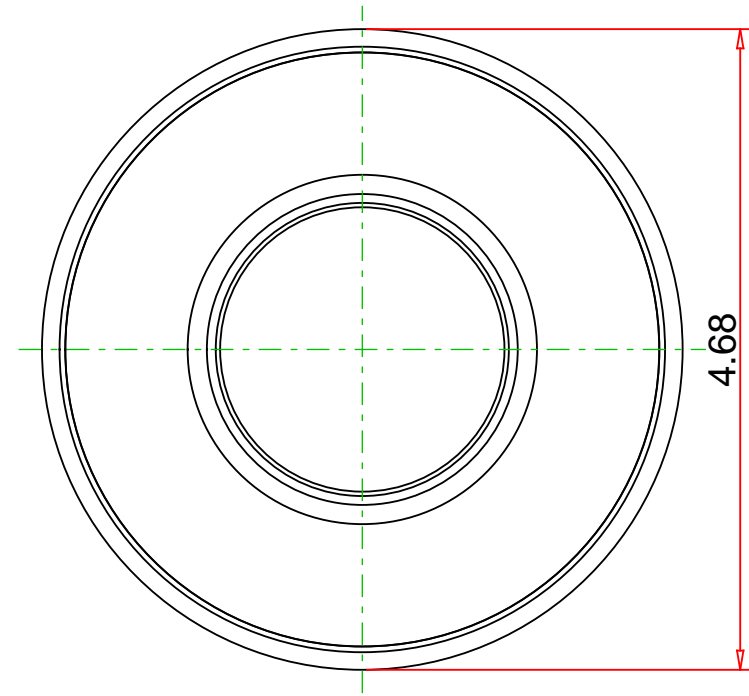
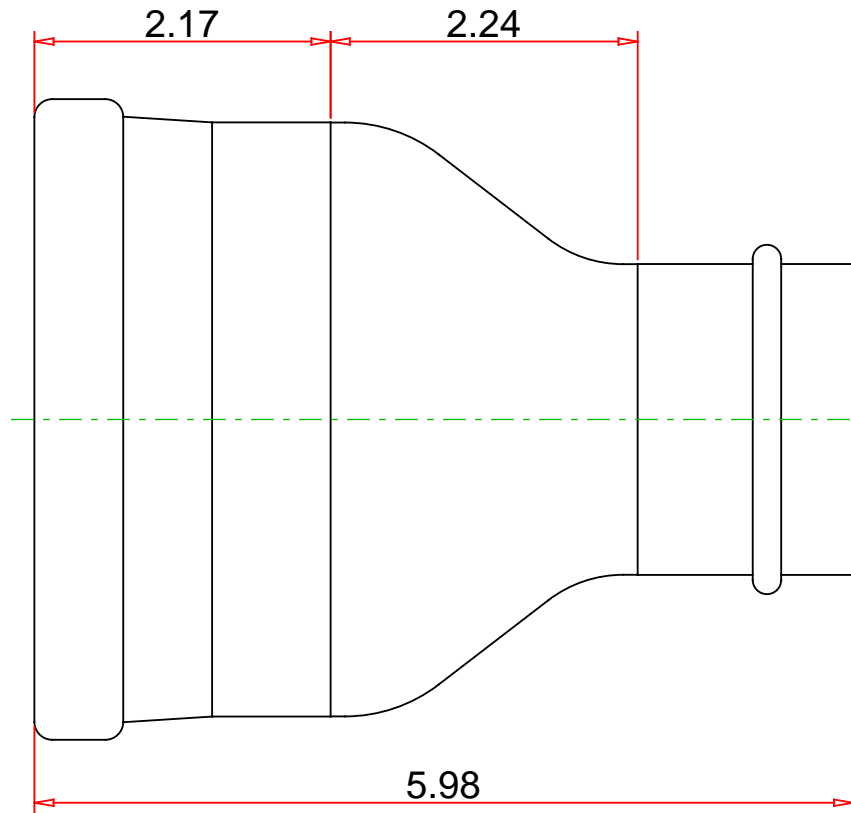

Note : - Drawing not to Scale

Part No. :
PF 10111

Description :
Copper Reducer, P x P, 4" x 2"



Mueller Streamline Co.

Address : 8285 Tournament Dr., Suite 150
Memphis, TN 38125
Ph : 901-753-3200
Email : contact@muellerindustries.com
Web : <http://www.muellerindustries.com/>