



Mueller Streamline Co. Headquarters

150 Schilling Blvd
Suite 201
Collierville, Tennessee 38017
United States
Phone: 901 753 3200

Mueller Streamline Co. International

525 Okeechobee Blvd
Suite 860
West Palm Beach, FL 33401
United States
Phone: 561 273 8300

ITEM # PF 08004, LEAD FREE UNION, P X P, 3/4" X 3/4"

Streamline® PRS™ Copper-Press Fittings is a flameless joining alternative for plumbing or mechanical applications. Available sizes ranging from 1/2" to 4" in diameter.

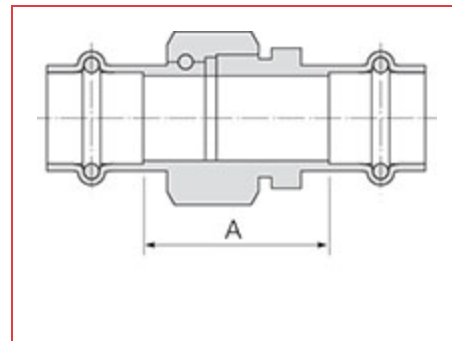

[Specifications](#) | [Dimensions](#) | [Details](#)

Specifications

Weight	0.63 lb
Material	LEAD FREE
Operating Temperature [Min]	-20 °F
Operating Temperature [Max]	250 °F
Operating Pressure [Max]	200 psi
End Type	Press

End Size	3/4 in
-----------------	--------

Second End Type	Press
------------------------	-------

Second End Size	3/4 in
------------------------	--------

Standards	ASME B16.51 IAPMO PS-117 NSF/ANSI 61 NSF/ANSI 372 CSA TIL-MSE-13
------------------	--

Dimensions

Overall Length	3.22 in
-----------------------	---------

Overall Height	1.42 in
-----------------------	---------

Overall Width	1.23 in
----------------------	---------

A	1.31 in
----------	---------

Details

Qty Pcs / Bag	5
----------------------	---

Master Qty Pcs / Box	75
-----------------------------	----

Mueller Description	3/4 P X P UNION
----------------------------	-----------------