

Approvals & Certifications

- ASME B16.51
- IAPMO PS-117
- NSF/ANSI 61
- NSF/ANSI 372
- CSA TIL-MSE-13

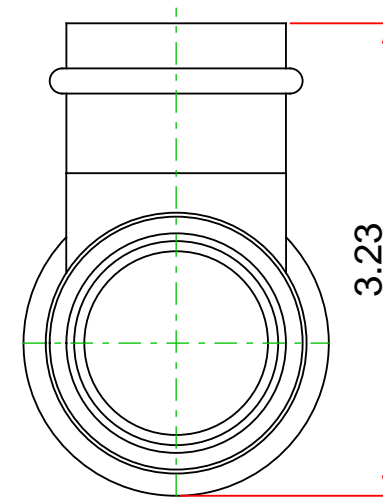
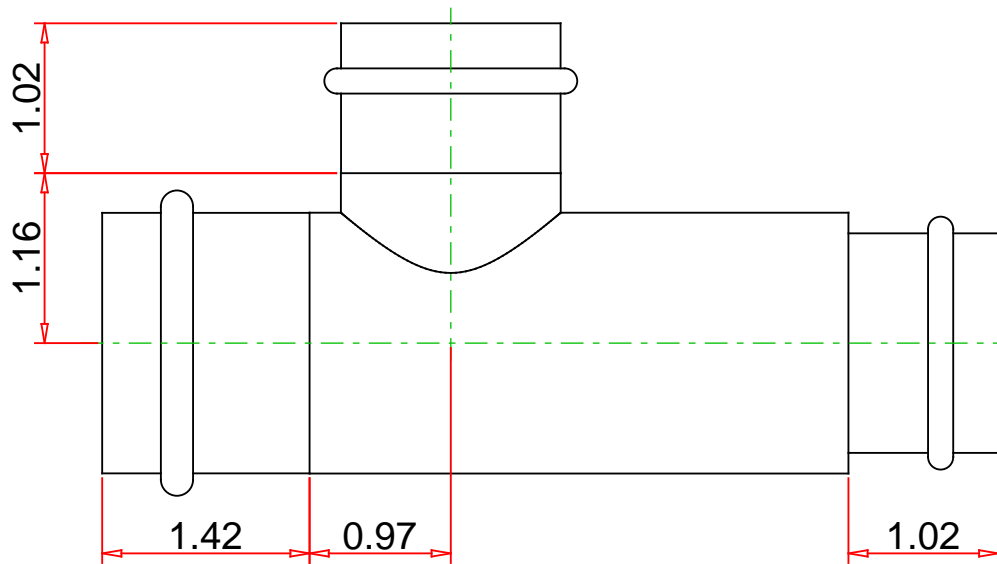
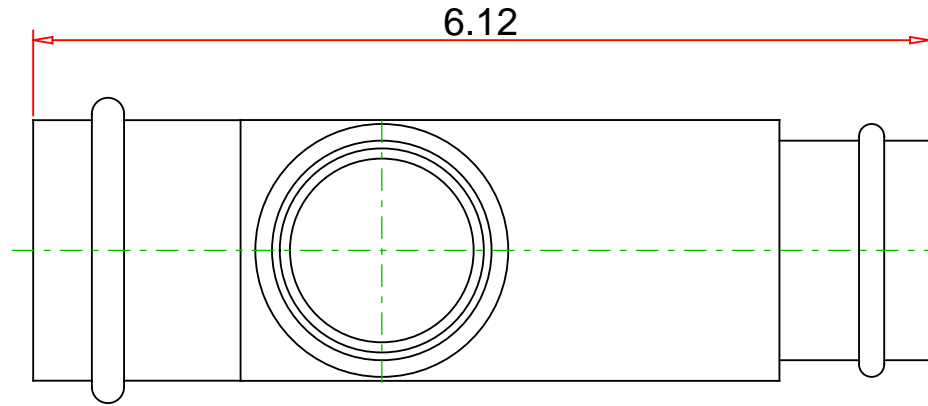

Note : - Drawing not to Scale

Part No. :

PF 04091

Description :

Copper Tee, P x P x P, 1-1/2" x 1-1/4" x 1-1/4"



**Mueller Streamline Co.**

Address : 8285 Tournament Dr., Suite 150

Memphis, TN 38125

Ph : 901-753-3200

Email : [contact@muellerindustries.com](mailto:contact@muellerindustries.com)

Web : <http://www.muellerindustries.com/>