

Approvals & Certifications

- ASME B16.51
- IAPMO PS-117
- NSF/ANSI 61
- NSF/ANSI 372
- CSA TIL-MSE-13

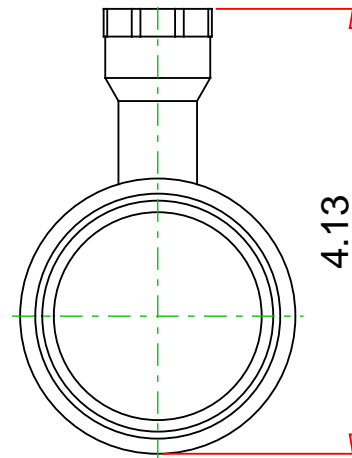
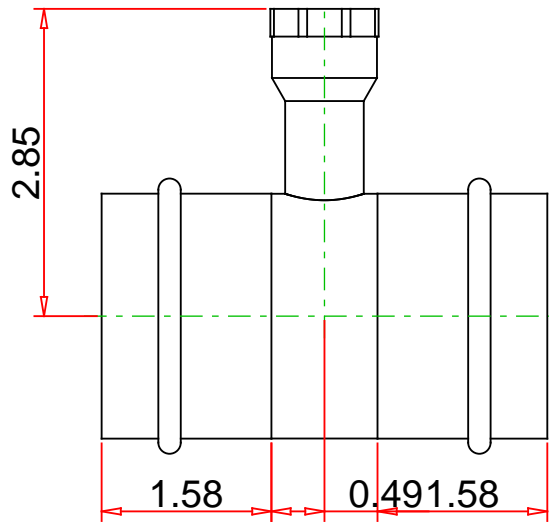
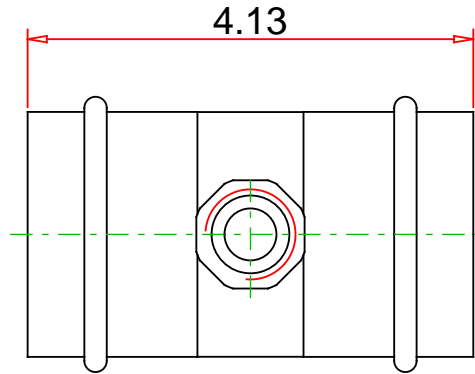

Note : - Drawing not to Scale

Part No. :

PF 01699

Description :

Copper Tee, P x P x FPT, 2" x 2" x 1/2"



Mueller Streamline Co.

Address : 8285 Tournament Dr., Suite 150
Memphis, TN 38125

Ph : 901-753-3200

Email : contact@muellerindustries.com

Web : <http://www.muellerindustries.com/>