

# Systems for Wall-Hung Toilets, 2x4 Installation

## Geberit Duofix Carrier, Sigma 2x4 Installation

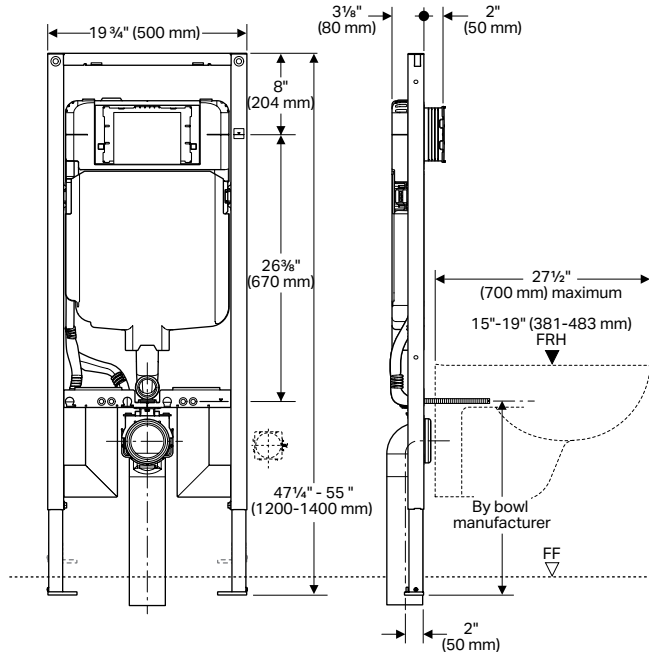





Model No.	Description	List Price
111.798.00.1	Carrier frame with 1.6/0.8 GPF Sigma Concealed Tank	\$646.00
111.597.00.1	Carrier frame with 1.28/0.8 GPF Sigma Concealed Tank	\$646.00





- NOTES:
1. Concealed tank shipped dual-flush ready
  2. Geberit Duofix Carrier for 2-hole washdown style wall-hung toilet fixtures only
  3. Refer to [geberit.us](http://geberit.us) for latest list of Code approved Compatible toilet fixtures, including certified WaterSense® combinations

Note: For System Accessories see pages 16-18.

## Dual-Flush Actuators, Sigma 2x4 Installation





Style	Material	Finish	Model No.	List Price	
Sigma01 	Plastic	Alpine White	115.770.11.5	\$89.00	
		Polished Chrome	115.770.21.5	121.00	
		Matte Chrome	115.770.46.5	121.00	
Sigma20 	Metal	Br Ni-Polished Ni-Br Ni*	115.882.ID.1	251.00	
		Br SS-Polished SS-Br SS*	115.882.SN.1	252.00	
		Br Ni-Polished Ni-Br Ni* VR	115.889.ID.1	290.00	
		Br SS-Polished SS-Br SS* VR	115.889.SN.1	290.00	
	Plastic	Polished Chr-Matte Chr-Polished Chr*	115.882.KH.1	187.00	
		White-Polished Chrome-White*	115.882.KJ.1	129.00	
		White-Polished Gold-White* (Effective 4/21/17)	115.882.KK.1	450.00	
		White-Matte Chr-Matte Chr*	115.882.KL.1	159.00	
		Black-Polished Chrome-Black*	115.882.KM.1	159.00	
		Matte Chr-Pol Chr-Matte Chr*	115.882.KN.1	187.00	
Sigma30 	Plastic	Polished Chr-Matte Chr-Polished Chr***	115.883.KH.1	210.00	
		White-Polished Chrome-White***	115.883.KJ.1	131.00	
		White-Polished Gold-White***	115.883.KK.1	170.00	
		White-Matte Chr-Matte Chr***	115.883.KL.1	170.00	
		Black-Polished Chrome-Black***	115.883.KM.1	170.00	
		Matte Chr-Polished Chr-Matte Chr***	115.883.KN.1	210.00	
		Sigma50 	Die Cast	Customer supplied inlay	115.788.00.5
Alpine White	115.788.11.5			366.00	
Polished Chrome	115.788.21.5			472.00	
Black	115.788.DW.5			366.00	
Brushed Chrome	115.788.GH.5			472.00	
Smoke Glass	115.788.SD.5			472.00	
Green Satin Glass	115.788.SE.5			472.00	
Umber Glass	115.788.SQ.5			472.00	
Sigma60† 	Die Cast	Brushed Chrome	115.640.GH.1	618.00	
		Glass	White Glass	115.640.SI.1	618.00
			Black Glass	115.640.SJ.1	618.00
			Umber Glass	115.640.SQ.1	618.00
	Glass	Cover frame (optional accessory) Polished Chrome	115.641.21.1	160.00	
		Cover frame (optional accessory) Brushed Chrome	115.641.GH.1	160.00	
		Note: Required accessory kit 243.168.00.1 is included with 111.597.00.1 and 111.798.00.1 carrier.			
		Sigma70 	Die Cast	Customizable	115.625.00.1
Metal	Br SS			115.625.FW.1	694.00
Glass	White Glass		115.625.SI.1	612.00	
	Black Glass		115.625.SJ.1	612.00	
	Umber Glass		115.625.SQ.1	612.00	

## Single-Flush Actuators, Sigma 2x4 Installation









Sigma10† 	Metal	Br SS	115.758.SN.5	\$252.00
		Br SS VR	115.787.SN.5	286.00
	Plastic	Pol Chr-Matte Chr-Polished Chr*	115.758.KH.5	187.00
		White-Polished Chrome-White*	115.758.KJ.5	130.00
		White-Polished Gold-White*	115.758.KK.5	371.00
		White-Matte Chr-Matte Chr*	115.758.KL.5	159.00
Sigma30† 	Die Cast	Black-Polished Chrome-Black*	115.758.KM.5	159.00
		Matte Chr-Pol Chr-Matte Chr*	115.758.KN.5	187.00
		Polished Gold***	115.893.45.1	594.00
		White-Polished Chr-White***	115.893.KJ.1	246.00
		Br Chrome-Pol Chr-Br Chrome***	115.893.KX.1	361.00
Pol Chr-Br Chrome-Pol Chr***	115.893.KY.1	361.00		

Products marked with  comply with the American Disabilities Act (ADA) when installed per the requirements of the latest ADA Accessibility Guidelines (ADAAG) and/or ICC/ANSI A117.1.

### Hands-Free Actuators and Transformer, Sigma 2x4 Installation

Style	Material	Finish	Model No.	List Price
Sigma10 <sup>†</sup> 	Metal	Br SS (AC Power)	115.856.SN.1	\$858.00
		Single-Flush		
Sigma80 	Glass	Black (AC Power)	116.092.SG.1	1,448.00
		Mirror (AC Power)	116.092.SM.1	1,448.00
		Connection cable (optional accessory) length 78-3/4" (2 mm)	242.658.00.1	42.00
		Extension mains cable (optional accessory for Sigma10 and Sigma80) length 78-3/4" (2 mm)	241.831.00.1	58.00
		Transformer for AC powered hands-free actuator. (For Sigma10 and Sigma80)	115.861.00.1	145.00



### Dual-Flush Buttons for Concealed Installations, Sigma 2x4 Installation

Style	Material	Finish	Model No.	List Price	
Type 01 	Plastic	Alpine White	116.043.11.1	\$119.00	
		Polished Chrome	116.043.21.1	154.00	
	Plastic	Alpine White 	116.045.11.1	119.00	
Type 10 	Plastic	Matte Chr-Polished Chr**	116.056.KH.1	170.00	
		Polished Chrome-White**	116.056.KJ.1	154.00	
Type 70 	Metal	Br SS 	115.635.FW.1	782.00	
		Glass	White Glass 	115.635.SI.1	664.00
			Black Glass 	115.635.SJ.1	664.00
			Umber Glass 	115.635.SQ.1	664.00

### Single-Flush Buttons for Concealed Installations, Sigma 2x4 Installation

Style	Material	Finish	Model No.	List Price
Type 01 <sup>†</sup> 	Plastic	Alpine White	116.041.11.1	\$101.00
		Polished Chrome	116.041.21.1	119.00

### Cover Plates for Concealed Tank, Sigma 2x4 Installation, for use with Flush Buttons

	Glass	White	115.766.SI.1	\$205.00	
		Metal	Br SS	115.764.FW.1	164.00
			Customizable	115.766.00.1	164.00
	Plastic	Alpine White	115.768.11.1	71.00	
		Polished chrome	115.768.21.1	94.00	
		Matte Chrome	115.768.46.1	94.00	

### Surface Even Cover Plates for Sigma Concealed Tank, 2x4 Installation, for use with Flush Buttons

	Plastic	Customizable <sup>†</sup>	115.696.00.1	\$205.00
		Customizable with frame <sup>†</sup>	115.697.00.1	258.00
Note: Required accessory kit 243.168.00.1 is included with 111.597.00.1 and 111.798.00.1 carrier.				

\* Finishes follow this pattern = Plate-Ring-Button

\*\* Finishes follow this pattern = Frame-Button

\*\*\* Finishes follow this pattern = Frame-Button Edge Trim-Button

† Note: For tile, stone or other hard surfaced walls only!

‡ Not intended to be sold in California

VR = Vandal Resistant

Br SS = Brushed Stainless Steel

Br Ni = Brushed Nickel

Products marked with  comply with the American Disabilities Act (ADA) when installed per the requirements of the latest ADA Accessibility Guidelines (ADAAG) and/or ICC/ANSI A117.1.

**Geberit Duofix Carrier 111.798.00.1 and 111.597.00.1, Sigma 2x4 Installation**

Item	Model No.	Description	List Price	Item	Model No.	Description	List Price
1	242.314.00.1	Materials for Concealed Carrier and Tank installation	\$40.00	15	242.415.00.1	Connection hose for Sigma Concealed Tank 2x4, 3/8"	\$16.00
2	242.418.00.1	Splash guard protection cover for Sigma Concealed Tank 2x4	6.00	15	243.357.00.1	Connection hose for Sigma Concealed Tank 2x4, 3/8" - for salt water applications	21.00
3	243.345.00.1 or 243.168.00.1	Mud guard protection housing for Sigma Concealed Tank 2x4, plastic	16.00	15.1	240.922.00.1	Seal kit for braided hose, EPDM O-ring	9.00
4	362.771.00.1	Seal for concealed flush pipe, EPDM	2.00	16	243.279.00.1	Fixation clip for filling valve	5.00
5	362.796.92.1	Protection plug, plastic	5.00	17	241.469.00.1	Filling valve Type 380 for Sigma, Omega and Kappa Concealed Tanks	26.00
6	240.189.00.1	Threaded rod for wall-mounted toilet or bidet installation	4.00	17.1	240.771.00.1	Seal kit for filling valve Type 380	11.00
7	152.404.46.1	Connector set with mounting hardware (bowl installation kit), HDPE; Matte Chrome cover caps	42.00	17.2	241.670.00.1	Nipple to filling valve Type 380 for Sigma Concealed Tank 2x4	16.00
7.1	217.713.46.1	Cover caps with leveling washer, plastic, Matte Chrome	7.00	18A	243.727.00.1	1.28/0.8 GPF dual-flush valve for Sigma Concealed Tank 2x4	16.00
7.2	119.668.00.1	Seal for supply inlet tube, EPDM	2.00	18B	242.416.00.1	Dual-flush valve for 1.6/0.8 GPF Sigma Concealed Tank 2x4	16.00
7.3	152.424.00.1	Seal for toilet outlet connector, EPDM	3.00	18.1	241.167.00.1	Yoke set for flush valves	9.00
8	241.899.00.1	HDPE waste fitting outlet bend, 1 x 90° bend with socket for Ø3.50" (Ø90 mm) push fit piping and Ø3.50" (Ø90 mm) outlet	51.00	18.2	241.291.00.1	Flat gasket for flush valve for Sigma Concealed Tank 2x4	2.00
8.1	387.282.00.1	Seal for outlet bends, EPDM	5.00	18.3	241.292.00.1	Fixing rail to Sigma Concealed Tank 2x4	5.00
9	366.820.92.1	Protection plug, plastic	4.00	19	242.269.00.1	Valve seat basket and noise bushing for flush valve	16.00
10	—	Flexible coupling FERNCO 3005-33	—	19.1	241.293.00.1	U-cup seal for valve basket	4.00
11	242.012.00.1	Outlet pipe bracket (complete)	4.00	20	243.344.00.1	Flush actuator gear box	16.00
12	242.888.00.1	Conduit pipe for shower toilet water supply with Sigma Concealed Tank 2x4 (from mid-2013 on)	10.00	21	240.847.00.1	Stop valve to concealed tank (blue handle - for salt water applications)	25.00
13	216.179.00.1	Installation hardware	3.00	21	242.414.00.1	Stop valve to concealed tank (blue handle)	17.00
14	240.851.00.1	Drop ear elbow, copper	11.00	21.1	240.298.00.1	Spindle to angle stop valve	13.00
				21.2	240.347.00.1	Handle for angle stop valve (blue)	4.00
				22	111.892.00.1	Frame mounting screws for steel stud construction, galvanized, self-tapping	6.00

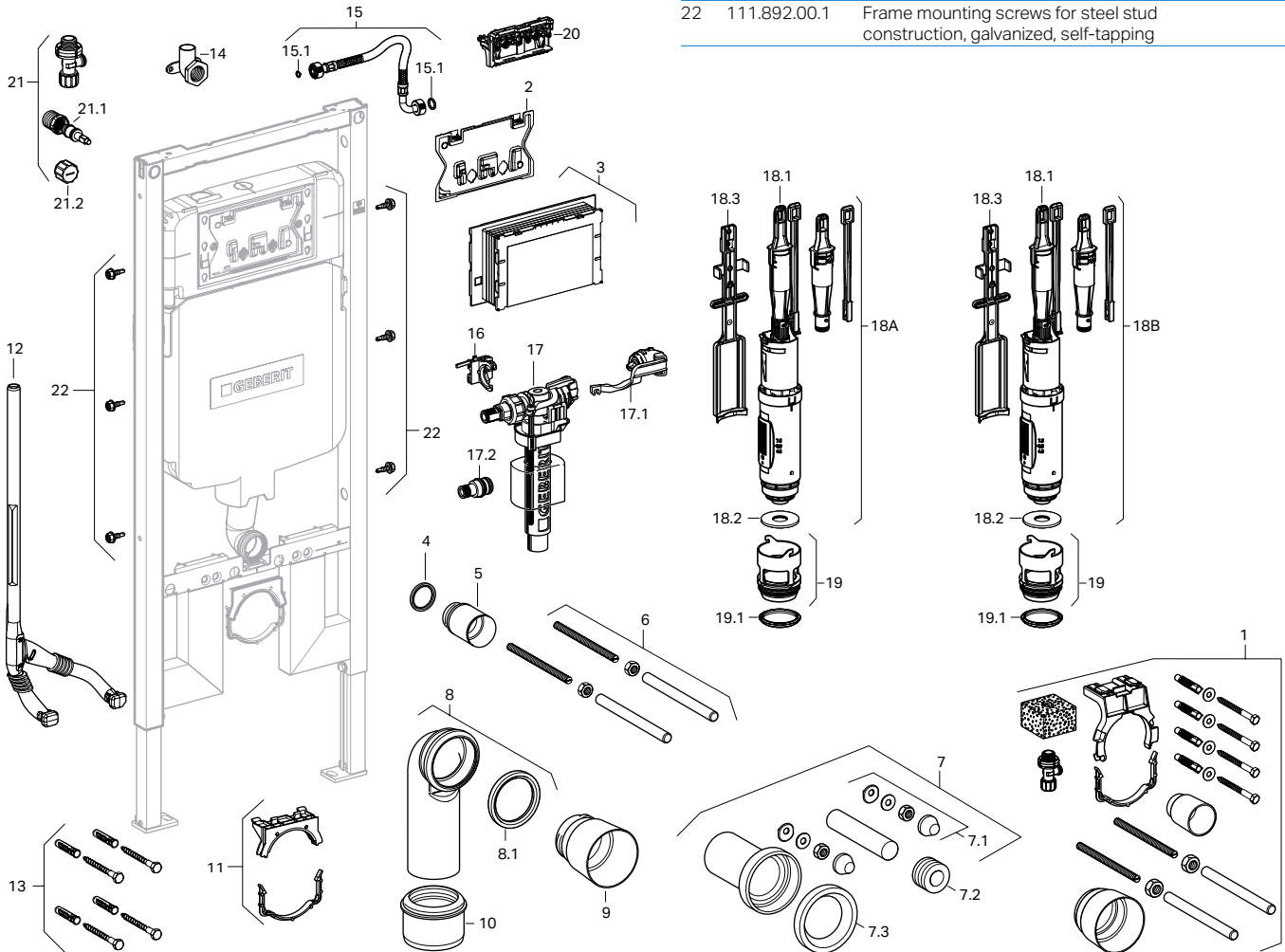

# System Accessories

## Geberit Optional and Required Accessories for Installation

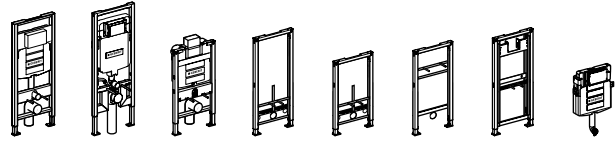

Description	Model Number	List Price	111.335	111.798	111.012	111.520	111.524	111.490	111.625	109.304
			111.902	111.597	111.018					

### OPTIONAL Connection Sets and Accessories for Finished Walls up to 3.5" (9cm) Thick

	Connector set with mounting hardware (bowl installation kit), HDPE; Alpine White cover caps	152.404.11.1	\$42.00	✓	✓	✓						
	PE syphon trap with horizontal outlet and seal; Ø1.96" (Ø50 mm) outlet	152.950.11.1	35.00								✓	
	PE syphon trap with vertical outlet and seal; Ø1.97" (Ø50 mm) outlet	152.951.11.1	35.00								✓	
	Acoustic insulation set for wall-hung toilets and bidets	156.050.00.1	18.00	✓	✓	✓	✓	✓				
	Cover caps with leveling washer, plastic, Alpine White	217.713.11.1	7.00	✓	✓	✓	✓	✓	✓			
	HDPE connection set with 1" (2.5 cm) offset and mounting hardware (bowl installation kit); with socket for Ø3.50" (Ø90 mm) push fit piping and Ø55 supply inlet; Matte Chrome cover caps	405.116.00.1	218.00	✓	✓	✓						✓

### REQUIRED Connection Sets and Accessories for Finished Walls 3.5" - 7.0" (9-18cm) Thick

	HDPE Connector set for extended installation and mounting hardware (bowl installation kit), with socket for Ø3.50" (Ø90 mm) push fit piping and Ø2.16" (Ø55 mm) supply inlet; Matte Chrome cover caps	152.438.46.1	54.00	✓	✓	✓						✓
	Extension set for actuator plates for Sigma Concealed Tanks 2x6 and 2x4, Kappa and Omega Concealed Tanks	240.938.00.1	22.00	✓	✓	✓						✓
	Mud guard protection housing for Sigma Concealed Tanks 2x6 and 2x4, plastic, 4 inch (10 cm)	241.826.00.1	13.00	✓	✓							✓
	Mud guard protection housing and extension set for urinal carrier	241.930.00.1	19.00								✓	
	Mounting rod M12 x 10" long. Not supplied.	M12 x 10"	—	✓	✓	✓	✓	✓				
	Mounting rod M10 x 10" long. Not supplied.	M10 x 10"	—						✓			
	Mounting rod M8 x 10" long. Not supplied.	M8 x 10"	—								✓	

**Geberit Optional and Required Accessories for Installation**

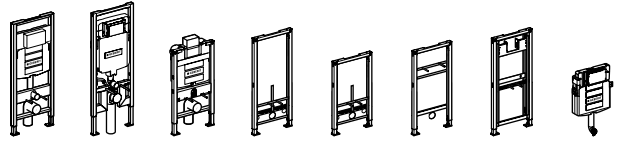

Description Model Number List Price

**111.335 111.798 111.012**  
**111.902 111.597 111.018 111.520 111.524 111.490 111.625 109.304**

**OPTIONAL Installation Accessories for Bidet Seats**

	Water supply hose for bidet seat for Kappa and Omega Concealed Tank pre-wall. For adding bidet seat to an installed carrier. For complete installation, must order with 249.801.00.1.	240.839.00.1	\$57.00			✓							
	Water supply hose for bidet seat for 111.597.00.1 and 111.798.00.1 carrier with Sigma Concealed Tank 2x4. For adding bidet seat to an installed carrier. For complete installation, must order with 249.801.00.1.	243.173.00.1	46.00			✓							
	Water supply hose for bidet seat add-on after finished installation of Sigma 2x6 and 2x4, Kappa and Omega Concealed Tanks.	249.801.00.1	111.00	✓	✓	✓							✓

**OPTIONAL Installation Accessories for Geberit Duofix Carrier Frames**

	Frame to wall anchoring for 5.125"-7.875" (13-20 cm) thick unfinished pre-wall	111.013.00.1	22.00			✓							
	Frame to wall anchoring for 5.125"-7.875" (13-20 cm) thick unfinished pre-wall	111.815.00.1	34.00	✓		✓	✓	✓	✓	✓	✓		
	Frame to wall anchoring for 5.125"-7.875" (13-20 cm) thick unfinished pre-wall corner installations	111.835.00.1	34.00	✓	✓	✓	✓	✓	✓	✓	✓		
	Support brackets for wall-hung toilets with small contact surface (thin profiles)	111.847.00.1	44.00	✓		✓							
	Fire protection set for Sigma Concealed Tank 90 min. fire resistance to DIN EN 1364-1:1999-10	111.863.00.1	490.00	✓									
	Frame to wall anchoring where foot installations into floor are not allowed for 5.125"-7.875" (13-20 cm)	111.867.00.1	65.00	✓	✓	✓	✓	✓	✓	✓	✓		
	Fastening set for sinks with 14.9"-22.8" (38-58 cm) mounting centers	111.868.00.1	111.00								✓		
	Frame to stud fastening set for extended stud spacing from 19.75"-25.56" (50-65 cm)	111.869.00.1	34.00	✓	✓	✓	✓	✓	✓	✓	✓		
	Frame to wall anchoring extensions for 7.875"-15.75" (20-40 cm) thick (unfinished pre-wall)	111.887.00.1	14.00	✓	✓	✓	✓	✓	✓	✓	✓		
	Crossbar for inlet 1/2" thread	242.042.00.1	69.00									✓	
	Elbow supply fitting set, Gun Metal (until Q3 2017)	465.034.00.1	37.00				✓	✓	✓				

GEBERIT SYSTEM ACCESSORIES

# System Accessories

## Geberit Optional and Required Accessories for Installation

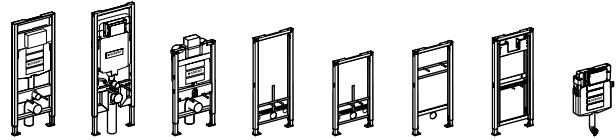

Description Model Number List Price **111.335 111.798 111.012**  
**111.902 111.597 111.018 111.520 111.524 111.490 111.625 109.304**

### OPTIONAL Installation Waste Fitting Accessories

	PP connector set with bend for floor-mount toilets with mounting hardware, 1 x 90° bends with socket for Ø4.375" (Ø110 mm) push fit piping for Ø3.82"-4.21" (Ø97-107 mm) male connection and expansion to Ø4.375" (Ø110 mm) outlet	152.647.00.1	\$111.00									✓ (For A or B discharge. See below)
	HDPE waste fitting outlet bend, 1 x 90° bend with socket for Ø3.50" (Ø90 mm) push fit piping and Ø3.50" (Ø90 mm) outlet	366.061.16.1	22.00									✓ (For A discharge. See below)
	HDPE straight connector with socket for Ø3.50" (Ø90 mm) push fit piping and Ø3.50" (Ø90 mm) outlet x 12" (31 cm) long	366.887.16.1	34.00	✓	✓	✓						✓ (For A discharge. See below)
	HDPE connector with offset for LH horizontal drain connections (as viewed from sitting position), 1 x 90° bend with socket for Ø3.50" (Ø90 mm) push fit piping, with 45° offset and Ø3.50" (Ø90 mm) outlet for 5.5" (13.97 cm) minimum walls only.	366.913.16.1	71.00	✓	✓	✓						✓ (For A discharge. See below)
	HDPE connector with offset for RH horizontal drain connections (as viewed from sitting position), 1 x 90° bend with socket for Ø3.50" (Ø90 mm) push fit piping, with 45° offset and Ø3.50" (Ø90 mm) outlet for 5.5" (13.97 cm) minimum walls only.	366.914.16.1	71.00	✓	✓	✓						✓ (For A discharge. See below)
	Cast iron outlet bend; 1 x 90° bend with socket for Ø3.50" (Ø90 mm) push fit piping and 3" CIP outlet	367.071.18.1	147.00	✓	✓	✓						✓ (For A discharge. See below)
	HDPE "Back-to-back" connector for horizontal drain connections; 2 x 90° bends with sockets for Ø3.50" (Ø90 mm) push fit piping, with 45° offset and expansion to Ø4.375" (Ø110 mm) outlet for 10.75" (27.31 cm) minimum walls only.	367.485.16.1	147.00	✓	✓	✓						✓ (For A or B discharge. See below)
	HDPE "Back-to-back" connector for vertical drain connections; 2 x 90° bends with sockets for Ø3.50" (Ø90 mm) push fit piping and expansion to Ø4.375" (Ø110 mm) outlet for 10.75" (27.31 cm) minimum walls only.	367.923.16.1	147.00	✓	✓	✓						✓ (For A or B discharge. See below)

Note: Any of these fittings in combination with carrier 111.798.00.1 are cUPC and IPC listed.

### Waste Fitting Discharge Configurations for Floor Mount Back Outlet Toilets

Note: Mounting collar/clamp by installer

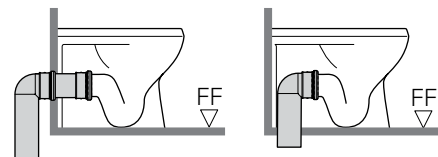

**A.** Floor-Mount Rear Discharge into Wall

**B.** Floor-Mount Rear Discharge into Floor