



Features

- Center drain.
- Low-threshold assures ease of exit and entry of the shower space.
- Water containment bead along the step over threshold provides optimum barrier to eliminate water escaping from the shower.
- Textured bottom surface.
- One-piece construction.
- Compliments traditional and contemporary bathroom designs.
- Coordinates with Choreograph™ walls.

Material

- Acrylic

Installation

- Alcove
- 3-side integral flange.

Recommended Accessories

K-9132 Shower Drain



Codes/Standards







CSA B45.5/IAPMO Z124
ASTM E162
ASTM E662
Greenguard UL 2818 - Gold

KOHLER® One-Year Limited Warranty

See website for detailed warranty information.

Available Color/Finishes

Color tiles intended for reference only.

Color	Code	Description
	0	White
	96	Biscuit
	47	Almond
	NY	Dune
	95	Ice™ Grey
	G9	Sandbar

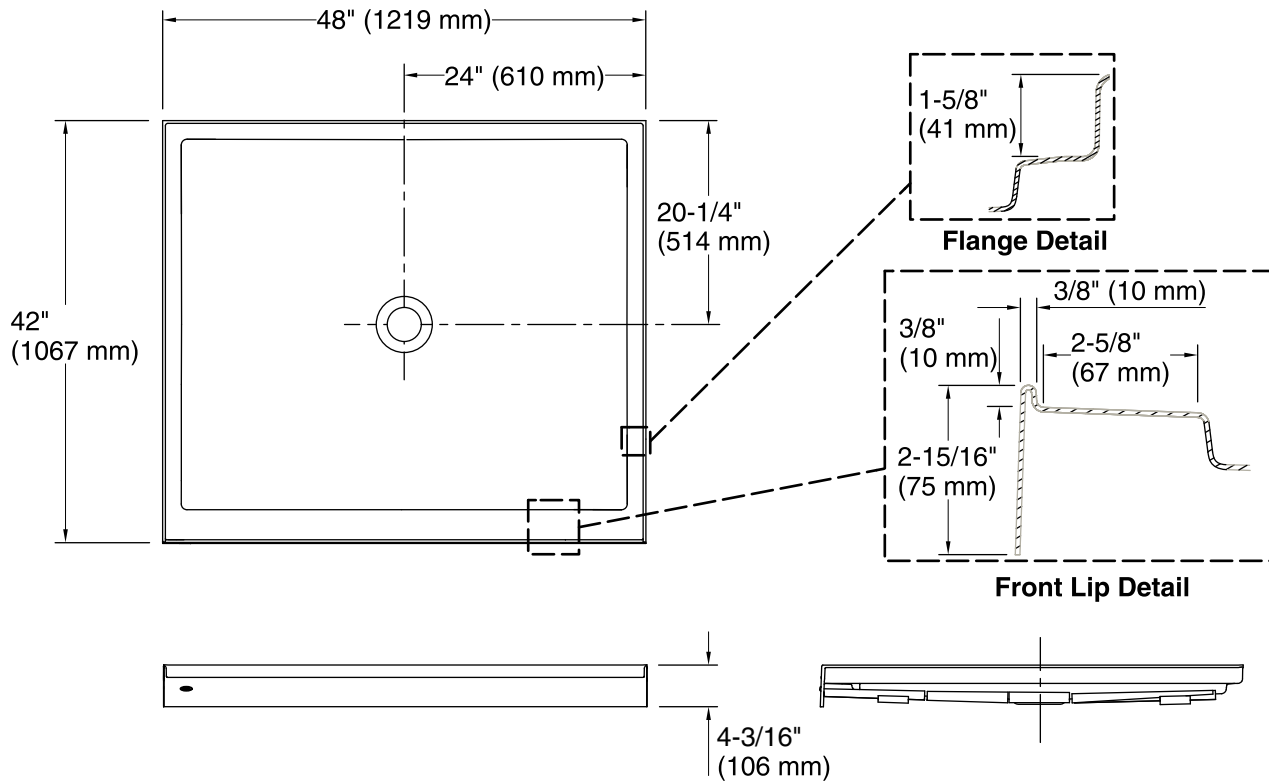

Technical Information

All product dimensions are nominal.

Installation: 3-Wall Alcove
 Drain location: Center
 Weight: 59 lbs (26.8 kg)

Notes

Measure your actual product for rough-in details.
 Install this product according to the installation instructions.
 Subfloor must be within 1/2" (13 mm) of level.
 This receptor has a front lip. This should be taken into account when installing a shower door.