

Definitions: Safety Alert Symbols and Words

This instruction manual uses the following safety alert symbols and words to alert you to hazardous situations and your risk of personal injury or property damage.



DANGER: Indicates an imminently hazardous situation which, if not avoided, **will** result in **death or serious injury**.



WARNING: Indicates a potentially hazardous situation which, if not avoided, **could** result in **death or serious injury**.



CAUTION: Indicates a potentially hazardous situation which, if not avoided, **may** result in **minor or moderate injury**.



(Used without word) Indicates a safety related message.

NOTICE: Indicates a practice **not related to personal injury** which, if not avoided, **may** result in **property damage**.

Fig. A

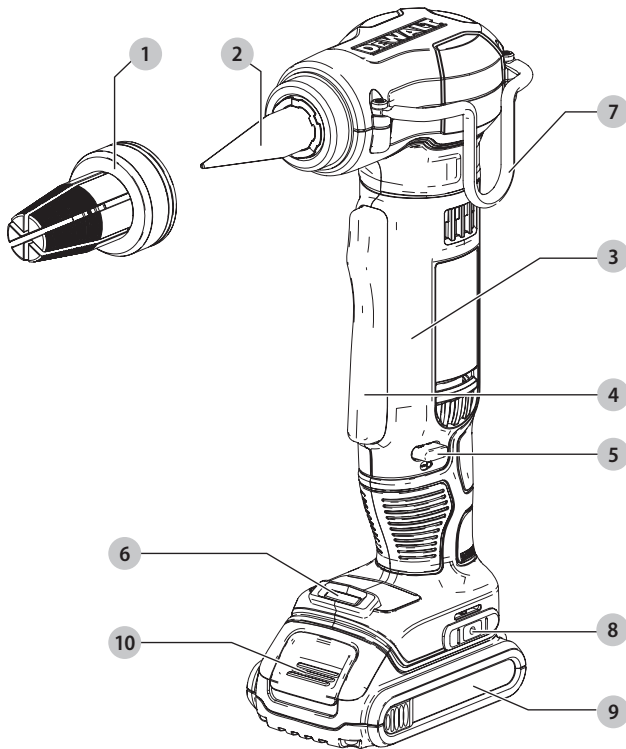

- 1 Expander head
- 2 Expander cone
- 3 Handle
- 4 Trigger switch
- 5 Trigger lock

- 6 LED
- 7 Hang hook
- 8 Belt hook attachment location
- 9 Battery
- 10 Battery release



WARNING! Read all safety warnings, instructions, illustrations and specifications provided with this power tool. Failure to follow all instructions listed below may result in electric shock, fire and/or serious injury.



WARNING: To reduce the risk of injury, read the instruction manual.

If you have any questions or comments about this or any DeWALT tool, call us toll free at: 1-800-4-DeWALT (1-800-433-9258).

GENERAL POWER TOOL SAFETY WARNINGS



WARNING! Read all safety warnings, instructions, illustrations and specifications provided with this power tool. Failure to follow all instructions listed below may result in electric shock, fire and/or serious injury.

SAVE ALL WARNINGS AND INSTRUCTIONS FOR FUTURE REFERENCE

The term "power tool" in the warnings refers to your mains-operated (corded) power tool or battery-operated (cordless) power tool.

1) Work Area Safety

- a) **Keep work area clean and well lit.** Cluttered or dark areas invite accidents.
- b) **Do not operate power tools in explosive atmospheres, such as in the presence of flammable liquids, gases or dust.** Power tools create sparks which may ignite the dust or fumes.
- c) **Keep children and bystanders away while operating a power tool.** Distractions can cause you to lose control.

2) Electrical Safety

- a) **Power tool plugs must match the outlet. Never modify the plug in any way. Do not use any adapter plugs with earthed (grounded) power tools.** Unmodified plugs and matching outlets will reduce risk of electric shock.
- b) **Avoid body contact with earthed or grounded surfaces such as pipes, radiators, ranges and refrigerators.** There is an increased risk of electric shock if your body is earthed or grounded.
- c) **Do not expose power tools to rain or wet conditions.** Water entering a power tool will increase the risk of electric shock.
- d) **Do not abuse the cord. Never use the cord for carrying, pulling or unplugging the power tool. Keep cord away from heat, oil, sharp edges or moving parts.** Damaged or entangled cords increase the risk of electric shock.
- e) **When operating a power tool outdoors, use an extension cord suitable for outdoor use.** Use of a cord suitable for outdoor use reduces the risk of electric shock.
- f) **If operating a power tool in a damp location is unavoidable, use a ground fault circuit interrupter (GFCI) protected supply.** Use of a GFCI reduces the risk of electric shock.

3) Personal Safety

- a) **Stay alert, watch what you are doing and use common sense when operating a power tool. Do not use a power tool while you are tired or under the influence of drugs, alcohol or medication.** A moment of inattention while operating power tools may result in serious personal injury.

- b) **Use personal protective equipment. Always wear eye protection.** Protective equipment such as dust mask, non-skid safety shoes, hard hat, or hearing protection used for appropriate conditions will reduce personal injuries.
- c) **Prevent unintentional starting. Ensure the switch is in the off position before connecting to power source and/or battery pack, picking up or carrying the tool.** Carrying power tools with your finger on the switch or energizing power tools that have the switch on invites accidents.
- d) **Remove any adjusting key or wrench before turning the power tool on.** A wrench or a key left attached to a rotating part of the power tool may result in personal injury.
- e) **Do not overreach. Keep proper footing and balance at all times.** This enables better control of the power tool in unexpected situations.
- f) **Dress properly. Do not wear loose clothing or jewelry. Keep your hair, clothing and gloves away from moving parts.** Loose clothes, jewelry or long hair can be caught in moving parts.
- g) **If devices are provided for the connection of dust extraction and collection facilities, ensure these are connected and properly used.** Use of dust collection can reduce dust-related hazards.
- h) **Do not let familiarity gained from frequent use of tools allow you to become complacent and ignore tool safety principles.** A careless action can cause severe injury within a fraction of a second.

4) Power Tool Use and Care

- a) **Do not force the power tool. Use the correct power tool for your application.** The correct power tool will do the job better and safer at the rate for which it was designed.
- b) **Do not use the power tool if the switch does not turn it on and off.** Any power tool that cannot be controlled with the switch is dangerous and must be repaired.
- c) **Disconnect the plug from the power source and/or the battery pack from the power tool before making any adjustments, changing accessories, or storing power tools.** Such preventive safety measures reduce the risk of starting the power tool accidentally.
- d) **Store idle power tools out of the reach of children and do not allow persons unfamiliar with the power tool or these instructions to operate the power tool.** Power tools are dangerous in the hands of untrained users.
- e) **Maintain power tools. Check for misalignment or binding of moving parts, breakage of parts and any other condition that may affect the power tool's operation. If damaged, have the power tool repaired before use.** Many accidents are caused by poorly maintained power tools.

- f) **Keep cutting tools sharp and clean.** Properly maintained cutting tools with sharp cutting edges are less likely to bind and are easier to control.
- g) **Use the power tool, accessories and tool bits, etc. in accordance with these instructions, taking into account the working conditions and the work to be performed.** Use of the power tool for operations different from those intended could result in a hazardous situation.
- h) **Keep handles and grasping surfaces dry, clean and free from oil and grease.** Slippery handles and grasping surfaces do not allow for safe handling and control of the tool in unexpected situations.

5) Battery Tool Use and Care

- a) **Recharge only with the charger specified by the manufacturer.** A charger that is suitable for one type of battery pack may create a risk of fire when used with another battery pack.
- b) **Use power tools only with specifically designated battery packs.** Use of any other battery packs may create a risk of injury and fire.
- c) **When battery pack is not in use, keep it away from other metal objects, like paper clips, coins, keys, nails, screws, or other small metal objects, that can make a connection from one terminal to another.** Shorting the battery terminals together may cause burns or a fire.
- d) **Under abusive conditions, liquid may be ejected from the battery; avoid contact. If contact accidentally occurs, flush with water. If liquid contacts eyes, additionally seek medical help.** Liquid ejected from the battery may cause irritation or burns.

6) Service

- a) **Have your power tool serviced by a qualified repair person using only identical replacement parts.** This will ensure that the safety of the power tool is maintained.

Additional Safety Rules for Expansion Tools



WARNING: Use the expander tool only with D_EWALT or D_EWALT-approved attachments. Other uses or modifying the expander tool for other applications may damage the expander tool, damage the attachments and/or can result in a faulty installation. Faulty installations can result in catastrophic failures, injury to installers and damage to property.



WARNING: Proper preparation and installation is the responsibility of the installing contractor.

- **Keep all body parts away from the attachments during operation and any time the power is ON. A moment of inattention while operating power tools, may result in serious personal injury.** Fingers or hands can be pinched if they become caught in the attachments.
- **Inspect tool and attachments before use. Never attempt to repair or use a damaged expander head or other attachment.** Replace with a new expander head.

- **This tool produces large forces that can break attachments or parts and cause injury.** Always be attentive and take proper safety precautions, including wearing eye protection.
- **Only trained personnel should operate this tool.**
- **Before operating, inspect job site for hazards including chemicals or waste that could remain in pipes.**
- **Before operating, read and understand all safety and operating instructions including the fitting manufacturer's installation instructions and the instructions for any other equipment used with this tool.** Failure to follow all instructions and warnings may result in property damage and/or serious personal injury.
- **Secure and support the material to prevent movement during operation.**
- **Keep a firm grip on the tool at all times.** Forces on the tool may change during and after the operation.
- **Expansion operations may cause material pieces to fly. Flying particles can cause permanent eye damage.** ALWAYS wear eye protection.
- **Always wear gloves when operating tool and handling materials.** The ends of the materials can be sharp and can cause serious personal injury.
- **Always wear safety shoes to protect your feet from sharp metal debris on the floor.**
- **To reduce the chance of damage to your PEX expander, always store your tool with the expander head installed.**
- **The expander cones sharp end may cause injury to the user without the expander head installed.**
- **Improper lubrication may lead to defective connections.**

Additional Safety Information



WARNING: ALWAYS use safety glasses. Everyday eyeglasses are NOT safety glasses. Also use face or dust mask if cutting operation is dusty. ALWAYS WEAR CERTIFIED SAFETY EQUIPMENT:

- ANSI Z87.1 eye protection (CAN/CSA Z94.3),
- ANSI S12.6 (S3.19) hearing protection,
- NIOSH/OSHA/MSHA respiratory protection.



WARNING: Some dust created by power sanding, sawing, grinding, drilling, and other construction activities contains chemicals known to the State of California to cause cancer, birth defects or other reproductive harm. Some examples of these chemicals are:

- lead from lead-based paints,
- crystalline silica from bricks and cement and other masonry products, and
- arsenic and chromium from chemically-treated lumber.

Your risk from these exposures varies, depending on how often you do this type of work. To reduce your exposure to these chemicals: work in a well ventilated area, and work with

ENGLISH

approved safety equipment, such as those dust masks that are specially designed to filter out microscopic particles.

- **Avoid prolonged contact with dust from power sanding, sawing, grinding, drilling, and other construction activities. Wear protective clothing and wash exposed areas with soap and water.** Allowing dust to get into your mouth, eyes, or lay on the skin may promote absorption of harmful chemicals.













 **WARNING:** Use of this tool can generate and/or disperse dust, which may cause serious and permanent respiratory or other injury. Always use NIOSH/OSHA approved respiratory protection appropriate for the dust exposure. Direct particles away from face and body.

 **WARNING:** Always wear proper personal hearing protection that conforms to ANSI S12.6 (S3.19) during use. Under some conditions and duration of use, noise from this product may contribute to hearing loss.

 **CAUTION:** When not in use, place tool on its side on a stable surface where it will not cause a tripping or falling hazard. Some tools with large battery packs will stand upright on the battery pack but may be easily knocked over.

- **Air vents often cover moving parts and should be avoided.** Loose clothes, jewelry or long hair can be caught in moving parts.

The label on your tool may include the following symbols. The symbols and their definitions are as follows:

V.....volts	 or AC/DC.....alternating or direct current
Hz.....hertz	Class II Construction (double insulated)
min.....minutes	n_0no load speed
 or DC.....direct current	n.....rated speed
Class I Construction (grounded)	earthing terminal
.../min.....per minute	safety alert symbol
BPM.....beats per minute	visible radiation
IPM.....impacts per minute	wear respiratory protection
RPM.....revolutions per minute	wear eye protection
sfpn.....surface feet per minute	wear hearing protection
SPM.....strokes per minute	read all documentation
A.....amperes	
W.....watts	
 or AC.....alternating current	

BATTERIES AND CHARGERS

The battery pack is not fully charged out of the carton. Before using the battery pack and charger, read the safety instructions below and then follow charging procedures outlined. When ordering replacement battery packs, be sure to include the catalog number and voltage. Your tool uses a DeWALT charger. Be sure to read all safety instructions before using your charger. Consult the chart at the end of this manual for compatibility of chargers and battery packs.

READ ALL INSTRUCTIONS

Important Safety Instructions for All Battery Packs

 **WARNING:** Read all safety warnings and all instructions for the battery pack, charger and power tool. Failure to follow the warnings and instructions may result in electric shock, fire and/or serious injury.

- **Do not charge or use the battery pack in explosive atmospheres, such as in the presence of flammable liquids, gases or dust.** Inserting or removing the battery pack from the charger may ignite the dust or fumes.
- **NEVER force the battery pack into the charger. DO NOT modify the battery pack in any way to fit into a non-compatible charger as battery pack may rupture causing serious personal injury.** Consult the chart at the end of this manual for compatibility of batteries and chargers.
- Charge the battery packs only in designated DeWALT chargers.
- **DO NOT splash or immerse in water or other liquids.**
- **Do not store or use the tool and battery pack in locations where the temperature may reach or exceed 104 °F (40 °C) (such as outside sheds or metal buildings in summer).** For best life store battery packs in a cool, dry location.

NOTE: Do not store the battery packs in a tool with the trigger switch locked on. Never tape the trigger switch in the ON position.

- **Do not incinerate the battery pack even if it is severely damaged or is completely worn out.** The battery pack can explode in a fire. Toxic fumes and materials are created when lithium ion battery packs are burned.
- **If battery contents come into contact with the skin, immediately wash area with mild soap and water.** If battery liquid gets into the eye, rinse water over the open eye for 15 minutes or until irritation ceases. If medical attention is needed, the battery electrolyte is composed of a mixture of liquid organic carbonates and lithium salts.
- **Contents of opened battery cells may cause respiratory irritation.** Provide fresh air. If symptoms persist, seek medical attention.

 **WARNING:** Burn hazard. Battery liquid may be flammable if exposed to spark or flame.

 **WARNING:** Fire hazard. Never attempt to open the battery pack for any reason. If the battery pack case is cracked or damaged, do not insert into the charger. Do not crush, drop or damage the battery pack. Do not use a battery pack or charger that has received a sharp blow, been dropped, run over or damaged in any way (e.g., pierced with a nail, hit with a hammer, stepped on). Damaged battery packs should be returned to the service center for recycling.

Transportation



WARNING: Fire hazard. Do not store or carry the battery pack so that metal objects can contact exposed battery terminals. For example, do not place the battery pack in aprons, pockets, tool boxes, product kit boxes, drawers, etc., with loose nails, screws, keys, etc. **Transporting batteries can possibly cause fires if the battery terminals inadvertently come in contact with conductive materials such as keys, coins, hand tools and the like.** The US Department of Transportation Hazardous Material Regulations (HMR) actually prohibit transporting batteries in commerce or on airplanes in carry-on baggage UNLESS they are properly protected from short circuits. So when transporting individual battery packs, make sure that the battery terminals are protected and well insulated from materials that could contact them and cause a short circuit.

Shipping the DeWALT FLEXVOLT™ Battery

The DeWALT FLEXVOLT™ battery has two modes: **Use** and **Shipping**.

Use Mode: When the FLEXVOLT™ battery stands alone or is in a DeWALT 20V Max* product, it will operate as a 20V Max* battery. When the FLEXVOLT™ battery is in a 60V Max* or a 120V Max* (two 60V Max* batteries) product, it will operate as a 60V Max* battery.

Shipping Mode: When the cap is attached to the FLEXVOLT™ battery, the battery is in Shipping Mode. Strings of cells are electrically disconnected within the pack resulting in three batteries with a lower Watt hour (Wh) rating as compared to one battery with a higher Watt hour rating. This increased quantity of three batteries with the lower Watt hour rating can exempt the pack from certain shipping regulations that are imposed upon the higher Watt hour batteries.

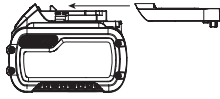

The battery label indicates two Watt hour ratings (see example). Depending on how the battery is shipped, the appropriate Watt hour rating must be used to determine the applicable shipping requirements. If utilizing the shipping cap, the pack will be considered 3 batteries at the Watt hour rating indicated for “Shipping”. If shipping without the cap or in a tool, the pack will be considered one battery at the Watt hour rating indicated next to “Use”.

Example of Use and Shipping Label Marking

USE: 120 Wh Shipping: 3 x 40 Wh

For example, Shipping Wh rating might indicate 3 x 40 Wh, meaning 3 batteries of 40 Watt hours each. The Use Wh rating might indicate 120 Wh (1 battery implied).

Fuel Gauge Battery Packs (Fig. B)

Some DeWALT battery packs include a fuel gauge which consists of three green LED lights that indicate the level of charge remaining in the battery pack.

The fuel gauge is an indication of approximate levels of charge remaining in the battery pack according to the following indicators:

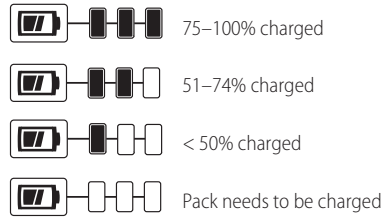

To actuate the fuel gauge, press and hold the fuel gauge button. A combination of the three green LED lights will illuminate designating the level of charge left. When the level of charge in the battery is below the usable limit, the fuel gauge will not illuminate and the battery will need to be recharged.

Fig. B



NOTE: The fuel gauge is only an indication of the charge left on the battery pack. It does not indicate tool functionality and is subject to variation based on product components, temperature and end-user application.

For more information regarding fuel gauge battery packs, please contact call 1-800-4-DeWALT (1-800-433-9258) or visit our website www.dewalt.com.

The RBRC® Seal

The RBRC® (Rechargeable Battery Recycling Corporation) Seal on the nickel cadmium, nickel metal hydride or lithium-ion batteries (or battery packs) indicates that the costs to recycle these batteries (or battery packs) at the end of their useful life have already been paid by DeWALT. In some areas, it is illegal to place spent nickel cadmium, nickel metal hydride or lithium-ion batteries in the trash or municipal solid waste stream and the Call 2 Recycle® program provides an environmentally conscious alternative.



Call 2 Recycle, Inc., in cooperation with DeWALT and other battery users, has established the program in the United States and Canada to facilitate the collection of spent nickel cadmium, nickel metal hydride or lithium-ion batteries. Help protect our environment and conserve natural resources by returning the spent nickel cadmium, nickel metal hydride or lithium-ion batteries to an authorized DeWALT service center or to your local retailer for recycling. You may also contact your local recycling center for information on where to drop off the spent battery. RBRC® is a registered trademark of Call 2 Recycle, Inc.

Important Safety Instructions for All Battery Chargers



WARNING: Read all safety warnings and all instructions for the battery pack, charger and power tool. Failure to follow the warnings and instructions may result in electric shock, fire and/or serious injury.

ENGLISH

- **DO NOT attempt to charge the battery pack with any chargers other than the ones in this manual.**
The charger and battery pack are specifically designed to work together.
- **These chargers are not intended for any uses other than charging DeWALT rechargeable batteries.**
Any other uses may result in risk of fire, electric shock or electrocution.
- **Do not expose the charger to rain or snow.**
- **Pull by the plug rather than the cord when disconnecting the charger.** This will reduce the risk of damage to the electric plug and cord.
- **Make sure that the cord is located so that it will not be stepped on, tripped over or otherwise subjected to damage or stress.**
- **Do not use an extension cord unless it is absolutely necessary.** Use of improper extension cord could result in risk of fire, electric shock or electrocution.
- **When operating a charger outdoors, always provide a dry location and use an extension cord suitable for outdoor use.** Use of a cord suitable for outdoor use reduces the risk of electric shock.
- **An extension cord must have adequate wire size (AWG or American Wire Gauge) for safety.** The smaller the gauge number of the wire, the greater the capacity of the cable, that is, 16 gauge has more capacity than 18 gauge. An undersized cord will cause a drop in line voltage resulting in loss of power and overheating. When using more than one extension to make up the total length, be sure each individual extension contains at least the minimum wire size. The following table shows the correct size to use depending on cord length and nameplate ampere rating. If in doubt, use the next heavier gauge. The lower the gauge number, the heavier the cord.

Minimum Gauge for Cord Sets

Volts		Total Length of Cord in Feet (meters)			
		25 (7.6)	50 (15.2)	100 (30.5)	150 (45.7)
120 V		25 (7.6)	50 (15.2)	100 (30.5)	150 (45.7)
240 V		50 (15.2)	100 (30.5)	200 (61.0)	300 (91.4)
Ampere Rating More Than	Not More Than	American Wire Gauge			
		0	6	10	12
0	6	18	16	16	14
6	10	18	16	14	12
10	12	16	16	14	12
12	16	14	12	Not Recommended	

- **Do not place any object on top of the charger or place the charger on a soft surface that might block the ventilation slots and result in excessive internal heat.** Place the charger in a position away from any heat source. The charger is ventilated through slots in the top and the bottom of the housing.
- **Do not operate the charger with a damaged cord or plug.**
- **Do not operate the charger if it has received a sharp blow, been dropped or otherwise damaged in any way.** Take it to an authorized service center.

- **Do not disassemble the charger; take it to an authorized service center when service or repair is required.** Incorrect reassembly may result in a risk of electric shock, electrocution or fire.
- **Disconnect the charger from the outlet before attempting any cleaning.** This will reduce the risk of electric shock. Removing the battery pack will not reduce this risk.
- **NEVER attempt to connect 2 chargers together.**
- **The charger is designed to operate on standard 120V household electrical power. Do not attempt to use it on any other voltage.** This does not apply to the vehicular charger.

WARNING: Shock hazard. Do not allow any liquid to get inside the charger. Electric shock may result.

WARNING: Burn hazard. Do not submerge the battery pack in any liquid or allow any liquid to enter the battery pack. Never attempt to open the battery pack for any reason. If the plastic housing of the battery pack breaks or cracks, return to a service center for recycling.

CAUTION: Burn hazard. To reduce the risk of injury, charge only DeWALT rechargeable battery packs. Other types of batteries may overheat and burst resulting in personal injury and property damage.

NOTICE: Under certain conditions, with the charger plugged into the power supply, the charger can be shorted by foreign material. Foreign materials of a conductive nature, such as, but not limited to, grinding dust, metal chips, steel wool, aluminum foil or any buildup of metallic particles should be kept away from the charger cavities. Always unplug the charger from the power supply when there is no battery pack in the cavity. Unplug the charger before attempting to clean.

Charging a Battery (Fig. C)

1. Plug the charger into an appropriate outlet before inserting battery pack.

Fig. C

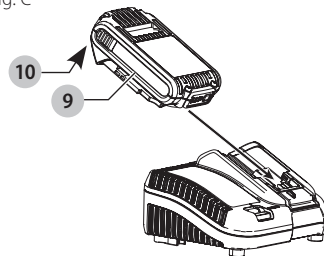

2. Insert the battery pack 9 into the charger, making sure the battery pack is fully seated in the charger. The red (charging) light will blink continuously indicating that the charging process has started.
3. The completion of charge will be indicated by the red light remaining ON continuously. The battery pack is fully charged and may be used at this time or left in the charger. To remove the battery pack from the charger, push the battery release button 10 on the battery pack.

NOTE: To ensure maximum performance and life of lithium-ion battery packs, charge the battery pack fully before first use.

Charger Operation

Refer to the indicators below for the charge status of the battery pack.

DCB101		
	Charging	— — — — —
	Fully Charged	—————
	Hot/Cold Pack Delay	— • — • — •
	Problem Pack or Charger	• • • • • • • •
DCB107, DCB112, DCB113, DCB115, DCB118, DCB132		
	Charging	— — — — —
	Fully Charged	—————
	Hot/Cold Pack Delay*	— — — — — —————

*DCB107, DCB112, DCB113, DCB115, DCB118, DCB132:

The red light will continue to blink, but a yellow indicator light will be illuminated during this operation. Once the battery pack has reached an appropriate temperature, the yellow light will turn off and the charger will resume the charging procedure.

The compatible charger(s) will not charge a faulty battery pack. The charger will indicate faulty battery pack by refusing to light or by displaying a problem pack or charger blink pattern.

NOTE: This could also mean a problem with a charger.

If the charger indicates a problem, take the charger and battery pack to be tested at an authorized service center.

Hot/Cold Pack Delay

When the charger detects a battery pack that is too hot or too cold, it automatically starts a Hot/Cold Pack Delay, suspending charging until the battery pack has reached an appropriate temperature. The charger then automatically switches to the pack charging mode. This feature ensures maximum battery pack life.

A cold battery pack will charge at a slower rate than a warm battery pack. The battery pack will charge at that slower rate throughout the entire charging cycle and will not return to maximum charge rate even if the battery pack warms.

The DCB118 charger is equipped with an internal fan designed to cool the battery pack. The fan will turn on automatically when the battery pack needs to be cooled. Never operate the charger if the fan does not operate properly or if ventilation slots are blocked. Do not permit foreign objects to enter the interior of the charger.

Electronic Protection System

Li-Ion tools are designed with an Electronic Protection System that will protect the battery pack against overloading, overheating or deep discharge.

The tool will automatically turn off if the Electronic Protection System engages. If this occurs, place the lithium-ion battery pack on the charger until it is fully charged.

Wall Mounting

DCB107, DCB112, DCB113, DCB115, DCB118, DCB132

These chargers are designed to be wall mountable or to sit upright on a table or work surface. If wall mounting, locate the charger within reach of an electrical outlet, and away from a corner or other obstructions which may impede air flow. Use the back of the charger as a template for the location of the mounting screws on the wall. Mount the charger securely using drywall screws (purchased separately) at least 1" (25.4 mm) long, with a screw head diameter of 0.28–0.35" (7–9 mm), screwed into wood to an optimal depth leaving approximately 7/32" (5.5 mm) of the screw exposed. Align the slots on the back of the charger with the exposed screws and fully engage them in the slots.

Charger Cleaning Instructions



WARNING: Shock hazard. Disconnect the charger from the AC outlet before cleaning. Dirt and grease may be removed from the exterior of the charger using a cloth or soft non-metallic brush. Do not use water or any cleaning solutions.

Important Charging Notes

- Longest life and best performance can be obtained if the battery pack is charged when the air temperature is between 65 °F and 75 °F (18 ° – 24 °C). DO NOT charge the battery pack in an air temperature below +40 °F (+4.5 °C), or above +104 °F (+40 °C). This is important and will prevent serious damage to the battery pack.
- The charger and battery pack may become warm to the touch while charging. This is a normal condition, and does not indicate a problem. To facilitate the cooling of the battery pack after use, avoid placing the charger or battery pack in a warm environment such as in a metal shed or an uninsulated trailer.
- If the battery pack does not charge properly:
 - Check operation of receptacle by plugging in a lamp or other appliance;
 - Check to see if receptacle is connected to a light switch which turns power off when you turn out the lights;
 - Move the charger and battery pack to a location where the surrounding air temperature is approximately 65 °F – 75 °F (18 ° – 24 °C);
 - If charging problems persist, take the tool, battery pack and charger to your local service center.
- The battery pack should be recharged when it fails to produce sufficient power on jobs which were easily done previously. DO NOT CONTINUE to use under these conditions. Follow the charging procedure. You may also charge a partially used pack whenever you desire with no adverse effect on the battery pack.
- Foreign materials of a conductive nature such as, but not limited to, grinding dust, metal chips, steel wool, aluminum foil, or any buildup of metallic particles

ENGLISH

should be kept away from charger cavities. Always unplug the charger from the power supply when there is no battery pack in the cavity. Unplug the charger before attempting to clean.

6. Do not freeze or immerse the charger in water or any other liquid.

Storage Recommendations

1. The best storage place is one that is cool and dry, away from direct sunlight and excess heat or cold.
2. For long storage, it is recommended to store a fully charged battery pack in a cool dry place out of the charger for optimal results.

NOTE: Battery packs should not be stored completely depleted of charge. The battery pack will need to be recharged before use.

SAVE THESE INSTRUCTIONS FOR FUTURE USE

COMPONENTS (FIG. A)



WARNING: Never modify the power tool or any part of it. Damage or personal injury could result.

Refer to Figure A at the beginning of this manual for a complete list of components.

Intended Use

Your DCE400 PEX expander is designed for professional PEX tube expansion applications.

Your PEX expander was designed for use with PEX-A material only. Using your PEX expander with unrecommended material may cause cracking or splitting, resulting in an improper seal.

DO NOT use under wet conditions or in presence of flammable liquids or gases.

The DCE400 PEX expander is a professional power tool.

DO NOT let children come into contact with the tool.

Supervision is required when inexperienced operators use this tool.

SPECIFICATIONS

DCE400

Max PEX-A Diameter	3/8"–1"
Expander Heads	DCE40038 –3/8" PEX Expander Head DCE40058 –5/8" PEX Expander Head DCE40034 –3/4" PEX Expander Head DCE40012 –1/2" PEX Expander Head DCE4001 –1" PEX Expander Head
Lubricant	DCE400GR Expander Grease

ASSEMBLY AND ADJUSTMENTS



WARNING: To reduce the risk of serious personal injury, turn unit off and remove the battery pack before making any adjustments or removing/installing attachments or accessories. An accidental start-up can cause injury.

Installing and Removing the Expander Head (Fig. A, D)

To install an expander head ①, screw onto the tool clockwise until hand tight. **DO NOT** over tighten. To uninstall an expander head, unscrew from the tool counterclockwise.

NOTICE: To reduce the chance of damage to your PEX expander, **ALWAYS** store your tool with the expander head installed.

Fig. D

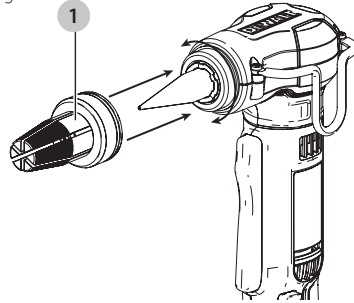

Hang Hook (Fig. A)



WARNING: To reduce the risk of serious personal injury, **ONLY** use the tool's hang hook to hang the tool from a work belt. **DO NOT** use the hang hook for tethering or securing the tool to a person or object during use. **DO NOT** suspend tool overhead or suspend objects from the hang hook.



WARNING: To reduce the risk of serious personal injury, ensure the screws holding the hang hook are secure.



CAUTION: To reduce the risk of personal injury or damage, **DO NOT** use the hang hook to hang the expander tool while using as a spotlight.

IMPORTANT: When attaching or replacing the hang hook ⑦, use only the screws that are provided. Be sure to securely tighten the screws.

The hang hook can be attached to either side of the tool using only the screws provided, to accommodate left-handed or right-handed users. If the hang hook is not desired at all, they can be removed from the tool.

- To move hang hook, remove the two screws that hold it in place then reassemble on the opposite side. Be sure to securely tighten the screws.

Belt Hook (Optional Accessory) (Fig. A)



WARNING: To reduce the risk of serious personal injury, **DO NOT** suspend tool overhead or suspend objects from the belt hook. **ONLY** hang tool's belt hook from a work belt.



WARNING: To reduce the risk of serious personal injury, ensure the screw holding the belt hook is secure.

IMPORTANT: When attaching or replacing the belt hook, use only the screw that is provided. Be sure to securely tighten the screw.

The belt hook can be attached to either side of the tool using only the screw provided, to accommodate left- or right-handed users. If the hook is not desired at all, it can be removed from the tool.

To move the belt hook, remove the screw that holds the belt hook in place then reassemble on the opposite side. Be sure to securely tighten the screw.

OPERATION

WARNING: To reduce the risk of serious personal injury, turn unit off and remove the battery pack before making any adjustments or removing/installing attachments or accessories. An accidental start-up can cause injury.

WARNING: Proper material preparation and installation is the responsibility of the installing contractor.

WARNING: The tubing and hardware must be used in compliance with applicable building codes and as approved by the authorities having jurisdiction. For proper installation procedures and to reduce the risk of failure resulting in injury or property damage, follow all published safety and installation instructions.

CAUTION: Pinch hazard. Keep fingers away from expander head while in use.

Installing and Removing the Battery Pack (Fig. E)

NOTE: For best results, make sure your battery pack is fully charged.

To install the battery pack **9** into the tool handle, align the battery pack with the rails inside the tool's handle and slide it into the handle until the battery pack is firmly seated in the tool and ensure that it does not disengage.

To remove the battery pack from the tool, press the release button **10** and firmly pull the battery pack out of the tool handle. Insert it into the charger as described in the charger section of this manual.

Fig. E

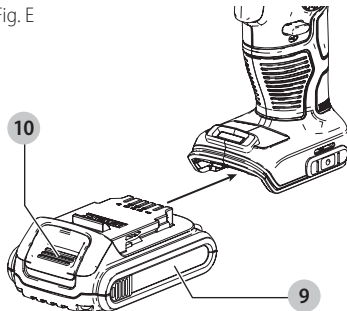

Proper Hand Position (Fig. F)

WARNING: To reduce the risk of serious personal injury, ALWAYS use proper hand position as shown.

WARNING: To reduce the risk of serious personal injury, ALWAYS hold securely in anticipation of a sudden reaction.

Proper hand position requires one hand on the main handle **3**.

Fig. F

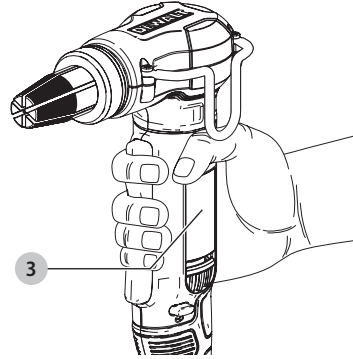

Trigger Switch and Lock Off (Fig. A)

To turn the tool on, squeeze the trigger switch **4**. To turn the tool off, release the trigger switch.

Your PEX expander is equipped with a trigger lock **5**. To lock the trigger switch in the OFF position, push the trigger lock from the left side of the tool. To unlock the trigger switch, push the trigger lock from the right side of the tool.

NOTE: Depressing the trigger switch will activate the LED worklight **6**. The light will dim after two and half minutes and will automatically turn off after three minutes. To turn the light off immediately, remove and reinstall the battery. The worklight is for lighting the immediate work surface and is not intended to be used as a flashlight.

NOTICE: To reduce the chance of damage to the tool ALWAYS lock the tool when not in use.

Creating a PEX Tubing Connection (Fig. A, G, H)

WARNING: Prior to use inspect all workpieces for cracks, defects or wear. Defective workpieces may shatter.

CAUTION: Using incorrectly sized expansion heads may result faulty connection, possibly resulting in damage to property.

To create a proper PEX tubing connection:

1. Select appropriate expander head **1** to match the tubing and, if needed, remove any dirt and debris.
2. Using a clean, lint-free cloth, apply a thin coat of DeWALT DCE400GR grease to the expander cone **2**. **DO NOT** over-lubricate.

ENGLISH

3. Make a perpendicular cut to PEX tubing to the needed length. Use **ONLY** cutters designed for PEX tubing.
4. Slide the PEX Ring **11** over the end of the PEX tubing **12** until it sits properly against the ring stop. If the PEX ring does not have a stop, leave an over-hang of no more than 1/16" (1.6 mm) (Fig. G)

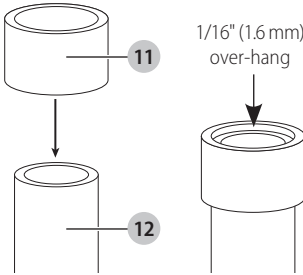

5. Insert the expander head into the PEX tubing (Fig. H).
6. Squeeze the trigger switch **4**. The expander head will begin to expand, retract, and rotate slightly.

NOTE: Hold the ring and tubing so they do not rotate with the head.

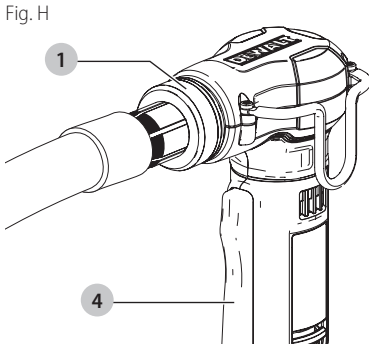

PEX Ring Size	Recommended Number of Expansions
3/8"	6-7
1/2"	7-8
5/8"	9-10
3/4"	11-12
1"	17-18

NOTE: The number of expansions needed may vary depending on temperature or user technique. To avoid over-expanding the PEX tubing, do not keep tool in the expanded position with PEX tubing in place.

7. After achieving the recommended number of expansions, remove the tubing when the expander cone **2** segments are retracted and release the trigger switch **4**. **DO NOT** expand the PEX tubing beyond the tool's capacity of 1 inch.
8. Wipe off the excess grease from inside the PEX tubing.
9. Slide the PEX tubing over the fitting until it is flush with the fitting shoulder. The connection may be tight. If you are unable to slide the PEX tubing over the fitting, remove

the fitting from the PEX tubing and re-expand until you can secure a proper fit.

NOTE: The PEX tubing should fit tightly against the fitting shoulder. If there is more than a 1/16" (1.6 mm) gap between the PEX tubing and the shoulder, cut 2" (50 mm) off the end of the PEX tubing and restart procedure with a new PEX Ring.

Making 3/8" PEX Tubing Connections (Fig. A, G)

The thicker 3/8" PEX rings will not fit over 3/8" PEX tubing without first expanding each end of the PEX ring.

1. Insert the expander head **1** into the PEX ring **11**.
2. Squeeze the trigger switch **4** and allow the expander head to expand the PEX ring once.
3. Remove the PEX ring and repeat steps 1 and 2 for the other end of the PEX ring.
4. **IMMEDIATELY** slide the PEX ring onto the end of the PEX tubing **12** leaving an over-hang of no more than 1/16" (1.6 mm)(Fig. G).

NOTE: 3/8" PEX rings will shrink faster than other size PEX rings.

5. Continue with the steps outlined in **Creating a PEX Tubing Connection** to complete your connection.

Cold weather use

Use of your PEX expander in colder temperatures (<40 °F/4 °C) requires a longer contraction time and less expansions. Attempting to make PEX connections in extreme temperatures (<5 °F/-15 °C) is not recommended.

Expansion Markings (Fig. I)

! CAUTION: *Incorrect expansion of the PEX tubing can create deep grooves in the material which could result in faulty connections and risk of property damage.*

Examples of correct and incorrect markings on the inside of the PEX tubing are shown in Fig. I. Incorrect markings could indicate the head is not rotating properly, or the tubing is rotating with the head.

Fig. I

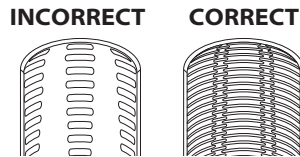

MAINTENANCE

! WARNING: *To reduce the risk of serious personal injury, turn unit off and remove the battery pack before making any adjustments or removing/installing attachments or accessories. An accidental start-up can cause injury.*

Cleaning

! WARNING: *Blow dirt and dust out of all air vents with clean, dry air at least once a week. To minimize the risk of eye injury, always wear ANSI Z87.1 approved eye protection when performing this.*

! WARNING: *Never use solvents or other harsh chemicals for cleaning the non-metallic parts of*

the tool. These chemicals may weaken the plastic materials used in these parts. Use a cloth dampened only with water and mild soap. Never let any liquid get inside the tool; never immerse any part of the tool into a liquid.

Cleaning the Expander Head and Cone (Fig. A)

1. Remove the expander head ① and soak in a degreasing agent to remove grease from between expander segments.
2. Wipe expander cone ② with clean, dry, lint-free cloth.
3. Re-lubricate using DeWALT DCE400GR grease.

Accessories



WARNING: Since accessories, other than those offered by DeWALT, have not been tested with this product, use of such accessories with this tool could be hazardous. To reduce the risk of injury, only DeWALT recommended accessories should be used with this product.

DCE40038 –3/8" PEX Expander Head
 DCE40058 –5/8" PEX Expander Head
 DCE40034 –3/4" PEX Expander Head
 DCE40012 –1/2" PEX Expander Head
 DCE4001 –1" PEX Expander Head

To lubricate the head use only DeWALT DCE400GR PEX Expander Grease.

Recommended accessories for use with your tool are available at extra cost from your local dealer or authorized service center. If you need assistance in locating any accessory, please contact DeWALT Industrial Tool Co., 701 East Joppa Road, Towson, MD 21286, call 1-800-4-DeWALT (1-800-433-9258) or visit our website: www.dewalt.com.

Repairs

The charger and battery pack are not serviceable.



WARNING: To assure product SAFETY and RELIABILITY, repairs, maintenance and adjustment (including brush inspection and replacement, when applicable) should be performed by a DeWALT factory service center or a DeWALT authorized service center. Always use identical replacement parts.

Register Online

Thank you for your purchase. Register your product now for:

- **WARRANTY SERVICE:** Registering your product will help you obtain more efficient warranty service in case there is a problem with your product.
- **CONFIRMATION OF OWNERSHIP:** In case of an insurance loss, such as fire, flood or theft, your registration of ownership will serve as your proof of purchase.
- **FOR YOUR SAFETY:** Registering your product will allow you to contact you in the unlikely event a safety

notification is required under the Federal Consumer Safety Act.

Register online at www.dewalt.com/register.

Three Year Limited Warranty

DeWALT will repair, without charge, any defects due to faulty materials or workmanship for three years from the date of purchase. This warranty does not cover part failure due to normal wear or tool abuse. For further detail of warranty coverage and warranty repair information, visit www.dewalt.com or call 1-800-4-DeWALT (1-800-433-9258). This warranty does not apply to accessories or damage caused where repairs have been made or attempted by others. This warranty gives you specific legal rights and you may have other rights which vary in certain states or provinces.

In addition to the warranty, DeWALT tools are covered by our:

1 YEAR FREE SERVICE

DeWALT will maintain the tool and replace worn parts caused by normal use, for free, any time during the first year after purchase.

2 YEARS FREE SERVICE ON DEWALT BATTERY PACKS

DC9071, DC9091, DC9096, DC9182, DC9280, DC9360, DCB120, DCB127, DCB201, DCB203, DCB203BT, DCB207, DCB361

3 YEARS FREE SERVICE ON DEWALT BATTERY PACKS

DCB200, DCB204, DCB204BT, DCB205, DCB205BT, DCB206, DCB606, DCB609

NOTE: Battery warranty voided if the battery pack is tampered with in any way. DeWALT is not responsible for any injury caused by tampering and may prosecute warranty fraud to the fullest extent permitted by law.

90 DAY MONEY BACK GUARANTEE

If you are not completely satisfied with the performance of your DeWALT Power Tool, Laser, or Nailer for any reason, you can return it within 90 days from the date of purchase with a receipt for a full refund – no questions asked.

LATIN AMERICA: This warranty does not apply to products sold in Latin America. For products sold in Latin America, see country specific warranty information contained in the packaging, call the local company or see website for warranty information.

FREE WARNING LABEL REPLACEMENT: If your warning labels become illegible or are missing, call 1-800-4-DeWALT (1-800-433-9258) for a free replacement.

Troubleshooting Guide

If the fittings will not seal properly:

- **Check to see if the expander head is screwed on tightly.**
 - Tighten the head.
- **Check to see if the expander head segments are bent or misaligned.**
 - Replace the expander head.
- **Are the expander head segments not properly contracting between expansions?**
 - Clean and relubricate the expander head.
 - Check to see if the expander cone is properly lubricated.
 - Clean and relubricate the expander cone.
- **Has the fitting been damaged?**
 - Replace the fitting.
- **Was the PEX tubing removed while the expander cone was in the expanded position?**
 - Cut 2" (50 mm) from the PEX tubing and restart the process.
- **Is the PEX tubing and Ring dry?**
 - Wipe dry with a clean, lint-free cloth.
- **Is there grease from the expander head inside the PEX tubing?**
 - Wipe off all grease from inside the PEX tubing and relubricate the expander head.

The Ring slides during the expansion process:

- **Is the PEX tubing and Ring dry?**
 - Wipe dry with a clean, lint-free cloth
- **Are your hands clean and dry?**
 - Make sure your hands are clean and dry. Oils from your hands can lubricate the PEX tubing and Ring.
- **Is the Ring being held properly in place?**
 - Use your thumb to hold the ring in place for the first couple of expansions.