

Effective March 15, 2016

JCM INDUSTRIES

GENERAL PRODUCT DIRECTORY
Fittings & Fabrications
Repair - Connection - Branching
All Types & Sizes of Pipe

JCM Industries, Inc.
P. O. Box 1220
Nash, Texas 75569-1220
www.jcmindustries.com

Phone Toll Free 800-527-8482
Outside U.S. Call 903-832-2581
Fax Toll Free 800-874-9524
Outside U.S. Fax 903-838-6260

JCM GENERAL PRODUCT DIRECTORY

Effective March 15, 2016

Replaces Directory Dated 3/1/2010

UNIVERSAL CLAMP COUPLINGS / REPAIR FITTINGS

	Page
101 Universal Clamp Coupling - Standard Range	6 - 7
102 Universal Clamp Coupling - Extended Range	8 - 9
103 - 174 Tapped Outlet Clamps	18
108 Universal Clamp Coupling For Sewer Pipe.....	2
131 All Stainless Universal Clamp Coupling - Std Range	10 - 11
132 All Stainless Universal Clamp Coupling - Exd Range	12 - 13
133 - 163 All Stainless Tapped Outlet Clamps	18
121 Gas Repair Clamp	2
151 All Stainless Gas Repair Clamp	2
161 All Stainless Steel Fabricated Lug Clamp	14 - 15
162 All Stainless Steel Fabricated Lug Clamp - Extended Range	16
168 All Stainless Fabricated Lug Lightweight Clamp	17
171 UCC Removeable Lug - Standard Range.....	6 - 7
172 UCC Removeable Lug - Extended Range	8 - 9
105 - 135 Collar Leak Clamp.....	19
106 Bell Joint Leak Clamp for PVC Pipe	20
143 Bell Joint Leak Clamp - Cast Iron, Ductile Iron, C-900/905	20
110 Patch Clamp	21
111 Full Repair Clamps	22
112 Heavy Duty Patch Clamp - Single Band	23
113 Heavy Duty Patch Clamp - Multi-Band	23
114 Mechanical Joint Repair Sleeve.....	4
116 Repair Sleeve for Concrete Steel Cylinder Pipe	4
118 Fabricated Repair Sleeve	4
136 Heavy Duty All Stainless Steel Repair Sleeve	4

COUPLINGS - FLANGED COUPLING ADAPTERS

	Page
201 Steel Coupling - IPS PVC & Stl Pipe O.D.-CI, DI O.D.....	26 - 27
202 Long Steel Coupling.....	28
203 Steel Transition Coupling	29
204 Steel Reducing Coupling.....	29
210 Ductile Iron Coupling - CI, DI, C-900/905 PVC & A/C.....	30
211 Ductile Iron Coupling - IPS PVC & Steel Pipe O.D.	30
212 Ductile Iron Transition Coupling	31
214 Pipe End Cap Coupling.....	32
215 Long Ductile Iron Couplings.....	33
219 Restrained Ductile Iron Coupling	32
220 Galvanized Compression Coupling Series	35
225 Insulating Adapter Gasket.....	35
230 Stiffener Insert for High Density Polyethylene Pipe	37
241 - 242 Optimum Range Coupling	36
301 Flanged Coupling Adapter	38 - 39
303 Steel Fabricated FCA - Special.....	40
304 Steel Fabricated Reducing FCA.....	41
306 Fabricated FCA.....	42
307 Fabricated Reducing FCA.....	43
309 Dismantling Joint.....	44

SERVICE SADDLES

	Page
401 Single Strap Service Saddle	47
402 Double Strap Service Saddle	49
403 Wide Body Service Saddle - SS Strap	47
404 Service Saddle with Double SS Straps	49
405 Coated Wide Body Service Saddle - SS Strap	48
406 Coated Service Saddle with Double SS Straps	50
407 Coated Single Strap SS - electro-galvanized strap.....	48
408 Coated Double Strap SS - electro-galvanized straps.....	50
425 Service Saddle for Concrete Steel Cylinder Pipe.....	51
502 Stainless Steel Service Saddle	52 - 53

TAPPING SLEEVES

	Page
411 Fabricated Tapping Sleeve - Plain End Outlet.....	57
412 Fabricated Tapping Sleeve - Flanged Outlet	62 - 63
413 Fabricated Tapping Cross.....	57
414 Fabricated Mechanical Joint Tapping Sleeve	57
415 Fabricated Tapping Sleeve - Concrete Steel Cylinder Pipe	57
416 Weld-On Tapping Sleeve - Outlet Only.....	77
417 Weld-On Tapping Sleeve	77
418 Fabricated Threaded Outlet Tapping Sleeve	54
419 Fabricated Tapping Sleeve - Mechanical Joint Outlet	66
422 Fabricated Tapping Sleeve for PVC Pipe	64 - 65
429 Fabricated Tapping Sleeve for PVC/MJ Outlet	67
432 All Stainless Steel Tapping Sleeve.....	68 - 69
432T2 Fabricated Lug Lightweight All Stainless Steel Tapping Slv. 70	71
438 All Stainless Steel Threaded Outlet Tapping Sleeve.....	55
439 Stainless Steel Tapping Slv - Mechanical Joint Outlet	72 - 73
440 Line Stop Fittings	78 - 85
452 All Stainless Steel Tapping Sleeve Outlet Seal Gasket	74 - 75
459 Stainless Steel Tap Slv - Mechanical Joint Outlet	76
462 Stainless Steel Tapping Sleeve - Carbon Steel Flange.....	68 - 69
464 Stainless Steel Tapping Sleeve - Carbon Steel Flange.....	74 - 75
465 Stainless Steel Tapping Sleeve - Carbon MJ Outlet	76
469 Stainless Steel Tapping Sleeve - Carbon MJ Outlet	72 - 73
400 Series Tapping Sleeves for HDPE Pipe	86 - 88

RESTRAINERS

600 Sur-Grip Restrainers.....	89 - 91
-------------------------------	---------

PIPE FABRICATIONS, TOOLS & ACCESSORIES

800 Series Surge Suppressor	94
800 Fabricated Tee, Spools & Wall Fittings	93
801 Expansion Joint - Single End.....	92
802 Expansion Joint - Double End	92
900 Series Master Wrenches - 901, 902, 903, 904	95
900 Master Wrench Set.....	95
905 Torque Wrench	96
906 Hydrant Wrench.....	96
910 Deep Well Socket Set.....	96
920 Pipe Outside Diameter Tape.....	96

ENGINEERING INFORMATION











	Page
HDPE Application Information.....	Inside Back Cover
Pipe O.D. Chart	Back Cover

For engineered fittings, see JCM Engineered Fittings Manual
For HDPE fittings, see JCM Fittings and Fabrications for HDPE Manual







JCM Industries fittings are certified to the following standards:
 ANSI/AWWA Standards as Applicable
 ANSI/NSF Standard 61- Drinking Water System Components
 ANSI/NSF Standards 372 - Lead Content (NSF Annex 61-G)



JCM Selection Guide to Repair Fittings

PRODUCT	NUMBER & TYPE	APPLICATION, SIZES AND INFORMATION
 	101 Universal Clamp Coupling - Standard Range	<p>Most popular and economical clamp provides a full circumferential seal and wide range. Sizes 1-1/2" - 12".</p> <p>This multi-band clamp provides a full circumferential seal and offers extended range, heavy duty design and extra safety factor in larger sizes. Sizes 4" - 60".</p> <p>This popular and economical clamp provides a full circumferential seal permanently repairing cast iron and steel gas service lines. Sizes 2" - 12".</p>
	108 Sewer Clamp	
	102 Universal Clamp Coupling - Extended Range	
	121 Gas Repair Clamp	
 	103 Tapped Universal Clamp Coupling - Standard Range	<p>Repair clamps with tapped outlets are recommended for replacement of pulled out corporation stops and in applications where pipe reinforcement is necessary. Taps 3/4" - 2".</p>
	104 Tapped Universal Clamp Coupling - Extended Range	
	123 Gas Service Clamp	
 	131 All Stainless Steel Univ. Clamp Coupling - Std. Range	<p>All stainless version of the popular single band clamp provides a full circumferential seal and wide range. Sizes 1-1/2" - 12".</p> <p>This all stainless multi-band clamp provides a full circumferential seal and offers extended range, heavy duty design and extra safety factor in larger sizes. Sizes 4" - 60".</p> <p>All Stainless Steel construction provides extra corrosion resistance for permanent repair of cast iron and steel gas service lines.</p>
	132 All Stainless Steel Univ. Clamp Coupling - Extd. Range	
	151 All Stainless Gas Repair Clamp	
 	133 All Stainless Tapped Univ. Clamp Cplg. - Standard Range	<p>All stainless repair clamps with tapped outlets are recommended for replacement of pulled out corporation stops and in applications where pipe reinforcement is necessary. Taps 3/4" - 2".</p>
	134 All Stainless Tapped U. C. C. - Extended Range	
	153 All Stainless Gas Service Clamp	
	105 Collar Leak Clamp	<p>This specialty clamp provides a quick, simple means of repairing solvent weld PVC pipe joints. Pressure pipe sizes 2" - 8". Plastic Irrigation Pipe sizes 4" - 15".</p>
135 All Stainless Collar Leak Clamp		
	161 All Stainless Steel Fabricated Lug Clamp	<p>All stainless steel fabricated repair clamp provides full circumferential seal and wide range. All stainless construction is suitable for hot, acidic or corrosive environments. Sizes 2" - 12".</p> <p>168 and 169 All stainless steel fabricated lug Lightweight Clamp for Sewer and Slip Lining applications.</p>
162 All SS Fab Lug Extd Range		
163 Tapped All Stainless Steel Fabricated Lug Clamp		
168 All SS Fab Lug Lightweight Clamp		
169 All SS Fab Lug Lightweight Clamp Extd Range		

JCM Selection Guide to Repair Fittings

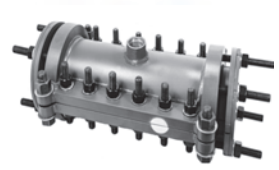
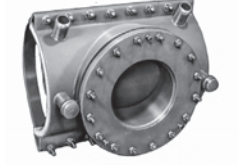
PRODUCT	NUMBER & TYPE	APPLICATION, SIZES AND INFORMATION
 	171 Universal Clamp Coupling - Removeable Lug - Standard Range	Universal Clamp Coupling with unique feature of removeable lug. Lug slides off to accommodate installations in rockbound soils, narrow piping galleries and other limited space installation applications. Sizes 1-1/2" - 12"
	172 Universal Clamp Coupling - Removeable Lug - Extended Range	Multi-band clamp provide full circumferential seal and the removeable lug feature. Heavy duty design and extra safety factor in large sizes. Sizes 4" - 60"
	106 Bell Joint Leak Clamp for IPS PVC	A bell joint repair clamp specifically for rubber joint IPS size plastic pipe. Clamp also fits solvent weld joints and many standard steel pipe threaded couplings. Sizes 4" - 8".
	143 Bell Joint Leak Clamps for Ductile Iron, Cast Iron, C-900 PVC Pipe	Bell joint clamps for leaking caulk and rubber joints on cast iron, ductile iron and C-900/905 PVC Pipe. Sizes 4" - 12" are cast ductile fittings, 14" and larger are fabricated. Sizes 14" and larger are fabricated steel which can accommodate application specific requirements including space limitations, oversized bells, out of round pipe, etc.
	108 Universal Clamp Coupling for Sewer Pipe	A full circumferential clamp coupling to join and repair various types of sewer pipe, single and multi-band versions. Sizes 4" - 48".
	138 All Stainless Steel Univ. Clamp Cplg. for Sewer Pipe	All stainless full circumferential clamp coupling to join and repair sewer pipe, single and multi-band versions. Sizes 4" - 48".
	110 Patch Clamp	Fast, economical repair clamps to permanently repair pinholes, punctures or splits in steel pipe. Sizes 1/2" - 24".
	111 Full-Repair Clamp	Fully gasketed repair clamp. Especially recommended for repairs to heavily damaged pipe and pipe with reduced diameter due to corrosion. Steel Sizes 1/2" - 2".
	112 Heavy Duty Patch Clamp - Single Band	Heavy duty single band patch clamp for repairing pinholes, punctures or splits. Sizes 1-1/2" - 12".
	113 Heavy Duty Patch Clamp - Multi-Band	Heavy duty multi-band clamp offers increased performance and range in repairing pinholes, punctures and splits. Sizes 10" and larger.
	114 Mechanical Joint Repair Sleeve	A special repair sleeve for sealing over split or leaking cast iron bells, A/C couplings and welded couplings. Sizes 4" and larger.
	116 Repair Sleeve for Concrete Steel Cylinder Pipe	A high pressure, reinforcing repair sleeve for repairing holes, punctures and splits in concrete steel cylinder pipe. Especially recommended for heavily damaged and larger sizes of pipe.

JCM Engineered Repair Fitting Selection Guide

JCM provides repair fittings for repairs to all types and sizes of pipe. Selection of the proper fitting is a determining factor to the success of the repair and returning the pipeline to its original service capacity. This chart is an introduction to the Engineered Repair Fittings JCM fabricates and the types of applications for which they would be considered. For specific product application recommendations, contact the JCM Sales Team.

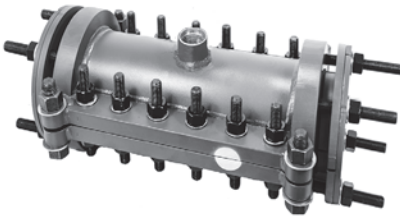
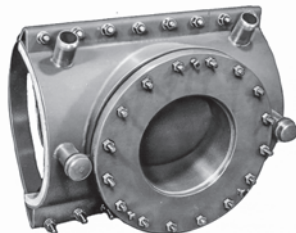
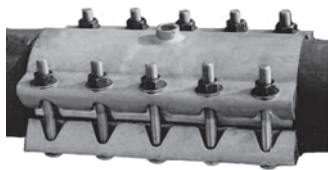
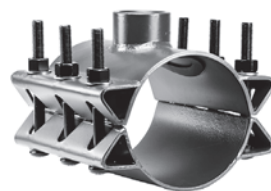
JCM Repair Fitting	Types of Pipe	Application
 <p style="text-align: center;">JCM 114 MJ Repair Sleeve</p>	Cast Iron Ductile Iron Asbestos Cement Steel PVC HDPE	114 Split Repair Sleeve repairs cracks, splits, longitudinal and circumferential breaks. Especially useful for repairs to critical lines that cannot be shut down. Product is custom fabricated to accommodate all types and sizes of pipe. Pipe Sizes 6" and larger.
	Cast Iron Ductile Iron Asbestos Cement Steel PVC HDPE	114 Bell Joint Repair Sleeve repairs cracked cast iron bells, split or leaking couplings, leaking joints. Repair fitting "houses" the leaking connection and provides permanent water tight joint. Product is fabricated to specific application dimensions, ensuring custom fit over damaged area. Pipe Sizes 6" and larger.
 <p style="text-align: center;">JCM 116 Repair Sleeve for Concrete Steel Cylinder Pipe and Large Diameter Pipe</p>	C301/SP-5/PCCP C301/SP-12/ ECCP C303/SP-3/RCCP	Repairs holes, punctures, construction damage, and corroded areas on PCCP. Repairs directly on the steel cylinder preventing further corrosion damage to pipeline. Requires minimal excavation of pipeline. Pipe Sizes 14" and larger.
	Cast Iron Ductile Iron Steel Other large diameter rigid pipe	Repairs holes, punctures, construction damage and corrosion areas on large diameter pipe. Concentration of gasket compression around damage area allows for high working pressure capability. Pipe Sizes 14" and larger
 <p style="text-align: center;">JCM 136 Heavy Duty Stainless Steel Repair Sleeve</p>	Cast Iron Ductile Iron Steel Asbestos Cement PVC	Repairs holes, punctures, splits, cracks, breaks and other serious damage to pipelines. The fully gasketed stainless shell provides a complete seal on the full circumference of the pipe. Heavy duty tapping sleeve lug system provides for higher bolt torque capabilities. Pipe Sizes 6" and larger.
 <p style="text-align: center;">JCM 118 Large Diameter and Non-Standard Contour Pipe Repair Sleeve</p>	Cast Iron Ductile Iron Steel Asbestos Cement PVC HDPE	Repairs holes, punctures, construction damage and corrosion areas on large diameter pipe. Accommodates application parameters such as limited space, non-standard pipe diameters, uneven pipe surfaces, out of round pipe high working pressure systems. Pipe Sizes 12" and larger.

JCM Universal Clamp Couplings Selection

Standard repair clamps in the industry require bolt torque ranges between 60 - 85 ft. lbs. of torque. Some advise not to exceed 75 ft. lbs. of torque due to excessive lug deformation. Difficult installations involving pipe offset or deflection often require more torque to assure proper clamp conformation to the pipe and high gasket compression. Larger pipe sizes and pipelines with higher working pressures also require higher torque capability. JCM Universal Clamp Couplings have bolt torque capability in excess of 100 ft. lbs. on 5/8" bolts and 150 ft. lbs. on 3/4" bolts. These higher torque value capabilities allow JCM Universal Clamp Couplings to go beyond the "standard installation".

As an added PLUS, JCM Universal Clamp Couplings come standard with a thicker gasket in all but the smallest sizes. This heavy 1/4" thick gasket was introduced to the industry to provide for better performance on heavily damaged and pitted pipe. However, it had been available in only 10" and 12" clamp sizes. In JCM clamps this heavier gasket is standard in all sizes 3" and larger. Combined with the **high bolt torque capability**, the heavy gasket feature means more clamp capability under extreme conditions.

Width Selection - 101, 102, 171, 172 Universal Clamp Couplings

JCM Universal Clamp Couplings are available in a great many widths. Because these clamps utilize a heavier gasket and bolting arrangement than most comparable clamps, when you use JCM Universal Clamp Couplings significant savings are possible. The following general recommendations are offered to assist you in taking advantage of the design benefits of these clamps. Specific circumstance may require widths other than these general recommendations.

- 6" Width: Best and most economical width to repair most beam breaks and to connect pipe in sizes 4" and smaller. Short length with thicker gasket give outstanding deflection capability. Recommend 2" of gasket on both sides of the break.
- 7-1/2" Width: Best for Asbestos Cement coupling replacements, beam breaks and connection of pipe in sizes 6" and larger.
- 12" Width: Best for longer breaks, repairs on working pressure above 150 PSI and for larger sizes of pipe.
- 15, 18, 24, 30" and longer widths: Best for long splits and heavily damaged pipe. For best performance the separation between pipe ends should be no more than 1/4". If the space is larger, or a large hole is being repaired, use a sheet of stainless steel over the hole under the gasket or a spacer to fill gap between pipe ends.

JCM Universal Clamp Couplings - Single Band

JCM Universal Clamp Couplings provide a full circumferential seal and wide range for the permanent repair or reconnection of asbestos-cement, cast iron, ductile iron, PVC, HDPE and other types of pipe.

JCM 101 Series Universal Clamp Couplings

Balanced, Low Profile Ductile Iron lugs (ASTM A536) with mutually supporting sliding fingers provide distortion free tightening over a wide range. Ductile Iron lugs offer corrosion resistance and the most efficient method of transfer of energy from the fastener attachment directly to compression of the gasket.

Corrosion Resistant Type 304 Stainless Steel Band conforms to pipe irregularities, maintaining sealing pressure over the entire gasket area. Design criteria requires gauge thickness increase with clamp size. This is just one of the design points which enables JCM Universal Clamp Couplings to withstand the internal forces involved with large pipe repair.

Positive Attachment of stainless band to lugs is a structurally sound fabrication design element which accommodates the higher **“turbo torque”** capabilities ensuring permanent repairs on high pressure applications.

Gridded Gasket with long tapered ends and recessed bridge plate assures even gasket pressure through out the range - without wrinkling or crimping. **Diamond gridded, 1/4” thick gasket** (JCM standard on nominal sizes 4” and larger) adapt to pitted or uneven pipe surfaces to completely seal damaged areas. Standard gasket is compounded for use with water, salt solutions, mild acids, bases and sewage. Other gasket compounds for exotic line contents are available.

Larger Bolts for greater torque ratings are provided on 10” clamps and larger. The 3/4” bolts have bolt torque capability in excess of 100 ft. lbs. These higher torque value capabilities allow JCM Universal Clamp Couplings to go beyond the “standard installation.”

JCM 170 Series Universal Clamp Coupling with Removeable Lug System

Features an Easy to Remove Lug - simply slide the open ear lug section off the stainless band receiver pleat, install the clamp around the pipe and slide the lug back into place. A simple transfer of bolt torque energy from the bolt to the stainless steel band locks the lug into place and prevents band pull out.

Full Line of Diameters and Widths - JCM 170 Series is available in the exact sizes and ranges as the JCM Models 101, 102, 103 and 104 are have the same great availability. Single band, multi-band and tapped outlets are readily available.

JCM 170 Series with Removeable Lug Overcomes common installation problems such as:

- Cramped Underground Utility Applications**
- Rockbound Soil Conditions**
- Restricted, Narrow Space Piping Galleries**
- Limited Excavation Applications**

Corrosion resistant, high strength low alloy bolts and nuts (AWWA C-111, ANSI A21.11.) are standard. Optional 18-8 Type 304 Stainless Steel available. Drop-in bolts means no loose parts.

Meets ANSI/AWWA C230 Stainless-Steel Full-Encirclement Repair and Service Connection Clamps

Low profile Ductile Iron lugs (ASTM A536) with mutually supporting sliding fingers provide distortion free tightening over wide range.

Positive attachment of band to lugs eliminates mechanical weaknesses and band pull-out.

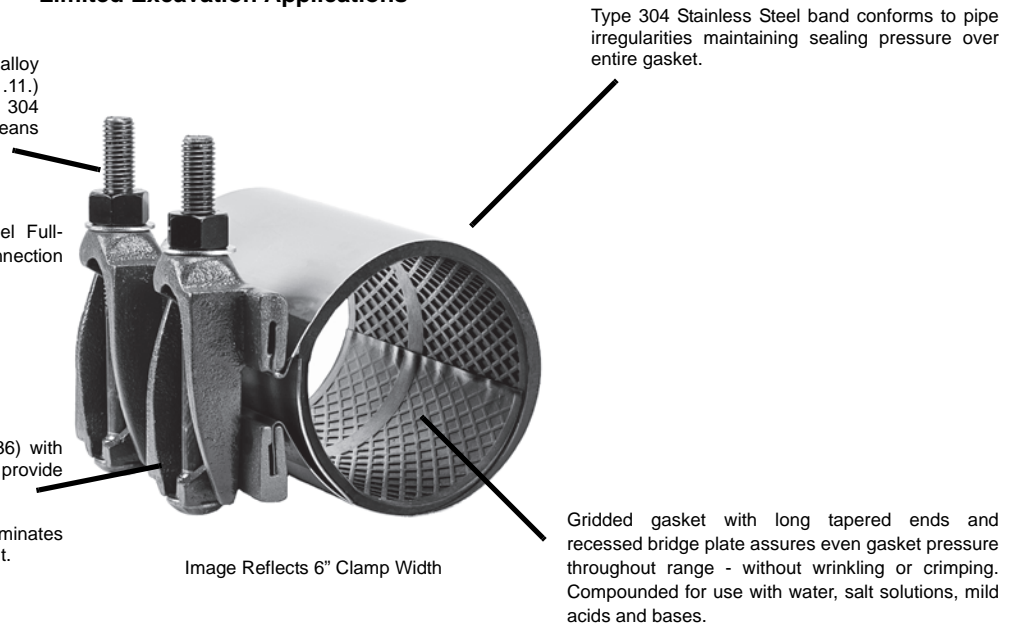

JCM 101 Universal Clamp Couplings

JCM 171 Universal Clamp Couplings

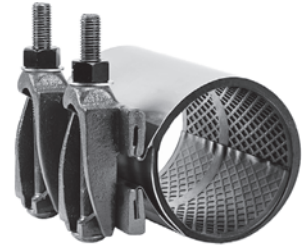

Nom. Pipe Size (IN.)	Clamp O.D. Range (IN.)	101 Attached	171 Removeable Lug	Clamp Width - Approximate Weight						
				6"	7"	12"	15"	18"	24"	30"
				Lbs.#	Lbs.#	Lbs.#	Lbs.#	Lbs.#	Lbs.#	Lbs.#
1-1/2	1.88 - 2.15	0190		•	-	•	-	-	-	-
				7#		14#				
2 - 2-1/2	2.35 - 2.63 2.70 - 3.13	0238 0275		•	•	•	•	-	-	-
				8#	9#	15#	19#			
3	3.46 - 3.70 3.73 - 4.13	0350 0400		•	•	•	•	-	-	-
				8#	10#	16#	20#			
4	4.45 - 4.75 4.74 - 5.14 4.95 - 5.35 5.22 - 5.62	0450 0480 0500 0525		•	•	•	•	•	•	•
				9#	11#	18#	22#	27#	36#	44#
6	5.95 - 6.35 6.56 - 6.96 6.85 - 7.25 7.05 - 7.45 7.45 - 7.85	0600 0663 0690 0710 0745		•	•	•	•	•	•	•
				10#	12#	19#	24#	29#	38#	48#
8	7.95 - 8.35 8.54 - 8.94 8.99 - 9.39 9.27 - 9.67 9.90 - 10.30	0800 0863 0905 0940 1000		•	•	•	•	•	•	•
				11#	13#	21#	27#	32#	42#	53#
10	10.60 - 11.00 11.04 - 11.44 11.34 - 11.74 11.75 - 12.15 12.00 - 12.40	1075 1110 1140 1175 1200		-	•	•	•	•	•	•
					19#	36#	39#	52#	70#	78#
12	12.60 - 13.02 13.10 - 13.50 13.40 - 13.80 13.70 - 14.10 14.00 - 14.40	1275 1320 1340 1370 1400		-	•	•	•	•	•	•
					20#	37#	40#	52#	74#	82#
Number of Bolts				2	2	4	4	6	8	10

HOW TO ORDER

1. Determine O.D. of pipe.
2. Select proper clamp O.D. range and width.
3. Determine Model Number. Model 101 for standard clamp, 171 for Removeable lug system.
4. Specify clamp number. Example: To fit Cast Iron pipe, 6.90 O.D. with 6" width, order: 101-0690-6 or 171-0690-6

Clamps do not prevent lateral movement of pipe. Applications in which the pipe may move out of the clamp, proper anchorage of the pipe must be provided.

Available Options Upon Request Models 101-171-102-172

- Pipe sizes and ranges not listed
- Stainless Steel Bolts
- Conductive Buttons
- Specialty Gaskets
- Tapped clamps, see page 18
- Other Sizes and Ranges



JCM 102 Extended Range Universal Clamp Couplings

JCM 172 Extended Range UCC with Removeable Lug

JCM Extended Range Universal Clamp Coupling - Double/Multi-Band

JCM 102 and 172 Extended Range Universal Clamp Couplings are designed especially for systems with both asbestos-cement and cast iron pipe, or with oversized pipe. This extended range, multi-band clamp provides a full circumferential seal and extra wide range. Only 6 clamps are needed to fit all cast-iron and asbestos-cement pressure pipe in sizes 4" through 12". Extra range and safety factor make this clamp particularly suited for pipe sizes 10" and larger.

JCM 102 and 172 Extended Range/Multi-Band clamps are designed to accommodate the working characteristics of large diameter pipe. In the repair applications to large diameter pipe, there are several factors to be considered to maintain pipe integrity and return to 100% service capacity. Factors which are critical to the application include: size and type of pipe, severity of damage, working pressure or service requirements, location or repair and time factor. JCM 102 UCC design criteria accommodate these factors by providing the following strength features...

Heavy Duty Lug - provides the safety factor and solid platform to support the increased bolt torque levels required to compress the gasket and seal the damaged area.

Large Bolts - supply bolting power and high torque ability to fully compress the full circumferential gasket.

Thick Stainless Steel Band - increases pressure holding capability and provides even, consistent compression over the gasket area.

JCM 172 provides an easy to remove lug that accommodates cramped underground utility applications, rockbound soil conditions, restricted, narrow space piping galleries and limited excavation applications.

Problem:

**Damaged Large Diameter Pipe
with
Demanding Services/Working Pressure**

= Solution=

**JCM Extended Range
Universal Clamp Couplings
with
Heavy Duty Lug System
3/4" Bolt Assembly
Thicker Gauge Stainless Steel Band**



Image Reflects 12" Clamp Width

JCM Universal Clamp Couplings - Models 101, 102, 171, 172

Band: 18-8 Type 304 Certifiable Prime Stainless Steel

Lugs: Ductile Iron ASTM A-536, 60-40-18

Bolts: Corrosion resistant low alloy per ASTM A242, ANSI A21.11, AWWA C-111. National coarse rolled thread and heavy hex nut. Optional Stainless Steel 18-8 Type 304 or 316 available. Optional Epoxy Coated low alloy bolts/nuts available.

Gasket: Virgin Styrene-Butadiene Rubber (SBR) - Compounded for use with water, salt solutions, mild acids and bases. Per ASTM D-2000 M4AA 607. Standard temperature range from -40° to 150° F (-40° to 65° C) constant, maximum intermittent 180° F (82° C). For applications on high temperatures or chemical pipelines, contact JCM Industries Technical Services.

Coating: Corrosion resistant shop coat paint primer.

Pressure

Rating: Pressure holding capabilities vary according to application. For specific pressure ratings, contact JCM Industries Technical Services.

Meets ANSI/AWWA C230 Stainless-Steel Full-Encirclement Repair and Service Connection Clamps

JCM 102 Extended Range Universal Clamp Couplings

JCM 172 Removeable Lug Extended Range UCC

DOUBLE BAND CLAMPS

Nom. Pipe Size (IN.)	Clamp O.D. Range (IN.)	102 Attached Lug	172 Removeable Lug	Clamp Width - Approximate Weight						
				6"	7"	12"	15"	18"	24"	30"
				Lbs.#	Lbs.#	Lbs.#	Lbs.#	Lbs.#	Lbs.#	Lbs.#
4	4.44 - 5.24 4.74 - 5.57	0450 0480		•	•	•	•	•	•	•
				16#	20#	32#	40#	48#	64#	80#
6	6.62 - 7.42 6.84 - 7.64	0663 0690		•	•	•	•	•	•	•
				16#	20#	32#	40#	48#	64#	80#
8	8.62 - 9.42 8.99 - 9.79	0863 0905		•	•	•	•	•	•	•
				17#	21#	34#	43#	51#	68#	85#
10	10.72 - 11.72 11.04 - 12.24	1075 1110		-	-	•	-	•	•	•
						53#		80#	106#	132#
12	12.72 - 13.92 13.14 - 14.34 13.65 - 14.65	1275 1320 1365		-	-	•	-	•	•	•
						55#		80#	106#	132#
14	15.20 - 16.20	1530		-	-	•	-	•	•	•
						58#		87#	106#	145#
14 - 16	16.00 - 17.00 17.20 - 18.20	1600 1740		-	-	•	-	•	•	•
						59#		89#	108#	148#
16 - 18	18.40 - 19.40	1846		-	-	•	-	•	•	•
						62#		95#	124#	158#
18 - 20	19.40 - 20.40 20.40 - 21.40	1950 2050		-	-	•	-	•	•	•
						63#		95#	126#	158#
20 - 22	21.40 - 22.40 22.50 - 23.60	2160 2260		-	-	•	-	•	•	•
						67#		100#	134#	168#
Number of Bolts				4	4	8	8	12	16	20

MULTI-BAND CLAMPS

24	23.80 - 25.00 25.50 - 26.70 27.90 - 29.10	2400 2580 2800		-	-	•	-	•	•	•
						93#		140#	186#	233#
24 - 30	29.80 - 31.00 31.70 - 32.90	3000 3200		-	-	•	-	•	•	•
						98#		147#	196#	245#
36	37.85 - 39.20	3830		-	-	•	-	•	•	•
						117#		175#	234#	292#

HOW TO ORDER

- Determine O.D. of pipe.
- Select proper clamp O.D. range and band width.
- Determine Model Number.
- Specify clamp number. Model 102 or 172.
Example: To fit Cast Iron pipe, 6.90 O.D. with 6" width, order: 102-0690-6 or 172-0690-6

For tapped/threaded outlet clamps, see page 18.

Larger sizes and ranges available upon request, contact JCM Sales Team.

Clamps do not prevent lateral movement of pipe. Applications in which the pipe may move out of the clamp, proper anchorage of the pipe must be provided.



Certified to NSF/ANSI 61

JCM 131 All Stainless Steel Universal Clamp Coupling - Single Band

JCM All Stainless Universal Clamp Couplings work on the mechanical sealing principle providing a stronger, more structurally positive fastener system that is capable of obtaining maximum gasket compression. JCM All Stainless Steel Universal Clamp Couplings with “Turbo Torque” provide the means of making the clamp conform to the pipe and performing as never before. Advanced design features include:

Low Profile Cast Stainless Steel Lugs - with mutually supporting sliding fingers provide distortion free tightening over a wide range. Cast Stainless Steel Lugs offer corrosion resistance for hot and acidic environments.

Positive Attachment - of the stainless band to lugs eliminates band pull out and mechanical weakness at this critical point. Allow “Turbo Torque” capabilities to ensure permanent repairs on high pressure applications

Larger Bolts - for greater torque rating are provided on 10” clamps and larger the 3/4” bolts have bolt torque capability in excess of 100 ft. lbs allowing the JCM 131 to go beyond the “standard installation.”

JCM Series 130 Stainless Steel Universal Clamp Couplings Nominal sizes 1-1/2” - 8” have 5/8” bolts Nominal sizes 10” and larger 3/4” bolts

Balanced, low profile CF-8 Cast Stainless Steel Lugs with mutually supporting sliding fingers provide distortion free tightening over a wide range. Stainless Steel lugs offer corrosion resistance and the most efficient method of transfer of energy from the fastener attachment directly to compression of the gasket.

Corrosion resistant stainless steel band conforms to pipe irregularities, maintaining sealing pressure over the entire gasket area. Design criteria requires gauge thickness increase with clamp size. This is just one of the design points which enables JCM Universal Clamp Couplings to withstand the internal forces involved with large pipe repair.

Positive attachment of stainless band to lugs eliminates band pull out and mechanical weakness at this critical point. This structurally sound fabrication design element also allows the high torque capabilities to ensure permanent repair on high pressure applications.

Gridded gasket with long tapered ends and recessed bridge plate assures even gasket pressure throughout the range - without wrinkling or crimping. Diamond Gridded Gasket 1/4” Thick (JCM standard on nominal sizes 3” and larger) adapts to pitted or uneven pipe surfaces to completely seal damaged areas.

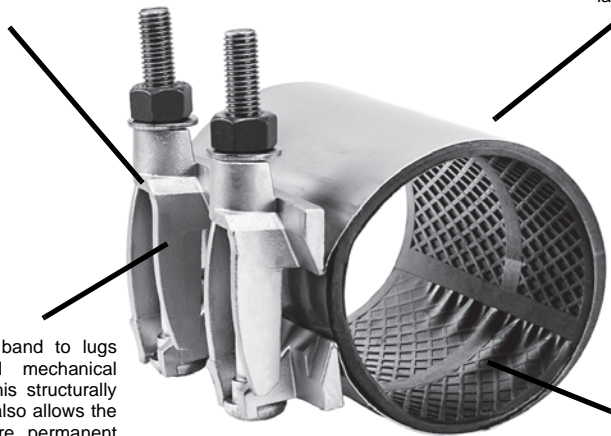

Image Reflects 6” Clamp Width

Meets ANSI/AWWA C230 Stainless-Steel Full-Encirclement Repair and Service Connection Clamps

JCM 131 All Stainless Steel Universal Clamp Couplings



JCM 131 All Stainless Steel Clamp Coupling with larger bolts and heavier lug - especially for piping systems that are exposed to hot soils or corrosive environments. JCM All Stainless Clamps provide the corrosion resistance of stainless to this means of repairing and connecting pipe.

Nom. Pipe Size (IN.)	Clamp O.D. Range (IN.)	131 Stainless Steel Universal Clamp Clamp Number	Clamp Width - Approximate Weight						
			6"	7"	12"	15"	18"	24"	30"
			Lbs.#	Lbs.#	Lbs.#	Lbs.#	Lbs.#	Lbs.#	Lbs.#
1-1/2	1.88 - 2.15	0190	•	-	•	-	-	-	-
			5#		10#				
2 - 2-1/2	2.35 - 2.63 2.70 - 3.13	0238 0275	•	•	•	•	-	-	-
			5#	6#	10#	12#			
3	3.46 - 3.70 3.73 - 4.13	0350 0400	•	•	•	•	-	-	-
			6#	7#	11#	13#			
4	4.45 - 4.75 4.74 - 5.14 4.95 - 5.35 5.22 - 5.62	0450 0480 0500 0525	•	•	•	•	•	•	•
			6#	7#	12#	14#	18#	24#	28#
6	5.95 - 6.35 6.56 - 6.96 6.85 - 7.25 7.05 - 7.45 7.45 - 7.85	0600 0663 0690 0710 0745	•	•	•	•	•	•	•
			7#	8#	13#	16#	21#	26#	31#
8	7.95 - 8.35 8.54 - 8.94 8.99 - 9.39 9.27 - 9.67 9.90 - 10.30	0800 0863 0905 0940 1000	•	•	•	•	•	•	•
			8#	9#	15#	19#	24#	30#	38#
8 - 10	10.60 - 11.00 11.04 - 11.44 11.34 - 11.74 11.75 - 12.15 12.00 - 12.40	1075 1110 1140 1175 1200	-	•	•	•	•	•	•
				15#	26#	31#	39#	42#	60#
12	12.60 - 13.02 13.10 - 13.50 13.40 - 13.80 13.70 - 14.10 14.00 - 14.40	1275 1320 1340 1370 1400	-	•	•	•	•	•	•
				17#	28#	34#	42#	56#	68#
Number of Bolts			2	2	4	4	6	8	10

HOW TO ORDER

- Determine O.D. of pipe.
- Select proper clamp O.D. range and band width.
- Determine Model Number.
- Specify clamp number.
Example: To fit Cast Iron pipe, 6.90 O.D. with 6" width, order: 131-0690-6

Clamps do not prevent lateral movement of pipe. Applications in which the pipe may move out of the clamp, proper anchorage of the pipe must be provided.

Available Options Upon Request Models 131-132

- Pipe sizes and ranges not listed
- Conductive Buttons
- Specialty Gaskets
- Tapped clamps, see page 18
- Other Sizes and Ranges



JCM 132 Extended Range All Stainless Universal Clamp Coupling - Double/Multi-Band

JCM 132 Extended Range All Stainless Steel Universal Clamp Couplings are designed especially for systems with both asbestos-cement and cast iron pipe, or with oversized pipe. This extended range, multi-band clamp provides a full circumferential seal and extra wide range. Only 6 clamps are needed to fit all cast-iron and asbestos-cement pressure pipe in sizes 4" through 12". Extra range and safety factor make this clamp particularly suited for pipe sizes 10" and larger. All stainless steel construction makes the 132 All Stainless Steel Clamps corrosion resistant and ideal for use in corrosive environments.

JCM 132 All Stainless Extended Range/Multi-Band clamps are designed to accommodate the working characteristics of large diameter pipe, especially in hot or acidic soils. In the repair applications to large diameter pipe, there are several factors to be considered to maintain pipe integrity and return to 100% service capacity. Factors which are critical to the application include: size and type of pipe, severity of damage, working pressure or service requirements, location or repair and time factor. JCM 132 All Stainless UCC Design criteria accommodate these factors by providing the following strength features...

Heavy Duty Lug - and positive fastener attachment provides the safety factor and solid platform to support the increased bolt torque levels required to compress the gasket and seal the damaged area.

Large Bolts - supply bolting power and high torque ability to fully contract the full circumferential gasket.

Thick Stainless Steel Band - increases pressure holding capability and provides even, consistent compression over the gasket area.

JCM Series 130 Stainless Steel Universal Clamp Couplings Nominal sizes 1-1/2" - 8" have 5/8" bolts Nominal sizes 10" and larger 3/4" bolts



Image Reflects 12" Clamp Width

MATERIAL SPECIFICATIONS - JCM 131, 132, 133, 134 ALL STAINLESS UNIVERSAL CLAMP COUPLINGS

- Band:** 18-8 Type 304 Stainless Steel. Optional 316 material available.
- Lugs:** CF-8 Cast Stainless Steel (equivalent to 304 Stainless Steel). Optional 316 material available.
- Bolts:** 18-8 Type 304 Stainless Steel. Optional 316 material available.
- Gasket:** Virgin Styrene-Butadiene Rubber (SBR) - Compounded for use with water, salt solutions, mild acids and bases. Per ASTM D-2000 M4AA 607. Standard temperature range from -40° to 150°F (-40° to 65° C) constant, maximum intermittent 180° F (82° C). For applications on high temperatures or chemical pipelines, contact JCM Industries Technical Services. Meets ANSI/AWWA C230 Stainless-Steel Full-Encirclement Repair and Service Connection Clamps.

JCM 132 All Stainless Steel Extended Range Universal Clamp Couplings

DOUBLE BAND CLAMPS

Nom. Pipe Size (IN.)	Clamp O.D. Range (IN.)	132 Stainless Steel Extended Range	Clamp Width - Approximate Weight						
			6"	7"	12"	15"	18"	24"	30"
			Lbs.#	Lbs.#	Lbs.#	Lbs.#	Lbs.#	Lbs.#	Lbs.#
4	4.44 - 5.24 4.74 - 5.57	0450 0480	•	•	•	•	•	•	•
			9#	11#	16#	20#	25#	32#	44#
6	6.62 - 7.42 6.84 - 7.64	0663 0690	•	•	•	•	•	•	•
			10#	12#	19#	26#	30#	38#	55#
8	8.62 - 9.42 8.99 - 9.79	0863 0905	•	•	•	•	•	•	•
			11#	13#	20#	29#	33#	40#	55#
10	10.72 - 11.72 11.04 - 12.24	1075 1110	-	-	•	-	•	•	•
					32#		48#	64#	80#
12	12.72 - 13.92 13.14 - 14.34 13.65 - 14.65	1275 1320 1365	-	-	•	-	•	•	•
					34#		51#	68#	85#
14	15.20 - 16.20	1530	-	-	•	-	•	•	•
					36#		54#	72#	89#
14 - 16	16.00 - 17.00 17.20 - 18.20	1600 1740	-	-	•	-	•	•	•
					37#		56#	74#	92#
16 - 18	18.40 - 19.40	1846	-	-	•	-	•	•	•
					39#		59#	78#	97#
18 - 20	19.40 - 20.40 20.40 - 21.40	1950 2050	-	-	•	-	•	•	•
					41#		62#	82#	103#
20 - 22	21.40 - 22.40 22.50 - 23.60	2160 2260	-	-	•	-	•	•	•
					45#		67#	90#	111#
Number of Bolts			4	4	8	8	12	16	20

MULTI-BAND CLAMPS

24	23.80 - 25.00 25.50 - 26.70 27.90 - 29.10	2400 2580 2800	-	-	•	-	•	•	•
					59#		88#	108#	146#
24 - 30	29.80 - 31.00 31.70 - 32.90	3000 3200	-	-	•	-	•	•	•
					64#		95#	128#	158#
36	37.85 - 39.20	3830	-	-	•	-	•	•	•
					82#		123#	164#	205#

HOW TO ORDER

1. Determine O.D. of pipe.
2. Select proper clamp O.D. range and band width.
3. Determine Model Number.
4. Specify clamp number. Model 102 or 172.

Example: To fit Cast Iron pipe, 6.90 O.D. with 6" width, order: 132-0690-6

For tapped/threaded outlet clamps, see page 18.

Larger sizes and ranges available upon request, contact JCM Sales Team.

Clamps do not prevent lateral movement of pipe. Applications in which the pipe may move out of the clamp, proper anchorage of the pipe must be provided.



JCM 161 Fabricated Lug All Stainless Steel Clamps

The new JCM 161 Fabricated Lug All Stainless Steel Clamp offers an economical solution to problems such as breaks, splits, cracks, holes in all types of pipe. Available in standard sizes for cast iron, ductile iron, IPS PVC, C-900/905 PVC, steel, asbestos cement, polyethylene. The 161 is a stainless steel clamp that offers all the benefits of stainless: corrosion resistance, lightweight, flexible yet

strong. The JCM 161 is especially recommended for hot soil conditions and corrosive environments.

The full circumferential gasket provides a complete repair while the molded in stainless steel bridge plate provides the full stainless steel barrier to aggressive elements.

MATERIAL SPECIFICATIONS - JCM 161, 162, 163, 168 FABRICATED LUG ALL STAINLESS STEEL CLAMP COUPLINGS

Bolting Assembly:	18-8 Type 304 Stainless Steel
Band:	18-8 Type 304 Stainless Steel
Bolts And Nuts:	18-8 Type 304 Stainless Steel
Gasket:	Virgin Styrene-Butadiene Rubber (SBR) - Compounded for use with water, salt solutions, mild acids and bases. Per ASTM D-2000 M4AA 607. Temperature range from -40° to 150°F (-40° to 65°C) constant, maximum intermittent 180°F (82°C). For applications on high temperatures or chemical pipelines, contact JCM Industries Technical Services. Meets ANSI/AWWA C230 Stainless-Steel Full-Encirclement Repair and Service Connection Clamps.

Strong Stainless Steel Studs - permanently attached to eliminate loose parts and nuts are treated to speed installation and prevent seizing.

Thick Gridded Gasket - long tapered ends and recessed bridge plate assure even gasket pressure throughout range - without wrinkling or crimping. Compounded for use with water, salt solutions, mild acids and bases.

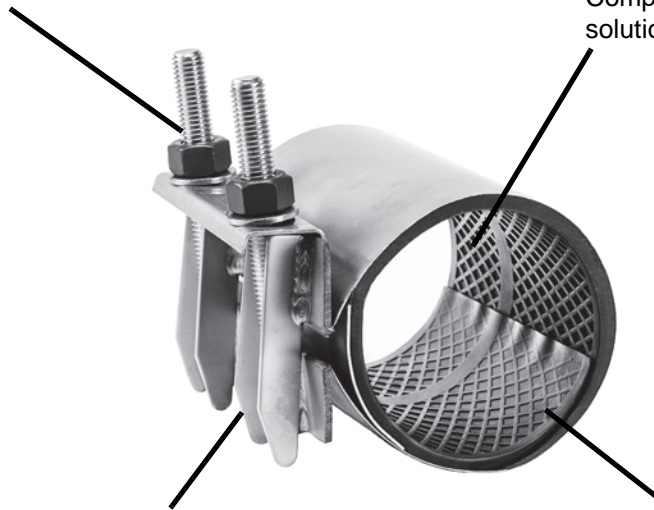

Image Reflects 7" Clamp Width

Positive Attachment of Band to Lugs - strong TIG welds eliminate mechanical weaknesses and prevents band separation. Thick stainless lifter bar plate prevents distortion or warping during tightening.

Type 304 Stainless Steel Band - conforms to pipe irregularities, maintaining sealing pressure over the entire gasket.



JCM 161 Fabricated Lug Stainless Steel Universal Clamps

The JCM 161 Fabricated Lug All Stainless Steel Clamp offers an economical solution to problems such as breaks, splits, cracks, holes in all types of pipe. Available in standard sizes, the 161 is a stainless steel clamp that offers all the benefits of stainless: corrosion resistance, lightweight, flexible yet strong.



Image Reflects 7" Clamp Width

Nom. Pipe Size (IN.)	Clamp O.D. Range (IN.)	161 Stainless Steel Universal Clamp Clamp Number	Clamp Width - Approximate Weight					
			7"	12"	15"	18"	24"	30"
			Lbs.#	Lbs.#	Lbs.#	Lbs.#	Lbs.#	Lbs.#
2 - 2-1/2	2.35 - 2.63 2.70 - 3.13	0238 0275	•	•	•	-	-	-
			5#	8#	10#			
3	3.46 - 3.70 3.73 - 4.13	0350 0400	•	•	•	-	-	-
			6#	9#	11#			
4	4.45 - 4.75 4.74 - 5.14 4.95 - 5.35 5.22 - 5.62	0450 0480 0500 0525	•	•	•	•	•	•
			7#	10#	12#	17#	20#	24#
6	5.95 - 6.35 6.56 - 6.96 6.85 - 7.25 7.05 - 7.45 7.45 - 7.85	0600 0663 0690 0710 0745	•	•	•	•	•	•
			9#	13#	17#	20#	26#	34#
8	7.95 - 8.35 8.54 - 8.94 8.99 - 9.39 9.27 - 9.67 9.90 - 10.30	0800 0863 0905 0940 1000	•	•	•	•	•	•
			11#	16#	21#	25#	32#	44#
10	10.60 - 11.00 11.04 - 11.44 11.34 - 11.74 11.75 - 12.15 12.00 - 12.40	1075 1110 1140 1175 1200	•	•	•	•	•	•
			15#	18#	24#	30#	36#	50#
12	12.60 - 13.02 13.10 - 13.50 13.40 - 13.80 13.70 - 14.10 14.00 - 14.40	1275 1320 1340 1370 1400	•	•	•	•	•	•
			17#	20#	27#	34#	40#	56#
Number of Bolts			2	3	4	4	6	8

HOW TO ORDER

- Determine O.D. of pipe.
 - Select proper clamp O.D. range and band width.
 - Determine Model Number.
 - Specify clamp number.
Example: To fit Cast Iron pipe, 6.90 O.D. with 6" width, order: 161-0690-6
- Clamp width should be equal to or greater than the pipe diameter for higher working pressures.
 - Not recommended for use for joining plain end pressure pipe.
 - Other ranges and widths available upon request.
 - Clamps do not prevent lateral movement of pipe. Applications in which the pipe may move out of the clamp, proper anchorage of the pipe must be provided.

Available Options Upon Request

Models 161-162

- Pipe sizes and ranges not listed
- Conductive Buttons
- Specialty Gaskets
- Tapped clamps, see page 18
- Other Sizes and Ranges



JCM 162 Fabricated Lug All Stainless Steel Extended Range Clamps

JCM 162 All Stainless Steel Extended Range Clamps - for piping systems that are exposed to hot soils or corrosive environments. Provides extra corrosion resistance of stainless steel to this means of repair and connecting pipe.

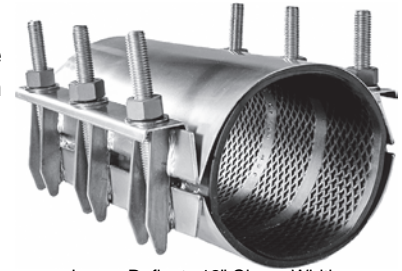

Image Reflects 12" Clamp Width

DOUBLE BAND CLAMPS

Nom. Pipe Size (IN.)	Clamp O.D. Range (IN.)	162 Stainless Steel Extended Range Clamp Number	Clamp Width - Approximate Weight					
			7"	12"	15"	18"	24"	30"
			Lbs.#	Lbs.#	Lbs.#	Lbs.#	Lbs.#	Lbs.#
4	4.44 - 5.24 4.74 - 5.57	0450 0480	•	•	•	•	•	•
			9#	13#	16#	25#	27#	34#
6	6.62 - 7.42 6.84 - 7.64	0663 0690	•	•	•	•	•	•
			11#	14#	19#	28#	30#	40#
8	8.62 - 9.42 8.99 - 9.79	0863 0905	•	•	•	•	•	•
			13#	19#	23#	36#	41#	45#
10	10.72 - 11.72 11.04 - 12.24	1075 1110	-	•	•	•	•	•
				28#	32#	43#	56#	64#
12	12.72 - 13.92 13.14 - 14.34 13.65 - 14.65	1275 1320 1365	-	•	•	•	•	•
				30#	40#	52#	60#	80#
14	15.20 - 16.20	1530	-	•	•	•	•	•
				34#	43#	55#	79#	86#
14 - 16	16.00 - 17.00 17.20 - 18.20	1600 1740	-	•	•	•	•	•
				36#	46#	59#	87#	92#
16 - 18	18.40 - 19.40	1846	-	•	•	•	•	•
				38#	49#	61#	90#	96#
18 - 20	19.40 - 20.40 20.40 - 21.40	1950 2050	-	•	•	•	•	•
				43#	52#	63#	94#	101#
20 - 22	21.40 - 22.40 22.50 - 23.60	2160 2260	-	•	•	•	•	•
				47#	59#	67#	99#	106#
Number of Bolts			4	6	8	8	12	16

HOW TO ORDER

- Determine O.D. of pipe.
 - Select proper clamp O.D. range and band width.
 - Determine Model Number.
 - Specify clamp number.
Example: To fit Cast Iron pipe, 6.90 O.D. with 6" width, order: 162-0690-6
- Clamp width should be equal to or greater than the pipe diameter for higher working pressures.
 - Not recommended for use for joining plain end pressure pipe.
 - Other ranges and widths available upon request.
 - Clamps do not prevent lateral movement of pipe. Applications in which the pipe may move out of the clamp, proper anchorage of the pipe must be provided.



JCM 168 Fabricated Lug Lightweight Stainless Steel Clamps

The JCM 168 Fabricated Lug All Stainless Steel Lightweight Clamp offers an economical solution for applications on low pressure systems. Typical applications include joining plain end pipe in sliplining applications, gravity and low pressure pipelines. For pressure applications, see JCM 161 Fabricated Lug Stainless Steel Clamp.



Image Reflects 7" Clamp Width

Nom. Pipe Size (IN.)	Clamp O.D. Range (IN.)	168 Stainless Steel Universal Clamp Clamp Number	Clamp Width - Approximate Weight					
			7"	12"	15"	18"	24"	30"
			Lbs.#	Lbs.#	Lbs.#	Lbs.#	Lbs.#	Lbs.#
4	4.00 - 4.40 4.45 - 4.75 4.74 - 5.14	0420 0450 0480	•	•	•	•	•	•
			7#	10#	12#	17#	20#	24#
6	6.00 - 6.40 6.56 - 6.96 6.85 - 7.25	0630 0663 0690	•	•	•	•	•	•
			9#	13#	17#	20#	26#	34#
8	8.20 - 8.60 8.54 - 8.94 8.99 - 9.39	0840 0863 0905	•	•	•	•	•	•
			11#	16#	21#	25#	32#	44#
10	10.30 - 10.70 10.60 - 11.00 11.04 - 11.44	1050 1075 1110	•	•	•	•	•	•
			15#	18#	24#	30#	36#	50#
12	12.30 - 12.70 12.60 - 13.02 13.10 - 13.50	1250 1275 1320	•	•	•	•	•	•
			17#	20#	27#	34#	40#	56#
Number of Bolts			2	3	4	4	6	8

Conductive Buttons for electrical thawing available for all models upon request.

HOW TO ORDER

- Determine O.D. of pipe.
 - Select proper clamp O.D. range and band width.
 - Determine Model Number.
 - Specify clamp number.
Example: To fit Cast Iron pipe, 6.90 O.D. with 6" width, order: 168-0690-6
- Not recommended for use for joining plain end pressure pipe.
 - Other ranges and widths available upon request.
 - Clamps do not prevent lateral movement of pipe. Applications in which the pipe may move out of the clamp, proper anchorage of the pipe must be provided.

Available in double band, JCM Model 169. Contact JCM Inside Sales Team.



JCM Tapped Outlet Repair Clamps - 103, 104, 173, 174, 133, 134, 123, 153, 163, 164

Models of JCM Universal Clamp Couplings are available with tapped outlets for repair of direct tap pull outs and broken or split pipe requiring a service outlet.

HOW TO ORDER

<ol style="list-style-type: none"> 1. Select standard model, size and width clamp to fit pipe. 2. Change model number to corresponding Tapped Outlet Clamp Model Number. 	<ol style="list-style-type: none"> 3. Select size and type of tapped outlet from outlet guide below. Note minimum widths and range/sizes. 4. Add Outlet Tap Code to clamp number. Add-On outlet price to standard clamp list price. 	<p>Ordering Example:</p> <p>For standard clamp to fit 6" Cast Iron Pipe with 12" width, with 2" IP outlet, order:</p> <p style="text-align: right;">103-0690-12 x 14IP</p>
--------------------------------------------------------------------------------------------------------------------------------------------------------------------------------------------------	-------------------------------------------------------------------------------------------------------------------------------------------------------------------------------------------------------------------------------------------------------------	-----------------------------------------------------------------------------------------------------------------------------------------------------------------------------------

Standard Clamp Model	Becomes	Tapped Outlet Clamp Model
101 Universal Clamp Coupling - Standard Range		103 Tapped Universal Clamp Coupling - Standard Range
102 Universal Clamp Coupling - Extended Range		104 Tapped Universal Clamp Coupling - Extended Range
131 All Stainless Steel UCC - Std Range		133 Tapped All Stainless Steel UCC - Std Range
132 All Stainless Steel UCC - Extd Range		134 Tapped All Stainless Steel UCC - Extd Range
121 Gas Repair Clamp		123 Tapped Gas Service Clamp
151 Gas Repair Clamp		153 Tapped All Stainless Steel Gas Service Clamp
161 All Stainless Steel Fabricated Lug Clamp		163 All Stainless Steel Tapped Fabricated Lug Clamp
162 All Stainless Steel Fabricated Lug Clamp - Ext Range		164 All Stainless Steel Tapped Fabricated Lug Clamp - Ext Range
171 UCC - Standard Range - Removeable Lug		173 Tapped UCC - Standard Range - Removeable Lug
172 UCC - Extended Range - Removeable Lug		174 Tapped UCC - Standard Range - Removeable Lug

CLAMP RANGE/SIZE (IN.)	MINIMUM CLAMP LENGTH (IN.)	TYPE OF THREAD	TAP SIZE	ADD OUTLET TAP CODE	
				IP ORDER TAP CODE	CC ORDER TAP CODE
2.38 - 4.80	6	IP or CC	3/4"	06	07
			1"	08	09
2.38 - 14.00	7-1/2	IP or CC	3/4"	06	07
			1"	08	09
4.50 - 14.00	12	IP or CC	1-1/4"	10	11
4.50 - 14.00	12	IP or CC	1-1/2"	12	13
4.50 - 14.00	12	IP	2"	14	-
4.50 - 14.00	12	CC	2"	-	15

JCM
103
123
173



JCM
133
153



JCM
163



Images Reflect 7" Clamp Width



JCM 105 Collar Leak Clamps

JCM 135 All Stainless Steel Collar Leak Clamps

For Quick, Permanent repairs of solvent weld PVC pipe joints.

JCM 105/135 Collar Leak Clamps provide a simple, quick solution to troublesome leaks in PVC solvent weld pipe systems - without having to cut out fittings or modifying your system. These heavy duty clamps have many features which assure a successful repair, even under the most adverse conditions.



HOW TO ORDER

1. Determine O.D. of pipe.	3. Specify clamp number. For all stainless clamp, change model number to 135.	EXAMPLE: For 3" Class 160 PVC pipe, order: 105-0350-6. For All Stainless Clamp, order: 135-0350-6.
2. Select proper clamp O.D. range and band width.		

NOM. PIPE SIZE (IN.)	PIPE O.D. SIZE (IN.)	TYPE OF SOLVENT WELD PIPE JOINT	Clamp Width*	CLAMP NUMBER	APPR WT. EACH (LBS.)	ALL STAINLESS CLAMP NUMBER	APPR WT. EACH (LBS.)
2	2.38	BELL END CLASS 160, 200 SCH 40 COUPLING AND BELL END	6	105-0238-6	7.3	135-0238-6	5.3
			7	105-0238-7	9.3	135-0238-7	6
2-1/2	2.88	BELL END CLASS 160, 200 SCH 40 COUPLING AND BELL END	6	105-0288-6	7.7	135-0288-6	5.7
			7	105-0288-7	9.9	135-0288-7	6
3	3.50	BELL END CLASS 160, 200 SCH 40 COUPLING AND BELL END	6	105-0350-6	8.0	135-0350-6	6
			7	105-0350-7	10	135-0350-7	7
4	4.50	BELL END CLASS 160, 200 SCH 40 COUPLING AND BELL END	6	105-0450-6	9.1	135-0450-6	6
			7	105-0450-7	11	135-0450-7	7
5	5.56	BELL END CLASS 160, 200 SCH 40 COUPLING AND BELL END	6	105-0556-6	9.4	135-0556-6	6.5
			7	105-0556-7	11	135-0556-7	7
6	6.63	BELL END CLASS 160, 200 SCH 40 COUPLING AND BELLEND	6	105-0663-6	10	135-0663-6	7.5
			7	105-0663-7	12	135-0663-7	8.5
8	8.63	BELL END CLASS 160, 200 SCH 40 COUPLING AND BELL END	6	105-0863-6	11	135-0863-6	8.7
			7	105-0863-7	13	135-0863-7	9.5

*OTHER WIDTHS AVAILABLE UPON REQUEST

105 COLLAR LEAK CLAMP FOR PLASTIC IRRIGATION PIPE

NOM. PIPE SIZE (IN.)	PIPE O.D. SIZE (IN.)	CLAMP WIDTH (IN.)*	FOR PIPE WALL THICKNESS	CLAMP NUMBER	APPR. WT. EA. (LBS.)
4	4.125	6	.125	105-0413-6	9.1
6	6.140	6	.150	105-0614-6	9.8
8	8.160	6	.199	105-0816-6	10.7
10	10.200	6	.249	105-1020-6	14.1
12	12.240	6	.290	105-1224-6	14.9
15	15.300	6	.375	105-1530-6	18.0

*OTHER WIDTHS AVAILABLE UPON REQUEST



JCM 106 Bell Joint Leak Clamp

For quick repair or water tight joint assurance for rubber joint PVC pipe, solvent weld pipe or coupled pipe specify JCM 106 Bell Joint Leak Clamps. These clamps are engineered to provide a simple, dependable repair or assured joint. In addition, the JCM 106 eliminates possible notching of PVC pipe and offers maximum versatility and corrosion resistance.

For Repair of:

- PVC Rubber Joint Bells - Std. Steel Sizes (SDR 26, SDR 21)
- PVC Solvent Weld Joints and Couplings
- Std. Steel Threaded Couplings.



106 Bell Joint Leak Clamp

NOM. PIPE SIZE (IN.)	PIPE O.D. (IN.)	MAXIMUM BELL O.D. (IN.)	MAXIMUM LIP O.D. (IN.)	OVERALL LENGTH*	MAX. STD. CPLG. LENGTH	CATALOG NUMBER	APPR. WT. EACH (LBS.)
4	4.50	6.13	5.43	11-1/2	7	106-0450	12
6	6.63	8.25	7.56	11-1/2	7	106-0663	17
8	8.63	10.88	9.56	11-1/2	7	106-0863	21

*Dimension will change with use of studs.

JCM 143 Bell Joint Leak Clamps

Pipe Sizes 4" - 12" Cast Iron Pipe, Ductile Iron Pipe, C-900 PVC

Strong - Split, interlocking rings provide maximum gasket compression. Heavy duty ductile iron components for the life of the pipeline.

Eliminates Extra Parts and Time Loss - Comes complete to repair cast iron, ductile iron and C-900 PVC in its nominal size without any special order bolts, gaskets or other parts. Simple transfer from shelf to job site to pipe joint without confusion.

Simple, Fast Installation - Split, interlocking rings and pre-cut gasket eliminates field cutting.

Install Under Pressure - Repair leaking joint or install as a leak preventative on older pipe joints that have been excavated or disturbed during other pipeline maintenance (a low-cost, long-term insurance policy).

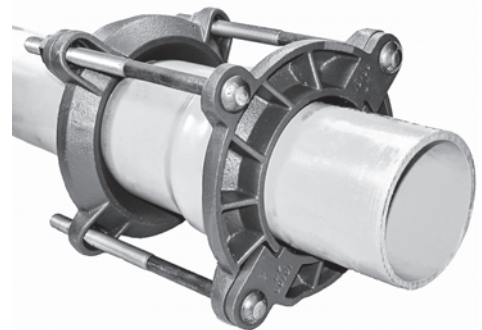

JCM 143 - 4" - 12"

Pipe Sizes 14" and Larger for Ductile Iron/Cast Iron Pipe

Fabricated Bell Joint Leak Clamps with split, bolt-on design provides a positive seal for large diameter Ductile Iron and Cast Iron leaking bells.

143 Bell Joint Leak Clamp - 4" - 36"

NOMINAL PIPE SIZE (IN.)	Clamp O.D. Range	CATALOG NUMBER	APPR. WT. EACH (LBS.)
4	4.80 - 5.00	143-0480	18
6	6.90 - 7.10	143-0690	27
8	9.05 - 9.30	143-0905	33
10	11.10 - 11.40	143-1110	43
12	13.20 - 13.50	143-1320	48
14	15.30	143-1530	125
16	17.40	143-1740	150
18	19.50	143-1950	175
20	21.60	143-2160	200
24	25.80	143-2580	325
30	32.00	143-3200	400
36	38.30	143-3830	600

JCM 143 Bell Joint Leak Clamp 14" and Larger - fabricated steel. Standard Ductile Iron sizes listed. Optional oversize or undersized Cast Iron pipe O.D.s available. Large sizes available. Contact JCM Sales Team.

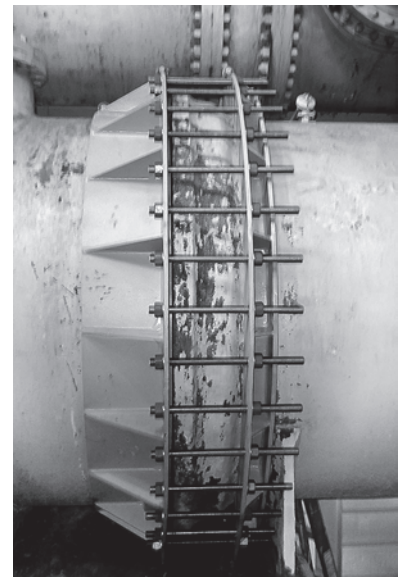

JCM 143 - 14" - 36"

JCM 110 Patch Clamps



HOW TO ORDER

1. Determine clamp size, material options and width required.
2. Order by clamp number.

For **Stainless Steel Bolt(s)** add **(SS)** to clamp number.

For **ALL Stainless Steel Clamp** add **(AS)** to clamp number.

Example: All Stainless Steel Clamp for 4" IPS PVC with 4.50 O.D. 3" with, order 110-0450-3AS.

NOMINAL PIPE SIZE (IN.)	PIPE O.D. (IN.)	CLAMP NUMBER E-GALV. BOLT	WIDTH (IN.)	SS BOLT Add (SS)	ALL STAINLESS Add (AS)	WT. EA. LBS.	CTN. QTY.
1/2	.84	110-0084	3	SS	AS	.6	20
			6	SS	AS	1.2	10
3/4	1.05	110-0105	3	SS	AS	.6	16
			6	SS	AS	1.2	8
1	1.32	110-0132	3	SS	AS	.6	16
			6	SS	AS	1.4	8
1-1/4	1.66	110-0166	3	SS	AS	.7	12
			6	SS	AS	1.4	6
1-1/2	1.90	110-0190	3	SS	AS	1.1	12
			6	SS	AS	2.2	6
2	2.38	110-0238	3	SS	AS	1.1	8
			6	SS	AS	2.3	4
			9	SS	AS	3.4	2
			12	SS	AS	4.5	2
2-1/2	2.88	110-0288	3	SS	AS	1.2	8
			6	SS	AS	2.4	4
			9	SS	AS	3.6	2
			12	SS	AS	4.8	2
3	3.50	110-0350	3	SS	AS	1.6	8
			6	SS	AS	3.2	4
			9	SS	AS	4.8	2
			12	SS	AS	6.4	2
4	4.50	110-0450	3	SS	AS	1.6	8
			6	SS	AS	3.2	4
			9	SS	AS	4.8	2
			12	SS	AS	6.4	2
5	5.56	110-0556	3	SS	AS	1.7	8
			6	SS	AS	3.4	4
			9	SS	AS	5.1	-
			12	SS	AS	6.8	-
6	6.63	110-0663	3	SS	AS	1.9	8
			6	SS	AS	3.8	4
			9	SS	AS	5.7	-
			12	SS	AS	7.6	-
8	8.63	110-0863	3	SS	AS	2.2	8
			6	SS	AS	4.4	4
			9	SS	AS	6.6	-
			12	SS	AS	8.8	-
DOUBLE BAND CLAMPS FOR STEEL PIPE SIZES							
10	10.75	110-1075	3	SS	AS	3.4	-
			6	SS	AS	6.8	-
			9	SS	AS	10.2	-
			12	SS	AS	13.6	-
12	12.75	110-1275	3	SS	AS	3.7	-
			6	SS	AS	7.4	-
			9	SS	AS	13.1	-
			12	SS	AS	14.8	-
COPPER TUBE SIZES							
1/2	.63	110-0063	3	SS	AS	.6	20
			6	SS	AS	1.2	10
3/4	.88	110-0084	3	SS	AS	.6	20
			6	SS	AS	1.2	10
1	1.13	110-0105	3	SS	AS	.6	16
			6	SS	AS	1.2	8
1-1/4	1.38	110-0132	3	SS	AS	.6	16
			6	SS	AS	1.4	8
1-1/2	1.63	110-0166	3	SS	AS	.7	12
			6	SS	AS	1.4	6
2	2.13	110-0213	3	SS	AS	1.1	8
			6	SS	AS	2.3	4



JCM 111 Full-Repair Clamps

JCM 111 Full-Repair clamps are a fast economical means of permanently repairing steel pipe with extensive corrosion, splits, punctures or pin holes. These clamps have a heavy, full circumferential Buna-N gasket with a hardened recessed armor. This provides extra sealing capability for heavily damaged pipe and pipe with reduced diameter due to corrosion. Available in all stainless steel.

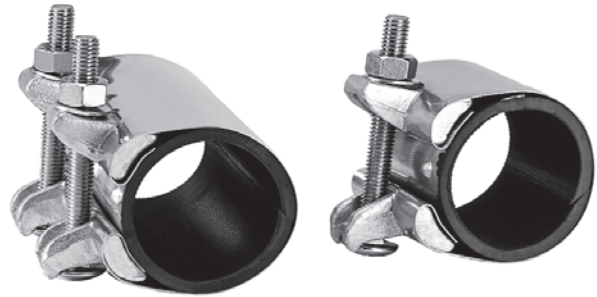

JCM 111 FULL- REPAIR CLAMPS Steel Pipe Sizes - IPS

Copper Tube Sizes - CTS

NOMINAL PIPE SIZE (IN.)	PIPE O. D. (IN.)	TYPE OF PIPE	WIDTH (IN.)	CLAMP NUMBER E-GALV. BOLT	STAINLESS BOLT Add (SS)	ALL STAINLESS Add (AS)	WT. EA. (LBS.)	CTN. QTY.
1/2"	0.84	IPS	3	111-0084-3	SS	AS	.7	20
			6	111-0084-6	SS	AS	1.4	10
3/4"	1.05	IPS	3	111-0105-3	SS	AS	.7	16
			6	111-0105-6	SS	AS	1.4	8
	0.88	CTS	3	111-0088-3	SS	AS	.7	16
			6	111-0088-6	SS	AS	1.4	8
1"	1.32	IPS	3	111-0132-3	SS	AS	.8	16
			6	111-0132-6	SS	AS	1.5	8
	1.13	CTS	3	111-0113-3	SS	AS	.8	16
			6	111-0113-6	SS	AS	1.5	8
1-1/4"	1.66	IPS	3	111-0166-3	SS	AS	.9	12
			6	111-0166-6	SS	AS	1.8	6
1-1/2"	1.63	CTS	3	111-0166-3	SS	AS	.9	12
			6	111-0166-6	SS	AS	1.8	6
	1.90	IPS	3	111-0190-3	SS	AS	1.3	12
			6	111-0190-6	SS	AS	2.6	6
2"	2.38	IPS	3	111-0238-3	SS	AS	1.3	8
			6	111-0238-6	SS	AS	2.7	4

HOW TO ORDER

- Determine clamp size, material options and width required.
- Order by clamp number.
For **Stainless Steel Bolt(s)** add **(SS)** to clamp number.
For **ALL Stainless Steel Clamp** add **(AS)** to clamp number.
Example: All Stainless Steel Clamp for 2" IPS PVC with 2.38 O.D. 3" with, order 111-0238-3AS

Material Specifications JCM 110 PATCH CLAMPS and JCM 111 FULL-REPAIR CLAMPS

JCM 110 PATCH CLAMP

Lug: Ductile Iron ASTM A-536. Optional CF8 Stainless Steel, equal to 304.

Gasket: Rubber gasket suitable for gas.

Band: 18-8 Type 304 Stainless Steel

Hardware: Electro-galvanized Steel.
Optional Stainless Steel available.

JCM 111 FULL-REPAIR CLAMP

Lug: Ductile Iron ASTM A-536. Optional CF8 Stainless Steel, equal to 304.

Gasket: Buna-N

Band: 18-8 Type 304 Stainless Steel

Hardware: Electro-galvanized Steel.
Optional Stainless Steel available.



JCM 112 Heavy Duty Patch Clamps

JCM 113 Multi-band Patch Clamps

Heavy Duty Patch Clamps provide fast, permanent repair of pin holes, punctures or splits in steel and other types of pipe where a beam break is not involved. The clamps are readily available for all sizes of pipe 1-1/2" and larger.

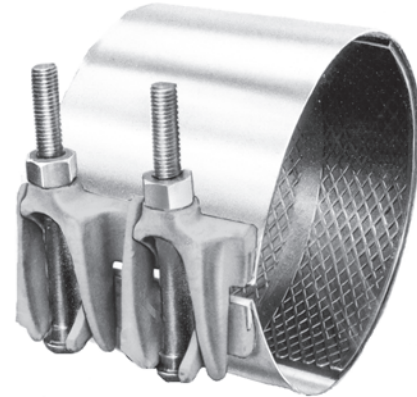

MATERIAL SPECIFICATIONS:

Lug: Ductile Iron ASTM A536

Band: 18-8 Type 304 Stainless Steel

Gasket: Gridded gasket is compounded for use with water, salt solutions, mild acids and bases. Optional Buna-N gasket available.

Bolts/nuts: Corrosion resistant, high strength low alloy (AWWA C-111, ANSI A21.11). Optional Stainless Steel, 18-8 Type 304 available.

HOW TO ORDER

1. Determine pipe size.
2. Select proper clamp and width.

3. Specify clamp number.

EXAMPLE: For 8" steel pipe with 6" width, order: 112-0863-6

112 HEAVY DUTY PATCH CLAMP

NOM. PIPE SIZE (IN.)	CLAMP O.D. RANGE (IN.)	CLAMP NUMBER	WIDTH (IN.)	WT. EA. LB.
1-1/2	1.90 - 2.00	112-0190- 6	6	6
		112-0190-12	12	12
2	2.38 - 2.50	112-0238- 6	6	6
		112-0238-12	12	12
2-1/2	2.88 - 3.00	112-0288- 6	6	6
		112-0288-12	12	12
3	3.50 - 3.88	112-0350- 6	6	6
		112-0350-12	12	13
3-1/2	4.00 - 4.35	112-0400- 6	6	7
		112-0400-12	12	14
4	4.50 - 4.85	112-0450- 6	6	8
		112-0450-12	12	15
5	5.56 - 6.00	112-0556- 6	6	8
		112-0556-12	12	15
6	6.63 - 6.90	112-0663- 6	6	8
		112-0663-12	12	16
8	8.63 - 9.05	112-0863- 6	6	8
		112-0863-12	12	17
10	10.00 - 10.30	112-1000- 6	6	9
		112-1000-12	12	18
10	10.75 - 11.10	112-1075- 6	6	9
		112-1075-12	12	18
12	12.00 - 12.30	112-1200- 6	6	9
		112-1200-12	12	18
12	12.75 - 13.05	112-1275- 6	6	10
		112-1275-12	12	20

113 MULTI-BAND PATCH CLAMP







NOM. PIPE SIZE (IN.)	CLAMP O.D. RANGE (IN.)	CLAMP NUMBER	WIDTH (IN.)	WT. EA. LB.
10	10.00 - 10.75	113-1000- 6	6	17
		113-1000-12	12	34
12	12.00 - 12.75	113-1200- 6	6	19.
		113-1200-12	12	38
14	14.00 - 14.75	113-1400- 6	6	20
		113-1400-12	12	40
16	16.00 - 16.75	113-1600- 6	6	23
		113-1600-12	12	46
18	18.00 - 18.75	113-1800- 6	6	24
		113-1800-12	12	49
20	20.00 - 20.75	113-2000- 6	6	26
		113-2000-12	12	52
22	22.00 - 22.75	113-2200- 6	6	27
		113-2200-12	12	54
24	24.00 - 24.75	113-2400- 6	6	28
		113-2400-12	12	56
30	30.00 - 30.75	113-3000- 6	6	29
		113-3000-12	12	58
36	36.00 - 36.75	113-3600- 6	6	31
		113-3600-12	12	62

LARGER OR OTHER SIZES AVAILABLE UPON REQUEST.





FOR COMPLETE BREAKS USE JCM UNIVERSAL CLAMP COUPLINGS MODELS 101, 102



JCM Selection Guide to Couplings

PRODUCT	NUMBER & TYPE	APPLICATION, SIZES AND INFORMATION
	201 Steel Couplings	Steel couplings for joining steel, galvanized, PVC and other pipe with standard steel dimensions 1/2" - 24". Available for cast iron and other pipe in sizes 14" and larger.
	202 Long Sleeve Steel Coupling	Provides longer length for longer space between pipe ends. Especially good for repairing PVC pipe. Sizes 2" - 12" Larger sizes on request.
	203 Steel Transition Coupling	For connection of oversize to standard size pipe within the same nominal pipe size. Special ranges available.
	204 Steel Reducing Coupling	For connection of any combination of two sizes or types of pipe either to increase or decrease sizes.
	210 Ductile Iron Coupling	The standard wide range coupling for joining Cast Iron, Ductile Iron, A/C, C-900/C-905 PVC and other types of pipe. Sizes 2" - 24"
	211 Ductile Iron Coupling	Sized for steel and IPS PVC this ductile iron coupling offers more deflection capability and corrosion resistance than steel couplings. Sizes 2"- 24"
	212 Ductile Iron Transition Coupling	Utilizes special transition gaskets in standard ductile iron couplings to join pipe of the same nominal size but different outside diameters. Sizes 2-1/4" - 24"
	214 Pipe End Cap Coupling	Provides a simple means of capping all types of plain end pipe. Also used for line testing, air release and reducing line for service extensions. Sizes 3" - 12" Larger sizes on request.
	215 Long Ductile Iron Couplings	Extra long coupling provides a wide range, accommodates wide gaps between pipe ends, reduces inventory and fits both cast iron and A/C Class 150 pipe in the popular 4", 6" and 8" sizes. Utilizes the JCM original transition gasket system.
	219 Restrained Ductile Iron Coupling	Simplifies piping installations requiring couplings and tie rods or other types of restraint. Provides an easy joint makeup with restraint in a minimum amount of space. Sizes 4" - 12"
	241 Optimum Range Coupling - Standard Length	Optimum range coupling accommodates all types of pipe within the same nominal size. No change of gasket, end rings or bolts. Can be installed without complete disassembly. Sizes 3" - 16"
	242 Optimum Range Coupling - Long Length	

JCM Selection Guide to Flanged Coupling Adapters

PRODUCT	NUMBER & TYPE	APPLICATION, SIZES AND INFORMATION
	301 Flanged Coupling Adapter	This most popular and versatile FCA provides a quick means of joining plain end pipe for flanged fittings, valves and equipment. Short laying length does not require exact alignment of pipe and preparation. Can be used with butterfly and wafer valves. Sizes 4" - 12"
	303 Fabricated Flanged Coupling Adapter	Quick means of joining plain end pipe to flanged fittings of same nominal size. Most popular sizes - 14" and larger. Also available in sizes 2" - 12"
	304 Fabricated Reducing Flanged Coupling Adapter	Provides a quick means of increasing or reducing pipe sizes at a flanged connection. Sizes 2" and larger.
	306 Fabricated Flanged Coupling Adapter	A very versatile FCA which combines the ductile iron coupling system to a flanged outlet. Excellent for cutting in equipment or where more take up capability is needed. Available for 10" and 12" Asbestos Cement pipe. Sizes 3" - 12". Larger sizes upon request.
	307 Fabricated Reducing Flanged Coupling Adapter	Similar to the JCM 306 FCA this adapter is available with reducing or larger flanges. Excellent for installing reduced sizes of meters and equipment in lines. For pipe sizes 3" - 12" with larger or smaller flanges. Larger sizes upon request.
	309 Fabricated Dismantling Joint	<p>Simplify installations and replacement of flanged fittings in retrofitting applications. Provides the solution for adding, repairing or replacing flanged fittings within a flanged pipe system. Adjustable, slip joint design accommodates either wide gaps or close quarter installations and eliminates the need for precise measurements between flange connections.</p> <p>Available in sizes 2" and larger, for ductile iron or flanged steel pipe systems.</p>

JCM 201 Steel Couplings for Steel Pipe Sizes

JCM 201 Steel Couplings provide an easy means of joining plain end pipe. These couplings are especially applicable for use on steel, galvanized, PVC and other pipe with standard steel dimensions.



201 STEEL COUPLINGS FOR STEEL PIPE SIZES

NOM. PIPE SIZE (IN.)	PIPE O.D. RANGE (IN.)	SLEEVE LENGTH & THICKNESS	NO. OF BOLTS	CATALOG NUMBER	CARTON QUANTITY	APPR. WT. EACH LBS.
1/2	.84	.157 x 3-1/2	2	201-008401	12	1
3/4	1.05	.157 x 5	2	201-010501	12	2
1	1.32	.157 x 5	2	201-013201	12	3-1/2
1-1/4	1.66	.138 x 5	2	201-016601	6	4
1-1/2	1.90	.157 x 5	2	201-019001	6	4-1/2
2	2.38	.157 x 5	2	201-023800	6	5
2	2.38	.157 x 5	3	201-023801	1	7
2-1/2	2.88	.197 x 5	3	201-028801	1	8
3	3.50	.157 x 5	4	201-035001	1	10
3	3.50	.157 x 7	4	201-035002	1	12
4	4.50	.157 x 5	4	201-045001	1	12
4	4.50	.157 x 7	4	201-045002	1	15
5	5.56	1/4 x 5	4	201-055601	1	16
6	6.63	1/4 x 5	6	201-066301	1	18
6	6.63	1/4 x 7	6	201-066302	1	22
8	8.63	1/4 x 5	6	201-086301	1	20
8	8.63	1/4 x 7	6	201-086302	1	26
10	10.75	1/4 x 5	8	201-107501	1	32
10	10.75	5/16 x 7	8	201-107507	1	46
12	12.75	1/4 x 5	8	201-127501	1	51
12	12.75	5/16 x 7	8	201-127507	1	62
14	14.00	3/8 x 7	8	201-140007	1	89
16	16.00	3/8 x 7	10	201-160007	1	95
18	18.00	3/8 x 7	10	201-180007	1	102
20	20.00	3/8 x 7	12	201-200007	1	115
22	22.00	3/8 x 7	14	201-220007	1	126
24	24.00	3/8 x 7	14	201-240007	1	132
28	28.00	3/8 x 7	15	201-280007	1	140
30	30.00	3/8 x 7	16	201-300007	1	158
36	36.00	1/2 x 10	18	201-360009	1	250
42	42.00	1/2 x 10	20	201-420009	1	315
48	48.00	1/2 x 10	22	201-480009	1	375

Note: Applications in which pipe may move out of the coupling, proper anchorage of the pipe must be provided.



JCM 201 Steel Couplings for Cast Iron Pipe Sizes

201 STEEL COUPLINGS 14" AND LARGER

NOM. PIPE SIZE (IN.)	PIPE O.D. RANGE (IN.)	SLEEVE LENGTH & THICKNESS	NO. OF BOLTS	CATALOG NUMBER	APPR. WT. EA. (LBS.)
14	15.30	3/8 X 7	8	201-153007	85
14	15.65	3/8 X 7	8	201-156507	85
14	16.75	3/8 X 7	10	201-167507	89
16	17.40	3/8 X 7	10	201-174007	90
16	17.80	3/8 X 7	10	201-178007	90
16	18.88	3/8 X 7	10	201-188807	95
18	19.50	3/8 X 7	12	201-195007	113
18	19.92	3/8 X 7	12	201-199207	115
20	21.60	3/8 X 7	12	201-216007	126
20	22.06	3/8 X 7	14	201-220607	126
24	25.80	3/8 X 7	15	201-258007	141
24	26.32	3/8 X 7	15	201-263207	147
30	31.74	3/8 X 7	16	201-317407	200
30	32.00	1/2 X 10	16	201-320007	210
36	37.96	1/2 X 10	18	201-379609	273
36	38.30	1/2 X 10	18	201-383009	278
42	44.20	1/2 X 10	20	201-442009	338
42	44.50	1/2 X 10	20	201-445009	338
48	50.50	1/2 X 10	22	201-505009	375
48	50.80	1/2 X 10	22	201-508009	375

Other Sizes Available Upon Request

*For Sizes 2" through 12" See JCM 210 Ductile Iron Couplings

Note: Applications in which pipe may move out of the coupling, proper anchorage of the pipe must be provided.

MATERIAL SPECIFICATIONS - JCM STEEL COUPLINGS

Sizes 1/2" through 2":

Middle Ring: ASTM A-36
Followers: Ductile Iron ASTM A-536
Bolts: ASTM A242 low alloy with yellow dichromate seal. Optional 18-8 Type 304 Stainless Steel bolts available.

Sizes 14" and Larger:

Middle Ring: ASTM A-36
Followers: ASTM A-36
Bolts: Corrosion resistant, high strength low alloy (AWWA C-111, ANSI A21.11). Optional 18-8 Type 304 Stainless Steel bolts available.

Sizes 2-1/2" through 12":

Middle Ring: ASTM A-36
Followers: Ductile Iron ASTM A-536
Bolts: Corrosion resistant, high strength low alloy (AWWA C-111, ANSI A21.11). Optional 18-8 Type 304 Stainless Steel bolts available.

Gaskets: Nitrile Butadiene Rubber (NBR, Buna-N) per ASTM D2000. Molded virgin rubber. Gasket temperature range -40°F to 212°F (-40°C - 100°C) Recommended for water, salt solutions, mild acids, bases, sewage and natural gas. Available Options: EPDM

Finish: Heavy coat of corrosion resistant shop coat primer.
 Optional Fusion Epoxy Coating available (AWWA C-213).



JCM Industries couplings meet or exceed the ANSI/AWWA C-219 Standard for Bolted Sleeve Type Couplings as applicable.

Certified to NSF/ANSI 61

JCM 202 Long Steel Couplings for Steel Pipe Sizes



202 LONG STEEL COUPLINGS - STEEL PIPE SIZES

NOM. PIPE SIZE (IN.)	PIPE O.D. RANGE (IN.)	SLEEVE LENGTH & THICKNESS	NO. OF BOLTS	CATALOG NUMBER	APPR. WT. EA. (LBS.)
2	2.375	.154 X 12	3	202-023811	15
2-1/2	2.875	.203 X 12	3	202-028811	20
3	3.500	.203 X 12	4	202-035011	23
4	4.500	.203 X 12	4	202-045011	28
6	6.625	1/4 X 16	6	202-066311	51
8	8.625	1/4 X 16	6	202-086311	54
10	10.750	1/4 X 16	8	202-107511	81
12	12.750	1/4 X 16	8	202-127511	119

Smaller and Larger Sizes available upon request

Note: Applications in which pipe may move out of the coupling, correct anchorage of the pipe must be provided.

JCM STEEL COUPLINGS OFFER THESE ADVANTAGES

- No beveling, costly threading, exact pipe alignment or fitting is required.
- Quick, simple to install, using only a wrench.
- Gaskets absorb vibration and pipe movement - permits curves to be laid with straight pieces of pipe.
- Simple, rugged and serviceable, JCM couplings are available for most sizes of steel, PVC or cast iron pipe sizes.



JCM 203 Steel Transition Couplings



The JCM 203 Steel Transition Coupling provides a simple means of joining plain end pipe of the same nominal size but different outside diameter dimensions. The couplings are especially useful in joining old cast iron pipe to ductile iron pipe. Listed are the most common sizes. Other sizes are available upon request. Also see JCM 212 Ductile Iron Couplings.

203 STEEL TRANSITION COUPLINGS

NOM. PIPE SIZE (IN.)	FROM O.D. RANGE (IN.)	TRANSITION TO O.D. RANGE (IN.)	SLEEVE LENGTH (IN.)	MIDDLE RING THICKNESS (IN.)	CATALOG NUMBER	APPR. WT. EA. (LBS.)
14	15.65	15.30	7	3/8"	203-1565-1530	104
16	17.80	17.40	7	3/8"	203-1780-1740	117
18	19.92	19.50	7	3/8"	203-1992-1950	131
20	22.06	21.60	7	3/8"	203-2206-2160	148
24	26.32	25.80	7	3/8"	203-2632-2580	175

OTHER SIZES AVAILABLE UPON REQUEST

NOTE: Applications in which pipe may move out of the coupling, correct anchorage of the pipe must be provided.

JCM 204 Steel Reducing Couplings

The JCM 204 Steel Reducing Coupling is the simplest means of connecting any combination of two sizes or types of pipe. There is practically no limit to the pipe sizes that can be connected - either to reduce or increase in size. One common use is joining large steel pipe to ductile iron or C-905 PVC pipe. Listed are the most common sizes. Other sizes are available upon request.

204 STEEL REDUCING COUPLINGS

NOM. PIPE SIZE (IN.)	FROM O.D. RANGE (IN.)	REDUCE TO O.D. RANGE (IN.)	CATALOG NUMBER	APPR. WT. EACH (LBS.)
14	15.30	14.00	204-1530-1400	170
	15.65	14.00	204-1565-1400	170
16	17.40	16.00	204-1740-1600	195
	17.80	16.00	204-1780-1600	195
	18.88	17.40	204-1888-1740	205
18	19.50	18.00	204-1950-1800	215
	19.92	18.00	204-1992-1800	215
20	21.60	20.00	204-2160-2000	245
	22.06	20.00	204-2206-2000	245
24	25.80	24.00	204-2580-2400	290
	26.32	24.00	204-2632-2400	290

OTHER SIZES AVAILABLE UPON REQUEST

NOTE: Applications in which pipe may move out of the coupling, correct anchorage of the pipe must be provided.



JCM Ductile Iron Couplings

Now Offering 14" - 24" Nominal Pipe Sizes

JCM Ductile Iron Couplings employ the mechanical compression joint principle to join two pieces of plain end pipe. Eliminates precise cutting and fitting in the field, provides for deflection, limited expansion-contraction, pipe settlement and a quick easy means of disassembly for maintenance. JCM Bolted Coupling meet or exceed the ANSI/AWWA C219 Standard as applicable. **Note: Applications in which pipe may move out of the coupling, proper anchorage of the pipe must be provided.**



210 DUCTILE IRON COUPLINGS - STANDARD SIZE

NOM. PIPE SIZE (IN.)	PIPE O.D. RANGE (IN.)	CATALOG NUMBER	FITS TYPE AND CLASS OF PIPE	NO. OF BOLTS	SLEEVE LENGTH (IN.)	APPR. WT. EACH (LBS.)
2	2.34 - 2.63	210-0250	STEEL, PVC, CI	2	5	8
2-1/4, 2-1/2	2.62 - 2.92	210-0288	CI, STEEL, PVC	2	5	9
3	3.80 - 4.17	210-0396	CI, DI, A/C 150	3	6	15
4	4.80 - 5.10	210-0480	CI, DI, A/C 150, C-900PVC, DI HDPE	4	6	20
6	6.90 - 7.20	210-0690	CI, DI, A/C 150, C-900 PVC, DI HDPE	5	6	24
8	9.05 - 9.40	210-0905	CI, DI, A/C 150, C-900 PVC, DI HDPE	6	6	36
10	11.10 - 11.40	210-1110	CI, DI, C-900 PVC, DI HDPE	7	6	46
12	13.20 - 13.50	210-1320	CI, DI, C-900 PVC, DI HDPE	8	6	62
14	15.30 - 15.70	210-1530	CI, DI, C-905 PVC, DI HDPE	9	7	100
16	17.40 - 17.80	210-1740	CI, DI, C-905 PVC, DI HDPE	10	7	132
18	19.10 - 19.70	210-1950	CI, DI, C-905 PVC, DI HDPE	12	7	140
20	21.35 - 21.75	210-2160	CI, DI, C-905 PVC, DI HDPE	12	7	150
24	25.70 - 26.00	210-2580	CI, DI, C-905 PVC, DI HDPE	14	10	285

210 DUCTILE IRON COUPLINGS - OVERSIZED (A/C Class 200 & oversized pipe)

NOM. PIPE SIZE (IN.)	PIPE O.D. RANGE (IN.)	CATALOG NUMBER	FITS TYPE AND CLASS OF PIPE	NO. OF BOLTS	SLEEVE LENGTH (IN.)	APPR. WT. EACH (LBS.)
4	5.10 - 5.40	210-0535	Oversized and Class 200 A/C	4	6	22
6	7.20 - 7.55	210-0740	Oversized and Class 200 A/C	5	6	31
8	9.40 - 9.75	210-0960	Oversized and Class 200 A/C	6	6	41
10	11.60 - 12.05	210-1200	Oversized and Class 200 A/C	7	6	55
12	13.92 - 14.40	210-1420	Oversized and Class 200 A/C - STEEL	8	6	68

211 DUCTILE IRON COUPLINGS - IPS PVC, IPS HDPE, STEEL PIPE

NOM. PIPE SIZE (IN.)	PIPE O.D. RANGE (IN.)	CATALOG NUMBER	FITS SIZES OF PIPE STEEL	NO. OF BOLTS	SLEEVE LENGTH (IN.)	APPR. WT. EA. (LBS.)
2	2.38	210-0250	STANDARD IPS & SCHEDULE PIPE	2	5	8
2-1/2	2.88	210-0288	STANDARD IPS & SCHEDULE PIPE	2	5	9
3	3.50	211-0350	STANDARD IPS & SCHEDULE PIPE	3	6	15
4	4.50	211-0450	STD. IPS PVC, SCHEDULE PIPE, IPS HDPE	4	6	20
6	6.63	211-0663	STD. IPS PVC, SCHEDULE PIPE, IPS HDPE	5	6	25
8	8.63	211-0863	STD. IPS PVC, SCHEDULE PIPE, IPS HDPE	6	6	38
10	10.75	211-1075	STD. IPS PVC, SCHEDULE PIPE, IPS HDPE	7	6	46
12	12.75	211-1275	STD. IPS PVC, SCHEDULE PIPE, IPS HDPE	8	6	64
16	16.00	211-1600	STD. IPS PVC, SCHEDULE PIPE, IPS HDPE	10	7	132
18	18.00	211-1800	STD. IPS PVC, SCHEDULE PIPE, IPS HDPE	12	7	140
20	20.00	211-2000	STD. IPS PVC, SCHEDULE PIPE, IPS HDPE	12	7	150
24	24.00	211-2400	STD. IPS PVC, SCHEDULE PIPE, IPS HDPE	13	7	165



Certified to NSF/ANSI 61

JCM 212 Ductile Iron Transition Couplings

NOW OFFERS 24" NOMINAL PIPE SIZES

212 DUCTILE IRON TRANSITION COUPLINGS

NOM. PIPE SIZE (IN.)	FROM O.D. RANGE (IN.)	TRANSITION TO O.D. RANGE (IN.)	CATALOG NUMBER	NO. OF BOLTS	SLEEVE LENGTH (IN.)	APPR. WT. EACH (LBS.)
2, 2-1/2	2.62 - 2.92	2.38 - 2.50	212-0288-0238	2	5	9
3	3.80 - 4.17	3.50	212-0396-0350	3	6	15
4	4.50	4.00	212-0450-0400	4	6	20
4	4.50	4.22	212-0450-0422	4	6	20
4	4.80 - 5.10	4.00	212-0480-0400	4	6	20
4	4.80 - 5.10	4.22	212-0480-0422	4	6	20
4	4.80 - 5.10	4.50	212-0480-0450	4	6	20
4	5.10 - 5.40	4.50	212-0535-0450	4	6	22
4	5.10 - 5.40	4.80	212-0535-0480	4	6	22
6	6.63	6.00	212-0663-0600	5	6	26
6	6.63	6.30	212-0663-0630	5	6	26
6	6.90 - 7.20	6.00	212-0690-0600	5	6	26
6	6.90 - 7.20	6.30	212-0690-0630	5	6	26
6	6.90 - 7.20	6.63	212-0690-0663	5	6	26
6	7.20 - 7.55	6.63	212-0740-0663	5	6	31
6	7.20 - 7.55	6.90	212-0740-0690	5	6	31
8	8.63	8.00	212-0863-0800	6	6	38
8	8.63	8.40	212-0863-0840	6	6	38
8	9.05 - 9.40	8.00	212-0905-0800	6	6	38
8	9.05 - 9.40	8.40	212-0905-0840	6	6	38
8	9.05 - 9.40	8.63	212-0905-0863	6	6	38
8	9.40 - 9.75	8.63	212-0960-0863	6	6	41
8	9.40 - 9.75	9.05	212-0960-0905	6	6	41
10	10.75	10.50	212-1075-1050	7	6	46
10	11.10 - 11.40	10.50	212-1110-1050	7	6	46
10	11.10 - 11.40	10.75	212-1110-1075	7	6	46
10	11.60 - 12.05	10.75	212-1200-1075	7	6	57
10	11.60 - 12.05	11.10	212-1200-1110	7	6	57
12	12.75	12.50	212-1275-1250	8	6	64
12	13.20 - 13.50	12.50	212-1320-1250	8	6	64
12	13.20 - 13.50	12.75	212-1320-1275	8	6	64
12	13.92 - 14.40	12.75	212-1420-1275	8	6	70
12	13.92 - 14.40	13.20	212-1420-1320	8	6	70
24	26.10 - 26.32	25.70 - 26.00	212-2635-2580	14	10	285

Note: Applications in which pipe may move out of the coupling, proper anchorage of the pipe must be provided.



JCM 214 Pipe End Cap Couplings

The JCM 214 Pipe End Cap Coupling is a quick, simple means of capping plain end pipe in either permanent or temporary installations. Furnished standard with a threaded outlet, this fitting is often used as a test cap, air release or as a means of reduction for a smaller line extension. The optional restrained coupling end eliminates the need for required thrust blocks.



214 PIPE END CAP COUPLINGS (WITH 2" IPS OUTLET)

NOM. PIPE SIZE (IN.)	PIPE O.D. RANGE (IN.)	CATALOG NUMBER	FITS TYPES & CLASSES OF PIPE	NO. OF BOLTS	SLEEVE LENGTH (IN.)	APPR. WT. EACH (LBS.)
3	3.50	214-0350	STEEL, PVC	3	6	19
3	3.80 - 4.17	214-0396	CI, DI, A/C 150	3	6	19
4	4.50	214-0450	STEEL, PVC	4	6	25
4	4.80 - 5.10	214-0480	CI, DI, A/C 150, C-900 PVC	4	6	25
4	5.10 - 5.40	214-0535	A/C	4	6	27
6	6.63	214-0663	STEEL, PVC	5	6	32
6	6.90 - 7.20	214-0690	CI, DI, A/C 150, C-900 PVC	5	6	32
6	7.20 - 7.55	214-0740	A/C	5	6	41
8	8.63	214-0863	STEEL, PVC	6	6	51
8	9.05 - 9.40	214-0905	CI, DI, A/C 150, C-900 PVC	6	6	49
8	9.40 - 9.75	214-0960	A/C	6	6	56
10	10.75	214-1075	STEEL, PVC	7	6	64
10	11.10 - 11.40	214-1110	CI, DI, A/C 150, C-900 PVC	7	6	64
10	11.60 - 12.05	214-1200	A/C	7	6	78
12	12.75	214-1275	STEEL, PVC	8	6	88
12	13.20 - 13.50	214-1320	CI, DI, A/C 150, C-900 PVC	8	6	86
12	13.92 - 14.40	214-1420	A/C, STEEL	8	6	99

*Pipe sizes 3.50 & 3.96 have 1-1/2" IPS outlet.

Large Sizes Available Upon Request

Requires thrust blocks or restraint. Restrained ends available sizes 4" -12". Add (R) to end of catalog number to indicate restrained ends. (Not for use A/C pipe, HDPE or PVC pipe).

Note: Applications in which pipe may move out of the coupling, correct anchorage of the pipe must be provided.

JCM 219 Restrained Ductile Iron Couplings

JCM 219 Restrained Ductile Iron Coupling simplifies piping installations requiring tie rods or other types of thrust restraint. The Ductile Iron Coupling eliminates the need for exact pipe fit, alignment and end preparation. The integral restraining set screws provide restraint equal to restrained M.J. glands and eliminate the need for cumbersome tie rods or harness assemblies.



NOM. PIPE SIZE (IN.)	PIPE O.D. RANGE (IN.)	CATALOG NUMBER	NO. OF BOLTS	NO. OF SET SCREWS EA. END	APPR. WT. EACH (LBS.)
3	3.80 - 4.17	219-0396	4	4	19
4	4.80 - 5.10	219-0480	4	4	22
6	6.90 - 7.20	219-0690	8	8	38
8	9.05 - 9.40	219-0905	8	8	46
10	11.10 - 11.40	219-1110	12	12	67
12	13.20 - 13.50	219-1320	12	12	81

Larger Sizes available upon request.

NOTE: Restrained ends are not for use on Asbestos Cement, HDPE or PVC pipe.

Note: Applications in which pipe may move out of the coupling, correct anchorage of the pipe must be provided.



JCM 215 Long Duc tile Iron Couplings



JCM Introduces the 215 Long Ductile Iron Coupling. This extra-long coupling provides a wide range, accommodates wide gaps between pipe ends, reduces inventory and fits both cast iron and A/C Class 150 pipe in the popular 4", 6" & 8" sizes. The JCM 215 utilizes the same JCM original transition gasket system. One coupling replaces two or more standard couplings. Unique transition gaskets change standard couplings into transition couplings, eliminating the need to stock transition couplings or color-coded end rings, gaskets and loose parts.

215 LONG DUCTILE IRON COUPLINGS

NOM. PIPE SIZE (IN.)	PIPE O.D. RANGE (IN.)	CATALOG NUMBER	FITS TYPE AND CLASS OF PIPE	NO. OF BOLTS	COUPLING LENGTH (IN.)	APPR. WT. EACH (LBS.)
2	2.34 - 2.63	215-0250	STEEL, PVC, CI	2	10	16
2-1/2	2.62 - 2.92	215-0288	CI, STEEL, PVC	2	10	18
3	3.50	215-0350	STANDARD IPS & SCHEDULE PIPE	3	12	30
3	3.80 - 4.17	215-0396	CI, DI, A/C 150	3	12	30
4	4.50	215-0450	STANDARD IPS & SCHEDULE PIPE	4	12	35
4	4.80 - 5.10	215-0480	CI, DI, A/C 150, C-900PVC	4	12	35
4	5.10 - 5.40	215-0535	A/C	4	12	39
6	6.63	215-0663	STANDARD IPS & SCHEDULE PIPE	5	12	42
6	6.90 - 7.20	215-0690	CI, DI, A/C 150, C-900 PVC	5	12	42
6	7.20 - 7.55	215-0740	A/C	5	12	54
8	8.63	215-0863	STANDARD IPS & SCHEDULE PIPE	6	12	65
8	9.05 - 9.40	215-0905	CI, DI, A/C 150, C-900 PVC	6	12	65
8	9.40 - 9.75	215-0960	A/C	6	12	71
10	10.75	215-1075	STANDARD IPS & SCHEDULE PIPE	7	12	79
10	11.10 - 11.40	215-1110	CI, DI, C-900 PVC	7	12	79
10	11.60 - 12.05	215-1200	A/C	7	12	87
12	12.75	215-1275	STANDARD IPS & SCHEDULE PIPE	8	12	111
12	13.20 - 13.50	215-1320	CI, DI, C-900 PVC	8	12	111
12	13.92 - 14.40	215-1420	A/C, STEEL	8	12	118

Note: Applications in which pipe may move out of the coupling, correct anchorage of the pipe must be provided.

MATERIAL SPECIFICATIONS - JCM MODELS 210, 211, 212, 214, 215, 219 DUCTILE COUPLINGS:

Sleeve & Flanges: Ductile Iron ASTM A536

Gaskets: Styrene-Butadiene Rubber (SBR) has good physical properties. Compounded for use with water, salt solutions, mild acids and bases; has excellent abrasion resistance. Per ASTM D-2000. Standard temperature range from -40° to 150°F (-40° to 65° C) constant, maximum intermittent 180° F (82° C). For applications on high temperatures or chemical pipelines, contact JCM Industries Technical Services. The material is not recommended for use on oil, ozone or weather resistant applications.

Bolts: Corrosion resistant, high strength low alloy bolts and nuts (AWWA C-111, ANSI A21.11). Optional Stainless Steel, 18-8 Type 304.

Finish: Heavy coating of corrosion resistant metal primer. Optional Fusion applied Epoxy Coating available.

JCM Industries bolted couplings meet or exceed the ANSI/AWWA C-219 Standard as applicable.



JCM Transition Gaskets

For Models 210, 211, 212, 214, 215, 216, 301, 306, 307 Couplings and FCA's

The uniquely simple JCM Wide Range Coupling and Flanged Coupling Adapter system utilizes self-centering, extra wide transition gaskets eliminating the need for stocking special transition couplings or color coded flanges and gaskets. Stock JCM Ductile Iron Coupling and JCM Flanged Coupling Adapters and change only gaskets to make a transition between A/C, Cast Iron, Ductile Iron, Steel and PVC pipe. Use the same size gasket on both ends to make a straight coupling.

GASKETS FOR STANDARD SIZE 210 DUCTILE IRON COUPLINGS

NOM. PIPE SIZE (IN.)	FITS COUPLING SLEEVE	GASKET O.D. RANGE (IN.)	FITS TYPES & CLASSES OF PIPE	GASKET NUMBER
2-1/4, 2-1/2	210-0288	2.62 - 2.92 2.38 - 2.50	CI, 2-1/2" PVC, STEEL 2" PVC, STEEL, CI	G212-0288 G212-0288-0238*
3	210-0396	3.80 - 4.17 3.50	CI, DI, A/C 150, C-900 PVC IPS PVC, STEEL	G212-0396 G212-0396-0350*
4	210-0480	4.74 - 5.10 4.50 4.22 4.00	CI, DI, A/C 150, C-900 PVC IPS PVC, STEEL, HDPE SDR 35 STEEL TUBING	G212-0480 G212-0480-0450 G212-0480-0422 G212-0480-0400
6	210-0690	6.84 - 7.26 6.63 6.30 6.00	CI, DI, A/C 150, C-900 PVC IPS PVC, STEEL, HDPE SDR 35 STEEL TUBING	G212-0690 G212-0690-0663 G212-0690-0630 G212-0690-0600
8	210-0905	8.99 - 9.42 8.63 8.40 8.00	CI, DI, A/C 150, C-900 PVC IPS PVC, STEEL, HDPE SDR 35 STEEL TUBING	G212-0905 G212-0905-0863 G212-0905-0840 G212-0905-0800
10	210-1110	11.04 - 11.40 10.75 10.50	CI, DI, C-900 PVC IPS PVC, STEEL, HDPE SDR 35	G212-1110 G212-1110-1075 G212-1110-1050
12	210-1320	13.14 - 13.50 12.75 12.50	CI, DI, C-900 PVC IPS PVC, STEEL, HDPE SDR 35	G212-1320 G212-1320-1275 G212-1320-1250
14	210-1565	15.20 - 15.40 15.56 - 15.75	CI, DI, C-905 PVC CI	G212-1530 G212-1565
16	210-1780	17.32 - 17.50 17.72 - 17.94	CI, DI, C-905 PVC CI	G212-1740 G212-1780

*This size gasket does not have extended lip.

GASKETS FOR OVERSIZED 210 DUCTILE IRON COUPLINGS

NOM. PIPE SIZE (IN.)	FITS COUPLING SLEEVE	GASKET O.D. RANGE	FITS TYPES & CLASSES OF PIPE	GASKET NUMBER
4	210-0535	5.06 - 5.40 4.80 - 5.10 4.50	A/C CI, DI, C-900 PVC IPS PVC, STEEL, HDPE	G212-0535 G212-0535-0480 G212-0535-0450
6	210-0740	7.17 - 7.55 6.90 - 7.10 6.63	A/C CI, DI, C-900 PVC IPS PVC, STEEL, HDPE	G212-0740 G212-0740-0690 G212-0740-0663
8	210-0960	9.32 - 9.75 9.05 - 9.30 8.63	A/C CI, DI, C-900 PVC IPS PVC, STEEL, HDPE	G212-0967 G212-0967-0905 G212-0967-0863
10	210-1200	11.60 - 12.05 11.10 - 11.30 10.75	A/C CI, DI, C-900 PVC IPS PVC, STEEL, HDPE	G212-1200 G212-1200-1110 G212-1200-1075
12	210-1420	13.92 - 14.40 13.20 - 13.50 12.75	A/C CI, DI, C-900 PVC IPS PVC, STEEL, HDPE	G212-1420 G212-1420-1320 G212-1420-1275



JCM 220 Galvanized Compression Fittings



220 GALVANIZED COMPRESSION COUPLINGS

JCM FITTINGS	NOM. PIPE SIZE (IN.)	PIPE O.D. (IN.)	CATALOG NUMBER	OVERALL LENGTH (IN.)	CTN. QTY.	CTN. WT.	APPR. WT. EACH (LBS.)
 220 Compression Coupling	1/2	.840	220-0084-L	4-1/8	12	11	.80
	3/4	1.050	220-0105-L	4-1/4	12	14	1.08
	1	1.315	220-0132-L	4-1/2	12	19	1.42
	1-1/4	1.660	220-0166-L	4-3/4	12	23	1.92
	1-1/2	1.900	220-0190-L	5	12	28	2.33
	2	2.375	220-0238-L	5-1/4	12	40	3.38

225 Insulating Adapter Gaskets

For adapting iron pipe size fittings to copper tube size. Also for insulation between dissimilar metals to prevent galvanic corrosion.

225 INSULATING ADAPTER GASKETS

NOMINAL PIPE SIZES	CATALOG NUMBER
1/2 IP X 1/2 CT	225-0084-0063
3/4 IP X 3/4 CT	225-0105-0080
1 IP X 1 CT	225-0132-0113
1-1/4 IP X 1-1/4 CT	225-0166-0138
1-1/2 IP X 1-1/2 CT	225-0190-0163
2 IP X 2 CT	225-0238-0213



JCM 241 Standard Length Optimum Range Ductile Iron Couplings

JCM 242 Long Length Optimum Range Ductile Iron Couplings

JCM “Optimum Range Coupling”

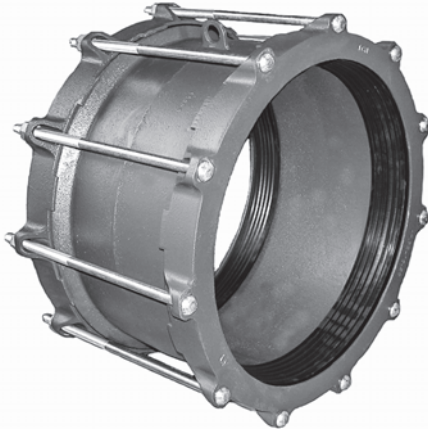

Full Range capability for pipe sizes 3” through 16”

242 Long length middle ring allows for deeper pipe insertion and accommodates wide gaps between pipe ends

Rated for 250 PSI working pressure

Reduces inventory - one coupling fits SDR35, IPS PVC, C-900 PVC, Ductile Iron, Steel, Cast Iron and A/C Pipe classes 100, 150 and 200

Non-compromising design with maximum number of bolts for uniform tightening provides the engineered test and field proven service and reliability of the JCM Ductile Iron Coupling family.

NOM. PIPE SIZE (IN.)	PIPE O.D. RANGE (IN.)	CATALOG NUMBER	SLEEVE LENGTH (IN.)	NO. OF BOLTS	APPROX. WT. EA. (LBS.)
3	3.45 - 4.20	241-0420	6	3	22
		242-0420	10	3	26
4	4.22 - 5.60	241-0550	6	4	30
		242-0550	10	4	35
6	6.28 - 7.60	241-0760	6	5	39
		242-0760	10	5	46
8	8.40 - 9.75	241-0960	6	6	47
		242-0960	10	6	55
10	10.50 - 12.12	241-1200	6	8	62
		242-1200	10	8	71
12	12.50 - 14.38	241-1430	6	8	71
		242-1430	10	8	84
14	15.05 - 16.93	242-1690	10	10	115
16	17.32 - 19.20	242-1920	10	11	118

MATERIAL SPECIFICATIONS - JCM 241, 242 OPTIMUM RANGE COUPLING

- Sleeve & Flanges:** Ductile Iron Per ASTM A536 65-45-12
- Gaskets:** Nitrile Butadiene Rubber (NBR, Buna-N) per ASTM D2000.
Gasket temperature range -40°F to 212°F (-40°C - 100°C) Gasket suitable for water, salt solutions, mild acids, bases, and sewage.
- Bolts:** 5/8" Corrosion resistant, high strength low alloy oval neck track head bolts per ASTM A242/ANSI 21.11/AWWA C111 and heavy hex nuts per A563 or equal. Optional Hardware: Stainless Steel 18-8 Type 304 or 316; Epoxy Coated Alloy Hardware, Powercron 590-534 black cationic electrocoat
- Finish:** Corrosion resistant shop coat paint primer. Optional fusion applied epoxy coating per ANSI/AWWA C-213. Other coatings available upon request.

JCM Industries bolted couplings meet or exceed the ANSI/AWWA C-219 Standard as applicable.



JCM PRODUCTS FOR POLYETHYLENE PIPE

JCM Industries manufactures a number of products which have proven to be very applicable to HDPE Pipe. Due to the unique characteristics of polyethylene pipe, special attention should be applied to the repair, connection and tapping procedures performed in systems using this type of pipe. Products especially applicable to HDPE pipe include:

COUPLINGS AND REPAIR CLAMPS

101 - 102 Universal Clamp Couplings
131 - 132 All Stainless Steel Universal Clamp Couplings
201 Steel Couplings
210 Series Ductile Iron Couplings
230 Series Stiffeners



JCM 230 Stiffener

TAPPING SLEEVES AND SADDLES

412 - 422 - 452 Tapping Sleeves (4" size and larger)
418 - 438 Threaded Outlet Tapping Sleeve (1/2" - 4" Outlets)
404 - 406 Service Saddle with Double Stainless Steel Straps (3/4" thru 2-1/2" outlets, 2" - 24" sizes)

Success in these products is largely due to the design criteria that took the working characteristics of HDPE Pipe into consideration. Design characteristics inherent to JCM clamps, couplings, tapping sleeves, saddles and other products area as follows:

GASKETS - Tapping sleeve and service saddle gaskets should have wide cross section with enough volume to store compression energy. Gaskets should be of a hardness which will flex with pipe pressure fluctuations. Outlet seals should have a mechanical sealing lip that utilizes line pressure to increase seal. Outlet gaskets should be externally and internally confined.

TAPPING SLEEVE OR CLAMP BODY - Tapping sleeve or clamp coupling body should conform to the HDPE pipe and support it and the branch (in cases of outlets). Width of sleeve should be such that it spreads the load to prevent point loading or deformation of the pipe.

BOLTING - Bolting should be self-aligning and heavy enough to properly load the gasket and assure an adequate safety factor.

For specific applications or questions regarding product recommendations or availability, please call the JCM Inside Sales Team.

PRODUCTS FOR POLYETHYLENE PIPE



JCM recommends JCM Model 230 pipe stiffeners be used when joining or connecting High Density Polyethylene Pipe.

JCM 301 Flanged Coupling Adapters

The Quick, Simple, Economical way to join flanged fittings, valves and meters to plain end pipe.

Ductile Iron body and flange and corrosion resistant high strength alloy bolts provide high strength and corrosion resistance to installations.

Laying length provides extra margin of safety for field cutting of pipe, yet is short enough for close quarter installations.

Full bolting to compression flange provides proper gasket compression. Many adapters use half the number of the standard flange.

Special flange gasket provides extra sealing capability on new and old flanged fittings and equipment. The wide molded gasket has a special lip which increases its sealing pressure with increases in line pressure.

Special flange design provides extra versatility which makes it an excellent means for installing wafer type valves, fittings and equipment.

Optional retainer set screws anchor the adapter on steel, cast iron and ductile iron pipe eliminating the need for tie rods, thrust blocks and additional joint restraint. Retainer set screws are not exposed to the line contents and do not require drilling of pipe.

Special wide range gaskets, which are interchangeable with JCM Ductile Iron Couplings, provide extra field versatility necessary on installations involving deflection, oversize pipe, out-of-round and uneven pipe ends.

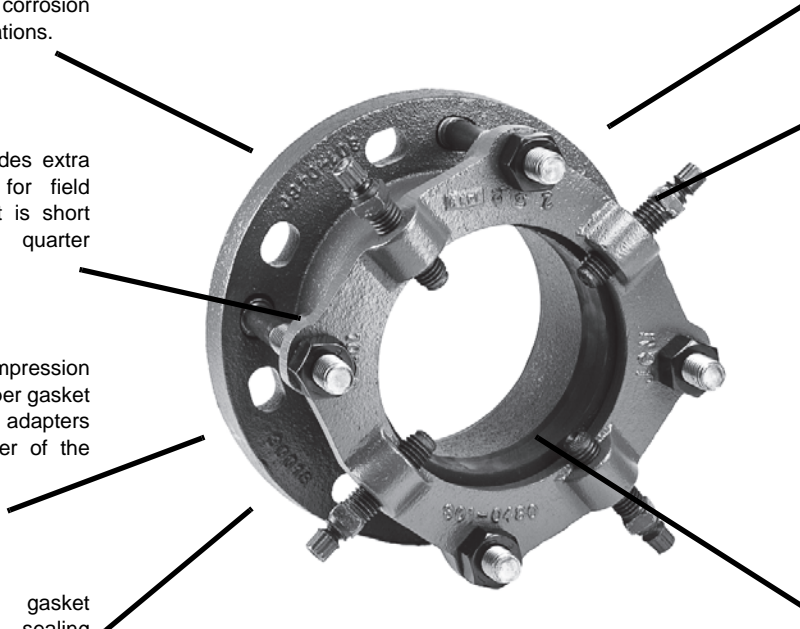

JCM 301 Flanged Coupling Adapter Dimensions

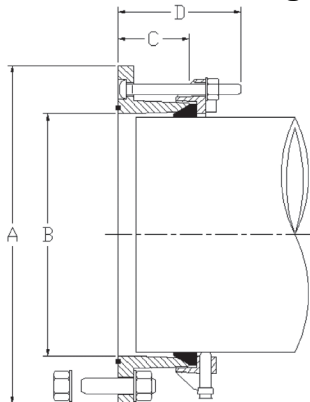

Nominal Size	A	B	C	D
3	8-1/8	4-1/4	3	5-1/2
4	9-1/8	5-1/4	3	5-1/2
6	11-1/8	7-5/16	3-1/2	5-1/2
8	13-1/2	9-9/16	3-1/2	5-1/2
10	16-1/4	11-9/16	4	7
12	19	13-5/8	4	7

The JCM 301 Flanged Coupling Adapter combines a flange with a ductile iron flexible coupling to provide a compact adapter fitting to connect plain end pipe to flanged fittings, meters, valves and equipment. The JCM 301 can be used to make on-site flanged spools and, when used with the optional set screws, eliminates the need for extra tie rods or harnessing assemblies on flanged equipment.

JCM 301 Flanged Coupling Adapters



301 Standard Flanged Coupling Adapter

301 Standard Flexible Flanged Coupling Adapter

The JCM 301 FCA provides a quick simple means of joining flanged fittings to plain end pipe. The 301 will absorb vibration, accommodate pipe deflection and expansion, provide for easy equipment removal and reinstallation, and eliminate the need for exact measurements.

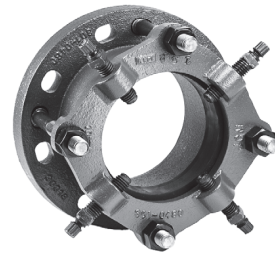

301 Optional Restrained Flanged Adapter

Applications especially advantageous for using JCM FCA's

- Valve insertions
- Equipment connections and offset adjustment
- Converting flanged fittings to mechanical joint or push on type
- Dampening vibration
- Providing for field fitting of flanged spool pieces

301 FLANGED COUPLING ADAPTERS

NOM. PIPE SIZE (IN.)	PIPE O.D. RANGE (IN.)	CATALOG NUMBER	QTY OPTIONAL SET SCREWS	APPR. WT EACH (LBS.)
3	3.50	301-0350	4	17
	3.80 - 4.17	301-0396	4	17
4	4.00	301-0400	N/A	22
	4.50	301-0450	4	22
	4.80 - 5.10	301-0480	4	22
6	6.00	301-0600	N/A	37
	6.63	301-0663	8	37
	6.90 - 7.20	301-0690	8	37
8	8.00	301-0800	N/A	44
	8.63	301-0863	8	44
	9.05 - 9.40	301-0905	8	44
10	10.75	301-1075	12	67
	11.10 - 11.40	301-1110	12	67
12	12.75	301-1275	12	94
	13.20 - 13.50	301-1320	12	94

*Set Screws are not for use on Asbestos Cement, HDPE or PVC pipe.

Add (R) to end of Catalog Number to indicate optional set screws.

Note: Applications in which pipe may move out of the coupling, proper anchorage of the pipe must be provided.

MATERIAL SPECIFICATIONS - JCM 301 FLANGED COUPLING ADAPTER

Sleeve & Flanges: Sleeve - Ductile Iron Per ASTM A536 65-45-12.

Flange - Ductile Iron with ANSI Class 125 & 150 bolt pattern

Gaskets: Styrene-Butadiene Rubber (SBR) has good physical properties. Standard temperature range from -40° to 150°F (-40° to 65°C) constant, maximum intermittent 180° F (82° C). Per ASTM D-2000. Compounded for use with water, salt solutions, mild acids and bases; has excellent abrasion resistance. For applications on high temperatures or chemical pipelines, contact JCM Industries. The material is not recommended for use on oil, ozone or weather resistant applications.

Bolts: 5/8" Corrosion resistant, high strength low alloy oval neck track head bolts per ASTM A242/ANSI 21.11/AWWA C111 and heavy hex nuts per A563 or equal. Optional Hardware: Stainless Steel 18-8 Type 304 or 316; Epoxy Coated Alloy Hardware, Powercron 590-534 black cationic electrocoat.

Finish: Corrosion resistant shop coat paint primer. Optional fusion applied epoxy coating per ANSI/AWWA C-213. Other coatings available upon request.

JCM Industries flanged adapters meet or exceed the ANSI/AWWA C-219 Standard as applicable.



JCM 303 Fabricated Flanged Coupling Adapters



The JCM 303 Fabricated Flanged Coupling Adapter provides a simple means of joining plain end pipe to flanged fittings, valves and equipment. Fabricated from steel, these fittings are readily available in large or small sizes with a standard ANSI/AWWA Class D flange. Special or heavier flanges are available on request.

Flange: Standard 125# Class D - other flanges available upon request.

HOW TO ORDER

1. Determine pipe O.D. and flange size & type to be joined.

2. Order catalog Number indicating O.D. and flange size selected.

EXAMPLE: For 17.40 O.D. ductile iron pipe to be joined to 16" Class D flange, order: 303-1740 x16

JCM 303 FLANGED COUPLING ADAPTERS

NOM. PIPE SIZE (IN.)	PIPE O.D. RANGE (IN.)	NOMINAL FLANGE SIZE	CATALOG NUMBER	APPR. WT. EACH (LBS.)
3	3.50	3	303-0350 X 3	19
3	3.96	3	303-0396 X 3	20
4	4.50	4	303-0450 X 4	25
4	4.80 - 5.00	4	303-0480 X 4	26
5	5.56	5	303-0556 X 5	32
6	6.63	6	303-0663 X 6	38
6	6.90 - 7.10	6	303-0690 X 6	40
8	8.63	8	303-0863 X 8	50
8	9.05 - 9.30	8	303-0905 X 8	52
10	10.75	10	303-1075 X 10	58
10	11.10 - 11.40	10	303-1110 X 10	61
12	12.75	12	303-1275 X 12	78
12	13.20 - 13.50	12	303-1320 X 12	84
14	14.00	14	303-1400 X 14	90
14	15.30	14	303-1530 X 14	110
14	15.65	14	303-1565 X 14	110
16	16.00	16	303-1600 X 16	113
16	17.40	16	303-1740 X 16	130
16	17.80	16	303-1780 X 16	137
18	18.00	18	303-1800 X 18	137
18	19.50	18	303-1950 X 18	144
18	19.92	18	303-1992 X 18	144
20	20.00	20	303-2000 X 20	158
20	21.60	20	303-2160 X 20	162
20	22.06	20	303-2206 X 20	162
24	24.00	24	303-2400 X 24	192
24	25.80	24	303-2580 X 24	220
24	26.32	24	303-2632 X 24	220
30	32.00	30	303-3200 X 30	442
36	38.30	36	303-3830 X 36	602
42	44.50	42	303-4450 X 42	771
48	50.80	48	303-5080 X 48	885

Other sizes available upon request.

Epoxy coating and stainless steel bolts are available as an extra.

NOTE: Applications in which pipe may move out of the coupling, correct anchorage of the pipe must be provided.



JCM 304 Fabricated Reducing Flanged Coupling Adapters

The JCM 304 Reducing Flanged Coupling Adapter is similar in construction to the JCM 303 FCA but has a reducer or increaser combination of coupling and flange.



HOW TO ORDER

- | | |
|------------------------------------------------------|--------------------------------------------------------------------------------------|
| 1. Determine pipe O.D. and flange size to be joined. | 3. Insert desired flange size to complete catalog number. |
| 2. Select proper coupling O.D. catalog number. | EXAMPLE:
To join 16" O.D. steel pipe to 4" Class D flange, order:
304-1600 x 4 |

304 FABRICATED FLANGED COUPLING ADAPTERS

NOM. PIPE SIZE (IN.)	PIPE O.D. RANGE (IN.)	CATALOG NUMBER	(X) ADD FLANGE SIZE
4	4.50	304-0450	X
4	4.80 - 5.00	304-0480	X
5	5.56	304-0556	X
6	6.63	304-0663	X
6	6.90 - 7.10	304-0690	X
8	8.63	304-0863	X
8	9.05 - 9.30	304-0905	X
10	10.75	304-1075	X
10	11.10 - 11.40	304-1110	X
12	12.75	304-1275	X
12	13.20 - 13.50	304-1320	X
14	14.00	304-1400	X
14	15.30	304-1530	X
14	15.65	304-1565	X
16	16.00	304-1600	X
16	17.40	304-1740	X
16	17.80	304-1780	X
18	18.00	304-1800	X
18	19.50	304-1950	X
18	19.92	304-1992	X
20	20.00	304-2000	X
20	21.60	304-2160	X
20	22.06	304-2206	X
24	24.00	304-2400	X
24	25.80	304-2580	X
24	26.32	304-2632	X

STANDARD AVAILABLE FLANGE SIZES
2
3
4
6
8
10
12
14
16
18
20
24

FLANGES:
Standard 125# Class D

Other Flanges available upon request.

OTHER SIZES AVAILABLE UPON REQUEST.

NOTE: Applications in which pipe may move out of the coupling, correct anchorage of the pipe must be provided.



JCM 306 Fabricated Flanged Coupling Adapters

The JCM 306 Fabricated Flanged Coupling Adapter combine the versatile JCM Ductile Iron Coupling system with a fabricated flanged end to provide a fitting which allows for pipe misalignment, less critical pipe end preparation and ease of equipment installation and removal. The 306 FCAs are easily adapted from one type of pipe to another with the simple JCM Transition Gasket system. These FCAs simplify installations on larger A/C pipe and are available in the hard to find 10" and 12" sizes.



MATERIAL SPECIFICATIONS JCM 306 & 307 FCA:

- Body/follower:** Ductile Iron ASTM A536
- Flanged End:** Fabricated ASTM A285 Grade C Steel with AWWA C207 Class D Flange, with ANSI 150 lb. drilling.
- Gaskets:** Styrene-Butadiene Rubber (SBR) has good physical properties. Compounded for use with water, salt solutions, mild acids and bases; has excellent abrasion resistance. Per ASTM D-2000. Standard temperature range from -40° to 150°F (-40° to 65° C) constant, maximum intermittent 180° F (82° C). For applications on high temperatures or chemical pipelines, contact JCM Industries Technical Services. The material is not recommended for use on oil, ozone or weather resistant applications.
- Bolts:** Corrosion resistant, high strength low alloy bolts and nuts (AWWA C-111, ANSI A21.11). Flanged bolts not furnished. Optional Stainless Steel, 18-8 Type 304.
- Finish:** Heavy coating of corrosion resistant metal primer. Optional Fusion applied Epoxy Coating available.

JCM Industries bolted couplings meet or exceed the ANSI/AWWA C-219 Standard as applicable.

306 FLANGED COUPLING ADAPTERS

NOM. PIPE SIZE (IN.)	COUPLING O.D. RANGE (IN.)	NOM. FLANGE SIZE	CATALOG NUMBER	OVERALL LENGTH (IN.)	APPR. WT. EACH (LBS.)
3	3.50	3	306-0350 X 3	12	32
	3.80 - 4.17	3	306-0396 X 3	12	32
4	4.50	4	306-0450 X 4	12	42
	4.80 - 5.10	4	306-0480 X 4	12	42
	5.10 - 5.40	4	306-0535 X 4	12	46
6	6.63	6	306-0663 X 6	12	59
	6.90 - 7.20	6	306-0690 X 6	12	59
	7.20 - 7.55	6	306-0740 X 6	12	68
8	8.63	8	306-0863 X 8	12	86
	9.05 - 9.40	8	306-0905 X 8	12	86
	9.40 - 9.75	8	306-0960 X 8	12	91
10	10.75	10	306-1075 X 10	12	115
	11.10 - 11.40	10	306-1110 X 10	12	115
	11.60 - 12.05	10	306-1200 X 10	12	129
12	12.75	12	306-1275 X 12	12	163
	13.20 - 13.50	12	306-1320 X 12	12	163
	13.92 - 14.40	12	306-1420 X 12	12	175

Larger sizes available upon request.

Epoxy coating and stainless steel bolts available as an extra.

Integral retainer set screws are available as an extra. Add (R) to end of catalog number. Price on application.

NOTE: Restraining set screws are not for use on Asbestos Cement, HDPE or PVC pipe.

NOTE: Applications in which pipe may move out of the coupling, proper anchorage of the pipe must be provided.



JCM 307 Fabricated Reducing Flanged Coupling Adapters

The JCM 307 Reducing Fabricated Flanged Coupling Adapter combines the versatile JCM Ductile Iron Coupling system with an increaser or reducer fabricated flanged end to provide a fitting which allows for pipe misalignment, less critical pipe end preparation and ease of equipment installation and removal. The 307 FCAs are easily adapted from one type of pipe to another with the simple JCM Transition Gasket system. These FCAs simplify installations on larger A/C pipe and are available in the hard to find 10" and 12" sizes.



307 FLANGED REDUCING COUPLING ADAPTERS

NOM. PIPE SIZE (IN.)	COUPLING O.D. RANGE (IN.)	CATALOG NUMBER	(X) ADD REQUIRED FLANGE SIZE	OVERALL LENGTH (IN.)
3	3.50	307-0350	X	12
	3.80 - 4.17	307-0396	X	12
4	4.50	307-0450	X	12
	4.80 - 5.10	307-0480	X	12
	5.10 - 5.40	307-0535	X	12
6	6.63	307-0663	X	12
	6.90 - 7.20	307-0690	X	12
	7.20 - 7.55	307-0740	X	12
8	8.63	307-0863	X	12
	9.05 - 9.40	307-0905	X	12
	9.40 - 9.75	307-0960	X	12
10	10.75	307-1075	X	12
	11.10 - 11.40	307-1110	X	12
	11.60 - 12.05	307-1200	X	12
12	12.75	307-1275	X	12
	13.20 - 13.50	307-1320	X	12
	13.92 - 14.40	307-1420	X	12

Larger sizes available upon request

Epoxy coating and stainless steel bolts available.

Integral retainer set screws are available as an extra. Add (R) to end of catalog number. Price on application.

NOTE: Restraining set screws are not for use on Asbestos Cement, HDPE or PVC pipe.

NOTE: Applications in which pipe may move out of the coupling, proper anchorage of the pipe must be provided.



JCM 309 Dismantling Joints

Dismantling joints simplify installations and replacement of flanged fittings in retrofitting applications. JCM 309 Dismantling Joints provide the solution for adding, repairing or replacing flanged fittings within a flanged pipe system. Adjustable, slip joint design accommodates either wide gaps or close quarter installations and eliminates the need for precise measurements between flange connections.

Available in sizes 2" and larger, for ductile iron or flanged steel pipe systems.

Standard flanges AWWA C207 Class D Flange with 150 lb. drilling. Other flanges available upon request.

Restraint system available upon request.

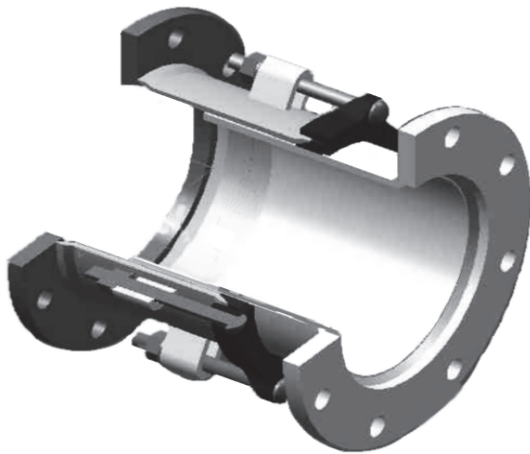

JCM 309 Dismantling Joints Offer:

Greater adjustment ability speeds installations and reduce system downtime.







Accommodates future modifications and system adjustments.

Simplifies installation - one fitting integrates into system operating as flanged adapter and an adjustable spool piece.

MATERIAL SPECIFICATIONS - JCM 309 DISMANTLING JOINT

- Flanged Adapter Body:** ASTM A513, ASME SA 675 GR60, or Ductile Iron ASTM A536.
- Follower Flange:** AISI C1012, ASME SA36, or Ductile Iron ASTM A536.
- Flange:** AWWA C207 Class D Flange, 150 lb. drilling. Optional flanges available.
- Flange Extension:** Schedule 40 Steel Pipe
 - Bolts:** Corrosion resistant, high strength low alloy (AWWA C-111, ANSI 21.11). Optional Stainless Steel 18-8 Type 304 available.
 - Finish:** Heavy coat of corrosion resistant metal primer. Optional Fusion Applied Epoxy Coating available.
 - Gasket:** Specially compounded new rubber polymer for superior shelf life and resistance to permanent set. Recommended for water, salt solutions, mild acids, bases.

JCM Service Saddle Selection Guide

PRODUCT	NUMBER & TYPE	APPLICATION, SIZES AND ADDITIONAL INFORMATION
	402 Double Strap Service Saddle	Large outlet heavy duty double strap saddle. Sizes 2" - 24" with outlet sizes 1/2" - 2-1/2".
	408 Coated Double Strap Service Saddle	Coated saddle with electro-galvanized straps. Sizes 2" - 24" with outlet sizes 1/2" - 2-1/2".
	401 Single Strap Service Saddle	Single strap saddle with wrap around design utilizes single electro-galvanized strap. Sizes 2" - 12" with outlet sizes 1/2" - 2-1/2".
	407 Coated Single Strap Service Saddle	Coated saddle with electro-galvanized strap. Sizes 2" - 12" with outlet sizes 1/2" - 2-1/2".
	403 Wide Body Service Saddle	Single strap saddle with stainless steel band especially recommended for pipe requiring extra reinforcement. Sizes 2" - 12" with outlet sizes 1/2" - 2-1/2".
	405 Coated Wide Body Service Saddle	Single strap saddle, stainless steel band and fusion plastic coating for hot and corrosive soils. Sizes 2" - 12" with outlet sizes 1/2" - 2-1/2".
	404 Service Saddle with Double Stainless Steel Straps	Heavy duty saddle with two wide stainless steel straps for extra pipe support and corrosion resistance. Sizes 2" - 24" with outlet sizes 1/2" - 2-1/2".
	406 Coated Service Saddle with Double Stainless Steel Straps	Heavy duty saddle with two wide stainless steel straps and fusion plastic coating for hot and corrosive soils. Sizes 2" - 24" with outlet sizes 1/2" - 2-1/2".
	418 Threaded Outlet Tap Sleeve	For taps and connections on larger pipe, thin wall pipe and pipe requiring extra reinforcement. Sizes 4" - 60" with outlet sizes 1/2" - 4".
	438 All Stainless Threaded Outlet Tap Slv	All stainless steel construction, especially recommended for aggressive or corrosive environments. Sizes 4" - 60" with outlet sizes 1/2" - 4"
	425 Service Saddle for Concrete Steel Cylinder Pipe	For 3/4" - 2" taps and connections in 16" - 48" concrete steel cylinder pipe. Available for standard and embedded cylinder pipe.
	502 Stainless Steel Service Saddle	Stainless Steel Service Saddle of heavy duty construction and balanced bolt design for pipe support, bolt torque and gasket compression. Recommended for PS PVC, C-900 PVC, Ductile Iron, Cast Iron, Steel and other types of pipe. Not recommended for High Density Polyethylene Pipe (HDPE).

JCM Service Saddles

JCM Service Saddles provide a quick, dependable means of tapping pipe for branch connections of 1/2" through 2-1/2". Use of economical JCM Service Saddles eliminate problems common to direct taps, such as leaking threads or split pipe, and reinforces the critical connection.

JCM Service Saddles are designed for maximum safety and performance. The wrap around design, wide skirt and wide straps support and reinforce the pipe while providing excellent stability to the saddle. The heavy duty design of these saddles provides strength and mass for long term service.

High pressure performance is assured by the broad, pressure activated gasket. Permanently set in a retaining cavity, the contoured gasket produces a positive initial seal which increases with increase in line pressure.

The JCM 402, 404, 406, 408 saddles, with their wide bodies and large sealed outlet areas, provide an excellent means of repairing holes, pin holes and leaking 3/4" and 1" direct taps.

DESIGNED FOR SAFETY AND PERFORMANCE

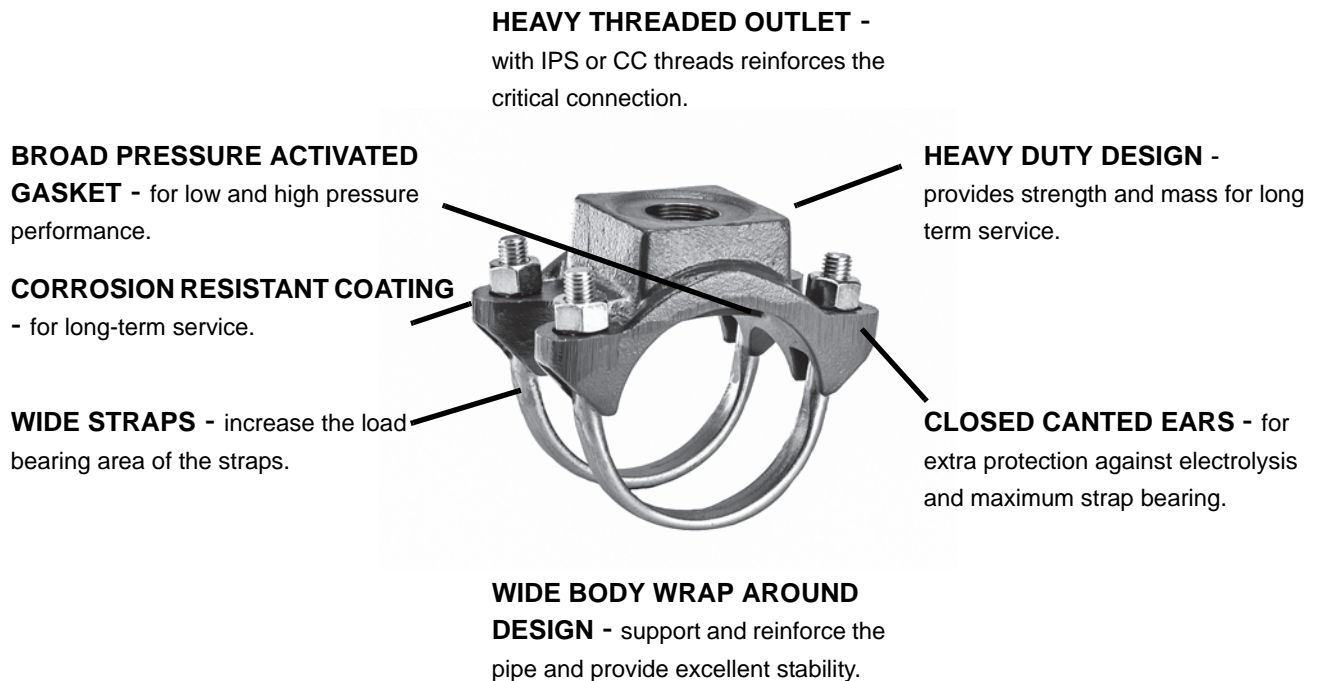

MATERIAL SPECIFICATIONS - JCM SERVICE SADDLES

- Body:** Ductile Iron ASTM A536
- Straps:** **Models 401, 402, 407, 408** - Electro Galvanized Steel
Models 403, 404, 405, 406 - Bands, Bolts, Nuts and Washers are 18-8 Type 304 Stainless Steel.
- Gasket:** Nitrile Butadiene Rubber (NBR, Buna-N) per ASTM D2000. Molded virgin rubber with a pressure activated hydromechanical design. Gasket is bonded into a cavity for internal and external retention. Gasket temperature range -40°F to 212°F (-40°C - 100°C) Gasket suitable for water, salt solutions, mild acids, bases, and sewage. Optional EPDM gasket available.
- Finish:** **Models 401, 402, 403, 404** - Standard Shop Coat Primer: Heavy coat of corrosion resistant metal primer.
Models 405, 406, 407, 408 - Fusion Plastic Coating: fusion bonded, high density blue plastic coating, 12 mils minimum thickness with a dielectric strength of over 12,000 volts.

JCM Service Saddles - Single Strap
JCM 401 Single Strap Service Saddle with Electro Galvanized Strap
JCM 403 Wide Body Service Saddle with Stainless Steel Strap

The **JCM 401 Single Strap Service Saddle** is designed for maximum safety, performance and economy. The wrap around design, broad, pressure activated gasket and corrosion electro galvanized steel strap provide for ease of installation, high pressure performance and a long service life.

The **JCM 403 Wide Body Service Saddle** utilizes an extra wide stainless steel strap with the broad, wrap around single strap saddle body to provide extra support and stability as well as to eliminate point loading. The 403 is especially recommended for PVC, thin wall pipe and pipe sensitive to point loading.

NOM. PIPE SIZE (IN.)	PIPE O.D. RANGE (IN.)	APPR WT. EACH (LBS.)	CTN. QTY.	JCM 401 SERVICE SADDLE	JCM 403 SERVICES SADDLE
				CATALOG NUMBER X TAP CODE	CATALOG NUMBER X TAP CODE
2	2.35 - 2.63	2.5	12	*401-0238 X --	*403-0238 X --
2-1/2	2.70 - 3.13	3.0	12	*401-0288 X --	*403-0288 X --
3	3.25 - 3.50	3.0	12	*401-0350 X --	*403-0350 X --
3 - 4	3.80 - 4.13	3.0	12	N/A	*403-0413 X --
4	4.25 - 4.50	4.5	10	401-0450 X --	403-0450 X --
4	4.50 - 4.80	4.5	10	401-0480 X --	403-0480 X --
4	4.74 - 5.45	4.5	10	*401-0545 X --	*403-0545 X --
6	6.50 - 6.63	4.5	10	401-0663 X --	403-0663 X --
6	6.63 - 6.90	4.5	10	401-0690 X --	403-0690 X --
6	6.84 - 7.60	4.5	10	401-0745 X --	403-0745 X --
8	8.50 - 8.63	5.0	10	401-0863 X --	403-0863 X --
8	8.63 - 9.05	5.0	10	401-0905 X --	403-0905 X --
8	8.99 - 9.79	5.0	10	401-0963 X --	403-0963 X --
10	10.60 - 10.75	5.5	6	401-1075 X --	403-1075 X --
10	10.75 - 11.10	5.5	6	401-1110 X --	403-1110 X --
10	11.10 - 11.40	5.5	6	401-1140 X --	403-1140 X --
10	11.00 - 12.25	5.5	6	401-1225 X --	403-1225 X --
12	12.60 - 12.75	6.0	6	401-1275 X --	403-1275 X --
12	12.75 - 13.20	6.0	6	401-1320 X --	403-1320 X --
12	12.75 - 13.50	6.0	6	401-1350 X --	403-1350 X --
12	13.10 - 14.38	6.0	4	401-1426 X --	403-1426 X --

*Not available in 1-1/4, 1-1/2, 2, 2-1/2 Outlets

HOW TO ORDER

1. Determine O.D. of pipe, outlet size and thread type.
2. Select desired saddle type and tap order code.
3. Look under saddle listing to determine order number. Add tap code after base catalog number.

Example: For 6" C.I. Pipe with O.D. of 6.90 with 1" IP thread, order: 401-0745 x 08IP. For stainless steel strap, order: 403-0745 x 08IP.

OUTLET SIZES	TAP CODES IP	TAP CODES CC
1/2"	04	--
3/4"	06	07
1"	08	09
1-1/4"	10	11
1-1/2"	12	13
2"	14	15
2-1/2"	16	--

JCM
401
407



JCM
403
405



JCM 403/405
Strap Service
Saddles with
outlets
1-1/4" - 2-1/2"



JCM Coated Service Saddles - Single Strap

JCM 405 Single Strap Service Saddle with Stainless Steel Strap

JCM 407 Wide Body Service Saddle with Electro Galvanized Strap

The **JCM 405 Coated Wide Body Service Saddle with Stainless Steel Strap** is designed for maximum safety and performance in tapping all types of pipe in hot and corrosive soils. Extra corrosion resistance is built into this saddle with the heavy resilient plastic coating which is fusion applied to the saddle body.

The **JCM 407 Coated Wide Body Service Saddle** utilizes an electro galvanized steel strap with the broad, wrap around single strap saddle body. The 407 features the extra corrosion resistance is built into this saddle with the heavy resilient plastic coating which is fusion applied to the saddle body.

NOM. PIPE SIZE (IN.)	PIPE O.D. RANGE (IN.)	APPR WT. EACH (LBS.)	CTN. QTY.	JCM 405 SERVICE SADDLE	JCM 407 SERVICE SADDLE
				CATALOG NUMBER X TAP CODE	CATALOG NUMBER X TAP CODE
2	2.35 - 2.63	2.5	12	*405-0238 X --	*407-0238 X --
2-1/2	2.70 - 3.13	3.0	12	*405-0288 X --	*407-0288 X --
3	3.25 - 3.50	3.0	12	*405-0350 X --	*407-0350 X --
3 - 4	3.80 - 4.13	3.0	12	*405-0413 X --	N/A
4	4.25 - 4.50	4.5	10	405-0450 X --	*407-0450 X --
4	4.50 - 4.80	4.5	10	405-0480 X --	407-0480 X --
4	4.74 - 5.45	4.5	10	*405-0545 X --	*407-0545 X --
6	6.50 - 6.63	4.5	10	405-0663 X --	407-0663 X --
6	6.63 - 6.90	4.5	10	405-0690 X --	407-0690 X --
6	6.84 - 7.60	4.5	10	405-0745 X --	407-0745 X --
8	8.50 - 8.63	5.0	10	405-0863 X --	407-0863 X --
8	8.63 - 9.05	5.0	10	405-0905 X --	407-0905 X --
8	8.99 - 9.79	5.0	10	405-0963 X --	407-0963 X --
10	10.60 - 10.75	5.5	6	405-1075 X --	407-1075 X --
10	10.75 - 11.10	5.5	6	405-1110 X --	407-1110 X --
10	11.10 - 11.40	5.5	6	405-1140 X --	407-1140 X --
10	11.00 - 12.25	5.5	6	405-1225 X --	407-1225 X --
12	12.60 - 12.75	6.0	6	405-1275 X --	407-1275 X --
12	12.75 - 13.20	6.0	6	405-1320 X --	407-1320 X --
12	12.75 - 13.50	6.0	6	405-1350 X --	407-1350 X --
12	13.10 - 14.38	6.0	4	405-1426 X --	407-1426 X --

*Not available in 1-1/4, 1-1/2, 2, 2-1/2 Outlets

HOW TO ORDER

1. Determine O.D. of pipe, outlet size and thread type.
2. Select desired saddle type and tap order code.
3. Look under saddle listing to determine order number. Add tap code after base catalog number.

Example: For 6" C.I. Pipe with O.D. of 6.90 with 1" IP thread, order: 405-0745 x 08IP. For electro galvanized strap, order: 407-0745 x 08IP.

OUTLET SIZES	TAP CODES IP	TAP CODES CC
1/2"	04	--
3/4"	06	07
1"	08	09
1-1/4"	10	11
1-1/2"	12	13
2"	14	15
2-1/2"	16	--

JCM
401
407



JCM
403
405



JCM 403/405
Strap Service
Saddles with
outlets
1-1/4" - 2-1/2"



JCM Service Saddles - Double Strap
JCM 402 Double Strap Service Saddle
JCM 404 Service Saddle with Double Stainless Steel Straps

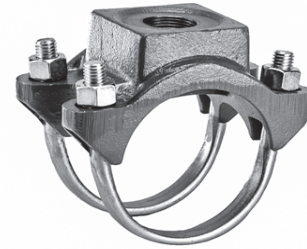

The JCM 402 and 404 utilize the heavy duty double strap saddle body with corrosion resistant shop coat primer. The 402 is furnished with two electro galvanized straps sizes 2" -12", on sizes 15.20 and larger, the 402 incorporates two fabricated, wide electro galvanized steel straps. The 404 is furnished with two wide stainless steel straps.

NOM. PIPE SIZE (IN.)	PIPE O.D. RANGE (IN.)	WT. EA. LBS.	CTN. QTY.	JCM 402 SERVICE SADDLE	JCM 404 SERVICE SADDLE
				BASE CATALOG NUMBER 402-R X ADD TAP CODE	BASE CATALOG NUMBER X ADD TAP CODE
2	2.35 - 2.63	4	6	*402-0238 X --	*404-0238 X --
2-1/2	2.70 - 3.13	5	6	*402-0288 X --	*404-0288 X --
3	3.25 - 3.50	7	6	**402-0350 X --	**404-0350 X --
3 - 4	3.80 - 4.13	7	6	**402-0413 X --	**404-0413 X --
4	4.25 - 4.50	10	4	402-0450 X --	404-0450 X --
4	4.50 - 4.80	10	4	402-0480 X --	404-0480 X --
4	4.74 - 5.45	10	4	402-0545 X --	404-0545 X --
5	5.50 - 5.56	10	4	402-0556 X --	404-0556 X --
6	6.50 - 6.63	10	4	402-0663 X --	404-0663 X --
6	6.63 - 6.90	10	4	402-0690 X --	404-0690 X --
6	6.84 - 7.60	10	4	402-0745 X --	404-0745 X --
8	8.50 - 8.63	12	4	402-0863 X --	404-0863 X --
8	8.63 - 9.05	13	4	402-0905 X --	404-0905 X --
8	8.99 - 9.79	13	4	402-0963 X --	404-0963 X --
10	10.60 - 10.75	14	3	402-1075 X --	404-1075 X --
10	10.75 - 11.10	14	3	402-1110 X --	404-1110 X --
10	11.10 - 11.40	14	3	402-1140 X --	404-1140 X --
10	11.00 - 12.25	14	3	402-1225 X --	404-1225 X --
12	12.75 - 13.20	16	3	402-1320 X --	404-1320 X --
12	12.75 - 13.50	16	3	402-1350 X --	404-1350 X --
12	13.10 - 14.38	16	2	402-1426 X --	404-1426 X --
12 - 14	14.00 - 15.20	15	1	402-1520 X --	404-1520 X --
14	C-905 15.30	15	1	402-1530 X --	404-1530 X --
14 - 16	15.20 - 16.60	15	1	402-1660 X --	404-1660 X --
16	C-905 17.40	16	1	402-1740 X --	404-1740 X --
16 - 18	17.30 - 18.88	16	1	402-1888 X --	404-1888 X --
18	C-905 19.50	18	1	402-1950 X --	404-1950 X --
18 - 20	19.00 - 20.50	18	1	402-2050 X --	404-2050 X --
18 - 20	20.50 - 21.50	18	1	402-2125 X --	404-2125 X --
20	C-905 21.60	20	1	402-2160 X --	404-2160 X --
20	21.35 - 22.60	20	1	402-2260 X --	404-2260 X --
20	22.50 - 23.70	20	1	402-2370 X --	404-2370 X --
24	23.75 - 25.25	20	1	402-2525 X --	404-2525 X --
24	C-905 25.80	20	1	402-2580 X --	404-2580 X --
24	25.50 - 26.50	20	1	402-2650 X --	404-2650 X --

OUTLET SIZES	TAP CODES IP	TAP CODES CC
1/2"	04	--
3/4"	06	07
1"	08	09
1-1/4"	10	11
1-1/2"	12	13
2"	14	15
2-1/2"	16	--

*Outlets Not available in 1-1/4", 1-1/2", 2" or 2-1/2"
 **Outlets Not available in 2" CC or 2-1/2" IP

HOW TO ORDER

- Determine O.D. of pipe, outlet size and thread type.
- Select desired saddle type and tap order code.
- Look under saddle listing to determine order number. Add tap code after base catalog number.
 Example: For 6" C.I. Pipe with O.D. of 6.90 with 1" IP thread, order: 402-0745 x 08IP.
 For stainless steel straps, order: 404-0745 x08IP

JCM Coated Service Saddles - Double Straps
JCM 406 Coated Saddle - Double Stainless Steel Straps
JCM 408 Coated Saddle - Electro Galvanized Straps

The JCM 406 and 408 utilize the heavy duty double strap saddle body with a fusion applied, heavy resilient plastic coating. The JCM 406 is furnished with two stainless steel straps. The model 408 is furnished with two electro galvanized steel straps.



NOM. PIPE SIZE (IN.)	PIPE O.D. RANGE (IN.)	WT. EA. LBS.	CTN. QTY.	JCM 406 SERVICE SADDLE	JCM 408 SERVICE SADDLE
				BASE CATALOG NUMBER X ADD TAP CODE	BASE CATALOG NUMBER X ADD TAP CODE
2	2.35 - 2.63	4	6	*406-0238 X --	*408-0238 X --
2-1/2	2.70 - 3.13	5	6	*406-0288 X --	*408-0288 X --
3	3.25 - 3.50	7	6	**406-0350 X --	**408-0350 X --
3 - 4	3.80 - 4.13	7	6	**406-0413 X --	**408-0413 X --
4	4.25 - 4.50	10	4	406-0450 X --	408-0450 X --
4	4.50 - 4.80	10	4	406-0480 X --	408-0480 X --
4	4.74 - 5.45	10	4	406-0545 X --	408-0545 X --
5	5.50 - 5.56	10	4	406-0556 X --	408-0556 X --
6	6.50 - 6.63	10	4	406-0663 X --	408-0663 X --
6	6.63 - 6.90	10	4	406-0690 X --	408-0690 X --
6	6.84 - 7.60	10	4	406-0745 X --	408-0745 X --
8	8.50 - 8.63	12	4	406-0863 X --	408-0863 X --
8	8.63 - 9.05	13	4	406-0905 X --	408-0905 X --
8	8.99 - 9.79	13	4	406-0963 X --	408-0963 X --
10	10.60 - 10.75	14	3	406-1075 X --	408-1075 X --
10	10.75 - 11.10	14	3	406-1110 X --	408-1110 X --
10	11.10 - 11.40	14	3	406-1140 X --	408-1140 X --
10	11.00 - 12.25	14	3	406-1225 X --	408-1225 X --
12	12.75 - 13.20	16	3	406-1320 X --	408-1320 X --
12	12.75 - 13.50	16	3	406-1350 X --	408-1350 X --
12	13.10 - 14.38	16	2	406-1426 X --	408-1426 X --
12 - 14	14.00 - 15.20	15	1	406-1520 X --	408-1520 X --
14	C-905 15.30	15	1	406-1530 X --	408-1530 X --
14 - 16	15.20 - 16.60	15	1	406-1660 X --	408-1660 X --
16	C-905 17.40	16	1	406-1740 X --	408-1740 X --
16 - 18	17.30 - 18.88	16	1	406-1888 X --	408-1888 X --
18	C-905 19.50	18	1	406-1950 X --	408-1950 X --
18 - 20	19.00 - 20.50	18	1	406-2050 X --	408-2050 X --
18 - 20	20.50 - 21.50	18	1	406-2125 X --	408-2125 X --
20	C-905 21.60	20	1	406-2160 X --	408-2160 X --
20	21.35 - 22.60	20	1	406-2260 X --	408-2260 X --
20	22.50 - 23.70	20	1	406-2370 X --	408-2370 X --
24	23.75 - 25.25	20	1	406-2525 X --	408-2525 X --
24	C-905 25.80	20	1	406-2580 X --	408-2580 X --
24	25.50 - 26.50	20	1	406-2650 X --	408-2650 X --

OUTLET SIZES	TAP CODES IP	TAP CODES CC
1/2"	04	--
3/4"	06	07
1"	08	09
1-1/4"	10	11
1-1/2"	12	13
2"	14	15
2-1/2"	16	--

*Outlets Not available in 1-1/4", 1-1/2", 2" or 2-1/2"

**Outlets Not available in 2" CC or 2-1/2" IP

HOW TO ORDER

1. Determine O.D. of pipe, outlet size and thread type.
2. Select desired saddle type and tap order code.
3. Look under saddle listing to determine order number. Add tap code after base catalog number.

Example: For 6" C.I. Pipe with O.D. of 6.90 with 1" IP thread, order: 406-0745 x 08IP.

For electro galvanized straps, order: 408-0745 x08IP

JCM 425 Service Saddle for Concrete Steel Cylinder Pipe

Service Saddle for 3/4" through 2" Taps and Connections on Concrete Steel Cylinder Pipe, Reinforced Concrete Pipe, Large Diameter Cast Iron and Ductile Iron.

The JCM 425 Service Saddle is specifically designed for making safe, dependable taps into Concrete Steel Cylinder Pipe and Concrete Coated Steel Pipe. The threaded outlet, available in sizes 3/4" through 2" IP or CC, provides critical reinforcement to branch connections for service lines. These saddles can also be used to install air and vacuum valves, pitot tubes, injection lines and other equipment.

The following are important features and benefits this saddle offers:

*Provides critical reinforcement of pipe prior to removal of the prestress wire from the outlet area. This is a required feature to maintain pipe integrity on larger taps and many small taps. The separate bolt-in outlet makes possible this essential installation step.

*The adjustable outlet accommodates variation in concrete coating from no coating to a thickness of 1-1/8". Special outlets are available for embedded cylinder pipe and thicker coatings of concrete.

*High and low pressure performance are assured by a broad, pressure-activated gasket. Permanently set in a retaining cavity, the contoured gasket produces a positive initial seal which increases with increases in line pressure.



For coating thickness of 1-1/8" or less.



For coating thickness of over 1-1/8".
Outlet for Embedded Cylinder Pipe. Prices upon request.

425 SERVICE SADDLE FOR CONCRETE STEEL CYLINDER PIPE

NOM. PIPE SIZE (IN.)	CONCRETE O.D. RANGE (IN.)	STEEL CYLINDER O.D.* RANGE (IN.)	CATALOG NUMBER X TAP CODE	APPROX. WT. EA. (LBS.)
16	19.25 - 20.15	17.25 - 20.15	425-2015 X --	50
18	21.75 - 22.75	19.50 - 22.75	425-2275 X --	50
20	23.64 - 24.65	21.70 - 24.65	425-2465 X --	50
24	27.62 - 29.15	25.75 - 29.15	425-2915 X --	50
30	33.88 - 35.75	31.88 - 35.75	425-3575 X --	60
36	39.75 - 41.00	37.75 - 41.00	425-4100 X --	70
36	41.50 - 43.00	40.50 - 43.00	425-4300 X --	70
42	45.75 - 47.25	43.75 - 47.25	425-4725 X --	85
42	48.00 - 49.50	46.00 - 49.50	425-4950 X --	85
48	51.50 - 53.00	49.50 - 53.00	425-5300 X --	100
48	55.38 - 56.50	53.40 - 56.50	425-5650 X --	100

OUTLET TAP CODES		
OUTLET SIZE	IP THREAD	CC THREAD
3/4"	06	07
1"	08	09
1-1/4"	10	11
1-1/2"	12	13
2"	14	15



*Longer outlet bolts are required for making taps on pipe with less than 1/4" coating

MATERIAL SPECIFICATIONS - JCM 425 SERVICE SADDLE FOR CONCRETE STEEL CYLINDER PIPE

- Body, Outlet, Washers:** Ductile Iron ASTM A536
- Outlet Bolts:** Corrosion resistant, high strength low alloy (AWWA C-111, ANSI A21.11)
- Straps:** Steel per ASTM A-36. Optional Stainless Steel 18-8 Type 304.
- Gasket:** Buna-N compounded for use with water, salt solutions, mild acids, bases, gas.
- Coating:** Heavy coating of corrosion resistant shop coat primer. Optional Fusion Epoxy Coating available.

Grout Diapers for Service Saddles

These diapers make the recommended grouting of the service saddle a very quick procedure. Diapers are 11" wide with two 5/8" straps and are constructed of one layer of Tytar backed by a 6 mil ply of polyethylene film. Order by pipe size.

GROUT DIAPERS

SADDLE SIZE
16" - 24"
30" - 36"
42" - 48"

JCM Model 502 Stainless Steel Service Saddle.

The JCM 502 Stainless Steel Service Saddle is engineered with the pipe in mind. Heavy duty construction with balanced bolt design provides the pipe support, bolt torque and gasket compression necessary for a successful, long term saddle installation.

Recommended for PS PVC, C-900 PVC, Ductile Iron, Cast Iron, Steel and other types of pipe. Not recommended for High Density Polyethylene Pipe (HDPE).

Durable bolting unit comprised of fabricated, interlocking finger lugs, 5/8" stainless steel studs, structurally designed lift bar and welded plates join together to provide torque values to efficiently compress the gasket without damage to the pipe wall.

Nuts furnished with anti-seize coating to prevent galling of hardware during installation.

Heavyweight threaded stainless steel outlet is available with IP/NPT or CC threads. Meets ANSI/AWWA C800

JCM 502 Service Saddle pressure rating:
200 PSI Working Pressure
225 PSI Test Pressure

Standard 8" width through all sizes provides maximum pipe support.

Environmentally friendly passivation of the 304 Stainless Steel fabrication ensures a return to the stainless steel's natural corrosion resistant state to last the life of the pipeline. Per ASTM A380.

Raised outlet gasket with molded channels for maximum watertight contact between fitting and pipe wall.

Full circumferential stainless steel band provides utmost corrosion resistance and support to the pipe wall both at the tap location and the backside of the pipe wall. Per ASTM A240.

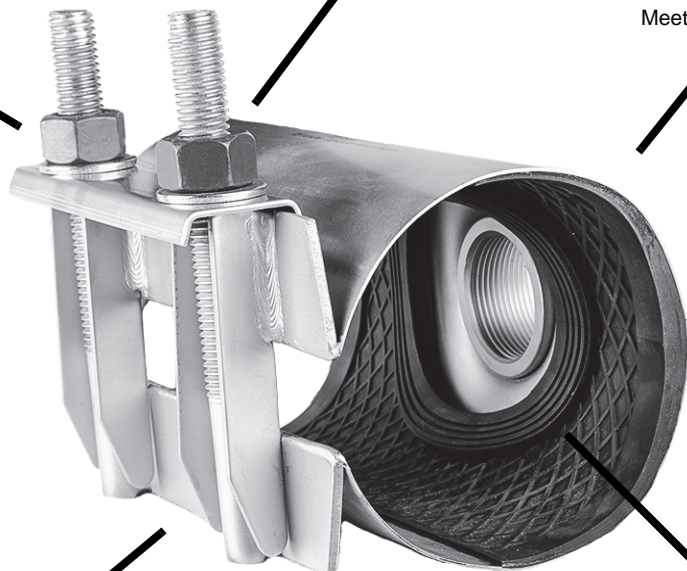

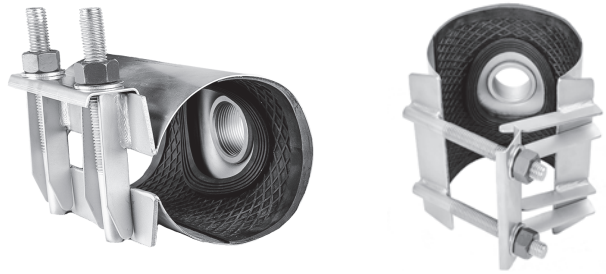

JCM 502 Stainless Steel Service Saddles
All 304 Stainless Steel Construction

Nominal Pipe Size	Range (Inches)	Saddle Number x Outlet Order Code	Saddle Width (Inches)	Available Outlets 3/4" & 1"	Available Outlets 1-1/4" - 2"	Approx. Weight (Lbs)
2"	2.38	502-0238 x --	8"	-	N/A	2.0
2-1/2"	2.63 - 2.88	502-0288 x --	8"	-	N/A	2.5
3	3.13 - 3.50	502-0350 x --	8"	-	N/A	3.0
3 - 4	3.80 - 4.13	502-0413 x --	8"	-	N/A	3.5
4	4.50 - 4.80 4.80 - 5.20	502-0480 x -- 502-0500 x --	8"	-	-	4.3
6	6.63 - 6.90 6.90 - 7.30	502-0690 x -- 502-0710 x --	8"	-	-	6.0
8	8.63 - 9.05 9.05 - 9.45	502-0905 x -- 502-0940 x --	8"	-	-	8.5
10	10.75 - 11.10 11.70 - 12.10	502-1110 x -- 502-1175 x --	8"	-	-	10.0
12	12.75 - 13.20 14.00 - 14.40	502-1320 x -- 502-1400 x --	8"	-	-	13.0

Outlet Size	IP Order Code	CC Order Code
3/4"	06	07
1"	08	09
1-1/4"	10	11
1-1/2"	12	13
2"	14	15

502 Saddle Number	Outlet Sizes Available	IP/CC
502-0238 thru 502-0413	3/4" - 1"	IP/CC
502-0480 thru 502-1320	3/4" thru 2"	IP/CC

MATERIAL SPECIFICATIONS - JCM 502 STAINLESS STEEL SERVICE SADDLE

- Band:** 18-8 Type 304 Stainless Steel. Per ASTM A240
- Outlet:** 18-8 Type 304 Stainless Steel Threaded Half Coupling. Meets ANSI/AWWA C800 as applicable.
- Bolting Assembly:** 18-8 Type 304 Stainless Steel. Per ASTM A240
- Lift Bar:** 18-8 Type 304 Stainless Steel. Per ASTM A240
- Fasteners:** 18-8 Type 304 Stainless Steel.
- Gasket:** EPDM - excellent resistance to aging factors including ozone, oxygen, elevated temperatures and fluctuations in weather. Recommended for service in hot water, steam and dry heat. Most popular application on chloramine. Suitable for other popular chemicals - ketones, alcohols, phosphate ester hydraulic fluids, glycols, dilute acids and alkalis. Maximum temperature 300°F wet. Not suitable for petroleum.
- Pressure Rating:** 200 PSI Working Pressure, 225 PSI Test Pressure

Recommended For:
 IPS PVC, C-900 PVC, Ductile Iron, Cast Iron, Steel and other types of pipe.
 Not recommended for High Density Polyethylene Pipe (HDPE).
 Environmentally friendly passivation of the 304 Stainless Steel fabrication ensures a return to the stainless steel's natural corrosion resistant state to last the life of the pipeline. Per ASTM A380.

JCM 418 Threaded Outlet Tapping Sleeve

For taps and connections on larger pipe, thin wall pipe and pipe requiring extra reinforcement.



The JCM 418 Fabricated Threaded Outlet Tapping Sleeve is especially recommended for service connections, air relief valve connections, taps on larger A/C, Cast Iron, Ductile Iron, PVC and Reinforced Concrete Pipe. The heavy gasket section and full sleeve support of this fitting offer much more stability, pipe reinforcement and strength than a strapped saddle, yet they are competitively priced. Readily available for pipe 4" and larger requiring IPS outlets of 3/4" through 4", these sleeves are furnished with shop coat and alloy bolts. Epoxy coating and stainless steel bolts are available at an additional charge.

HOW TO ORDER

1. Determine O.D. of pipe and outlet size.
2. Check listing to determine catalog number.
3. For sizes not listed, order by pipe O.D. size

Example: For 24" Cast Iron with 25.80 O.D. with 3"IP outlet, order: 418-2580 x 17IP.

For All Stainless Steel see 438 Threaded Outlet Tapping Sleeve

418 FABRICATED THREADED OUTLET TAPPING SLEEVE (IPS Outlet)

NOM. PIPE SIZE (IN.)	SLEEVE O.D. RANGE (IN.)	CATALOG NUMBER X OUTLET SIZE	APPR. WT. EACH (LBS.)	OUTLET SIZE	ORDER CODE IP
				3/4"	06
2	*2.38	418-0238 X --	12	1"	08
	*2.50	418-0250 X --	12	1-1/4"	10
3	3.50	418-0350 X --	18	1-1/2"	12
	3.96	418-0396 X --	18	2"	14
4	4.50	418-0450 X --	21	2-1/2"	16
	4.80	418-0480 X --	21	3	17
6	6.63	418-0663 X --	23	4	18
	6.90	418-0690 X --	23		
8	8.63	418-0863 X --	31		
	9.05	418-0905 X --	33		
10	10.75	418-1075 X --	38		
	11.10	418-1110 X --	40		
12	12.75	418-1275 X --	48		
	13.20	418-1320 X --	51		
14	14.59 - 15.08	418-1475 X --	54		
	15.23 - 15.80	418-1530 X --	57		
	16.30 - 16.73	418-1650 X --	60		
16	17.33 - 17.87	418-1740 X --	64		
	18.62 - 19.19	418-1875 X --	68		
18	19.41 - 20.01	418-1950 X --	72		
	20.93 - 21.57	418-2130 X --	77		
20	21.51 - 22.15	418-2160 X --	80		
	23.46 - 24.16	418-2400 X --	87		
24	25.71 - 26.41	418-2580 X --	95		
	28.14 - 28.84	418-2834 X --	104		
30	31.62 - 32.22	418-3200 X --	115		
36	38.10 - 38.75	418-3830 X --	139		
42	44.10 - 44.70	418-4450 X --	160		
48	50.40 - 51.00	418-5080 X --	183		
54	56.60 - 57.25	418-5710 X --	205		

* Outlets Available
3/4 - 2" IP/CC

2" CC Not Available

OTHER SIZES AVAILABLE UPON REQUEST.

Available Options for JCM 418:

- Epoxy Coated with Stainless Steel Hardware (additional charge).
- With CC Threaded Outlet (additional charge).



JCM 438 All Stainless Steel Threaded Outlet Tapping Sleeve

For taps and connections on larger pipe, thin wall pipe and pipe requiring extra reinforcement in corrosive or aggressive conditions.

The JCM 438 All Stainless Steel Threaded Outlet Tapping Sleeve is especially recommended for aggressive or acidic conditions. The heavy gasket section and full sleeve support of this fitting offer much more stability, pipe reinforcement and strength than a strapped saddle, yet they are competitively priced. Readily available for pipe 4" and larger requiring IPS outlets of 3/4" through 4".

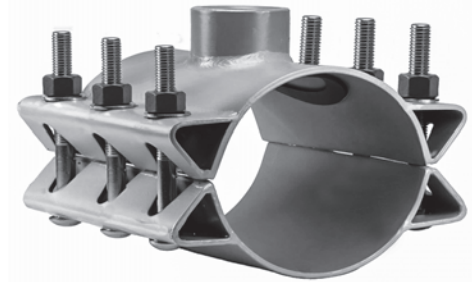

HOW TO ORDER

1. Determine O.D. of pipe and outlet size.
2. Check listing to determine order number.
3. For sizes not listed, order by pipe O.D. size

Example: For 24" Cast Iron with 25.80 O.D. with 3"IP outlet, order: 438-2580 x 17IP

438 ALL STAINLESS STEEL THREADED OUTLET TAPPING SLEEVE (IPS Outlet)

NOM. PIPE SIZE (IN.)	SLEEVE O.D. RANGE (IN.)	CATALOG NUMBER X OUTLET SIZE	APPR. WT. EACH (LBS.)
3	3.50	438-0350 X --	19
	3.96	438-0396 X --	19
4	4.50	438-0450 X --	21
	4.80	438-0480 X --	21
6	6.63	438-0663 X --	23
	6.90	438-0690 X --	23
8	8.63	438-0863 X --	31
	9.05	438-0905 X --	33
10	10.75	438-1075 X --	38
	11.10	438-1110 X --	40
12	12.75	438-1275 X --	48
	13.20	438-1320 X --	51
14	14.59 - 15.08	438-1475 X --	54
	15.23 - 15.80	438-1530 X --	57
	16.30 - 16.73	438-1650 X --	60
16	17.33 - 17.87	438-1740 X --	64
	18.62 - 19.19	438-1875 X --	68
18	19.41 - 20.01	438-1950 X --	72
	20.93 - 21.57	438-2130 X --	77
20	21.51 - 22.15	438-2160 X --	80
	23.46 - 24.16	438-2400 X --	87
24	25.71 - 26.41	438-2580 X --	95
	28.14 - 28.84	438-2834 X --	104
30	31.62 - 32.22	438-3200 X --	115
36	38.10 - 38.75	438-3830 X --	139
42	44.10 - 44.70	438-4450 X --	160
48	50.40 - 51.00	438-5080 X --	183
54	56.60 - 57.25	438-5710 X --	205

OTHER SIZES AVAILABLE UPON REQUEST.

Available Options for JCM 438:

- With CC Threaded Outlet (additional charge).
- JCM Model 6438 All Stainless Steel Tapping Sleeve - 316 Stainless Steel available.

OUTLET SIZE	ORDER CODE IP
3/4"	06
1"	08
1-1/4"	10
1-1/2"	12
2"	14
2-1/2"	16
3	17
4	18

* Outlets Available
3/4 - 2" IP/CC

2" CC Not Available



JCM TAPPING SLEEVES

MORE SELECTION, BENEFITS, OPTIONS

Specifying the right tapping sleeve for the condition of the job is the best way to assure a successful tap. JCM Tapping Sleeves are readily available in a wide variety of types and options to meet your exact conditions. High strength to weight ratio, built-in range and large gasket cross sections are just some of the design features that make JCM Tapping Sleeve highly desirable on critical installations.





JCM's expanded tapping sleeve selections and versatility assist our customers in selecting the correct JCM Model Tapping Sleeve for the job. Below is a chart that defines each tapping sleeve offering, its body material, design and gasket style along with the outlet material and style.

For specialty, engineered tapping sleeves, refer to the JCM Industries Engineered Fittings Specification Manual. This manual includes: mechanical joint tapping sleeves, concrete steel cylinder pipe tapping sleeves, large diameter and unique contour sleeves along with numerous options and designs.



JCM Tapping Sleeve Selection Chart

JCM Model Number	Body Material	Gasket Style	Outlet Material	Outlet Style
418	Carbon Steel	Outlet Seal	Carbon Steel	Threaded Outlet
438	304 Stainless Steel	Outlet Seal	304 Stainless Steel	Threaded Outlet
412	Carbon Steel	Outlet Seal	Carbon Steel	Flanged
419	Carbon Steel	Outlet Seal	Carbon Steel	Mechanical Joint
422	Carbon Steel	Outlet Seal	Carbon Steel	Flanged
429	Carbon Steel	Outlet Seal	Carbon Steel	Mechanical Joint
432	304 Stainless Steel	Full Circumferential	304 Stainless Steel	Flanged
439	304 Stainless Steel	Full Circumferential	304 Stainless Steel	Mechanical Joint
462	304 Stainless Steel	Full Circumferential	Carbon Steel	Flanged
469	304 Stainless Steel	Full Circumferential	Carbon Steel	Mechanical Joint
432 (T2)	304 Stainless Steel	Full Circumferential	304 Stainless Steel	Flanged
452	304 Stainless Steel	Outlet Seal	304 Stainless Steel	Flanged
459	304 Stainless Steel	Outlet Seal	304 Stainless Steel	Mechanical Joint
464	304 Stainless Steel	Outlet Seal	Carbon Steel	Flanged
465	304 Stainless Steel	Outlet Seal	Carbon Steel	Mechanical Joint
6432	316 Stainless Steel	Full Circumferential	316 Stainless Steel	316 Flanged
6439	316 Stainless Steel	Full Circumferential	316 Stainless Steel	316 Mechanical Joint
6438	316 Stainless Steel	Outlet Seal	316 Stainless Steel	316 Threaded Outlet
6452	316 Stainless Steel	Outlet Seal	316 Stainless Steel	316 Flanged
6459	316 Stainless Steel	Outlet Seal	316 Stainless Steel	316 Mechanical Joint

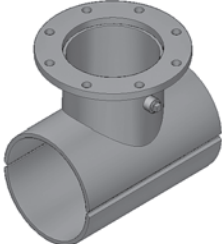
JCM Carbon Steel Fabricated Tapping Sleeve Selection Guide



PRODUCT	NUMBER & TYPE	APPLICATION, SIZES AND INFORMATION
	411 Plain Outlet Sleeve	Most economical sleeve for dry taps and connections to be made without a valve. Also excellent as a base sleeve for special sleeves. Available with reducing and size on size outlets for all types of pipe, 6" and larger.
	412 Flanged Outlet Tapping Sleeve 422 Flanged Outlet Tapping Sleeve for PVC & Steel Pipe 413 Flanged Outlet Tapping Cross	<p>The standard sleeve for quick, economical taps on all types of pipe, standard or high pressure service. Most available of all types in standard or special sizes. Available with reducing and size on size outlets, pipe sizes 6" and larger. Special outlets readily available.</p> <p>Specially designed tapping sleeve for the exact O.D. of steel pipe, IPS PVC and C-900. Sizes 4" -12".</p> <p>Quick economical cross for all types of pipe 8" and larger. Outlets must be minimum of three nominal sizes smaller than run. Made similar to the 412, the sleeve length is extended to provide more pipe support.</p>
	414 Mechanical Joint Tapping Sleeve & Cross	The sleeve with side and end gaskets to provide extra margin of safety on lines which are subject to problems of beam loads. Available with size on size and reducing outlets. Competitive with cast sleeves in larger and special sizes. Excellent availability.
	415 Concrete Steel Cylinder Tapping Sleeve	Designed to tap all types and brands of concrete steel cylinder pipe. Sleeve reinforces pipe prior to cutting of pipe reinforcing rod. Extra heavy retained gasket and easily installed gland provide a locked in, positive seal. Available with reducing outlets in pipe sizes 16" and larger.
	416 Weld On Outlets 417 Weld on Tapping Sleeve	<p>Outlets, partial sleeves and complete sleeves for pipe sizes 6" and larger with size on size and reducing outlets. These outlets are designed for steel pipe with wall thickness of 1/4" and greater.</p> <p>Split weld on sleeve designed to reinforce pipe to be tapped. Standard sleeve thickness 1/4".</p>

JCM Carbon Steel Fabricated Tapping Sleeve Selection Guide

PRODUCT	NUMBER & TYPE	APPLICATION, SIZES AND ADDITIONAL INFORMATION
	<p>418 Threaded Outlet Tapping Sleeve</p>	<p>For taps and connections in larger sizes of pipe (service connections, taps for air relief valves). Heavy gasket section and full sleeve offer better performance than strapped saddle, yet competitively priced. Available with IPS outlets, pipe sizes 4" and larger, outlets 3/4" - 4", in standard shop coat alloy bolts or epoxy coated/stainless steel bolts.</p>
	<p>419 Fabricated Carbon Steel Tapping Sleeve with Mechanical Joint Outlet*</p> <p>429 Fabricated Carbon Steel Tap Sleeve with MJ Outlet* for IPS PVC, C-900 PVC and Steel Pipe sizes</p>	<p>New from JCM Fabricated Carbon Steel Tapping Sleeve with TRUE Mechanical Joint Outlet. Durable construction, alignment set pins and "monocast" mechanical joint outlet provides a competitive option for using MJ valves in lieu of tapping valves. Available in shopcoat or epoxy, standard or stainless steel hardware. Sizes 4" and larger up through 12" outlets. JCM 429 is provided standard epoxy coated.</p> <p>JCM Mechanical Joint Outlets meet AWWA C-111/ANSI 21.11 Standard Dimensions</p> <p><small>*Licensed by PowerSeal Corporation U. S. Patent No. 6,227,234</small></p>
	<p>440 Line Stop Fitting</p>	<p>Largest selection of options in the industry. Available in all JCM sleeve body/material combinations with options of threaded plug or push pin plug.</p> <p>Designed for use on 150 PSI piping systems, the heavier materials and extra bolting power built into these sleeves eliminate flexing and provides extra sealing capability necessary for long term performance. The heavy all stainless construction and full circumferential sealing gasket means these non-compromising sleeves will be trouble free and become a permanent part of the piping system just as the mechanical joint fittings already in use.</p> <p>Carbon Steel Stainless Steel Combination Stainless/Carbon</p>

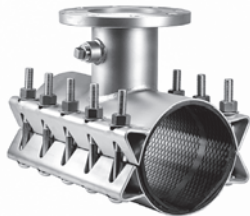
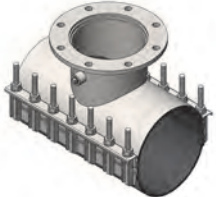

JCM Tapping Sleeves meet or exceed the ANSI/AWWA C-223 and the MSS-SP 124 Standards as applicable.

JCM Stainless Steel (304) Tapping Sleeve Selection Guide

PRODUCT	NUMBER & TYPE	APPLICATION, SIZES AND ADDITIONAL INFORMATION
	438 All Stainless Steel Threaded Outlet Tapping Sleeve	All stainless steel construction for taps and connections of larger sizes of pipe in corrosive, acidic environments. The 438 is available construction of either 304 or 316 Stainless Steel. Heavy gasket section and full sleeve offer better performance than strapped saddle, yet competitively priced. Available with IPS outlets, pipe sizes 4" and larger, outlets 3/4" - 4"
	432 All Stainless Steel Tapping Sleeve 462 Stainless Steel Tapping Sleeve with Carbon Steel Flange	The sleeve for taps requiring full circumferential seal with high safety factor. Strong stainless construction with independent bolting for higher bolt torque capabilities. Sizes 4" - 24".
	432 Type 2 Fabricated Lug Lightweight All Stainless Steel Tapping Sleeve	NEW FROM JCM Stainless steel sleeves featuring the full circumferential gasket for economical, non complex applications. Available in all stainless or stainless carbon combination. Sizes 4" - 16".
	452 All Stainless Steel Tapping Sleeve with Outlet Seal Gasket 464 Stainless Steel Tapping Sleeve with Outlet Seal Gasket Carbon Steel Flange	Stainless steel tapping sleeve for large diameter pipe and high pressure applications. Stainless construction provides superior corrosion resistance for long term service. Sizes 6" and larger.

JCM Tapping Sleeves meet or exceed the ANSI/AWWA C-223 and the MSS-SP 124 Standards as applicable.

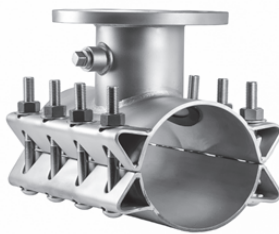

JCM Stainless Steel (304) Tapping Sleeve Selection Guide

PRODUCT	NUMBER & TYPE	APPLICATION, SIZES AND ADDITIONAL INFORMATION
	<p>452 All Stainless Steel Tapping Sleeve with Outlet Seal Gasket</p> <p>464 Stainless Steel Tapping Sleeve with Outlet Seal Gasket Carbon Steel Flange</p>	<p>Stainless steel tapping sleeve for large diameter pipe and high pressure applications. Stainless construction provides superior corrosion resistance for long term service. Sizes 6" and larger.</p>
	<p>439 All Stainless Steel Sleeve with Mechanical Joint Outlet*</p> <p>469 Stainless Steel Sleeve with Carbon Steel Mechanical Joint Outlet*</p> <p>459 All Stainless Steel Sleeve with Mechanical Joint Outlet*</p> <p>465 Stainless Steel Sleeve with Outlet Seal Gasket and Carbon Steel Mechanical Joint Outlet*</p>	<p>True mechanical joint outlet tapping sleeve reduces application costs and inventory by utilizing MJ gate valve in lieu of tapping valve. All stainless steel construction provides corrosion resistance. Unique load bearing set pins transfer load and prevents movement or misalignment during or after the tap. Available in full circumferential gasket style or outlet seal gasket style. Sizes: Outlets 4" - 12", pipe sizes 4" and larger.</p> <p>JCM Mechanical Joint Outlets meet AWWA C-111/ANSI 21.11 Standard Dimensions</p> <p>*Licensed by PowerSeal Corporation U. S. Patent No. 6,227,234</p>

JCM Tapping Sleeves meet or exceed the ANSI/AWWA C-223 and the MSS-SP 124 Standards as applicable.

JCM Stainless Steel (316) Tapping Sleeve Selection Guide

Tapping Sleeves featured are available constructed of ALL 316 Stainless Steel material. Four digit model numbers reflect JCM standard tapping sleeve design style and outlet configuration. Fittings are available in same O.D. ranges and outlet sizes as their corresponding model numbers indicate. These fittings are priced on application. Contact JCM Inside Sales Team for information.

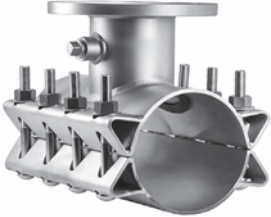
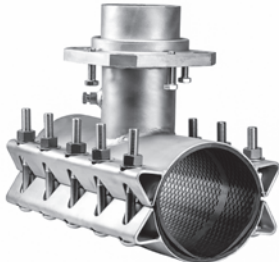
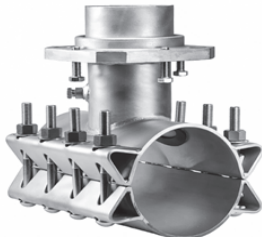
PRODUCT	NUMBER & TYPE	APPLICATION, SIZES AND ADDITIONAL INFORMATION
	6438 All 316 Stainless Steel Threaded Outlet Tapping Sleeve	All 316 stainless steel construction for taps and connections of larger sizes of pipe in corrosive, saltwater and extreme acidic environments. Heavy gasket section and full sleeve offer better performance than strapped saddle. Available with IPS outlets, pipe sizes 4" and larger, outlets 3/4" - 4"
	6432 All 316 Stainless Steel Tapping Sleeve	The sleeve for taps requiring full circumferential seal with high safety factor. Strong stainless construction with independent bolting for higher bolt torque capabilities. Sizes 4" - 24".
	6452 All 316 Stainless Steel Tapping Sleeve with Outlet Seal Gasket	Stainless steel tapping sleeve for large diameter pipe and high pressure applications. Stainless construction provides superior corrosion resistance for long term service. Sizes 6" and larger.
	6439 All 316 Stainless Steel Sleeve with Mechanical Joint Outlet*	True mechanical joint outlet tapping sleeve reduces application costs and inventory by utilizing MJ gate valve in lieu of tapping valve. All stainless steel construction provides corrosion resistance. Unique load bearing set pins transfer load and prevents movement or misalignment during or after the tap. Available in full circumferential gasket style or outlet seal gasket style. Sizes: Outlets 4" - 12", pipe sizes 4" and larger.
	6459 All 316 Stainless Steel Sleeve with Mechanical Joint Outlet*	JCM Mechanical Joint Outlets meet AWWA C-111/ANSI 21.11 Standard Dimensions *Licensed by PowerSeal Corporation U. S. Patent No. 6,227,234

JCM Tapping Sleeves meet or exceed the ANSI/AWWA C-223 and the MSS-SP 124 Standards as applicable.

JCM 412 Fabricated Carbon Steel Tapping Sleeves

Built-in benefits make these heavy fabricated steel sleeves increasingly popular for making larger taps on all types of pipe. By placing the design emphasis on eliminating problems inherent with older pipe and field installations, JCM 412 Tapping Sleeves have taken the complexity out of tapping larger pipe.

Built in range assures proper fit on more than one class of pipe - reducing inventory requirements and the chance of not having the right size sleeve.

Ease of assembly eliminates extra equipment, time and specially trained personnel.

Ready availability means taps can be made without long delays - even taps on special sizes of pipe - or services requiring high pressure flanges.

Direct reinforcement of the pipe by the sleeve eliminates flexing or deflection of pipe opposite the tap. Less weight than heavy cast iron sleeves reduces the load on the pipe.

Most important, **JCM 412 Tapping Sleeves assure a safe dependable tap**. A large gasket cross section provides a positive initial seal which increases with increases in line pressure.

Alignment recess for aligning sleeve and tapping valve. Corrosion resistant, high strength low alloy bolts and nuts. Optional Stainless Steel.

Test Plug 3/4" NPT (stainless steel in the Epoxy Coated tapping sleeve).

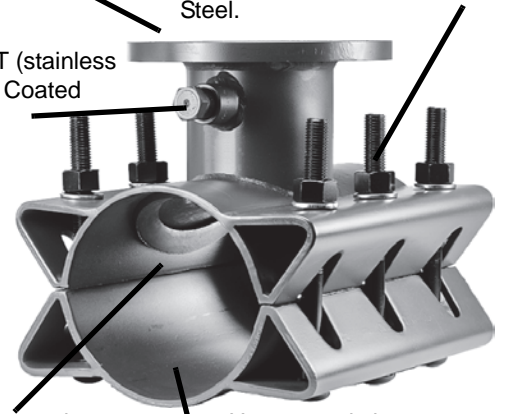

Broad cross section gasket set in retaining cavity.

Heavy steel sleeve with built-in range reinforces pipe - eliminates deflection possibility.

MATERIAL SPECIFICATIONS - JCM 412 FABRICATED TAPPING SLEEVE

- Body:** ASTM A285 Grade C or ASTM A-36 Steel
- Bolts:** Corrosion Resistant, high strength low alloy (AWWA C-111, ANSI A21.11). Optional Stainless Steel 18-8 Type 304.
- Flange:** AWWA C207 Class D, ANSI 150lb. Drilling, recessed for tapping valve MSS-SP60. Other flanges and outlets available upon request.
- Gasket:** Nitrile Butadiene Rubber (NBR, Buna-N) per ASTM D2000. Molded virgin rubber with a pressure activated hydromechanical design. Gasket is bonded into a cavity for internal and external retention. Gasket temperature range -40°F to 212°F (-40°C - 100°C) Gasket suitable for water, salt solutions, mild acids, bases, and sewage. Optional gasket materials available.
- Finish:** Heavy coat of corrosion resistant metal primer. Optional Fusion Epoxy Coating available.
- Service**
- Rating:** 4" to 12" Outlets: 175 PSI. Higher service rating available for specific applications and sizes.

JCM Industries Tapping Sleeves meet or exceed the ANSI/AWWA C-223 and the MSS-SP 124 Standards as applicable.

412 TAPPING SLEEVE DIMENSIONS

Flange Size*	A	B	C	D	E	F
3	12	5	4-1/32	3-1/2	6	3/4
4	12	5	5-1/32	4-1/2	6	3/4
6	12	5	7-1/32	6-1/2	6	3/4
8	16	5-1/8	9-1/32	8-1/8	8	3/4
10	20	5-1/2	11-1/16	10-1/4	10	3/4
12	24	5-3/4	13-1/16	12-1/4	12	3/4

For outlets 14" and larger the manufacturer of the tapping valve must be specified to assure proper alignment recess dimension.
 Size on size tapping sleeve requires 1/2" undersize cutter to assure proper cutter clearance and complete severance of the coupon.
 On nominal pipe size 07.45 and smaller dimension D is 6-1/8".
 On nominal pipe sizes 07.45 and smaller dimensions: E = 8, F = 5/8"

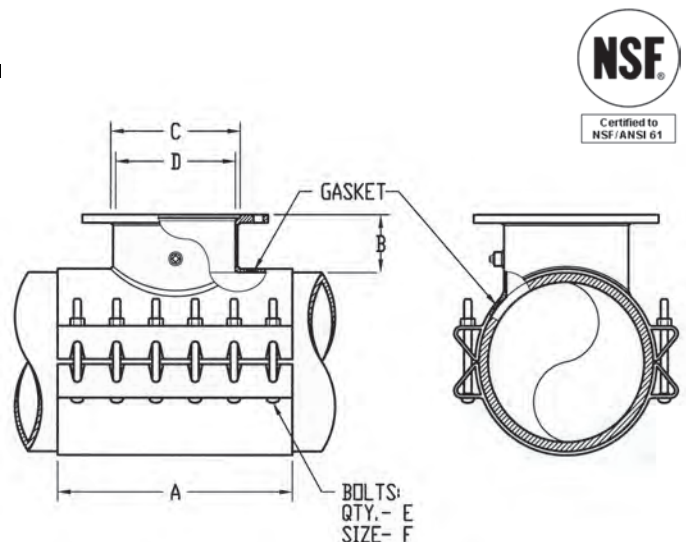

JCM 412 Fabricated Carbon Steel Tapping Sleeves

NOM. PIPE SIZE (IN.)	SLEEVE O.D. RANGE (IN.)	CATALOG NUMBER X ANY OUTLET	OUTLET SIZES AVAILABLE	APPR. WT. EACH (LBS.)
6**	6.63 (SEE 422)			
	6.83 - 7.16	412-0690	X 3	74
	7.05 - 7.40	412-0720	X 4	76
	7.40 - 7.73	412-0745	X 6	82
8	8.63 (SEE 422)			
	8.98 - 9.37	412-0905	X 3	83
	9.27 - 9.69	412-0940	X 4	85
			X 6 X 8	88 118
10	9.83 - 10.25*	412-1000	X 3	90
	10.64 - 10.86	412-1075	X 4	92
	11.03 - 11.47	412-1110	X 6	96
	11.36 - 11.80	412-1140	X 8	125
	11.76 - 12.24	412-1200	X 10	168
12	12.62 - 12.88	412-1275	X 3	98
	13.13 - 13.60	412-1320	X 4	100
	13.60 - 14.09	412-1392	X 6	104
	14.08 - 14.56	412-1420	X 8	140
			X 10 X 12	176 216
14	14.59 - 15.08	412-1475	X 3	113
	15.23 - 15.80	412-1530	X 4	115
	15.73 - 16.22	412-1600	X 6	116
	16.30 - 16.73	412-1650	X 8	150
			X 10 X 12	190 220
16	16.74 - 17.26	412-1684	X 3	113
	17.33 - 17.87	412-1740	X 4	115
	17.88 - 18.43	412-1800	X 6	120
	18.62 - 19.19	412-1875	X 8	162
			X 10 X 12	210 230
18	18.87 - 19.45	412-1920	X 3	120
	19.41 - 20.01	412-1950	X 4	122
	20.00 - 20.60	412-2000	X 6	126
	20.29 - 20.94	412-2050	X 8	180
	20.93 - 21.57	412-2130	X 10 X 12	240 245
20	21.51 - 22.15	412-2160	X 3	131
	22.16 - 22.81	412-2254	X 4	133
	22.78 - 23.45	412-2294	X 6	140
	23.46 - 24.16	412-2400	X 8	185
	24.15 - 24.85	412-2450	X 10	245
	24.82 - 25.52	412-2502	X 12	255
24	25.71 - 26.41	412-2580	X 3	143
	26.55 - 27.25	412-2715	X 4	143
	27.26 - 27.96	412-2746	X 6	160
	28.14 - 28.84	412-2834	X 8	215
			X 10 X 12	280 312
30	29.78 - 30.48	412-3000	X 3	163
	30.48 - 31.18	412-3075	X 4	165
	31.52 - 32.22	412-3200	X 6	175
			X 8	226
			X 10 X 12	295 310

Pipe sizes 72" and larger available upon request

*These sizes not available with size on size outlets.

**These sizes incorporate (8) - 5/8 bolts.

For size on size outlets a 1/2" undersize shell cutter is required.

Larger Sizes: For outlets 14" and larger, the tapping valve to be used must be specified to assure proper alignment recess dimension.

JCM 412 Tapping Sleeves furnished with test plugs unless otherwise specified.



JCM 422 Carbon Steel Tapping Sleeves for PVC & Steel Pipe Sizes

Built-in benefits make JCM 422 Tapping Sleeves the ideal selection for tapping and branching IPS sized PVC, Steel, High Density Polyethylene Pipe and C-900 PVC. These sleeves are designed to reinforce the pipe and assure simple, safe installation - even under the most adverse field conditions. The extra wide reinforcement and exact fit of these sleeves provide reinforcement which strengthens the PVC pipe and prevents pipe stress at the branch.

Built-in Corrosion Resistance

JCM 422 Tapping Sleeves are furnished standard Fusion Epoxy Coated with Hot Dipped Galvanized Bolts.

Heavy Gasket Best for PVC Pipe

JCM 422 Tapping Sleeves utilize a broad, heavy gasket with hydro-mechanical lip to assure a positive seal on PVC pipe with its normal expansion-contraction characteristics.

Extra Wide for Support and Stability

JCM Sleeves are designed extra wide for reinforcement to the main, to spread the load over a wider area and to provide stability during the tapping process.

Stronger - yet lighter than Cast Sleeves

Extra strength provides an extra margin of safety against damage to the sleeve in handling and installation, or due to concentrated stress. Reduced weight speeds installation and reduces the load placed on the pipe.

Ease Of Assembly Assures Proper Installation

Simplicity of design permits JCM Tapping Sleeves to be installed with minimum of crew, equipment, time and experience.

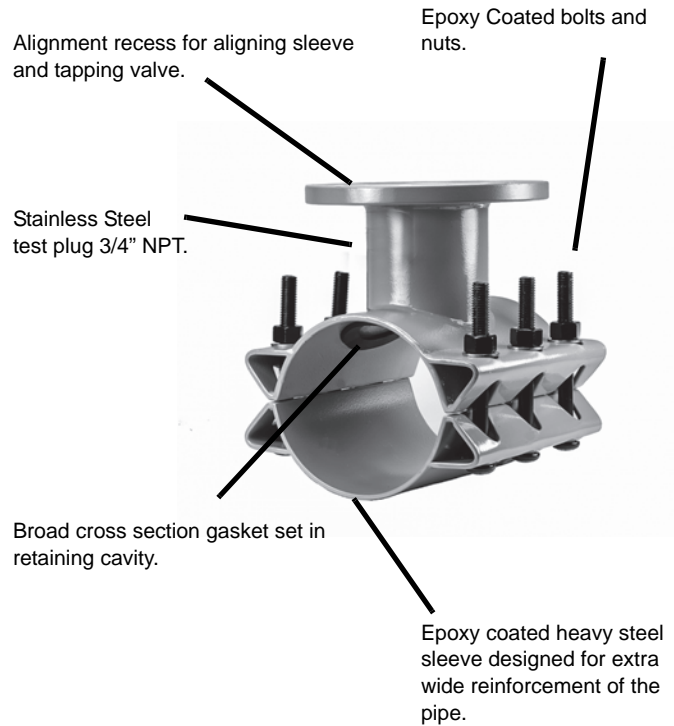

MATERIAL SPECIFICATIONS - JCM 422 TAPPING SLEEVE

BODY: ASTM A285 Grade C, ASTM A-36 Steel or equal.

BOLTS: 5/8" Corrosion resistant, high strength low alloy oval neck track head bolt per ASTM A242/ANSI 21.11/AWWA C-111 and heavy hex nut per A563 epoxy coated, Powercron 590-534. Optional: Stainless Steel 18-8 304 or 316 available.

FLANGE: AWWA C207 Class D, ANSI 150 lb. Drilling, recessed for tapping valve MSS-SP60.

GASKET: Nitrile Butadiene Rubber (NBR, Buna-N) per ASTM D2000. Molded virgin rubber with a pressure activated hydro mechanical design. Gasket is bonded into a cavity for internal and external retention. Gasket temperature range -40°F to 212°F (-40°C - 100°C) Gasket suitable for water, salt solutions, mild acids, bases, and sewage.

FINISH: Fusion applied epoxy coating, minimum 12 mils thickness per ANSI/AWWA C-213.

SERVICE RATING: 4" to 12" Outlets: 175 PSI. Higher service rating available for specific applications and sizes.

JCM Tapping Sleeves meet or exceed the ANSI/AWWA C-223 and the MSS-SP 124 Standards as applicable.



422 TAPPING SLEEVE DIMENSIONS

FLANGE SIZE	A	B	C	D	E	F
3	9*	5	4-1/32	3-1/2	6	5/8
4	9*	5	5-1/32	4	6	5/8
6	12	5	7-1/32	6-1/8	8	5/8
8	15	5-1/8	9-1/32	8-1/8	10	5/8
10	21	5-1/2	11-1/16	10-1/4	14	5/8
12	24	5-3/4	13-1/16	12-1/4	16	5/8

NOTE: 422 Sleeves requires a standard 1/2" undersize cutter be used.
10" & 12" Nominal pipe sizes - dimension A is 12".

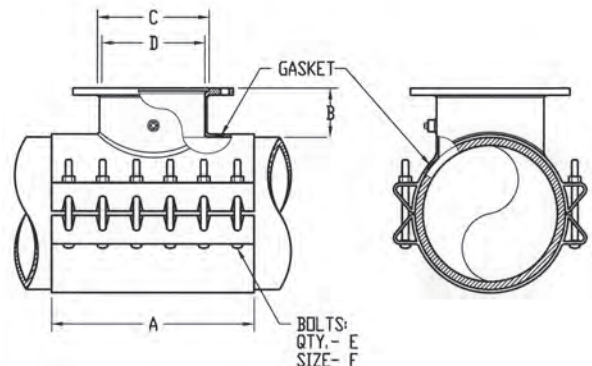

JCM 422 Carbon Steel Tapping Sleeves for PVC & Steel Pipe

TYPE AND CLASS OF PIPE	NOM. PIPE SIZE (IN.)	O.D. RANGE (IN.)	CATALOG NUMBER	ADD OUTLET SIZE	APPR. WT. EACH (LBS.)	
PVC PIPE IPS SIZED SDR 26, 21 SCH. 40 CLASS 200, CLASS 160	2	2.38 2.50	422-0238 422-0250	x 2	12	
	3	3.50	422-0350	x 3	18	
	STEEL PIPE IPS SIZES, SCHEDULE PIPE	4	4.50	422-0450	x 3 x 4	29 31
		5	5.56	422-0556	x 3 x 4	32 33
		6	6.63	422-0663	x 3 x 4 x 6	33 35 44
		8	8.63	422-0863	x 3 x 4 x 6 x 8	36 38 49 64
	10	10.75	422-1075	x 3 x 4 x 6 x 8 x 10	90 92 96 125 168	
	12	12.75	422-1275	x 3 x 4 x 6 x 8 x 10 x 12	98 100 104 140 176 216	
	C-900 PVC ONLY AWWA C-900 ALL CLASSES	3	3.96	422-0396	x 3	20
		4	4.80	422-0480	x 3 x 4	33 35
6		6.90	422-0690	x 3 x 4 x 6	38 40 60	
8		9.05	422-0905	x 3 x 4 x 6 x 8	43 45 56 71	
10		11.10	422-1110	x 3 x 4 x 6 x 8 x 10	90 92 96 125 168	
12		13.20	422-1320	x 3 x 4 x 6 x 8 x 10 x 12	98 100 104 140 176 216	

422 Tapping Sleeves are furnished with test plugs; standard fusion epoxy coated with epoxy coated low alloy bolts; require that a 1/2" undersized cutter be used.

HOW TO ORDER - JCM TAPPING SLEEVES

1. Determine O.D. of pipe.
2. Select proper sleeve O.D. range.
3. Specify catalog number and outlet size. JCM 422 is standard Epoxy Coated. Add (SS) for Stainless Hardware.
Example: For PVC pipe with 8.63 O.D. with 6" outlet, order: 422-0863 x 6. For stainless steel hardware, add (SS).



JCM 419 Fabricated Carbon Steel Tapping Sleeves Mechanical Joint Outlet*

JCM Mechanical Joint Outlets meet AWWA C-111/ANSI 21.11 Standard Dimensions

NOM. PIPE SIZE (IN.)	SLEEVE O.D. RANGE (IN.)	CATALOG NUMBER X ANY OUTLET	OUTLET SIZES AVAILABLE	APPR. WT. EACH (LBS.)
6	6.63 (SEE 429)	419-0690 419-0720 419-0745	X 3	73
	6.83 - 7.16		X 4	76
	7.05 - 7.40		X 6	82
	7.40 - 7.73			
8	8.63 (SEE 429)	419-0905 419-0940	X 3	83
	8.98 - 9.37		X 4	85
	9.27 - 9.69		X 6	88
			X 8	118
10	9.83 - 10.25*	419-1000 419-1075 419-1110 419-1140 419-1200	X 3	90
	10.64 - 10.86		X 4	92
	11.03 - 11.47		X 6	96
	11.36 - 11.80		X 8	125
	11.76 - 12.24		X 10	168
12	12.62 - 12.88	419-1275 419-1320 419-1392 419-1420	X 3	97
	13.13 - 13.60		X 4	100
	13.60 - 14.09		X 6	104
	14.08 - 14.56		X 8	140
			X 10	176
14	14.59 - 15.08	419-1475 419-1530 419-1600 419-1650	X 12	216
	15.23 - 15.80		X 3	110
	15.73 - 16.22		X 4	115
	16.30 - 16.73		X 6	116
			X 8	150
16	16.74 - 17.26	419-1684 419-1740 419-1800 419-1875	X 10	190
	17.33 - 17.87		X 12	220
	17.88 - 18.43		X 3	110
	18.62 - 19.19		X 4	115
			X 6	120
18	18.87 - 19.45	419-1920 419-1950 419-2000 419-2050 419-2130	X 8	162
	19.41 - 20.01		X 10	210
	20.00 - 20.60		X 12	230
	20.29 - 20.94		X 3	120
	20.93 - 21.57		X 4	122
20	21.51 - 22.15	419-2160 419-2254 419-2294 419-2400 419-2450 419-2502	X 6	126
	22.16 - 22.81		X 8	180
	22.78 - 23.45		X 10	240
	23.46 - 24.16		X 12	245
	24.15 - 24.85		X 3	130
	24.82 - 25.52		X 4	133
24	25.71 - 26.41	419-2580 419-2715 419-2746 419-2834	X 6	140
	26.55 - 27.25		X 8	143
	27.26 - 27.96		X 10	160
	28.14 - 28.84		X 12	215
			X 3	280
30	29.78 - 30.48	419-3000 419-3075 419-3200	X 4	312
	30.48 - 31.18		X 6	160
	31.52 - 32.22		X 8	175
			X 10	226
			X 12	295

*These sizes not available with size on size outlets. For size on size outlets a 1/2" undersize shell cutter is required.

JCM 419 are furnished with test plugs unless otherwise specified. Pipe sizes 72" and larger available upon request

*Licensed by PowerSeal Corporation U. S. Patent No. 6,227,234

JCM 419 FABRICATED TAPPING SLEEVE - MECHANICAL JOINT OUTLET

OUTLET	A	B	C	D	E
3	12	5	3.32	6	3/4
4	12	5-1/8	4.26	6	3/4
6	12	5-1/4	6.36	6	3/4
8	16	5-3/8	8.33	8	3/4
10	20	5-3/8	10.42	10	3/4
12	24	5-3/8	12.39	12	3/4

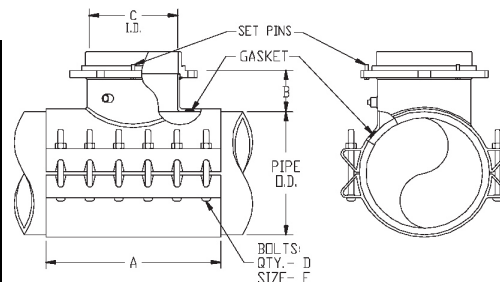

On nominal pipe sizes 07.45 and smaller dimensions: E = 8, F = 5/8"



JCM 429 Fabricated Carbon Steel Tapping Sleeve Mechanical Joint Outlet*

JCM Mechanical Joint Outlets meet AWWA C-111/ANSI 21.11 Standard Dimensions

TYPE AND CLASS OF PIPE	NOM. PIPE SIZE (IN.)	O.D. RANGE (IN.)	CATALOG NUMBER	ADD OUTLET SIZE	APPR. WT. EACH (LBS.)	
PVC PIPE IPS SIZED SDR 26, 21 SCH. 40 CLASS 200, CLASS 160 STEEL PIPE IPS SIZES, SCHEDULE PIPE 	4	4.50	429-0450	x 3 x 4	29 31	
	5	5.56	429-0556	x 3 x 4	31 33	
	6	6.63	429-0663	x 3 x 4 x 6	32 35 44	
	8	8.63	429-0863	x 3 x 4 x 6 x 8	35 38 49 64	
	10	10.75	429-1075	x 3 x 4 x 6 x 8 x 10	89 92 96 125 168	
	12	12.75	429-1275	x 3 x 4 x 6 x 8 x 10 x 12	96 100 104 140 176 216	
	C-900 PVC ONLY AWWA C-900 ALL CLASSES	4	4.80	429-0480	x 3 x 4	29 31
		6	6.90	429-0690	x 3 x 4 x 6	32 35 44
		8	9.05	429-0905	x 3 x 4 x 6 x 8	35 38 49 64
		10	11.10	429-1110	x 3 x 4 x 6 x 8 x 10	89 92 96 125 168
		12	13.20	429-1320	x 3 x 4 x 6 x 8 x 10 x 12	96 100 104 140 176 216

429 Tapping Sleeves are furnished with test plugs; standard fusion epoxy coated with epoxy coated low alloy bolts; requires that a 1/2" undersized cutter be used.

*Licensed by PowerSeal Corporation U. S. Patent No. 6,227,234.

HOW TO ORDER - JCM TAPPING SLEEVES WITH MECHANICAL JOINT OUTLETS

1. Determine O.D. of pipe.
2. Select proper Sleeve O.D. range.
3. Specify catalog number and outlet size.
4. For Epoxy Coating add (E). For Stainless hardware add (SS). JCM 429 is standard Epoxy Coated.
 Example: For PVC pipe with 08.63 O.D. with 6" outlet, order: 429-0863 x 6. For stainless steel hardware, add (SS).



JCM 432 All Stainless Steel Tapping Sleeve

JCM 462 Stainless Steel Tapping Sleeve with Carbon Steel Flange

EXTRA BOLTING POWER...The true tapping sleeve design of this sleeve incorporates replaceable, self-aligning bolts, which facilitate conversion of high bolt torques to high gasket pressure, can be torqued to 125 ft. lbs. This increases gasket sealing pressure and pressure holding capability.

FULL CIRCUMFERENTIAL SEAL...The extra bolting power assures the gasket will seal the full circumference of the pipe. This provides insurance against beam breaks in size on size taps. Molded in recessed bridge plate assures even gasket pressure throughout the range of the sleeve.

STRONGER YET LIGHTER THAN CAST SLEEVES...Extra strength eliminates possible cracking of the sleeve or flange. Reduced weight speeds installation and reduces the load placed on the pipe.

EXTRA WIDE FOR SUPPORT AND STABILITY...Extra width and heavier neck and body material provide extra reinforcement of the outlet and extra stability during the tapping process.

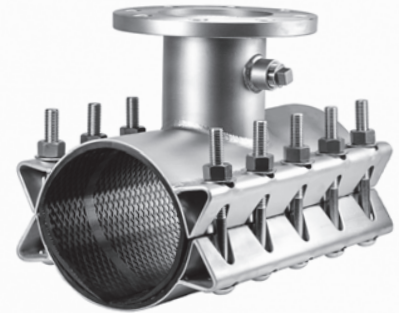

JCM 432 - All stainless construction provides extra corrosion resistance. The stainless steel flange, outlet and body join as one unit of similar metals for highest structural strength and corrosion resistance.

JCM 462 - Stainless steel body/neck construction joins with a strong, economical carbon steel flange. Coated steel flange is to AWWA C207, Class D standard with recess for tapping alignment.

Sleeve pressure rating with standard stainless steel flange:

Sleeves 4" - 24" nominal pipe sizes: 150 PSI working pressure, per ANSI/AWWA C228 Class SD

Sleeve pressure rating with optional ANSI stainless steel flange:

Sleeves 4" - 12" nominal pipe sizes: 250 PSI working pressure, hydrostatic test pressure of 300 PSI.

Sleeves 14" - 24" nominal pipe sizes: 200 PSI working pressure, hydrostatic test pressure of 250 PSI

MATERIAL SPECIFICATIONS - JCM 432 and 462 TAPPING SLEEVES:

- Body:** Stainless Steel, 18-8 Type 304
- Bolts:** Stainless Steel, Type 304
- Branch Outlet:** Schedule 10 Stainless Steel Pipe
- Gasket:** Full circumferential gasket compounded for use with water, salt solutions, mild acids, bases and sewage.
- 432 Flange:** 18-8 Type 304 Stainless Steel per ANSI/AWWA C228 Class SD. ANSI 150lb. Drilling, recessed for tapping valve per MSS-SP 60.
- 462 Flange:** AWWA C207 Class D, ANSI 150lb. Drilling, recessed for tapping valve MSS-SP60.



JCM Tapping Sleeves meet or exceed the ANSI/AWWA C-223 and the MSS-SP 124 Standards as applicable.

JCM 432 & 462 STAINLESS STEEL TAPPING SLEEVE DIMENSIONS

FLANGE SIZE	A	B	C	D	E	F
2	15	5	3-1/32	2.16	10	5/8
3	15	5-1/8	4-1/32	3.26	10	5/8
4	15	5-1/4	5-1/32	4.26	10	5/8
6	15	5-3/8	7-1/32	6.35	10	5/8
8	21	5-3/8	9-1/32	8.32	14	5/8
10	27	5-3/8	11-1/16	10.42	18	5/8
12	30	5-3/8	13-1/16	12.39	20	5/8

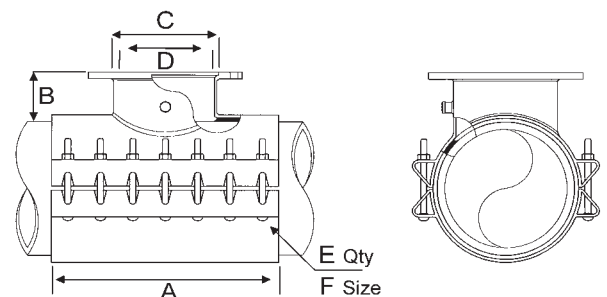

Stainless Steel Tapping Sleeve - Full Circumferential Gasket - Flanged Outlet

JCM 432 Stainless Steel Flanged Outlet

JCM 462 Carbon Steel Flanged Outlet

NOM. PIPE SIZE (IN.)	SLEEVE O.D. RANGE (IN.)	MODEL 432 STAINLESS STEEL FLANGE CATALOG NUMBER	MODEL 462 CARBON STEEL FLANGE CATALOG NUMBER	OUTLET SIZES	WIDTH OF SLEEVE	NUMBER OF BOLTS	APPR. WT. EA. LBS
4	4.40 - 4.60	432-0450	462-0450	X 2	15	10	38
	4.50 - 4.80	432-0465	462-0465	X 3	15	10	40
	4.74 - 5.00	432-0480	462-0480	X 4	15	10	42
	5.10 - 5.30	432-0520	462-0520				
6	6.56 - 6.90++	432-0663	462-0663	X 2	15	10	42
	6.83 - 7.16	432-0690	462-0690	X 3	15	10	42
	7.05 - 7.40	432-0720	462-0720	X 4	15	10	47
	7.40 - 7.73	432-0745	462-0745	X 6	15	10	49
8	8.54 - 8.74	432-0863	462-0863	X 2	15	10	45
	8.60 - 9.05++	432-0900	462-0900	X 3	15	10	45
	8.98 - 9.37	432-0905	462-0905	X 4	15	10	51
	9.27 - 9.69	432-0940	462-0940	X 6	15	10	54
		432-0940	462-0940	X 8	21	14	78
10	9.83 - 10.25+	432-1000	462-1000	X 2	15	10	46
	10.64 - 10.86	432-1075	462-1075	X 3	15	10	46
	11.00 - 11.40	432-1110	462-1110	X 4	15	10	55
	11.36 - 11.80	432-1140	462-1140	X 6	15	10	60
	11.76 - 12.24	432-1200	462-1200	X 8	21	14	72
		432-1200	462-1200	X 10	27	18	132
12	12.62 - 12.88	432-1275	462-1275	X 2	15	10	47
	12.75 - 13.20++	432-1300*	462-1300*	X 3	15	10	47
		432-1320	462-1320	X 4	15	10	60
	13.10 - 13.50	432-1320	462-1320	X 6	15	10	64
	13.70 - 14.09	432-1392	462-1392	X 8	21	14	90
	14.08 - 14.40	432-1420	462-1420	X 10	27	18	138
432-1420		462-1420	X 12	30	20	161	
14	15.20 - 15.60 15.80 - 16.20 16.38 - 16.78	432-1530 432-1600 432-1650	462-1530 462-1600 462-1650	X 2	15	10	74
				X 3	15	10	74
				X 4	15	10	80
				X 6	15	10	85
				X 8	21	14	114
				X 10	27	18	150
X 12	30	20	171				
16	17.40 - 17.80 17.75 - 18.15 18.58 - 18.98	432-1740 432-1800 432-1875	462-1740 462-1800 462-1875	X 2	15	10	78
				X 3	15	10	78
				X 4	15	10	78
				X 6	15	10	90
				X 8	21	14	126
				X 10	27	18	163
X 12	30	20	175				
18	19.30 - 19.70 19.80 - 20.20 21.20 - 21.40	432-1950 432-1990 432-2130	462-1950 462-1990 432-2130	X 3	15	10	80
				X 4	15	10	80
				X 6	15	10	90
				X 8	21	14	130
20	21.40 - 21.80 21.90 - 22.30 22.30 - 22.70	432-2160 432-2206 432-2250	462-2160 462-2206 462-2250	X 3	15	10	85
				X 4	15	10	85
				X 6	15	10	92
				X 8	21	14	136
24	23.45 - 23.85 25.60 - 26.00 26.20 - 26.60	432-2360 432-2580 432-2632	462-2360 462-2580 462-2632	X 3	15	10	105
				X 4	15	10	105
				X 6	15	10	125
				X 8	21	14	150

+NOTE: This size not available with a size on size outlet.

++NOTE: Recommended for IPS PVC, STEEL, C-900 PVC, Ductile Iron Pipe Diameters. Not recommended for Pit Cast Iron Pipe. For oversized or Pit Cast Iron Pipe, see next larger range.

*NOTE: Not available in 10" OR 12" outlet sizes

For larger sizes and outlets, see JCM 412 Tapping Sleeve or JCM 452 All Stainless Steel Tapping Sleeve.

HOW TO ORDER - JCM TAPPING SLEEVES

- Determine O.D. of pipe.
- Select proper sleeve O.D. range.
- Specify catalog number and outlet size.

Example: For PVC pipe with 8.63 O.D. with 6" outlet, order: 432-0863 x 6. For carbon steel flange, order 462-0863 x 6.



New From JCM Industries -

JCM 432 Type 2 Fabricated Lug Lightweight All Stainless Steel Tapping Sleeve

Responding to industry demand for an advanced, economical fabricated lug tapping sleeve, JCM introduces our New JCM 432 Type 2 Fabricated Lug Stainless Steel Tapping Sleeve. Using the popular structure of fabricated stainless steel bolting system with lifter plate, the JCM 432 Type 2 provides a reliable, cost-effective solution for tapping pipe.

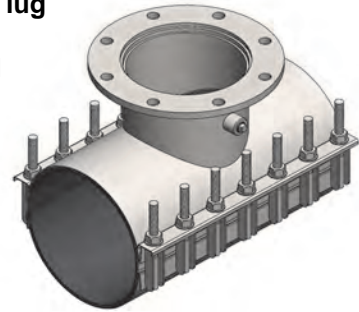

Heavy Stainless Steel Fabricated Lug System - eases installation and assists alignment of fasteners. Welded in place bolting studs reduces loose parts.

Full Circumferential Seal...The substantial, stainless steel body assures the gasket is sealed on the full circumference of the pipe. This provides insurance against beam breaks in size on size taps. Molded in recessed bridge plate assures even gasket pressure throughout the range of the sleeve.

Lighter Than Cast Sleeves...Robust stainless steel construction eliminates possible cracking of the sleeve or flange. Reduced weight speeds installation and reduces the load placed on the pipe.

Increased Width Provides Support And Stability...Wide body and heavy neck material provides reinforcement of the outlet and extra stability during the tapping process.

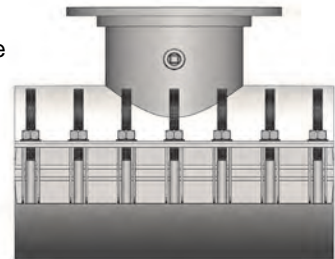

JCM 432 Type 2 - All stainless construction provides extra corrosion resistance. The stainless steel flange, outlet and body join as one unit of similar metals for highest structural strength and corrosion resistance.

JCM Tapping Sleeves meet or exceed the ANSI/AWWA C-223 and the MSS-SP 124 Standards as applicable

MATERIAL SPECIFICATIONS - JCM 432 Type 2 Fabricated Lug Lightweight Tapping Sleeves:

- Body:** Stainless Steel, 18-8 Type 304
- Hardware:** Stainless Steel, Type 304
- Branch Outlet:** Schedule 10 Stainless Steel Pipe. For size on size taps, outlets 11 gauge Stainless Steel Pipe
- Gasket:** Full circumferential gasket compounded for use with water, salt solutions, mild acids, bases and sewage.
- 432 Type 2 Flange:** Type 304 Stainless Steel, per ANSI/AWWA C228 Class SD ANSI 150lb. Drilling, recessed for tapping valve per MSS-SP 60.

HOW TO ORDER - JCM TAPPING SLEEVES

1. Determine O.D. of pipe.
2. Select proper sleeve O.D. range.
3. Specify SLEEVE number - outlet size and T2.

Example: For PVC pipe with 8.63 O.D. with 6" outlet, order: 432-0863 x 6 T2

JCM 432 Type 2 STAINLESS STEEL TAPPING SLEEVE DIMENSIONS

FLANGE SIZE	A	B	C	D	E	F
4	12	4	5-1/32	4.26	8	5/8
6	15	4-1/2	7-1/32	6.35	10	5/8
8	20	5	9-1/32	8.32	14	5/8
10	20	5-1/2	11-1/16	10.42	14	5/8
12	24	5-3/4	13-1/16	12.39	16	5/8

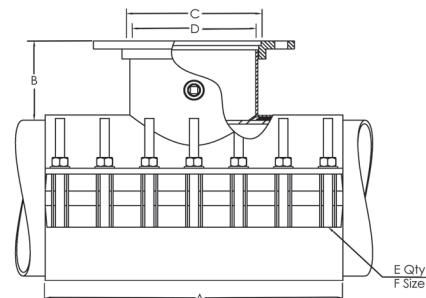

Stainless Steel Tapping Sleeve - Full Circumferential Gasket - Flanged Outlet JCM 432 Type 2 Fabricated Lug Lightweight Stainless Steel Flanged Outlet

NOM. PIPE SIZE (IN.)	SLEEVE O.D. RANGE (IN.)	MODEL 432 (T2) STAINLESS STEEL FLANGE CATALOG NUMBER	OUTLET SIZES	WIDTH OF SLEEVE	NUMBER OF BOLTS	APPR. WT. EA. LBS
6	6.40 - 6.80 6.80 - 7.20 7.20 - 7.60	432-0663 432-0690 432-0720	X 4	12	8	39
6 x 6 Size on Size	6.75 - 7.00 7.00 - 7.25	432-0690 432-0720	X 6*	15	10	43
8	8.40 - 8.80 8.80 - 9.20 9.20 - 9.60	432-0863 432-0905 432-0940	X 4 X 6	12 15	8 10	43 47
8 x 8 Size on Size	8.95 - 9.20 9.25 - 9.50	432-0905 432-0940	X 8*	20	14	64
10	10.55 - 10.95 10.90 - 11.30 11.30 - 11.70 11.90 - 12.30	432-1075 432-1110 432-1140 432-1200	X 4 X 6 X 8 X 10*	12 15 20 20	8 10 14 14	46 50 68 73
12	12.55 - 12.95 13.00 - 13.40 13.80 - 14.20	432-1275 432-1320 432-1420	X 4 X 6 X 8 X 10 X 12*	12 15 20 20 24	8 10 14 14 16	49 53 72 77 111
14	15.10 - 15.50 15.80 - 16.20 16.20 - 16.60	432-1530 432-1600 432-1650	X 4 X 6 X 8 X 10 X 12	12 15 20 20 24	8 10 14 14 16	70 74 93 98 132
16	17.40 - 17.80 17.80 - 18.20 18.40 - 18.80	432-1740 432-1800 432-1875	X 4 X 6 X 8 X 10 X 12	12 15 20 20 24	8 10 14 14 16	75 79 100 105 141

*Size on size sleeve require 1/2" undersized cutter.

For 2" or 3" outlets, other ranges or special ranges, see JCM 432 or 462 Tapping Sleeves Pages 68-69

For larger sizes and outlets, see JCM 452 or 464 Tapping Sleeves Pages 74-75

HOW TO ORDER - JCM TAPPING SLEEVES

1. Determine O.D. of pipe.
2. Select proper sleeve O.D. range.
3. Specify catalog number X outlet size, follow with T2.

Example: For PVC pipe with 8.63 O.D. with 6" outlet, order: 432-0863 x 6 T2.

DIMENSIONS for SIZE ON SIZE SLEEVES ONLY JCM 432 Type 2 STAINLESS STEEL TAPPING SLEEVES (Requires 1/2" undersized cutter)

FLANGE SIZE	A	B	C	D	E	F
4	12	4	5-1/32	4.00	8	5/8
6	15	4-1/2	7-1/32	6.00	10	5/8
8	20	5	9-1/32	8.00	14	5/8
10	20	5-1/2	11-1/16	10.00	14	5/8
12	24	5-3/4	13-1/16	12.00	16	5/8

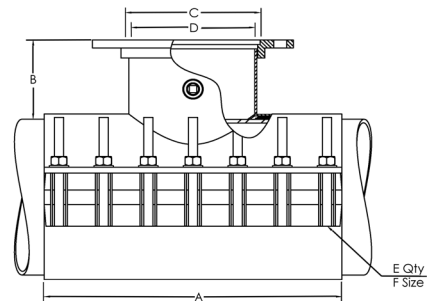

JCM Stainless Steel Tapping Sleeves with Mechanical Joint Outlet

Available,
JCM Mechanical Joint Outlet*
Tapping Sleeves

Great JCM Quality,
Great JCM Delivery
Reduce Application Costs
Reduce Valve Inventory
Available Immediately
Provide Load Bearing Set Pins

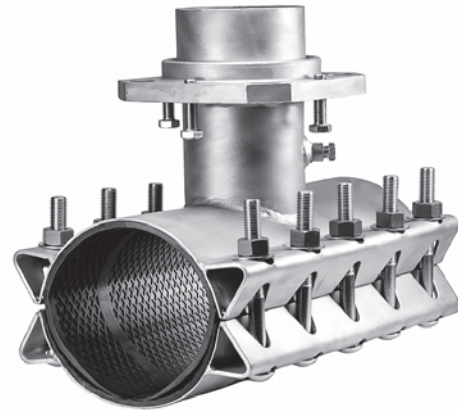

True Mechanical Joint Outlet - one cast piece creates a strong, corrosion resistant unit. No glued or attached parts to separate or cause misalignment. JCM Mechanical Joint Outlets meet AWWA C-111/ANSI 21.11 Standard Dimensions.

Durable - JCM Mechanical Joint Outlet Tapping Sleeves are fabricated of quality materials for long term service.

Load Bearing Set Pins - JCM Tapping Sleeves with MJ Outlet connections come furnished with load bearing set pins on the MJ outlet gland. After valve installation, the set pins are tightened against the face of the MJ valve flange, transferring any load and preventing movement or misalignment during or after the tap.

Strong pipe outlet - heavy duty neck outlet provides stability and a full size cutter bore. Standard lengths accommodate industry common tapping machine travel.

Consistent Inside Diameter Outlet - through the MJ flange outlet and through the pipe neck outlet. No modifications, changes or alterations that can interfere with cutter travel.

Quality Workmanship - JCM Tapping Sleeves with Mechanical Joint Outlets are manufactured of certifiable materials and are fabricated to the JCM standard quality recognized in the industry.

JCM 439/469 MJ Outlet Sleeve pressure rating with mechanical joint outlets:

Sleeves 4" – 12" nominal pipe sizes: 250 PSI working pressure, hydrostatic test pressure of 300 PSI.
Sleeves 14" – 24" nominal pipe sizes: 200 PSI working pressure, hydrostatic test pressure of 250 PSI

JCM MJ OUTLET TAPPING SLEEVES AVAILABLE IN THE FOLLOWING CONFIGURATIONS

All 304 Stainless Steel (Models 439, 459)

All 316 Stainless Steel (Models 6439, 6459)

Stainless Body/Neck with Carbon Steel Outlet (Models 469, 465)

All Fabricated Carbon Steel (Models 419, 429)

JCM Tapping Sleeves meet or exceed the ANSI/AWWA C-223 and the MSS-SP 124 Standards as applicable.

*Licensed by PowerSeal Corporation U.S. Patent No. 6,227,234.



Stainless Steel Tapping Sleeve - Full Circumferential Gasket - Mechanical Joint Outlet*
JCM 439 Stainless Steel Mechanical Joint Outlet
JCM 469 Carbon Steel Mechanical Joint Outlet
 JCM Mechanical Joint Outlets meet AWWA C-111/ANSI 21.11 Standard Dimensions

FULL CIRCUMFERENTIAL SEAL • EXTRA WIDTH • EXTRA BOLTING POWER

NOM. PIPE SIZE (IN.)	SLEEVE O.D. RANGE (IN.)	MODEL 439 STAINLESS STEEL MJ OUTLET	MODEL 469 CARBON STEEL MJ OUTLET	OUTLET SIZES	WIDTH OF SLEEVE	NUMBER OF BOLTS	APPR. WT. EACH (LBS.)
4	4.40 - 4.60	439-0450	469-0450				
	4.50 - 4.80	439-0465	469-0465	X 3	15	10	38
	4.74 - 5.00	439-0480	469-0480	X 4	15	10	40
	5.10 - 5.30	439-0520	469-0520				
6	6.56 - 6.90++	439-0663	469-0663	X 3^	15	10	45
	6.83 - 7.16	439-0690	469-0690	X 4	15	10	47
	7.05 - 7.40	439-0720	469-0720	X 6	15	10	49
	7.40 - 7.73	439-0745	439-0745				
8	8.54 - 8.74	439-0863	469-0863	X 3^	15	10	50
	8.60 - 9.05++	439-0900	469-0900	X 4	15	10	51
	8.98 - 9.37	439-0905	469-0905	X 6	15	10	54
	9.27 - 9.69	439-0940	469-0940	X 8	21	14	78
10	9.83 - 10.25+	439-1000	469-1000	X 3^	15	10	52
	10.64 - 10.86	439-1075	469-1075	X 4	15	10	55
	11.00 - 11.40	439-1110	469-1110	X 6	15	10	60
	11.36 - 11.80	439-1140	469-1140	X 8	21	14	82
	11.76 - 12.24	439-1200	469-1200	X 10	27	18	125
12	12.62 - 12.88	439-1275	469-1275	X 3^	15	10	58
	12.75 - 13.20++	439-1300**	469-1300**	X 4	15	10	60
	13.10 - 13.50	439-1320	469-1320	X 6	15	10	64
	13.70 - 14.09	439-1392	469-1392	X 8	21	14	90
	14.08 - 14.40	439-1420	469-1420	X 10	27	18	138
				X 12	30	20	161
14	15.20 - 15.60 15.80 - 16.20 16.38 - 16.78	439-1530 439-1600 439-1650	469-1530 469-1600 469-1650	X 3^	15	10	68
				X 4	15	10	70
				X 6	15	10	85
				X 8	21	14	114
				X 10	27	18	150
				X 12	30	20	171
16	17.40 - 17.80 17.75 - 18.15 18.58 - 18.98	439-1740 439-1800 439-1875	469-1740 469-1800 469-1875	X 3^	15	10	76
				X 4	15	10	78
				X 6	15	10	90
				X 8	21	14	126
				X 10	27	18	163
				X 12	30	20	175
18	19.30 - 19.70 19.80 - 20.20 21.20 - 21.40	439-1950 439-1990 439-2130	469-1950 469-1990 469-2130	X 3^	15	10	80
				X 4	15	10	80
				X 6	15	10	90
				X 8	21	14	130
20	21.40 - 21.80 21.90 - 22.30 22.30 - 22.70	439-2160 439-2206 439-2250	469-2160 469-2206 469-2250	X 3^	15	10	85
				X 4	15	10	85
				X 6	15	10	92
				X 8	21	14	136
24	23.45 - 23.85 25.60 - 26.00 26.20 - 26.60	439-2360 439-2580 439-2632	469-2360 469-2580 469-2632	X 3^	15	10	105
				X 4	15	10	105
				X 6	15	10	125
				X 8	21	14	150

+NOTE: This size not available with a size on size outlet.

++NOTE: Recommended for IPS PVC, STEEL, C-900 PVC, Ductile Iron Pipe Diameters.
 Not recommended for Pit Cast Iron Pipe.

For oversized or Pit Cast Iron Pipe, see next larger range.

**NOTE: Not available in 10" OR 12" outlet sizes

*Licensed by PowerSeal Corporation U. S. Patent No. 6,227,234



JCM Stainless Steel Tapping Sleeves with Outlet Seal Gasket

Available With Flanged Outlet or Mechanical Joint Outlet* in Stainless Steel or Carbon Steel

Rugged and Heavy Duty Stainless Tapping Sleeves Offer Extra Benefits.

- **Heavy Duty Design...**

Heavier construction and thicker metal provide extra reinforcement of the pipe and outlet. The extra bolting power and body thickness eliminate problems inherent with light weight sleeves. Reduced weight aids in installation and handling as well as reducing load on the pipe.

- **High Pressure Capability - High Safety Factor...**

The broad, heavy hydromechanical gasket provides for high working pressure applications. They are also ideal for critical problem prone taps such as pump and lift stations, large diameter mains and large outlets.

- **Large Sizes - High Pressure...**

The premier sleeve for larger sizes of ductile iron, PVC, PE and steel pipe, these sleeves are capable of working pressure of 1.5 times the valves commonly used with these types of pipe. Higher pressure sleeves are available on request.

- **Extra Wide for Support and Stability...**

Extra width and heavier neck and body material provide extra reinforcement of the outlet and extra stability during the tapping process.

- **Affordable...**

These stainless sleeves are surprisingly affordable in all sizes. Larger sleeves are priced less than ductile iron mechanical joint sleeves which offer less corrosion resistance and pressure capability.

MATERIAL SPECIFICATIONS

(Fitting dimensions - see JCM 412 Fabricated Tapping Sleeve)

Body: Stainless Steel, 18-8 Type 304. Optional 316 Stainless Steel.

Bolts: Stainless Steel, 18-8 Type 304. Optional 316 Stainless Steel.

Outlet: Heavy Stainless Steel Pipe. Optional 316 Stainless Steel.

Gasket: Nitrile Butadiene Rubber (NBR, Buna-N) per ASTM D2000. Molded virgin rubber with a pressure activated hydromechanical design. Gasket is bonded into a cavity for internal and external retention. Gasket temperature range -40°F to 212°F (-40°C - 100°C) Gasket suitable for water, salt solutions, mild acids, bases, and sewage. Optional gasket materials available.

452 Flange: 18-8 Type 304 Stainless Steel per ANSI/AWWA C228 Class SD. ANSI 150lb. Drilling, recessed for tapping valve per MSS-SP 60. Optional 316 Stainless Steel.

464 Flange: AWWA C207 Class D, ANSI 150lb. Drilling, recessed for tapping valve MSS-SP60.

459 MJ Outlet: CF8 Cast Stainless Steel - equivalent to 18-8 Type 304 Stainless Steel meets AWWA C-111/ANSI 21.11 Standard Dimensions. Optional 316 Stainless Steel.

465 MJ Outlet: Carbon Steel meets AWWA C-111/ANSI 21.11 Standard Dimensions

JCM Industries Tapping Sleeves meet or exceed the ANSI/AWWA C-223 and the MSS-SP 124 Standards as applicable.

*Licensed by PowerSeal Corporation U. S. Patent No. 6,227,234.

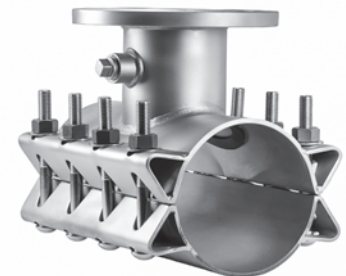

**JCM 452 - 464 Stainless Tapping Sleeve
Flanged Outlet**

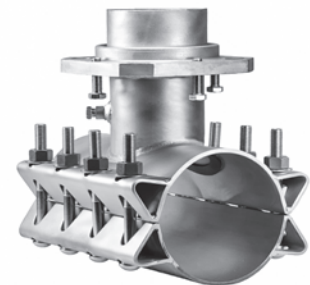

**JCM 459 - 465 Stainless Tapping Sleeve
Mechanical Joint Outlet***



Stainless Steel Tapping Sleeves - Outlet Seal Gasket - Flanged Outlet
JCM 452 Stainless Steel Flanged Outlet
JCM 464 Carbon Steel Flanged Outlet

OUTLET SEAL GASKET • HIGH PRESSURE CAPABILITY • HIGH SAFETY FACTOR • LARGE SIZES

NOM. PIPE SIZE (IN.)	SLEEVE O.D. RANGE (IN.)	MODEL 452 STAINLESS STEEL FLANGE	MODEL 464 CARBON STEEL FLANGE	OUTLET SIZES	APPROX. WEIGHT EACH
4	4.50	452-0450	464-0450	X 3	32
	4.80	452-0480	464-0480	X 4	32
6	6.63	452-0663	464-0663	X 3	74
	6.83 - 7.16	452-0690	464-0690	X 4	76
	7.05 - 7.40	452-0720	464-0720	X 6	82
	7.40 - 7.73	452-0745	464-0745		
8	8.63	452-0863	464-0863	X 3	83
	8.98 - 9.37	452-0905	464-0905	X 4	85
	9.27 - 9.69	452-0940	464-0940	X 6 X 8	88 118
10	9.83 - 10.25*	452-1000	464-1000	X 3	90
	10.64 - 10.86	452-1075	464-1075	X 4	92
	11.03 - 11.47	452-1110	464-1110	X 6	96
	11.36 - 11.80	452-1140	464-1140	X 8	125
	11.76 - 12.24	452-1200	464-1200	X 10	168
12	12.62 - 12.88	452-1275	464-1275	X 3	98
	13.13 - 13.60	452-1320	464-1320	X 4	100
	13.60 - 14.09	452-1392	464-1392	X 6	104
	14.08 - 14.56	452-1420	464-1420	X 8	140
				X 10 X 12	176 216
14	14.59 - 15.08	452-1475	464-1475	X 3	113
	15.23 - 15.80	452-1530	464-1530	X 4	115
	15.73 - 16.22	452-1600	464-1600	X 6	116
	16.30 - 16.73	452-1650	464-1650	X 8	150
				X 10 X 12	190 220
16	16.74 - 17.26	452-1684	464-1684	X 3	113
	17.33 - 17.87	452-1740	464-1740	X 4	115
	17.88 - 18.43	452-1800	464-1800	X 6	120
	18.62 - 19.19	452-1875	464-1875	X 8	162
				X 10 X 12	210 230
18	18.87 - 19.45	452-1920	464-1920	X 3	120
	19.41 - 20.01	452-1950	464-1950	X 4	122
	20.00 - 20.60	452-2000	464-2000	X 6	126
	20.29 - 20.94	452-2050	464-2050	X 8	180
	20.93 - 21.57	452-2130	464-2130	X 10 X 12	240 245
20	21.51 - 22.15	452-2160	464-2160	X 3	131
	22.16 - 22.81	452-2254	464-2254	X 4	133
	22.78 - 23.45	452-2294	464-2294	X 6	140
	23.46 - 24.16	452-2400	464-2400	X 8	185
	24.15 - 24.85	452-2450	464-2450	X 10	245
	24.82 - 25.52	452-2502	464-2502	X 12	255
24	25.71 - 26.41	452-2580	464-2580	X 3	143
	26.55 - 27.25	452-2715	464-2715	X 4	143
	27.26 - 27.96	452-2746	464-2746	X 6	160
	28.14 - 28.84	452-2834	464-2834	X 8	215
				X 10 X 12	280 312
30	29.78 - 30.48	452-3000	464-3000	X 3	163
	30.48 - 31.18	452-3075	464-3075	X 4	165
	31.52 - 32.22	452-3200	464-3200	X 6	175
				X 8 X 10 X 12	226 295 310

*These sizes not available with size on size outlets.

JCM 452/464 Tapping Sleeves furnished with test plugs unless otherwise specified.

For size on size outlets a 1/2" undersize shell cutter is required.

Pipe sizes 72" and larger available upon request.

For outlets 14" and larger, the tapping valve to be used must be specified to assure proper alignment recess dimension.



Certified to NSF/ANSI 61

Stainless Steel Tapping Sleeves - Outlet Seal Gasket - Mechanical Joint Outlet*

JCM 459 Stainless Steel Mechanical Joint Outlet

JCM Mechanical Joint Outlets meet AWWA

JCM 465 Carbon Steel Mechanical Joint Outlet

C-111/ANSI 21.11 Standard Dimensions

NOM. PIPE SIZE (IN.)	SLEEVE O.D. RANGE (IN.)	MODEL 459 STAINLESS STEEL MJ OUTLET	MODEL 465 CARBON STEEL MJ OUTLET	OUTLET SIZES	APPROX. WEIGHT EACH
4	4.50	459-0450	465-0450	X 3	32
	4.80	459-0480	465-0480	X 4	35
6	6.63	459-0663	465-0663	X 3 ^A	74
	6.83 - 7.16	459-0690	465-0690	X 4	76
	7.05 - 7.40	459-0720	465-0720	X 6	82
	7.40 - 7.73	459-0745	465-0745		
8	8.63	459-0863	465-0863	X 3 ^A	82
	8.98 - 9.37	459-0905	465-0905	X 4	85
	9.27 - 9.69	459-0940	465-0940	X 6	88
				X 8	118
10	9.83 - 10.25**	459-1000	465-1000	X 3 ^A	89
	10.64 - 10.86	459-1075	465-1075	X 4	92
	11.03 - 11.47	459-1110	465-1110	X 6	96
	11.36 - 11.80	459-1140	465-1140	X 8	125
	11.76 - 12.24	459-1200	465-1200	X 10	168
12	12.62 - 12.88	459-1275	465-1275	X 3 ^A	95
	13.13 - 13.60	459-1320	465-1320	X 4	100
	13.60 - 14.09	459-1392	465-1392	X 6	104
	14.08 - 14.56	459-1420	465-1420	X 8	140
				X 10	176
			X 12	216	
14	14.59 - 15.08	459-1475	465-1475	X 3 ^A	102
	15.23 - 15.80	459-1530	465-1530	X 4	115
	15.73 - 16.22	459-1600	465-1600	X 6	116
	16.30 - 16.73	459-1650	465-1650	X 8	150
				X 10	190
			X 12	220	
16	16.74 - 17.26	459-1684	465-1684	X 3 ^A	102
	17.33 - 17.87	459-1740	465-1740	X 4	115
	17.88 - 18.43	459-1800	465-1800	X 6	120
	18.62 - 19.19	459-1875	465-1875	X 8	162
				X 10	210
			X 12	230	
18	18.87 - 19.45	459-1920	465-1920	X 3 ^A	115
	19.41 - 20.01	459-1950	465-1950	X 4	122
	20.00 - 20.60	459-2000	465-2000	X 6	126
	20.29 - 20.94	459-2050	465-2050	X 8	180
	20.93 - 21.57	459-2130	465-2130	X 10	240
			X 12	245	
20	21.51 - 22.15	459-2160	465-2160	X 3 ^A	125
	22.16 - 22.81	459-2254	465-2254	X 4	133
	22.78 - 23.45	459-2294	465-2294	X 6	140
	23.46 - 24.16	459-2400	465-2400	X 8	185
	24.15 - 24.85	459-2450	465-2450	X 10	245
	24.82 - 25.52	459-2502	465-2502	X 12	255
24	25.71 - 26.41	459-2580	465-2580	X 3 ^A	138
	26.55 - 27.25	459-2715	465-2715	X 4	143
	27.26 - 27.96	459-2746	465-2746	X 6	160
	28.14 - 28.84	459-2834	465-2834	X 8	215
				X 10	280
			X 12	312	
30	29.78 - 30.48	459-3000	465-3000	X 3 ^A	159
	30.48 - 31.18	459-3075	465-3075	X 4	165
	31.52 - 32.22	459-3200	465-3200	X 6	175
				X 8	226
			X 10	295	
			X 12	310	

**These sizes not available with size on size outlets

JCM 459/465 Tapping Sleeves furnished with test plugs unless otherwise specified.

For size on size outlets a 1/2" undersize shell cutter is required.

Outlet sizes 14" & 16" available in Stainless Steel.

Larger outlets and pipe sizes 72" and larger available upon request

*Licensed by PowerSeal Corporation U. S. Patent No. 6,227,234



JCM Weld On Tapping Outlets

Weld-on outlets & connections are dependable and economical with JCM Weld On Fittings

Outlets, partial sleeves and complete sleeves are readily available for steel pipe 6" and larger with size on size and reducing outlets. Outlets and partial sleeves are also available for tank and bulkhead use. Various configurations of this design are available. Featured below are the most popular.

MATERIAL SPECIFICATIONS - JCM WELD ON OUTLETS AND SLEEVES

Body: ASTM A283, A285 Grade C, ASTM A-36 Steel or equal. Optional 304 or 316 Stainless Steel.

Finish: Heavy coat of corrosion resistant metal primer. Optional Fusion Epoxy Coating available.

Flange: AWWA C207 Class D, ANSI 150 drilling recessed for tapping valve per MSS-SP60. Other flanges available.

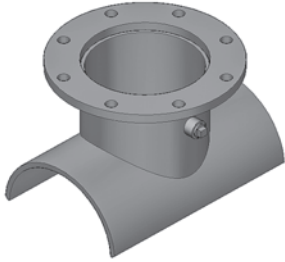

**416 Type 1:
Weld On Outlet**

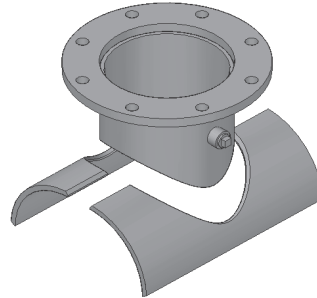

**416 Type 2:
Split Tee
Three Piece Weld On Saddle**

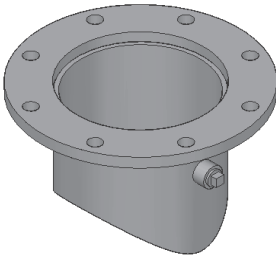

**416 Type 3:
Flanged Nozzle
Weld On Outlet**

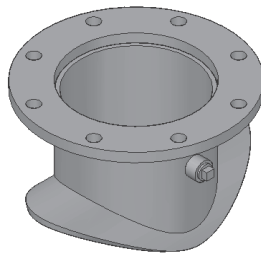

**416 Type 4:
Hat Flange Weld On
Outlet**

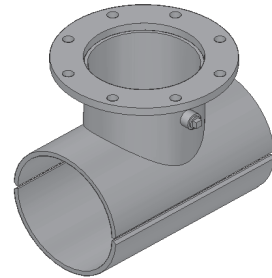

**417 Type 1:
Split Tee
Weld On Tapping Sleeve**

Other configurations
available upon
request.

HOW TO ORDER - JCM WELD ON OUTLETS

1. Determine pipe O.D. and outlet size. Each sleeve is fabricated to the exact O.D. of the pipe.
2. Determine sleeve type required.

For Standard Type 1 416 Weld On Outlet for steel pipe with 6.63 O.D. with 6" outlet, order: 476-0663 x 6 Type1.

Other configurations and designs available.

Standard outlet flange is AWWA C207 Class D, ANSI 150lb Drilling, recessed for tapping valve MSS-SP60. Other flanges available upon request.

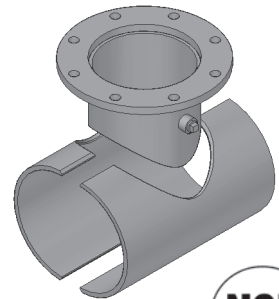

JCM 440 Line Stop Sleeves

440 Type Material Specifications

All 440 Line Stop Fitting Types:

Line Stop Plug:	Ductile Iron per ASTM A536
Plug O-Ring:	Nitrile (NBR, Buna-N) Rubber - Gasket temperature range -40° to 180°F (-40°C to 82°C).
Blind Flange:	150#, ASTM A36 Carbon Steel, Epoxy Coated
Blind Flange Gasket:	Styrene-Butadiene Rubber (SBR) - Compounded for use with water, salt solutions, mild acids and bases. Standard temperature range from -40° to 150°F (-40° to 65°C) constant, maximum intermittent 180°F (82°C).
Push Plug/Pin Hardware:	SAE Grade 8

440 Type 1 440 Type 11	Body: Stainless Steel, 18-8 Type 304 Flange: ASME/ANSI 150 lb. Drilling, B16.1 Class 125 Compatible, Type 304 Stainless Steel, recess for tapping valve MSS-SP60 Bolts: Stainless Steel 18-8 Type 304. Gasket: Full circumferential Virgin Styrene-Butadiene Rubber (SBR) - Compounded for use with water, salt solutions, mild acids and bases. Per ASTM D-2000 M4AA 607. Standard temperature range from -40° to 150°F (-40° to 65°C) constant, maximum intermittent 180°F (82°C).
440 Type 2 440 Type 12	Body: ASTM A285 Grade C or A36 Carbon Steel or Equal Flange: ASME/ANSI 150 lb. Drilling, B16.1 Class 125 Compatible, Carbon Steel, recess for tapping valve MSS-SP60 Bolts: ASTM A242 corrosion resistant high strength, low alloy (per ANSI 21.11/AWWA C-111). Optional Stainless Steel 18-8 Type 304 or 316 available. Finish: Heavy coat of corrosion resistant shop coat primer. Optional fusion applied Epoxy Coating per ANSI/AWWA C213 Standard. Gasket: Nitrile Butadiene Rubber (NBR, Buna-N) per ASTM D2000. Molded virgin rubber with a pressure activated hydro mechanical design. Gasket is bonded into a cavity for internal and external retention. Gasket temperature range -40° to 180°F (-40° - 82°C). Gasket suitable for water, salt solutions, mild acids, bases, and sewage.
440 Type 3 440 Type 13	Body: Stainless Steel, 18-8 Type 304 Flange: ASME/ANSI 150 lb. Drilling, B16.1 Class 125 Compatible, Type 304 Stainless Steel, recess for tapping valve MSS-SP60 Bolts: Stainless Steel 18-8 Type 304. Gasket: Nitrile Butadiene Rubber (NBR, Buna-N) per ASTM D2000. Molded virgin rubber with a pressure activated hydro mechanical design. Gasket is bonded into a cavity for internal and external retention. Gasket temperature range -40° to 180°F (-40° - 82°C). Gasket suitable for water, salt solutions, mild acids, bases, and sewage.
440 Type 4 440 Type 14	Body: Stainless Steel, 18-8 Type 304 Flange: ASME/ANSI 150 lb. Drilling, B16.1 Class 125 Compatible, Carbon Steel, recess for tapping valve MSS-SP60, shop coat for corrosion resistance. Bolts: Stainless Steel 18-8 Type 304. Gasket: Full circumferential Virgin Styrene-Butadiene Rubber (SBR) - Compounded for use with water, salt solutions, mild acids and bases. Per ASTM D-2000 M4AA 607. Standard temperature range from -40° to 150°F (-40° to 65°C) constant, maximum intermittent 180°F (82°C).
440 Type 5 440 Type 15	Body: Stainless Steel, 18-8 Type 304 Flange: ASME/ANSI 150 lb. Drilling, B16.1 Class 125 Compatible, Carbon Steel, recess for tapping valve MSS-SP60, shop coat for corrosion resistance. Bolts: Stainless Steel 18-8 Type 304. Gasket: Nitrile Butadiene Rubber (NBR, Buna-N) per ASTM D2000. Molded virgin rubber with a pressure activated hydro mechanical design. Gasket is bonded into a cavity for internal and external retention. Gasket temperature range -40° to 180°F (-40° - 82° C). Gasket suitable for water, salt solutions, mild acids, bases, and sewage.

U.S. Patent No. 8176929



JCM Line Stop Fittings with Full Circumferential Gasket

The 440 Line Stop Sleeve Family offers the sleeve you need for the application. As the **NUMBER ONE** choice of contractors, JCM continues to meet the challenge of field application requirements with product design, material selection and delivery expectations.

JCM 440 Line Stop Family continues to grow with advanced designs, material combinations and numerous options to fit your application.

JCM's patented Line Stop Sleeves adapt to popular line stop machines and can be rated up to 250 PSI.

JCM Line Stop Sleeves with Full Circumferential Gasket are designed for applications in which the pipe is susceptible to breaking during or after the tapping/line stop procedure. JCM 440 Line Stops with Full Circumferential Gasket are offered in two fabricated material combinations: All Stainless Steel or Stainless Steel with Carbon Steel Outlet.

Both sleeves are offered with either the "threaded plug" design or the "push plug" design.

JCM 440 Line Stop Sleeves with Full Circumferential Gasket Material Specifications

Line Stop Plug: Ductile Iron per ASTM A536

Plug O-Ring: Nitrile (NBR, Buna-N) Rubber - Gasket temperature range -40° to 180°F (-40°C to 82°C).

Blind Flange: 150#, ASTM A36 Carbon Steel, Epoxy Coated



Blind Flange Gasket: Styrene-Butadiene Rubber (SBR) - Compounded for use with water, salt solutions, mild acids and bases. Standard temperature range from -40° to 150°F (-40° to 65°C) constant, maximum intermittent 180°F (82°C).

Push Plug/Pin Hardware: SAE Grade 8

Bolts: Stainless Steel 18-8 Type 304.

Body: Stainless Steel, 18-8 Type 304

Body Gasket: Full circumferential virgin Styrene-Butadiene Rubber (SBR) - Compounded for use with water, salt solutions, mild acids and bases. Per ASTM D-2000 M4AA 607. Standard temperature range from -40° to 150°F (-40° to 65°C) constant, maximum intermittent 180°F (82°C)..

440 Line Stop Sleeve	Outlet Material Options for Stainless Steel Full Circumferential Gasket Sleeve
	<p>JCM 440 Type 1 - All Stainless Steel with Full Circumferential Gasket - Threaded Plug JCM 440 Type 11 - All Stainless Steel with Full Circumferential Gasket - Push Plug/Pin</p> <p>Outlet Material: ASME/ANSI 150 lb. Drilling, B16.1 Class 125 Compatible, Type 304 Stainless Steel, recess for tapping valve MSS-SP60</p>
	<p>JCM 440 Type 4 - Stainless Steel Carbon Steel Outlet Full Circumferential Gasket - Threaded Plug JCM 440 Type 14 - Stainless Steel Carbon Steel Outlet Full Circumferential Gasket - Push Plug/Pin</p> <p>Outlet Material: ASME/ANSI 150 lb. Drilling, B16.1 Class 125 Compatible, Carbon Steel, recess for tapping valve MSS-SP60, shop coated for corrosion resistance. Optional: Fusion applied epoxy coating.</p>

1. Determine O.D. of pipe
2. Select proper catalog number
3. Select proper outlet size
4. Select proper outlet plug type code (threaded or push/pin)
5. Add Outlet Type Code (T1 or T11)

Example: For Ductile Iron with 6.90 O.D. with threaded plug, order: 440-0690 T1

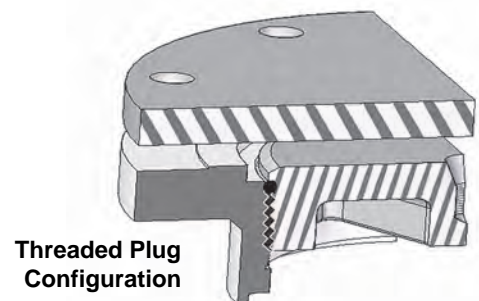
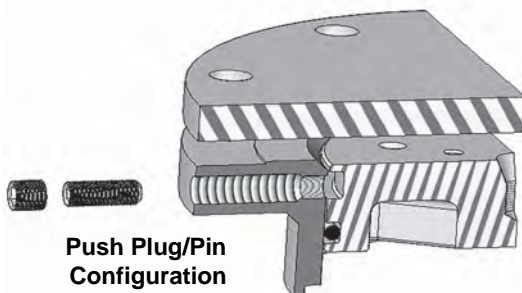



JCM 440 Type 1 Line Stop with Full Circumferential Gasket - Threaded Plug
JCM 440 Type 11 Line Stop with Full Circumferential Gasket - Push Plug/Pin
All Stainless Steel Construction - Full Circumferential Gasket

Recommended for: cast iron, ductile iron, asbestos cement, PVC and other types of pipe susceptible to breakage.

NOMINAL PIPE SIZE (IN.)	SLEEVE O.D. RANGE (IN.)	CATALOG NUMBER X OUTLET SIZE X PLUG CODE	OUTLET SIZE	THREADED PLUG TYPE CODE	PUSH PLUG/PIN TYPE CODE	APPROX. WEIGHT (LBS.)
4	4.40 - 4.60	440-0450	x 4	T1	T11	56
	4.50 - 4.80	440-0465		T1	T11	
	4.74 - 5.00	440-0480		T1	T11	
	5.10 - 5.30	440-0520		T1	T11	
6	6.56 - 6.76	440-0663	x 4	T1	T11	63 81
	6.84 - 7.10	440-0690		T1	T11	
	7.05 - 7.25	440-0720	x 6	T1	T11	
	7.40 - 7.65	440-0745		T1	T11	
8	8.54 - 8.74	440-0863	x 6	T1	T11	86 132
	8.60 - 9.05	440-0900		T1	T11	
	8.98 - 9.30	440-0905	x 8	T1	T11	
	9.27 - 9.50	440-0940		T1	T11	
10	9.83 - 10.25	440-1000	x 8 x10	T1	T11	126 192
	10.64 - 10.86	440-1075		T1	T11	
	11.03 - 11.40	440-1110		T1	T11	
	11.36 - 11.80	440-1140		T1	T11	
	11.85 - 12.15	440-1200		T1	T11	
12	12.62 - 12.85	440-1275	x 8 x 12	T1	T11	144 269
	12.75 - 13.20	440-1300		T1	T11	
	13.12 - 13.50	440-1320		T1	T11	
	13.70 - 14.09	440-1392		T1	T11	
	14.10 - 14.35	440-1420		T1	T11	



JCM 440 Type 4 Line Stop Full Circumferential Gasket - Threaded Plug
JCM 440 Type 14 Line Stop Full Circumferential Gasket - Push Plug/Pin
Stainless Steel Body - Carbon Steel Outlet - Full Circumferential Gasket

Recommended for: cast iron, ductile iron, asbestos cement, PVC and other types of pipe susceptible to breakage.



NOMINAL PIPE SIZE (IN.)	SLEEVE O.D. RANGE (IN.)	CATALOG NUMBER X OUTLET SIZE X PLUG CODE	OUTLET SIZE	THREADED PLUG TYPE CODE	PUSH PLUG/PIN TYPE CODE	APPROX. WEIGHT (LBS.)
4	4.40 - 4.60	440-0450	x 4	T4	T14	56
	4.50 - 4.80	440-0465		T4	T14	
	4.74 - 5.00	440-0480		T4	T14	
	5.10 - 5.30	440-0520		T4	T14	
6	6.56 - 6.76	440-0663	x 4	T4	T14	63 81
	6.84 - 7.10	440-0690		T4	T14	
	7.05 - 7.25	440-0720	x 6	T4	T14	
	7.40 - 7.65	440-0745		T4	T14	
8	8.54 - 8.74	440-0863	x 6	T4	T14	86 132
	8.60 - 9.05	440-0900		T4	T14	
	8.98 - 9.30	440-0905	x 8	T4	T14	
	9.27 - 9.50	440-0940		T4	T14	
10	9.83 - 10.25	440-1000	x 8 x 10	T4	T14	126 192
	10.64 - 10.86	440-1075		T4	T14	
	11.03 - 11.40	440-1110		T4	T14	
	11.36 - 11.80	440-1140		T4	T14	
	11.85 - 12.15	440-1200		T4	T14	
12	12.62 - 12.85	440-1275	x 8 x 12	T4	T14	144 269
	12.75 - 13.20	440-1300		T4	T14	
	13.12 - 13.50	440-1320		T4	T14	
	13.70 - 14.09	440-1392		T4	T14	
	14.10 - 14.35	440-1420		T4	T14	

Other sleeve ranges and outlet sizes available upon request.

U.S. Patent No. 8176929

JCM Line Stop Fittings with Outlet Seal Gasket

The JCM 440 Line Stop Fitting with Outlet Seal Gasket are fabricated for types of pipe that are not susceptible to breaking and for large diameter pipelines. JCM offers the broadest selection of material combination in the industry and can meet the exacting standards of your application. Fabrication materials include: carbon steel, carbon/stainless and all stainless steel. JCM patented Line Stop Sleeves adapt to popular line stop machines and can be rated up to 250 PSI. Other designs available: weld-on outlets and sleeves, mechanical joint sleeves, specialty configurations. All combinations are available with “threaded plug” design or “push plug” design.

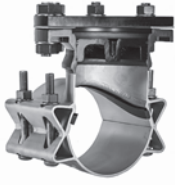
440 Line Stop Sleeve	Outlet Gasket Sleeve Description
	<p>JCM 440 Type 2 - Carbon Steel Construction - Outlet Seal Gasket - Threaded Plug JCM 440 Type 12 - Carbon Steel Construction - Outlet Seal Gasket - Push Plug/pin</p> <p>Pipe Sizes: 4" - 20" and larger Optional epoxy coating per ANSI/AWWA Standard C213 Optional Hardware 304 or 316 stainless Optional gasket materials. Recommended for: cast iron, ductile iron, C-900/C905 PVC, HDPE, steel</p>
	<p>JCM 440 Type 3 - All Stainless Steel Construction - Outlet Seal Gasket - Threaded Plug JCM 440 Type 13 - All Stainless Steel Construction - Outlet Seal Gasket - Push Plug Pin</p> <p>Pipe Sizes: 4" - 20" and larger Optional gasket materials Recommended for: cast iron, ductile iron, C-900/C905 PVC, HDPE, steel</p>
	<p>JCM 440 Type 5 - Stainless Steel Body - Carbon Steel Outlet - Outlet Seal Gasket - Threaded Plug JCM 440 Type 15 - Stainless Steel Body - Carbon Steel Outlet - Outlet Seal Gasket - Push Plug Pin</p> <p>Pipe Sizes: 4" - 20" and larger Optional gasket materials Recommended for: cast iron, ductile iron, C-900/C905 PVC, HDPE, steel</p>

How To Order:

1. Determine O.D. of pipe
2. Select proper catalog number
3. Select proper outlet size
4. Select proper outlet plug type code (threaded or push/pin)
5. Add Outlet Type Code (T2 or T12)

Example: For Ductile Iron with 6.90 O.D. with threaded plug, order: 440-0690 T2

Other sleeve size and outlet size combinations available upon request.

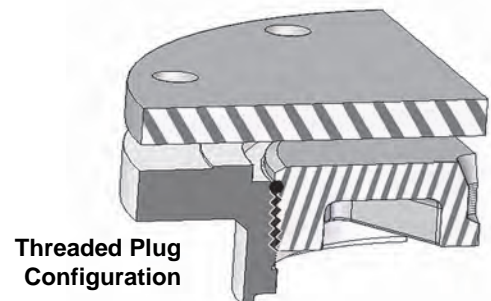
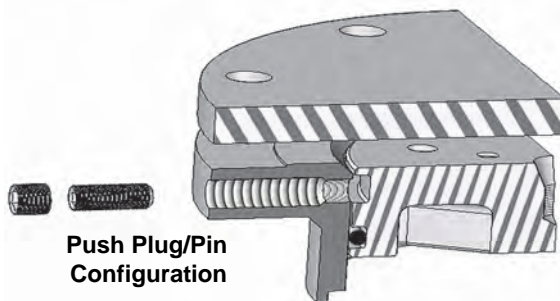

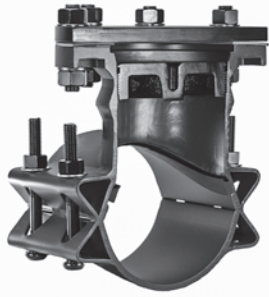

JCM 440 Type 2 - Carbon Steel - Outlet Seal Gasket - Threaded Plug
JCM 440 Type 12 - Carbon Steel - Outlet Seal Gasket - Push Plug/Pin

Furnished standard shopcoat with alloy hardware

- Line Stop Plug:** Ductile Iron per ASTM A536
- Plug O-Ring:** Nitrile (NBR, Buna-N) Rubber - Gasket temperature range -40° to 180°F (-40°C to 82°C).
- Blind Flange:** 150#, ASTM A36 Carbon Steel, Epoxy Coated
- Blind Flange Gasket:** Styrene-Butadiene Rubber (SBR) - for use with water, salt solutions, mild acids and bases. Standard temperature range from -40° to 150°F (-40° to 65°C) constant, maximum intermittent 180°F (82°C).
- Push Plug/Pins:** SAE Grade 8
- Outlet Gasket:** Nitrile Butadiene Rubber (NBR, Buna-N) per ASTM D2000. Molded virgin rubber with a pressure activated hydromechanical design. Gasket is bonded into a cavity for internal and external retention. Gasket temperature range -40° to 180°F (-40° - 82°C). Gasket suitable for water, salt solutions, mild acids, bases, and sewage.
- Body:** ASTM A285 Grade C or A36 Carbon Steel or Equal
- Flange:** ASME/ANSI 150 lb. Drilling, B16.1 Class 125 Compatible, Carbon Steel
Flange recess for tapping valve MSS-SP60
- Bolts:** ASTM A242 corrosion resistant high strength, low alloy (per ANSI 21.11/AWWA C-111).
Optional Stainless Steel 18-8 Type 304 or 316 available.

JCM 440 Type 2 - Carbon Steel - Outlet Seal Gasket - Threaded Plug
JCM 440 Type 12 - Carbon Steel - Outlet Seal Gasket - Push Plug/Pin

NOMINAL PIPE SIZE (IN.)	SLEEVE O.D. RANGE (IN.)	CATALOG NUMBER X OUTLET SIZE X PLUG CODE	OUTLET SIZE	THREADED PLUG TYPE CODE	PUSH PLUG/PIN TYPE CODE	APPROX. WEIGHT (LBS.)	
4	4.50	440-0450	x 4	T2	T12	48	
	4.80	440-0480		T2	T12		
	5.20	440-0520		T2	T12		
	5.56	440-0556		T2	T12		
6	6.63	440-0663	x 4	T2	T12	92	
	6.84 - 7.10	440-0690		T2	T12		
	7.05 - 7.25	440-0720	x 6	T2	T12		
	7.40 - 7.65	440-0745		T2	T12		
8	8.63	440-0863	x 6	T2	T12	120	
	8.98 - 9.30	440-0905		T2	T12		
	9.27 - 9.50	440-0940	x 8	T2	T12		
	9.83 - 10.25	440-1000		T2	T12		
10	10.64 - 10.86	440-1075	x 8	T2	T12	179	
	11.03 - 11.40	440-1110		T2	T12		
	11.36 - 11.80	440-1140		x 10	T2		T12
	11.85 - 12.15	440-1200			T2		T12
12	12.62 - 12.85	440-1275	x 8	T2	T12	194	
	13.12 - 13.50	440-1320		T2	T12		
	13.70 - 14.09	440-1392	x 12	T2	T12		
	14.10 - 14.35	440-1420		T2	T12		
14	14.59 - 15.08	440-1475	x 12	T2	T12	328	
	15.23 - 15.80	440-1530		T2	T12		
	15.73 - 16.22	440-1600		T2	T12		
	16.30 - 16.73	440-1650		T2	T12		
16	16.74 - 17.26	440-1684	x 12	T2	T12	338	
	17.33 - 17.87	440-1740		T2	T12		
	17.88 - 18.43	440-1800		T2	T12		
	18.62 - 19.19	440-1875		T2	T12		
18	18.87 - 19.45	440-1920	x 12	T2	T12	353	
	19.41 - 20.01	440-1950		T2	T12		
	20.00 - 20.60	440-2000		T2	T12		
	20.29 - 20.94	440-2050		T2	T12		
	20.93 - 21.57	440-2130		T2	T12		
20	21.51 - 22.15	440-2160	x 12	T2	T12	363	
	22.16 - 22.81	440-2254		T2	T12		
	22.78 - 23.45	440-2294		T2	T12		
	23.46 - 24.16	440-2400		T2	T12		
	24.15 - 24.85	440-2450		T2	T12		
	24.82 - 25.52	440-2502		T2	T12		

Other sleeve ranges and outlet sizes available upon request.

U.S. Patent No. 8176929



JCM 440 Type 3 - All Stainless Steel - Outlet Seal Gasket - Threaded Plug
JCM 440 Type 13 - All Stainless Steel - Outlet Seal Gasket - Push Plug/Pin

- Line Stop Plug:** Ductile Iron per ASTM A536
- Plug O-Ring:** Nitrile (NBR, Buna-N) Rubber - Gasket temperature range -40° to 180°F (-40°C to 82°C).
- Blind Flange:** 150#, ASTM A36 Carbon Steel, Epoxy Coated
- Blind Flange Gasket:** Styrene-Butadiene Rubber (SBR) - for use with water, salt solutions, mild acids and bases. Standard temperature range from -40° to 150°F (-40° to 65°C) constant, maximum intermittent 180°F (82°C).
- Push Plug/Pins:** SAE Grade 8
- Outlet Gasket:** Nitrile Butadiene Rubber (NBR, Buna-N) per ASTM D2000. Molded virgin rubber with a pressure activated hydromechanical design. Gasket is bonded into a cavity for internal and external retention. Gasket temperature range -40° to 180°F (-40° - 82° C). Gasket suitable for water, salt solutions, mild acids, bases, and sewage.
- Body:** Stainless Steel, 18-8 Type 304
- Flange:** ASME/ANSI 150 lb. Drilling, B16.1 Class 125 Compatible, Type 304 Stainless Steel, recess for tapping valve MSS-SP60
- Bolts:** Stainless Steel 18-8 Type 304.

JCM 440 Type 3 - All Stainless Steel - Outlet Seal Gasket - Threaded Plug
JCM 440 Type 13 - All Stainless Steel - Outlet Seal Gasket - Push Plug/Pin

NOMINAL PIPE SIZE (IN.)	SLEEVE O.D. RANGE (IN.)	CATALOG NUMBER X OUTLET SIZE X PLUG CODE	OUTLET SIZE	THREADED PLUG TYPE CODE	PUSH PLUG/PIN TYPE CODE	APPROX. WEIGHT (LBS.)
4	4.50	440-0450	x 4	T3	T13	48
	4.80	440-0480		T3	T13	
	5.20	440-0520		T3	T13	
	5.56	440-0556		T3	T13	
6	6.63	440-0663	x 4	T3	T13	92 114
	6.84 - 7.10	440-0690		T3	T13	
	7.05 - 7.25	440-0720	x 6	T3	T13	
	7.40 - 7.65	440-0745	T3	T13		
8	8.63	440-0863	x 6	T3	T13	120 172
	8.98 - 9.30	440-0905		T3	T13	
	9.27 - 9.50	440-0940	x 8	T3	T13	
	9.83 -10.25	440-1000	T3	T13		
10	10.64 - 10.86	440-1075	x 8	T3	T13	179 267
	11.03 - 11.40	440-1110		T3	T13	
	11.36 - 11.80	440-1140	x 10	T3	T13	
	11.85 - 12.15	440-1200	T3	T13		
12	12.62 - 12.85	440-1275	x 8	T3	T13	194 324
	13.12 - 13.50	440-1320		T3	T13	
	13.70 - 14.09	440-1392	x 12	T3	T13	
	14.10 - 14.35	440-1420	T3	T13		
14	14.59 - 15.08	440-1475	x 12	T3	T13	328
	15.23 - 15.80	440-1530		T3	T13	
	15.73 - 16.22	440-1600	T3	T13		
	16.30 - 16.73	440-1650	T3	T13		
16	16.74 - 17.26	440-1684	x 12	T3	T13	338
	17.33 - 17.87	440-1740		T3	T13	
	17.88 - 18.43	440-1800	T3	T13		
	18.62 - 19.19	440-1875	T3	T13		
18	18.87 - 19.45	440-1920	x 12	T3	T13	353
	19.41 - 20.01	440-1950		T3	T13	
	20.00 - 20.60	440-2000		T3	T13	
	20.29 - 20.94	440-2050		T3	T13	
	20.93 - 21.57	440-2130		T3	T13	
20	21.51 - 22.15	440-2160	x 12	T3	T13	363
	22.16 - 22.81	440-2254		T3	T13	
	22.78 - 23.45	440-2294		T3	T13	
	23.46 - 24.16	440-2400		T3	T13	
	24.15 - 24.85	440-2450		T3	T13	
	24.82 - 25.52	440-2502		T3	T13	

Other sleeve ranges and outlet sizes available upon request.

U.S. Patent No. 8176929

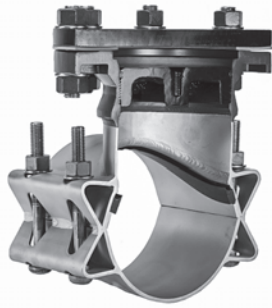

JCM 440 Type 5 - Stainless Body - Carbon Steel Outlet - Outlet Seal Gasket - Threaded Plug
JCM 440 Type 15 - Stainless Body - Carbon Steel Outlet - Outlet Seal Gasket - Push Plug/Pin

- Line Stop Plug:** Ductile Iron per ASTM A536
- Plug O-Ring:** Nitrile (NBR, Buna-N) Rubber - Gasket temperature range -40° to 180°F (-40°C to 82°C).
- Blind Flange:** 150#, ASTM A36 Carbon Steel, Epoxy Coated
- Blind Flange Gasket:** Styrene-Butadiene Rubber (SBR) - for use with water, salt solutions, mild acids and bases. Standard temperature range from -40° to 150°F (-40° to 65°C) constant, maximum intermittent 180°F (82°C).
- Push Plug/Pins:** SAE Grade 8
- Outlet Gasket:** Nitrile Butadiene Rubber (NBR, Buna-N) per ASTM D2000. Molded virgin rubber with a pressure activated hydromechanical design. Gasket is bonded into a cavity for internal and external retention. Gasket temperature range -40° to 180°F (-40° - 82° C). Gasket suitable for water, salt solutions, mild acids, bases, and sewage.
- Body:** Stainless Steel, 18-8 Type 304
- Flange:** ASME/ANSI 150 lb. Drilling, B16.1 Class 125 Compatible, Carbon Steel, recess for tapping valve MSS-SP60, shop coat for corrosion resistance. Optional: Fusion applied epoxy coating.
- Bolts:** Stainless Steel 18-8 Type 304.

JCM 440 Type 5 - Stainless Body - Carbon Steel Outlet - Outlet Seal Gasket - Threaded Plug
JCM 440 Type 15 - Stainless Body - Carbon Steel Outlet - Outlet Seal Gasket - Push Plug/Pin

NOMINAL PIPE SIZE (IN.)	SLEEVE O.D. RANGE (IN.)	CATALOG NUMBER X OUTLET SIZE X PLUG CODE	OUTLET SIZE	THREADED PLUG TYPE CODE	PUSH PLUG/PIN TYPE CODE	APPROX. WEIGHT (LBS.)
4	4.50	440-0450	x 4	T5	T15	48
	4.80	440-0480		T5	T15	
	5.20	440-0520		T5	T15	
	5.56	440-0556		T5	T15	
6	6.63	440-0663	x 4	T5	T15	92 114
	6.84 - 7.10	440-0690		T5	T15	
	7.05 - 7.25	440-0720	x 6	T5	T15	
	7.40 - 7.65	440-0745	T5	T15		
8	8.63	440-0863	x 6	T5	T15	120 172
	8.98 - 9.30	440-0905		T5	T15	
	9.27 - 9.50	440-0940	x 8	T5	T15	
	9.83 -10.25	440-1000	T5	T15		
10	10.64 - 10.86	440-1075	x 8 x 10	T5	T15	179 267
	11.03 - 11.40	440-1110		T5	T15	
	11.36 - 11.80	440-1140		T5	T15	
	11.85 - 12.15	440-1200		T5	T15	
12	12.62 - 12.85	440-1275	x 8 x 12	T5	T15	194 324
	13.12 - 13.50	440-1320		T5	T15	
	13.70 - 14.09	440-1392		T5	T15	
	14.10 - 14.35	440-1420		T5	T15	
14	14.59 - 15.08	440-1475	x 12	T5	T15	328
	15.23 - 15.80	440-1530		T5	T15	
	15.73 - 16.22	440-1600		T5	T15	
	16.30 - 16.73	440-1650		T5	T15	
16	16.74 - 17.26	440-1684	x 12	T5	T15	338
	17.33 - 17.87	440-1740		T5	T15	
	17.88 - 18.43	440-1800		T5	T15	
	18.62 - 19.19	440-1875		T5	T15	
18	18.87 - 19.45	440-1920	x 12	T5	T15	353
	19.41 - 20.01	440-1950		T5	T15	
	20.00 - 20.60	440-2000		T5	T15	
	20.29 - 20.94	440-2050		T5	T15	
	20.93 - 21.57	440-2130		T5	T15	
20	21.51 - 22.15	440-2160	x 12	T5	T15	363
	22.16 - 22.81	440-2254		T5	T15	
	22.78 - 23.45	440-2294		T5	T15	
	23.46 - 24.16	440-2400		T5	T15	
	24.15 - 24.85	440-2450		T5	T15	
	24.82 - 25.52	440-2502		T5	T15	

Other sleeve ranges and outlet sizes available upon request.
 U.S. Patent No. 8176929

JCM Fabricated Weld On Line Stop Outlets

Carbon Steel and All Stainless Steel (304 & 316) Construction Available

Outlets, partial sleeves and full sleeves readily available for steel pipe 4" and larger. Size on size and reducing outlets to accommodate folding head or bag stop machinery available. Outlets and partial sleeves available for tank and bulkhead use.

- JCM 440 Type 6 - Full Body- Threaded Plug
- JCM 440 Type 16 - Full Body - Push Plug/Pin
- JCM 440 Type 7 - Outlet Only - Threaded Plug
- JCM 440 Type 17 - Outlet Only - Push Plug/Pin



Nominal Pipe Size (IN.)	Catalog Number	Outlet Sizes	SLEEVE STYLE THREADED PLUG TYPE CODE	SLEEVE STYLE PUSH PLUG/PIN TYPE CODE	SLEEVE STYLE THREADED PLUG TYPE CODE	SLEEVE STYLE PUSH PLUG/PIN TYPE CODE
4	440-0450	x 4	T6	T16	T7	T17
6	440-0663	x 4 x 6	T6 T6	T16 T16	T7 T7	T17 T17
8	440-0863	x 6 x 8	T6 T6	T16 T16	T7 T7	T17 T17
10	440-1075	x 8 x 10	T6 T6	T16 T16	T7 T7	T17 T17
12	440-1275	x 8 x 12	T6 T6	T16 T16	T7 T7	T17 T17
14	440-1400	x 12	T6	T16	T7	T17
16	440-1600	x 12	T6	T16	T7	T17
18	440-1800	x 12	T6	T16	T7	T17
20	440-2000	x 12	T6	T16	T7	T17

How To Order:

1. Determine O.D. of pipe
2. Select proper catalog number
3. Select proper outlet size
4. Select proper sleeve style and outlet plug type code (threaded or push/pin)
5. Add Outlet Type Code (T6 or T16)

Example: For Steel Pipe with 6.63 O.D., full sleeve style, with threaded plug, order: 440-0663 T6

JCM 440 Weld On Line Stop Fittings are standard no test plugs. For optional test plug, contact JCM. Fittings are fabricated to exact O.D. of pipe.

Larger sizes available.

Other designs offered; contact JCM Industries. U.S. Patent No. 8176929

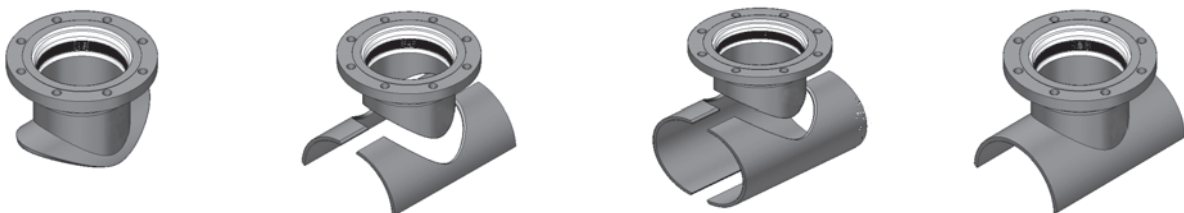

JCM Fittings and Fabrications for High Density Polyethylene Pipe

JCM Products for tapping PE pipe have been tested and evaluated for their suitability and design capability. In each case JCM products have performed satisfactorily in respect to their design application.

High Density Polyethylene Pipe (HDPE) has several unique characteristics which must be taken into consideration. HDPE has a high coefficient of thermal expansion and a low modulus of elasticity. This sensitivity to pressure and temperature causes HDPE to expand and contract more than traditional water and sewer piping materials. HDPE will also relax ("creep") at lower stress levels than other piping materials.

In consideration of the unique characteristics, JCM provides fabricated tapping fittings that are sized specifically with applicable ranges for HDPE. These sleeves are featured on the following pages.

JCM Outlet Seal Threaded Outlet Tapping Sleeves for HDPE Pipe Model Numbers 418, 438

Ranges and Part Numbers provided specifically for High Density Polyethylene Pipe.

NOM. PIPE SIZE (IN.)	SLEEVE O.D. RANGE (IN.)	SLEEVE NUMBER X ANY OUTLET	OUTLET SIZE	ORDER CODE IP		
14	13.60 - 14.09	1392				
	14.99 - 15.49	1520				
16	15.68 - 16.18	1590				
	17.05 - 17.55	1730				
18	17.64 - 18.14	1790				
	19.11 - 19.61	1940				
20	19.60 - 20.10	1990			3/4"	06
	21.17 - 21.67	2150				
21	20.60 - 21.10	2090			1"	08
	21.60 - 22.10	2190				
24	23.46 - 24.16	2400			1-1/4"	10
	25.30 - 25.80	2570				
27	26.50 - 27.00	2690			1-1/2"	12
	27.50 - 28.00	2790				
30	29.50 - 30.00	2990			2"	14
	31.50 - 32.00	3190				
36	35.50 - 36.00	3590			2-1/2"	16
	37.80 - 38.30	3820				
42	41.50 - 42.00	4190	3	17		
	44.00 - 44.50	4440				
48	47.50 - 48.00	4790	4	18		
	50.30 - 50.80	5070				
54	53.50 - 54.00	5390				
	57.06 - 57.56	5746				
60	59.50 - 60.00	5990				
	61.11 - 61.61	6151				

How to Order:

1. Determine outside diameter of HDPE Pipe (IPS, DI), provide SDR#.
2. Select sleeve material (carbon, stainless) and proper size outlet.
3. Select model number (418, 438). For full product description see JCM Catalog.
4. Select proper sleeve O.D. Range and sleeve number.
5. Specify Model Number-Sleeve Number x Outlet Size

Example: For 24" HDPE SDR 17 IPS O.D. pipe, with 2" threaded outlet, carbon steel, order: 418-2400 x 14IP

Example: For 24" HDPE SDR 17 IPS O.D. Pipe, with 2" threaded outlet, All Stainless Steel, order: 438-2400 x 14IP

For sizes not listed, contact JCM Inside Sales Team at 800-527-8482 or 903-832-2581.

JCM Outlet Seal Tapping Sleeves for HDPE Pipe Model Numbers 412, 419, 452, 464, 459, 465

Ranges and Part Numbers provided specifically for High Density Polyethylene Pipe

For sizes not listed, contact JCM Inside Sales Team at 800-527-8482 or 903-832-2581.

NOM. PIPE SIZE (IN.)	SLEEVE O.D. RANGE (IN.)	SLEEVE NUMBER X ANY OUTLET	OUTLET SIZES AVAILABLE
14	13.60 - 14.09 14.99 - 15.49	1392 1520	X 2 X 3 X 4 X 6 X 8 X 10 X 12
16	15.68 - 16.18 17.05 - 17.55	1590 1730	X 2 X 3 X 4 X 6 X 8 X 10 X 12
18	17.64 - 18.14 19.11 - 19.61	1790 1940	X 2 X 3 X 4 X 6 X 8 X 10 X 12
20	19.60 - 20.10 21.17 - 21.67	1990 2150	X 2 X 3 X 4 X 6 X 8 X 10 X 12
21 22	20.60 - 21.10 21.60 - 22.10	2090 2190	X 2 X 3 X 4 X 6 X 8 X 10 X 12
24	23.46 - 24.16 25.30 - 25.80	2400 2570	X 2 X 3 X 4 X 6 X 8 X 10 X 12
27 28	26.50 - 27.00 27.50 - 28.00	2690 2790	X 2 X 3 X 4 X 6 X 8 X 10 X 12
30	29.50 - 30.00 31.50 - 32.00	2990 3190	X 2 X 3 X 4 X 6 X 8 X 10 X 12

JCM Outlet Seal Tapping Sleeves for HDPE Pipe Model Numbers 412, 419, 452, 454, 459, 465

Ranges and Part Numbers provided specifically for High Density Polyethylene Pipe.

For other types of pipe see JCM General Products Directory

NOM. PIPE SIZE (IN.)	SLEEVE O.D. RANGE (IN.)	SLEEVE NUMBER X ANY OUTLET	OUTLET SIZES AVAILABLE
36	35.50 - 36.00 37.80 - 38.30	3590 3820	X 2 X 3 X 4 X 6 X 8 X 10 X 12
42	41.50 - 42.00 44.00 - 44.50	4190 4440	X 2 X 3 X 4 X 6 X 8 X 10 X 12
48	47.50 - 48.00 50.30 - 50.80	4790 5070	X 2 X 3 X 4 X 6 X 8 X 10 X 12
54	53.50 - 54.00 57.06 - 57.56	5390 5746	X 2 X 3 X 4 X 6 X 8 X 10 X 12
60	59.50 - 60.00 61.11 - 61.61	5990 6151	X 2 X 3 X 4 X 6 X 8 X 10 X 12

2" Mechanical Joint Outlets Not Available

14" and Larger Flanged Outlets Available. Tapping valve information must be specified to assure proper alignment recess dimension.

14" & 16" Mechanical Joint Outlets Available. Stainless Steel Only (Model 459)

For size on size outlets a 1/2" undersize shell cutter is required.

JCM Flanged and Mechanical Joint Outlet Tapping Sleeves furnished with test plugs unless otherwise specified.

How to Order:

1. **Determine outside diameter of HDPE Pipe (IPS, DI), provide SDR#.**
2. **Select sleeve material (carbon, stainless) and proper outlet material & type (flange, mechanical joint).**
3. **Select model number. For full product description, see JCM Catalog.**
4. **Select proper sleeve O.D. Range and sleeve number.**
5. **Specify Model Number-Sleeve Number x Outlet Size.**

Example: For 24" HDPE SDR 17 IPS O.D. pipe, with 8" flanged outlet, carbon steel, order: 412-2400 x 8

Example: For 24" HDPE SDR 17 IPS O.D. Pipe, with 8" mechanical joint outlet, All Stainless Steel, order: 459-2400 x 8

For sizes not listed, contact JCM Inside Sales Team at 800-527-8482 or 903-832-2581.

JCM 610 Sur-Grip Fitting Restrainer

4" - 12" for use with C-900 PVC, Ductile Iron Pipe, DIP HDPE

4" - 8" for use on IPS PVC, IPS HDPE

Anchors IPS PVC, C-900 PVC Pipe and Ductile Iron Pipe to mechanical joint and other type fittings provided with anchor lugs.



PIPE SIZE		CATALOG NUMBER	SERRATED COMPRESSION RING BODY	T-HEAD BOLTS		APPR. WT.EA. (LBS.)
NOM.	O. D.		WIDTH	SIZE	QTY	
4	4.50	610-0450	2-1/2"	3/4 X 9-1/2	2	12
4	4.80	610-0480	2-1/2"	3/4 X 9-1/2	2	12
6	6.63	610-0663	2-1/2"	3/4 X 9-1/2	2	15
6	6.90	610-0690	2-1/2"	3/4 X 9-1/2	2	15
8	8.63	610-0863	2-3/4"	3/4 X 9-1/2	2	22
8	9.05	610-0905	2-3/4"	3/4 X 9-1/2	2	22
10	11.10	610-1110	2-3/4"	3/4 X 9-1/2	4	31
12	13.20	610-1320	2-3/4"	3/4 X 9-1/2	4	41



JCM 620 Sur-Grip Bell Joint/Fuse Joint Restrainer

4" - 12" for use with C-900 PVC, Ductile Iron Pipe, DIP HDPE

4" - 8" for use on IPS PVC, IPS HDPE

Anchors IPS PVC, C-900 PVC Pipe and Ductile Iron Pipe over the bell, flexible couplings and other low profile joints.

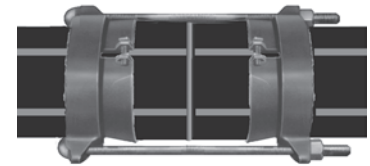

PIPE SIZE		CATALOG NUMBER	SERRATED COMPRESSION RING BODY	COMPRESSION FOLLOWER RING		BOLTS		APPR. WT. EA. (LBS.)
NOM.	O. D.		WIDTH	WIDTH	QTY.	SIZE	QTY	
4	4.50	620-0450	2-1/2"	1-3/8"	2	3/4 X 12	2	16
4	4.80	620-0480	2-1/2"	1-3/8"	2	3/4 X 12	2	16
6	6.63	620-0663	2-1/2"	1-1/2"	2	3/4 X 12	2	21
6	6.90	620-0690	2-1/2"	1-1/2"	2	3/4 X 12	2	21
8	8.63	620-0863	2-3/4"	1-3/4"	2	3/4 X 14	2	32
8	9.05	620-0905	2-3/4"	1-3/4"	2	3/4 X 14	2	32
10	11.10	620-1110	2-3/4"	1-3/4"	2	3/4 X 18-1/2	4	49
12	13.20	620-1320	2-3/4"	1-3/4"	2	3/4 X 18-1/2	4	63

JCM 610 and 620 Sur-Grip Restrainers are rated for 235 PSI on DR-18 PVC Pipe, and are equal to the pipe rating on other classes. JCM 610 and 620 Sur-Grip Restrainers are rated for 350 PSI on Ductile Iron Pipe offering a 2:1 safety factor.

JCM 610 Sur-Grip Restrainer

14" - 30" for use with C-905 PVC Pipe, DIP HDPE

Anchors PVC Pipe to Mechanical Joint and other types of fittings provided with anchor lugs.

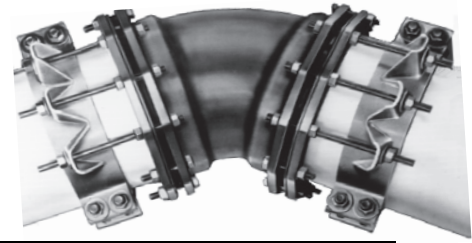

PIPE SIZE		CATALOG NUMBER	BODY WIDTH	RESTRAINING RODS		BOLTS		APPR. WT. EA. (LBS.)
NOM.	O. D.			SIZE	QTY.	SIZE	QTY.	
14	15.30	610-1530	5"	3/4 X 14	6	1 X 9	4	60
16	17.40	610-1740	5"	3/4 X 14	6	1 X 9	4	63
18	19.50	610-1950	5"	3/4 X 14	8	1 X 9	4	73
20	21.60	610-2160	7"	3/4 X 16	8	1 X 9	6	120
24	25.80	610-2580	7"	3/4 X 16	12	1 X 9	6	150
30	32.00	610-3200	10"	1 X 18	14	1 X 9	8	330

JCM 611 Sur-Grip PVC Fitting Restrainer

14" - 30" for use with C-905 PVC Fittings and Pipe

Anchors Long Bell PVC Gasketed Fittings to C-905 PVC Pipe. JCM 611 PVC Fitting Restrainers are Priced on Application. For price and availability, provide the O.D., manufacturer and SDR of the PVC fitting.

PIPE SIZE	BASE CATALOG NUMBER	-	PROVIDE O.D. OF PVC FITTING
14	611-1530	-	x x x x
16	611-1740	-	x x x x
18	611-1950	-	x x x x
20	611-2160	-	x x x x
24	611-2580	-	x x x x
30	611-3200	-	x x x x

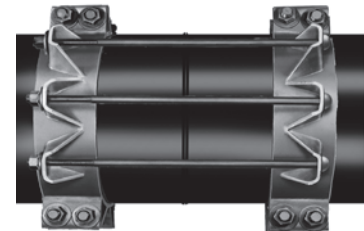
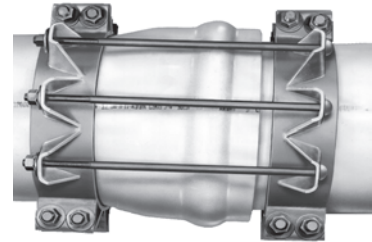

JCM 621 Sur-Grip Bell Joint Restrainer

14" - 30" for use with C-905 PVC Pipe, DIP HDPE

Anchors over the bell-spigot connection or suspect fused joints, the JCM 621 prevents joint separation on pressure pipe.

PIPE SIZE		CATALOG NUMBER	BODY WIDTH	RESTRAINING RODS		BOLTS.		APPR. WT. EA. (LBS.)
NOM.	O. D.			SIZE	QTY.	SIZE	QTY.	
14	15.30	621-1530	5"	3/4 X 26	6	1 X 9	8	113
16	17.40	621-1740	5"	3/4 X 26	6	1 X 9	8	120
18	19.50	621-1950	5"	3/4 X 26	8	1 X 9	8	137
20	21.60	621-2160	7"	3/4 X 32	8	1 X 9	12	230
24	25.80	621-2580	7"	3/4 X 32	12	1 X 9	12	280
30	32.00	621-3200	10"	1 X 36	14	1 X 9	16	660

JCM 610, 611 and 621 Sur-Grip Restrainers sizes 14" - 30" are not for use on ductile iron, cast iron, asbestos cement, steel or any other rigid types of pipe. For application recommendations, contact JCM Inside Sales Team at 1-800-527-8482 or 903-832-2581.

JCM 630 Restrainer for Asbestos Cement Pipe

JCM 630 Restrainers have been developed to fill the need to anchor 4 - 16 inch Asbestos Cement pipe. The wide supportive stance around the pipe combined with the split design make these restrainers ideal for retrofitting installations. Necessary excavation of Asbestos Cement Pipe will release the compacted backfill around joint areas exposing the joints to shifting or movement. This disturbance can lead to displaced and leaking gaskets. Hydrants, dead ends, ground subsidence and unstable soils often require restraint other than concrete thrust blocking.

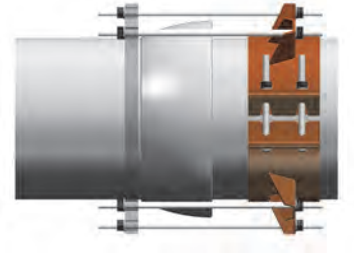

JCM 630 Fitting Restrainer for Asbestos Cement Pipe

Restrainer for use with fittings, hydrants, flanged coupling adapters, meter and mechanical joints. All thread rods (16" long) nuts and washers are included.

Nominal Pipe Size	Pipe Range O.D.	Fitting Width (IN)	No. Tie Rod	Size Tie Rod	Catalog Number	Options	
						Epoxy Coat Alloy Bolts (E)	Epoxy Coat Stainless Steel Bolts (ESS)
4	4.80 - 5.10	9	2	3/4 x 16	630-0500	(E)	(ESS)
6	7.05 - 7.40	8	2	3/4 x 16	630-0720	(E)	(ESS)
8	9.27 - 9.60	8	2	3/4 x 16	630-0940	(E)	(ESS)
10	11.76 - 12.24	8	4	3/4 x 16	630-1200	(E)	(ESS)
12	14.08 - 14.56	8	4	3/4 x 16	630-1420	(E)	(ESS)
14	16.30 - 16.73	12	6	3/4 x 16	630-1650	(E)	(ESS)
16	18.62 - 19.19	12	6	3/4 x 16	630-1875	(E)	(ESS)

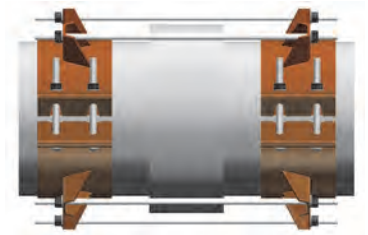

JCM 631 Coupling Restrainer for Asbestos Cement Pipe

Restrainer for use over A/C coupling, MJ couplings and mechanical couplings. Tie rods (36" long), nuts and washers are included with restrainer

Nominal Pipe Size	Pipe Range O.D.	Fitting Width (IN)	No. Tie Rod	Size Tie Rod	Catalog Number	Options	
						Epoxy Coat Alloy Bolts (E)	Epoxy Coat Stainless Steel Bolts (ESS)
4	4.80 - 5.10	9	2	3/4 x 36	631-0500	(E)	(ESS)
6	7.05 - 7.40	8	2	3/4 x 36	631-0720	(E)	(ESS)
8	9.27 - 9.60	8	2	3/4 x 36	631-0940	(E)	(ESS)
10	11.76 - 12.24	8	4	3/4 x 36	631-1200	(E)	(ESS)
12	14.08 - 14.56	8	4	3/4 x 36	631-1420	(E)	(ESS)
14	16.30 - 16.73	12	6	3/4 x 36	631-1650	(E)	(ESS)
16	18.62 - 19.19	12	6	3/4 x 36	631-1875	(E)	(ESS)

For optional Epoxy Coating add (E) to end of Catalog Number.

For optional Epoxy Coating and stainless steel bolts add (ESS) to end of Catalog Number.

Material Specifications

- Restrainer Body: Pressure Vessel Quality Steel ASTM A285 Grade C or equal.
- Bolts and Nuts: Corrosion resistant high strength, low alloy AWWA C-111, ANSI 21.11. Optional stainless steel, 18-8 Type 304.
- Finish: Standard Shop Coat - heavy coating of corrosion inhibiting metal primer. Optional Fusion applied Epoxy Coating ANSI/AWWA C-213.

JCM Fabricated Expansion Joints

JCM Expansion Joints permit up to 10" of concentrated pipe movement that provides for normal expansion/contraction of pipelines subject to variations of both environmental and line content temperatures. JCM Expansion Joints are manufactured using a telescoping design that consists of a fabricated steel body, or housing, that accommodates an inserted internal "slip pipe" that moves in and out of the body. This free movement absorbs the linear, or axial, movement of the section of pipe. The fabricated steel body houses a "packing" area of alternating rings of lubricated flax and rubber that provides the water tight seal during the cycling of the joint. JCM Expansion Joints offer several design options including end connections, coatings, limit rods, stainless steel fabrication and others. JCM Expansion Joints are manufactured for each specific application allowing for the incorporation of special options or engineered features required for the installation.

Heavy Duty Construction - The heavy duty, durable exterior body provides the protective shell for the slip pipe and packing system. For corrosive or acidic environments, the expansion joint may be epoxy coated or fabricated of stainless steel.

Externally Guided Slip Pipe - The corrosion resistant slip pipe furnishes a hard, surface that reduces friction between the slip pipe and packing material. For corrosive environments or line contents, slip pipe is available fabricated of stainless steel.

Adjustable Packing Gland - Alternating rings of lubricated flax and rubber are packed tightly into the packing area of the body by the adjustable packing gland. This packing gland maintains a consistent compression of the flax/rubber rings to ensure a tight, leak proof seal between the slip pipe and body.

Lubricated Packing - The rings of lubricated flax provide the "lubrication" to the slip pipe ensuring a smooth expanding/contracting movement while the square rubber rings secure the water tight seal. This packing area is easily accessible, without disruption of service, should repacking be required.







HOW TO ORDER

For pricing and engineering, the following information must be furnished:

- Type of pipe
- Outside diameter of pipe
- Type of End Connections
- Line Contents
- Minimum and maximum temperatures
- Maximum working pressure
- Material and Coating specifications

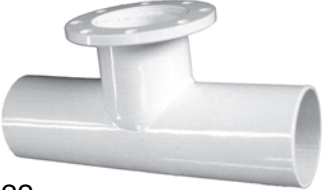
JCM 802 Double End Expansion Joints are designed for special applications such as middle of line use where expansion joint body can be anchored. This fitting permits up to 10" total pipe movement, 5" on each end, with properly anchored body.

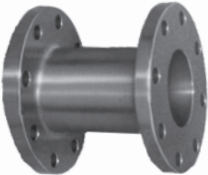
JCM Fabricated Spools and Bypass Tees

 <p>820</p>  <p>822</p>  <p>823</p>	<p>820 Fabricated Plain End Tee 822 Fabricated Flanged x Plain End Tee 823 Bypass Tee (Flg x Flg x Flg) Sizes 3" and Larger, Available size on size and reducing</p> <p>Custom fabricated tees for cutting in services, replacing existing piping and for installing bypasses. The ability to meet exact length requirements, epoxy coated for extra corrosion resistance and quick shipment make these tee's real problem solvers.</p> <p>How To Order</p> <ol style="list-style-type: none"> 1. Determine Nominal Pipe and Flange Size 2. Determine Outlet Tee/ Flange Size 3. Determine Exact Laying Length Requirements <p>Example: Flange x Flange Bypass Tee 6" Nominal Run with 4" Flanged Outlet, 10" in Length Part Number: 823-6 x 6 x 4 x 10</p>
 <p>831</p>  <p>832</p>	<p>831 Flange x Flange Spool with Test Outlets 832 Flange x Flange Spool without Test Outlets Sizes 3" and Larger, Available size on size and reducing</p> <p>Ideal for installing new meters and equipment where the laying length of the new equipment is shorter than the equipment being replaced. These flanged spools can make up the difference and add test outlets if necessary. Custom fabrication allows exact length requirements to be met.</p> <p>How To Order</p> <ol style="list-style-type: none"> 1. Determine Nominal Pipe and Flange Size 2. Determine Size and Quantity of Test Outlets (for 831) 3. Determine Exact Laying Length Requirements - minimum length available: Size on Size: 3" nominal size - 5-3/4", 4" - 12" nominal size - 6-3/4" <p>Example: 6" Nominal run with two (2) 1-3/4" Test Outlets, 10" in Length 831 Part Number: 831-6 x 6 x 1-3/4 x 10 with two (2) Test Outlets 832 Part Number: 832-6 x 6 x 10</p>
 <p>833</p>  <p>834</p>	<p>833 Flange x Plain End Spool with Test Outlets 834 Flange x Plain End Spool without Test Outlets Sizes 3" and Larger, Available size on size and reducing</p> <p>Ideal for use on installations requiring field fit up. Plain end accommodates a flexible coupling for easy adjustment.</p> <p>How To Order</p> <ol style="list-style-type: none"> 1. Determine Nominal Pipe and Flange Size 2. Determine Size and Quantity of Test Outlets (for 833) 3. Determine Exact Laying Length Requirements -minimum length available: Size on Size: 3" nominal size - 8-3/4", 4" - 12" nominal size - 9-3/4" <p>Example: 6" Nominal run with two (2) 1-3/4" Test Outlets, 10" in Length 833 Part Number: 833-6 x 6 x 1-3/4 x 10 with two (2) Test Outlets 834 Part Number: 834-6 x 6 x 10</p>



JCM 800 Series Surge Suppressors

JCM Surge Suppressors provide a simple and economical solution to reducing the number and costs of repairs, protection of valuable system assets and eliminates loss of expensive treated water from damage associated with water hammer. The JCM Surge Suppressor performs as a “shock absorber” for the system and minimizes the damaging effects of pressure spikes or velocity changes.

Overall benefits of these devices far exceed their costs:

- Reduction in main breaks
- Reduce and eliminate water quality/supply complaints
- Extend the life expectancy of streets, pavement and overlays
- Minimize system pump damage
- Prevent water treatment discharge line main breaks
- Prevent fatal pressure stresses on pipe system joints and components
- Reduce exposure of the potable system to contaminants, liability and service loss.



Patent No. 5218987

The JCM 800 Series Surge Suppressor body is constructed of certifiable 18-8 Type 304 Stainless Steel and is available with two types of connections - flange and mechanical joint. The connections are available in stainless steel or carbon steel.

JCM 800 Series Surge Suppressor

Model Number Type of Connection	841 Stainless Steel Flange	842 Carbon Steel Flange	843 Stainless Steel Mechanical Joint	844 Carbon Steel Mechanical Joint
Body Material	Stainless Steel	Stainless Steel	Stainless Steel	Stainless Steel
Connection Material	Stainless Steel	Carbon Steel	Stainless Steel	Carbon Steel
Connection Type	Flange	Flange	Mechanical Joint	Mechanical Joint
Fitting Height	18" (457.2mm)	18" (457.2mm)	22" (558.8mm)	22" (558.8mm)
Fitting Length	24" (609.6mm)	24" (609.6mm)	24" (609.6mm)	24" (609.6mm)
Outside Diameter	12.75 (323.85mm)	12.75 (323.85mm)	12.75 (323.85mm)	12.75 (323.85mm)
Approximate Weight	85 lbs. (38.55kg)	85 lbs. (38.55kg)	85 lbs. (38.55kg)	85 lbs. (38.55kg)

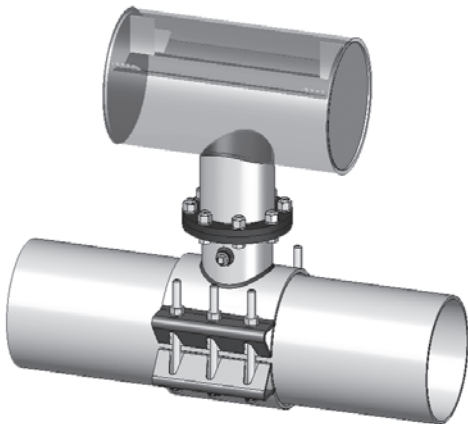

JCM Tools And Accessories

JCM MASTER WRENCHES

JCM Master Wrenches are designed for simple, quick use for installing all types of pipe fittings and fabrications. By incorporating specific design points, JCM Wrenches eliminate problems such as missing sockets, bottoming out on long bolts and not having the right size socket.

All JCM Master Wrenches offer these important field advantages.

- Two common sizes on each wrench.
- Works on long bolts without bottoming out.
- Nuts can be spun tight with knurled socket.
- No complex reverse mechanism - just flip over.
- Easily cleaned without disassembly.
- No loose parts.

CATALOG NUMBER	SOCKET SIZE	NOMINAL NUT SIZE	FITS PRODUCTS	LENGTH	CARTON QTY.	WT. PER CARTON (LBS.)
901	1-1/4" X 1-1/16"	3/4" & 5/8" HH	M.J. BOLTS, CLAMPS, TAPPING SLEEVES	17"	10	20
902	7/8" X 3/4"	1/2" & 7/16" HH	SMALL BOLTED COUPLINGS, CLAMPS	9-1/4"	10	5-1/2
903	3/4" X 11/16"	7/16" & 3/8" HH	PATCH CLAMPS	9-1/4"	10	5-1/2
904	1-1/8" X 15/16"	3/4" & 5/8" STD. HEX	FLANGE BOLTS, EQUIPMENT	17"	10	20



JCM 900 Master Wrench Set

The JCM 900 Master Wrench Set includes all four JCM wrenches 901, 902, 903, 904 packed in a heavy duty fabric rolled case for easy storage. The **900 Master Wrench Set Lists 10% LESS** than if all four wrenches were purchased separately. A real savings!



CATALOG NUMBER	INCLUDES WRENCH MODELS	CARTON QTY.	WT. PER CARTON (LBS.)
900	901, 902, 903, 904	1	20

JCM 905 Torque Wrench - Designed for Rugged Field Use

Knurled Grip provides a rugged No-Slip Grip that allows continual pull on the wrench during tighten process. Manual wrench allows for accurate levels of torque to be achieved. One strong handle eases use, especially in harsh environments and inclement weather.

1/2" Standard Drive* accepts any 1/2" standard square socket.

Audible Torque Indicator provides "click" sound that provides immediate confirmation the proper torque level has been met. Audible click eliminates the necessity of watching or protecting fragile dials and pointers. Meets the Federal Specification GGG-W-00686C and is delivered calibrated with an accuracy of ±4%. Adjusts from 10 - 150 Ft. Lbs.

Reverse Action Lever make use simple, the same motion both tightens and loosens with just a flip of the lever.

Includes storage case. *Sockets not included.



JCM 906 Universal Hydrant Wrench

Adjustable hydrant wrench accommodates pentagon nuts up to 1-3/4" and square nuts through 1-1/4". Complete with 3/4" through hole and lug style spanners, the JCM 906 fits both pin and lug style couplings. JCM 906 handle is 7/8" in diameter and has a knurled grip making it easy to use when wearing gloves and resistant to slippage. The 15" long steel handle provides for maximum leverage. Zinc chromate plated.



JCM 910 Extra Deep Socket Set

Four piece deep socket set includes the popular 1/2" drive sockets sizes 15/16", 1-1/16", 1-1/8", 1-1/4" with a plastic storage case to protect and store sockets when not in use



JCM 920 Pipe O.D. Tape - 8' Length

This popular tape has a 8' blade which has standard inches on the reverse from the diameter in 100ths. This reversed blade allows a quick and accurate measurement of the diameter or circumference of the pipe.



Catalog Number	Description
905	JCM Torque Wrench
906	Universal Hydrant Wrench
910	Extra Deep Socket Set
920	8' Pipe Diameter Tape

JCM INDUSTRIES, INC,
General Application Information
Fittings and Fabrications for High Density Polyethylene Pipe

JCM Products for repairing, connecting and tapping Polyethylene pipe have been tested and evaluated for their suitability and design capability. In each case JCM products have performed satisfactorily in respect to their design application. Test criteria range from short-term for special applications to long-term 1000 hour evaluations with the most common applications. Temperature and pressure cycles are also incorporated to fully address the pipe characteristics and full range of occurrences. Special monitoring equipment is utilized to produce accurate test data and for historical reference.

High Density Polyethylene Pipe (HDPE) has several unique characteristics which are taken into consideration in the following guidelines. The disregard of these guidelines and/or the installation instructions supplied with each fitting may cause unsatisfactory results and void the expressed product warranty.

HDPE Pipe considered for use must be manufactured to the recommendations set forth in the ANSI/AWWA Standard C906 and complies with criteria in reference to size.

HDPE has a high coefficient of thermal expansion and contraction along with a low modulus of elasticity. This sensitivity to pressure and temperature causes HDPE to expand and contract more than traditional water and sewer piping materials. The potential pipe expansion or contraction must be considered when assembling bolt on fittings.

HDPE will relax ("creep") at lower stress levels than other piping materials. Due to these special characteristics, the following parameters should be adhered to when utilizing JCM products for HDPE (ANSI/AWWA C901, C906).

- HDPE and bolt-on fitting connections are vulnerable to forces experienced with expansion/contraction of the pipe and require special consideration. Restraint must be considered when joining plain end pipe to ensure against pipe pull out. HDPE is manufactured with a smooth pipe wall surface resulting in a low coefficient of friction that can enable fittings to slide, shift, move, rotate and/or travel on the pipe after installation. JCM products are limited in the tolerance of axial movement of the pipe.
- JCM products for HDPE are designed for underground pressurized fluid service and are pressure rated to match the pipe SDR pressure rating or with a maximum service rating of 150 PSI (Temperature 35° - 75° F/Maximum test pressure limited to rated pipe pressure or fitting, whichever is lower). For above ground applications, contact JCM Industries Technical Services.
- Pipe stiffeners must be used when joining, or connecting to, HDPE. Pipe systems must be engineered to prevent movement causing fittings to slide or rotate on the pipe. Cutting HDPE can cause the pipe to ovate or "neck" down and become egg shaped. This pipe movement can interfere with the assembly of bolt on fittings.

Thirty years of successful performance has been one of the most stringent proving grounds for JCM products and their application with Polyethylene Pipe. Generally speaking, most common potable water pressure applications utilize HDPE SDR 17 through 11. For applications on thinner wall pipe, special applications, higher pressure ratings and product usage recommendations, please contact JCM.

Note: JCM recommends fusion joints as a primary method of connection. When correctly implemented, fused joints are self-restraining and leak proof. In some instances conditions are not conducive to properly fuse the joint per manufacturers' recommendations. Mechanical fittings to join or repair HDPE are a secondary and limiting choice. The information included on this page is provided to address the known factors when repairing, joining or tapping HDPE with mechanical fittings.

Effective 07/30/08



Pipe Outside Diameter Guide

SMALL DIAMETER PIPE SIZES

NOMINAL PIPE SIZE (INCHES)	1/2	3/4	1	1-1/4	1-1/2	2	2-1/2
COPPER TUBING	.63	.88	1.13	1.38	1.63	2.13	2.63
STEEL & PLASTIC PIPE	.84	1.05	1.32	1.66	1.90	2.38	2.88

IMPORTANT: This Pipe O.D. Guide is furnished for your convenience and is based on the latest pipe standards and information supplied by pipe manufacturers. Due to occasional changes and variances in outside diameters, the pipe O.D. should always be verified before ordering fittings.

STANDARD PRESSURE PIPE SIZES

NOMINAL PIPE SIZE (INCHES)	3	4	5	6	8	10	12	14	15	16	18	20	24	30
COPPER TUBING	3.13	4.13	5.13	6.13										
STEEL & PLASTIC PIPE (SDR 26,21 & SCHEDULE)	3.50	4.50	5.56	6.63	8.63	10.75	12.75	14.00		16.00	18.00	20.00	24.00	30.00
PLASTIC IRRIGATION PIPE (PIP)		4.13		6.14	8.16	10.20	12.24		15.30		18.70	22.05	24.80	
PLASTIC SEWER PIPE (SDR 35)		4.22		6.28	8.40	10.50	12.50		15.30		18.70		24.80	
PLASTIC (PVC) AWWA C-900/C-905/C-909		4.80		6.90	9.05	11.10	13.20	15.30		17.40	19.50	21.60	25.80	
POLYETHYLENE PIPE (IPS SIZE)	3.50	4.50		6.63	8.63	10.75	12.75	14.00		16.00	18.00	20.00	24.00	30.00
POLYETHYLENE PIPE (DIP SIZE)		4.80		6.90	9.05	11.10	13.20	15.30		17.40	19.50	21.60	25.80	32.00

CAST IRON	DUCTILE IRON PIPE	3.96	4.80		6.90	9.05	11.10	13.20	15.30		17.40	19.50	21.60	25.80	32.00
	CLASS 100 - 250 AWWA	3.96	4.80		6.90	9.05	11.10	13.20	15.30		17.40	19.50	21.60	25.80	32.00
	CLASS A AWWA PIT CAST	3.80	4.80		6.90	9.05	11.10	13.20	15.30		17.40	19.50	21.60	25.80	31.74
	CLASS B AWWA PIT CAST	3.96	5.00		7.10	9.05	11.10	13.20	15.30		17.40	19.50	21.60	25.80	32.00
	CLASS C - D AWWA PIT CAST	3.96	5.00		7.10	9.30	11.40	13.50	15.65		17.80	19.92	22.06	26.32	

ABESTOS CEMENT PIPE	Class 100	MACHINED END	3.74	4.64		6.91	9.11	11.24*	13.44*	15.07		17.15	19.90	22.12	26.48	33.12	
		FLINTITE ROUGH BARREL	3.94	4.90		7.13	9.33	11.30	13.42	15.45		17.60					
		FLUID-TITE ROUGH BARREL	3.93	5.05		7.16	9.32	11.46	13.70	15.36		17.50	20.44	22.50	27.17		
		PERMAFLEX ROUGH BARREL		4.84		7.15	9.35	11.47	13.74	15.55		17.55	20.50	22.70	27.15		
		RING-TITE ROUGH BARREL	3.95	4.92		7.19	9.39	11.47	13.74	15.51		17.65	20.44	22.68	27.12	33.80	
		MIN. STD. ROUGH BARREL		4.79		7.05	9.22	11.25	13.37	15.36		17.50					
		MAX. STD. ROUGH BARREL		5.26		7.40	9.57	11.77	14.04	15.80		17.94					
	Class 150	MACHINED END	3.84	4.81		6.91	9.11	11.66	13.92	16.22		18.46	20.94	23.28	27.96	35.00	
		FLINTITE ROUGH BARREL	4.40	5.06		7.13	9.33	11.88	14.14	16.48		18.72					
		FLUID-TITE ROUGH BARREL	4.03	5.14		7.12	9.32	11.85	14.11	16.41		18.65	21.20	23.54	28.22		
		PERMAFLEX ROUGH BARREL		5.00		7.20	9.40	11.92	14.20	16.50		18.75	21.30	23.64	28.32		
		RING-TITE ROUGH BARREL	4.13	5.07		7.17	9.37	11.92	14.18	16.48		18.72	21.30	23.64	28.32	35.42	
		MIN. STD. ROUGH BARREL		4.97		7.07	9.27	11.82	14.08	16.38		18.62					
		MAX. STD. ROUGH BARREL		5.32		7.37	9.62	12.12	14.38	16.73		18.97					
	Class 200	MACHINED END	3.84	4.81		6.91	9.11	11.66	13.92	16.22		18.46	22.18	24.66	29.62	37.06	
		FLINTITE ROUGH BARREL	4.17	5.32		7.26	9.44	11.88	14.14	16.53		18.84					
		FLUID-TITE ROUGH BARREL	4.18	5.32		7.36	9.46	11.88	14.11	16.44		18.74					
		PERMAFLEX ROUGH BARREL		5.32		7.25	9.50	11.95	14.20	16.55		18.90	22.54	25.02	29.98		
		RING-TITE ROUGH BARREL	4.17	5.33		7.32	9.50	11.92	14.18	16.59		18.90	22.54	25.02	29.98	37.48	
		MIN. STD. ROUGH BARREL		5.22		7.26	9.39	11.77	14.03	16.44		18.74					
		MAX. STD. ROUGH BARREL		5.57		7.60	9.79	12.12	14.38	16.88		19.19					
	NOMINAL PIPE SIZE (INCHES)		3	4	5	6	8	10	12	14	15	16	18	20	24	30	

* Flintite ME is 10.89 for 10" and 12.99 for 12" sizes.



JCM INDUSTRIES, INC.
 P.O. Box 1220 • Nash, Texas 75569-1220
 Call Toll Free 800-527-8482, Fax Toll Free 800-874-9524
 Outside U.S. Call 903-832-2581, Outside U.S. Fax 903-838-6260
www.jcmindustries.com

