



# Universal Fire Tube

Floor and Wall Mount  
Combi Boilers

**Installation**

**Start-Up**

**Maintenance**

**Parts**

**Warranty**

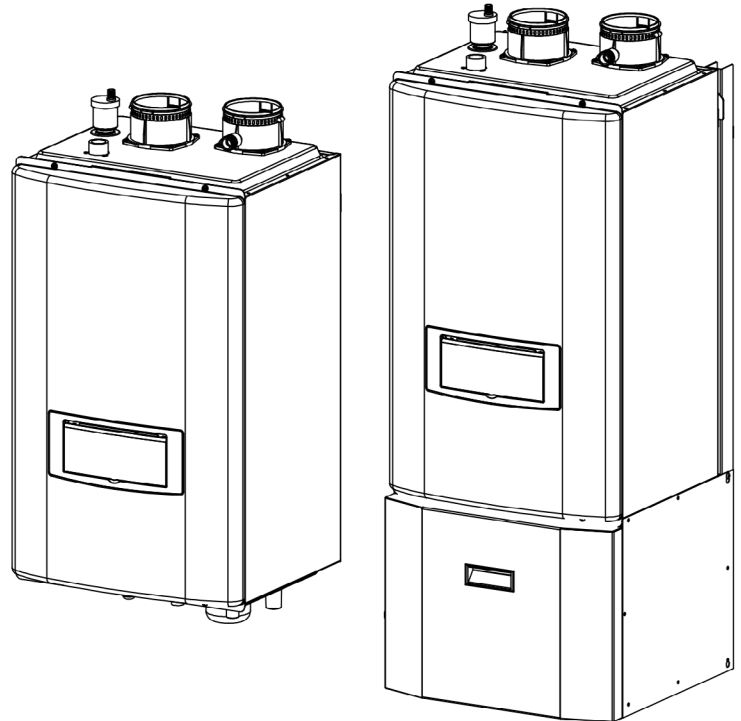

**UFTC-140 / 199\* Models**

\*"F" Denotes Floor Model; "W" Denotes Wall Mount Model, "LP" Denotes Propane Gas



Heat Exchanger Bears the ASME "H" Stamp



## **⚠ DANGER**

This manual must only be used by a qualified service technician. Read all instructions in this manual before installing. Perform steps in the given order. Failure to do so could result in substantial property damage, severe personal injury, or death.

## **⚠ WARNING**

Improper installation, adjustment, alteration, service, or maintenance could void product warranty and cause property damage, severe personal injury, or death.

California Proposition 65 Warning: This product contains chemicals known to the State of California to cause cancer, birth defects, or other reproductive harm.

## **NOTICE**

The manufacturer reserves the right to make product changes or updates without notice and will not be held liable for typographical errors in literature.

The surfaces of these products contacted by potable (consumable) water contain less than 0.25% lead by weight as required by the Safe Drinking Water Act, Section 1417.

**NOTE TO CONSUMER: PLEASE KEEP ALL INSTRUCTIONS FOR FUTURE REFERENCE.**

## ⚠ WARNING

**WARNING:** If the information in these instructions is not followed exactly, a fire or explosion may result causing property damage, personal injury or death.

- Do not store or use gasoline or other flammable vapors and liquids in the vicinity of this or any other appliance.

### WHAT TO DO IF YOU SMELL GAS

- Do not try to light any appliance.
- Do not touch any electrical switch; do not use any phone in your building.
- Immediately call your gas supplier from a neighbor's phone. Follow the gas supplier's instructions.
- If you cannot reach your gas supplier, call the fire department.
- Installation and service must be provided by a qualified installer, service agency or the gas supplier.



**Improper installation, adjustment, alteration, service, or maintenance can cause injury, property damage, or death. Refer to this manual. Installation and service must be performed by a qualified installer, service agency, or gas supplier.**

## FOR YOUR SAFETY READ BEFORE OPERATING

**⚠ WARNING :** If you do not follow these instructions exactly, a fire or explosion may result causing property damage, personal injury or loss of life."

- A. This appliance does not have a pilot. It is equipped with an ignition device which automatically lights the burner. Do not try to light the burner by hand.
- B. **BEFORE OPERATING** smell all around the appliance area for gas. Be sure to smell next to the floor because some gas is heavier than air and will settle on the floor.
- WHAT TO DO IF YOU SMELL GAS**
- Do not touch any electric switch; do not use any phone in your building.
  - Do not try to light any appliance.
  - Immediately call your gas supplier from a neighbor's phone. Follow the gas supplier's instructions.
  - If you cannot reach your gas supplier, call the fire department.
- C. Use only your hand to push in or turn the gas control knob. Never use tools. If the knob will not push in or turn by hand, don't try to repair it, call a qualified technician. Force or attempted repair may result in a fire or explosion.
- D. Do not use this appliance if any part has been under water. Immediately call a qualified technician to inspect the appliance and to replace any part of the control system and any gas control which has been under water.

## OPERATING INSTRUCTIONS

1. STOP! Read the safety information above on this label.
2. Set the thermostat to lowest setting.  
(Never use Water Heater unless it is completely filled with water.)
3. Turn OFF electrical power supply to the Water Heater.
4. Don't try to light the burner by hand.
5. Turn gas shut-off valve clockwise  to "OFF" position. Do not force.
6. Wait five (5) minutes to clear out any gas. If you then smell gas, STOP! Follow step "B" above on this label. If you don't smell gas, go to the next step.
7. Turn manual gas shut-off valve counterclockwise  to "ON" position.
8. Turn ON electrical power to the appliance.
9. Wait until default temperature (125°F) is displayed. Set desired water temperature. Turn on hot water faucet.
10. Set thermostat to desired setting.
11. If the appliance will not operate, follow the instructions "To Turn Off Gas To Appliance" and call your service technician or gas supplier.

## TO TURN OFF GAS TO APPLIANCE

1. Set the thermostat to lowest setting.
2. Turn off all electric power to the appliance if service is to be performed.
3. Turn manual gas shutoff valve to "OFF".

### SPECIAL ATTENTION BOXES

The following defined terms are used throughout this manual to bring attention to the presence of hazards of various risk levels or to important product information.

#### ⚠ DANGER

**DANGER** indicates an imminently hazardous situation which, if not avoided, will result in serious personal injury or death.

#### ⚠ WARNING

**WARNING** indicates a potentially hazardous situation which, if not avoided, could result in personal injury or death.

#### ⚠ CAUTION

**CAUTION** indicates a potentially hazardous situation which, if not avoided, may result in moderate or minor personal injury.

#### CAUTION

**CAUTION used without the safety alert symbol** indicates a potentially hazardous situation which, if not avoided, may result in property damage.

#### NOTICE

**NOTICE** is used to address practices not related to personal injury.

## Foreword

This manual is intended to be used in conjunction with other literature provided with the boiler. This includes all related control information. It is important that this manual, all other documents included in this system, and additional publications including the *National Fuel Gas Code - ANSI Z223.1* (latest versions), be reviewed in their entirety before beginning any work.

Installation should be made in accordance with the regulations of the Authority Having Jurisdiction, local code authorities, and utility companies which pertain to this type of water heating equipment.

Authority Having Jurisdiction (AHJ) – The AHJ may be a federal, state, local government, or individual such as a fire chief, fire marshal, chief of a fire prevention bureau, labor department or health department, building official or electrical inspector, or others having statutory authority. In some circumstances, the property owner or his/her agent assumes the role, and at government installations, the commanding officer or departmental official may be the AHJ.

**NOTE:** The manufacturer reserves the right to modify product technical specifications and components without prior notice.

## For the Installer

This boiler must be installed by qualified and licensed personnel. The installer should be guided by the instructions furnished with the boiler, and by local codes and utility company requirements. In the absence of local codes, preference should be given to the *National Fuel Gas Code - ANSI Z223.1*, latest version.

### Installations Must Comply With:

Local, state, provincial, and national codes, laws, regulations, and ordinances.

The latest version of the *National Fuel Gas Code, ANSI Z223.1*, from American Gas Association Laboratories, 8501 East Pleasant Valley Road, Cleveland, OH 44131.

In Canada - *CGA No. B149* (latest version), from Canadian Gas Association Laboratories, 55 Scarsdale Road, Don Mills, Ontario, Canada M3B 2R3. Also, *Canadian Electrical Code, C 22.1*, from Canadian Standards Association, 5060 Spectrum Way, Suite 100, Mississauga, Ontario, Canada L4W 5N6.

The latest version of the *National Electrical Code, NFPA No. 70*.

**NOTE:** The gas manifold and controls met safe lighting and other performance criteria when undergoing tests specified in *ANSI Z21.10.3* - latest edition.

**⚠ DANGER**

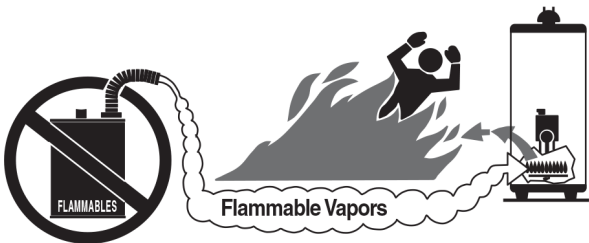

**⚠ Vapors from flammable liquids will explode and catch fire causing death or severe burns.**  
Do not use or store flammable products such as gasoline, solvents or adhesives in the same room or area near the water heater.

**Keep flammable products:**

1. far away from heater,
2. in approved containers,
3. tightly closed and
4. out of children's reach.

Water heater has a main burner and pilot flame.

**The pilot flame:**

1. which can come on at any time and
2. will ignite flammable vapors.

**Vapors:**

1. cannot be seen,
2. are heavier than air,
3. go a long way on the floor and
4. can be carried from other rooms to the pilot flame by air currents.

**Installation:**  
Do not install water heater where flammable products will be stored or used unless the main burner and pilot flames are at least 18" above the floor. This will reduce, but not eliminate, the risk of vapors being ignited by the main burner or pilot flame.

Read and follow water heater warnings and instructions. If owners manual is missing, contact the retailer or manufacturer.

**⚠ DANGER**

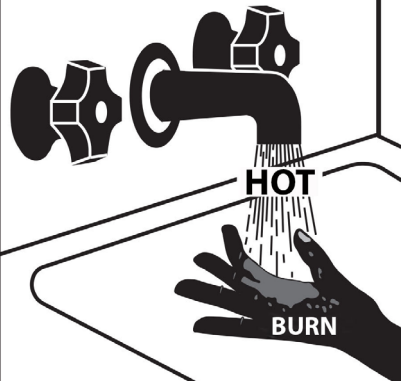

Water temperature over 125°F can cause severe burns instantly or death from scalds. Children, disabled and elderly are at highest risk of being scalded. See instruction manual before setting temperature at water heater. Feel water before bathing or showering. Temperature limiting valves are available, see manual.

## **WARNING**

**The hydronic supply and return connections of these products are for installation in closed loop systems ONLY!** Use of this product in any manner other than described in this manual may result in premature product failure, substantial property damage, severe personal injury, or death. Damage or failure of this product (or the system in which it is installed) due to unauthorized use **IS NOT COVERED BY WARRANTY.**

## **NOTICE**

### **IMPORTANT**

**In accordance with Section 325 (f) (3) of the Energy Policy and Conservation Act, HTP, Inc. has provided this boiler with multiple features designed to save energy by reducing the boiler water temperature as heating load decreases.**

**These features include:**

- **A modulating combustion system that adjusts firing rate based on heat demand.**
- **Adjustment of boiler set point based on inferred heat load as determined by an outdoor sensor. The outdoor sensor is supplied by HTP, Inc. with this boiler.**
- **This boiler does not include a standing pilot.**
- **This boiler is designed and shipped to assure the highest efficiency operation possible. Such high efficiency is achieved by limiting heating circuit water temperature to 140°F when there is no anticipated heat load, based upon the outdoor sensor and the Outdoor Reset Curve (sensor response curve) in the boiler software.**
- **This feature may be over-ridden as described below in specific installations:**
- **The boiler control is equipped with an outdoor sensor override for use with building management systems or in cascaded systems (for systems with total input of 300,000 BTU/hr or greater).**

**See statement below for an important notice on the use of the override.**

### **IMPORTANT**

**In accordance with Section 325 (f) (3) of the Energy Policy and Conservation Act, this boiler is equipped with a feature that saves energy by reducing the boiler water temperature as the heating load decreases. This feature is equipped with an override which is provided primarily to permit the use of an external energy management system that serves the same function. THIS OVERRIDE MUST NOT BE USED UNLESS AT LEAST ONE OF THE FOLLOWING CONDITIONS IS TRUE:**

- **An external energy management system is installed that reduces the boiler water temperature as the heating load decreases.**
- **This boiler is not used for space heating.**
- **This boiler is part of a modular or multiple boiler system having a total input of 300,000 BTU/hr or greater.**
- **This boiler is equipped with a tankless coil.**

## **NOTICE**

The CSD-1 ASME Code, Section CW-400 requires that hot water heating and supply boilers have a) a UL 353 temperature control device, b) at least one (1) temperature-actuated control to shut off the fuel supply when system water reaches a preset operating temperature, c) a high temperature limit control that prevents the water temperature from exceeding the maximum allowable temperature by causing a safety shutdown and lockout, and d) its own sensing element and operating switch.

The temperature control system integrated into the 926 control provided with this heating boiler complies with the requirements of CSD-1 Section CW-400 as a temperature operation control. The control monitors the temperature difference between the inlet and the outlet sensor, which is affected by boiler water flow. If this temperature difference exceeds 55°F (typically because of low water flow or very low heat load), the control will reduce the maximum fan speed. If the temperature difference exceeds 60°F, the control will effectively sense there is little or no water flow or heat load and shut the boiler down. The controller will restart automatically once the temperature difference has dropped below 55°F and the minimum off time (anti-cycle time) has expired. In addition, if the control senses that the outlet water temperature has reached 210°F, the boiler is put into a hard lockout and requires manual reset to restart.

## **WARNING**

### **Protection From Damage**

1. Boilers generating a glow, spark or flame capable of igniting flammable vapors may be installed in a garage, provided the pilots, burners or heating elements and switches are at least eighteen (18) inches (457 mm) above the floor level.
2. Where such boilers installed within a garage are enclosed in a separate, approved compartment having access only from outside of the garage, such boilers may be installed at floor level provided the required combustion air is also taken from the exterior of the garage. Fuel burning boilers having sealed combustion chambers need not be elevated.
3. All boilers installed in areas where they may be subjected to mechanical damage shall be suitably guarded against such damage by being installed behind adequate barriers or by being elevated or located out of the normal path of a vehicle using any such garage.
4. In seismic zones 3 and 4, boilers shall be anchored or strapped to resist horizontal displacement due to earthquake motion. Strapping shall be at points within the upper one-third (1/3) and lower one-third (1/3) of its vertical dimensions. At the lower point, a minimum distance of four (4) inches (102 mm) shall be maintained above the controls with the strapping.
5. An boiler supported from the ground shall rest on level concrete or other approved base extending not less than three (3) inches (76 mm) above the adjoining ground level.
6. Any boiler should be installed in such a manner that if it should leak the resulting flow of water will not cause damage to the area in which it is installed. If the boiler is installed in a location where a leak could cause damage, it is required to provide containment measures.

Table of Contents

**Part 1 - General Safety Information** 5

A. Operation and Installation Warnings 5

B. Improper Combustion 7

C. Gas 7

D. When Servicing the Boiler 7

E. Boiler System 7

F. Water Chemistry Requirements 7

G. Freeze Protection 8

H. Water Temperature Adjustment and Scalding 8

I. High Elevation Installations 9

**Part 2 - Before You Start** 9

A. What's in the Box 9

B. Optional Equipment 9

**Part 3 - Prepare the Boiler Installation** 10

A. Locating the Boiler 10

B. Leveling 10

C. Clearances for Service Access 10

D. Residential Garage and Closet Installations 11

E. Exhaust Vent and Intake Pipe 11

1. Direct Vent of Exhaust and Intake 12

2. Power Venting, Indoor Combustion Air in Confined or Unconfined Space 12

F. Carbon Monoxide Detectors 12

G. Prevent Combustion Air Contamination 12

H. Removing a Appliance from a Common Vent System 13

I. Technical Specifications 14

J. Wall-Mounting (Wall Mount Models Only) 17

K. Flow Restrictor 18

**Part 4 - Water Piping** 19

A. General Plumbing Guidelines 19

B. Backflow Preventer 20

C. Expansion Tank 20

D. Piping the Boiler 21

E. Applications 28

F. CH and DHW Pressure Relief Valves 29

**Part 5 - Venting** 29

A. General 29

B. Approved Materials for Exhaust Vent and Intake Pipe 30

C. Additional Requirements for Installation in Canada 30

D. Exhaust Vent and Intake Pipe Location 31

E. Exhaust Vent and Intake Pipe Sizing 32

F. Tightening Boiler Collar to Exhaust Vent and Intake Pipe 32

G. Exhaust Vent and Intake Pipe Installation 32

H. Applications 33

1. Direct Vent Installation of Exhaust and Intake 33

2. Venting Through an Existing System 36

3. Power Venting, Indoor Combustion Air in Confined or Unconfined Space 37

**Part 6 - Installing the Condensate Drain** 38

**Part 7 - Connecting Electrical Service** 39

A. Wiring 39

B. Dip Switches 39

**Part 8 - Gas Connections** 44

A. Gas Pipe Sizing Tables 44

1. Gas Pipe Sizing 44

2. Natural Gas Pipe Sizing 44

3. LP (Liquid Propane) Gas Pipe Sizing 44

B. Gas Connection Requirements 44

C. Additional Precaution for Excess Flow Valve (EFV) 45

D. Checking Gas Pressure at the Boiler for Proper Operation 45

E. Setting and Verifying the Combustion Setting 45

**Part 9 - Controls** 46

A. Control and Display Overviews 46

B. Start-Up Sequence 47

C. Changing the DHW Set-Point 47

D. Changing the Temperature Indicator 47

E. Changing the CH Set-Point 47

F. Storage Mode 47

G. Lock Function 47

H. Status Display 48

I. Installer Mode 49

J. Outdoor Temperature Mode (Optional) 50

K. 0-10 Volt Input 51

**Part 10 - Troubleshooting** 52

A. Error Code 52

B. Error Tree Analysis 55

1. Flame Detection 55

2. Air Pressure Switch / Burner Overheat Limit / Condensate Block Switch 55

3. DHW / Operating Temperature / CH Overheat / Exhaust Sensors 55

C. Suggested Corrective Actions 56

**Part 11 - Start-Up** 58

A. Check / Control Water Chemistry 58

B. Check for Gas Leaks 58

C. Freeze Protection (When Used) 59

D. Fill and Test Water System 59

E. Purge Air from CH and Internal Storage Tank 59

F. Purge Air from DHW System 60

G. Check Thermostat Circuit(s) 60

H. Condensate Removal 60

**Part 12 - Installation Checklist** 61

**Part 13 - Maintenance** 62

**Part 14 - Moving Adapters from Left to Right (Floor Models)** 67

**Part 15 - Replacement Parts** 67

Limited Warranty for UFTC Boilers 77

Notes 79

Customer Installation Record Form 80



**Part 1 - General Safety Information**

This boiler is approved for indoor installations only and is not intended for use as a pool heater. Clearance to combustibles: 0" top, bottom, sides, and back. Boiler must have room for service: 24" front, 18" top, 12" bottom, and 0" back are minimum recommended service clearances. Minimum recommended side clearances depend on model and installation options. (A combustibles door or removable panel is acceptable front clearance. A 3" minimum clearance must be provided from the boiler front cover to the removable panel or combustibles door.) This boiler has been approved for closet installation and installation on combustibles flooring. Do not install directly on carpeting. Install the boiler in a location where relief valve discharge or a leak will not result in damage to the surrounding area. If such a location is not available, install an auxiliary catch pan. The appliance is rated Category IV (pressurized vent, likely to form condensate in the vent) and requires a special vent system designed for pressurized venting. Use only Category IV vent systems.

 <b>WARNING</b>
<b>Installer</b> - Read all instructions in this manual before installing. Perform steps in the given order.
<b>User</b> - This manual is for use only by a qualified service technician. Have this boiler serviced / inspected annually by a qualified service technician.
<b>FAILURE TO ADHERE TO THE GUIDELINES ON THIS PAGE CAN RESULT IN SUBSTANTIAL PROPERTY DAMAGE, SEVERE PERSONAL INJURY, OR DEATH.</b>
<b>NOTE:</b> Obey all local codes. Obtain all applicable permits before installing the boiler.
<b>NOTE:</b> Install all system components and piping in such a manner that does not reduce the performance of any fire rated assembly.

**A. Operation and Installation Warnings**

To avoid serious injury or death, read, understand, and follow all of the precautions listed here.

 <b>DANGER</b>
Vapors from flammable liquids will explode and can cause a fire, resulting in personal injury or death. The boiler has a burner that can come on at any time and ignite vapors. DO NOT use or store flammable liquids around the boiler.
Improper venting can cause a build-up of carbon monoxide. Breathing carbon monoxide can result in brain damage or death. DO NOT operate the boiler unless it is properly vented to the outside and has an adequate fresh air supply for safe operation. Inspect the exterior exhaust gas outlet port and fresh air inlet port on a regular basis to ensure they are functioning properly.
A concentration of carbon monoxide as small as .04% (400 parts per million) in the air can be fatal. When making high fire or low fire adjustments, CO levels must be monitored using a calibrated combustion analyzer such that a CO level of no more than 150 ppm is exceeded at any time during operation.
Adjusting the "low fire offset" or the "main flow restrictor" in small increments can result in a significant increase in CO concentration. To avoid serious injury or death, DO NOT make any adjustments to the gas valve without monitoring the exhaust gases with a fully functional and calibrated combustion analyzer.
Failure to follow these instructions will result in property damage, severe personal injury, or death.
 <b>WARNING</b>
This boiler must be installed by a qualified service technician. Improper installation and/or operation can cause a potentially hazardous situation, which, if not avoided, could result in serious injury or death, and will void the warranty.
The manufacturer cannot anticipate every circumstance that might involve a potential hazard. Each installation has its own specialized characteristics, requirements, and possible hazards. Therefore, all possible incidents are not included in these warnings. Proper and safe installation, operation, and service are the responsibility of the qualified service technician.
Proper care of the boiler is the user's responsibility. Ensure the user carefully reads and understands the User's Information Manual before operating and maintaining the boiler.
Make sure the user knows the location of the gas shut-off valve and how to operate it. Immediately close the gas shut-off valve if the boiler is subjected to fire, overheating, flood, physical damage, or any other damaging condition that might affect the operation of the unit. Have the boiler checked by a qualified technician before resuming operation.
Do not power up the unit unless the gas and water supply valves are fully opened. Make sure the fresh air intake port and exhaust gas port are open and functional.
No one but a qualified service technician should attempt to install, service, or repair this boiler. There are no serviceable parts which can be changed by the user / owner. User / Owner: Contact the original qualified service technician if the boiler needs repair or maintenance. If the original technician is unavailable, ask your gas supplier for a list of qualified service providers.
Keep the area around the boiler clean and free of all materials that can burn. DO NOT store or place gasoline, oils, spray paint, or other flammable products near the boiler.
DO NOT use spray paint, hair spray, or any other flammable spray near the boiler or near the exterior fresh air intake port. DO NOT place any items in or around the exterior exhaust gas outlet port and/or fresh air inlet port that could restrict or block the flow in or out of the vent system.

 <b>WARNING</b>
DO NOT store or place newspapers, laundry, or other combustible items near the boiler or the exterior exhaust gas outlet and/or fresh air inlet port.
The owner should inspect the system monthly for damage, water stains, signs of rust, corrosion, and exhaust vent and air intake blockage. If inspection of the unit shows signs of damage, the boiler should be shut off until the problem is repaired by a qualified technician.
After installation, all boiler safety devices should be tested.
This boiler is certified for indoor installations only. The boiler consists of gas ignition system components which must be protected from water (dripping, spraying, etc.) during operation and service. Carefully consider installation location and the placement of critical components (circulators, condensate neutralizers, etc.) before installing the boiler.
DO NOT allow children to operate this unit. DO NOT use this unit if it does not appear to be operating correctly. A qualified technician should service and inspect the boiler annually.
<b>NOTICE</b>
This boiler is equipped with a three prong plug. It should only be plugged directly into a properly grounded three prong receptacle. DO NOT remove the ground plug from the plug.
Any claims for damage or shortage in shipment must be filed immediately against the transportation company by the consignee.
This boiler provides a overheat shutdown limit. In the event the boiler water temperature exceeds the set point of the control limit, the cutoff will trip and the boiler will shut down. Certain local codes require additional temperature limits. In addition, certain types of systems may operate at temperatures below the minimum set point of the limit provided with the boiler. Contact the manufacturer for additional overheat controls.
<b>NOTE:</b> When inquiring about service or troubleshooting, reference the model and serial numbers from the boiler rating label.
 <b>WARNING</b>
<b>DO NOT USE THIS BOILER IF ANY PART HAS BEEN SUBMERGED IN WATER.</b> Immediately call a qualified service technician. The boiler MUST BE replaced if it has been submerged. Attempting to operate a boiler that has been submerged could create numerous harmful conditions, such as a potential gas leakage causing a fire and/or explosion, or the release of mold, bacteria, or other harmful particulates into the air. Operating a previously submerged boiler could result in property damage, severe personal injury, or death.
<b>NOTE:</b> Boiler damage due to flood or submersion is considered an Act of God, and IS NOT covered under product warranty.
<b>NOTE:</b> If the boiler is exposed to the following, do not operate. Immediately call a qualified service technician.
<ol style="list-style-type: none"> <li>1. Fire</li> <li>2. Damage</li> <li>3. Water</li> </ol>
Failure to follow this information could result in property damage, severe personal injury, or death.
DO NOT alter or modify the boiler or boiler controls. Altering any HTP, Inc. boiler with parts not manufactured by HTP, Inc. WILL INSTANTLY VOID the boiler warranty and could result in property damage, personal injury, or death.

**CAUTION**

Do not use this boiler for anything other than its intended purpose (as described in this manual). Doing so could result in property damage and WILL VOID product warranty.

Due to the low water content of the boiler, improper sizing of the boiler with regard to heating system load will result in excessive cycling and accelerated component failure. HTP DOES NOT warrant failures caused by improperly sized boiler applications. DO NOT oversize the boiler to the system. Modular boiler installations greatly reduce the likelihood of boiler oversizing.

**B. Improper Combustion**

 **WARNING**

Do not obstruct the flow of combustion and ventilating air. Adequate air is necessary for safe operation. Failure to keep the exhaust vent and combustion air intake clear of ice, snow, or other debris could result in property damage, serious personal injury, or death.

**C. Gas**

Should overheating or gas supply fail to shut off, turn off the manual gas control valve to the boiler.

**D. When Servicing the Boiler**

 **WARNING**

Be sure to disconnect electrical power before opening boiler cabinet or performing service. Label all wires while performing service to ensure proper re-wiring of the boiler. Wiring errors can cause improper or dangerous operation. Failure to do so could result in an electrical shock, improper boiler operation, property damage, serious personal injury, or death.

- To avoid electric shock, disconnect electrical supply before performing maintenance.
- To avoid severe burns, allow boiler and associated equipment to cool before servicing.
- Do not use petroleum-based cleaning or sealing compounds in an boiler system. Gaskets and seals in the system may be damaged. This can result in substantial property damage.
- Do not use "homemade cures" or "patent medicines". Damage to the boiler, substantial property damage, and/or serious personal injury may result.
- Always verify proper operation after servicing the boiler.

**NOTE:** When inquiring about service or troubleshooting, reference the model and serial numbers from the boiler rating label.

**E. Boiler System**

- Thoroughly flush the system (without the boiler connected) to remove sediment. The high efficiency heat exchanger can be damaged by build-up or corrosion due to sediment. The manufacturer recommends a suction strainer in all systems.
- Do not use petroleum-based cleaning or sealing compounds in a boiler system. Gaskets and seals in the system may be damaged. This can result in substantial property damage.
- Do not use "homemade cures" or "patent medicines". Damage to the boiler, substantial property damage, and/or serious personal injury may result.

Continual fresh make-up water will reduce boiler life. Mineral buildup in the heat exchanger reduces heat transfer, overheats the stainless steel heat exchanger, and causes failure. Addition of oxygen from make-up water can cause internal corrosion in system components. Leaks in the boiler or piping must be repaired at once.

**F. Water Chemistry Requirements**

**CAUTION**

Chemical imbalance of the water supply may affect efficiency and cause severe damage to the boiler and associated equipment. Water quality must be professionally analyzed to determine whether it is necessary to treat the water. Various solutions are available to adjust water quality. Adverse water quality will affect the reliability of the system. In addition, operating temperatures above 135°F will accelerate the build-up of lime scale and possibly shorten boiler service life. Failure of a boiler due to lime scale build-up, low pH, or other chemical imbalance IS NOT covered by the warranty.

The water must be potable, free of corrosive chemicals, sand, dirt, and other contaminates. It is up to the installer to ensure the water does not contain corrosive chemicals or elements that can damage the heat exchanger. Potable water is defined as drinkable water supplied from utility or well water in compliance with EPA secondary maximum contaminant levels (40 CFR Part 143.3). If the water contains contaminants higher than outlined by the EPA, water treatment is recommended and additional, more frequent maintenance may be required. See Table 1.

If you suspect that your water is contaminated in any way, discontinue use of the boiler and contact an authorized technician or licensed professional.

Contaminant	Maximum Allowable Level
Total Hardness (Residential Use - Below 140°F water temperature)	200 mg/l (12 grains/gallon)
Total Hardness (Commercial Use - Above 140°F water temperature)	120 mg/l (7 grains/gallon)
Aluminum	0.05 to 0.2 mg/l or PPM
Chloride	100 mg/l or PPM
Copper	1 mg/l or PPM
Iron	0.3 mg/l or PPM
Manganese	0.05 mg/l or PPM
pH	6.5 - 8.5
Sulfate	205 mg/l or PPM
Total Dissolved Solids (TDS)	500 mg/l or PPM
Zinc	5 mg/l or PPM
Dissolved Carbon Dioxide (CO2)	15 mg/l or PPM

**Table 1 - Water Quality Specifications**

**G. Freeze Protection**

**CAUTION**

Consider piping and installation when determining boiler location. Damages resulting from incorrect installation or from use of products not approved by the manufacturer ARE NOT covered by warranty.

 **WARNING**

NEVER use any toxic chemical, including automotive, standard glycol antifreeze, or ethylene glycol made for hydronic (non-potable) systems. These chemicals can attack gaskets and seals in water systems, are poisonous if consumed, and can cause personal injury or death.

The boiler control is equipped with freeze protection that activates based on internal water temperature. See the table below for details on freeze protection operation.

**NOTE:** Freeze protection will not be active if the boiler loses power.

	Freeze Protection Operation	Range
System Freeze Protection (Activates Based on Internal Water Temperature)	<b>Stage 1</b> - If control detects water temperature of 46°F (8°C) and below, it turns the internal and external pumps On for 600 seconds and Off for 30 seconds. This cycle repeats until the control detects inlet water temperature of 50°F (10°C) and above.	ON or OFF (Default: ON) NOTE: If using boiler for Snow Melt applications, turn Freeze Protection OFF.
	<b>Stage 2</b> - If control detects water temperature of 41°F (5°C) and below, it turns the burner on to meet a target temperature of 104°F (40°C). The burner and internal and external pumps will continuously during this stage until the control detects inlet water temperature of 104°F (40°C) and above.	
	<b>Stage 3</b> - If control detects water temperature of 34°F (1°C) and below, Er: 85 will appear on the display.	

**Table 2 - Freeze Protection Detail**

Approximate Time / Temperature Relationships in Scalds	
120°F	More than 5 minutes
125°F	1 1/2 to 2 minutes
130°F	About 30 seconds
135°F	About 10 seconds
140°F	Less than 5 seconds
145°F	Less than 3 seconds
150°F	About 1 1/2 seconds
155°F	About 1 second

**Table 3 - Time and Temperature Relationship in Scalds**

**I. High Elevation Installations**

**⚠ WARNING**

Natural gas at high elevation might contain less heating value than typical 1,000 BTU/cu ft and therefore can cause improper air / gas mix leading to improper combustion. For natural gas installations above 3,000 ft, call your gas provider to determine the heating value of the supplied natural gas.

**H. Water Temperature Adjustment and Scalding**

This boiler can deliver scalding water. Be careful whenever using hot water to avoid scalding injury. Certain boilers such as dishwashers and automatic clothes washers may require increased water temperatures. By setting the thermostat on this heater to obtain the increased water temperature required by these boilers you may create the potential for scald injury.

To protect against injury, install a mixing valve in the water system. This valve will reduce point of use discharge temperatures by mixing cold and hot water in branch supply lines. Such valves are available from your local plumbing supplier.

**⚠ DANGER**

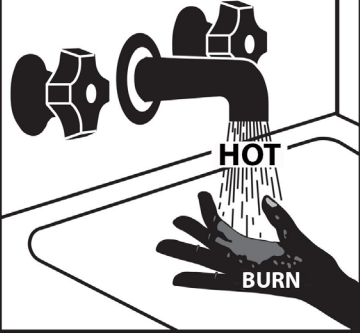

Water temperature over 125°F can cause severe burns instantly or death from scalds. Children, disabled and elderly are at highest risk of being scalded. See instruction manual before setting temperature at water heater. Feel water before bathing or showering. Temperature limiting valves are available, see manual.

Table 3 details the relationship of water temperature and time with regard to scald injury and may be used as a guide in determining the safest water temperature for your applications.



## Part 2 - Before You Start











Open the shipping crate of the boiler.

### NOTICE

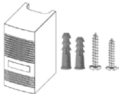
**UNCRATING THE BOILER** - Any claims for damage or shortage in shipment must be filed immediately against the transportation company by the consignee.

#### A. What's in the Box

Components included with the boiler:

Item	Description	Quantity
Universal Fire Tube Combination Boiler		One (1) Floor or Wall Mounted Boiler
User and Installation Manuals, H2 Document		One (1) each
Condensate Hose (Wall Mount Only) (Part # - 7855P-089)		One (1)
Anchors and Wall Mounting Bracket (Wall Mount Only) (7850P-084)		One (1) Kit
Outdoor Sensor with Screws and Anchors (7855P-084)		One (1)
Spare Parts Kit (Gaskets and O-Rings) (7855P-258)		One (1)
LP Conversion Kit (199 Model ONLY - 7855P-452)		One (1)
Vent Screens (3") (7850P-085)		Two (2) screens
CH 30 PSI Pressure Relief Valve and 3/4" x 1" Bushing (7855P-077)		One (1)
Blue Flow Restrictor (Limits Flow to 4.5 GPM - 140 Model Only) (7855P-261)		One (1) Each
Combi Venting Kit (S7855-002)		One (1)

**Table 4 - Included with the Boiler**

#### B. Optional Equipment

Optional equipment available from HTP (and Part #):

Optional Parts		
Threaded 3/4" DHW Tankless Isolation Valves (w/ Pressure Relief Valve) (7850P-090)		1

**Table 5 - Optional Equipment**

#### Other Optional Equipment

Below is a list of other optional equipment available from HTP. These additional options may be purchased through your HTP distributor:

- 2" PVC Concentric Vent Kit (Part # KGAVT0501CVT)
- 3" PVC Concentric Vent Kit (Part # KGAVT0601CVT)
- 2" Stainless Steel Outside Termination Vent Kit (Part # V500)
- 3" Stainless Steel Outside Termination Vent Kit (Part # V1000)
- 4" Stainless Steel Outside Termination Vent Kit (Part # V2000)
- 6" Stainless Steel Outside Termination Vent Kit (Part # V3000)
- 3" Polypro Vent Kit (Part # 8400P-001)
- 3" Polypro Pipe (33' length Part # 8400P-002, 49.5' length Part # 8400P-003)
- Condensate Neutralizer (Part # 7450P-212)
- Condensate Removal Pump (Part # 554200)

- 2" Mesh Vent Screens (Part # 7850P-088)
- UL353 Low Water Cut-Off Kit (Part # 7855P-315)

**NOTE:** When using an optional system sensor, pipe insulation must be wrapped around it to improve temperature measurement accuracy and increase overall system efficiency.

### Part 3 - Prepare the Boiler Installation

Remove all sides of the shipping crate to allow the boiler to be moved into its installation location.

#### CAUTION

**COLD WEATHER HANDLING** - If the boiler has been stored in a very cold location (BELOW 0°F) before installation, handle with care until the components come to room temperature. Failure to do so could result in damage to the boiler.

Carefully consider installation when determining boiler location. Please read the entire manual before attempting installation. Failure to properly take factors such as venting, piping, condensate removal, and wiring into account before installation could result in wasted time, money, and possible property damage and personal injury.

#### A. Locating the Boiler

#### WARNING

This boiler is certified for indoor use only. DO NOT INSTALL OUTDOORS. Outdoor installations ARE NOT covered by warranty. Failure to install the boiler indoors could result in property damage, severe personal injury, or death.

Incorrect ambient conditions can lead to damage to the heating system and put safe operation at risk. Ensure that the installation location adheres to the information included in this manual. Failure to do so could result in property damage, serious personal injury, or death. Failure of boiler or components due to incorrect operating conditions IS NOT covered by product warranty.

This boiler must be installed upright in the vertical position as described in this manual. DO NOT attempt to install this boiler in any other orientation. Doing so will result in improper boiler operation and property damage, and could result in serious personal injury or death.

#### 1. Installation Area (Mechanical Room) Operating Conditions

- Ensure ambient temperatures are higher than 32°F / 0°C and lower than 104°F / 40°C
- Prevent the air from becoming contaminated by the products, places, and conditions listed in this manual
- Avoid continuously high levels of humidity
- Never close existing ventilation openings
- Ensure a minimum 1" clearance around hot water and exhaust vent pipes
- **NOTE:** To prevent condensing in the fan, it is recommended to avoid prolonged exposure to temperatures below 45°F

#### WARNING

This boiler has a condensate disposal system that may freeze if exposed to sustained temperatures below 32°F. Precautions should be taken to protect the condensate trap and drain lines from sustained freezing conditions.

Do not use this boiler only for space heating applications.

Circulators suitable for DHW applications must be used.

Failure to take precautions could result in property damage, severe personal injury, or death.

#### CAUTION

The service life of the boiler's exposed metallic surfaces, such as the casing, as well as internal surfaces, such as the heat exchanger, are directly influenced by proximity to damp and salty marine environments. In such areas higher concentration levels of chlorides from sea spray coupled with relative humidity can lead to degradation of boiler components. In these environments, boilers must not be installed using direct vent systems which draw outdoor air for combustion. Such boilers must be installed using room air for combustion. Indoor air will have a much lower relative humidity, and hence potential corrosion will be minimized.

#### 2. Check for nearby connections to:

- System water piping
- Venting connections
- Gas supply piping
- Electrical power
- Condensate drain

#### 3. Check area around boiler. Remove any combustible materials, gasoline, and other flammable liquids.

#### WARNING

Failure to keep the boiler area clear and free of combustible materials, liquids, and vapors can result in substantial property damage, severe personal injury, or death.

#### 4. Gas control system components must be protected from dripping water during operation and service.

#### 5. If the boiler is to replace an existing boiler, check for and correct any existing system problems, such as:

- System leaks
- Location that could cause the system and boiler to freeze and leak
- Incorrectly sized expansion tank

#### 6. Clean and flush system when reinstalling an boiler.

#### CAUTION

Do not introduce toxic chemicals, such as antifreeze or boiler treatments, into any piping meant for potable water purposes.

Do not connect the boiler DHW connections to any heating systems or components that have been previously used for non-potable applications.

Ensure that all piping and components connected to the boiler are suitable for potable water applications.

**NOTE:** When installing in a zero clearance location, it may not be possible to read or view some product labeling. It is recommended to make note of the boiler model and serial number.

#### B. Leveling

#### CAUTION

In order for the condensate to properly flow out of the collection system, the area where you locate the boiler must be level. Location must also fully support the weight of the filled boiler.

#### C. Clearances for Service Access

See Table 5 for recommended service clearances. If these minimum clearances are not provided, it may not be possible to service the boiler without removing it from the space.

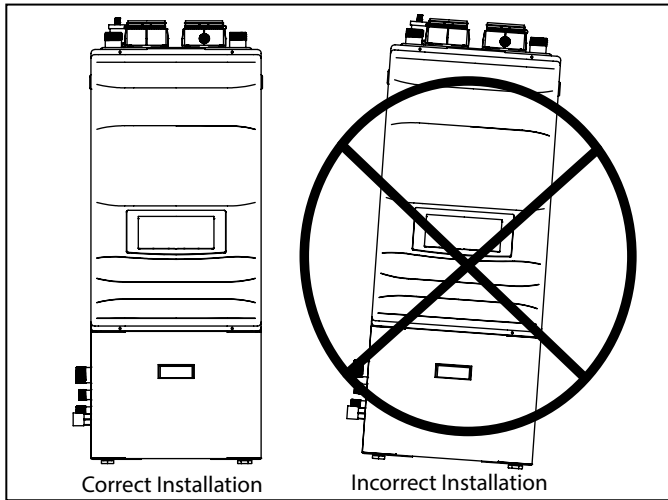

Figure 1 - Leveled Boiler (Floor Model)

**WARNING**

The space must be provided with combustion / ventilation air openings correctly sized for all other boilers located in the same space as the boiler. The boiler cover must be securely fastened to prevent the boiler from drawing air from the boiler room. This is particularly important if the boiler is in a room with other boilers. Failure to comply with the above warnings could result in substantial property damage, severe personal injury, or death.

**Minimum Clearances**

Installation Clearances from Non-Combustibles / Combustibles	Recommended Service and Proper Operation Clearances
Top	18" (45.7 cm)
Back	0" (0 cm)
Bottom (Wall Mount Model)	12" (30.45 cm)
Bottom (Floor Model)	0" (0 cm)
Front	24" (60.9 cm)
Right or Left Side (Wall Mount Model)	3" (7.6 cm)
*Side without Adapters (Floor Model)	
*Adapter Side (Floor Model)	24" (60.96 cm)

**Table 6 - Minimum Installation and Service Clearances - \*NOTE:** The piping configuration of the Floor Model can be changed from the left to the right side of the boiler.

**NOTE:** For closet installations, a combustible door or removable panel is acceptable front clearance. A 3" minimum clearance must be provided from the boiler front cover to the removable panel or combustible door.

**NOTE:** If you do not provide the minimum clearances shown in Table 5 it might not be possible to service the boiler without removing it from the space.

**MINIMUM CLEARANCES FROM COMBUSTIBLE MATERIALS**

- Hot water pipes - at least 1" from combustible materials
- Exhaust vent pipe - at least 1" from combustible materials

**CAUTION**

Always take future maintenance into consideration when locating the boiler. If the boiler is located in an installation location with limited clearances, it may be necessary to remove the boiler from the space to perform maintenance. Failure to consider maintenance when determining installation location could result in property damage.

**CAUTION**

All boilers eventually leak. Locate the boiler where any leakage from the relief valve, related piping, tank, or connections will not result in damage to surrounding areas or lower floors of the building. Any boiler should be installed in such a manner that if it should leak the resulting flow of water will not cause damage to the area in which it is installed. If the boiler is installed in a location where a leak could cause damage, it is required to provide containment measures. Such measures include but are not limited to: a properly sized drain pan installed beneath the boiler and piped to an open drain line, or installing the boiler on a concrete floor pitched to a free flowing drain. Failure to provide containment measures is the sole responsibility of the owner and/or installer. Leakage damages ARE NOT covered by warranty.

In addition, water leak detection devices and automatic water shutoff valves are readily available at plumbing supply houses. IT IS HIGHLY RECOMMENDED BY THE MANUFACTURER TO INSTALL WATER LEAK DETECTION DEVICES AND AUTOMATIC SHUTOFF VALVES IN ANY BOILER INSTALLATION WHERE A LEAKAGE OF WATER COULD RESULT IN PROPERTY DAMAGES.

**D. Residential Garage and Closet Installations**

**CAUTION**

Check with your local Authority Having Jurisdiction for requirements when installing the boiler in a garage or closet. Please read the entire manual before attempting installation. Failure to properly take factors such as venting, piping, condensate removal, and wiring into account before installation could result in wasted time, money, and possible property damage and personal injury.

**Precautions**

If the boiler is located in a residential garage, per ANSI Z223.1:

- Mount the bottom of the boiler a minimum of 18" above the floor of the garage to ensure the burner and ignition devices are well off the floor.
- Locate or protect the boiler so it cannot be damaged by a moving vehicle.

**WARNING**

The space must be provided with correctly sized combustion/ventilation air openings for all other boilers located in the space with the boiler. For power venting installations using room air for combustion, refer to the venting section, this manual, for descriptions of confined and unconfined spaces. Do not install the boiler in an attic. Failure to comply with these warnings could result in substantial property damage, severe personal injury, or death.

**E. Exhaust Vent and Intake Pipe**

The appliance is rated Category IV (pressurized vent, likely to form condensate in the vent) and requires a special vent system designed for pressurized venting.

**NOTE: The venting options described here (and further detailed in the Venting section, this manual) are the lone venting options approved for this appliance. Failure to vent the appliance in accordance with the provided venting instructions will void the warranty.**

**DANGER**

Failure to vent the appliance properly will result in serious personal injury or death.

## ▲ WARNING

Do not attempt to vent this appliance by any means other than those described in this manual. Doing so will void the warranty and may result in severe personal injury or death.

Vents must be properly supported. Appliance exhaust and intake connections are not designed to carry heavy weight. Vent support brackets must be within 1' of the appliance and the balance at 4' intervals. Appliance must be readily accessible for visual inspection for first 3' from the appliance. Failure to properly support vents could result in property damage, severe personal injury, or death.

The exhaust discharged by this appliance may be very hot. Avoid touching or other direct contact with the exhaust gases of the vent termination assembly. Doing so could result in severe personal injury or death.

### 1. Direct Vent of Exhaust and Intake

If installing a direct vent option, combustion air must be drawn from the outdoors directly into the appliance intake and exhaust must terminate outdoors. There are three basic direct vent options detailed in this manual: 1. Side Wall Venting, 2. Roof Venting, and 3. Unbalanced Venting.

Be sure to locate the appliance such that the exhaust vent and intake piping can be routed through the building and properly terminated. Different vent terminals can be used to simplify and eliminate multiple penetrations in the building structure (see Optional Equipment in Venting Section). The exhaust vent and intake piping lengths, routing, and termination methods must all comply with the methods and limits given in the Venting Section, this manual.

When installing a combustion air intake from outdoors, care must be taken to utilize uncontaminated combustion air. **To prevent combustion air contamination, see Table 6.**

### 2. Power Venting, Indoor Combustion Air in Confined or Unconfined Space

This appliance requires fresh, uncontaminated air for safe operation and must be installed in a mechanical room where there is adequate combustion and ventilating air. **NOTE: To prevent combustion air contamination, see Table 6.**

Combustion air from the indoor space can be used if the space has adequate area or when air is provided through a duct or louver to supply sufficient combustion air based on the appliance input. Never obstruct the supply of combustion air to the appliance. If the appliance is installed in areas where indoor air is contaminated (see Table 6) it is imperative that the appliance be installed as direct vent so that all combustion air is taken directly from the outdoors into the appliance intake connection.

**Unconfined space** is space with volume greater than 50 cubic feet per 1,000 BTU/hr (4.8 cubic meters per kW) of the total input rating of all fuel-burning appliances installed in that space. Rooms connected directly to this space through openings not furnished with doors are considered part of the space. See Venting Section for details.

**Confined space** is space with volume less than 50 cubic feet per 1,000 BTU/hr (4.8 cubic meters per kW) of the total input rating of all fuel-burning appliances installed in that space. Rooms connected directly to this space through openings not furnished with doors are considered part of the space.

When drawing combustion air from inside a conventionally constructed building to a confined space, such space should be provided with two permanent openings: one located 6" (15cm) below the space ceiling, the other 6" (15cm) above the space floor. Each opening should have a free area of one square inch per 1,000 BTU/hr (22cm<sup>2</sup>/kW) of the total input of all appliances in the space, but not less than 100 square inches (645cm<sup>2</sup>).

If the confined space is within a building of tight construction, air for combustion must be obtained from the outdoors as outlined in the Venting section of this manual.

## CAUTION

When drawing combustion air from the outside into the mechanical room, care must be taken to provide adequate freeze protection.

## ▲ WARNING

Failure to provide an adequate supply of fresh combustion air can cause poisonous flue gases to enter the living space, resulting in severe personal injury or death. To prevent combustion air contamination, see Table 6.

### F. Carbon Monoxide Detectors

#### In the Commonwealth of Massachusetts and As Required by State and Local Codes:

Installation of Carbon Monoxide Detectors: At the time of installation or replacement of the vented gas fueled appliance, the installing plumber or gas fitter shall observe that a hard wired carbon monoxide detector with an alarm and battery back-up is installed on the floor level where the gas appliance is installed, unless the appliance is located in a detached, uninhabitable structure separate from the dwelling, building, or structure used in whole or in part for residential purposes.

In addition, the installing plumber or gas fitter shall observe that a hard wired carbon monoxide detector with an alarm and battery back-up is installed on each additional level of the dwelling, building, or structure served by the vented gas appliance. It shall be the responsibility of the property owner to secure the service of qualified service technicians for the installation of hard wired carbon monoxide detectors.

a. In the event that the vented gas fueled appliance is installed in a crawl space or attic, the hard wired carbon monoxide detector with alarm and battery back-up shall be installed on the next adjacent floor level.

b. In the event that these requirements cannot be met at the time of completion of installation, the owner shall have a period of thirty (30) days to comply with the above requirements; provided, however, that during said thirty (30) day period, a battery operated carbon monoxide detector with an alarm shall be installed.

## ▲ WARNING

Do not attempt to vent this appliance by any means other than those described in this manual. Doing so will void the warranty and may result in severe personal injury or death.

Approved Carbon Monoxide Detectors: Each carbon monoxide detector as required in accordance with the above provisions shall comply with NFPA 70 and be ANSI/UL 2034 listed and IAS certified.

### G. Prevent Combustion Air Contamination

Install intake air piping for the boiler as described in the Venting Section, this manual. Do not terminate exhaust in locations that can allow contamination of intake air.

## ▲ WARNING

Ensure that the intake air will not contain any of the contaminants in Table 6. Contaminated air will damage the boiler, resulting in possible substantial property damage, severe personal injury, or death. For example, do not pipe intake air near a swimming pool or laundry facilities. These areas always contain contaminants.

Products to Avoid	Areas Likely to Have Contaminants
Spray cans containing fluorocarbons	Dry cleaning / laundry areas and establishments
Permanent wave solutions	Swimming pools
Chlorinated waxes / cleaners	Metal fabrication plants
Chlorine-based swimming pool chemicals	Beauty shops
Calcium chloride used for thawing	Refrigeration repair shops
Sodium chloride used for water softening	Photo processing plants
Refrigerant leaks	Auto body shops
Paint or varnish removers	Plastic manufacturing plants
Hydrochloric or Muriatic acid	Furniture refinishing areas and establishments
Cements and glues	New building construction
Antistatic fabric softeners used in clothes dryers	Remodeling areas
Chlorine-type bleaches, laundry detergents, and cleaning solvents	Garages and workshops
Adhesives used to fasten building products	

**Table 7 - Products and Areas Likely to Have Contaminants**

**NOTE: DAMAGE TO THE BOILER CAUSED BY EXPOSURE TO CORROSIVE VAPORS IS NOT COVERED BY WARRANTY.** (Refer to the limited warranty for complete terms and conditions.)

**H. Removing a Appliance from a Common Vent System**

**DANGER**

Do not install the appliance into a common vent with any other appliance. This will cause flue gas spillage or appliance malfunction, resulting in possible substantial property damage, severe personal injury, or death.

**WARNING**

Failure to follow all instructions can result in flue gas spillage and carbon monoxide emissions, causing severe personal injury or death.

When removing an existing appliance, follow the steps below.

1. Seal any unused openings in the common venting system.
2. Visually inspect the venting system for proper size and horizontal pitch to determine if there is blockage, leakage, corrosion, or other deficiencies that could cause an unsafe condition.
3. If practical, close all building doors, windows, and doors between the space in which the appliance remains connected to the common venting system and other spaces in the building. Turn on clothes dryers and any appliances not connected to the common venting system. Turn on any exhaust fans, such as range hoods and bathroom exhausts, at maximum speed. Do not operate a summer exhaust fan. Close all fireplace dampers.
4. Place in operation the appliance being inspected. Follow the lighting instructions. Adjust the thermostat so the appliance will operate continuously.
5. Test for spillage at the draft hood relief opening after 5 minutes of main burner operation. Use the flame of a match or candle or smoke from a cigarette.
6. After it has been determined that each appliance remaining connected to the common venting system properly vents when tested as outlined, return doors, windows, exhaust fans, fireplace dampers, and any other gas burning appliances to their previous condition of use.
7. Any improper operation of the common venting system should be corrected to conform to the National Fuel Gas Code, ANSI Z223.1. When resizing any portion of the common venting system, the system should approach the minimum size as determined using the appropriate tables in Appendix G of ANSI Z223.1.

**WARNING**

**Breathing Hazard - Carbon Monoxide Gas**

- Do not operate heater if flood damaged.
- Install vent system in accordance with local codes and manufacturers installation instructions.
- Do not obstruct heater air intake or exhaust. Support all vent piping per manufacturers installation instructions.
- Do not place chemical vapor emitting products near unit.
- According to NFPA 720, carbon monoxide detectors should be installed outside each sleeping area.
- Never operate the heater unless it is vented to the outdoors.
- Analyze the entire vent system to make sure that condensate will not become trapped in a section of vent pipe and therefore reduce the open cross sectional area of the vent.

**Breathing carbon monoxide can cause brain damage or death. Always read and understand instruction manual.**

LP-304

**Figure 2 - CO Warning Label**

## I. Technical Specifications

Model		140	199
Installation		Indoor, Wall Mounted Model or Floor Model, Fully Condensing	
Minimum / Maximum Input (Btu/Hr)	Central Heating (CH)	14,000 / 140,000	19,900 / 140,000*
	Domestic Hot Water (DHW)		19,900 / 199,000*
Flue System		Category IV, Sealed Combustion Direct Vent, Power Vent	
Vent Run		2" (50 feet), 3" (100 feet), Schedule 40 PVC, CPVC, PP	
AFUE		96%	95%
Hot Water Capacity	35°F Rise	7.1 GPM	9.9 GPM
	45°F Rise	5.5 GPM	7.7 GPM
	77°F Rise	3.2 GPM	4.8 GPM
Weight (lbs) Wall Mount Model		110	120
Weight (lbs) Floor Model		140	150
Orifice Size	NG	-	0.327" (8.3mm)
	LP	-	0.244" (6.2mm)
Gas Supply Pressure	NG	3.5" to 14" WC	
	LP		
Power Supply	Main Supply	120V 60 Hz, 6A	
	Maximum Power Consumption	160W	
General Operating Conditions		Ambient Temperature Range: 33 – 104°F (0.6 – 40°C) Operating Relative Humidity: Up to 90% at 140°F (40°C) Shipping and Storage Temperature Range: -4 – 176°F (-20 – 80°C) Power Supply and Communication (CN4): 14V DC Product Approvals and Requirements EMC: 89/336/EEC LVD: 73/23/EEC	
Ignition System		Direct Electronic Ignition / Automatic Flame Sensing	
Burner System		Premixed Fuel Modulation / Ceramic Fiber Infrared	
Gas Valve System		Combination Modulating (Current Proportional)	
Internal Pipe Material		Copper	
Wall Mount Model Dimensions		W 17.5" - H 34" - D 15.4"	W 19.7" - H 37" - D 16.8"
Floor Model Dimensions		W 19" - H 45" - D 17"	W 22" - H 48" - D 18"
Internal Storage Tank Water Capacity (DHW)		1 Gallon	1.5 Gallons
Heat Exchanger Capacity		4 Gallons	3.5 Gallons
Minimum Flow Rate		0.5 GPM	
Total Water Capacity		5 Gallons	
Control Panel / Main Controller		NGTX-900C / P-920C_CB-HTP	
CH Water Pressure		Min 12 - Max 30 PSI	
DHW Water Pressure		Max 150 PSI	
Connection Sizes	DHW Inlet / Outlet	3/4" NPT	
	CH Supply / Return	1" NPT	
	Gas Inlet	3/4" NPT	
Materials	Cabinet (Wall Mount Model)	Painted Cold Rolled Carbon Steel	
	Cabinet (Floor Model)	Galvaneal	
	Heat Exchanger	316L Stainless Steel	
Safety Devices		Optical Flame Sensor, Burner Plate High Limit (392°F), Water Temperature High Limit Sensor (200°F), Freeze Protection (Three Stage Operation - Activates at 46°F - See Freeze Protection in Installer Menu for Details), Exhaust Temperature High Limit Sensor (190°F), Blocked Flue Switch, Condensate Switch, Built-In Low Water Cut-Off Probe	

**Table 8 - Technical Specifications - \*NOTE: 199 Models offer a maximum BTU/Hr Input of 140,000 as shipped. Maximum BTU/Hr can be increased up to 199,000 BTU/Hr with a larger external pump installed in the primary loop.**

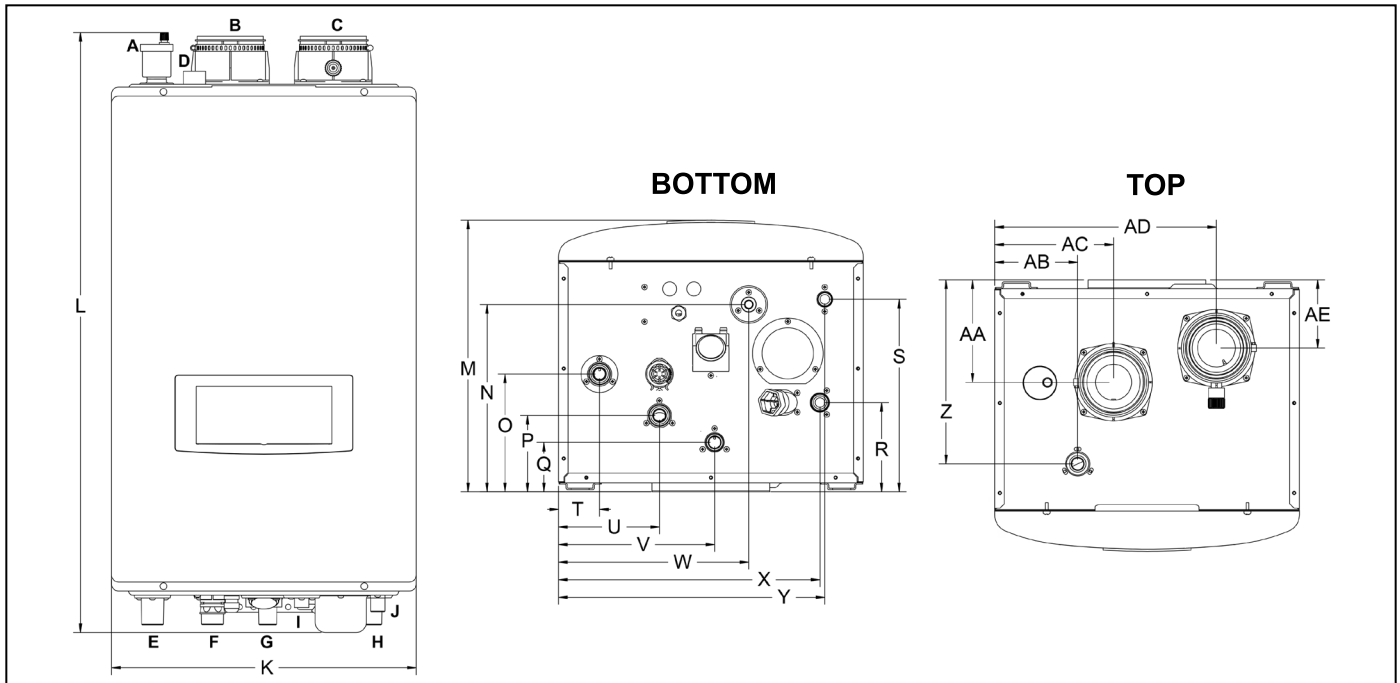

Figure 3 - Wall Mount Model Dimensions

	Description	Diameter
A	Automatic Air Vent	-
B	Air Intake Adapter	3"
C	Exhaust Vent Adapter	
D	Pressure Relief Valve Adapter	3/4" NPTF
E	CH Supply Adapter	1" NPT
F	CH Return Adapter	
G	DHW Outlet Adapter	3/4" NPT
H	DHW Inlet Adapter	
I	Gas Inlet Adapter	
J	Condensate Adapter	1/2" NPT (3/4" PVC Socket on Floor Models)

Table 9 - Adapter Specifications - All Models

Model	K	L	M	N	O	P	Q	R	S	T	U	V	W	X	Y	Z	AA	AB	AC	AD	AE
140	17.3	34	15.4	10.6	6.7	4.3	2.8	5.1	11.0	2.3	5.7	8.9	10.8	14.9	15.1	10.5	5.9	2.3	6.8	12.6	3.9
199	19.7	37	16.8		7.8	5.4	4.0	6.3	12.3	2.5	5.9	10.6		16.6	17.0	12.5	7.0	3.2	9.2	15.1	3.7

Table 10 - Wall Mount Specifications and Dimensions

**How the Boiler Operates**

Condensing technology intelligently delivers hydronic heating while maximizing efficiency. Outlined below are the features of the system and how they operate:

**Stainless Steel Heat Exchanger** - The highly efficient 316L stainless steel fire tube heat exchanger with internal aluminum is designed to extract all available heat from the combustion process and pass it into heat transfer fluid. The stainless steel construction provides protection for longer service life. The heat exchanger offers greater water content, providing lower system pressure and greater overall system efficiency.

**10 to 1 Modulating Combustion System** - The combustion system is specially designed to provide very high turn down. This combustion system will modulate the burner output to very low levels to match the system demand and achieve better overall control of the heating system for maximum efficiency and reliability.

**Control** - The integrated control system monitors the system and responds to internal and external signals to regulate fan speed and control output. This allows the boiler to deliver only the amount of heat energy required and nothing more.

The control can be set up to monitor outdoor temperature through

an outdoor sensor to regulate boiler set point temperature, increasing overall system efficiency while providing great comfort.

**Electronic LCD Display** - The high resolution display allows the user to monitor boiler functions. The display also provides the means to program the system parameters to maximize the efficiency of the system design.

**Combustion System (Blower - Gas Valve - Mixer - Burner - Spark Ignition)** - The highly efficient spark ignition combustion system uses a variable speed blower to adjust combustion as the system requires more or less energy. The negative regulated gas valve provides only the amount of fuel required to ensure clean combustion. The mixer accurately regulates the combination of gas and air throughout the modulating range to ensure high reliability. The burner is constructed of durable ceramic metal fiber for long service life.

**Boiler Sensors (Inlet - Outlet - Flue - Outdoor)** - Sensors provide highly accurate temperature monitoring to assure accurate system control. These sensor inputs can be monitored through the boiler control system and display.

**Pressure Gauge** - Allows the user to monitor system pressure.

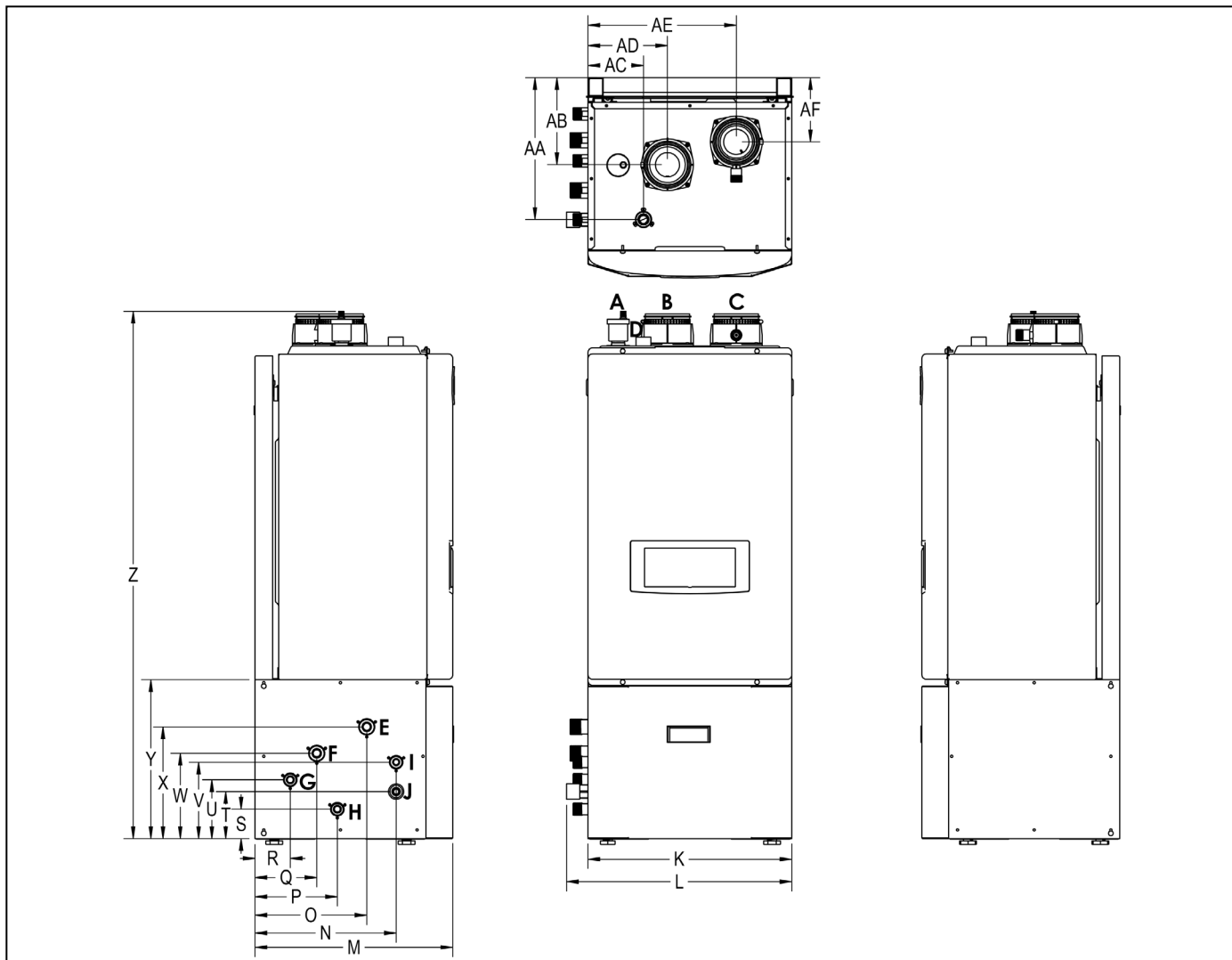

Figure 4 - Floor Model Dimensions

Model	K	L	M	N	O	P	Q	R	S	T	U	V	W	X	Y	Z	AA	AB	AC	AD	AE	AF
140	17.3	19.1	16.8	12	9.5	7	5.3	3	2.5	4	5	6.5	7.3	9.5	13.5	44.8	12	7.4	4.7	6.8	12.6	5.5
199	19.7	21.5	18.2	13.3	10.8	8.3	6.6	4.3								48	14	8.5	3.2	9.2	15.1	5.2

Table 11 - Floor Model Specifications and Dimensions

**System Safeties** – The boiler is provided with many safety features to ensure reliable and safe operation. Each safety is connected to the boiler control. The boiler will alert the user if an unsafe condition occurs and needs to be addressed. The following are provided safeties: Flue Pressure Switch (monitors flue pressure), Burner High Limit (monitors burner plate temperature), High Limit Water Switch (monitors boiler temperature), Low Water Sensor (monitors water level in the heat exchanger), optic flame sensor (monitors flame quality), Flue Sensor (monitors flue temperature), Condensate Pressure Switch (monitors pressure to ensure condensation does not back up into boiler).

**Manual Air Vent** – Each boiler is equipped with an air vent to discharge air from the system during start-up.

**Intake and Exhaust Adapters** – The boiler is equipped with adapters to ease connection to the vent system. The adapters are provided with clamps and seals to secure field supplied piping, and test ports to ease monitoring of the combustion system. Each boiler is supplied with a 6 inch piece of CPVC that must be connected into the exhaust vent adapter.

**Boiler 1" Return and 1" Supply Connection** – Boilers are equipped with both top and bottom piping connections for greater installation flexibility.

**Gas Connection** – The boiler is equipped with a 3/4" gas connection

to connect the incoming gas supply.

**Field Wiring and Power Switch** – Each boiler is supplied with a power switch to cut off power. The boiler is also equipped with two front mounted terminal strips. These terminal strips are separated into low and line voltage to ease system wiring.

**Condensate Trap and Hose Assembly** – Each boiler has a built-in condensate trap to control the discharge of condensate produced by the boiler during normal operation. A corrugated condensate hose is also provided to ensure proper drainage of condensate into the pump or drain.

**Low Water Cut Off Probe** – LWCO is provided with each boiler to ensure the boiler has an adequate water level to eliminate overheating and damage to the heat exchanger.

**Pump Service Mode** – Allows manual operation of pumps to commission system and check pump operation.



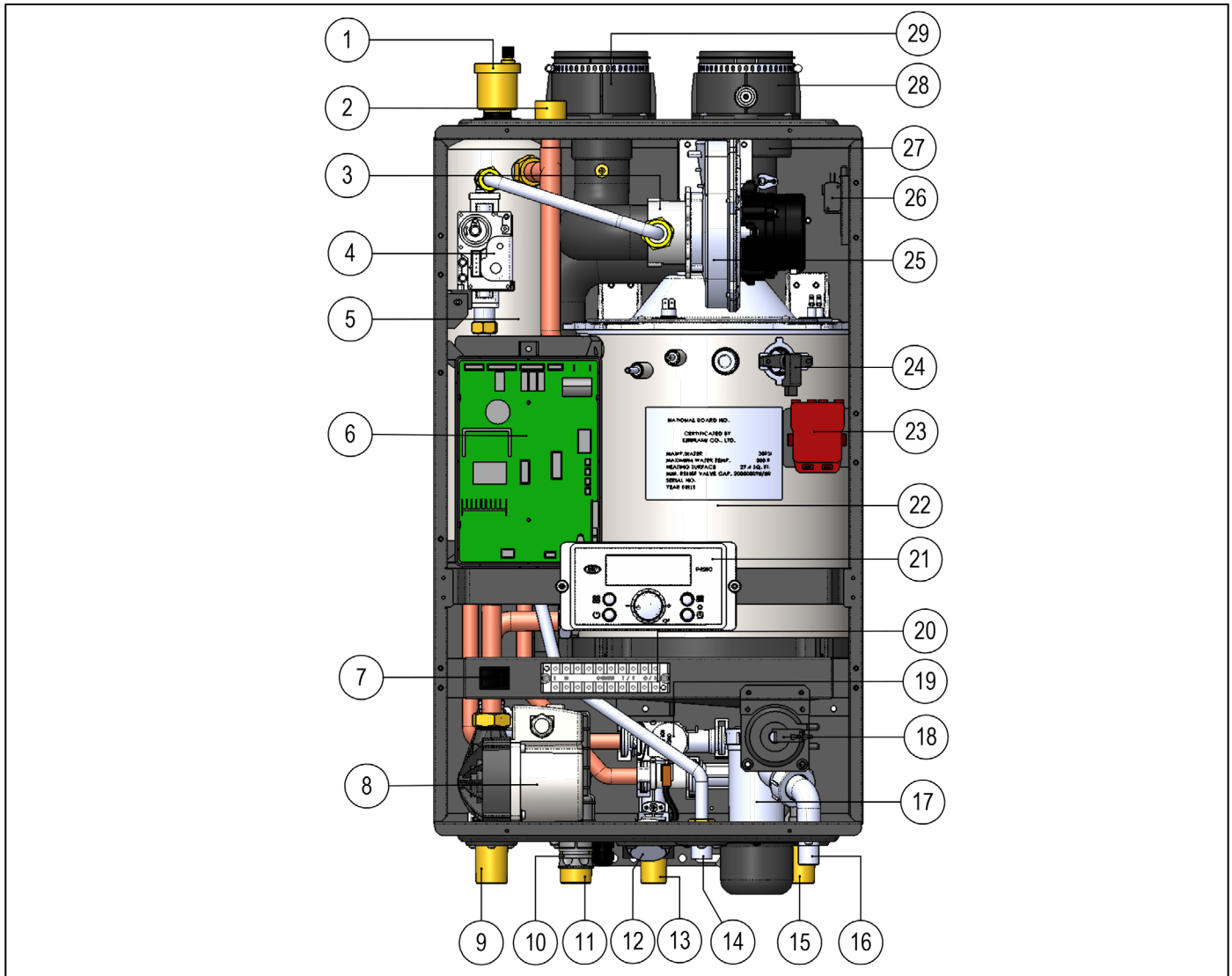

Figure 5 - Components

Number	Component Description	Number	Component Description	Number	Component Description
1	Air Vent	11	CH Return Adapter	21	Control Panel
2	Relief Valve Adapter	12	CH Pressure Gauge	22	Heat Exchanger
3	Air / Gas Mixing Pipe	13	DHW Outlet Adapter	23	Ignition Transformer
4	Gas Valve	14	Gas Inlet Adapter	24	Flame Detecting Sensor
5	Internal Storage Tank	15	DHW Inlet Adapter with Filter and Flow Restrictor	25	BLDC Fan
6	Main PCB	16	Condensate Adapter	26	Air Pressure Switch
7	Manual ON/OFF Power Switch	17	Condensate Trap	27	Exhaust Vent Pipe
8	Internal Recirculation Pump (DHW) / CH Internal Primary Pump	18	Condensate Air Pressure Switch	28	Exhaust Vent Adapter
9	CH Supply Adapter	19	Mixing Valve	29	Air Intake Adapter
10	CH Return Filter	20	Terminal Block		

Table 12 - Component List

**J. Wall-Mounting (Wall Mount Models Only)**

WARNING

The boiler must be installed on a wall that can bear its weight (more than 110 lbs. when fully plumbed and full of water). Installing the boiler on a wall which cannot support its weight could result in property damage, personal injury, or death.

The boiler may be installed on any suitable internal wall (suitable sound-proofing may be required when installing onto a stud partition wall).

## ⚠ WARNING

This boiler is too heavy for one person to lift. It is highly recommended to install the boiler with two people. Use caution as to not drop the boiler, which could damage the boiler and cause property damage and/or severe personal injury. Verify that the boiler is properly and securely mounted before leaving unsupervised. Failure to comply with the above and properly mount the boiler could result in substantial property damage, severe personal injury, or death.

This wall mounting system is not seismic rated and should not be applied as such. Failure to comply with the above and properly mount the boiler could result in substantial property damage, severe personal injury, or death.

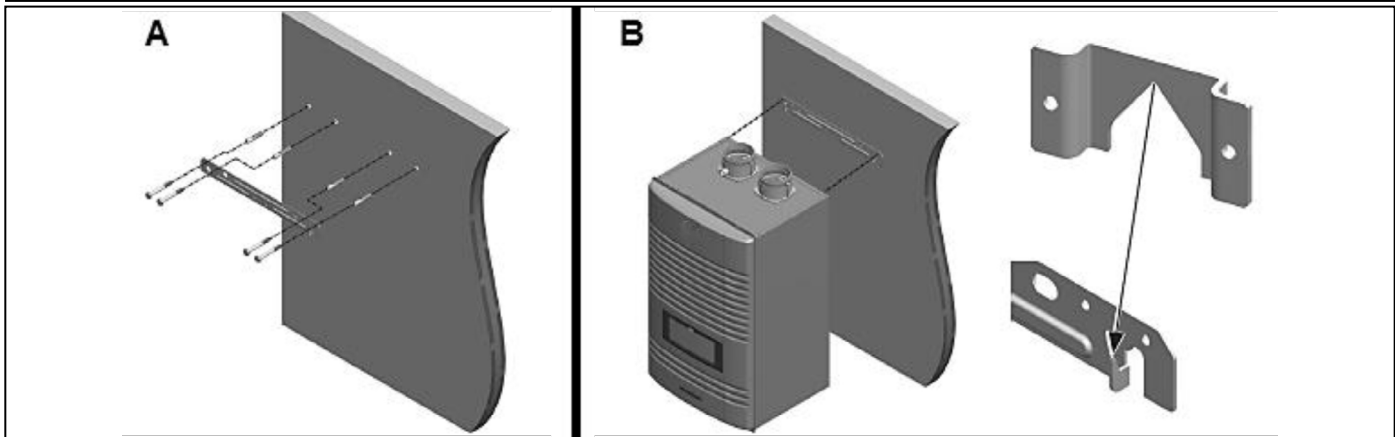

**Figure 6 - Wall-Mounting the Boiler**

### Positioning the Boiler on the Wall

1. Attach the wall bracket on the location where you want to install the boiler. Ensure it is level and on stud (16" centers) before proceeding.
2. Mark the four drill holes with a pencil or marker. Remove the wall bracket.
3. Drill four (4) holes using a 5/32 drill bit at the marked hole locations.
4. Mount the wall bracket to the wall with the four (4) included anchor bolts. Ensure the mounted bracket is level. See Figure 7A.
5. Align the boiler bracket grooves on the back of the boiler with the tongues on the wall bracket and hang the boiler on the bracket. See Figure 7B.

### K. Flow Restrictor

A flow restrictor is installed on this boiler in the DHW inlet adapter to avoid excessive flow at the faucets. See Flow Charts, this manual, for more information.

If it is necessary to further increase flow to the system, replace the factory installed white flow restrictor with the blue included with the boiler by following the instructions below.

## ⚠ WARNING

If the boiler is already fully installed, turn the gas, power, and water off to the boiler and drain all water from the boiler BEFORE proceeding. Failure to comply could result in substantial property damage, severe personal injury, or death.

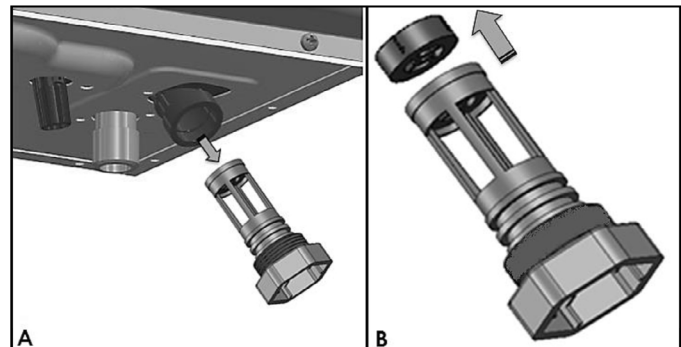

**Figure 7 - A - Removing the DHW Inlet Filter, B - Removing the Flow Restrictor**

1. Locate the DHW inlet adapter on the bottom of the boiler.
2. Pull the two pins to release the DHW inlet filter. See Figure 7-A. The flow restrictor is attached to the top of the filter assembly.
3. Remove the installed white flow restrictor and replace it with the blue flow restrictor included with the boiler. See Figure 7-B.
4. Reinstall the DHW inlet filter.
5. Reinstall the two pins.

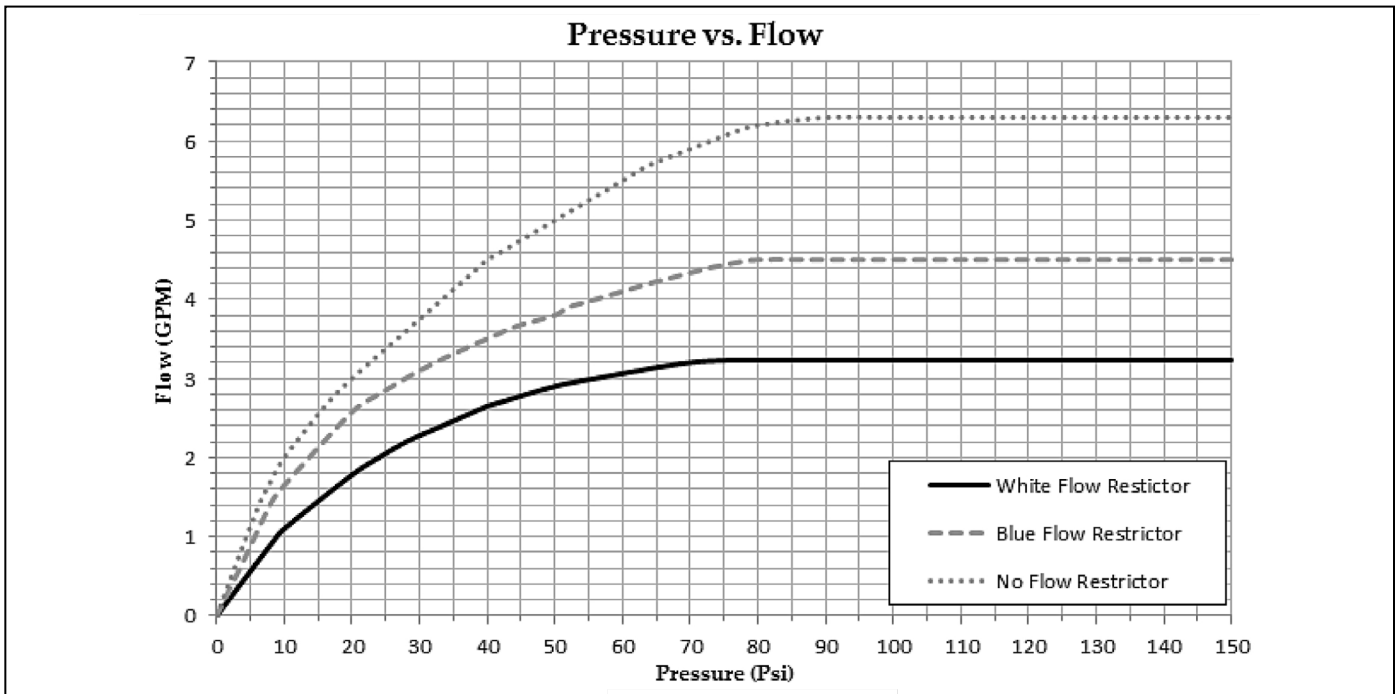

Figure 8 - Water Pressure vs. Flow through the Restrictors - 140 Models

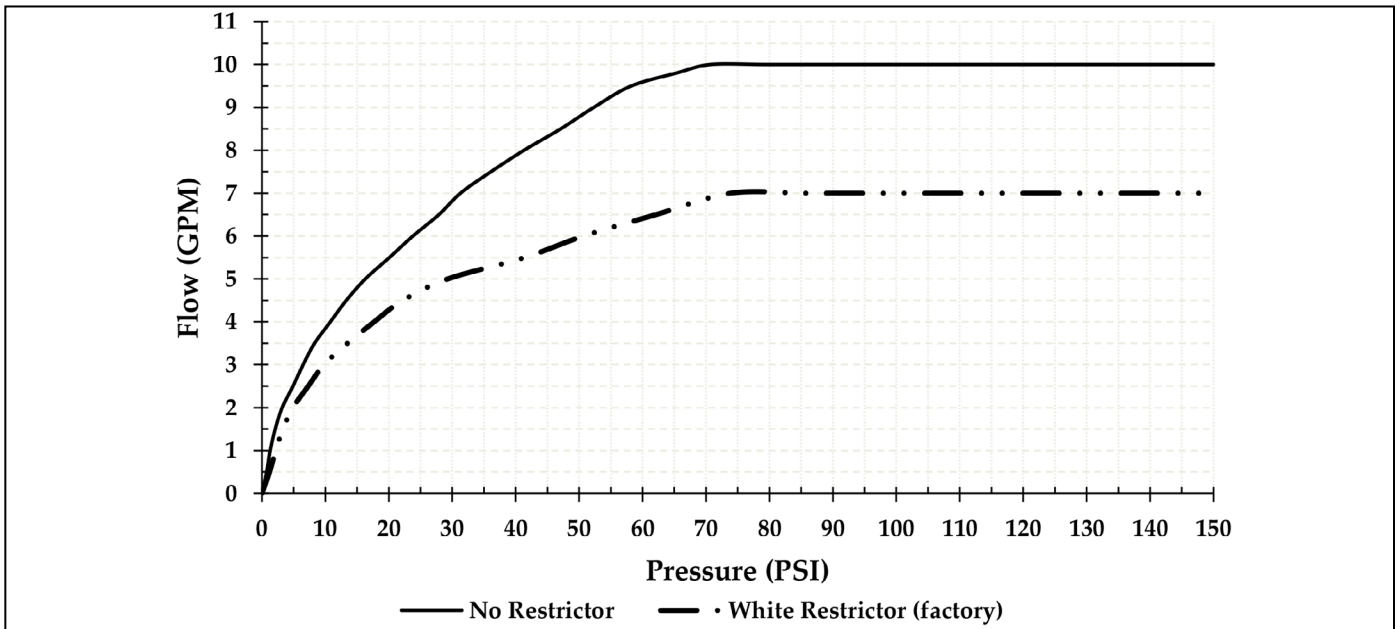

Figure 9 - Water Pressure vs. Flow through the Restrictors - 199 Models

**Part 4 - Water Piping**

<b>WARNING</b>
Failure to follow the instructions in this section WILL VOID the warranty and may result in property damage, severe personal injury, or death.
<b>CAUTION</b>
Do not apply a torch within 12" of the boiler. If sweat connections are used, sweat tubing to the adapter before fitting adapter to the water connections on the boiler. Damages due to improper installation practices ARE NOT covered by warranty.
Dielectric unions or galvanized steel fittings must not be used in a system with this boiler. Doing so WILL VOID the warranty. Use only copper, brass, or stainless steel fittings. Teflon thread sealant must be used on all connections.

**A. General Plumbing Guidelines**

<b>CAUTION</b>
Use two wrenches when tightening water piping at the boiler. Use one wrench to prevent the boiler return or supply line from turning. Failure to prevent piping connections from turning could cause damage to boiler components.
The boiler control module uses temperature sensors to provide both high limit protection and modulating temperature control. The control module also provides low water protection by sensing the water level in the heat exchanger. Some codes / jurisdictions may require additional external controls.

The water connections must be installed in accordance with all local and national plumbing codes, or any applicable standard which prevails.

- Pipe material must be suitable to meet local codes and industry standards.
- The pipe must be cleaned and without blemish before any connections are made.
- The size of the DHW pipes should be 3/4" diameter, and the CH pipes should be 1" diameter.
- Isolation (shutoff valves) should be used on both the CH and DHW loops to ease future servicing.
- All piping should be insulated.

It is recommended to install a sweat shut-off valve and a union in the return and supply piping to ease future servicing. If there is a backflow preventer or any type of a no return valve in the system, install an additional tee here, suitable for an expansion tank.

**B. Backflow Preventer**

It may be recommended to use a backflow preventer - check local codes. If a backflow preventer or a no return valve is used, a thermal expansion tank must be installed on the cold water supply between the boiler and the valve.

 <b>WARNING</b>
To control thermal expansion, a thermal expansion tank should be installed in systems with an installed backflow preventer. DO NOT use a closed type expansion tank. Follow expansion tank manufacturer's specifications to properly size an expansion tank to the installation. Failure to properly accommodate thermal expansion could result in property damage, severe personal injury, or death.

**C. Expansion Tank**

**Expansion Tank**

1. Ensure that the expansion tank is designed and sized to correctly handle system water volume and temperature. Check technical specifications for the water content of this boiler.

 <b>WARNING</b>
Expansion tanks must be sized according to total system volume. This includes all length of pipe, all fixtures, boilers, etc. Failure to properly accommodate thermal expansion could result in property damage, severe personal injury, or death.

<b>CAUTION</b>
Undersized expansion tanks cause system water to be lost from the relief valve, causing make-up water to be added. Eventual boiler failure can result due to excessive make-up water addition. <b>SUCH FAILURE IS NOT COVERED BY WARRANTY.</b>

2. The expansion tank must be located as shown in Applications, this manual, or following recognized design methods. See expansion tank manufacturer's instructions for details.

3. Connect the expansion tank to the air separator only if the air separator is on the suction side of the circulator. Always install the system fill connection at the same point as the expansion tank connection to the system.

<b>CAUTION</b>
<b>DO NOT</b> install automatic air vents on closed type expansion tank systems. Air must remain in the system and return to the tank to provide an air cushion. An automatic air vent would cause air to leave the system, resulting in improper operation of the expansion tank.

**Diaphragm (or Bladder) Expansion Tank**

Always install an automatic air vent on top of the air separator to remove residual air from the system.

**D. Piping the Boiler**

<b>CAUTION</b>
Use at least the MINIMUM pipe size for all boiler loop piping This is to avoid the possibility of inadequate flow through the boiler. Using less than the required minimum pipe size and piping could result in system problems, property damage, and premature boiler failure. Such problems ARE NOT covered by product warranty.

Use both thread tape and pipe dope to connect the 3/4" DHW inlet and outlet pipes. A shut off valve between the city water supply and DHW inlet is recommended for ease of service. HTP offers threaded 3/4" DHW tankless isolation valves with a DHW pressure relief valve for ease of installation and future service.

Use both thread tape and pipe dope to connect the 1" CH return and supply pipes. Isolation valves between are recommended for ease of service.

### E. Applications

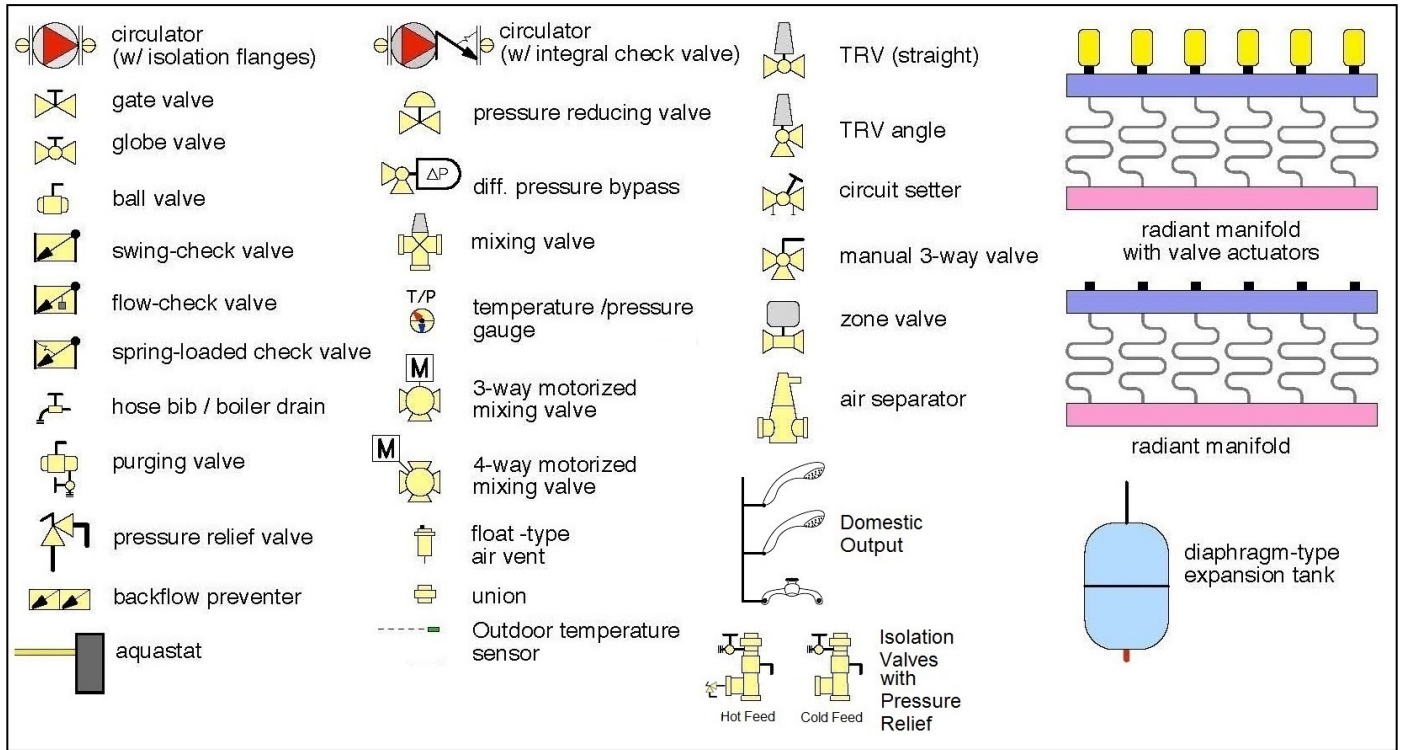
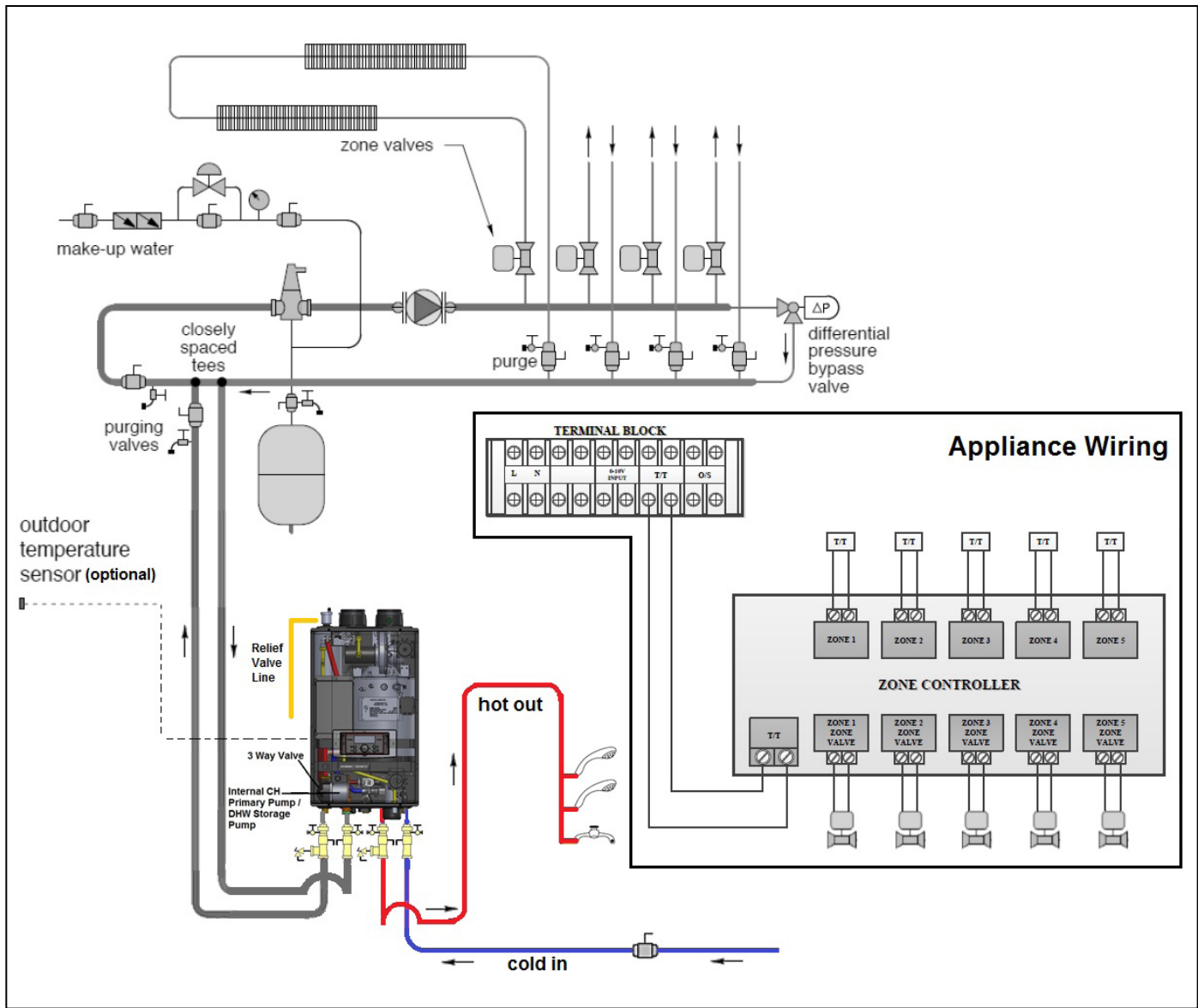

Figure 10 - Piping Symbol Legend



**Figure 11 - Primary / Secondary Piping with Zone Valves - DHW Priority and Outdoor Reset**

**NOTES:**

1. This drawing is meant to show system piping concept only. Installer is responsible for all equipment and detailing required by local codes.
2. All closely spaced tees shall be within 4 pipe diameters center to center spacing.
3. A minimum of 6 pipe diameters of straight pipe shall be installed upstream and downstream of all closely spaced tees.
4. The minimum pipe size of DHW piping should be  $\frac{3}{4}$ " diameter and CH piping should be 1" in diameter.
5. Circulators are shown with isolation flanges. The alternative is standard flanges with full port ball valves. Purge valves can be used with circulator flanges as an alternative.
6. Piping shown is Primary/Secondary. System flow (secondary loop) must be greater than the boiler's primary loop flow.
7. Install a minimum of 12 diameters of straight pipe upstream of all circulators.
8. **VERY IMPORTANT** – Minimum flow rates outlined in this manual must be maintained through the heat exchanger to minimize short cycling.
9. In a valve-based system, each heating zone has a zone valve which opens when that zone calls for heat. Each zone thermostat is wired to its corresponding zone valve. Contacts in the zone valves provide a signal to the boiler to operate when there is a call for heat.
10. **Unit is equipped with built-in primary pump for the heating loop.** This pump is sized to insure proper flow rate through the boiler heat exchanger and related piping. On long pipe runs, it is recommended to keep the pump at maximum speed (setting 3). DO NOT lower it from the factory default.
11. **NOTE:** DO NOT INSTALL a flow check or a pump with flow check on the return line of the primary loop going to the boiler. This will isolate the boiler from the expansion tank, causing pressure to build up in the unit and the Pressure Relief Valve to discharge.

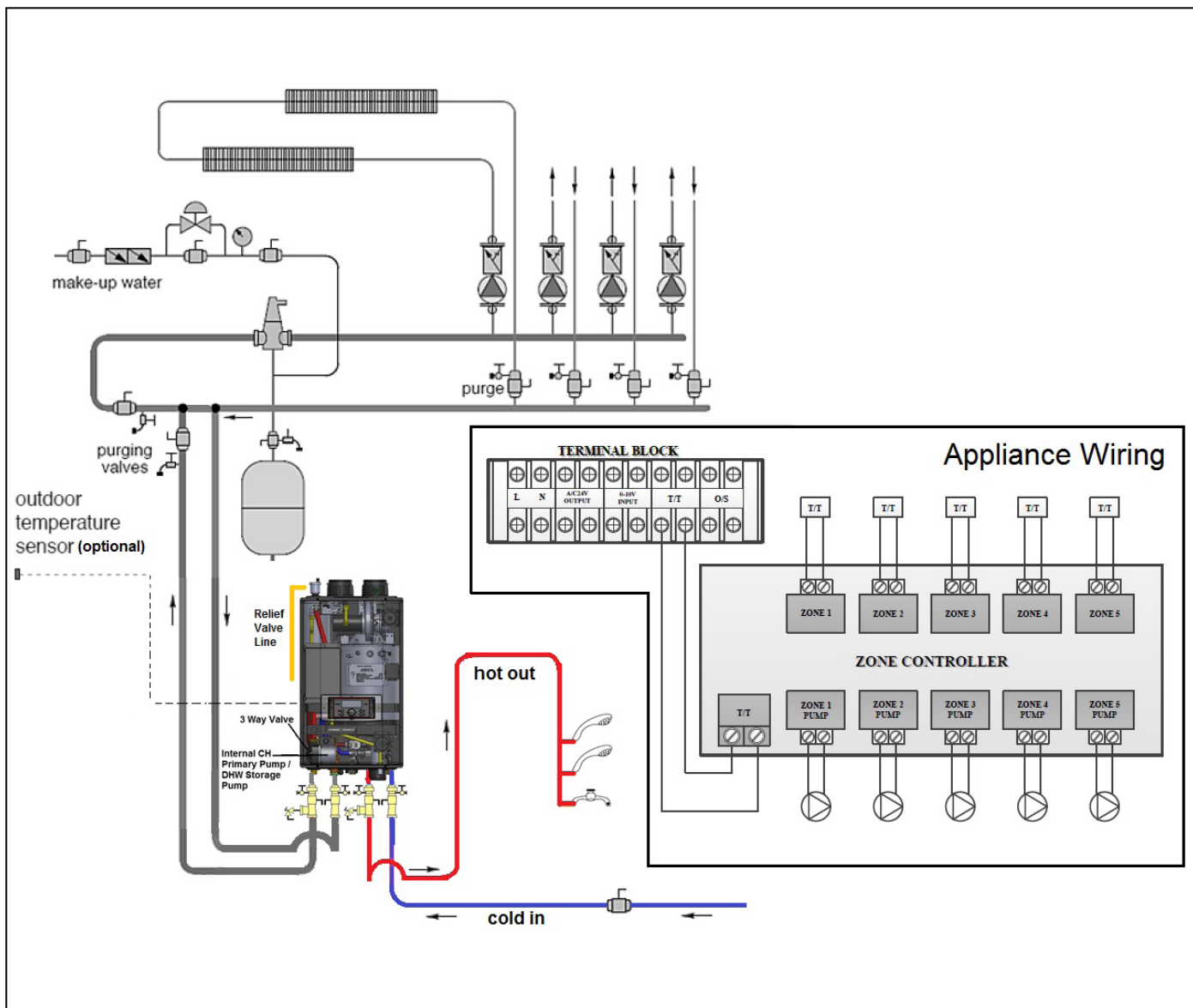

**Figure 12 - Primary / Secondary Piping with Pumps - DHW Priority and Outdoor Reset**

**NOTES:**

1. This drawing is meant to show system piping concept only. Installer is responsible for all equipment and detailing required by local codes.
2. All closely spaced tees shall be within 4 pipe diameters center to center spacing.
3. A minimum of 6 pipe diameters of straight pipe shall be installed upstream and downstream of all closely spaced tees.
4. The minimum pipe size of DHW piping should be  $\frac{3}{4}$ " diameter and CH piping should be 1" in diameter.
5. Circulators are shown with isolation flanges. The alternative is standard flanges with full port ball valves. Purge valves can be used with circulator flanges as an alternative.
6. Piping shown is Primary/Secondary. System flow (secondary loop) must be greater than the boiler's primary loop flow.
7. Install a minimum of 12 diameters of straight pipe upstream of all circulators.
8. **VERY IMPORTANT** – Minimum flow rates outlined in this manual must be maintained through the heat exchanger to minimize short cycling.
9. Each heating zone of a pump-based system has its own circulator with turns on when a zone thermostat calls for heat.
10. **Unit is equipped with built-in primary pump for the heating loop.** This pump is sized to insure proper flow rate through the boiler heat exchanger and related piping. On long pipe runs, it is recommended to keep the pump at maximum speed (setting 3). DO NOT lower it from the factory default.
11. **NOTE:** DO NOT INSTALL a flow check or a pump with flow check on the return line of the primary loop going to the boiler. This will isolate the boiler from the expansion tank, causing pressure to build up in the unit and the Pressure Relief Valve to discharge.

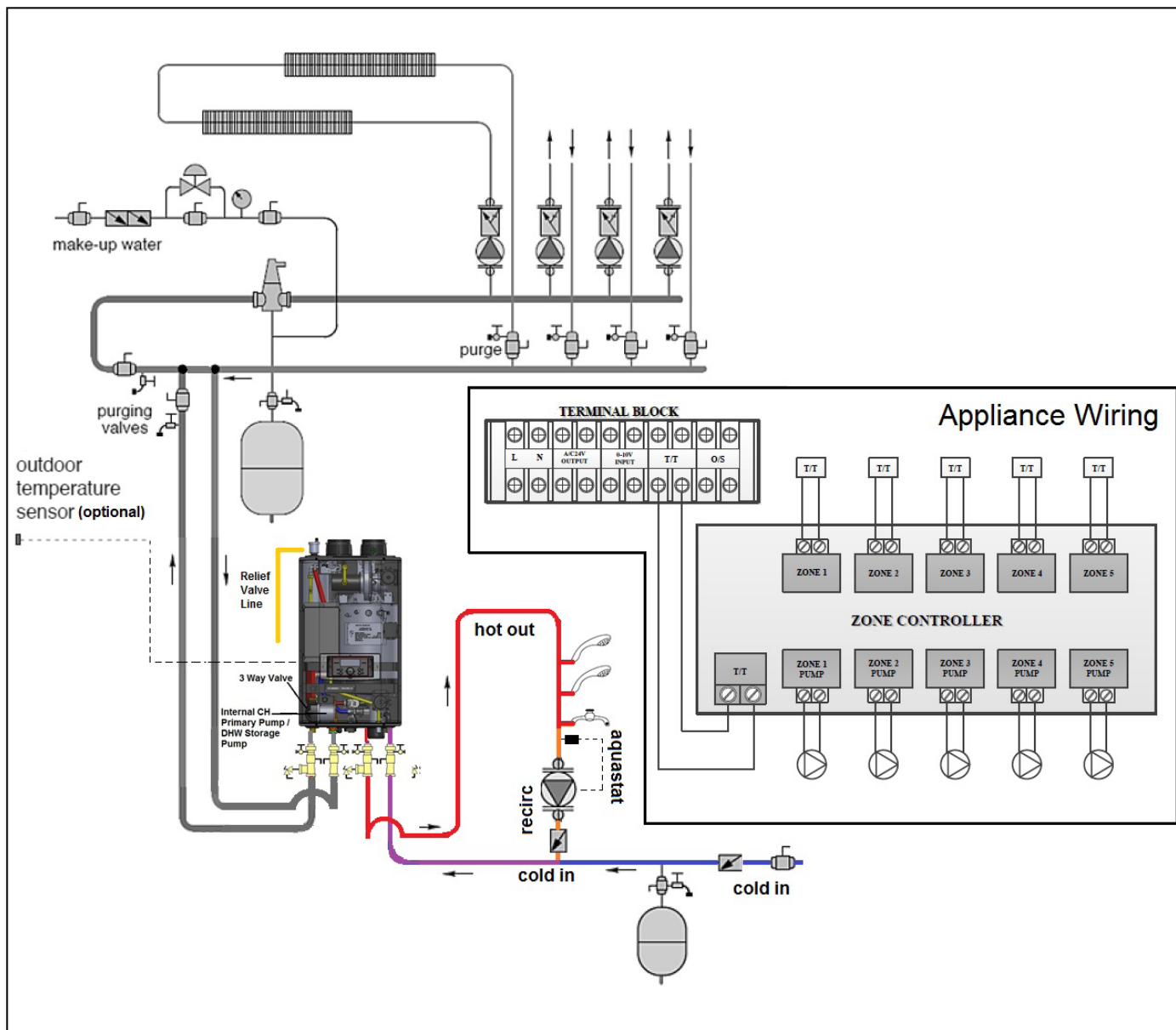
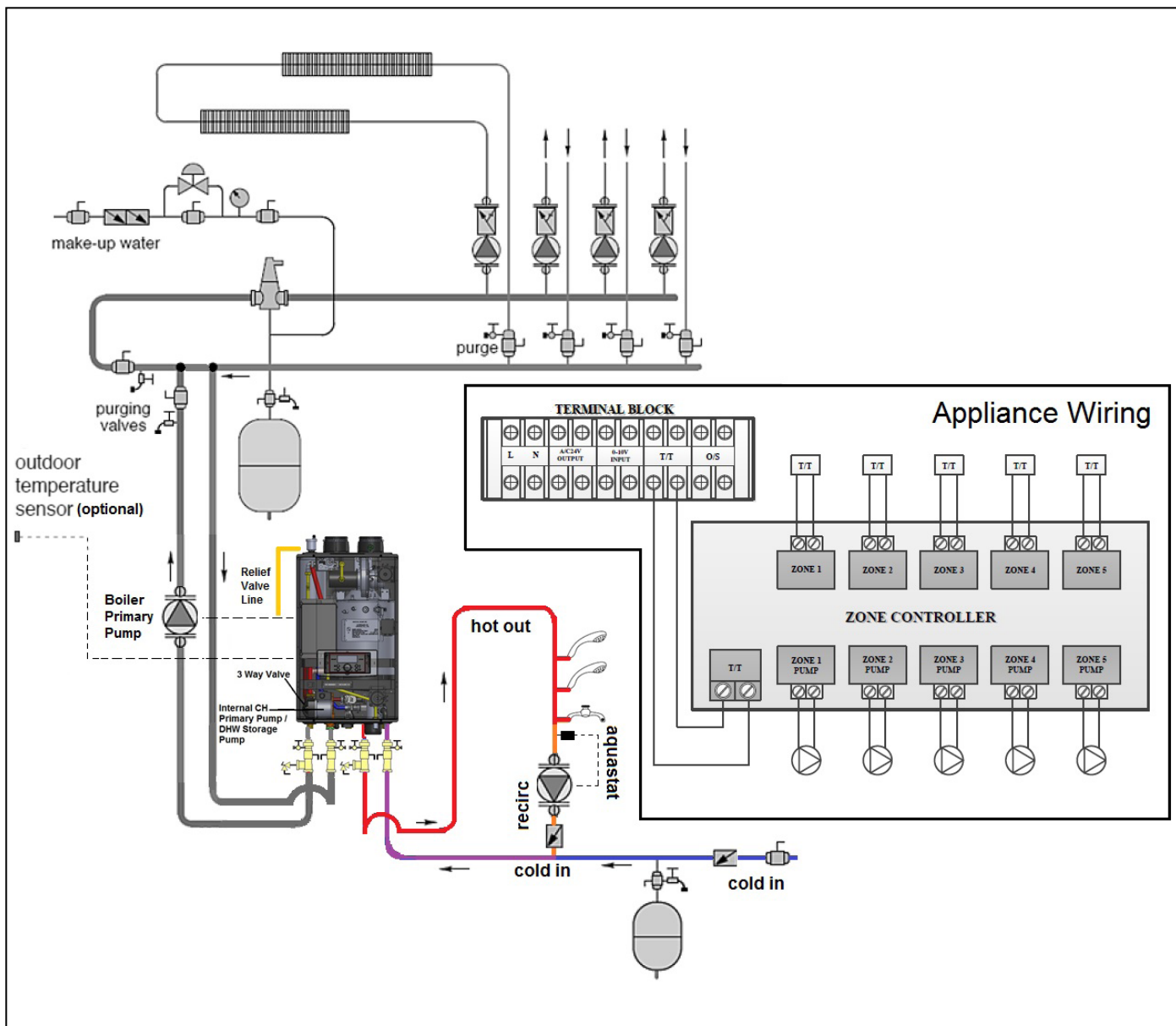

**Figure 13 - Primary / Secondary Piping with Pumps - DHW Priority and Outdoor Reset with Recirculation**

**NOTES:**

1. This drawing is meant to show system piping concept only. Installer is responsible for all equipment and detailing required by local codes.
2. All closely spaced tees shall be within 4 pipe diameters center to center spacing.
3. A minimum of 6 pipe diameters of straight pipe shall be installed upstream and downstream of all closely spaced tees.
4. The minimum pipe size of DHW piping should be  $\frac{3}{4}$ " diameter and CH piping should be 1" in diameter.
5. Circulators are shown with isolation flanges. The alternative is standard flanges with full port ball valves. Purge valves can be used with circulator flanges as an alternative.
6. Piping shown is Primary/Secondary. System flow (secondary loop) must be greater than the boiler's primary loop flow.
7. Install a minimum of 12 diameters of straight pipe upstream of all circulators.
8. **VERY IMPORTANT** – Minimum flow rates outlined in this manual must be maintained through the heat exchanger to minimize short cycling.
9. Each heating zone of a pump-based system has its own circulator with turns on when a zone thermostat calls for heat.
10. **Unit is equipped with built-in primary pump for the heating loop.** This pump is sized to insure proper flow rate through the boiler heat exchanger and related piping. On long pipe runs, it is recommended to keep the pump at maximum speed (setting 3). DO NOT lower it from the factory default.
11. **NOTE: DO NOT INSTALL** a flow check or a pump with flow check on the return line of the primary loop going to the boiler. This will isolate the boiler from the expansion tank, causing pressure to build up in the unit and the Pressure Relief Valve to discharge.





**Figure 14 - Primary / Secondary Piping with Pumps - DHW Priority and Outdoor Reset with Recirculation and Boiler Primary Pump**

**NOTES:**

1. This drawing is meant to show system piping concept only. Installer is responsible for all equipment and detailing required by local codes.
2. All closely spaced tees shall be within 4 pipe diameters center to center spacing.
3. A minimum of 6 pipe diameters of straight pipe shall be installed upstream and downstream of all closely spaced tees.
4. The minimum pipe size of DHW piping should be  $\frac{3}{4}$ " diameter and CH piping should be 1" in diameter.
5. Circulators are shown with isolation flanges. The alternative is standard flanges with full port ball valves. Purge valves can be used with circulator flanges as an alternative.
6. Piping shown is Primary/Secondary. System flow (secondary loop) must be greater than the boiler's primary loop flow.
7. Install a minimum of 12 diameters of straight pipe upstream of all circulators.
8. **VERY IMPORTANT** – Minimum flow rates outlined in this manual must be maintained through the heat exchanger to minimize short cycling.
9. Each heating zone of a pump-based system has its own circulator with turns on when a zone thermostat calls for heat.
10. **Unit is equipped with built-in primary pump for the heating loop.** This pump is sized to insure proper flow rate through the boiler heat exchanger and related piping. On long pipe runs, it is recommended to keep the pump at maximum speed (setting 3). DO NOT lower it from the factory default.
11. **NOTE:** DO NOT INSTALL a flow check or a pump with flow check on the return line of the primary loop going to the boiler. This will isolate the boiler from the expansion tank, causing pressure to build up in the unit and the Pressure Relief Valve to discharge.
12. To achieve 199,000 BTU/hr, install a Boiler Primary Pump. NOTE: RECOMMENDED PUMP: TACO 0013 or equivalent.

**Boiler Primary Pump Instructions:**

- a. Install pump. Connect the pump to boiler terminal (2A max).
- b. Go into installer menu and change 19:cb from 70 (default) to 100.

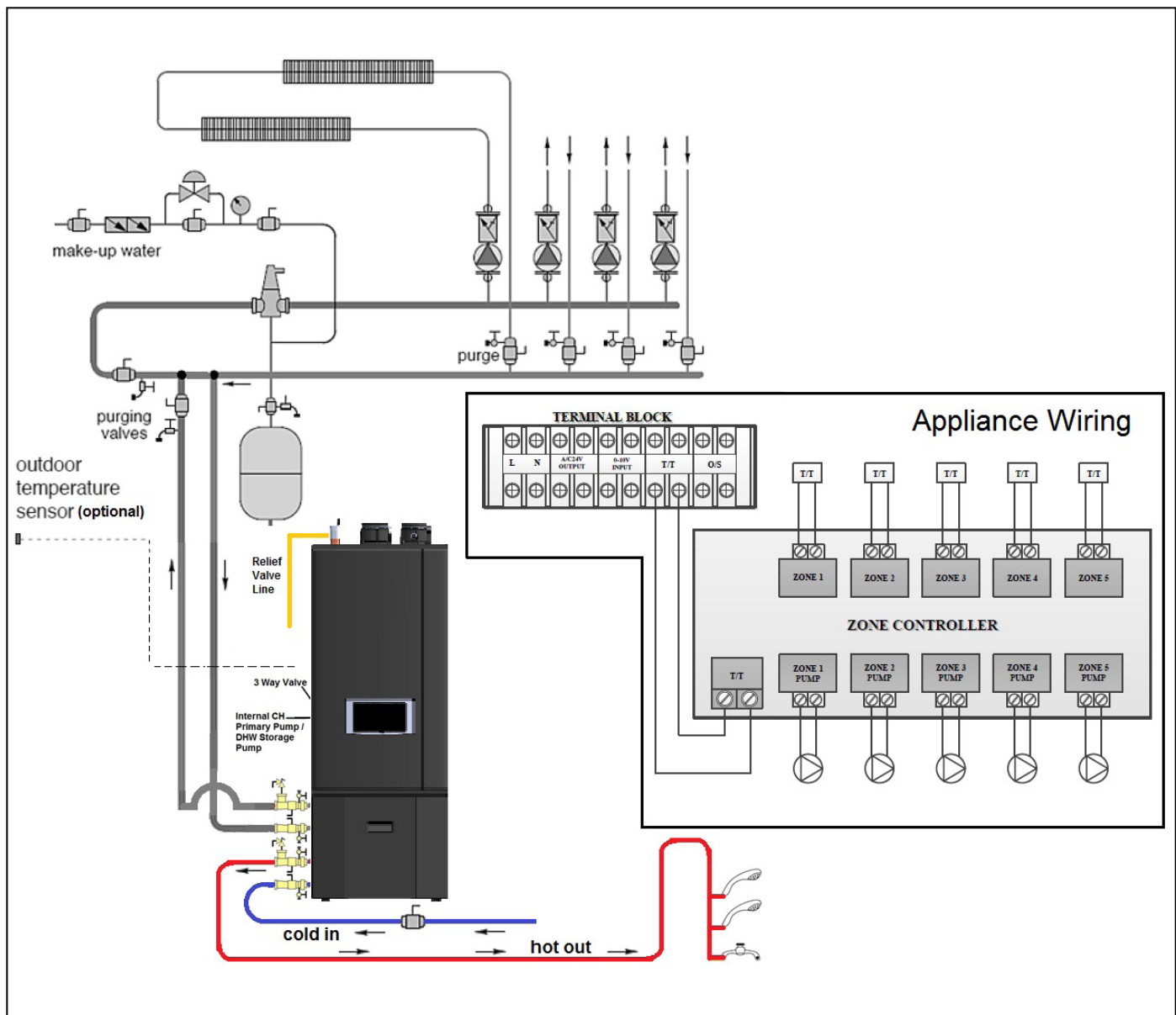
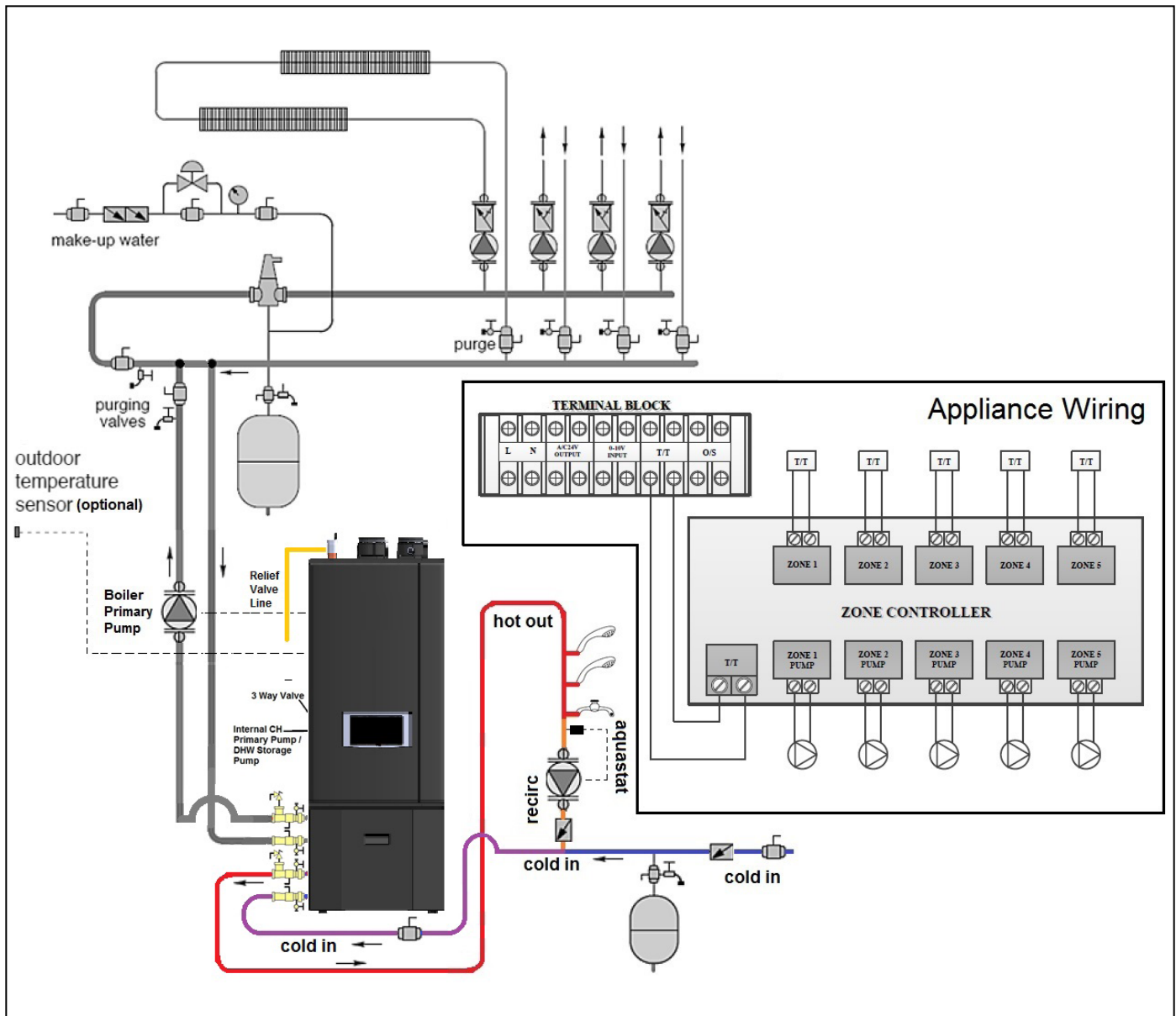

Figure 15 - Primary / Secondary Piping with Pumps - DHW Priority and Outdoor Reset - Floor Model

**NOTES:**

1. This drawing is meant to show system piping concept only. Installer is responsible for all equipment and detailing required by local codes.
2. All closely spaced tees shall be within 4 pipe diameters center to center spacing.
3. A minimum of 6 pipe diameters of straight pipe shall be installed upstream and downstream of all closely spaced tees.
4. The minimum pipe size of DHW piping should be 3/4" diameter and CH piping should be 1" in diameter.
5. Circulators are shown with isolation flanges. The alternative is standard flanges with full port ball valves. Purge valves can be used with circulator flanges as an alternative.
6. Piping shown is Primary/Secondary. System flow (secondary loop) must be greater than the boiler's primary loop flow.
7. Install a minimum of 12 diameters of straight pipe upstream of all circulators.
8. **VERY IMPORTANT** – Minimum flow rates outlined in this manual must be maintained through the heat exchanger to minimize short cycling.
9. Each heating zone of a pump-based system has its own circulator with turns on when a zone thermostat calls for heat.
10. **Unit is equipped with built-in primary pump for the heating loop.** This pump is sized to insure proper flow rate through the boiler heat exchanger and related piping. On long pipe runs, it is recommended to keep the pump at maximum speed (setting 3). DO NOT lower it from the factory default.
11. **NOTE:** DO NOT INSTALL a flow check or a pump with flow check on the return line of the primary loop going to the boiler. This will isolate the boiler from the expansion tank, causing pressure to build up in the unit and the Pressure Relief Valve to discharge.



**Figure 16 - Primary / Secondary Piping with Pumps - DHW Priority and Outdoor Reset with Recirculation and Boiler Primary Pump - Floor Model**

**NOTES:**

1. This drawing is meant to show system piping concept only. Installer is responsible for all equipment and detailing required by local codes.
2. All closely spaced tees shall be within 4 pipe diameters center to center spacing.
3. A minimum of 6 pipe diameters of straight pipe shall be installed upstream and downstream of all closely spaced tees.
4. The minimum pipe size of DHW piping should be ¾" diameter and CH piping should be 1" in diameter.
5. Circulators are shown with isolation flanges. The alternative is standard flanges with full port ball valves. Purge valves can be used with circulator flanges as an alternative.
6. Piping shown is Primary/Secondary. System flow (secondary loop) must be greater than the boiler's primary loop flow.
7. Install a minimum of 12 diameters of straight pipe upstream of all circulators.
8. **VERY IMPORTANT** – Minimum flow rates outlined in this manual must be maintained through the heat exchanger to minimize short cycling.
9. Each heating zone of a pump-based system has its own circulator with turns on when a zone thermostat calls for heat.
10. **Unit is equipped with built-in primary pump for the heating loop.** This pump is sized to insure proper flow rate through the boiler heat exchanger and related piping. On long pipe runs, it is recommended to keep the pump at maximum speed (setting 3). DO NOT lower it from the factory default.
11. **NOTE:** DO NOT INSTALL a flow check or a pump with flow check on the return line of the primary loop going to the boiler. This will isolate the boiler from the expansion tank, causing pressure to build up in the unit and the Pressure Relief Valve to discharge.
12. To achieve 199,000 BTU/hr, install a Boiler Primary Pump. NOTE: RECOMMENDED PUMP: TACO 0013 or equivalent.

**Boiler Primary Pump Instructions:**

- a. Install pump. Connect the pump to boiler terminal (2A max).
- b. Go into installer menu and change 19:cb from 70 (default) to 100.

**F. CH and DHW Pressure Relief Valves**

An external pressure relief valve must be installed on this boiler for both the CH and DHW loops. When installing, observe the following guidelines. Pressure relief valves must be installed as close to the boiler as possible. No other valves should be placed between the pressure relief valve and the boiler. Failure to comply with these guidelines can result in substantial property damage, personal injury, or death.

This boiler has a high-temperature shut-off switch built in as a standard safety feature. Therefore, a “pressure only” relief valve is required. DO NOT operate this boiler before the supplied pressure relief valve is installed with sufficient relieving capacity in accordance with the ASME rating plate on the boiler.

**CH Loop**

This boiler is provided with a CH pressure relief valve that complies with the ANSI/ASME Boiler and Pressure Vessel Code, Section IV (Heating Boilers). The included 30 psi CH Pressure Relief Valve must be installed on the CH supply line to ensure a compliant installation and safe operation. HTP has supplied a 3/4" X 1" bushing to aid installation of the CH Pressure Relief Valve. The valve is meant to be field installed. DO NOT install a CH pipe line relief valve with a pressure rating greater than 30 psi. This is the maximum allowable CH relief valve setting for this boiler.

**DHW Loop**

This boiler must be provided with a DHW pressure relief valve that complies with local codes, but not less than valves certified as meeting the requirements of Relief Valves for Hot Water Supply Systems, ANSI Z21.22 CSA4.4 by a nationally recognized lab that maintains periodic inspection of production listed equipment. A DHW pressure relief valve is not included with the boiler, and is to be field supplied and installed. DO NOT install a DHW relief valve with a pressure rating greater than 150 psi. This is the maximum allowable DHW relief valve setting for this boiler.

After installing the relief valves and filling and pressurizing the system, test the operation of the valves by lifting the levers. Make sure the valves discharge freely. If a valve fails to operate correctly, replace it with a new relief valve. Ensure that the maximum BTU/H rating on the pressure relief valve is equal to or greater than the maximum input BTU/H rating of the combination boiler.

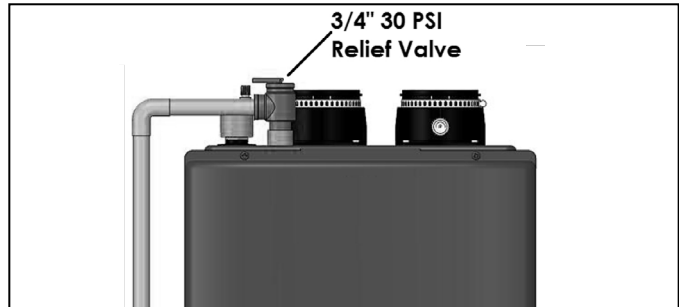

Figure 17 - Pressure Relief Valve

**WARNING**

To avoid water damage or scalding due to relief valve operation:

- Discharge line must be connected to relief valve outlet and run to a safe place of disposal. Terminate the discharge line in a manner that will prevent possibility of severe burns or property damage should the relief valve discharge.
- Discharge line must be as short as possible and the same size as the valve discharge connection throughout its entire length.
- Discharge line must pitch downward from the valve and terminate at least 6" above the floor drain, making discharge clearly visible.
- Discharge line shall terminate plain, not threaded, with a material serviceable for temperatures of 375°F or greater.
- Do not pipe discharge to any location where freezing could occur.
- No shutoff valve may be installed between the relief valve and boiler or in the discharge line. Do not plug or place any obstruction in the discharge line.
- Test the operation of the relief valve after filling and pressurizing the system by lifting the lever. Make sure the valve discharges freely. If the valve fails to operate correctly, replace it with a new relief valve.
- Test relief valve at least once annually to ensure the waterway is clear. If valve does not operate, turn the boiler "off" **and call a plumber immediately.**
- Take care whenever operating relief valve to avoid scalding injury or property damage.
- For boilers installed with only a pressure relief valve, the separate storage vessel must have a temperature and pressure relief valve installed. This relief valve shall comply with Relief Valves for Hot Water Supply Systems, ANSI Z21.22 CSA4.4.

**FAILURE TO COMPLY WITH THE ABOVE GUIDELINES COULD RESULT IN FAILURE OF RELIEF VALVE OPERATION, RESULTING IN POSSIBILITY OF SUBSTANTIAL PROPERTY DAMAGE, SEVERE PERSONAL INJURY, OR DEATH.**

Do not thread a cap or plug into the relief valve or relief valve line under any circumstances! Explosion and property damage, serious injury, or death may result.

**WARNING**

**RE-INSPECTION OF RELIEF VALVES: Valves should be inspected AT LEAST ONCE EVERY THREE YEARS, and replaced if necessary,** by a qualified service technician to ensure that the product has not been affected by corrosive water conditions and to ensure that the valve and discharge line have not been altered or tampered with illegally. Certain naturally occurring conditions may corrode the valve and its components over time, rendering the valve inoperative. Such conditions can only be detected if the valve and its components are physically removed and inspected. **Do not attempt to conduct an inspection on your own.** Contact your plumbing contractor for a re-inspection to assure continued safety.

**FAILURE TO RE-INSPECT THE RELIEF VALVE AS DIRECTED COULD RESULT IN UNSAFE TEMPERATURE AND/OR PRESSURE BUILD-UP WHICH CAN RESULT IN PROPERTY DAMAGE, SERIOUS PERSONAL INJURY, OR DEATH.**

**Part 5 - Venting**

**⚠ DANGER**

The boiler must be vented as detailed in this section. Ensure exhaust vent and intake piping complies with these instructions regarding vent system. Inspect finished exhaust vent and intake piping thoroughly to ensure all joints are well secured, airtight, and comply with all applicable code requirements, as well as the instructions provided in this manual. Failure to properly install the vent system will result in severe personal injury or death.

**A. General**

**⚠ DANGER**

This appliance is certified as a "Category IV" appliance and requires a special venting system. The vent system will operate with a positive pressure in the pipe. Exhaust gases must be piped directly outdoors using the vent materials and rules outlined in these instructions. Do not connect vent connectors serving appliances vented by natural draft into any portion of mechanical draft systems operating under positive pressure. Follow the venting instructions carefully. Failure to do so will result in substantial property damage, severe personal injury, or death.

Exhaust and intake are to be piped separately. This appliance cannot share a common exhaust or intake with multiple appliances. Failure to follow these instructions will result in substantial property damage, severe personal injury, or death.

1. Installation should be made in accordance with the regulations of the Authority Having Jurisdiction, local code authorities, and utility companies which pertain to this type of water heating equipment.
2. Install the venting system in accordance with these instructions and with the National Fuel Gas Code, ANSI Z223.1/NFPA 54, CAN/CGA B149, and / or applicable provisions of local building codes.
3. This appliance must be vented with materials, components, and systems listed and approved for Category IV appliances.

**NOTE:** To avoid contamination often contained in indoor air, it is best to pipe all intake combustion air directly to the outdoors.

**NOTE:** Care must be taken to prevent condensate freezing in the exhaust vent pipe system. See local, state, provincial, and national codes for best practices to prevent condensate freezing in the exhaust vent pipe system.

**⚠ WARNING**

Improper seating of vent pipe gaskets can cause eventual gasket failure and exhaust gas leakage. Ensure the exhaust vent pipe is properly beveled and seated before insertion into the flue adapter. Failure to do so could result in property damage, severe personal injury, or death.

**⚠ DANGER**

Due to the extreme flammability of most glues, cements, solvents, and primers used to join plastic exhaust vent and intake pipes, explosive solvent vapors must be cleared from all vent piping before start-up. Avoid using excess cement or primer, as this may pool in the vent pipes. Vent assemblies should be allowed to cure for a period of at least 8 hours before powering a connected appliance. Failure to follow these instructions will result in substantial property damage, severe personal injury, or death. It is the installers' responsibility to understand the hazards associated with explosive solvents and take the necessary precautions to avoid these risks.

**⚠ WARNING**

**Breathing Hazard - Carbon Monoxide Gas**

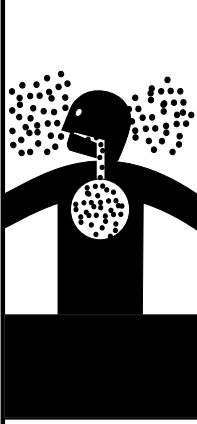

- Do not operate heater if flood damaged.
- Install vent system in accordance with local codes and manufacturers installation instructions.
- Do not obstruct heater air intake or exhaust. Support all vent piping per manufacturers installation instructions.
- Do not place chemical vapor emitting products near unit.
- According to NFPA 720, carbon monoxide detectors should be installed outside each sleeping area.
- Never operate the heater unless it is vented to the outdoors.
- Analyze the entire vent system to make sure that condensate will not become trapped in a section of vent pipe and therefore reduce the open cross sectional area of the vent.

**Breathing carbon monoxide can cause brain damage or death. Always read and understand instruction manual.**

LP-304

**⚠ WARNING**

- DO NOT insulate the first three (3) linear feet of the exhaust vent run.
- CPVC, Polypropylene, or Stainless Steel pipe material MUST be used if the first three (3) linear feet of the exhaust vent run is insulated or passes through an enclosed space greater than 6" in length, such as a wall. **NOTE:** Only Stainless Steel pipe material may be insulated.
- If CPVC is used to meet these requirements, the balance may be installed with approved PVC pipe.
- If Polypropylene or Stainless Steel is used to meet these requirements, the balance of the vent run must be installed with the same material.
- Failure to comply with this warning could result in property damage, severe personal injury, or death.

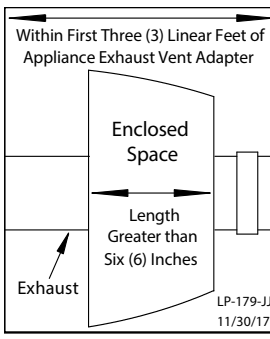

LP-179-JJ  
11/30/17

Exhaust vent adaptors are not designed as load-bearing devices, and must not be used to support exhaust vent piping. All vent pipes must be properly connected, supported, and the exhaust vent must be pitched a minimum of 1/4" per foot back to the boiler to allow drainage of condensate. Failure to properly support vent piping and follow the information in this statement could result in product damage, severe personal injury, or death.

It is required to insert the provided exhaust and intake screens into the vent terminations to prevent blockage caused by debris or birds. Failure to keep terminations clear could result in property damage, severe personal injury, or death.

## B. Approved Materials for Exhaust Vent and Intake Pipe

Item	Material	Standards for Installation In:	
		United States	Canada
<b>Pipe and Fittings Approved for Intake ONLY</b>	ABS*	ANSI/ASTM D2661	NOT PERMITTED
<b>Pipe Approved for Intake OR Exhaust Vent</b>	PVC Schedule 40/80	ANSI/ASTM D1785	PVC, CPVC, and PP Venting Must be ULC-S636 Certified. IPEX is an approved manufacturer in Canada.
	PVC-DWV Schedule 40/80	ANSI/ASTM D2665	
	CPVC Schedule 40/80	ANSI/ASTM F441	
	Polypropylene	UL-1738 or ULC-S636	
	Stainless Steel AL29-4C	Certified for Category IV and Direct Vent Appliance Venting	
<b>Pipe Fittings</b>	PVC Schedule 40	ANSI/ASTM D2466 or D2665	PVC, CPVC, and PP Venting Must be ULC-S636 Certified. IPEX is an approved manufacturer in Canada.
	PVC Schedule 80	ANSI/ASTM D2467 or D2665	
	CPVC Schedule 40	ANSI/ASTM F438	
	CPVC Schedule 80	ANSI/ASTM F439	
<b>Pipe Cement</b>	ABS*	ANSI/ASTM D2235	NOT PERMITTED
	PVC	ANSI/ASTM D2564	IPEX System 636 Cements and Primers
	CPVC	ANSI/ASTM F493	
<b>Pipe Primer</b>	PVC / CPVC	ASTM F656	

**DANGER**

- The exhaust and intake components installed with this appliance must be used for near appliance piping BEFORE transitioning to the approved materials listed above. DO NOT REMOVE these installed components. Doing so WILL VOID appliance warranty.
- PVC / CPVC pipe and fittings of the same diameter are considered interchangeable.
- The use of cellular core PVC (ASTM F891), cellular core CPVC, or Radel® (polyphenolsulfone) in non-metallic venting systems is prohibited.
- Covering non-metallic vent pipe and fittings with thermal insulation is prohibited.
- DO NOT connect PVC/CPVC to Polypropylene without an approved vent connector.
- Any transition to Polypropylene MUST be done in the vertical within five (5) feet of the appliance.
- When installing AL29-4C vent piping, install a PVC-to-stainless adapter at the appliance vent connection, and at the termination when using a PVC termination kit. DO NOT mix AL29-4C piping from different manufacturers unless using adapters specifically designed for the purpose by the manufacturer.
- A double wall vent or insulated material may be used when using stainless steel vent material in a freezing climate.
- \*ABS may be used for air intake applications ONLY. ABS is NOT PERMITTED for use in Canada.
- Contact the venting material manufacturer if there is any question about the applicability of the proposed venting material.

Failure to follow these directions will result in substantial property damage, severe personal injury, or death.

**Table 13 - Approved Materials for Exhaust Vent and Intake Pipe**

 <b style="font-size: 24px; margin-left: 10px;">WARNING</b>
DO NOT mix components from different venting systems. The vent system could fail, causing leakage of flue products into the living space. Use only the approved pipe and fitting materials, and primer and cement specifically designed for the material used, as listed in the above table. Failure to do so could result in property damage, serious injury, or death.
<b style="font-size: 24px; margin-left: 10px;">CAUTION</b>
High heat sources (generating heat 100°F / 37°C or greater, such as appliance flue pipes, space heaters, etc.) may damage plastic components of the boiler as well as plastic vent pipe materials. Such damages ARE NOT covered by warranty. It is recommended to keep a minimum clearance of 8" from high heat sources. Observe heat source manufacturer instructions, as well as local, state, provincial, and national codes, laws, regulations, and ordinances when installing this boiler and related components near high heat sources.

**NOTE:** The use of double-wall vent or insulated material for the combustion air intake pipe is recommended in cold climates to prevent the condensation of airborne moisture in the incoming combustion air.

 <b style="font-size: 24px; margin-left: 10px;">DANGER</b>
You must not use "B" vent in an exhaust application. "B" vent is for intake applications ONLY. Using "B" vent in an exhaust application will result in serious injury or death.

### C. Additional Requirements for Installation in Canada

- Installations must be made with a vent pipe system certified to ULC-S636. IPEX is an approved vent manufacturer in Canada supplying vent material listed to ULC-S636. Additionally, you may use AL29-4C stainless steel venting to comply with Canadian requirements.
- The first three (3) feet of vent pipe from the boiler flue outlet must be readily accessible for visual inspection.
- The components of the certified vent system must not be interchanged with other vent systems or unlisted pipe / fittings.

**D. Exhaust Vent and Intake Pipe Location**

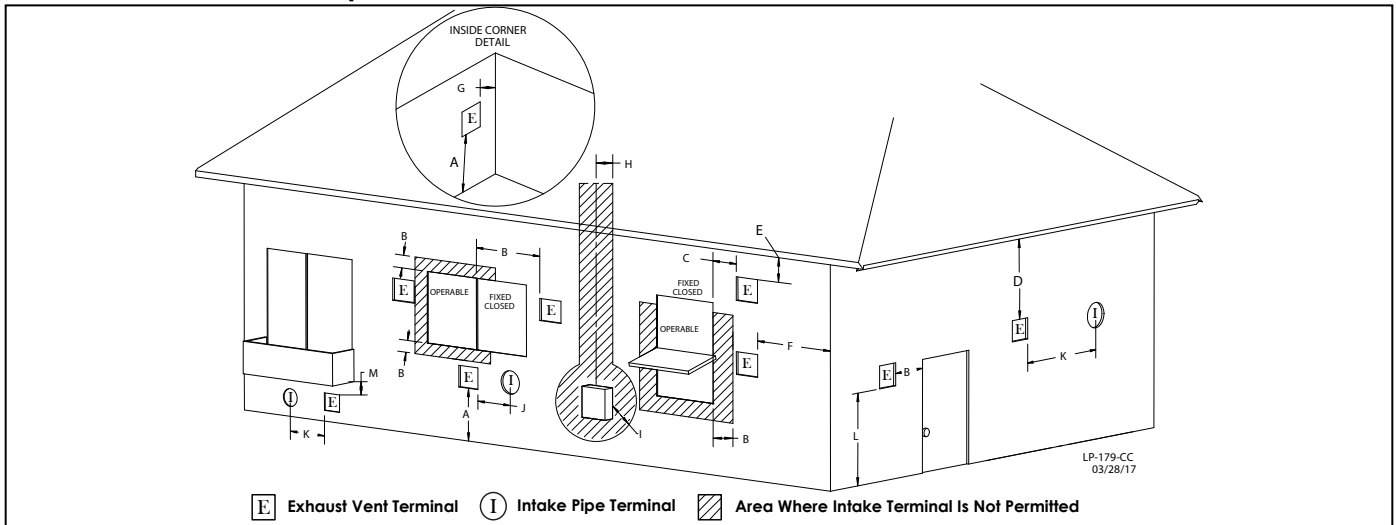

**Figure 18 - Exit Terminals for Direct Vent Systems - ANSI Z223.1 / NFPA 54 for US and CAN/CSA B149.1 for Canada**

DESCRIPTION		US	CANADA
<b>A</b>	Clearance above grade, veranda, porch, deck, or balcony	1 foot (30 cm)	
<b>B</b>	Clearance to window or door that may be opened	Direct Vent	1 foot
		Power Vent	4 ft below or to side of opening; 1 ft above opening
<b>C</b>	Clearance to permanently closed window	*	
<b>D</b>	Vertical clearance to ventilated soffit located above the terminal within a horizontal distance 2 feet (61 cm) from the center line of the terminal	*	
<b>E</b>	Clearance to unventilated soffit	*	
<b>F</b>	Clearance to outside corner	*	
<b>G</b>	Clearance to inside corner	*	
<b>H</b>	Clearance to each side of center line extended above meter / regulator assembly	*	
<b>I</b>	Clearance to service regulator vent outlet	*	Above a regulator within 3 feet (91 cm) horizontally of the vertical center line of the regulator vent outlet to a maximum vertical distance of 15 ft (4.5 m)
<b>J</b>	Clearance to nonmechanical air supply inlet to building or the combustion air inlet to any other appliance	Direct Vent	1 foot
		Power Vent	4 ft below or to side of opening; 1 ft above opening
<b>K</b>	Clearance to mechanical air supply inlet	3 feet above if within 10 feet horizontally	6 feet (1.83 m)
<b>L</b>	Clearance above paved sidewalk or paved driveway located on public property	Direct Vent	*
		Power Vent	7 feet (2.13 m)
<b>M</b>	Clearance under veranda, porch deck, or balcony	1 foot (30 cm)	

**Table 14 - Vent Termination Clearances - \*NOTE: For clearances not specified in ANSI Z223.1 / NFPA 54 for US and CAN/CSA B149.1 for Canada, please use clearances in accordance with local installation codes and the requirements of the gas supplier.**

**⚠ WARNING**

The building owner is responsible for keeping the exhaust and intake terminations free of snow, ice, or other potential blockages, as well as scheduling routing maintenance. Failure to keep the vent piping terminations clear and properly maintain the boiler could result in property damage, severe personal injury, or death.

For each floor containing bedroom(s), a carbon monoxide detector and alarm shall be placed in the living area outside the bedrooms, as well as in the room that houses the boiler. Detectors and alarms shall comply with NFPA 720 (latest edition). Failure to comply with these requirements could result in product damage, severe personal injury, or death.

**E. Exhaust Vent and Intake Pipe Sizing**

1. The exhaust vent and intake pipe size is 3".
2. The total equivalent length of 2" exhaust vent and intake pipe **should not exceed fifty (50) feet**; 3" exhaust vent and intake pipe **should not exceed one hundred (100) feet**.

- a. The equivalent length of elbows, tees, and other fittings are listed in the Friction Loss Table.
- b. For example: If the exhaust vent has two 90° elbows and 10 feet of PVC pipe we will calculate:  
 Exhaust Vent Equivalent Length = (2x5) + 10 = 20 feet.  
 Further, if the intake pipe has two 90° elbows, one 45° elbow, and 10 feet of PVC pipe, the following calculation applies:  
 Intake Pipe Equivalent Length = (2x5) + 3 + 10 = 23 feet.  
 Finally, if a concentric kit is used we find:  
 Total Equivalent Length = 20 + 23 + 3 = 46 feet.  
 The total equivalent length is 46 feet, well below the maximum of 150 feet.
- c. Effort should be made to keep a minimum difference in equivalent length between the exhaust vent and intake pipe.

Friction Loss Equivalent in Piping and Fittings		
Fittings or Piping	Equivalent Feet	
	2"	3"
90 Degree Elbow*	5'	5'
45 Degree Elbow	3'	3'
Coupling	0'	0'
Air Inlet Tee	0'	0'
Straight Pipe	1'	1'
Concentric Kit	3'	3'
V500 2" Kit	1'	N/A
V1000 3" Kit	N/A	1'
V2000 4" Kit	N/A	1'

Table 15 - \*Friction loss for long radius elbow is 1 foot less. NOTE: Consult Polypropylene venting instructions for friction loss and pressure drop equivalents.

3. The minimum total equivalent length is 14 feet.  
**NOTE:** The intake pipe and exhaust vent lengths do not have to be of equal length. There is no balancing requirement between intake and exhaust.

2" Combined Vent Length		3" Combined Vent Length	
Minimum	Maximum	Minimum	Maximum
14' (4.2M)	50' (50M)	14' (4.2M)	100' (30M)
<b>Maximum # of 90° Elbows (2" and 3" Vent Diameters)</b>			
6			

Table 16 - Approved Vent Lengths

CAUTION

Do not exceed the maximum lengths for vent pipes. Excessive length could result in boiler shutdown and property damage.

Failure to provide a minimum total vent length of 14 equivalent feet could result in property damage and improper product operation.

**F. Tightening Boiler Collar to Exhaust Vent and Intake Pipe**

This boiler uses 2" or 3" diameter pipe for exhaust vent and intake pipe. In order to use 2" pipe, it is required to reduce pipe size in a vertical length of pipe with a 3" x 2" reducing coupling (not included). Follow the steps below to install 3" vent pipe into the boiler vent collar. See Figure 19 for additional details.

**NOTE:** Clean and dry the boiler connection. DO NOT use primer or cement on the boiler connection.

1. Push the length of pipe into the connection until it touches the bottom of the fitting.
2. Tighten the clamps using a screwdriver.
3. Ensure the pipe is secure before continuing installation.
4. For 2" installations, install the reducing coupling in a vertical section of pipe. At least a 6" length of 3" pipe **MUST BE INSTALLED** before reducing to 2". See Figure 20.

**NOTE:** A reducing coupling **MUST BE USED** when transitioning from 3" to 2" vent pipe. DO NOT use reducing bushings.

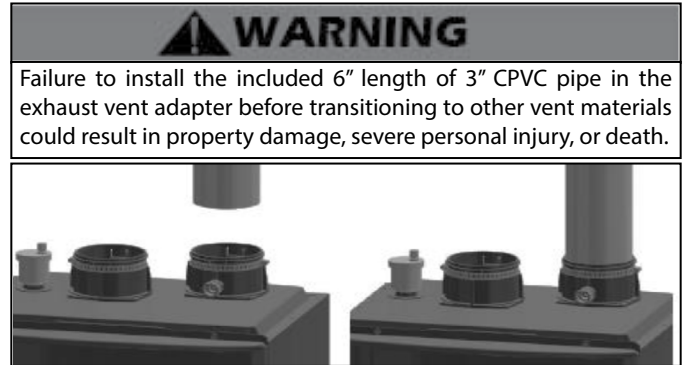

Figure 19 - Correct Installation into the Boiler Collar

**NOTE: REDUCING VENT SIZE: TRANSITIONING FROM 3" TO 2" VENT PIPE MUST ALWAYS TAKE PLACE IN A VERTICAL POSITION TO PREVENT CONDENSATE BLOCKAGE**

Figure 20 - Transitioning from 3" to 2" Vent Pipe

**G. Exhaust Vent and Intake Pipe Installation**

WARNING

All joints of positive pressure vent systems must be sealed completely to prevent leakage of flue products into the living space. Failure to do so could result in property damage, serious injury, or death.

1. Use only solid PVC, CPVC, or stainless steel pipe or a Polypropylene vent system approved for use with Category IV appliances. ABS pipe material may be used on air intake piping **only**.
2. Remove all burrs and debris from joints and fittings.
3. When using PVC or CPVC pipe, all joints must be properly cleaned, primed, and cemented. Use only cement and primer approved for use with the pipe material. Cement must conform to ASTM D2564 for PVC and ASTM F493 for CPVC pipe. **NOTE: DO NOT CEMENT POLYPROPYLENE PIPE.**
4. Ensure the vent is located where it will not be exposed to prevailing winds.
5. In all roof venting applications, exhaust discharge must point away from the pitch of the roof.
6. To prevent water leakage, install adequate roof flashing where the pipe enters the roof.
7. Do not locate vent over public walkways, driveways, or parking lots. Condensate could drip and freeze, resulting in a slip hazard or damage to vehicles and machinery.
8. Due to potential moisture build-up, sidewall venting may not be the preferred venting option. To save time and cost, carefully consider venting installation and location.
9. Horizontal lengths of exhaust vent must slope back towards the boiler not less than ¼" per foot to allow condensate to drain from



the vent pipe.

10. The exhaust vent must terminate where vapors cannot make accidental contact with people or pets, or damage shrubs or plants.

11. In vacant chimney applications, install and seal a rain cap over existing chimney openings.

12. All piping must be fully supported. Use pipe hangers at a minimum of 4 foot intervals to prevent sagging of the pipe where condensate may form.

13. Do not use the boiler to support any piping.

14. Maximum Snow Level Determination: These installation instructions reference snow levels in establishing a minimum height for the installation of exhaust vent or air intake terminations. Snow levels shall be determined as follows:

- a. The installation location may, by ordinance, designate how snow levels are calculated in that location; or
- b. In the absence of specific ordinances, snow levels shall be calculated from the average monthly maximum depth of snow accumulation as indicated by the National Weather Service's 10 year statistics for the installation location/geographical area.

In addition:

- Total length of vent piping shall not exceed the limits specified in this manual.
- The vent piping for this direct vented appliance is approved for zero clearance to combustible construction.
- The flue products coming from the exhaust vent will create a large plume when the boiler is in operation. Avoid venting in areas that will affect neighboring buildings or be considered objectionable.
- DO NOT locate exhaust vent or intake pipe in a parking area where machinery may damage the pipe.
- DO NOT vent near soffit vents, crawl space vents, or other areas where condensate or vapor could create a nuisance or hazard or cause property damage.
- DO NOT vent where condensate vapor could cause damage or could be detrimental to the operation of regulators, relief valve, or other equipment.

**In the Commonwealth of Massachusetts and as Required by State and Local Codes:**

- The vented gas fueled appliance shall not be installed so its combustion, ventilation, or dilution air is obtained from a bedroom or bathroom.
- Signage: Whenever any through-the-wall (horizontal or sidewall) vent is installed less than seven feet above the finished grade, a metal or plastic identification plate shall be permanently mounted to the exterior of the building at a minimum height of eight feet above grade directly in line with the exhaust vent terminal. The sign shall read, in print no less than 0.5 inches in size, "GAS VENT DIRECTLY BELOW. KEEP CLEAR OF ALL OBSTRUCTIONS".
- Marking of Exhaust Vent and Intake Pipe: Piping used for ventilation, make-up, or combustion air intake shall be labeled as follows:
  - a. Throughout the entire developed length:
    - i. Labels must be placed every ten feet for exposed/visible piping; or
    - ii. Labels must be placed every three feet for concealed piping.
  - b. At all changes of direction;
  - c. On each side of a penetration through a partition, wall or ceiling; and
  - d. The labels shall be black lettering that:
    - i. Indicates that the piping is used for ventilation, make-up, or combustion air intake, and
    - ii. The letters shall be sized equal to a minimum of the pipe diameter. However, for piping with a diameter exceeding two inches, said lettering does not need to be larger than

two inches.

This table lists optional exhaust/intake terminations available from HTP:

Description	Stock Code
2" PVC Concentric Termination Kit	KGAVT0501CVT
3" PVC Concentric Termination Kit	KGAVT0601CVT
2" Stainless Steel Termination Kit	V500
3" Stainless Steel Termination Kit	V1000
3" Polypro Vent Kit	8400P-001

**Table 17 - Optional Vent Kits**

**H. Applications**

**1. Direct Vent Installation of Exhaust and Intake**

If installing a direct vent option, combustion air must be drawn from the outdoors directly into the boiler intake, and exhaust must terminate outside. There are three basic direct vent options detailed in this manual: 1. Side Wall Venting, 2. Roof Venting, and 3. Unbalanced Venting.

Be sure to locate the boiler such that the exhaust vent and intake pipe can be routed through the building and properly terminated. Different vent terminals can be used to simplify and eliminate multiple penetrations in the building structure (see Optional Equipment in Venting Section). The exhaust vent and intake pipe lengths, routing and termination methods must all comply with the methods and limits given in the Venting section of this manual.

When installing a combustion air intake from outdoors, care must be taken to utilize uncontaminated combustion air. **NOTE:** To prevent combustion air contamination, see Table 6.

 <b>WARNING</b>
All vent pipes must be glued, properly supported, and the exhaust pitched a minimum of 1/4" per foot back to the appliance to allow drainage of condensate. When placing support brackets on vent piping, the first bracket must be within 1 foot of the appliance and the balance of 4 foot intervals on the vent pipe. Venting must be readily accessible for visual inspection from the first three feet from the appliance.
Take extra precaution to adequately support the weight of vent pipes terminating through the roof. Failure to properly support roof terminated piping could result in property damage, serious injury, or death.

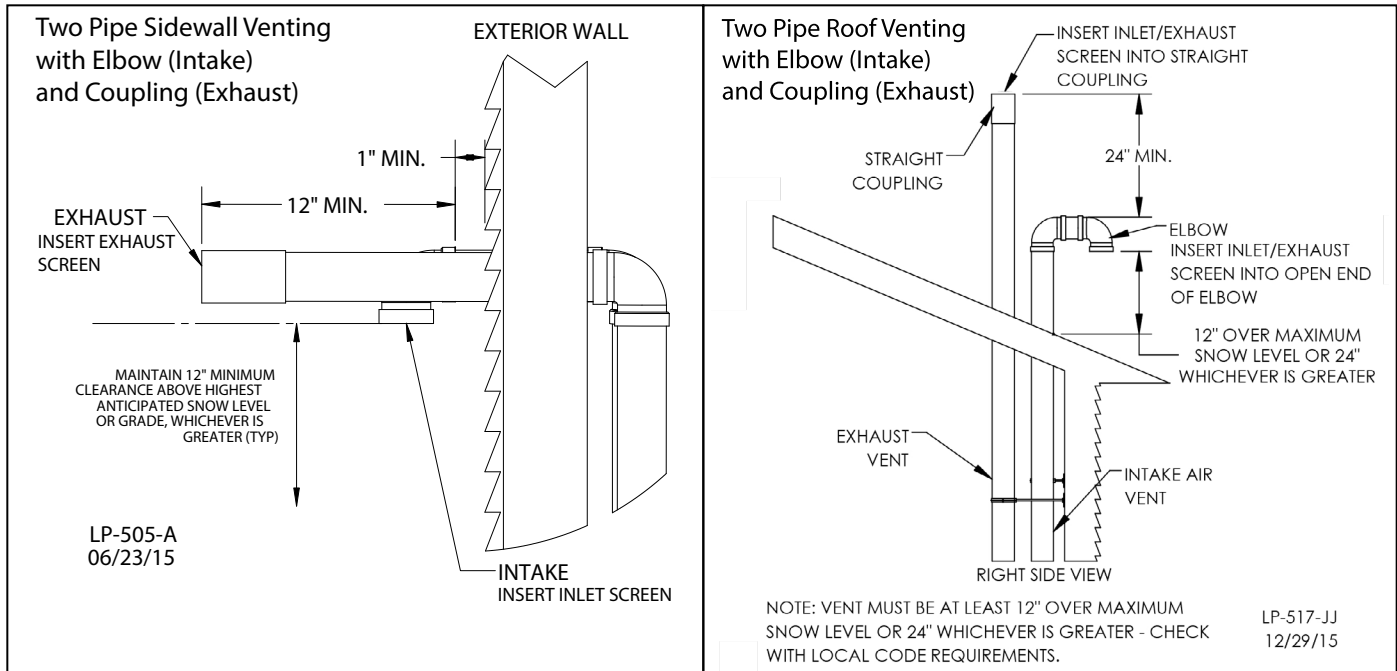

Figure 21 - Direct Vent, Roof and Sidewall Vent Terminations

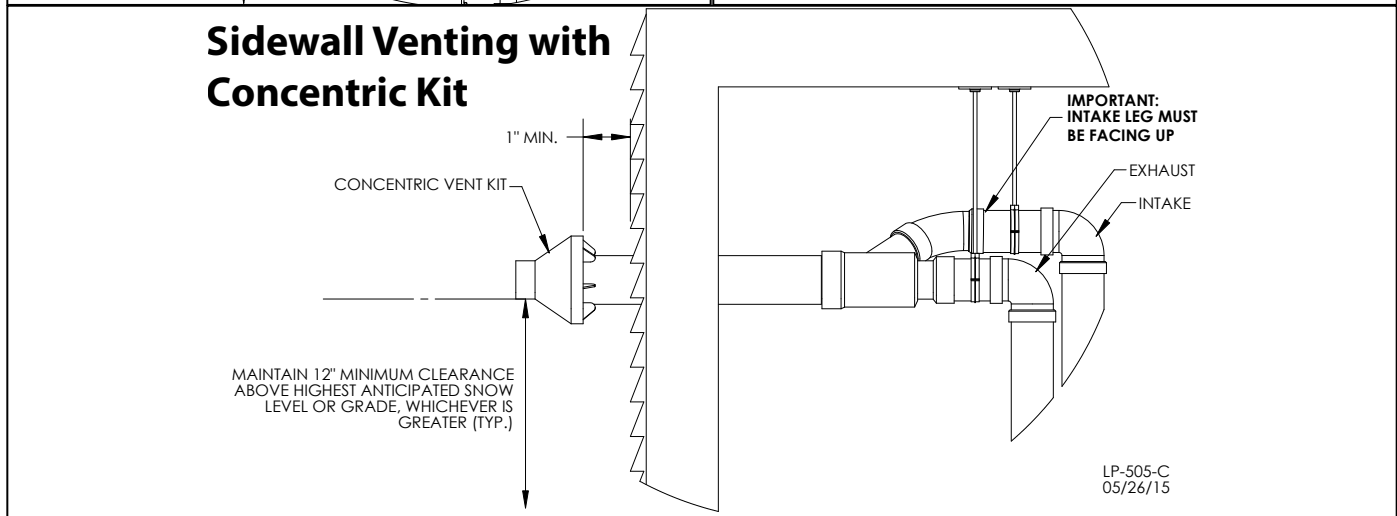
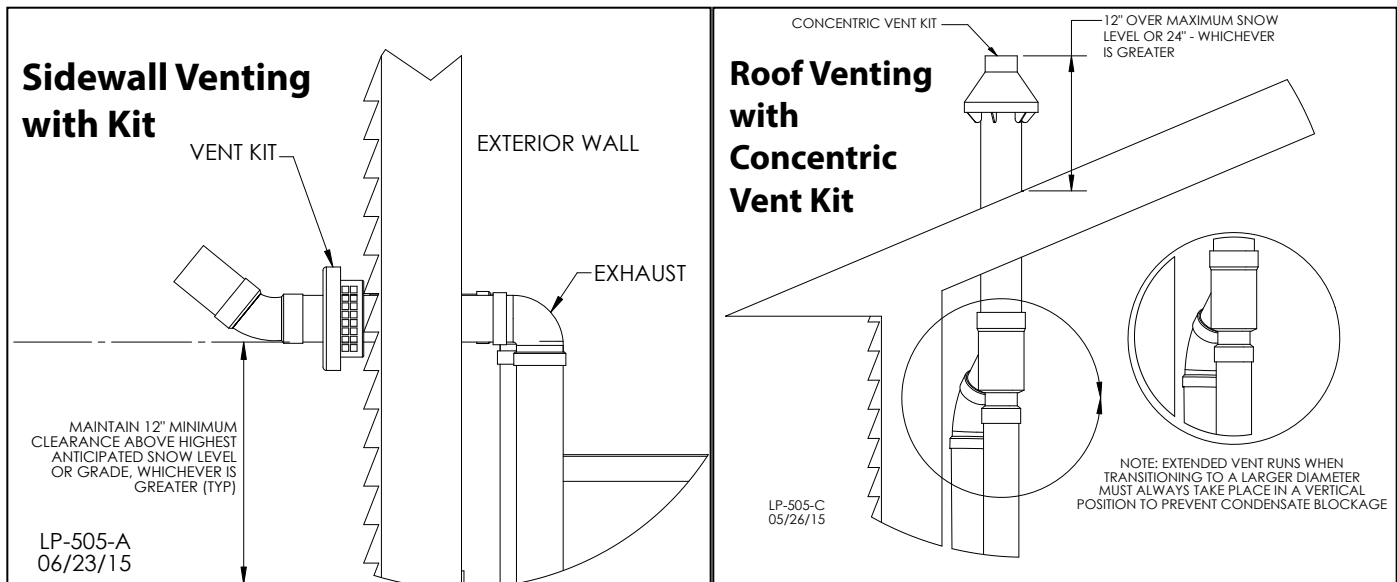

Figure 22 - Direct Vent, Vent Terminations with Optional Kits (NOT INCLUDED WITH THE BOILER)

**NOTE:** These drawings are meant to demonstrate system venting only. The installer is responsible for all equipment and detailing required by local codes.

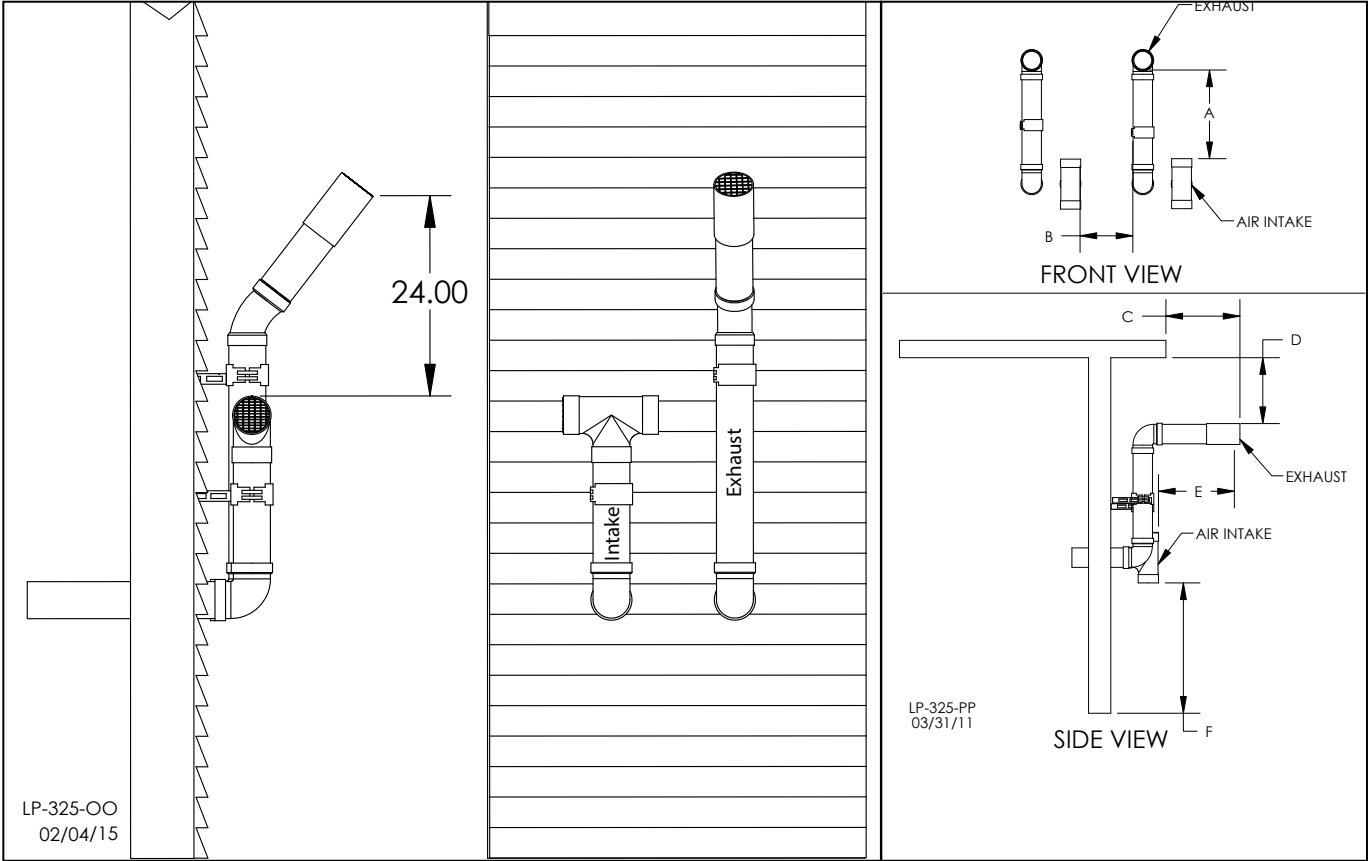

Figure 23 - Horizontal (Snorkel) Venting

**NOTES:**

- A. For every 1" of overhang, the exhaust vent must be located 1" vertical below overhang (overhang means top of building structure and not two adjacent walls [corner of building]).
- B. Typical installations require 12" minimum separation between bottom of exhaust outlet and top of air intake.
- C. Maintain 12" minimum clearance above highest anticipated snow level or grade (whichever is greater).
- D. Minimum 12" between vents when installing multiple vents.
- E. 12" minimum beyond air intake.

**Screen Installation**

After connecting the intake air and exhaust vent pipes, it is required to install the included screens into the exhaust vent and intake pipe terminations to prevent damages to the unit due to blockages. See Figure 24 for installation detail.

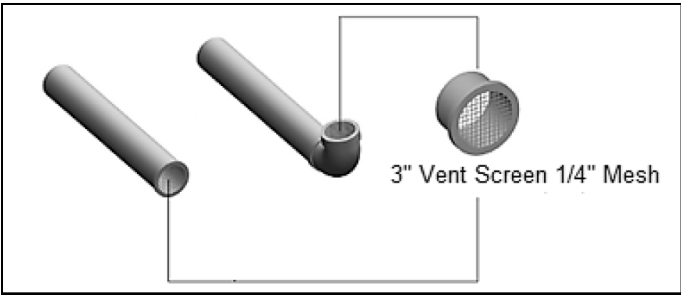

Figure 24 - Screen Installation - NOTE: Vent termination elbow is meant to be installed open end facing the ground. Orientation in Figure 24 is meant to demonstrate proper Vent Screen installation ONLY.

## 2. Venting Through an Existing System

This appliance may be vented through an existing unused vent system. The inner diameter of the existing vent system is utilized for the combustion air source. Two methods have been approved for such venting: Concentric Venting Through an Existing System and Venting as a Chase.

**⚠ DANGER**

Do not install the appliance into a common existing vent with any other appliance. This will cause flue gas spillage or appliance malfunction, resulting in substantial property damage, serious personal injury, or death.

**CAUTION**

Contractors must check state and local codes before installing through an existing vent opening. State and local codes always take precedence over manufacturer's instructions. Failure to check state and local codes before installing through an existing opening could result in property damage and add significantly to installation costs.

If an existing venting system is converted for use with this appliance, the installer must ensure that the existing venting system is clean and free from particulate contamination that could damage the appliance. Failure to do so could result in property damage and appliance failure. Such failure IS NOT covered under warranty.

### Concentric Venting Through an Existing System

**NOTE:** The following instructions refer only to venting through an existing vent system, and not to venting with HTP's optional concentric vent kits. Refer to Concentric Vent Kit installation manual (LP-166) for

further information on venting with the optional concentric vent kits.

Concentric venting through an existing system must run vertically through the roof. See Table 18 for proper minimum vent sizing. Use only the approved venting materials specified in Table 13 for piping the system. All instructions listed in this Venting section apply. See Figures 25-1 and 25-2 for venting demonstrations.

Vent / Air Inlet Size	Minimum Existing Vent / Chase Size
2"	4"
3"	5"
4"	7"

**Table 18 - Minimum Existing Vent / Chase Sizing**

**⚠ DANGER**

The upper and lower vent terminations as well as all joints in the venting system must be properly sealed to ensure that all combustion air is drawn properly and exhaust does not leak from the system. Failure to properly seal the venting system will result in property damage, serious personal injury, or death.

### Chase Venting Through an Existing System

When venting as a chase, follow all instructions included in this Venting section, including those in the previous Concentric Venting Through an Existing System section. See Figure 25-3 for chase venting demonstration.

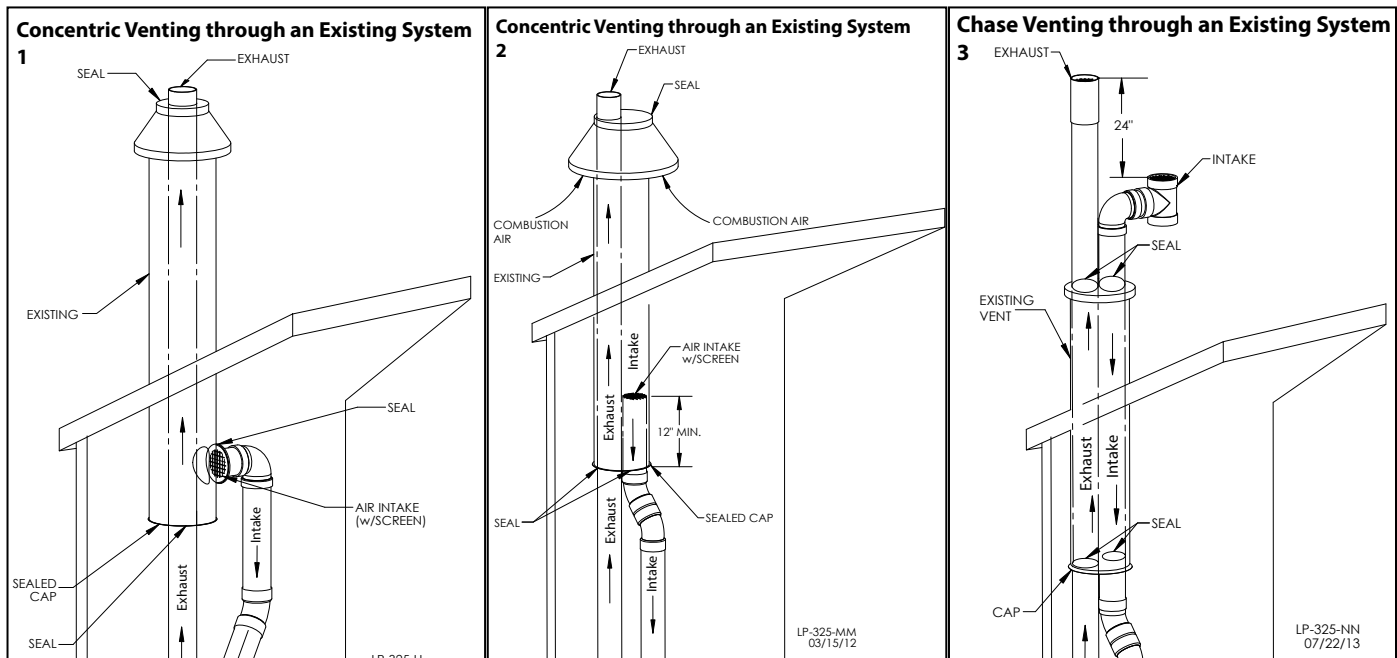

**Figure 25 - 1, 2 - Concentric Venting Through an Existing System, 3, Chase Venting Through an Existing System**

**NOTE:** These drawings are meant to demonstrate system venting only. The installer is responsible for all equipment and detailing required by local codes.

**3. Power Venting, Indoor Combustion Air in Confined or Unconfined Space**

This appliance requires fresh, uncontaminated air for safe operation and must be installed in a mechanical room where there is adequate combustion and ventilating air. **NOTE: To prevent combustion air contamination, see Table 6.**

Combustion air from the indoor space can be used if the space has adequate area or when air is provided through a duct or louver to supply sufficient combustion air based on the appliance input.

**Never obstruct the supply of combustion air to the appliance.** If the appliance is installed in areas where indoor air is contaminated (see Figure 26) it is imperative that the appliance be installed as direct vent so that all combustion air is taken directly from the outdoors into the appliance intake connection.

**Unconfined space** is space with volume greater than 50 cubic feet per 1,000 Btu/hour (4.8 cubic meters per kW) of the total input rating of all fuel-burning appliances installed in that space. Rooms connected directly to this space, through openings not furnished

with doors, are considered part of the space.

**Confined space** is space with volume less than 50 cubic feet per 1,000 Btu/hour (4.8 cubic meters per kW) of the total input rating of all fuel-burning appliances installed in that space. Rooms connected directly to this space, through openings not furnished with doors, are considered part of the space.

When drawing combustion air from inside a conventionally constructed building to a confined space, such space should be provided with two permanent openings: one located 6" (15 cm) below the space ceiling, the other 6" (15cm) above the space floor. Each opening should have a free area of one square inch per 1,000 Btu/hr (22cm<sup>2</sup>/kW) of the total input of all appliances in the space, but not less than 100 square inches (645cm<sup>2</sup>).

If the confined space is within a building of tight construction, air for combustion must be obtained from the outdoors as outlined in the Venting section of this manual. See Figure 27.

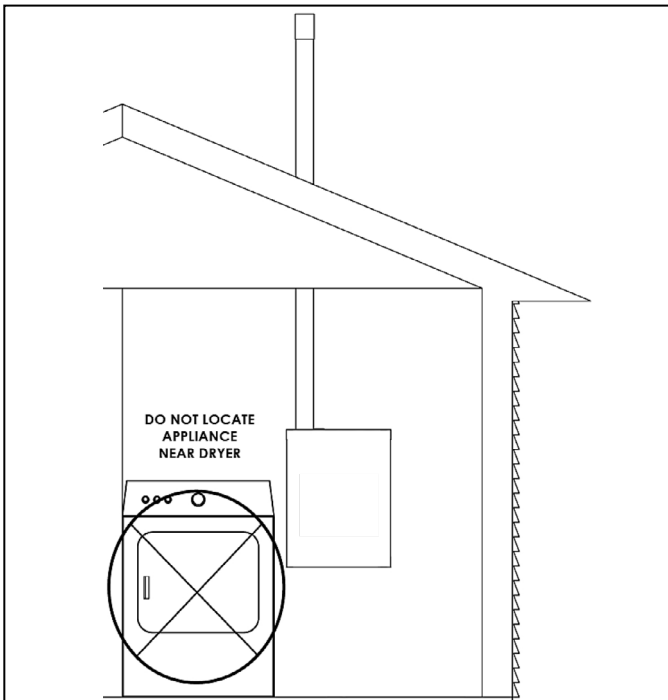

**Figure 26 - Do Not Place Boiler Near Dryer**

**⚠ WARNING**

**Breathing Hazard - Carbon Monoxide Gas**

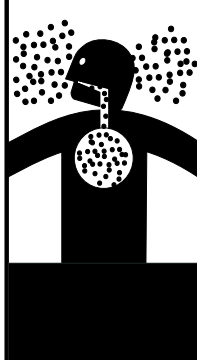

- Do not operate heater if flood damaged.
- Install vent system in accordance with local codes and manufacturers installation instructions.
- Do not obstruct heater air intake or exhaust. Support all vent piping per manufacturers installation instructions.
- Do not place chemical vapor emitting products near unit.
- According to NFPA 720, carbon monoxide detectors should be installed outside each sleeping area.
- Never operate the heater unless it is vented to the outdoors.
- Analyze the entire vent system to make sure that condensate will not become trapped in a section of vent pipe and therefore reduce the open cross sectional area of the vent.

Breathing carbon monoxide can cause brain damage or death.  
 Always read and understand instruction manual.

LP-304

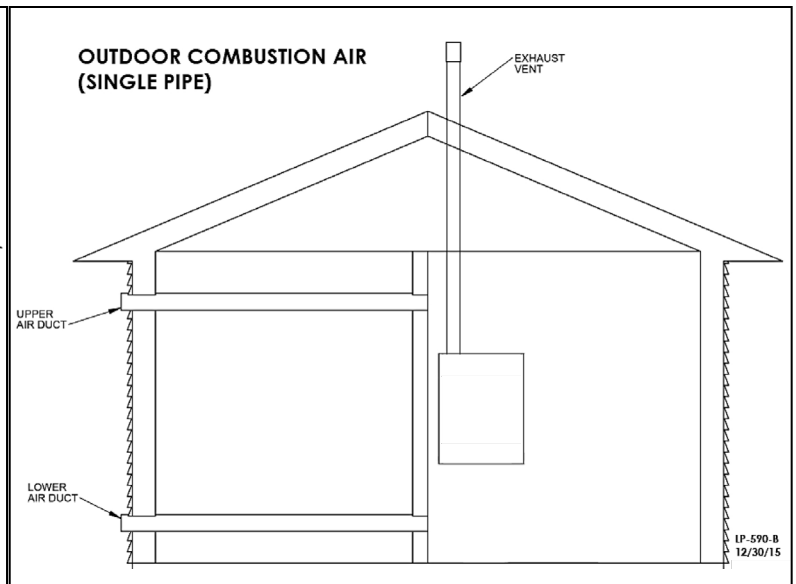
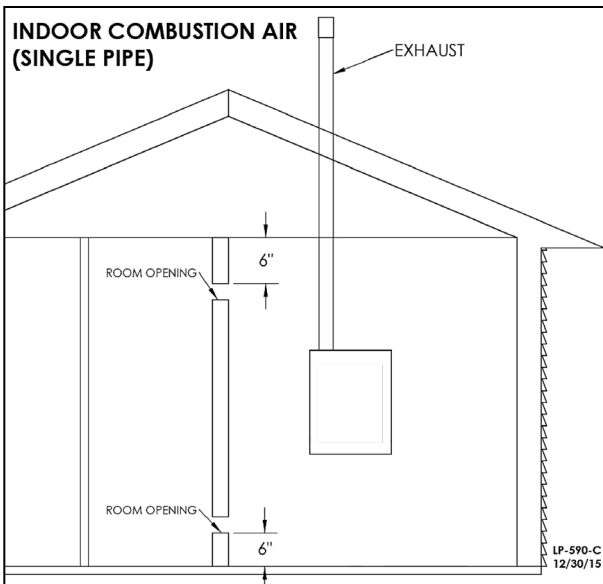

**Figure 27 - Power Venting, Indoor and Outdoor Combustion Air - Single Pipe**

**NOTE:** These drawings are meant to demonstrate system venting only. The installer is responsible for all equipment and detailing required by local codes.

## Part 6 - Installing the Condensate Drain

### CAUTION

This condensing high efficiency boiler has a condensate removal system. Condensate is water vapor derived from combustion products, similar to that produced by an automobile when it is initially started. It is very important that the condensate line is sloped down away from the boiler and to a suitable drain.

The condensate line must remain unobstructed. If allowed to freeze in the line or obstructed in any other manner, condensate can exit from the boiler tee, resulting in potential water damage to property. When installing a condensate pump, select one approved for use with condensing boilers and furnaces. The condensate pump should have an overflow switch to prevent property damage from spillage. Condensate from the boiler will be slightly acidic (pH from 3.2 to 4.5). Check with your local gas company to determine if combustion condensate disposal is permitted in your area. Install a neutralizing filter if required by local codes.

### NOTES:

1. Due to its efficient design, the boiler produces condensate (water) as a normal by-product. This condensate is acidic, with a pH level between 3 and 4. This condensate must be drained away from the boiler and disposed in accordance with all local regulations.
2. Condensate line must be pitched at least  $\frac{1}{4}$ " per foot to properly drain. If this cannot be done, or a very long length of condensate hose is used, increase the condensate line to a minimum of 1" ID and place a tee in the line after the condensate neutralizer to properly reduce vacuum lock in the drain line.
3. Use corrosion-resistant materials to drain condensate. Use the included flexible plastic hose or  $\frac{1}{2}$ " PVC and CPVC drain pipe complying with ASTM D1785, F441, or D2665 may be used. Cement must comply with ASTM D2564 for PVC pipe or F493 for CPVC pipe. For Canadian applications, use CSA or ULC certified PVC or CPVC pipe, fittings, and cement.
4. A frozen condensate line could result in a blocked vent condition. It is very important to protect the condensate line from freezing temperatures or any type of blockage. In installations that may encounter sustained freezing conditions, the use of heat tape is recommended to avoid freezing of the condensate line. It is also recommended to bush up the condensate line size to 1" and terminate condensate discharge as close to the unit as possible. Longer condensate runs are more prone to freezing. Damages due to frozen or blocked condensate lines ARE NOT covered by warranty.

5. Support of the condensate line may be necessary to avoid blockage of the condensate flow.

6. Local building codes may require an in-line neutralizer (1) to be installed (not included) to treat the condensate. If required by local authorities, a condensate filter of lime crystals, marble, or phosphate chips will neutralize slightly acidic condensate (p/n 7450P-212 available from HTP). Follow all the installation instructions included with the neutralizer. If a neutralizer is installed, periodic replacement of the limestone (or neutralizing agent) will be required. The rate of depletion of the limestone varies with usage of the boiler. During the first year of boiler operation, check the neutralizer every few months for depletion.

7. Route the drain line to a nearby floor drain (2), laundry tub (3), or condensate pump (4). If the boiler condensate outlet is lower than the drain, you must use a condensate removal pump (kit p/n 554200 available from HTP).

**NOTE:** If a nearby laundry tub is used as a disposal for waste water from the washing machine, draining the condensate into this tub allows the soapy water discharge to neutralize the acidic condensate.

8. An error will appear on the boiler display if condensate line is blocked. The boiler will not operate with a blocked condensate line. It is extremely important to have this condition repaired by a qualified service technician.

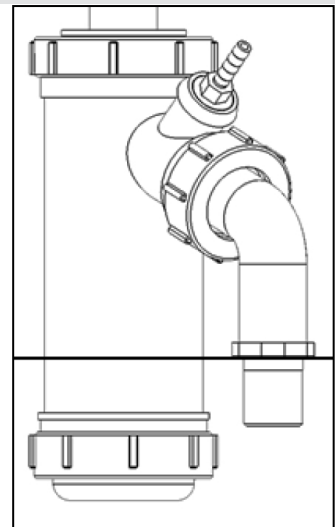

Figure 28 - Internal Condensate Trap

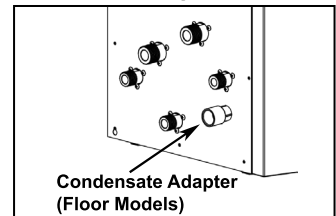

Figure 30 - Condensate Adapter (Floor Models)

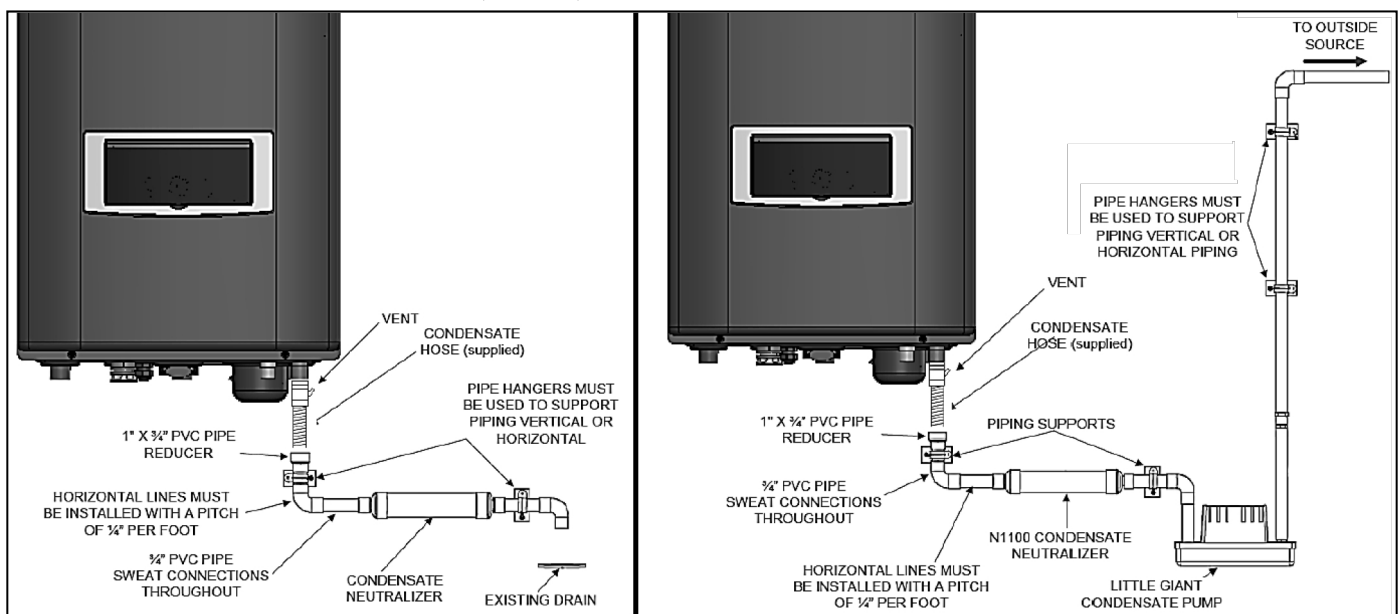

Figure 29 - Internal Condensate Trap

**Part 7 - Connecting Electrical Service**

**WARNING**

Install wiring and electrically ground boiler in accordance with the authority having jurisdiction or, in the absence of such an authority, follow the National Electrical Code, NFPA 70, and/or CSA C22.1 Electrical Code-Part 1 in Canada. Failure to follow all applicable local, state, and national regulations, mandates, and building supply codes for guidelines to install the electrical power supply could result in property damage, serious personal injury, or death.

**ELECTRICAL SHOCK HAZARD** – To ensure safety, turn off electrical power supply at service entrance panel before making any electrical connections to avoid possible electric shock hazard. Failure to do so could result in property damage, serious personal injury, or death.

Jumping out control circuits or components WILL VOID product warranty and can result in property damage, personal injury, or death.

It is of extreme importance that this unit be properly grounded. It is very important that the building system ground is inspected by a qualified electrician prior to making this connection. Electrical power must only be turned on when the boiler is completely filled with cold water. Failure to follow these instructions could result in component or product failure, serious injury, or death.

**CAUTION**

Label all wires prior to disconnecting them when servicing the boiler. Wiring errors can cause improper and dangerous operation. Failure to follow these instructions may result in property damage or personal injury.

**A. Wiring**

The boiler is equipped with a three prong power cord. The boiler is limited to a maximum of 15 amps at 120 volts in use.

**Ensure the Appliance is Properly Grounded**

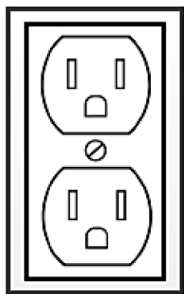

Grounded Electrical Outlet

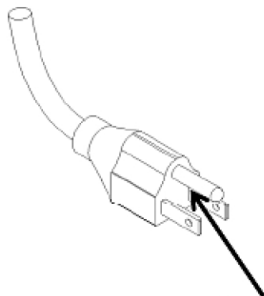

**WARNING! DO NOT REMOVE THIS GROUNDING PRONG FROM THE APPLIANCE PLUG!**

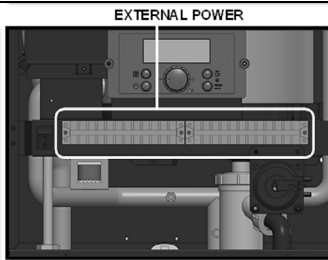
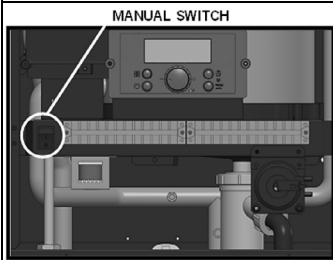

**Figure 31 - Proper Grounding - Internal Manual Power Switch**

1. This boiler must be properly grounded. Ensure the electrical receptacle is properly grounded. Do not remove the grounding prong from the boiler plug.
2. Do not attach the ground wire to either the gas or water piping.
3. The wiring diagrams in this manual are to be used for reference purposes only.
4. Refer to these diagrams and the wiring diagrams of any external controls used with the installation when wiring the boiler. Read, understand, and follow all wiring instructions supplied with the controls.
5. Do not disconnect the power supply when the boiler is in normal operation.

**NOTE:** For additional electrical protection, the use of a whole house surge protector is recommended. Damage caused by power surges IS NOT covered by the warranty.

**NOTICE**

If the boiler display does not turn on, first check the plug. Then check the electrical panel circuit breaker and reset if necessary. If the circuit breaker trips again, do not reset. Disconnect the plug and have a qualified technician diagnose the problem.

**B. Dip Switches**

There is one set of DIP switches. DIP switches 6 and 7 need to be set to OFF for the boiler to operate normally.

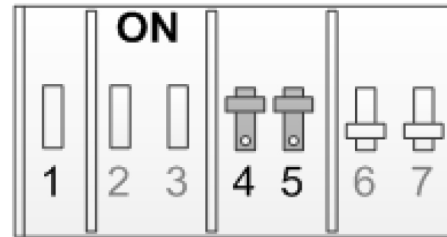

**Figure 32 - Proper Grounding - Internal Manual Power Switch**

DIP SWITCH	OFF	ON
1-3	Factory	Factory Settings - DO NOT CHANGE
4	Vent Size	2" / 3"
5	Gas Type	LP / NG
6	High Fire	Normal / High Fire
7	Low Fire	Normal / Low Fire

**Table 19 - DIP Switch Group - NOTE: DO NOT CHANGE SWITCHES 1-3. THESE ARE FACTORY SETTINGS.**

<b>Maximum Flame Detecting Voltage</b>	2.4V
<b>Pre-Purge Time (Tp)</b>	Maximum 10 seconds, Minimum 1 second
<b>Safety Time (Igniting Time) (Ts)</b>	3.5 seconds
<b>Igniting Interval Time</b>	20 seconds
<b>Post-Purge Time (Tip)</b>	3 minutes
<b>Over-Heating 1, 2, 3, Protection Detection Time</b>	<3 seconds
<b>Pump 1 Post Circulating Time (T1pv)</b>	1 minute
<b>Pump 2 Post Circulating Time (T2pv)</b>	1 minute
<b>High and Low Water Level Detection Time</b>	<6 seconds
<b>High and Low Water Level Recovery Time</b>	<6 seconds

**Table 20 - System Control Settings**





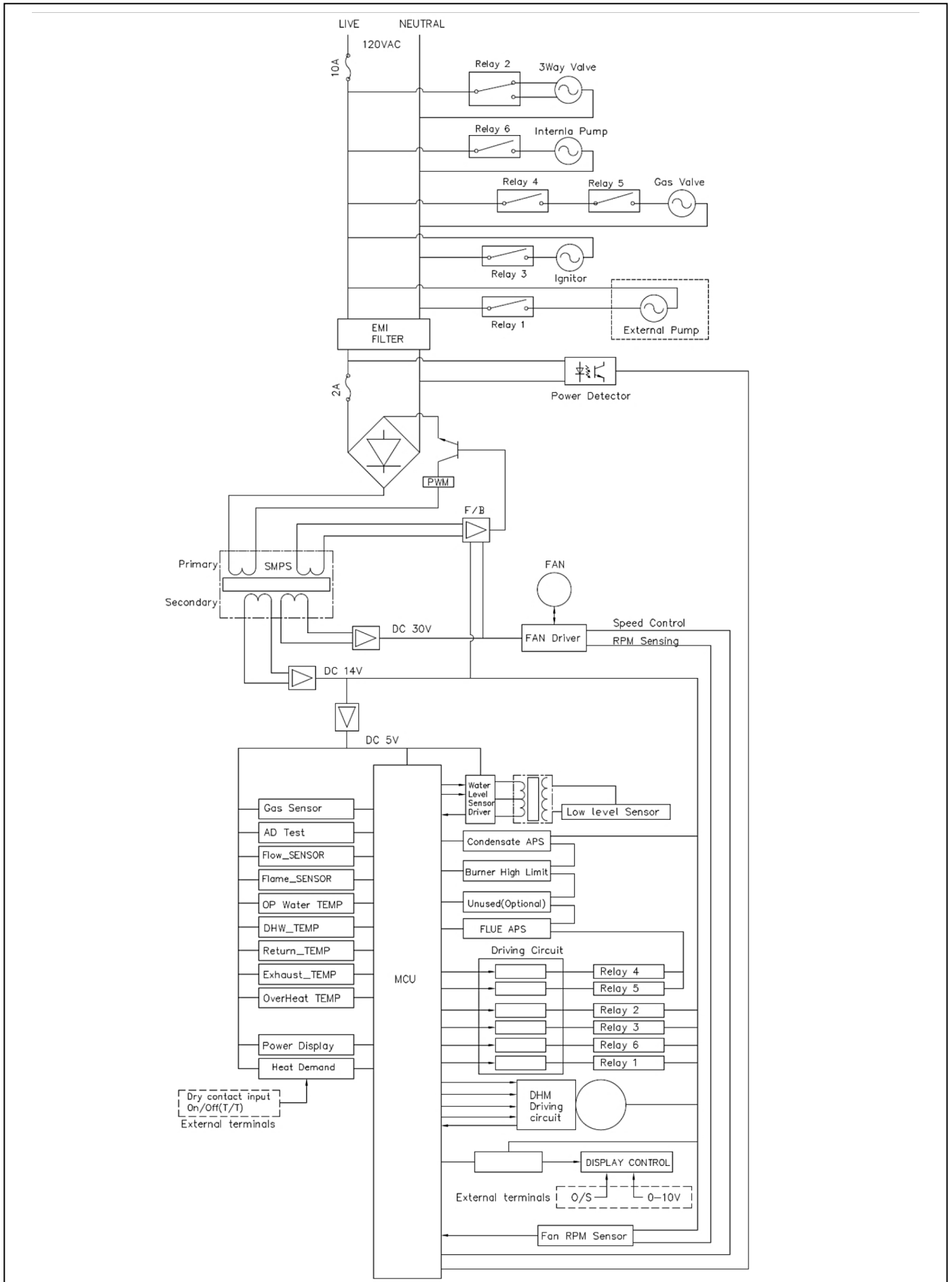

Figure 34 - Ladder Diagram



Connector			Description	HT Selv	
No. of Location	Pin	Board Silk			
<b>CN9</b> <b>65001WS-12</b>	1		GROUND	HT (120V~) AC	
	2	L	Power Supply Line		
	3	CP1	External CH Pump Power Supply (Live)		
	4	IT	Ignitor Power Supply		
	5	L/(HT)	Internal Pump Power Supply (Live)		
	6	GV	Gas Valve Power Supply		
	7		-		
	8	N	Power Supply (Neutral)		
	9-12		AC Power COM Line		
<b>CN6</b> <b>LW6A4-03</b>	1	CP2/3WAY	3 Way Valve	SELV (5V) DC	
	3				
<b>CN1</b> <b>SMW250-03</b>	1	RS-485	RS-485 +		
	2		GND		
	3		RS-485 -		
<b>CN4</b> <b>LWD1140-06</b>	1	FAN	NOT USED		-
	2		GND		SELV (14V) DC
	3		VDD		SELV (8 - 26.5V) AC
	4		Fan power (start coil)		
	5		Fan power (end coil)		
	6		Fan speed feedback signal	SELV (14V) DC	
<b>CN8</b> <b>SMW250-04</b>	1	MCU ISP	GND	SELV (5V) DC	
	2		ISP / Reset Port		
	3		ISP TOOL0 Data Port		
	4		VCC		
<b>CN11</b> <b>LWD1140-16</b>	1	HWL	NOT USED	SELV (12V~) AC	
	8				
	2	LWL	Low Water Level Sensor		
	10				
	3	HD	Central Heating Demand (T/T)	SELV (5V) DC	
	11				
	4	TH	Display Control	SELV (14V) DC	
	12				
	5	APS	Flue Air Pressure Switch		
	13				
	6	EL	NOT USED		
	14				
	7	BL	Burner High Limit		
	15				
	8	HL	Condensate Air Pressure Switch		
	16				

Table 21 - Boiler Wiring 1

Connector			Description	HT SELV
No. of Location	Pin	Board Silk		
CN7 LWD1140-14	1	F.S	Flame Sensor	SELV (5V)
	8			
	2	O.P.S	Operating Water Temperature Sensor	
	9			
	3	D.H.S	DHW Temperature Sensor	
	10			
	4	I.S	NOT USED	
	11			
	5	B.G.S	Exhaust Temperature Sensor	
	12			
	6	S.T.S	NOT USED	
	13			
	7	S.P.S	Overheat Temperature Sensor	
	14			
CN14 SMW250-09	1	DHM	GND	SELV (14V)
	2		DHM Stepper Motor Position	
	3		VDD	
	4		DHM Stepper Motor Coil X Phase	
	5		DHM Stepper Motor Coil Y Phase	
	6		VDD	
	7		DHW Stepper Motor Coil / X Phase	
	8		DHM Power IWM Stepper Motor Coil / Y Phase	
	9		NOT USED	
	CN3 SMW250-06		4	FLUX1
5		Water Flow Sensor		
6		GND		
CN5 SMW250-10	1	RPM	Fan RPM Check	SELV (5V)
	2		GND	

Table 22 - Boiler Wiring 2

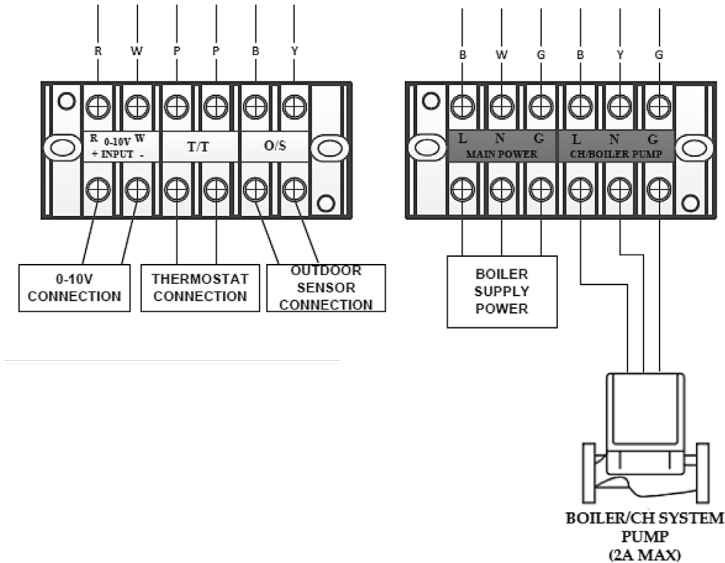

Figure 35 - Terminal Block Wiring Detail

**Part 8 - Gas Connections**

**WARNING**

**FIRE AND/OR EXPLOSION HAZARD**

To avoid serious injury or death, the gas line installation and the gas line inlet pressure test must be done by a licensed professional.

Ensure the gas on which the boiler will operate is the same type specified on the rating plate (natural gas or LP gas). This boiler must be converted into propane operation unless specifically manufactured for use with propane. Follow Gas Conversion Manual instructions (separate document). Propane ready boilers have the suffix "LP" after the model serial number. Failure to follow these instructions could result in property damage, personal injury, or death.

Make sure the gas line pressures are within normal limits. Pressures outside normal limits can result in poor performance and hazardous operating conditions. Failure to do so could result in property damage, personal injury, or death.

**A. Gas Pipe Sizing Tables**

**1. Gas Pipe Sizing**

This information is for reference use only. Refer to gas pipe manufacturer specifications for actual delivery capacity. The DOE standard for Natural Gas is 1100 BTU/ft<sup>3</sup>. Contact the local gas supplier for actual BTU/ft<sup>3</sup> rating.

**2. Natural Gas Pipe Sizing**

The following tables list maximum capacity of pipe in cubic feet of gas per hour for gas pressures of 14" or less and a pressure drop of 0.5 inches water column, based on a 0.60 specific gravity for natural gas.

Pipe Size (in.)	Length of Pipe (Feet)										BTU's Per Hour x 1,000
	10	20	30	40	50	60	80	100	150	200	
3/4	360	247	199	170	151	137	117	104	83	71	Schedule 40 Metallic Pipe  (0.60 Specific Gravity, 0.5 WC Pressure Drop)
1	678	466	374	320	284	257	220	195	157	134	
1 1/4	1390	957	768	657	583	528	452	400	322	275	
1 1/2	2090	1430	1150	985	873	791	677	600	482	412	
2	4020	2760	2220	1900	1680	1520	1300	1160	928	794	
3	11300	7780	6250	5350	4740	4290	3670	3260	2610	2240	
4	23100	15900	12700	10900	9660	8760	7490	6640	5330	4560	

**Table 23 - Natural Gas Delivery Capacity - Refer to ANSI Z223.1 - National Fuel Gas Code, Latest Edition**

**3. LP (Liquid Propane) Gas Pipe Sizing**

Contact gas supplier to size pipes, tanks, and 100% lockup gas pressure regulator. Adjust propane supply regulator provided by the gas supplier for 14 inches w.c. maximum pressure.

**B. Gas Connection Requirements**

1. The gas connection fitting on the boiler is 3/4" NPT. **NOTE:** The pipe size must not be less than 3/4".
2. The supply line must be sized for the maximum output of the boiler being installed. If there are additional gas boilers from the main supply line, measure the size of the supply line according to the COMBINED total maximum BTUH draw for the boilers as if they were operating at the same time.
3. Measure the length of the gas supply line from the gas meter to the boiler. Boiler must be installed downstream of the gas meter to ensure adequate gas supply. Use the tables in this manual or refer to the gas line manufacturer's sizing information to determine the correct supply pipe size.
4. The National Fuel Gas Code (NFPA 54) requires that a sediment trap (drip leg) be installed in the gas line on boilers not so equipped. The drip leg must be accessible, a minimum of 3" in length, and not subject to freezing conditions. See Figures 36 and 37.
5. A manual gas shut-off valve should be installed in the gas supply line close to the boiler. See Figures 36 and 37 for detail.
6. To facilitate any future maintenance, it is also recommended that an approved gas union fitting be installed in the supply line between the shut-off valve and the 3/4" NPT connection on the boiler.
7. Use a manometer to test the gas pressure to make sure it meets the minimum standards and does not exceed the maximum standards of the boiler.
8. Leak test the gas line pipe before placing the boiler in operation. Only use approved leak detector liquid solutions to check for leaks.
9. Do not operate the boiler until all connections have been completed and the heat exchanger is filled with water.

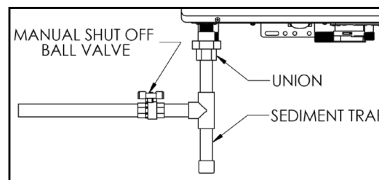

**Figure 36 - Gas Line with Shut-Off and Sediment Trap Detail - Wall Model**

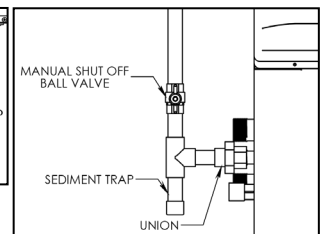

**Figure 37 - Gas Line with Shut-Off and Sediment Trap Detail - Floor Model**

**C. Additional Precaution for Excess Flow Valve (EFV)**

If an excess flow valve (EFV) is in the gas line, check the manufacturer's minimum and maximum flow capacity ratings. An improperly sized EFV will not allow for a full flow of gas to the boiler and will cause the boiler to malfunction. See Figure 38.



**Figure 38 - Excess Flow Valve (EFV)**

**D. Checking Gas Pressure at the Boiler for Proper Operation**

**NOTE:** Refer Figure 39 when checking gas pressure. Loosen the bolts before checking the gas inlet pressure.

1. The boiler and its individual shutoff valve must be disconnected from the gas supply piping system during any pressure testing of the system at test pressures greater than 1/2 psi (3.5 kPa).
2. The boiler must be isolated from the gas supply piping system by closing its individual manual shutoff valve during any pressure testing of the gas supply piping system at test pressures equal to or less than 1/2 psi (3.5 kPa).

The minimum and maximum inlet gas line pressures must meet the requirements shown in Table 25.

Natural or LP Gas	
Minimum Pressure	3.5"WC
Maximum Pressure	14"WC

**Table 24 - Gas Pressure Requirements**

NOTICE

Do not fire (operate) the boiler until all connections have been completed and the heat exchanger is filled with water. Doing so will damage the boiler and void the warranty.

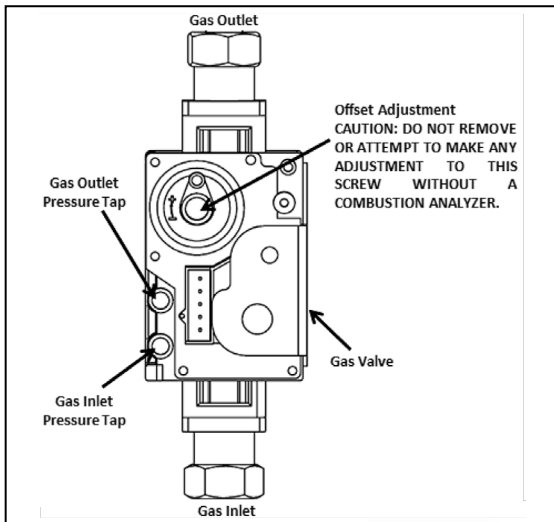

**Figure 39 - Gas Valve Detail**

**E. Setting and Verifying the Combustion Setting**

1. After the boiler has fired, flip DIP switch seven (7) to the ON position (low fire). Proceed to check boiler combustion values.

**NOTE:** Use a calibrated combustion analyzer to ensure CO and CO2 values are within the range shown in Table 26.

WARNING

It is required to use a calibrated combustion analyzer to verify final adjustment according to the combustion chart (Table 26). Failure to do so could result in serious personal injury or death.

If the readings obtained are lower or higher than the combustion readings in Table 26, use a 4mm Allen key to adjust the offset screw in a clockwise (positive) or counterclockwise (negative) direction (approximately 1/4 turn). See Figure 39. Check your combustion values. Repeat this procedure until the values obtained on the calibrated combustion analyzer agree with those stated in Table 26.

**NOTE:** If the boiler makes a whistling sound (harmonics) at low fire, adjust the offset screw in a clockwise (positive) direction (approximately 1/8 turn). Check your combustion values and ensure they agree with those stated in Table 26 before proceeding.

2. When low fire settings have been obtained, flip DIP switch seven (7) to its original (OFF) position. This will return the boiler to normal operation.

3. Flip DIP switch six (6) to ON (high fire). Again check combustion readings with a calibrated combustion analyzer.

**NOTE:** DO NOT adjust the gas valve offset screw at high fire. The offset screw is only used to adjust combustion values at low fire.

4. When complete, flip DIP switch six (6) to its original (OFF) position. This will return the boiler to normal operation.

5. Allow boiler to operate normally. Ensure it is operating properly.

6. Use a Phillips Head screwdriver to reinstall the boiler cover.

WARNING

It is very important that the combustion system be set within the recommended CO measurements listed in Table 26. Visually looking at the burner does not determine combustion quality. Failure to measure combustion with a calibrated combustion analyzer and set the throttle within the recommended CO measurements could result in property damage, severe personal injury, or death.

Fan Speed	Natural Gas		LP Gas	
	Low	High	Low	High
CO PPM	≤175		≤175	
CO <sub>2</sub> (%)	8 - 9 1/2	8 1/2 - 10	9 - 10 1/2	9 1/2 - 11

**Table 25 - Combustion Settings**

WARNING

Breathing Hazard - Carbon Monoxide Gas

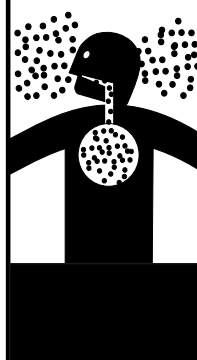

- Do not operate heater if flood damaged.
- Install vent system in accordance with local codes and manufacturers installation instructions.
- Do not obstruct heater air intake or exhaust. Support all vent piping per manufacturers installation instructions.
- Do not place chemical vapor emitting products near unit.
- According to NFPA 720, carbon monoxide detectors should be installed outside each sleeping area.
- Never operate the heater unless it is vented to the outdoors.
- Analyze the entire vent system to make sure that condensate will not become trapped in a section of vent pipe and therefore reduce the open cross sectional area of the vent.

Breathing carbon monoxide can cause brain damage or death. Always read and understand instruction manual.

LP-304

## Part 9 - Controls

### A. Control and Display Overviews

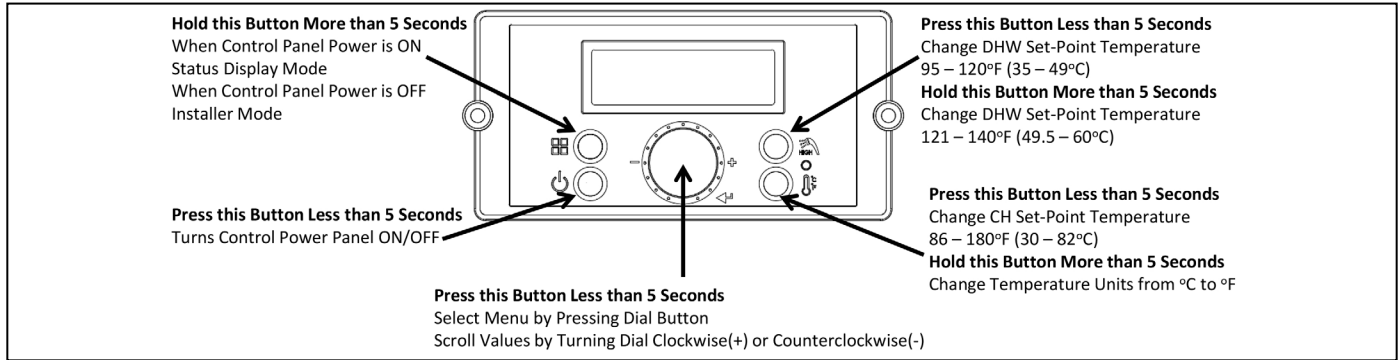

Figure 40 - Control Panel Detail

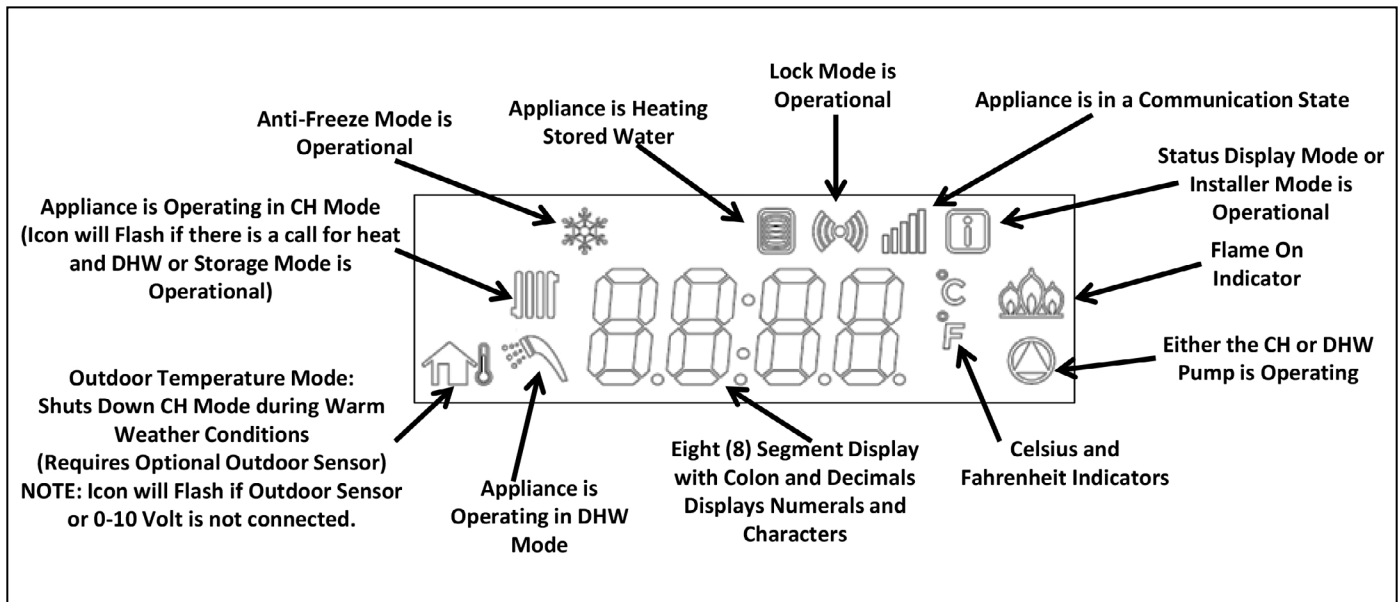

Figure 41 - LCD Display

The LCD display also features a backlit lamp that will illuminate:

- When a user action is detected (a button is pressed)
- The display has timed out for approximately 2 minutes

### B. Start-Up Sequence

After the boiler is powered ON, the LCD display shows a sequence of information. The icons will flash, followed by various indicators that describe the boiler controller and software versions. It will take the boiler roughly 15 seconds to cycle through the Start-Up Sequence.

Display Items	Time for Display	Remarks
LCD Test	1 sec	All segments "ON"
	0.5 sec	All segments "OFF"
Category: UFTC	1 sec	Pdn
	1 sec	0051
Software Version for Front Panel	1 sec	SPn
	1 sec	00.xx
Software Version for Boiler	1 sec	SFn
	1 sec	xx.xx
Hardware Version for Boiler	1 sec	Hdn
	1 sec	00xx

Table 26 - Start-Up Sequence

**NOTE:** When the boiler is powered ON, the fan will operate at maximum speed for 1 minute to purge the air and any fumes from the intake and exhaust pipes.

After start-up, the display appears as follows.

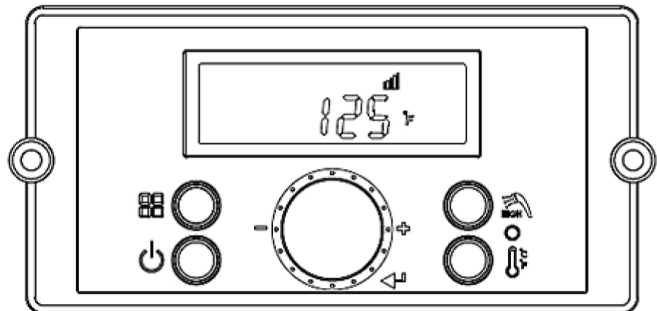



Figure 42 - Initial Display Screen

**NOTE:** The initial display screen will differ depending on a number of factors, including whether the boiler detects a call for heat or hot water.

The Control System can operate through user and service modes that have specific LCD outputs and dedicated controls, including:

- Changing the Set-Point Temperature
- Lock Function
- Status Display
- Installer Mode
- Error Mode
- Outdoor Temperature Mode

### C. Changing the DHW Set-Point

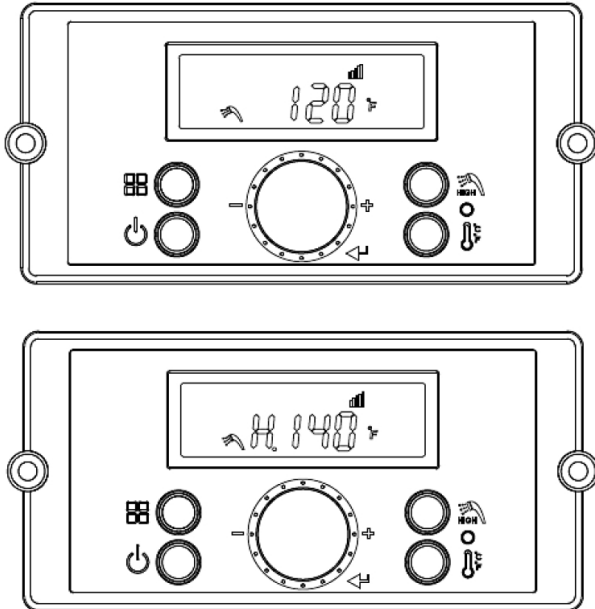

Press the  button when the display panel is powered ON to change the DHW Set-Point. The display will appear as follows.







**Figure 43 - DHW Set-Point Screens**

The DHW icon and current set-point temperature will flash when the DHW Set-Point can be changed.

Factory DHW Set-Point is 125°F (51°C). Initial DHW Set-Point range is 95 – 120°F (35 – 49°C).

Turn the dial  counterclockwise to lower and clockwise to raise the DHW set-point. After changing the temperature, press the  button to save the set-point.

To change the DHW Set-Point above 121°F (49.5°C), press the  button when the display panel is powered ON. The current DHW set-point will display and the DHW icon will flash. Then press and hold the  button for five seconds. The scald warning letter “H” (high temperature) will display. High temperature DHW Set-Point range is 121 – 140°F (49.5 – 60°C).

Turn the dial  counterclockwise to lower and clockwise to raise the DHW set-point. After changing the temperature, press the  button to save the set-point.

#### **DANGER**

Hotter water increases the risk of scald injury. Scalding may occur within five (5) seconds at a setting of 140°F (60°C). Water temperature over 125°F can instantly cause severe burns or death from scalds. Children, disabled, and elderly persons are at the highest risk of being scalded. See instruction manual before setting temperature at the boiler. Feel water before bathing or showering!

### D. Changing the Temperature Indicator

To change the temperature indicator from Fahrenheit to Celsius,

press and hold the  button for more than five (5) seconds when the display panel is powered ON. This will toggle the temperature unit indicated on the display.

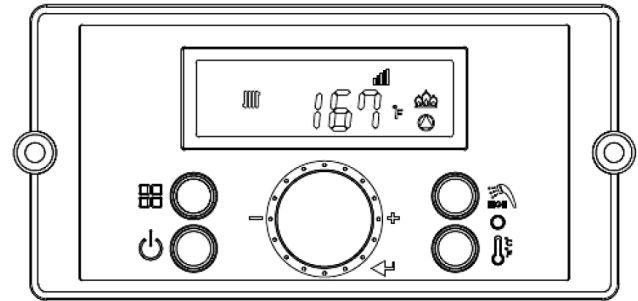

### E. Changing the CH Set-Point

Press the  button when the display panel is powered ON. The display will appear as follows. The set-point will flash when the CH set-point can be changed.



**Figure 44 - CH Set-Point Screens**

Factory CH Set-Point is 180°F (82°C). Initial CH Set-Point range is 86 – 180°F (30 – 82°C).

Turn the dial  counterclockwise to lower and clockwise to raise the CH set-point. After changing the temperature, press the  button to save the set-point.

**NOTE:** The CH Set-Point cannot be changed by pressing the  button if an outdoor sensor or 0-10V is connected to the boiler. When using an outdoor sensor, the boiler will automatically change the target temperature based on the outdoor reset curve. When using 0-10V, the boiler will automatically change the target temperature based on input voltage.

**NOTE:** If input voltage is less than 1.5V the 0-10V will be ignored.

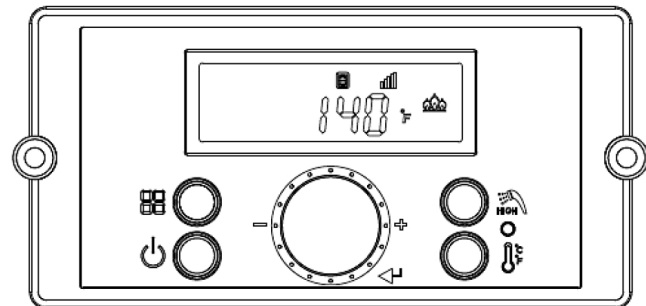

### F. Storage Mode

Storage Mode indicates that the boiler is heating stored water in the internal storage tank. When Storage Mode is operating the display appears as follows.



**Figure 45 - Storage Mode Screens**

### G. Lock Function

To turn on Lock Function, press the  button at the d:Lc parameter when scrolling through the Status Display screens. Turn the dial  counterclockwise to lower and clockwise to turn Lock Function On or Off. Press the  button to return to normal operation.

**NOTE:** The control system will not allow changes if Lock Function is activated. Lock Function will have to be turned off before making further changes.

### H. Status Display

Status Display will activate when button  is pressed and held for five seconds at Standby Mode when the display panel is powered ON.

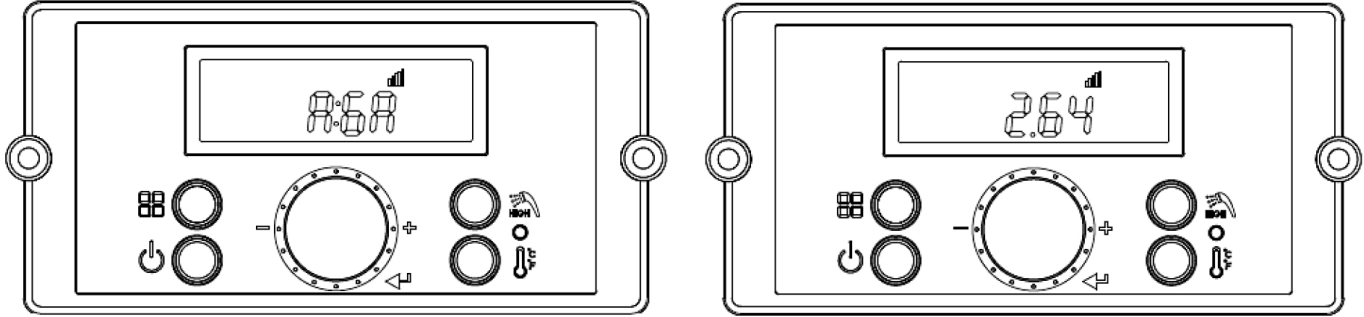

Figure 46 - Status Display Screens











Display (Main Menu)	Display (Sub Menu)	Detail		Description		
<b>O:ot</b>		Outdoor Temperature		Current Outdoor Sensor Temperature (When --- is displayed, outdoor sensor is not connected.)		
<b>A:Li or A:GA</b>		DHW Water Flow Rate		Current DHW Flow (Li: LPM; GA: GPM)		
<b>b:lt</b>		CH return water temperature		Current CH return water temperature		
<b>c:Fr</b>		Fan speed (RPM)		Current fan speed (RPM)		
<b>d:Lc</b>		Lock Function		Turns Lock Function On and Off		
<b>E:oP</b>		CH supply water temperature (Operating Temperature)		Current CH supply water temperature		
<b>F:dH</b>		DHW outlet temperature		Current DHW outlet temperature		
<b>H:Eh</b>		Exhaust temperature		Current exhaust temperature		
<b>I:St</b>		N/A		Not Used (Default is 0)		
<b>J:oH</b>		CH water overheat temperature		Current temperature on the overheat sensor		
<b>L:rt</b>	<b>1:PH</b>	Burner Operation Time	Power supply	<b>L:rt</b> on display on sub menu	Time boiler has been powered in 1000 hour units	
	<b>2:rh</b>		Burner operating time		Time burner has operated in 1 hour units	
	<b>3:rH</b>		Burner operating time		Time burner has operated in 1000 hour units	
	<b>4:lt</b>		Ignition attempts		Number of ignition attempts: 10 times the displayed unit	
	<b>5:IH</b>		Ignition attempts		Number of ignition attempts: 10,000 times the displayed unit	
<b>P:Ou</b>	Displays output condition for internal primary pump and three way valve  - Off  - On		1st Icon	2nd Icon	3rd Icon	
			External Pump	Internal Primary Pump	3 Way Valve	
						

Table 27 - Status Display Screen Descriptions

Turn the dial  counterclockwise and clockwise to scroll through the displayed parameters. To view parameter details, press the  button at the appropriate screen. Press the  or  buttons to leave the parameter.

Press the  button again to return to Operation Mode.



## I. Installer Mode

Installer Mode will activate when button  is pressed and held for five seconds while the boiler display is powered Off.

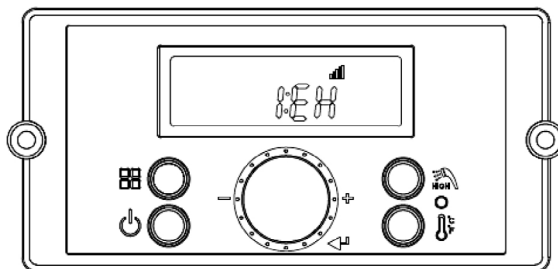





Figure 47 - Installer Mode Screens

Display	Default	Detail	Description
1:EH	E0.00	Error history up to 10	Check ten most recent Error Codes (E0 - E9)
2:cE	OFF	Clear Error History	Select "ON" to Clear Error History. Range: ON or OFF
3:In	OFF	System Reset (Factory Setting)	Select "ON" to restore system to default factory settings (Burner operation time, Ignition cycles, and Supply power time will not be reset. See Functions 10 and 11.) Range: ON or OFF
4:Fu	GA	Water Volume Unit	Range: GA or Li
5:St	ON	Stored Water Heating Function	Select "OFF" to turn off this function Range: ON or OFF
6:OH	68F	Maximum Outdoor Temperature	When used with an outdoor sensor, sets the maximum outdoor design temperature for the system design. Maximum outdoor temperature must be set 9°F above the minimum outdoor temperature. Range: (Minimum Outdoor Temperature + 9°F) to 110°F
7:OL	5F	Minimum Outdoor Temperature	Sets the minimum outdoor design temperature for the system. Minimum outdoor temperature must be set at least 9°F below the maximum outdoor design temperature. Range: -4°F to (Maximum Outdoor Temperature - 9°F)
8:FH	00	Maximum Fan Speed	Adjusts Maximum Fan Speed Range: -30 - +30
9:FH	00	Minimum Fan Speed	Adjusts Minimum Fan Speed Range: -30 - +30
10:dr	NO	Reset burner operation time	Select YES to reset burner operation time Range: NO or YES
11:dl	NO	Reset ignition cycle	Select YES to reset ignition cycles Range: NO or YES
12:bt	0	Boost Function	When Outdoor Temperature Mode is used, this function boosts CH temperature to the maximum supply temperature based on the outdoor reset curve if set point is not reached within the set period of time. Range: 0 - 120 min <b>NOTE:</b> "0" means Boost Function is OFF.
13:Ft	1	CH Anti-Frequency Time	This function delays burner operation during CH mode. Range: 0 - 20 min
14:bo	27F	Set differential temperature to turn burner "ON"	When set, the boiler will operate to heat CH water when water temperature falls below a differential setting. Example: If setpoint is 180°F and differential is 27°F, the boiler will turn on when CH water temperature falls below 153°F. Range: 9 - 27°F
15:OF	68F	Warm Weather Shutdown	Warm weather shut down will shut down CH Mode if the programmed outdoor temperature is exceeded. Range: 50 - 110°F
16:cH	180F	Maximum Supply Temperature	Sets the maximum design supply temperature based on the minimum outdoor design temperature. Maximum supply temperature must be set 9°F above the minimum supply temperature. Range: (Minimum Supply Temperature + 9°F) - 180°F

Display	Default	Detail	Description	
17:cL	86F	Minimum Supply Temperature	Sets the minimum design supply temperature based on the maximum outdoor design temperature. Minimum supply temperature must be set 9°F above the maximum supply temperature. Range: 86°F (Maximum Supply Temperature - 9°F)	
18:dH	140F	Maximum DHW Setpoint Temperature	Sets Maximum DHW Setpoint Temperature Range: 120 - 140°F	
19:cb	100	Heating capacity	Sets heating combustion rate Range: 50 - 100% <b>NOTE:</b> 199 Models shall be factory set at 70%. The default number will be 70. This percentage can be increased with an additional pump.	
20:db	100	DHW capacity	Set DHW combustion rate Range: 50 - 100%	
21:PP	40	Internal CH Pump Post Run Timer, T/T Calling for Heat	When boiler CH setpoint is satisfied, but T/T is calling for heat, the burner will shut OFF and the CH pump will continue to run for this set amount of time Range: 1 - 60 minutes	
22:Po	5	Internal CH Pump Overrun Timer (On)	This function runs the Internal CH Pump after the Internal CH Pump Post Run Timer has completed. This will cycle the Internal CH Pump again based on the default programmed Off and On cycles and repeats until the central heating call is satisfied. Range: 1 - 60 minutes	
23:PF	0	Internal CH Pump Overrun Timer (Off)		
24:SF	150F	Internal DHW Storage Tank Setpoint	Sets the Internal DHW Storage Tank Setpoint Range: 140 - 167°F	
25:So	20F	Internal DHW Storage Tank Differential	Sets the Internal DHW Storage Tank Differential Range: 140 - 167°F	
26:dt	2	Delay time when switching from DHW Mode to CH Mode	Range: 0 - 2 Minutes	
27:PE	1	Internal CH Pump Post-Purge Time, T/T Satisfied	Allows the user to set the boiler pump post purge time once the boiler CH setpoint and thermostat are satisfied. Range: 1-5 minutes	
28:HA	0-2	High Elevation Mode	This boiler may be installed at elevations up to 10,000 feet and operate on either Natural or LP. The boiler will de-rate by 4% for each 1000 feet above sea level. Select the appropriate installation location as described below. Selects Installation Location for Proper Boiler Operation at Altitude: 0-2 for installation locations from sea level to 1999 feet 2-5 for locations from 2000 to 4999 feet 5-8 for locations from 5000 to 7999 feet, 8-10 for locations from 8000 to 10000 feet Default: 0 - 2 <b>NOTE:</b> Use a calibrated combustion analyzer to ensure CO and CO2 are within the ranges shown in this manual. Adjust the offset screw in the clockwise (positive) or counterclockwise (negative) directions (approximately 1/8 turn) if the measured CO2 value on LOW FIRE is out of range.	
29:AP	AP:cP	5	Internal CH Pump and Internal DHW Storage Pump Test Mode	This function sets the time to run both the Internal CH and Internal DHW Storage pumps to purge air from the system. Range: 1 - 30 minutes
	cP:oFF or cP:on	OFF	Internal CH Pump and Internal DHW Storage Pump Test Mode	Turn this function on to activate Internal CH and Internal DHW Storage pump testing. Only works in Installation Mode. Turns off during normal operation.

Table 28 - Installer Mode Descriptions

Turn the dial  counterclockwise and clockwise to scroll through the displayed parameters. To view parameter details, press the  button at the appropriate screen. Turn the dial  counterclockwise and clockwise to change the selected parameter. To save the setting press the  button.

To leave Installer Mode, press the  button again. The display will return to power off mode.

### J. Outdoor Temperature Mode (Optional)

**NOTE:** If the system requires a fixed operating temperature, the outdoor sensor is not required and should not be installed.

There is no connection required if an outdoor sensor is not used in the installation.

1. Use a minimum 22 AWG wire for runs of 100 feet or less and minimum 18 AWG wire for runs of up to 150 feet.

2. Mount the outdoor sensor on an exterior surface of the building, preferably on the north side in an area that will not be affected by direct sunlight and will be exposed to varying weather conditions.

**NOTE:** For correct mounting procedures, follow instructions provided with the sensor.

**NOTE:** If sensor wires are located in an area with sources of potential electromagnetic interference (EMI), the sensor wires should be shielded, or the wires routed in a grounded metal conduit. If using shielded cable, the shielding should be connected to the common ground of the boiler.

**NOTE:** Outdoor Temperature Mode Icon on the display will flash if an Outdoor Sensor or 0-10 Volt is not connected to the boiler.

See Figure 48 to set your Outdoor Reset Curve.

To check the CH Target Temperature while using Outdoor Temperature Mode, press the  button while the boiler is operational and the display panel is powered on.

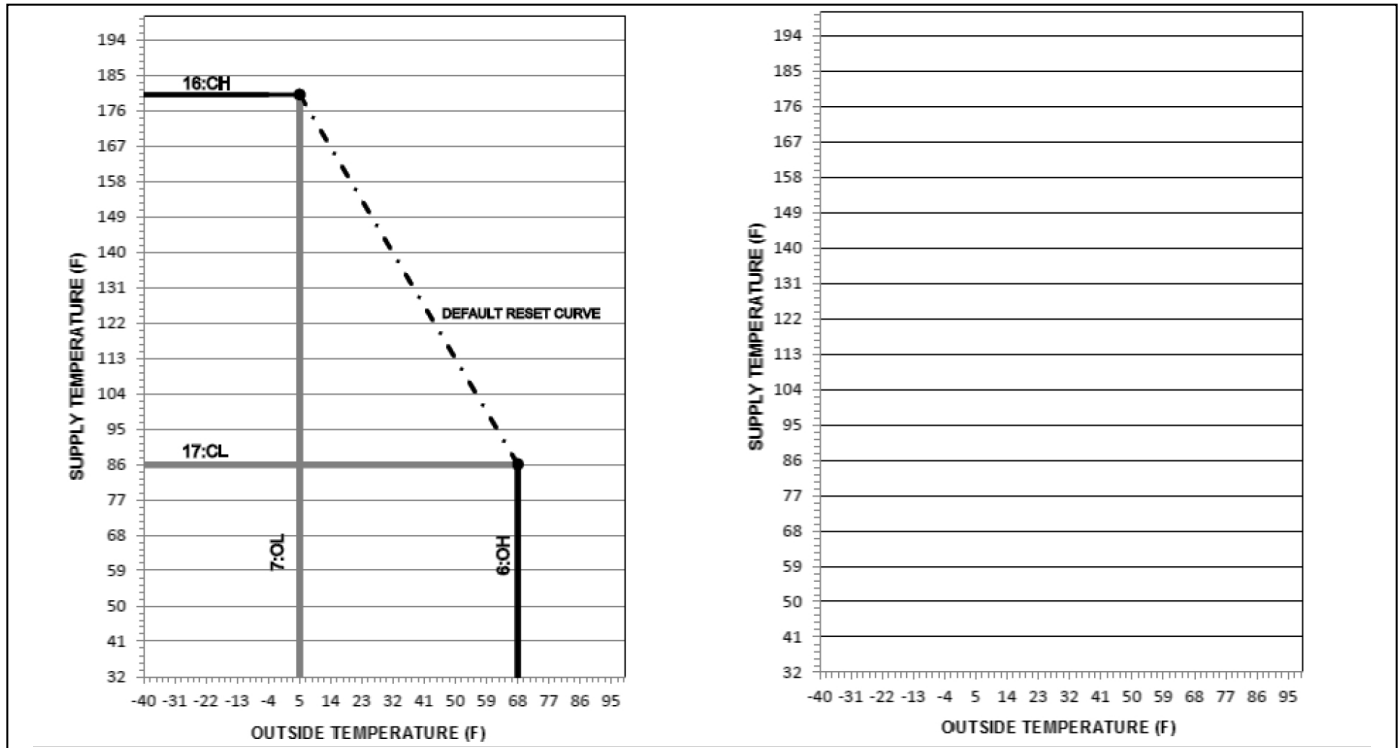

Figure 48 - Outdoor Reset Curve - See Installer Mode for Curve Setting Descriptions

**K. 0-10 Volt Input**

1. A signal from a building management system may be connected to the boiler to enable remote control. This signal should be a 0-10 volt positive-going DC signal. When the 0-10V input is wired to the boiler terminal strip, a building control system can be used to control the set point temperature of the boiler. The control interprets the 0-10 volt signal as follows; when the signal is between 0 and 1.5 volts, the boiler will be in standby mode, not firing. When the signal rises above 1.5 volts, the boiler will ignite. As the signal continues to rise towards its maximum of 10 volts, the boiler will increase in set point temperature.

2. Connect a building management system or other auxiliary control signal to the terminals marked for this purpose on the boiler terminal block (shown in Piping Diagrams, this manual). Caution should be used to ensure that the 0-10 VOLT + connection does not become connected to ground.

**NOTE:** Ensure that the polarity of the connections from the external modulating boiler controller to the boiler is correct. Reversed polarity could lead to erratic and/or no response from the boiler controller.

**NOTE:** Outdoor Temperature Mode Icon on the display will flash if an Outdoor Sensor or 0-10 Volt is not connected to the boiler.

**0-10V INPUT TABLE:**

When outside voltage is applied to the connector (2) in the wiring diagram,

1. The outdoor temperature sensor does not work.
2. The 0-10V symbol is displayed.
3. The heating temperature is automatically set according to the external voltage input.

**NOTE:** 0-10V is prioritized over T/T. If input voltage is less than 1.5V then T/T will operate.

The range of input voltage is approximately 1.5[V] ~ 10[V] and the heating temperature settings according to this range are as follows.

Input voltage[V]	Heat temperature [°C]	Heat temperature [°F]
1.5	35.0	95
2.0	37.1	98.8
2.5	39.2	102.7
3.0	41.3	106.5
...		
9.0	66.6	152
9.5	69	156.2
10	71.1	160

Table 29 - 0-10V Input Voltages and Associated Temperatures

**CAUTION**

Voltage exceeding 15V may damage internal parts. Such damages are not covered by product warranty.

## Part 10 - Troubleshooting

### A. Error Code

When the boiler encounters an error, the display will flash "Er" followed by a numerical code. The boiler shall enter a soft lockout condition if the error is such that it can return to normal operation once the condition relieves itself (overheat conditions, NTC open or shorts, etc.). The boiler shall enter a hard lockout if the condition indicates something more serious (flame, ignition, condensate line, etc.) To clear a hard lockout Error Code, press the Power button. See Figure 49.

The following screen will display when the boiler encounters an error.

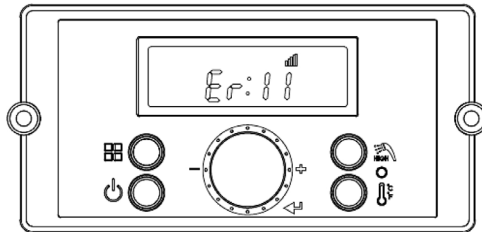

Figure 49 - Error Screen

Error Code	Error Code Description	Possible Remedies
<b>Er:10</b>	Flame has extinguished 5 (five) times	<p>Press the Power button to clear the Error Code. The Code will also automatically reset after one hour (up to three (3) times).</p> <p>If Error happens again:</p> <ol style="list-style-type: none"> <li>1. Monitor the gas pressure to the boiler while in operation. Ensure pressure is between 3.5 and 14" WC.</li> <li>2. Check gas valve wire. Ensure connection is secure.</li> <li>3. Check flame detection sensor. Ensure connections are secure. Normal operating settings are more than 2.5DC before ignition, less than 2.5DC after ignition.</li> <li>4. Check vent terminations. Ensure there are no blockages.</li> <li>5. Assure that the flame is stable when lit.</li> <li>6. If the problem persists, replace the main control.</li> </ol>
<b>Er:11</b>	Ignition has failed 5 (five) times	<p>Press the Power button to clear the Error Code. The Code will also automatically reset after one hour (up to three (3) times).</p> <p>If Error happens again:</p> <ol style="list-style-type: none"> <li>1. Monitor the gas pressure to the boiler while in operation. Ensure pressure is between 3.5 and 14" WC.</li> <li>2. Check gas valve wire. Ensure connection is secure.</li> <li>3. Check flame detection sensor. Ensure connections are secure. Normal operating settings are more than 2.5DC before ignition, less than 2.5DC after ignition.</li> <li>4. Check igniter transformer for proper connection.</li> <li>5. Clean the spark igniter with steel wool to remove oxides. Ensure proper separation (3-4 mm).</li> <li>6. Replace the spark igniter if damaged.</li> <li>7. Assure that the flame is stable when lit.</li> <li>8. If the problem persists, replace the main control.</li> </ol>
<b>Er:16</b>	Operating Temperature Sensor Detects Water Temperature Greater than 203°F (95°C)	<p>This Error Code will go away when the DHW temperature decreases.</p> <p>If Error happens again:</p> <ol style="list-style-type: none"> <li>1. Check if dip switch High Fire setting is ON. Switches 6 and 7 should be OFF for normal operation.</li> <li>2. Check if DHW inlet pipe is blocked. Ensure there is enough water flowing to the boiler.</li> <li>3. Check DHW sensor at DHW outlet. If resistance is zero, replace the sensor.</li> <li>4. Check Operating Temperature sensor at the heat exchanger. If resistance is zero, replace the sensor.</li> <li>5. If the problem persists, replace the main control.</li> </ol> <p>NOTE: During the error state, the pump will operate to cool the boiler until the temperature is below 192°F.</p>
<b>Er:20</b>	Condensate - Closed is Normal, Open is Fault (Condensate Drain Trap)	<p>Press the Power button to clear the Error Code.</p> <ol style="list-style-type: none"> <li>1. Check Condensate and main controller connections. Ensure all are secure.</li> <li>2. Check Condensate resistance. If resistance is not zero, replace the switch.</li> <li>3. Check Condensate hose. Ensure it is connected and in good condition.</li> <li>4. Check condensate line and termination for blockages.</li> <li>5. Check exhaust vent for blockages.</li> <li>6. If the problem persists, replace the main control.</li> </ol>
<b>Er:28</b>	Overheat Sensor Open or Short	<p>This Error Code will go away when CH temperature decreases.</p> <p>If Error happens again:</p> <ol style="list-style-type: none"> <li>1. Check overheat temperature sensor. Ensure connections are secure.</li> <li>2. Check overheat sensor resistance. If resistance is zero, replace the sensor.</li> <li>3. If the problem persists, replace the main control.</li> </ol>
<b>Er:29</b>	APS - Closed is Normal, Open is Fault	<p>Press the Power button to clear the Error Code.</p> <ol style="list-style-type: none"> <li>1. Check APS and main controller connections. Ensure all are secure.</li> <li>2. Check APS resistance. If resistance is not zero, replace the switch.</li> <li>3. Check APS hose. Ensure it is connected and in good condition.</li> <li>4. Check condensate line and termination for blockages.</li> <li>5. Check exhaust vent for blockages.</li> <li>6. If the problem persists, replace the main control.</li> </ol>

Error Code	Error Code Description	Possible Remedies
Er:31	Return Temperature Sensor Open or Short	This Error Code will go away when operating temperature decreases. If Error happens again: 1. Check return temperature sensor. Ensure connections are secure. 2. Check return sensor resistance. If resistance is zero, replace the sensor. 3. If the problem persists, replace the main control.
Er:32	DHW Sensor Open or Short	This Error Code will go away when outlet DHW temperature decreases. If Error happens again: 1. Check DHW outlet temperature sensor. Ensure connections are secure. 2. Check sensor resistance. If resistance is zero, replace the sensor. 3. If the problem persists, replace the main control.
Er:33	CH Temperature Sensor Open or Short	This Error Code will go away when CH temperature decreases. If Error happens again: 1. Check CH temperature sensor. Ensure connections are secure. 2. Check sensor resistance. If resistance is zero, replace the sensor. 3. If the problem persists, replace the main control.
Er:35	Exhaust Sensor Open or Short	This Error Code will go away when exhaust temperature decreases. If Error happens again: 1. Check exhaust temperature sensor. Ensure connections are secure. 2. Check sensor resistance. If resistance is zero, replace the sensor. 3. Check exhaust vent for blockage. 4. If the problem persists, replace the main control.
Er:36	Abnormal Supply Voltage	Supply voltage is too high to operate. This Error Code will go away when supply voltage returns to normal operating range. If Error happens again: 1. Ensure boiler is properly wired to a power source meeting the requirements on the rating plate. 2. If problem persists, replace the main control.
Er:37	Abnormal Supply Frequency	Supply frequency is too high to operate. This Error Code will go away when supply frequency returns to normal operating range. If Error happens again: 1. Ensure boiler is properly wired to a power source meeting the requirements on the rating plate. 2. If problem persists, replace the main control.
Er:38	Error Appears When Control Stores Data, but Data is not Saved	Press the Power button to clear the Error Code. Replace the main control.
Er:41	Fan Speed too high with flame on	The Error Code will go away unless it occurs five (5) times in ten (10) minutes. Press the Power button to clear the Error Code. If Error happens again: 1. Check the vent connections for blockages. 2. Check the burner assembly. 3. Check fan operation. If fan appears to be operating normally but RPMs are too low or too high, replace the fan. 4. If the problem persists, replace the main control.
Er:42	Jumped wire disconnected	Press the Power button to clear the Error Code. If Error happens again: 1. Ensure that the jumper wire is installed and properly connected. 2. If the problem persists, replace the main control.
Er:43	Burner overheat switch open	Press the Power button to clear the Error Code. If Error happens again: 1. Check burner overheat switch connections. Ensure connections are secure. 2. Check switch resistance. If resistance is not zero, replace the switch. 3. If the problem persists, replace the main control. <b>NOTE:</b> During the error state, the fan will operate to cool the burner until the switch closes.
Er:61	Fan Speed Feedback Signal Abnormal	This Error Code will go away when the condition is remedied. If Error happens again: 1. Check the connections to the fan. Ensure all are secure. 2. If the fan does not rotate during the ignition sequence, check for 8Vac 26.5Vac power at the fan connection. If 8Vac 26.5Vac power is present at the control, replace the fan. If the blower does not have 8Vac 26.5Vac power, check power at the control. If 8Vac 26.5Vac power is not present at the control, replace the control. 3. If the problem persists, replace the main control.
Er:66	Mixing Valve Initial Value Error (Mixing Valve Cannot Return to Initial Position)	This Error Code will go away when the condition is remedied. If Error happens again: 1. Turn power OFF and ON at the main power switch internal to the boiler. 2. Check wiring connections to mixing valve. Ensure all are secure. 3. Replace mixing valve. 4. If the problem persists, replace the main control.

Error Code	Error Code Description	Possible Remedies
<b>Er:68</b>	Mixing Valve Operation Error (Mixing Valve Stuck in Initial Position)	This Error Code will go away when the condition is remedied. If Error happens again: 1. Turn power OFF and ON at the main power switch internal to the boiler. 2. Check wiring connections to mixing valve. Ensure all are secure. 3. Replace mixing valve. 4. If the problem persists, replace the main control.
<b>Er:70</b>	Register, Ram, Rom, I/O Port, AD Abnormal, Important EPROM Data or Safe Data Abnormal	This Error Code will go away when the condition is remedied. If Error happens again: 1. Turn power OFF and ON at the main power switch internal to the boiler. 2. If the problem persists, replace the main control.
<b>Er:72</b>	Flame Signal Detected before Ignition	This Error Code will go away when the condition is remedied. If Error happens again: 1. Check the boiler cover. Ensure it is secure. Flame detection sensor can detect an external light source. 2. Check flame detection sensor. Ensure connections are secure. Normal operating settings are more than 2.5DC before ignition, less than 2.5DC after ignition. 3. If the problem persists, replace the main control.
<b>Er:76</b>	Poor Communication	This Error Code will go away when the condition is remedied. If Error happens again: 1. Check connections from main control to display panel (error occurs if there is no communication for ten [10] minutes). 2. If the problem persists, replace the display and/or the main control.
<b>Er:77</b>	Outdoor Sensor Shorted	The Error Code will go away when the condition is remedied. If Error happens again: 1. Check outdoor sensor. Ensure all wiring connections are intact and secure. If the sensor wires were secured to the wall with staples, the wires may have been damaged. 2. Check outdoor sensor resistance. If resistance is zero, replace the sensor. 3. If the problem persists, replace the outdoor sensor. <b>NOTE:</b> When this error occurs, the boiler will still operate at the max setting of the Outdoor Reset Curve.
<b>Er:80</b>	Low Water Level Sensor (Low Water Level Detected four [4] Consecutive Times)	This Error Code will go away when the condition is remedied. If Error happens again: 1. Ensure all valves are open to the boiler and there are no leaks. 2. Ensure all air has been purged from the system. 3. Check wiring connections to low water level sensor. Ensure all are secure. 4. Check low water level sensor resistance. If resistance is zero, replace the sensor. 5. If the problem persists, replace the main control.
<b>Er:81</b>	Low Water Level Circuit	This Error Code will go away when the condition is remedied. If Error happens again: 1. Ensure the system is filled with water. Ensure all valves are open to the boiler and there are no leaks. 2. Check wiring connections to low water level sensor. Ensure all are secure. 3. Check low water level sensor resistance. If resistance is zero, replace the sensor. 4. If the problem persists, replace the main control.
<b>Er:85</b>	Freeze Protection (Boiler has detected water temperature below 34°F [1°C])	This Error Code will go away when the freezing condition is remedied. If Error happens again: 1. Ensure boiler is located in a mechanical room protected from freezing conditions. 2. Ensure all valves are open to the boiler, there are no leaks. 3. Check wiring connections to low water level sensor. Ensure all are secure. 4. Check low water level sensor resistance. If resistance is zero, replace the sensor. 5. If the problem persists, replace the main control.
<b>Er:94</b>	Exhaust NTC detects Vent Temperature is Greater than 190°F (88°C)	This Error Code will go away when the condition is remedied. If Error happens again: 1. Check if dip switch High Fire setting is ON. Switches 6 and 7 should be OFF for normal operation. 2. Check exhaust temperature sensor. Ensure connections are secure. 3. Check sensor resistance. If resistance is zero, replace the sensor. 4. Check exhaust vent for blockage. 5. If the problem persists, replace the control. 6. If the problem persists, replace the heat exchanger.

**Table 30 - Error Codes and Suggested Corrective Actions**

## **WARNING**

This boiler is equipped with a blocked vent shutoff system. If Error Codes Er:29, Er:41, Er: 42, or Er:94 occur, turn off the gas valve at the manual shutoff. Check the vent terminations for obstructions. If no obstructions are found, reset the boiler by pressing the power button. If the error continues to occur, call a qualified service technician or the gas supplier to check the boiler. Failure to follow these instructions could result in property damage, personal injury, or death.

**B. Error Tree Analysis**  
**1. Flame Detection**

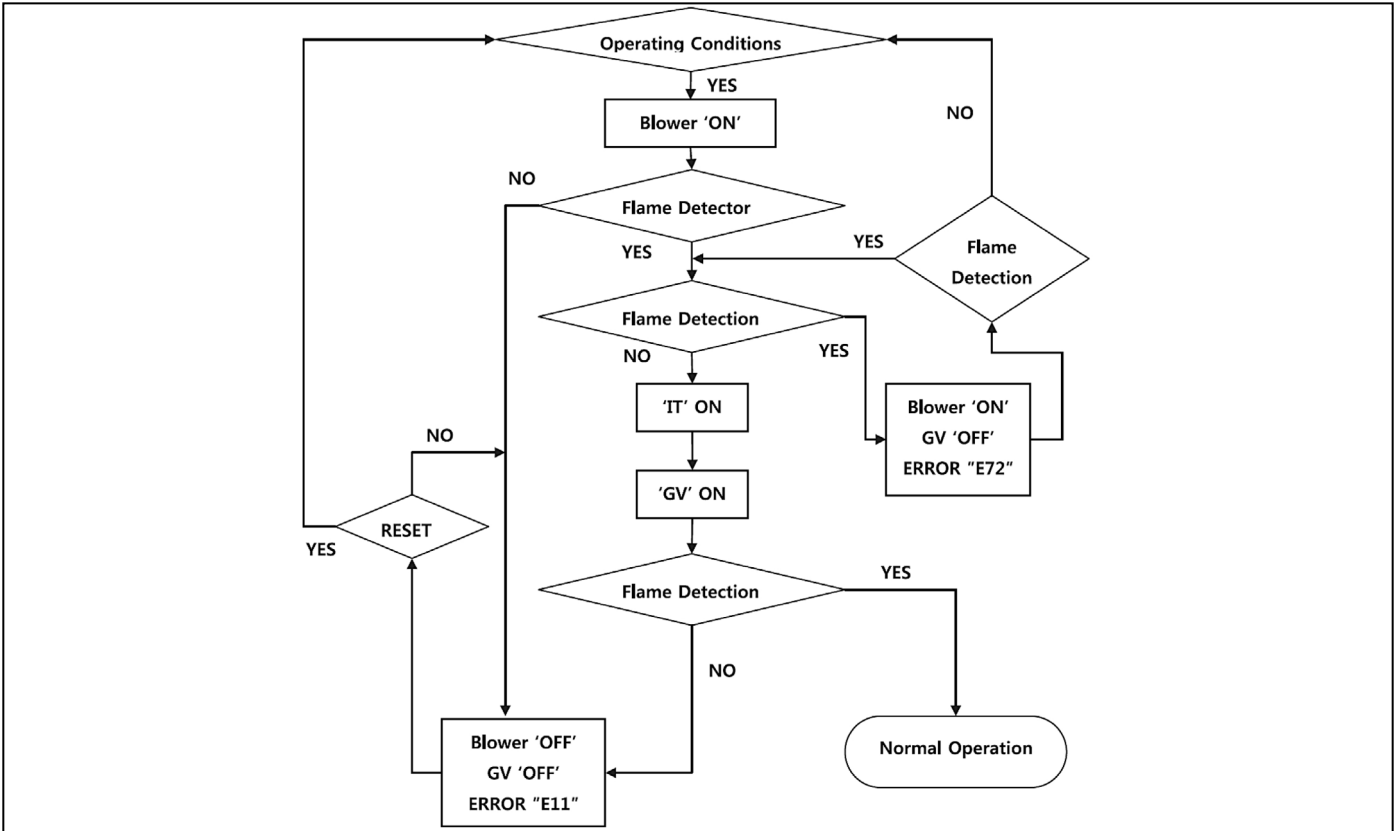

Figure 50 - Flame Detection Error Analysis Tree

**2. Air Pressure Switch / Burner Overheat Limit / Condensate Block Switch**

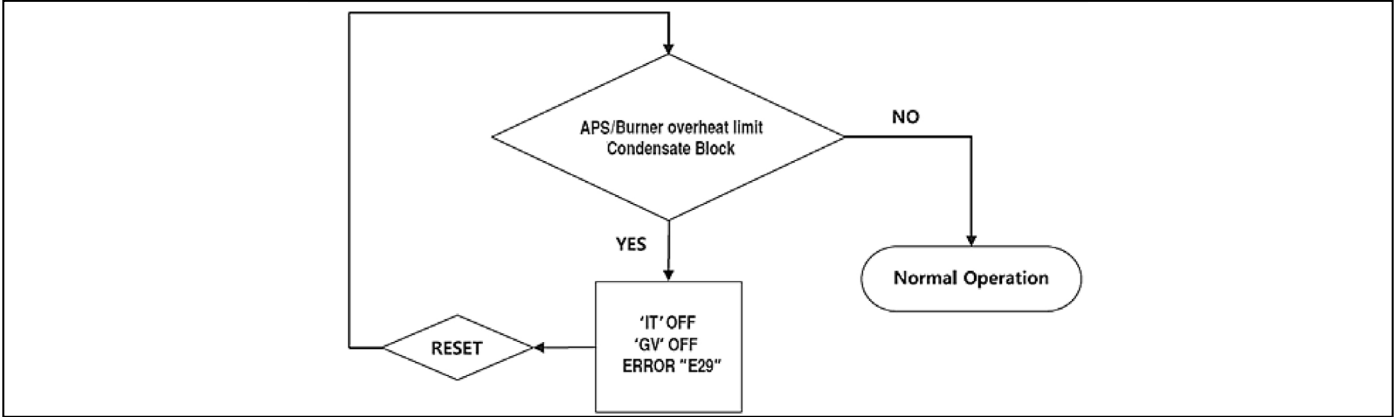

Figure 51 - APS / Burner Overheat Limit / Condensate Block Switch Error Analysis Tree

**3. DHW / Operating Temperature / CH Overheat / Exhaust Sensors**

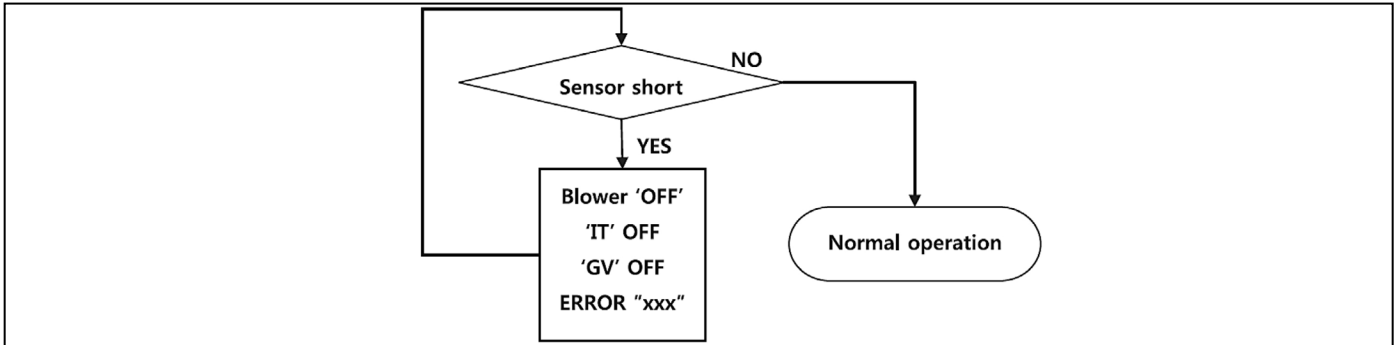

Figure 52 - DHW / Operating Temperature / CH Overheat / Exhaust Sensors Error Analysis Tree

### C. Suggested Corrective Actions

Problem	Possible Causes	Possible Remedies
No electrical power to the boiler	<ol style="list-style-type: none"> <li>1. Is the plug on the power supply cord unplugged from the electrical outlet?</li> <li>2. Is electrical panel's 10 Amp circuit breaker tripped?</li> <li>3. Is the fuse on the circuit board good?</li> <li>4. Is there a power outage to the home?</li> </ol>	<ol style="list-style-type: none"> <li>1. Reset the plug.</li> <li>2. Reset the circuit breaker.</li> <li>3. If the display panel is blank, unplug the unit or contact a qualified service technician.</li> <li>4. Contact the power company.</li> </ol>
No water available when faucet is opened	<ol style="list-style-type: none"> <li>1. Is the water supply valve shut off at the meter (do cold water faucets work)?</li> <li>2. Is the water supply valve near the unit open?</li> <li>3. Is the water pipe frozen?</li> <li>4. Is an error code flashing on the display panel (leak detected)?</li> </ol>	<ol style="list-style-type: none"> <li>1. Open the closed supply valve.</li> <li>2. Open the water supply valve.</li> <li>3. Turn OFF the unit, close all water valves and the gas valve. Contact a qualified service technician.</li> <li>4. Refer to error code information and contact an qualified service technician.</li> </ol>
Hot water is not available when the faucet is opened	<ol style="list-style-type: none"> <li>1. Does the boiler have power (plugged in)?</li> <li>2. Is the boiler turned ON?</li> <li>3. Is an error code flashing on the display panel?</li> <li>4. Is the gas supply valve open or shut off at the meter (do other gas devices work)?</li> </ol>	<ol style="list-style-type: none"> <li>1. Restore electrical power to the unit.</li> <li>2. Press and hold the <b>Power</b> button to turn the unit ON.</li> <li>3. Refer to the Diagnostic and Error Codes section in this manual.</li> <li>4. Open the gas supply valve.</li> </ol>
The water temperature is not hot enough or turns cold during use	<ol style="list-style-type: none"> <li>1. Is the faucet open enough to draw at least 0.6 gallons (2.3L) per minute through the boiler?</li> <li>2. Is an error code flashing on the display panel?</li> <li>3. Is the outlet water temperature set too low?</li> </ol>	<ol style="list-style-type: none"> <li>1. Open the faucet to allow more water flow.</li> <li>2. Refer to the Diagnostic and Error Codes section in this manual.</li> <li>3. Adjust the outlet water temperature (refer to the procedure in this manual).</li> </ol>
It takes a long time before hot water flows from the faucet	Is the faucet some distance from the boiler?	<ol style="list-style-type: none"> <li>1. Allow time for the cold water already in the pipes to flow from the faucet.</li> <li>2. Have recirculation valves and/or plumbing return line(s) installed and program the unit for recirculation mode.</li> </ol>
Domestic hot water is too hot or not hot enough	Is the water temperature set too high or low?	Adjust the temperature setting
House is not heating up	Is the CH temperature set too low?	Adjust the temperature setting.
A fan can be heard even when the unit is not operating	<ol style="list-style-type: none"> <li>1. The fan continues to operate after the burner shuts off to clear the exhaust vent of combustion gases.</li> <li>2. The fan may run to help prevent freezing.</li> </ol>	<ol style="list-style-type: none"> <li>1. This is normal operation – no action is required.</li> <li>2. Protect the boiler from freezing temperatures or shut off and drain the unit.</li> </ol>
White "smoke" can be seen coming out of the exterior exhaust gas vent	Depending on the outside temperature, water vapor can be produced as the exhaust is vented.	This is normal operation – no action is required.
The internal pump is not running	<ol style="list-style-type: none"> <li>1. No electrical supply</li> <li>2. The capacitor is damaged.</li> <li>3. Pump is blocked by debris or dirt.</li> </ol>	<ol style="list-style-type: none"> <li>1. Check the circuit breaker.</li> <li>2. Replace the capacitor.</li> <li>3. Use a screwdriver to rotate the rotor. Clean the pump.</li> </ol>
Pump or system noise	<ol style="list-style-type: none"> <li>1. There is air in the system.</li> <li>2. The inlet pressure is too low.</li> </ol>	<ol style="list-style-type: none"> <li>1. Bleed / purge air from the pump / system.</li> <li>2. Increase the inlet pressure.</li> </ol>

**Table 31 - Troubleshooting Chart**

#### DIAGNOSTICS AND SUGGESTED CORRECTIVE ACTIONS

The boiler control is able to record information about the boiler's condition at the time of the ten previous faults or errors. This information is available to view in the Installer Mode under the History screen.

The following screens may be displayed when reviewing the boiler history. The table below also includes diagnostic information and possible corrective actions.

Display	Condition	Diagnostic	Possible Corrective Actions
Nothing appears on the display control panel but the fan runs at full speed	Control is not receiving power	Check wiring for short circuit or incorrect wiring	Correct wiring per wiring diagram including connection of transformer to the control.
		Check transformer connection to the control per wiring diagram. Check for 12V output of panel wire.	Push the Power button on the control panel. Replace transformer if it is receiving 120V, but not outputting 12 VAC.



Display	Condition	Diagnostic	Possible Corrective Actions
Nothing appears on the display control panel and no other boiler components are operating	Control is not receiving 120V power	Ensure service switch and/or circuit breaker to boiler is turned ON	Turn on service switch or circuit breaker to power boiler
		Is there 120V at the service switch	Troubleshoot and correct the power supply to the manual switch
		Is the ON/OFF switch inside the boiler cabinet is turned on	Turn ON the manual power switch inside the boiler cabinet
		Check for 120V at the line voltage terminal block located inside the boiler cabinet	Correct wiring inside the boiler cabinet using the wiring diagram in the installation manual
		Inspect the fuse. Replace as necessary	Replace the fuse with the proper part found in the replacement part section of this manual. If fuse blows again, recheck the wiring per diagram
Nothing appears on the display control panel, but the boiler is operating	Occurs when communication is lost from the control to the display	Check for loose connections and proper pin alignment / engagement on the control's plug	Check for continuity on the wire harness from the display to the control. See repair parts section for proper replacement part.
		Cycle power off and on using boiler power switch and check for operation	Replace with new display module. See repair parts section for proper replacement part.
Display repeatedly goes through initialization sequence	Occurs when control does not receive signal from fan	Cycle power off and on using boiler power switch and check for operation	Replace fan

Table 32 - Diagnostics and Suggested Corrective Actions

CH Return Temperature Sensor (7855P-097) Exhaust Temperature Sensor (7850P-070) Storage Tank Temperature Sensor (7855P-057)		CH Supply Temperature Sensor (7855P-030) DHW Temperature Sensor (7855P-094)		Outdoor Temperature Sensor (7855P-084)	
Temperature (°F)	Resistance (Ω)	Temperature (°F)	Resistance (Ω)	Temperature (°F)	Resistance (Ω)
-4	62162	-4	28409	-4	99200
5	48440	5	22152	5	74229
14	38045	14	17408	14	56090
23	30107	23	13782	23	42790
32	23998	32	10990	32	32930
41	19261	41	8824	41	25550
50	15562	50	7131	50	19990
59	12655	59	5800	59	15760
68	10353	68	4747	68	12510
77	8520	77	3906	77	10000
86	7051	86	3233	86	8050
95	5867	95	2690	95	6520
104	4908	104	2250	104	5310
113	4125	113	1891	113	4350
122	3485	122	1598	122	3590
131	2957	131	1356		
140	2520	140	1155		
149	2157	149	989		
158	1854	158	850		
167	1600	167	733		
176	1386	176	635		
185	1205	185	552		
194	1051	194	482		
203	920	203	421		
212	808	212	370		

Table 33 - Temperature Sensor Resistance

## Part 11 - Start-Up

### CAUTION

Thoroughly clean and flush any system that has used glycol before installing the boiler. Provide the customer with a material safety data sheet (MSDS) on the fluid used.

### A. Check / Control Water Chemistry

### CAUTION

Chemical imbalance of the water supply may affect efficiency and cause severe damage to the boiler and associated equipment. It is important that the water chemistry on both the domestic hot water and central heating sides are checked before installing the boiler. Water quality must be professionally analyzed to determine whether it is necessary to treat the water. Various solutions are available to adjust water quality. Adverse water quality will affect the reliability of the system. In addition, operating temperatures above 135°F will accelerate the build-up of lime scale and possibly shorten boiler service life. Failure of a boiler due to lime scale build-up, low pH, or other chemical imbalance IS NOT covered by the warranty.

To ensure extended service life, it is recommended to test water quality prior to installation. Listed below are some guidelines.

### CAUTION

Do not use petroleum-based cleaning or sealing compounds in the boiler system. Damage to elastomer seals and gaskets in the system could occur, resulting in substantial property damage.

The water must be potable, free of corrosive chemicals, sand, dirt, and other contaminants. It is up to the installer to ensure the water does not contain corrosive chemicals or elements that can damage the heat exchanger. Potable water is defined as drinkable water supplied from utility or well water in compliance with EPA secondary maximum contaminant levels (40 CFR Part 143.3). If the water contains contaminants higher than outlined by the EPA, water treatment is recommended and additional, more frequent maintenance may be required. See Table 1.

If you suspect that your water is contaminated in any way, discontinue use of the boiler and contact an authorized technician or licensed professional.

Contaminant	Maximum Allowable Level
Total Hardness (Residential Use - Below 140°F water temperature)	200 mg/l (12 grains/gallon)
Total Hardness (Commercial Use - Above 140°F water temperature)	120 mg/l (7 grains/gallon)
Aluminum	0.05 to 0.2 mg/l or PPM
Chloride	100 mg/l or PPM
Copper	1 mg/l or PPM
Iron	0.3 mg/l or PPM
Manganese	0.05 mg/l or PPM
pH	6.5 - 8.5
Sulfate	205 mg/l or PPM
Total Dissolved Solids (TDS)	500 mg/l or PPM
Zinc	5 mg/l or PPM
Dissolved Carbon Dioxide (CO <sub>2</sub> )	15 mg/l or PPM

Table 34 - Water Quality Specifications

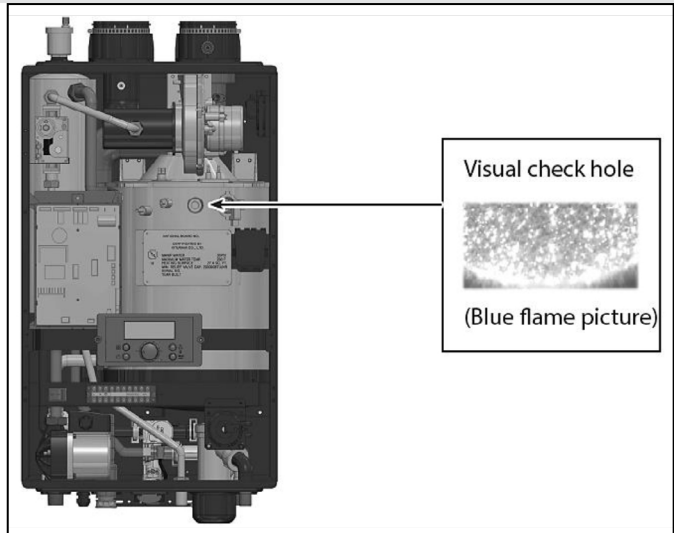

Figure 53 - Flame Sight Glass

**\*NOTE:** It is recommended to clean the heat exchanger at least once a year to prevent lime scale buildup. To clean the heat exchanger, follow the maintenance procedure in this manual.

### Clean system to remove sediment\*

1. You must thoroughly flush the system (without boiler connected) to remove sediment. The high-efficiency heat exchanger can be damaged by buildup or corrosion due to sediment.
2. For zoned systems, flush each zone separately through a purge valve. (If purge valves and isolation valves are not already installed, install them to properly clean the system.)
3. Check return Y strainer (if installed). Remove and clean sediment and debris if necessary.
4. Flush system until water runs clean and you are sure piping is free of sediment.

**NOTE: Boiler failure due to improper water chemistry is not covered by warranty.**

### B. Check for Gas Leaks

### WARNING

Before starting the boiler, and during initial operation, smell near the floor and around the boiler for gas odor or any unusual odor. Remove boiler front door and smell interior of boiler enclosure. Do not proceed with startup if there is any indication of a gas leak. Repair any leaks at once.

PROPANE Boilers ONLY – The propane supplier mixes an odorant with the propane to make its presence detectable. In some instances the odorant can fade, and the gas may no longer have an odor. Before startup (and periodically thereafter), have the propane supplier verify the correct odorant level in the gas.

If you discover any evidence of a gas leak, shut down the boiler at once. Find the leak source with a bubble test and repair immediately. Do not start the boiler again until the leak is repaired. Failure to comply could result in substantial property damage, severe personal injury, or death.

### C. Freeze Protection (When Used)

#### WARNING

NEVER use automotive or standard glycol antifreeze. Do not use ethylene glycol made for hydronic systems. Use only freeze-protection fluids certified by fluid manufacturer as suitable for use with stainless steel boilers, verified in the fluid manufacturer's literature. Thoroughly clean and flush any system that has used glycol before installing the new boiler. Provide the boiler owner with a material safety data sheet (MSDS) on the fluid used.

1. Determine the freeze protection fluid quantity using total system water content following the fluid manufacturer's instructions. Remember to include expansion tank water content.
2. Local codes may require back flow preventer or actual disconnect from city water supply.
3. When using freeze protection fluid with automatic fill, install a water meter to monitor water makeup. Freeze protection fluid may leak before the water begins to leak, causing concentration to drop, reducing the freeze protection level.
4. Glycol in hydronic applications should include inhibitors that prevent the glycol from attacking metallic system components. Make certain that the system fluid is checked for the correct glycol concentration and inhibitor level.
5. The glycol solution should be tested at least once a year or as recommended by the glycol manufacturer.
6. Anti-freeze solutions expand more than water. For example: A 50% by volume solution expands 4.8% in volume for a temperature increase from 32 - 80°F, while water expands 3% over the same temperature rise. Allowances must be made in system design for expansion.
7. A 30% mixture of glycol will result in a BTU output loss of 15% with a 5% increase in head against the system circulator.
8. A 50% mixture of glycol will result in a BTU output loss of 30% with a 50% increase in head against the system circulator.

**NOTE:** BTU losses apply to both CH and DHW.

#### CAUTION

It is highly recommended to carefully follow the glycol manufacturer's recommended concentrations, expansion requirements, and maintenance recommendations (pH additive breakdown, inhibitor reduction, etc.) You must carefully calculate the additional friction loss in the system as well as the reduction in heat transfer coefficients.

### D. Fill and Test Water System

#### WARNING

Ensure the boiler is full of water before firing the burner. Failure to do so will damage the boiler. Such damage IS NOT covered by warranty, and could result in property damage, severe personal injury, or death.

1. Fill the system only after ensuring water chemistry meets the requirements listed in this manual.
2. Close the manual and automatic air vents and boiler drain valve.
3. Fill to the correct system pressure. Correct pressure will vary with each application.
  - a. Typical cold water fill pressure for a CH residential system is 12 psi.
  - b. Pressure will rise when boiler is turned on and system water temperature increases. Operating pressure of the CH system should never exceed 25 psi, and must never exceed the relief valve pressure setting.
4. At initial fill and during boiler startup and testing, check system thoroughly for leaks. Repair all leaks before proceeding further.

#### WARNING

Eliminate all system leaks. Continual fresh make-up water will reduce boiler life. Minerals can build up in the heat exchanger, reducing heat transfer, overheating the heat exchanger and causing heat exchanger failure.

5. The system may have residual substances that could affect water chemistry. After the system has been filled and leak tested, verify that water pH and chloride concentrations are acceptable by sample testing.











#### CAUTION

It is important to purge the system of air to avoid damage to the boiler.

### E. Purge Air from CH and Internal Storage Tank

#### CAUTION

**IMPORTANT!** While commissioning the system, the air vent on top of the boiler must remain fully open to allow the boiler to properly fill. Failure to keep the air vent open could lead to improper boiler and system operation.

1. Purge air from the system:
  - a. Connect a hose to the purge valve and route hose to an area where water can drain and be seen.
  - b. Close the boiler or system isolation valve between the purge valve and fill connection to the system.
  - c. Close zone isolation valves.
  - d. Open quick-fill valve on cold water make-up line.
  - e. Open purge valve.
  - f. Open the isolation valves one zone at a time. Allow water to run through the zone, pushing out the air. Run water until no noticeable air flow is present. Close the zone isolation valves and proceed with the next zone. Follow this procedure until all zones are purged.
  - g. Close the quick-fill water valve and purge valve and remove the hose. Open all isolation valves. Watch the system pressure rise to correct cold-fill pressure. It is recommended that you put the pumps into manual operation to assist in purging the circuits.
  - h. Disconnect the wires that are connected to the THERMOSTAT terminals of the terminal block. Apply power to the boiler. After the control goes through the start-up sequence, the display will turn off.
  - i. Press and hold the  button for five seconds. Then scroll to 29:AP by turning the dial . Press the  button. AP:cP will show on the display. Press the  button to change the test time. The default is five minutes. Turn the dial  counterclockwise to lower or clockwise to raise the displayed value. Press the  button again to save any changes.
  - j. Then use the dial  to scroll to cP:off. Press the  button to turn on test mode. Turn the dial  counterclockwise to lower or clockwise to select on. Press the  button again to start test mode.
  - k. The CH and internal circulation pumps will come on. To bleed air

from the internal pump:

1. Use a flat head screwdriver and turn the pump bleed screw one (1) turn counterclockwise.
2. When water comes out the pump has been bled.
3. Turn the screwdriver clockwise and reseal the bleed screw.



**Figure 54 - Bleeding the Internal Pump**

Run pumps as required to help bleed out all entrapped air. Some good indicators that air is removed include the absence of gurgling noises in the pipes and pump operation becoming very quiet. Test mode will stop automatically after the set time (default is five minutes), or press the  button to leave it manually.

- l. After the system has operated for some time, eliminate any residual air by using the manual air vents located throughout the system.
- m. If purge valves are not installed in the system, open manual air vents in the system one at a time, beginning with the lowest floor. Close vent when water squirts out. Repeat with remaining vents.
- q. Refill to correct pressure.

#### F. Purge Air from DHW System

1. Make sure CH and DHW lines to the boiler are open and full of water. Turn on all electric power to boiler.

### **WARNING**

Ensure the boiler is full of water before firing the burner. Failure to do so will damage the boiler. Such damage IS NOT covered by warranty, and could result in property damage, severe personal injury, or death.

2. Open hot water faucets in the DHW system. Start with the faucets nearest the boiler.
3. Keep faucets open until water runs freely and all air is purged. Then move on to faucets further away from the boiler in the system.
4. When water flows freely from all hot water faucets, DHW purging is complete.

#### G. Check Thermostat Circuit(s)

1. Disconnect the two external wires connected to the boiler thermostat terminals (low voltage terminal strip).
2. Connect a voltmeter across these two incoming wires with power supplied to the thermostat circuits. Close each thermostat, zone valve and relay in the external circuit one at a time and check the voltmeter reading across the incoming wires.
3. There should NEVER be a voltage reading.
4. If a voltage reading does occur under any condition, check and correct the external wiring. (This is a common problem when using 3-wire zone valves.)
5. Once the external thermostat circuit wiring is checked and corrected if necessary, reconnect the external thermostat circuit wires to the boiler low voltage terminal strip. Allow the boiler to cycle.

#### H. Condensate Removal

1. The boiler is a high efficiency condensing boiler. Therefore, the unit has a condensate drain. Condensate fluid is nothing more than water vapor, derived from combustion products, similar to that produced by an automobile when it is initially started.

Condensation is slightly acidic (typically with a pH of 3 to 5) and must be piped with the correct materials. Never pipe the condensate using steel, copper, brass or other materials that will be subject to corrosion. Plastic PVC or CPVC pipe are the only approved materials. A condensate neutralizer, if required by local authorities, can be made up of lime crystals, marble or phosphate chips that will neutralize the condensate. This may be done by the installer or you may purchase a condensate neutralizer from HTP (7450P-212).

2. The boiler is equipped with a  $\frac{3}{4}$  female socket weld fitting connection that must be piped to a local drain. It is very important that the condensate line is sloped downward away from the boiler to a suitable inside drain. If the condensate outlet on the boiler is lower than the drain, you must use a condensate removal pump, available from HTP (554200). This pump is equipped with two leads that can be connected to an alarm or another type of warning device to alert the user of a condensate overflow, which, if not corrected, could cause property damage.
3. If a long horizontal run is used, it may be necessary to create a vent in the horizontal run to prevent a vacuum lock in the condensate line.
4. Do not expose the condensate to freezing temperatures.
5. It is very important you support the condensation line to assure proper drainage.

## Part 12 - Installation Checklist

<b>Before Installing</b>	<b>Yes</b>	<b>No</b>
Is there enough space to ensure proper installation?		
Does installation location allow for proper service clearances?		
Are water and gas lines properly sized and set at proper pressures for the installation?		
Is boiler location as near the exhaust vent / intake pipe terminations as possible?		
Have combustible materials been cleared from the installation location?		
Is there a drain close to the boiler?		
<b>Water Piping</b>	<b>Yes</b>	<b>No</b>
Does boiler loop piping meet the minimum sizing requirements listed? <b>NOTE:</b> Smaller piping will cause performance problems.		
Has water chemistry been checked?		
Does water chemistry meet requirements?		
If water chemistry does not meet requirements, have treatment measures been put in place?		
Has the system been cleaned and flushed?		
<b>Install Exhaust Vent and Intake Piping</b>	<b>Yes</b>	<b>No</b>
Has the boiler been vented with the approved materials listed in this manual or to meet local codes?		
Is air supply sufficient for proper boiler operation?		
Is total vent piping length within the maximum vent length restriction listed in this manual?		
<b>Install Exhaust Vent and Intake Piping</b>	<b>Yes</b>	<b>No</b>
Have venting lengths been minimized?		
Are terminations properly spaced from windows, doors, and other intake vents?		
Have all vent terminations been installed at least one foot above exterior grade and one foot above normal snow accumulation level?		
Is vent piping properly supported?		
Has vent piping been checked for leaks?		
Has the exhaust vent line been pitched back to the boiler at a rate of 1/4" per foot?		
Have the exhaust vent and intake pipes been properly installed to the boiler?		
<b>Install Condensate Piping / Tubing and Components</b>	<b>Yes</b>	<b>No</b>
Have all condensate components included with the boiler been installed?		
Is the condensate line piped with the approved materials listed in this manual?		
Has the condensate line been routed to a laundry tub or other drain?		
<b>Install Gas Piping</b>	<b>Yes</b>	<b>No</b>
Is the gas supply line a minimum of 3/4" in diameter?		
Is the gas supply line length and diameter adequate to deliver the required BTUs?		
Has gas supply line pressure been measured (between 3.5 and 14" WC)?		
Does the gas type match the type indicated on the boiler rating plate?		
Has a union and shut-off valve been installed?		
<b>Relief Valve</b>	<b>Yes</b>	<b>No</b>
Is the CH Pressure Relief Valve rated to 30 psi properly installed and at least 1" discharge line run to open drain?		
Is the DHW Pressure Relief Valve rated to 150 psi properly installed and at least 3/4" discharge line protected from freezing?		
<b>Wiring</b>	<b>Yes</b>	<b>No</b>
Has the power and control been wired per boiler wiring diagram, this manual?		
Have all DIP switches been set on the main boiler board?		
Is the electrical connection polarity within boiler requirements?		
Does the power supply voltage agree with the boiler rating plate? 120V AC?		