

# Rex Pipe & Cable Locators

User guide



### **Important Notice**

Sc honstedt believes the statements contained herein to be accurate and reliable; however, their accuracy, reliability, or completeness is not guaranteed.

Sc honstedt's only obligation shall be to repair or replace any instrument proven to be defective within three years of purchase. Sc honstedt shall not be responsible for any injury to persons or property, direct or consequential, arising from the use of any instrument.

# Table of Contents

<b>Chapter 1: Introduction &amp; Operating Modes</b>	<b>1</b>
Introduction.....	2
Passive 50/60 Hz.....	2
Conductive .....	2
Inductive Clamp.....	2
Inductive.....	3
Sonde .....	3
Operating Recommendations .....	4
<b>Chapter 2: Rex Receiver</b>	<b>5</b>
Automatic and Manual Gain.....	6
Directional Indication.....	6
Depth Measurement .....	6
Searching for a Sonde .....	6
Controls.....	7
Visual and Audible Indicators.....	8
Connectors and Accessories .....	11
Battery Replacement .....	11
Specifications .....	12
Regulatory Compliance and Declaration of Conformity.....	13
<b>Chapter 3: Rex Transmitter</b>	<b>14</b>
Automatic and Manual Output Power.....	15
Output Current Measurement.....	15
Line Voltage and Impedance Measurement .....	15
Controls.....	16
Visual and Audible Indicators.....	17
Connectors and Accessories .....	18
Battery Charger .....	19
Recommendations for Battery Charging and Storage.....	20
Battery Replacement .....	20
Specifications .....	22
Regulatory Compliance and Declaration of Conformity.....	23
<b>Chapter 4: Technical Support/ Service Information</b>	<b>24</b>
<b>Chapter 5: Warranty</b>	<b>26</b>

# 1

## INTRODUCTION & OPERATING MODES



## Introduction

In general, pipe and cable locators can operate in a variety of modes and frequencies. The following is a brief description of the basic operating modes supported by the Rex Pipe and Cable locator. In addition, Rex offers advanced features to suit almost any type of locating challenge, while emphasizing portability, size, and convenience. The receiver collapses for portability and expands for full functionality, and the transmitter packs up to 5 watts output power, multiple frequencies, and an inductive antenna in a flat and lightweight package.

Schonstedt has incorporated more than sixty years of experience in producing products for aerospace, military and infrastructure applications in the design of our locators. All Schonstedt products are manufactured following high standards of reliability, durability and performance.

For additional information on pipe and cable locating theory and techniques, check the training section of our website at [www.schonstedt.com/training](http://www.schonstedt.com/training).

### Passive 50/60 Hz



In passive mode, the transmitter is not used at all. Instead, the receiver searches for an appropriate harmonic of 60 or 50 Hz signals (factory preset). These signals are typically present in energized power cables, making it possible to locate them without using a transmitter to impose a tracing signal onto them.

### Conductive



In conductive mode, the transmitter imposes a signal of the selected frequency onto the pipe or cable to be traced. It does so by making direct contact with the pipe or cable at a point where the pipe/cable comes up to the surface of the ground (a transformer box, a water hydrant, a telephone switch box, a gas meter, etc.). The circuit is closed by providing a return path with a stake that is buried in the ground near the transmitter.

### Inductive Clamp



In inductive clamp mode, the transmitter imposes a signal of the selected frequency onto the pipe or cable to be traced. It does so by energizing a clamp that is placed so that it is completely encircling the pipe or cable at a point where the pipe/cable comes up to the surface of the ground (a transformer box, telephone switch box, gas meter, etc.). The clamp then induces a current onto the pipe or cable. In this mode, it is not necessary to provide a return path for the induced current to the transmitter. The induced current will travel on the pipe or cable for a certain distance, making it possible to trace it.

## Inductive



In the inductive mode, the transmitter imposes a signal of the selected frequency onto the pipe or cable to be traced. It does so by energizing an inductive antenna built into the case. The transmitter is placed on the ground in a direction perpendicular to the pipe or cable being traced. The inductive antenna then induces a current onto the pipe or cable. In this mode, it is not necessary to provide a return path for the induced current to the transmitter. The induced current will travel on the pipe or cable for a certain distance, making it possible to trace it.

## Sonde



In sonde mode, the transmitter is not used at all. This mode is used to trace non-metallic pipes, or metallic pipes where other modes are inapplicable or inefficient. A small beacon transmitter, or sonde, is pushed through the pipe, and the receiver searches for the signal emitted by the sonde.

Since the signal being traced by the receiver is produced by the sonde and not travelling along the pipes, there are some differences in the way the receiver is used. Due to the nature and strength of the sonde signal, it is necessary to have some idea of where the sonde is (in order to narrow the search area to a radius of several feet centered on the sonde).



For additional information on sonde locating and techniques, check the training section of our website at [www.schonstedt.com/training](http://www.schonstedt.com/training).



Mini Sonde-512 Hz



Large Sonde-512 Hz

## Operating Recommendations

When using Rex, follow these tips and recommendations to improve and facilitate your locating experience:

- 1) Whenever possible, use the conductive mode. It provides the strongest and best coupled signal.
- 2) When operating in conductive mode:
  - Try to bury the ground stake on a line perpendicular to the utility to be traced.
  - Verify that a good circuit has been established by:
    - Checking the output current from the transmitter.
    - Manually adjusting the output power to affect the output current.
    - Making adjustments to the conductive clips to improve the connection.
- 3) When operating in the inductive mode, place the transmitter antenna (located inside the handle) over the buried cable or pipe in the direction indicated by the label (perpendicular to the suspected direction of the pipe or cable).
- 4) If using the inductive clamp mode, place the clamp so that it completely encircles the desired cable or pipe. Make sure the clamp can fully close so that both ends touch.
- 5) When operating in the passive mode, be aware of your surroundings and possible interference from overhead power lines, other buried cables, pipes or utilities carrying 50 or 60 Hz signals, and nearby transformers or substations.
- 6) In all operating modes, always set the gain at the minimum setting that shows a clear peak over the target. Optimum results will most likely be obtained with a signal strength reading between 200 and 800. A consistent reading of 995 or higher indicates the signal is too strong and the receiver gain and/or transmitter power should be reduced.

2

## REX RECEIVER





## Automatic and Manual Gain

The Rex receiver has the ability to operate in an automatic or manual gain mode. In the automatic gain mode, the sensitivity of the receiver is adjusted automatically, based on the strength of the detected signal, to produce a relatively constant and strong signal strength indication. In the manual gain mode, the user can adjust the sensitivity up or down to suit different locating scenarios.

## Directional Indication

The Rex receiver is equipped with directional indicators (arrows). These visual and audible indicators help the user locate the pipe or cable by showing which direction he/she should move in order to get closer to the target. These indicators are not available in the Sonde mode.

## Depth Measurement

The Rex receiver has the ability to measure the approximate depth of the target pipe or cable being traced. When a depth measurement is made, the receiver must be fully extended and the bottom tip of the receiver must be touching the ground. Depth measurements should only be made when the directional indication says that the target is close and the receiver's signal strength is maximized (peaked) over the target. Special considerations are required for the Sonde mode.

## Searching for a Sonde

Once in the surroundings of a sonde, it is important to differentiate whether you are positioned along the axis of the sonde (the direction of the pipe) or off to either side. In the sonde mode, the directional indication is not functional; the signal strength is the only indication available.

Rotate the receiver back and forth and move in the direction that produces the maximum (peak) signal strength. As the receiver gets closer to the sonde, the signal strength increases and it will hit a peak when the receiver is directly over the sonde. Slowly rotate the receiver to fine tune the peak signal strength, which will occur when the plane of the sensors is parallel to the axis of the sonde. For verification, rotate the receiver 90 degrees and see that it produces a "null" (signal strength very close to zero), and then counter-rotate 90 degrees to go back to the original position.

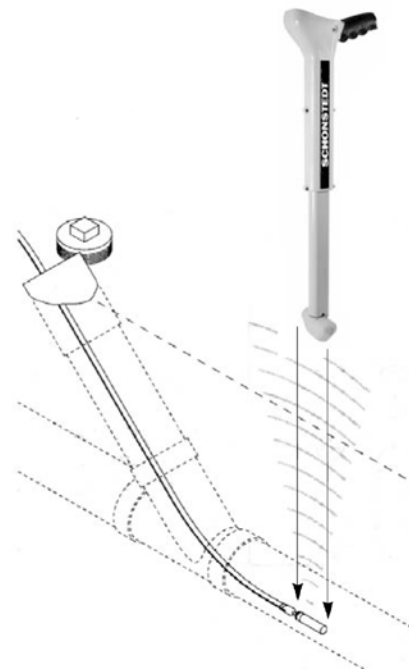

To measure depth, simply place the tip of the unit on the ground and press the DEPTH button when the signal strength is at a peak. The achievable depth depends on a number of factors, but typically it is possible to read depth up to 5 to 15 feet (1.5 to 4.2 m).

## Controls

The Rex Receiver controls are designed to be intuitive and require a minimum of training for effective use. The receiver can easily be operated with one hand.

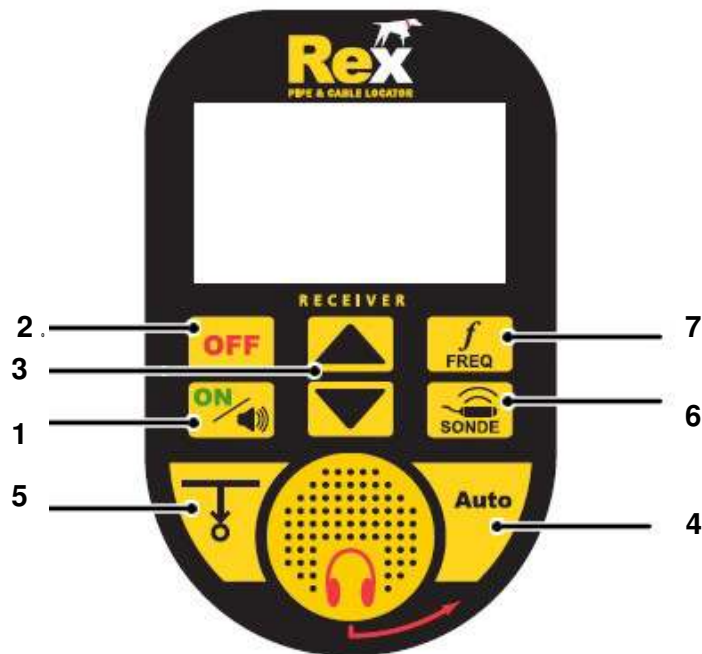

- 1 **ON/VOLUME** - This switch powers on the receiver and automatically sets the volume to High. Additional depressions of this switch will cycle the volume through Mute, Medium, and High settings.
- 2 **OFF** - This switch removes power from the receiver.
- 3 **UP/DOWN ARROWS** - When the receiver is operating in manual gain mode, pressing the UP or DOWN arrows will increase or decrease the gain from its current setting. When the receiver is operating in the automatic gain mode, the first press of the UP or DOWN arrow will switch the receiver to the manual gain mode.
- 4 **AUTO** - When the receiver is operating in the manual gain mode, pressing the AUTO button will switch the receiver to operate in the Automatic gain mode. In this mode the receiver adjusts its sensitivity as a function of the strength of the detected signal.

- 5 **DEPTH** - When the proper conditions to measure depth are present, pressing this switch will display the target's depth on the LCD (after a delay of 2 seconds). The depth will continue to be displayed on the LCD, along with the "depth symbol", for as long as the switch is depressed. If the switch is pressed and quickly released, the depth will show on the LCD momentarily. The Rex is factory set to display depth in feet and inches or in meters. If the depth cannot be determined due to a weak signal or interference signal by other nearby utilities (congested underground) the LCD will show 3 dashes "---".
- 
- 6 **SONDE** - If the sonde mode is available, pressing this switch will cause the receiver to go to the sonde mode of operation. If the receiver is already operating in sonde mode, pressing this switch will cause the receiver to stop the sonde mode of operation.
  - 7 **FREQ** - An operating frequency can be selected by depressing this switch consecutively until the desired frequency is indicated on the display of the receiver. Some frequencies are uniquely associated with the mode of operation selected (conductive, inductive or inductive clamp); therefore the user should ensure that the same frequency is selected on both the receiver and the transmitter.

## Visual and Audible Indicators

The information display areas for the receiver are easy to understand. In addition, the receiver has audible indicators to facilitate operation in heavy traffic or noisy areas. All visual indicators for the receiver are on the LCD display, which has six general areas to display information to the user: a Battery Indicator, a Gain Indicator, a Frequency/Mode Indicator, a Direction Indicator, an Alphanumeric Display and a Volume Indicator.

- **BATTERY INDICATOR** - The battery symbol indicates the receiver's battery status. When all 3 segments inside the battery symbol are present, the battery is fully charged. When only the 2 bottom segments are present, the battery has a medium charge. When only the bottom segment is present, the battery has a low charge and should be replaced. If there are no segments present, the battery is extremely low and you should replace it immediately.



- **GAIN INDICATOR** - The "Ⓐ" indicates that the gain is in the automatic mode. In this mode, the receiver adjusts its sensitivity as a function of the strength of the detected signal. No bar graph is shown in this mode.



If the "Ⓐ" is not visible, the receiver is operating in the manual gain mode; therefore, a means to show the user the relative gain setting is necessary. The bar graph indicates the relative strength of the gain.

Each time the UP or the DOWN arrow is pressed, the gain is adjusted by 1/30th of the full scale range and the gain level, preceded with an “L”, is shown temporarily to the user on the main signal display. The bar graph will change with approximately 6 presses of the UP or DOWN arrow. The user may press and hold the UP and DOWN button to change the gain rapidly.

- **FREQUENCY/MODE INDICATOR** – The upper left of the LCD consists of 4 icons: "512 Hz", "33 kHz", "82 kHz", and "Passive Arrow". The lower center of the LCD contains the "SONDE" icon.

These icons are used by themselves, or in various combinations to indicate different operating modes, as shown in the following table, where (C) is conductive mode, (IC) is inductive clamp mode, and (I) is inductive mode. See CHAPTER I: REX OPERATING MODES for a description of these modes.

OPERATING MODE	SONDE	33 kHz	82 kHz	512 Hz	PASSIVE ARROW
C, IC, I at 33 kHz	Off	On	Off	Off	Off
C, IC, I at 82 kHz	Off	Off	On	Off	Off
C at 512 Hz	Off	Off	Off	On	Off
Sonde (*)	On	Off	Off	On	Off
Passive 50/60 (**)	Off	Off	Off	Off	On

(\*) *The default sonde frequency is 512Hz. Rex has the capability to locate a number of alternate legacy Schonstedt sonde frequencies. For more information on these and how they are displayed, contact the factory.*

(\*\*) *The number 50 or 60 shows briefly on the numeric display upon entering this mode, indicating which line frequency the unit is programmed to locate in passive mode.*

- **DIRECTION INDICATOR** - The arrows and center bar in this indicator tell the operator in which direction to move the receiver in order to be directly over the target. The direction indicator does NOT work in the Sonde operating mode.



- **Right Arrow** - Receiver should be moved to the right to get closer to the target.
- **Left Arrow** - Receiver should be moved to the left to get closer to the target.
- **Both Arrows and Center Bar** - Receiver is placed close to or directly over the target. This is also accompanied by a beeping sound.

When all three elements of this indicator are OFF, the signal strength is not adequate to make a directional determination or you are not close to the pipe or cable being traced. Keep searching based on the signal strength indication and the audio feedback, until one of the arrows comes ON.

- **ALPHANUMERIC DISPLAY** - The alphanumeric display is used to display signal strength and depth. The numeric display is also used for temporary indications of certain operating modes, frequencies, and other brief information messages, as noted throughout this manual.

- **Signal Strength** - This is an indication of the relative signal level detected by the receiver and is a function of the gain setting. Good signal strength will typically be between 200 and 800.

The display range for signal strength is 0 to 999; however, very high signal strength is not necessarily better. If readings of 995 or higher are consistent, the signal is too strong and steps should be taken to reduce it. If a reading of "OL" is observed, a signal is present which interferes with the signal the receiver is set to detect. Steps should be taken to identify the source of interference or to change the locating mode.

- **Depth Reading** – When measuring depth, the "depth" icon lights up in the lower right of the display, and the depth of the target is displayed (in feet and inches, or meters - depending on the factory setting). The display range for depth in feet and inches is 0" to 19' 9" and in meters is 0.00 m to 5.99 m.



- **VOLUME INDICATOR** - The volume indicator consists of a speaker symbol with 3 sound wave bars. If the volume is off, the speaker symbol with NO bars is shown, for medium volume the speaker symbol with 2 bars is shown and for maximum volume the speaker symbol with 3 bars is shown.

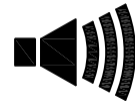

The speaker produces an audible indication of signal strength. The pitch of the sound will increase with increasing signal strength. However, the volume is determined only by the VOLUME control, as explained above.

## Connectors and Accessories

The receiver has a standard 3.5mm headphone jack that accepts any mono or stereo earphones or headphones. Schonstedt also supplies headphones as an optional accessory. The receiver automatically detects the insertion of the headphones or earphones and routes the audio signals to them, silencing the internal speaker.



The receiver comes fitted with a rubber plug to protect it from water and dust ingress. It is recommended to keep the rubber plug inserted in the earphone jack when earphones are not being used. The receiver also comes standard with a belt holster for hands-free carrying.



The receiver is shipped factory ready to detect sondes or other devices, such as inspection cameras, that transmit at 512 Hz; however, the sondes themselves are optional accessories also available through Schonstedt.

## Battery Replacement

The Rex receiver is powered by one 9-volt alkaline disposable battery. The battery is located in the handle of the instrument and can be accessed by turning the screw counterclockwise. To remove the battery, simply tilt the unit so that the handle is pointing down, and the battery will slide out. When replacing the battery, look at the outside of the battery door for the proper battery orientation. As a safety measure the unit will not turn on if the battery is not inserted correctly. You should never have to force the battery door closed. If the battery does not seem to be going in all the way, remove the battery, reverse its orientation and then replace it.

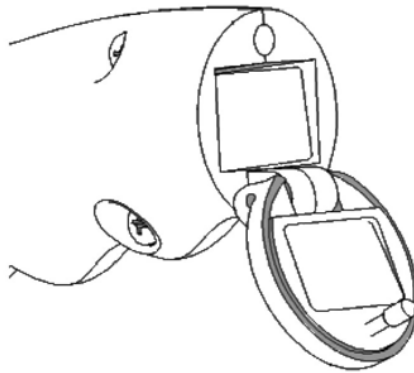

## Specifications

Operating Frequency:	Active: 512 Hz, 33 kHz and 82 kHz Passive: 50 or 60 Hz Sonde: 512 Hz
Battery:	One 9V Alkaline Battery
Battery Life:	12 hours (intermittent use)
Audio Output:	10 - 1500 Hz (determined by signal strength) 0 - 70 db SPL (volume controlled)
Weight (incl. battery):	2.8 lbs. (1.25 kg)
Operating Temperature:	-4°F to 140°F (-20°C to 70°C)
Water and Dust Resistance	Rated IP54
Overall Dimensions:	Closed: 17.5" x 3" x 8.5" (44 cm x 7.6 cm x 21.5 cm) Extended: 27.7" x 3" x 8.5" (70 cm x 7.6 cm x 21.5 cm)
Max. Depth Capability:	Approximately 19' (5.8 m) Sonde Mode: approximately 5'- 15' (1.5 m – 4.2 m)

## Regulatory Compliance and Declaration of Conformity

FCC:

++++

This device complies with Part 15 of the FCC Rules. Operation is subject to the following two conditions: (1) this device may not cause harmful interference, and (2) this device must accept any interference received, including interference that may cause undesired operation.

++++

Industry Canada:

+++++

CAN ICES-3 (B)/NMB-3(B)

CE Mark:

+++++

Application of Council Directive(s): Directive  
1999/5/EC (R&TTE Directive)

Standard(s) to which Conformity is declared:

ETSI EN 301 489-1 V1.9.2 (2011-09)

ETSI EN 301 489-3 V1.6.1 (2013-08)

ETS1 EN 300 330-2 V1.6.1 (2015-03)

Directive 2011/65/EU (RoHS2)

Standard to which conformity is declared: EN  
50581:2012

This device should only be cleaned using a dry cloth. Do not use any solvents that could damage the labels.



Schonstedt's Declaration of Conformity can be found at:

[www.schonstedt.com/rex](http://www.schonstedt.com/rex)



# 3

## REX TRANSMITTER



## **Automatic and Manual Output Power**

The Rex transmitter delivers power to the "load" that it is connected to. In the conductive mode, the load is the circuit formed by the cable or pipe being traced, the soil return, and the ground stake. In the inductive clamp and inductive modes, the loads are the clamp and the antenna, respectively. The inductive clamp and inductive modes require the maximum power that the transmitter can deliver. Therefore, the transmitter automatically operates at maximum power output, and there is no need for manual power adjustment.

In the conductive mode, the power delivered to the load is highly dependent on the external elements (soil, type of conductor, stake placement, etc.). In some cases, more power is desired to achieve more distance or depth; in other cases, less power is desired to avoid bleeding to nearby conductors. Therefore, while in the conductive mode, the user has the ability to adjust the output power manually, using the front panel controls and visual indicators described further down in this manual.

## **Transmitter Current Measurement**

When operating in the conductive mode, the Rex transmitter displays the amount of current flowing into the utility being traced. This is very useful in determining how good of a circuit has been established by the operator. The circuit can be improved by relocating the ground stake or improving the metal to metal contact of the conductive clips. A low current reading indicates a poor trace conductor, poor soil conductivity, or poor ground stake contact/placement. Higher current readings indicate a better circuit and a better chance at tracing long distances and deep conductors.

If the current reading is low, try improving the connection to see if the current increases (check the cables, clips, and ground stake; wet the ground; clean rust or dirt; etc.). Often, the reason for the low current is the soil itself (sandy or very dry) and/or the conductive quality and integrity of the pipe or cable that is being traced (cast iron pipes, rusted or broken wires, heavy insulation to ground, etc.). If an improved connection cannot be made, there may be a small amount of current still circulating in the circuit. Try increasing the output power manually and/or increase the gain on the receiver.

## **Line Voltage and Impedance Measurement**

When the transmitter is operating in conductive mode and a new frequency is entered, it performs an automatic measurement of the AC and DC voltages that are present on the line to be traced. If the voltage measured on the line is below 5 volts (DC or AC), then the measurement is transparent to the user and the transmitter proceeds to transmit the desired signal onto the line. If the voltage is above 5 V (DC or AC), an UP ARROW will be shown on the LCD display and the buzzer will be turned on to warn the user of the presence of voltage on the line. The transmitter will continue to retest for the presence of these voltages until they fall below 5 V, in which case it will resume normal signal transmission.

To determine the type (AC or DC) and value of the voltage present on the line, and to measure the line impedance, the transmitter can be put into the Measurement mode by simultaneously pressing the Frequency and Output Power controls while in the conductive mode.

In the Measurement mode, the transmitter alternatively displays the DC voltage, AC voltage, and Line Impedance on the LCD; it will turn on an UP ARROW if any voltage exceeds 50 V. To exit the Measurement mode, press the Frequency or Output Power control. The transmitter will go back to the conductive mode.

## Controls

The Rex Transmitter controls are designed to be intuitive and require a minimum of training for effective use. The transmitter controls are also large for ease of use when wearing gloves.

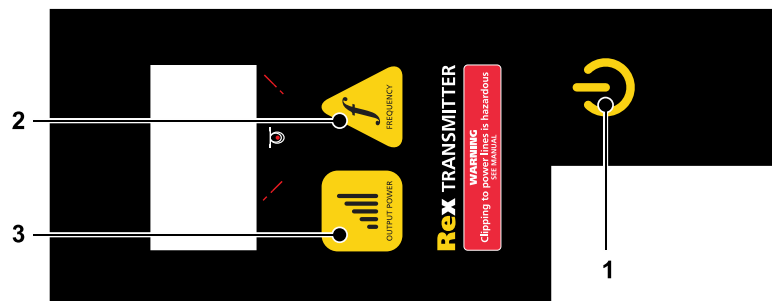

1. **ON/OFF** - This is a momentary push-button switch that toggles the power to the transmitter on and off. When the transmitter power is off, press this switch until the LCD indicators come on and you hear a beep, and then release it. When the transmitter power is on, press the switch until the LCD indicators go off, and then release it.
2. **FREQUENCY** - An operating frequency can be selected by depressing this switch consecutively until the desired frequency that matches the receiver's frequency is indicated on the display of the transmitter. Different frequencies are available for the different operating modes (conductive, inductive clamp or inductive); see Specifications below for specific frequencies in each mode.
3. **OUTPUT POWER** - Used to manually select the output power in the conductive mode only, this control has no use in the inductive and inductive clamp modes, where the output power is internally fixed. Each press increases the output power as follows:
  - 1 bar = 0.5W
  - 2 bars = 1 W
  - 3 bars = 2 W
  - 4 bars = 5 W

At the 82 kHz operating frequency, only 1/2 watt and 1 watt are available; this is due to FCC regulations. If the transmitter is operating at a higher output power (2 W or 5 W) and the frequency is changed to 82 kHz, the transmitter automatically defaults to 1 W.

## Visual and Audible Indicators

The information display areas for the transmitter are easy to understand. In addition, the transmitter has an audible indicator to provide feedback and warnings to the user in certain situations.

All visual indicators for the transmitter are on the LCD display, which has four general areas to display information to the user: a battery indicator, a large 3-digit numeric display, a frequency display, a power level indicator, mode indicators, and several unit indicators.

- **BATTERY INDICATOR** - The "Battery" symbol indicates the transmitter's battery status. When all 3 segments inside the battery symbol are present, the battery is fully charged. When only the 2 bottom segments are present, the battery has a medium charge. When only the bottom segment is present, the battery has a low charge and should be recharged as soon as possible. If there are no segments present, the battery is extremely low and it should be recharged immediately. If the battery reaches a voltage dangerously close to the level where continuous operation can damage it, the empty battery box will begin to flash and transmitter shutdown is imminent. In addition, the battery indicator is used to show that the charger is plugged in correctly; the battery box will be on with all 3 segments rolling. See section **Battery Charger** below for additional information on the battery charging visual indicators.



- **3-DIGIT NUMERIC DISPLAY** - This area is used to display operating mode information as follows:



- Ind Transmitter operating in the Inductive mode
- CLA Transmitter operating in the Inductive Clamp mode
- xxx mA Transmitter operating in the Conductive mode; the display shows the output current in milliamps
- XXX A 3-digit number displayed momentarily on power up indicating the current software version (i.e. 121 = Version 1.21).

See section **Line Voltage and Impedance Measurement** for additional uses of this display area when measuring line voltage and impedance.

- **FREQUENCY DISPLAY** – The upper left of the LCD consists of 4 icons: "512 Hz", "33 kHz", "82 kHz", and "Passive Arrow". The lower center of the LCD contains the "SONDE" icon.
- **POWER LEVEL INDICATOR** – This area is a bar graph display used to display the output power level setting in conductive mode. The output power levels are displayed as follows:

1 bar	0.5 W
2 bars	1 W
3 bars	2 W
4 bars	5 W

- **MODE INDICATOR** – This area consists of arrow indicators on the bottom of the screen, which point to an icon on the label which indicates whether the transmitter is in conductive, clamp, or inductive mode.
- **UNITS INDICATORS** - During normal operation, or when the Rex transmitter is measuring line voltage and impedance, it is necessary to display information to the user with the appropriate units. The indicators on the LCD are as follows:

KΩ	kilo ohm = 1000 ohms
A	ampere, an electrical current measurement unit
mA	milliampere = 1/1000 ampere
Hz	hertz, a frequency measurement unit
kHz	kilohertz = 1000 hertz

## Connectors and Accessories



**OUTPUT CONNECTOR** - This 1/4" phone jack is used to connect the conductive clips or the optional inductive clamp to the transmitter. The transmitter automatically detects what accessory has been plugged in and adjusts its operation and indicators accordingly. It is recommended that you turn the transmitter's power OFF before removing or inserting accessories from/into this connector or connecting to a utility. The connector is covered with a spring-loaded plastic cap to prevent water and dust from damaging the transmitter.



### CAUTION

Do not connect conductive clips to live power lines. This is a Hazardous practice and can permanently damage the transmitter. If you are connecting to dead power lines, make provisions to avoid accidental activation of power to the lines. Hazardous live voltage may be present at output terminals in conductive mode.



**DC INPUT CONNECTOR** - This 5.5 mm/2.1 mm, center positive, DC power connector is used to provide a DC voltage to charge the rechargeable battery. The universal AC/DC power supply provided with the transmitter as a standard accessory plugs into this connector to charge the battery. Alternatively, a DC voltage source capable of supplying 22-30 VDC at 1.5A can be plugged into this connector to charge the battery. The connector is covered with a spring-loaded plastic cap to prevent water and dust from damaging the transmitter.

**ACCESSORIES** - The standard accessories provided with the Rex transmitter are: conductive clips, the universal power supply with line cord, ground stake, a soft carry-all bag with space for the transmitter, the receiver.

Many optional accessories are also available. The following list includes the most common ones. Please contact Schonstedt or your local dealer for details.

- Inductive clamp (3" ID, 5" ID and 7" ID)
- Sondes (512 Hz)
- Medium size conductive clips
- Large size conductive clips
- Spare/Replacement Transmitter Recharge-able Battery Pack

## **Battery Charger**

The battery charger is especially designed to charge the internal custom NiMH battery pack that powers the Rex transmitter. It will typically charge a fully discharged battery in under 4 hours, and it has smart safety features to monitor the charge process. It is recommended to first charge the batteries for at least 4 hours before the initial use. The power jack or line cord should be accessible while charging for quick disconnect, if necessary.

The charger is built into the unit, and the AC/DC power supply plugs directly into the transmitter. The power supply is universal and will accept any AC input voltage in the 100 - 240 volt range, 50 or 60 Hz. A variety of power line cords are available to accommodate different style plugs around the world.

For in-vehicle charging, plug the AC/DC power supply into one of the many commercially available vehicle DC-to-AC inverters capable of supplying at least 100 W of power.

The transmitter detects when the charger is plugged in, and it will automatically go into battery charging mode. To protect the battery from an extremely deep discharge, the transmitter will also turn itself off when the battery voltage has reached a critically low level and the charger **IS NOT** plugged in.

- When the Rex transmitter detects that the battery charger is plugged in while the power is turned ON, it will display "CHA" on the LCD and the bars inside the battery indicator will "roll".
- When the battery is fully charged, it will display "FUL" on the LCD.
- If the power is OFF, the battery will still charge, but no indication of charging activity or battery status will be shown on the LCD.
- If the battery charger is not charging the battery successfully, the letters "Err" will be shown on the LCD.

The battery may not successfully charge for a number of reasons: the battery may be overcharged, the battery may not be taking a charge in a reasonable amount of time, the battery may be too warm to be charged without causing damage to its internal cells, or the battery charger may have an internal fault.

If the error message comes on, take the following steps to try to clear the condition:

1. Remove the power connector from the charger, and reconnect it to start the charger.
2. If the transmitter is warm, move it to a conditioned space, and allow it to cool for several hours before attempting to charge again.
3. If the error message remains on after the steps above, contact Schonstedt Instrument Company for further instructions. Also, please refer to the Battery Replacement portion of this manual.

## **Recommendations for Battery Charging and Storage**

Due to the composition of the battery and the safety features built into the charger, it may be necessary to complete two or more full-charging cycles in order to bring the battery back to full capacity after it has been completely discharged. If you suspect the battery has been fully depleted, such as when it has been in storage for a long time or when the transmitter won't turn on, it is recommended to do at least two consecutive charging cycles before resuming normal use of the battery. Make sure you unplug the charger from the battery in between the two cycles.

Before normal charging can begin, the battery pack temperature and voltage must fall within predetermined acceptable limits. The temperature must be between 50° and 104° F (10° and 40° C). When the charger detects that these two conditions are not met, it will continue to “trickle charge” until the two conditions are met. Then, it will start normal charging.

If the battery is faulty and never reaches an acceptable voltage to start normal charging, the charger continues to trickle charge. In this case, only a small fraction of full charge will be reached after the normal 4-hours of charging time.

If the charger is charging the battery in normal charge mode and the temperature rises above 140° F (60° C) before the battery is fully charged, the charger will switch to trickle charge mode. In this case, full charge may not be achieved after the normal 4-hours of charging time. The battery pack also contains a thermostat that will open the circuit for safety if it gets too hot.

The higher the storage temperature, the faster the battery will self-discharge, reducing its shelf life. The recommended storage temperature is 50° to 70°F (10° to 20°C). Storing the battery at higher temperature can reduce its overall life; storing it at colder temperatures is preferred and beneficial.

## **Battery Replacement**

The rechargeable NiMH battery pack that powers the transmitter should provide a very large number of charge-discharge cycles. However, like all rechargeable batteries, it has a finite life and eventually may have to be replaced if it can't hold or can't reach a full charge. In addition, if the transmitter is malfunctioning due to a defective battery, the user can replace the battery in the transmitter with a new one received from Schonstedt.



### CAUTION

When replacing the transmitter battery, only use Schonstedt batteries!

To replace the battery, turn the transmitter off, remove the four screws on the front panel's battery compartment and expose the battery by removing the cover. Gently flip the unit over to let the battery pack drop off into your hand and expose the connector to the main PC board. Reach into the compartment and unplug the connector to disconnect the existing battery (as shown in the below images).

Plug the new battery in (the connector is polarized and will plug only one way) until you hear it click into position. Let the wire fold into the compartment, under the battery, and place the new battery in the compartment. Then, replace the cover and the screws.

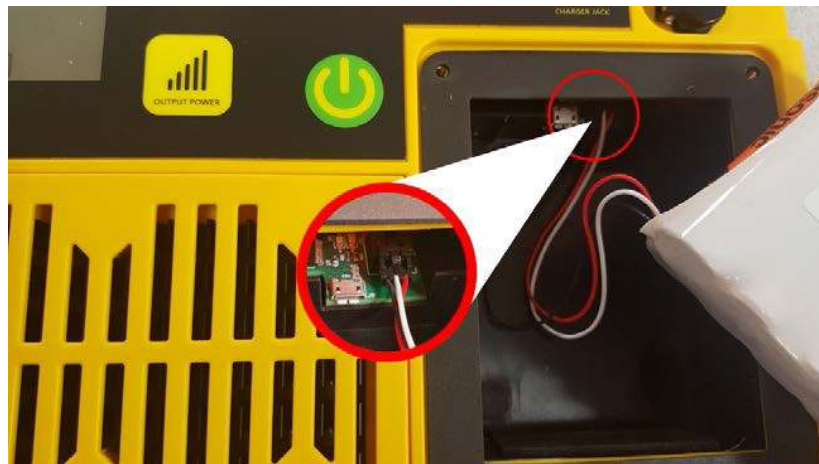



## Specifications

Operating Frequency:	512 Hz, 33 kHz and 82 kHz
Operating Modes:	Conductive, all frequencies Inductive, 33 kHz and 82 kHz only Inductive Clamp (optional), 33 kHz and 82 kHz only
Max. Output Power: (Conductive mode, @ 1000 $\Omega$ load)	512 Hz - 1/2, 1, 2 or 5 W 33 kHz - 1/2, 1, 2 or 5 W 82 kHz - 1/2 or 1 (FCC limited)
Max. Output Voltage:	100 V RMS
Resistance Meas. Range:	500 $\Omega$ to 5 M $\Omega$
Voltage Meas. Range:	0-260 VAC and 0-60 VDC Battery
Type:	Rechargeable NiMH pack (12V)
Battery Life:	8 Hours (intermittent usage @ 70° F)
Charging:	Internal Smart Charger powered by AC/DC power adapter (100-240 V - 0.8 A), or by 22-30 VDC, 1.5 A supply
Outputs/Inputs:	a) 1/4" Phone Jack Output: -Inductive clamp -Conductive clips b) 5.5 mm/2.1 mm DC Power Connector Input: -AC/DC power adapter and line cord (provided) -22-30 VDC, 1.5 A supply (center positive)
Dimensions:	10" W x 10.25" D x 1.75" H (25.4 cm x 26 cm x 4.5 cm)
Weight:	3.5 lbs. (1.6 kg)
Operating Temp.:	-4°F to 140°F (-20°C to 70°C)
Water and Dust Resistance	Rated IP54

## Regulatory Compliance and Declaration of Conformity

FCC:

++++

This device complies with Part 15 of the FCC Rules. Operation is subject to the following two conditions: (1) this device may not cause harmful interference, and (2) this device must accept any interference received, including interference that may cause undesired operation.

++++

Industry Canada:

+++++

CAN ICES-3 (B)/NMB-3(B)

CE Mark:

+++++

Application of Council Directives: Directive  
2014/53/EU (RED)

Standards to which conformity is declared:

ETSI EN 300 330 V 2.1.1 (2016-11)

ETSI EN 301 489-1 V2.2.0 (2017-03)

ETSI EN 301 489-3 V 2.1.1 (2017-03)

Directive 2014/35/EU (LVD)

Standard to which conformity is declared: EN  
61010-1:2010 (3<sup>rd</sup> Edition)

Directive 2011/65/EU (RoHS2)

Standard to which conformity is declared: EN  
50581:2012

This device should only be cleaned using a dry cloth. Do not use any solvents that could damage the labels.

If this device is not used in the manner specified in this manual by Schonstedt, the protection provided by the equipment may be impaired.



Schonstedt's Declaration of Conformity can be found at:

[www.schonstedt.com/rex](http://www.schonstedt.com/rex)

# 4

## TECHNICAL SUPPORT/SERVICE INFORMATION



Schonstedt offers technical support and sales support. For any reason regarding usage and application, please contact our technical support team at 888-32-TRACE (888-328-7223).

**FOR SERVICE OR REPAIR**

Please ship unit to:

Schonstedt Instrument Company  
100 Edmond Road  
Kameysville, WV 25430  
Attn: Customer Service Dept.

Return instructions and return form are located online at:  
<https://www.schonstedt.com/support/repair-department/>

5

WARRANTY



Schonstedt Instrument Company (Schonstedt) warrants each product of its manufacture to be free from defects in material and workmanship subject to the following terms and conditions. The warranty is effective for 3 years after the shipment by Schonstedt to the original purchaser. Please complete the warranty registration card online at [www.schonstedt.com/welcome](http://www.schonstedt.com/welcome).

Schonstedt's obligation under the warranty is limited to servicing or adjusting any product returned to the factory for this purpose and to replacing any defective part thereof. Such product must be returned by the original purchaser, transportation charges prepaid, with a description of the defect in writing. If the fault has been caused by misuse or abnormal conditions of operation, repairs will be billed. Specifically, this warranty does not cover product that has been subject to inundation by fire, water or other liquid intrusion, or units that have been damaged or compromised due to repair, alteration or modification by anyone other than an authorized repair representative. Prior to a repair being performed by Schonstedt, a cost estimate will be submitted and no work will be completed until authorized by the customer. Batteries are specifically excluded under the warranty and should be addressed to the manufacturer of batteries in question.

Schonstedt shall not be liable for any injury to persons or property or for any other special or consequential damages sustained or expenses incurred by reason of the use of any Schonstedt product.



Schonstedt Instrument Company (Schonstedt) warrants each product of its manufacture to be free from defects in material and workmanship subject to the following terms and conditions. The warranty is effective for 3 years after the shipment by Schonstedt to the original purchaser. Please complete the warranty registration card online at [www.schonstedt.com/welcome](http://www.schonstedt.com/welcome).

Schonstedt's obligation under the warranty is limited to servicing or adjusting any product returned to the factory for this purpose and to replacing any defective part thereof. Such product must be returned by the original purchaser, transportation charges prepaid, with a description of the defect in writing. If the fault has been caused by misuse or abnormal conditions of operation, repairs will be billed. Specifically, this warranty does not cover product that has been subject to inundation by fire, water or other liquid intrusion, or units that have been damaged or compromised due to repair, alteration or modification by anyone other than an authorized repair representative. Prior to a repair being performed by Schonstedt, a cost estimate will be submitted and no work will be completed until authorized by the customer. Batteries are specifically excluded under the warranty and should be addressed to the manufacturer of batteries in question.

Schonstedt shall not be liable for any injury to persons or property or for any other special or consequential damages sustained or expenses incurred by reason of the use of any Schonstedt product.

## Visit [www.schonstedt.com](http://www.schonstedt.com)

### **Schonstedt Instrument Company**

100 Edmond Road, Kearneysville, WV 25430, USA

Tel: +1 (304) 725-1050 Toll Free: +1 (800) 999-8280

Email: [schonstedt.info@spx.com](mailto:schonstedt.info@spx.com)

Copyright © 2019 Schonstedt Instrument Company. All rights reserved. Schonstedt is a subsidiary of SPX Corporation. Due to a policy of continued development, we reserve the right to alter or amend any published specification without notice. This document may not be copied, reproduced, transmitted, modified or used, in whole or in part, without the prior written consent of Schonstedt Instrument Company.