

Specification Sheets for Wallingford Vanities & Linen.

SPECIFICATION VARIANCES

Dimensions on finished vanities may vary slightly from those shown on these specification sheets due to variability in construction materials.

Our products are engineered to maintain close dimensional tolerances but variability in manufacturing materials can change dimensions slightly (normally within $\pm 1/8$ " but occasionally up to $\pm 3/16$ ").

In most applications these slight variations will have no impact upon installation, appearance or function. However, when planning and finishing a space for a built in vanity, **do not frame or finish the space before measuring the actual cabinet!**

We can not be responsible for any expenses incurred as a result of the end user or contractor not following this guideline.

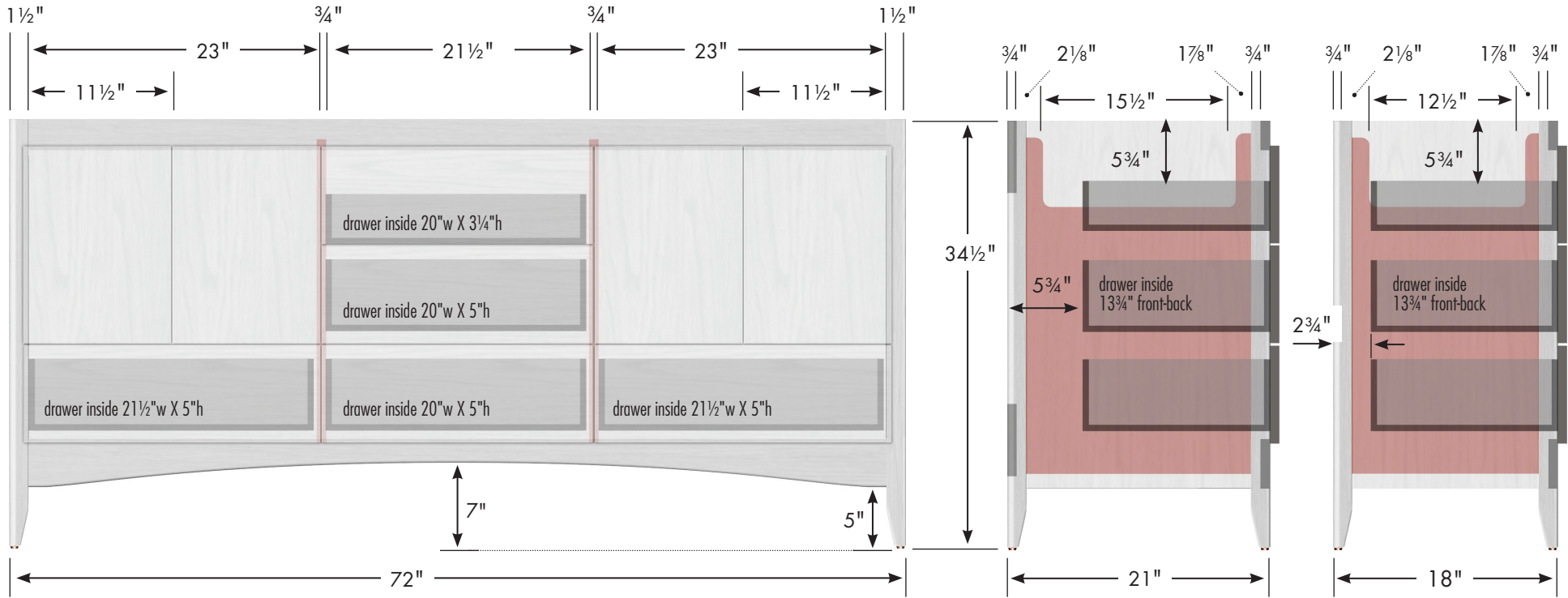

Adjustable/removable shelf under basins behind doors

internal dividers

Vanity back clear openings for plumbing
(may need to cut adjustable shelf)

72" Wallingford Vanity

72" wide
34½" tall
21" or 18" front-to-back

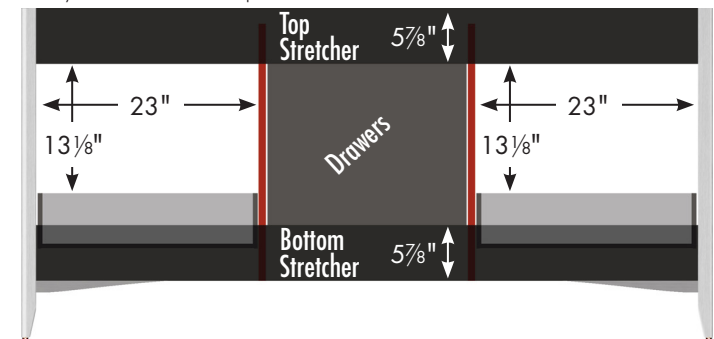

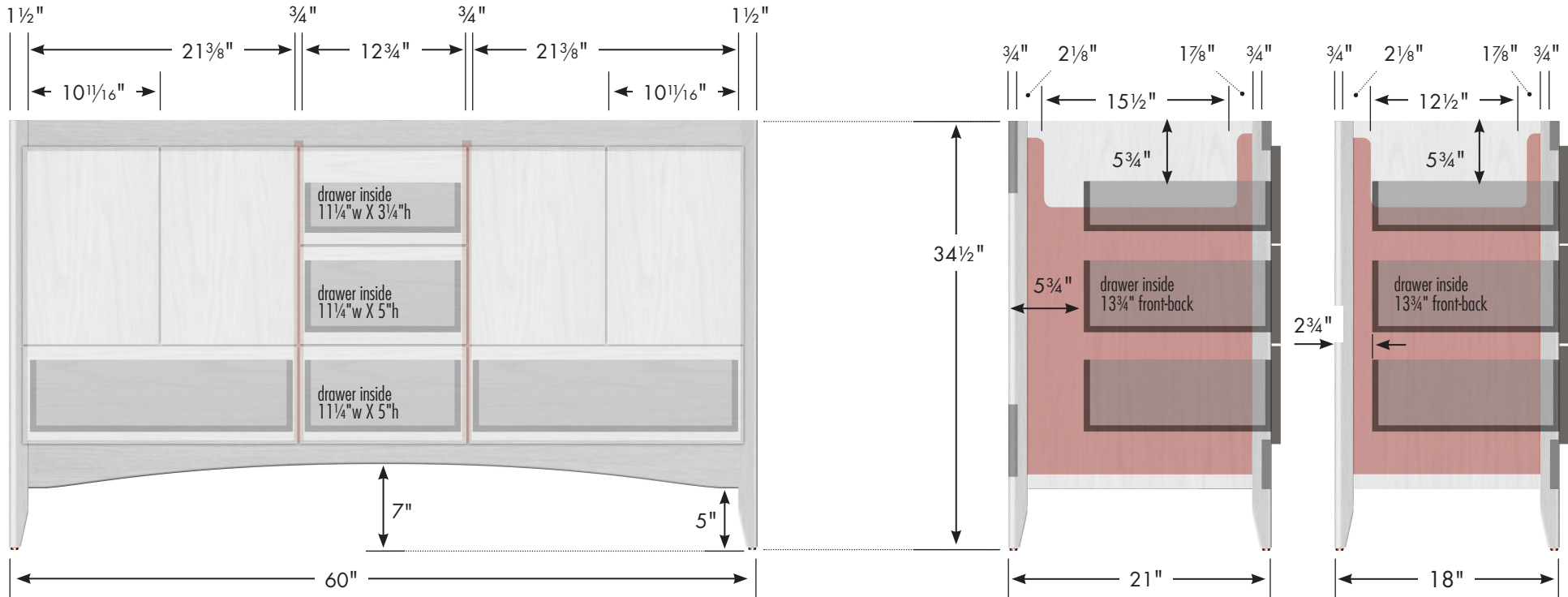

Adjustable/removable shelf under basins behind doors

internal dividers

Vanity back clear openings for plumbing
(may need to cut adjustable shelf)

60" Wallingford Vanity
Double Basin
 60" wide
 34½" tall
 21" or 18" front-to-back

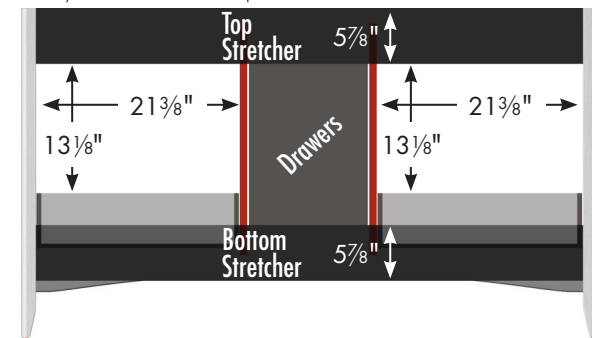

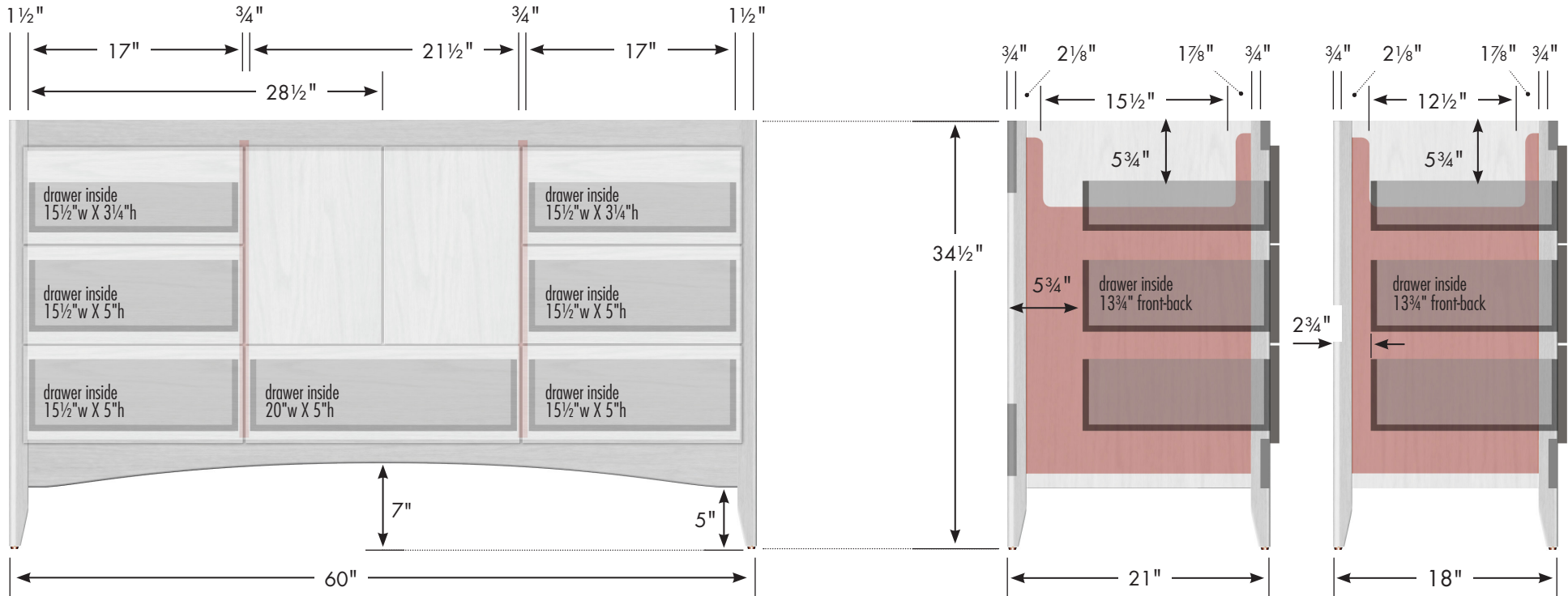

Adjustable/removable shelf under basin behind doors

internal dividers

Vanity back clear openings for plumbing
(may need to cut adjustable shelf)

**60" Wallingford Vanity
Center Basin**
60" wide
34½" tall
21" or 18" front-to-back

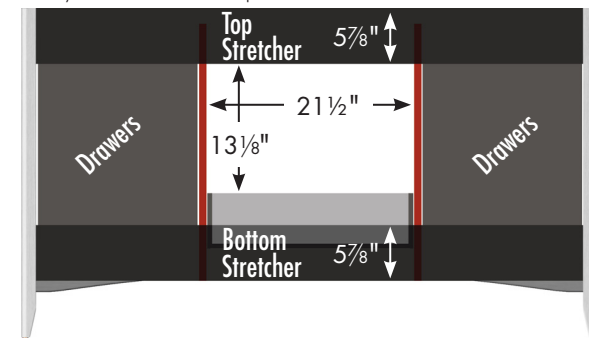

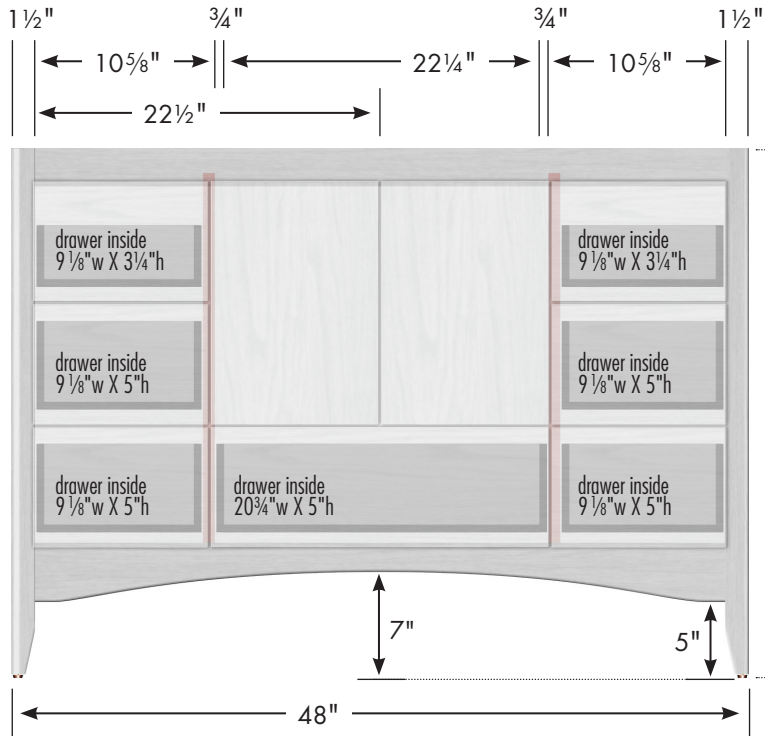

Adjustable/removable shelf under basin behind doors

internal dividers

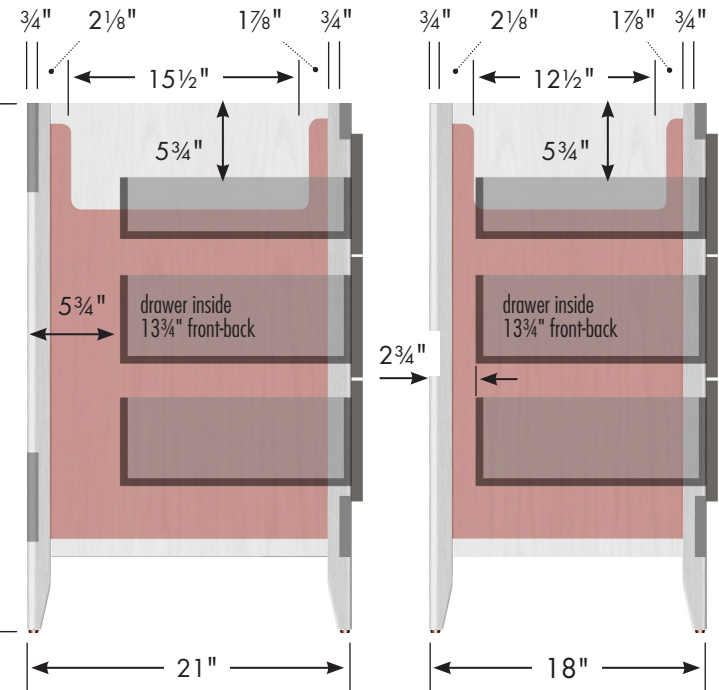

Vanity back clear openings for plumbing (may need to cut adjustable shelf)

48" Wallingford Vanity

48" wide
34½" tall
21" or 18" front-to-back

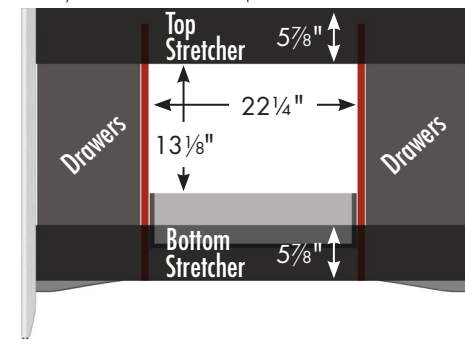

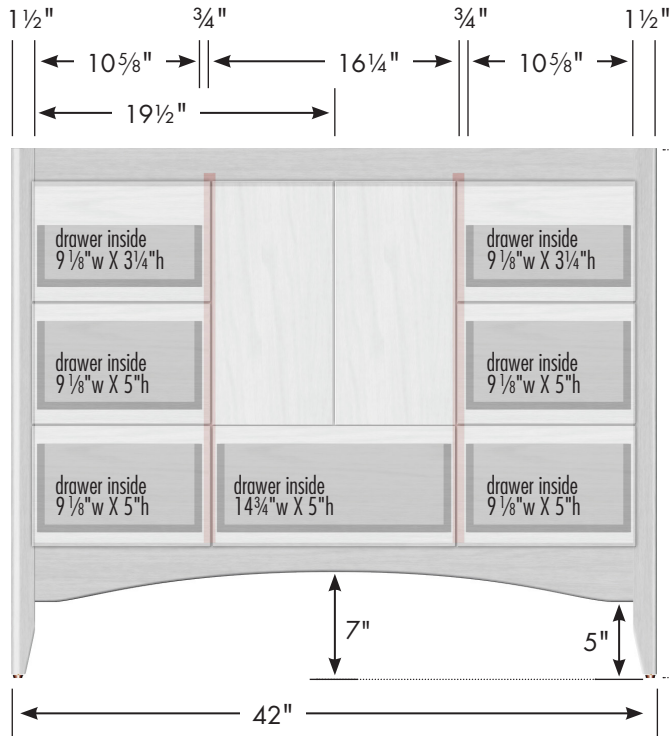

Adjustable/removable shelf under basin behind doors

internal dividers

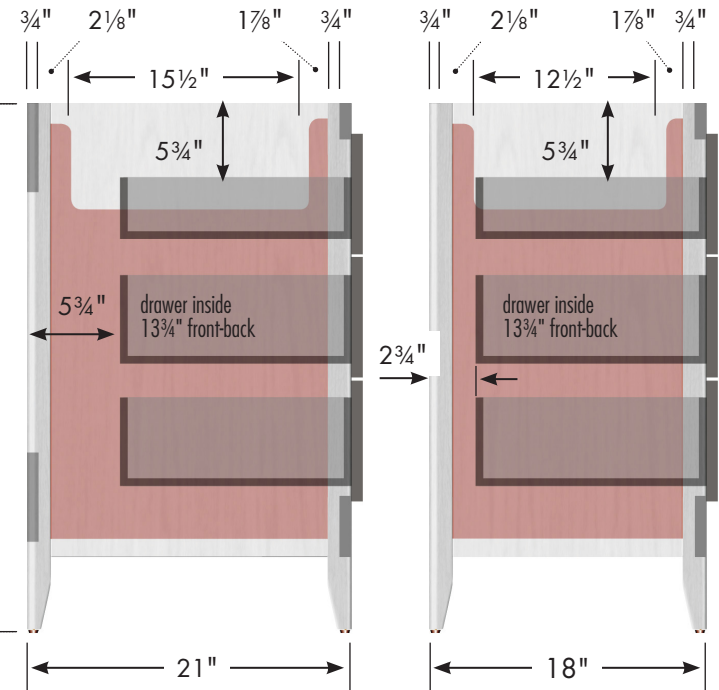

Vanity back clear openings for plumbing (may need to cut adjustable shelf)

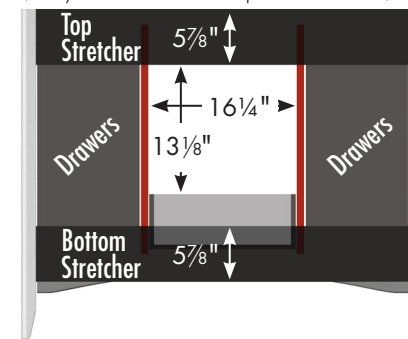

42" Wallingford Vanity

42" wide
34½" tall
21" or 18" front-to-back



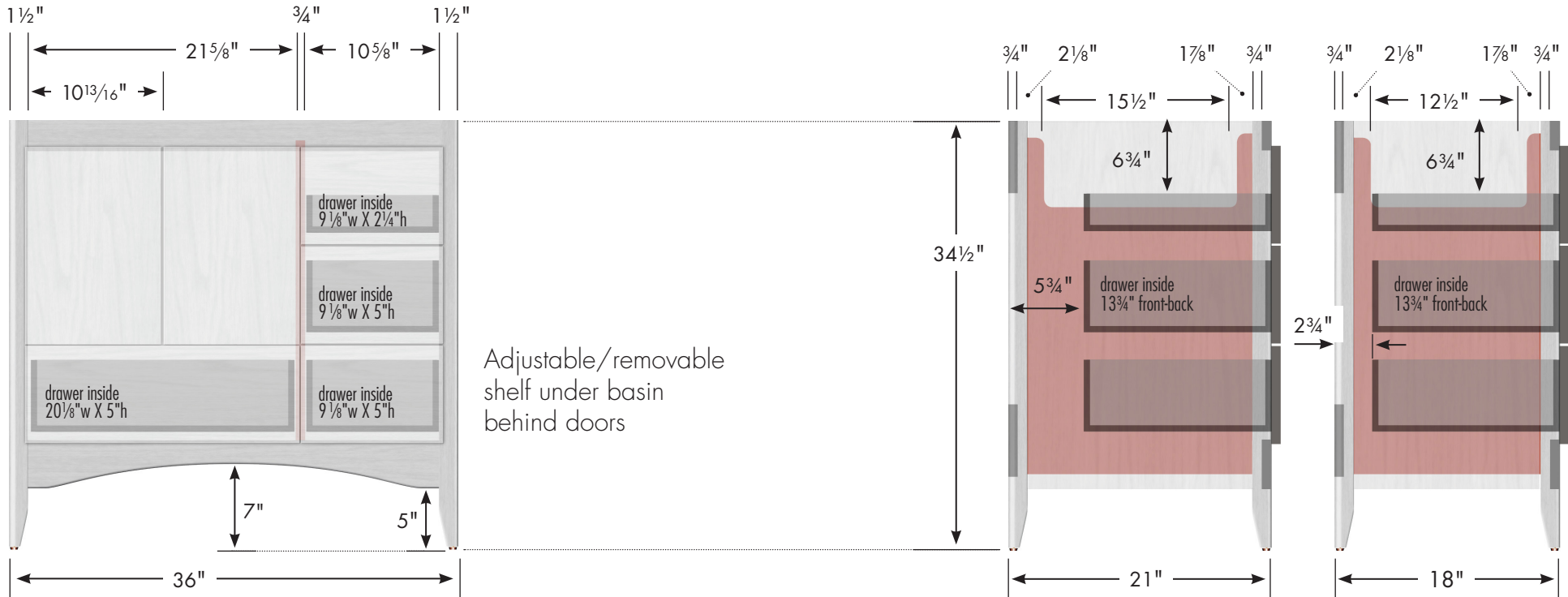

internal dividers

Vanity back clear openings for plumbing
(may need to cut adjustable shelf)

36" Wallingford Vanity
Drawers Right
 36" wide
 34½" tall
 21" or 18" front-to-back

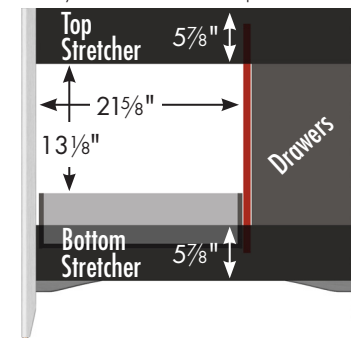

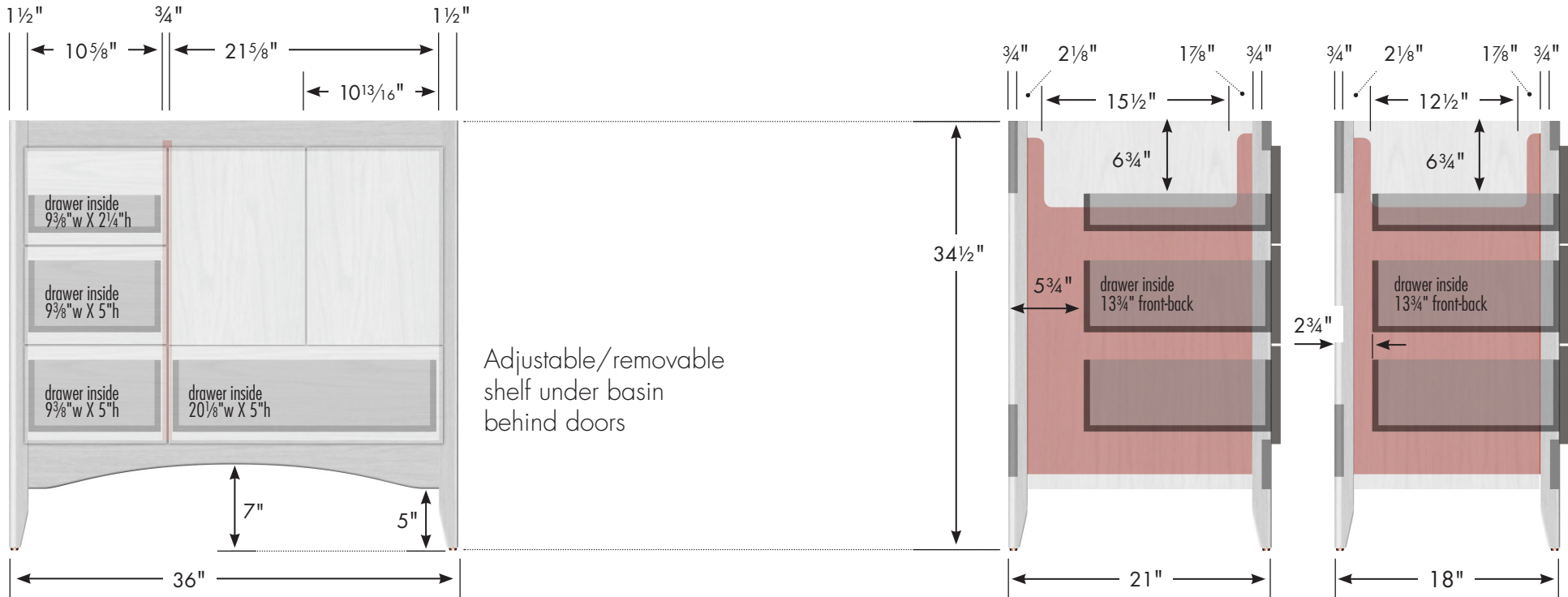

**36" Wallingford Vanity
Drawers Left**
36" wide
34½" tall
21" or 18" front-to-back



Vanity back clear openings for plumbing
(may need to cut adjustable shelf)

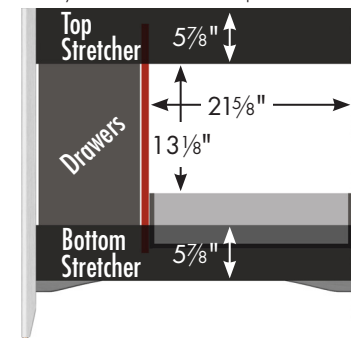

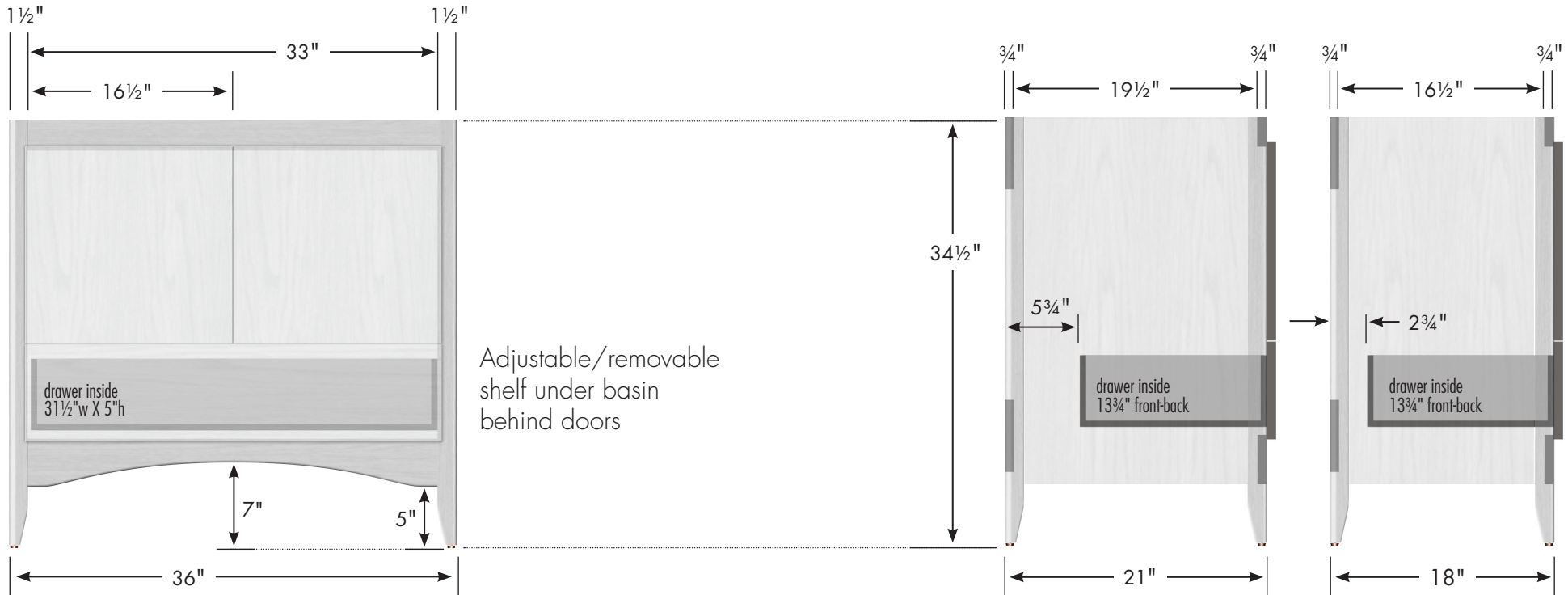

36" Wallingford Vanity
No Side Drawers
 36" wide
 34½" tall
 21" or 18" front-to-back



Vanity back clear openings for plumbing
 (may need to cut adjustable shelf)

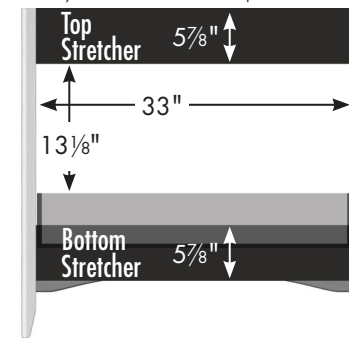

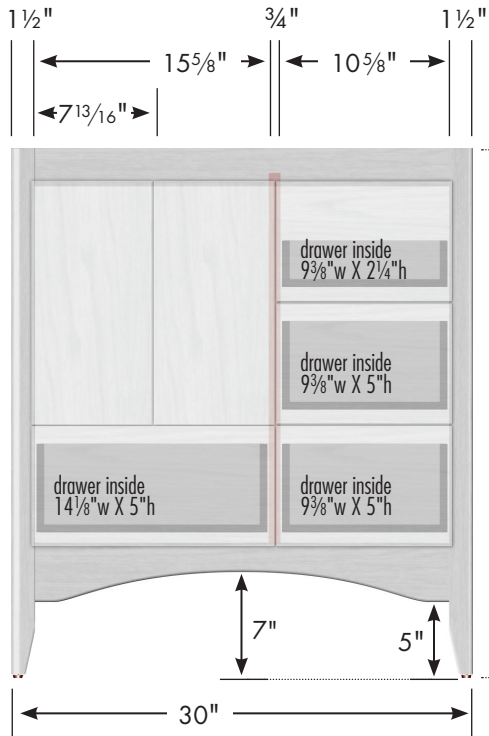

Adjustable/removable shelf under basin behind doors

34½"

internal dividers

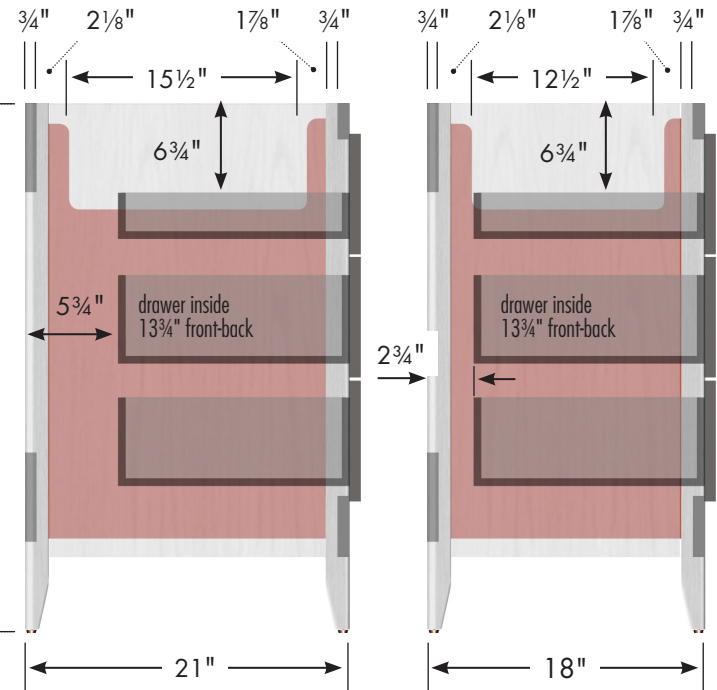

30" Wallingford Vanity
Drawers Right
 30" wide
 34½" tall
 21" or 18" front-to-back



Vanity back clear openings for plumbing
 (may need to cut adjustable shelf)

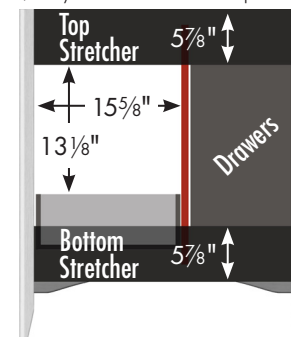

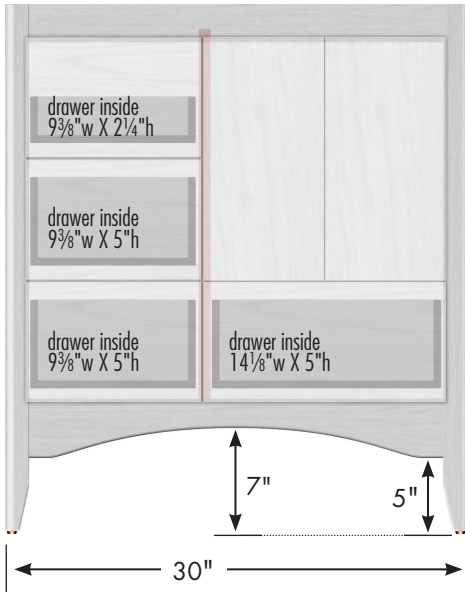
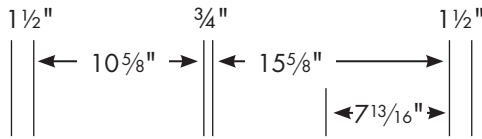

Adjustable/removable shelf under basin behind doors

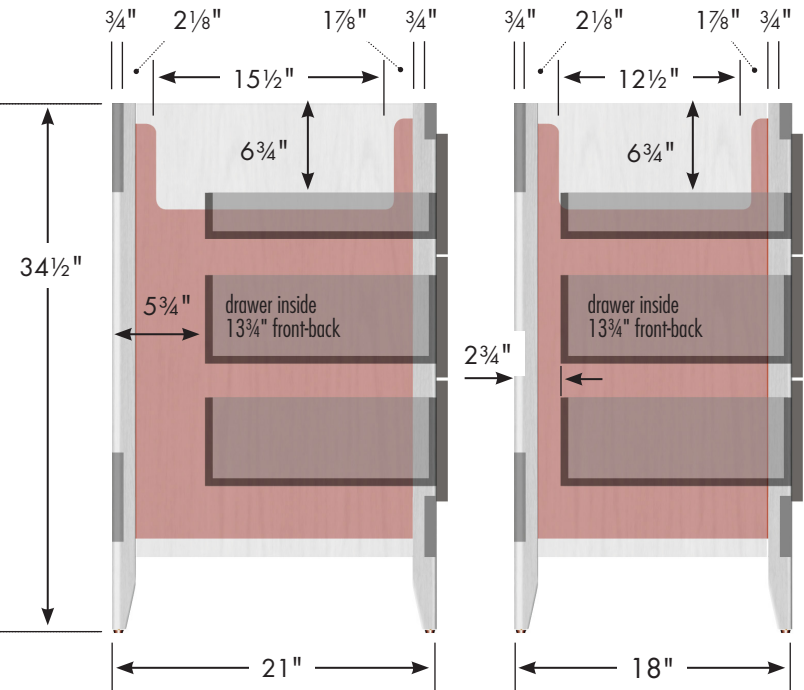

internal dividers

Vanity back clear openings for plumbing
(may need to cut adjustable shelf)

**30" Wallingford Vanity
Drawers Left**
30" wide
34½" tall
21" or 18" front-to-back

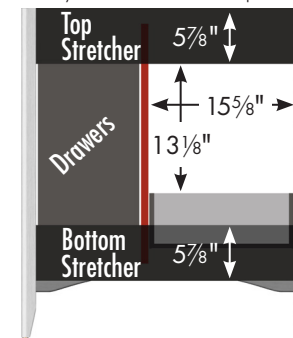

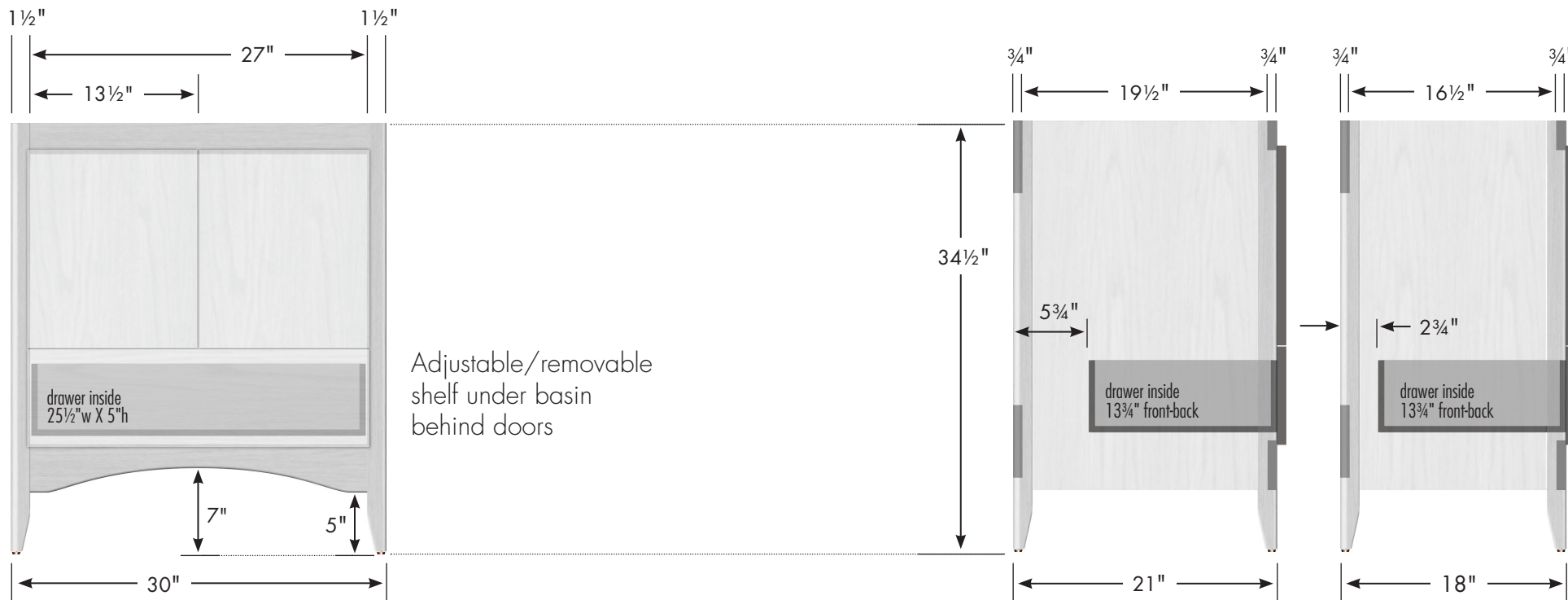

30" Wallingford Vanity
No Side Drawers
 30" wide
 34½" tall
 21" or 18" front-to-back



Vanity back clear openings for plumbing
 (may need to cut adjustable shelf)

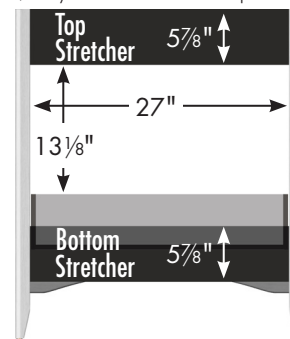

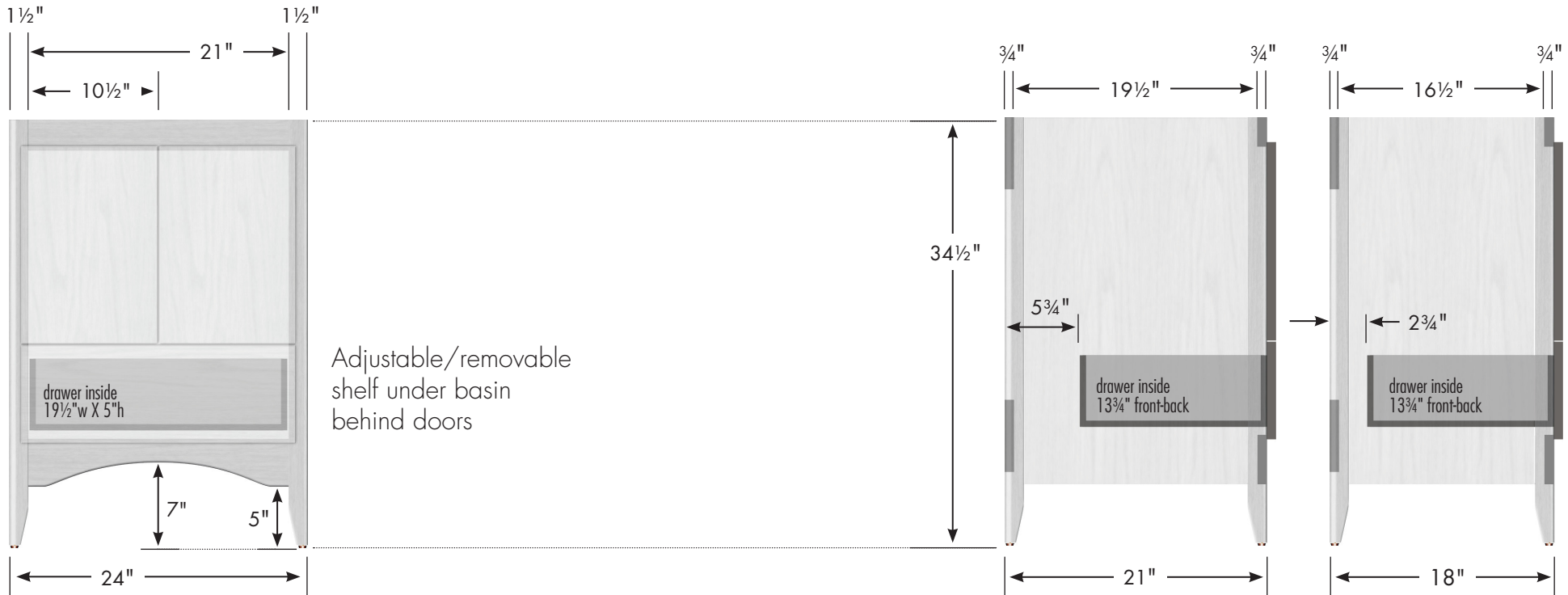

24" Wallingford Vanity

24" wide
34½" tall
21" or 18" front-to-back



Vanity back clear openings for plumbing
(may need to cut adjustable shelf)

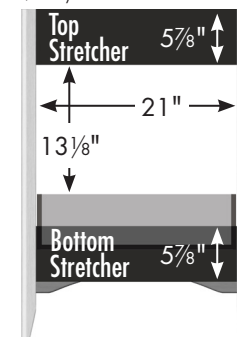

SPECIAL NOTE

Serious or fatal crushing injuries can occur from a linen cabinet tipping over.

To help prevent tipover:

- Install provided tipover restraint
- Place heaviest items in the lower drawers
- Do not place heavy objects on top of this product
- Never allow children to climb or hang on drawers, doors or shelves
- Do not open more than one drawer at a time.

Use of tipover restraints may only reduce, but not eliminate, the risk of tipover.

We supply attachment hardware with your order but some applications may need different/additional hardware. Manufacturer assumes no liability for improper installation or excessive loads placed on screws, brackets or straps.

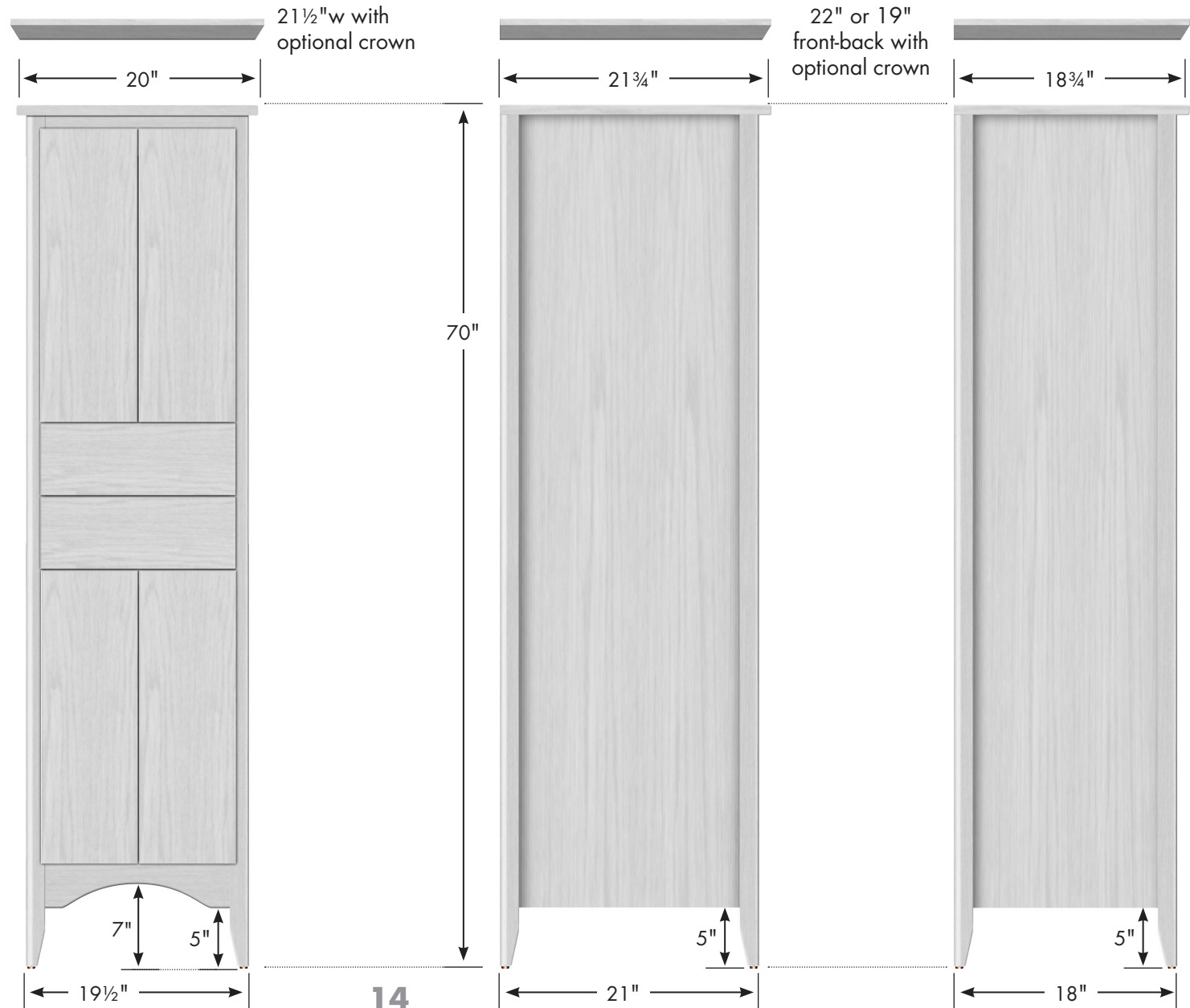

19½" Wallingford Linen

19½" wide
70" tall

21" or 18" front-to-back
optional crown adds 1" to height

