

Specification Sheets for Newhalem Vanities, Linen & Mirror.

SPECIFICATION VARIANCES

Dimensions on finished vanities may vary slightly from those shown on these specification sheets due to variability in construction materials.

Our products are engineered to maintain close dimensional tolerances but variability in manufacturing materials can change dimensions slightly (normally within $\pm 1/8$ " but occasionally up to $\pm 3/16$ ").

In most applications these slight variations will have no impact upon installation, appearance or function. However, when planning and finishing a space for a built in vanity, **do not frame or finish the space before measuring the actual cabinet!**

We can not be responsible for any expenses incurred as a result of the end user or contractor not following this guideline.

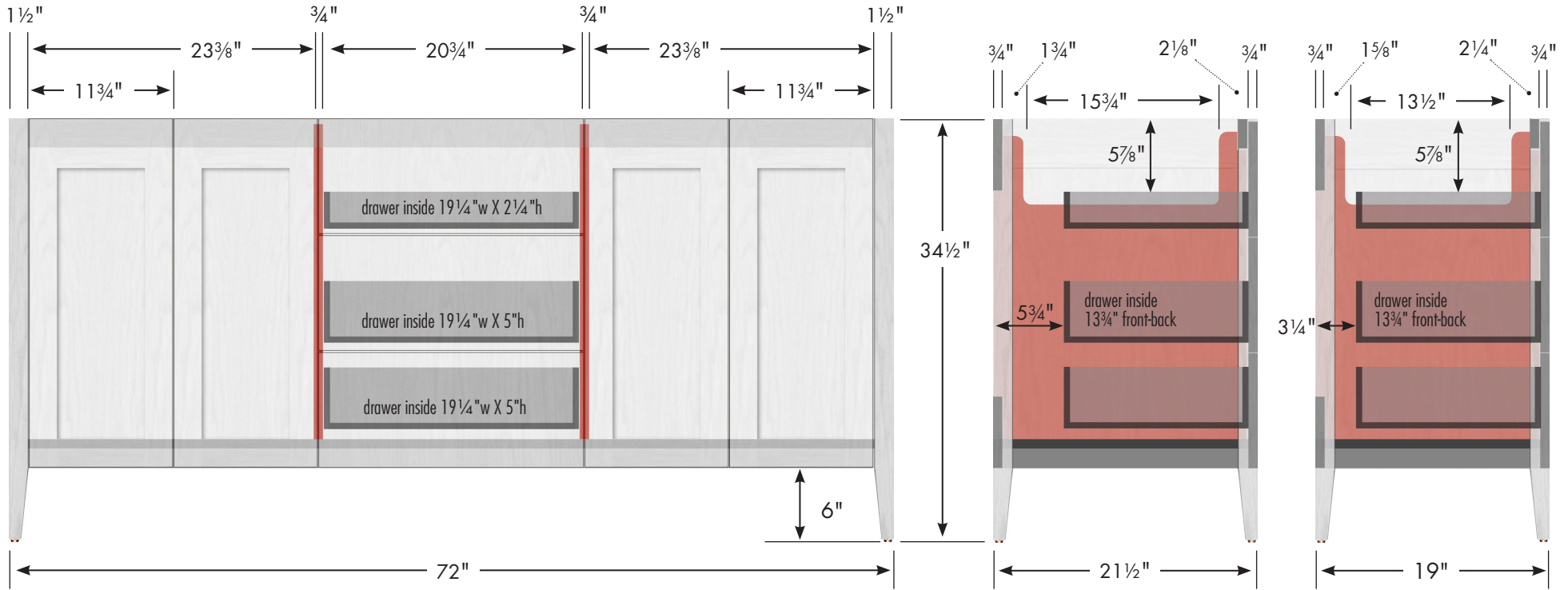

Adjustable/removable shelf under basins behind doors

internal dividers

Vanity back clear openings for plumbing
(may need to cut adjustable shelf)

72" Newhalem Vanity

72" wide
34½" tall
21½" or 19" front-to-back

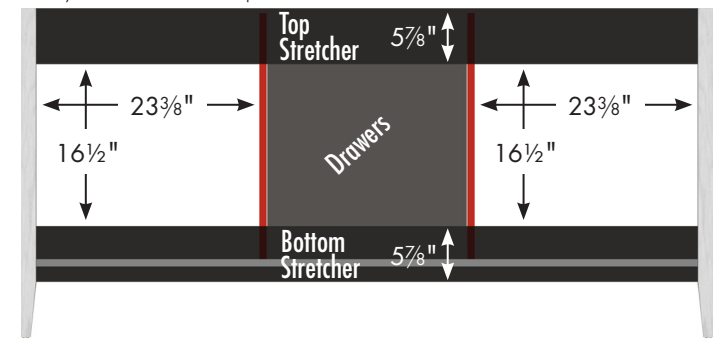

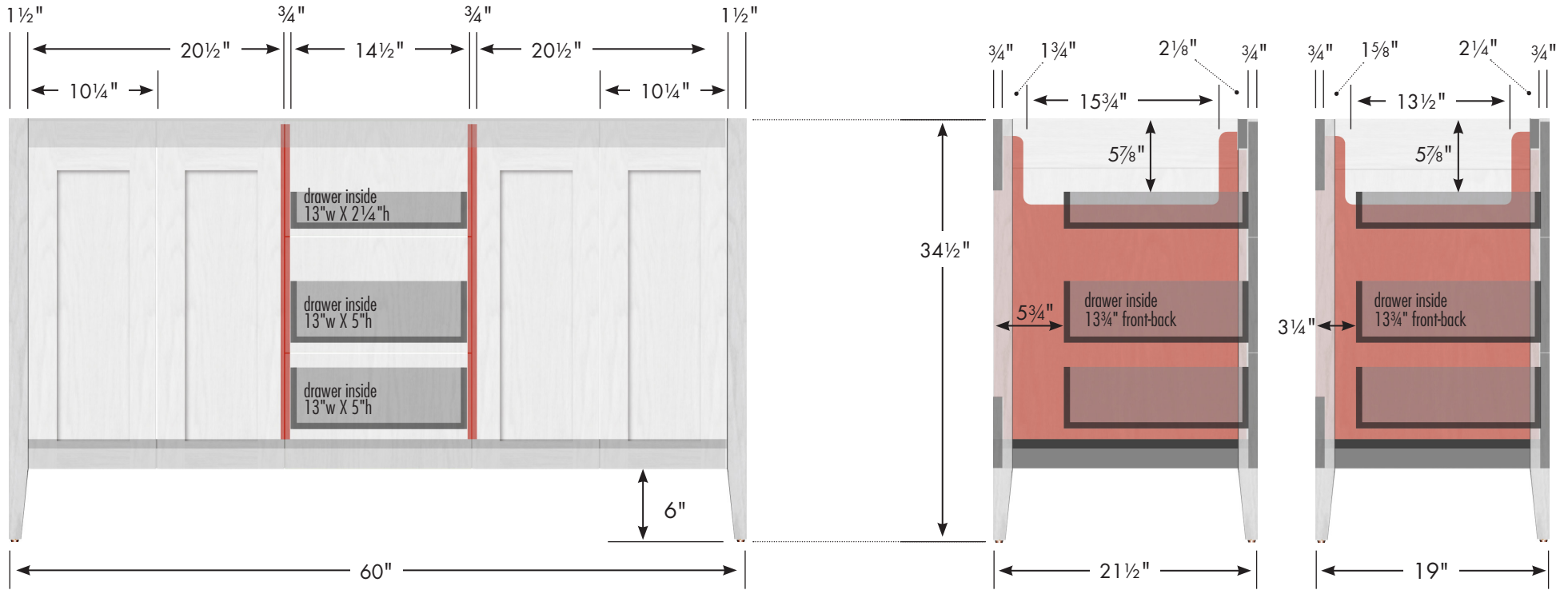

Adjustable/removable shelf under basins behind doors

internal dividers

Vanity back clear openings for plumbing
(may need to cut adjustable shelf)

60" Newhalem Vanity
Double Basin
60" wide
34½" tall
21½" or 19" front-to-back

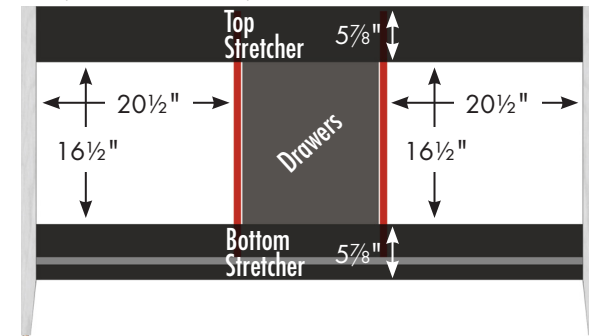

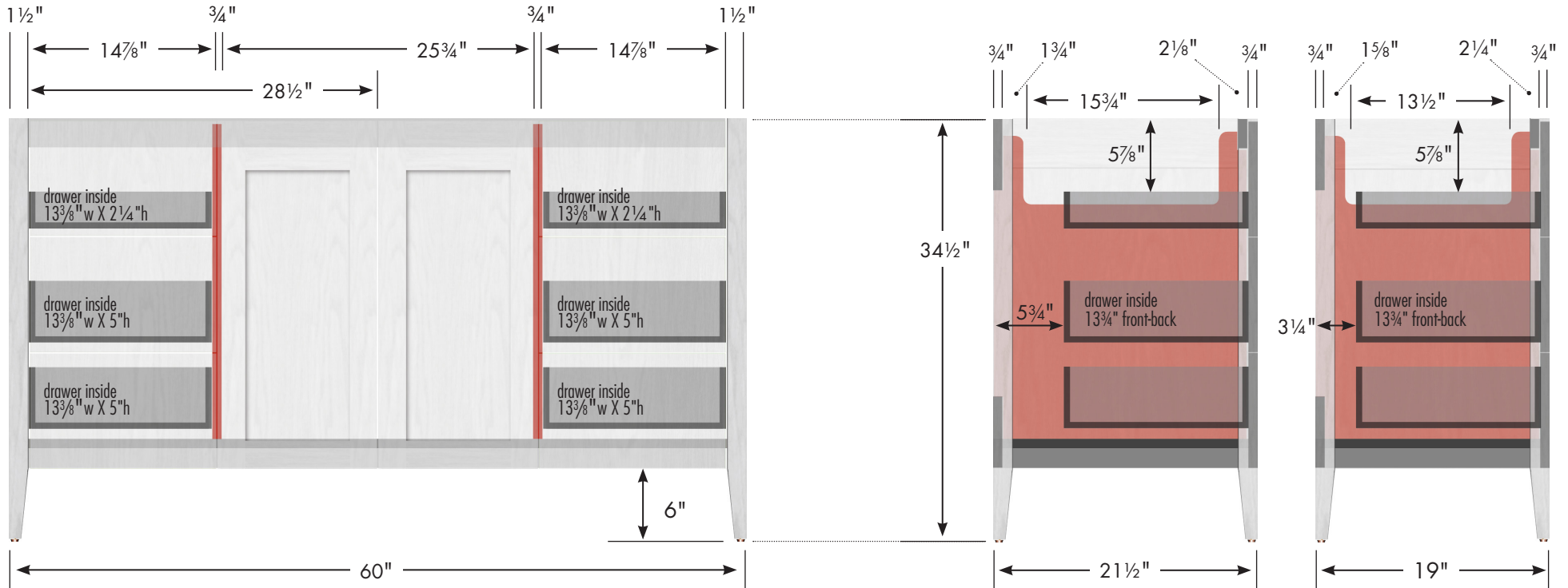

Adjustable/removable shelf under basins behind doors

internal dividers

Vanity back clear openings for plumbing
(may need to cut adjustable shelf)

60" Newhalem Vanity
Center Basin
60" wide
34½" tall
21½" or 19" front-to-back

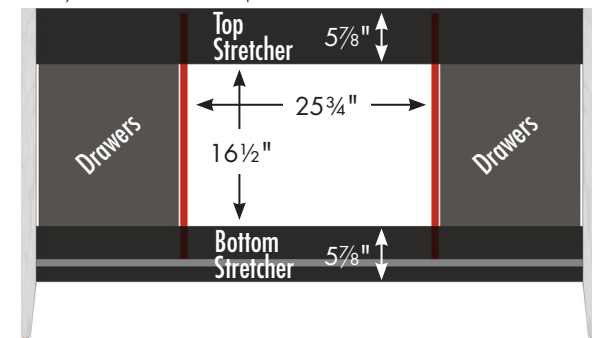

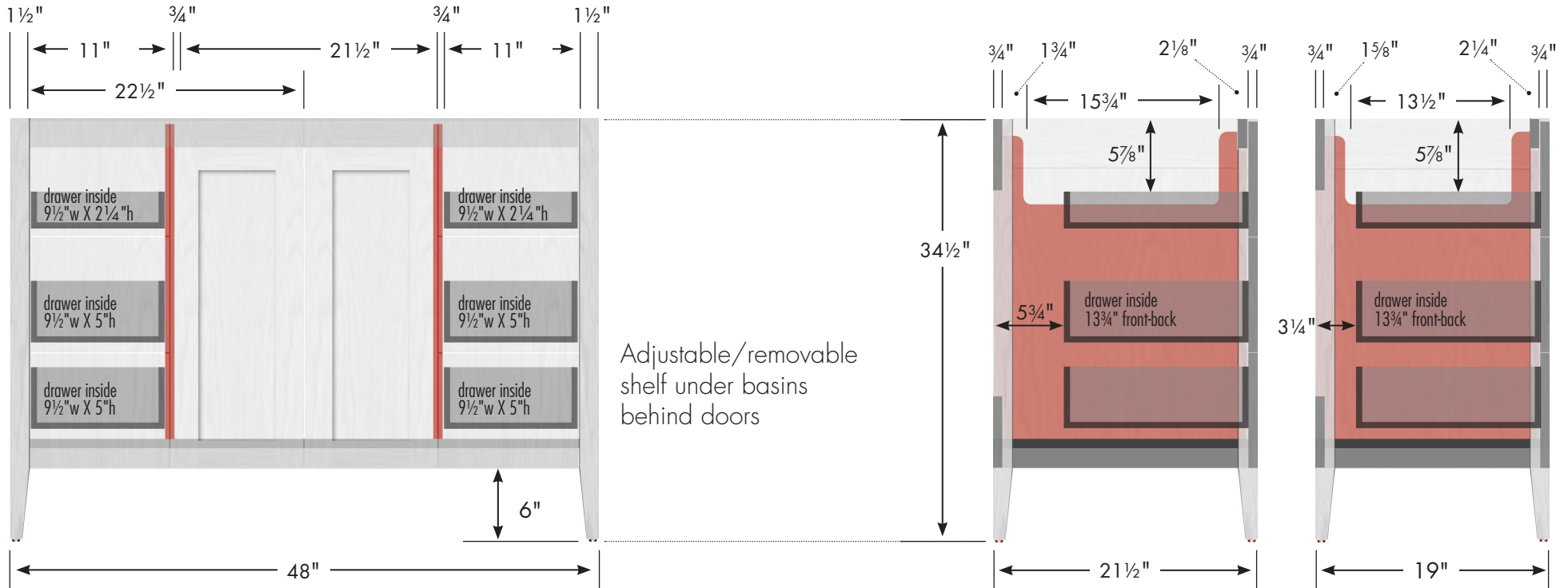

Adjustable/removable shelf under basins behind doors

internal dividers

Vanity back clear openings for plumbing (may need to cut adjustable shelf)

48" Newhalem Vanity

48" wide
34½" tall
21½" or 19" front-to-back

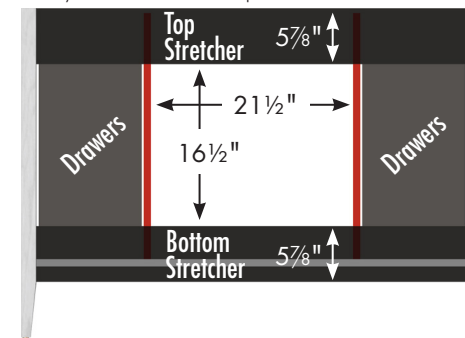

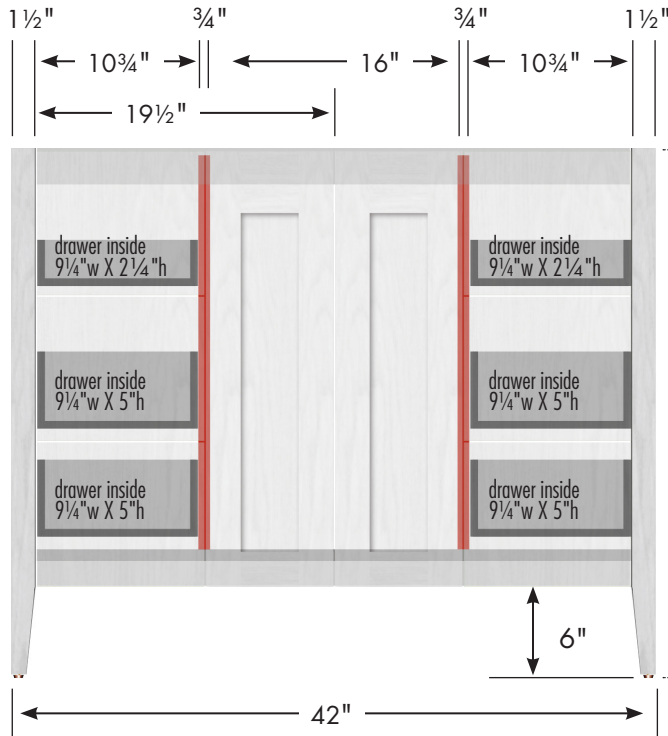

Adjustable/removable shelf under basins behind doors

34½"

internal dividers

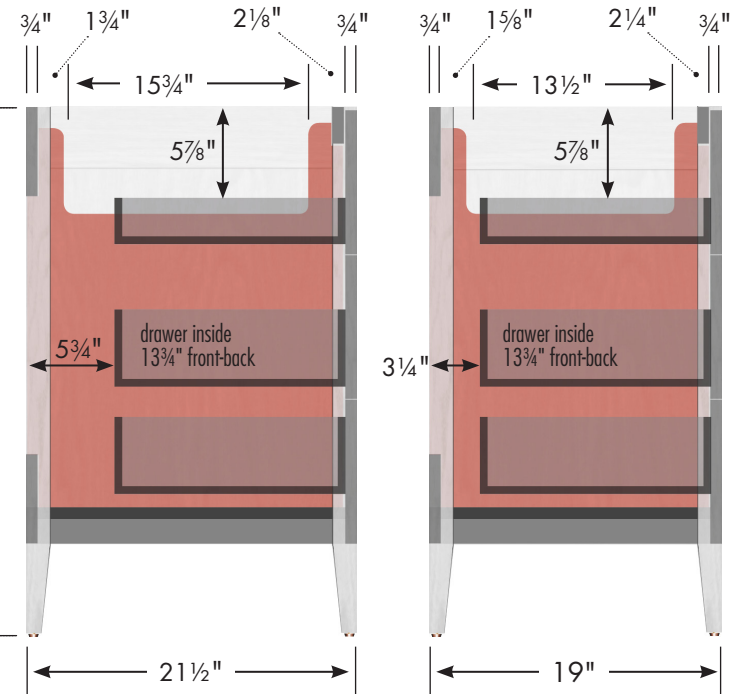

42" Newhalem Vanity

42" wide
34½" tall
21½" or 19" front-to-back



Vanity back clear openings for plumbing
(may need to cut adjustable shelf)

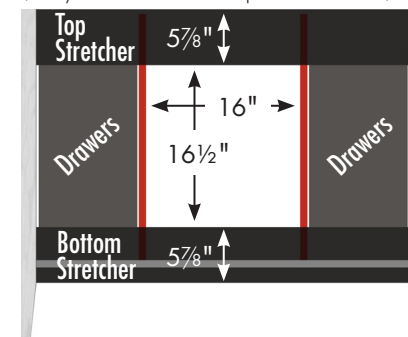

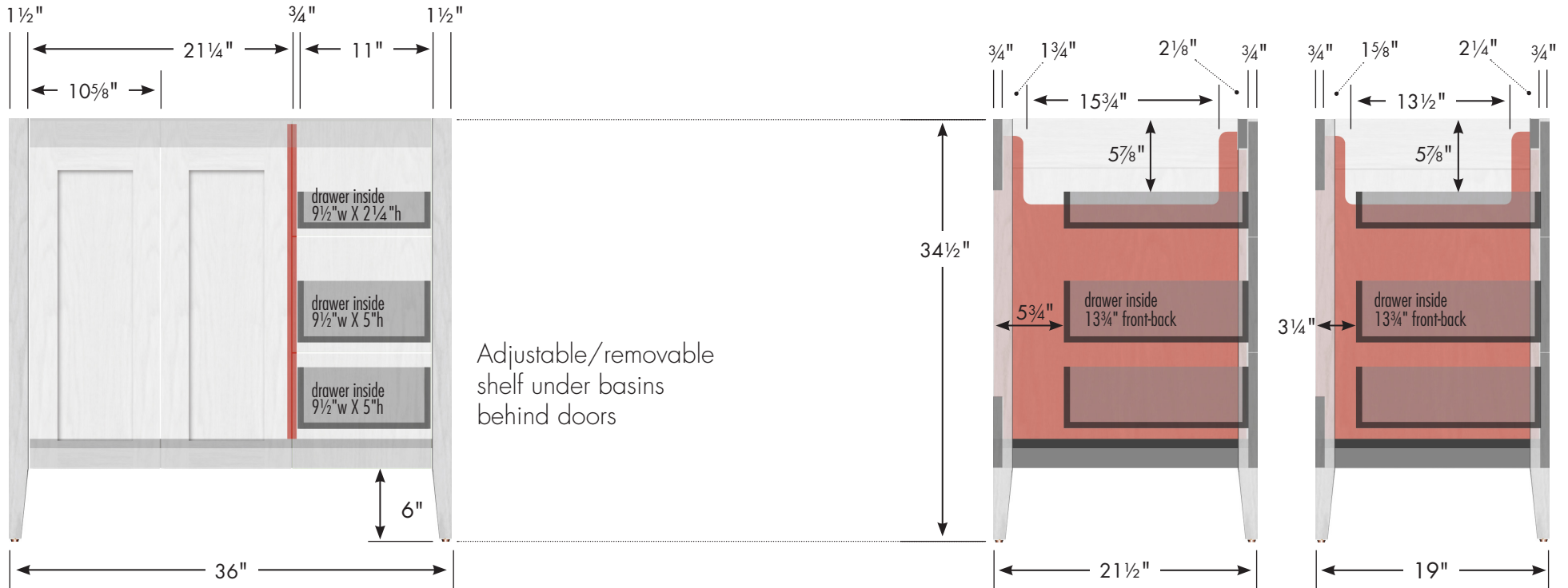

internal dividers

Vanity back clear openings for plumbing
(may need to cut adjustable shelf)

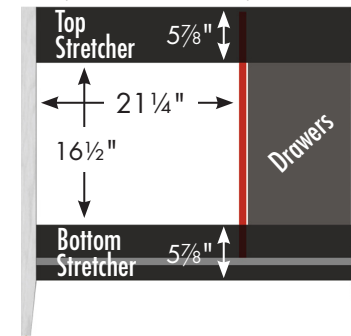

36" Newhalem Vanity
Drawers Right
 36" wide
 34½" tall
 21½" or 19" front-to-back



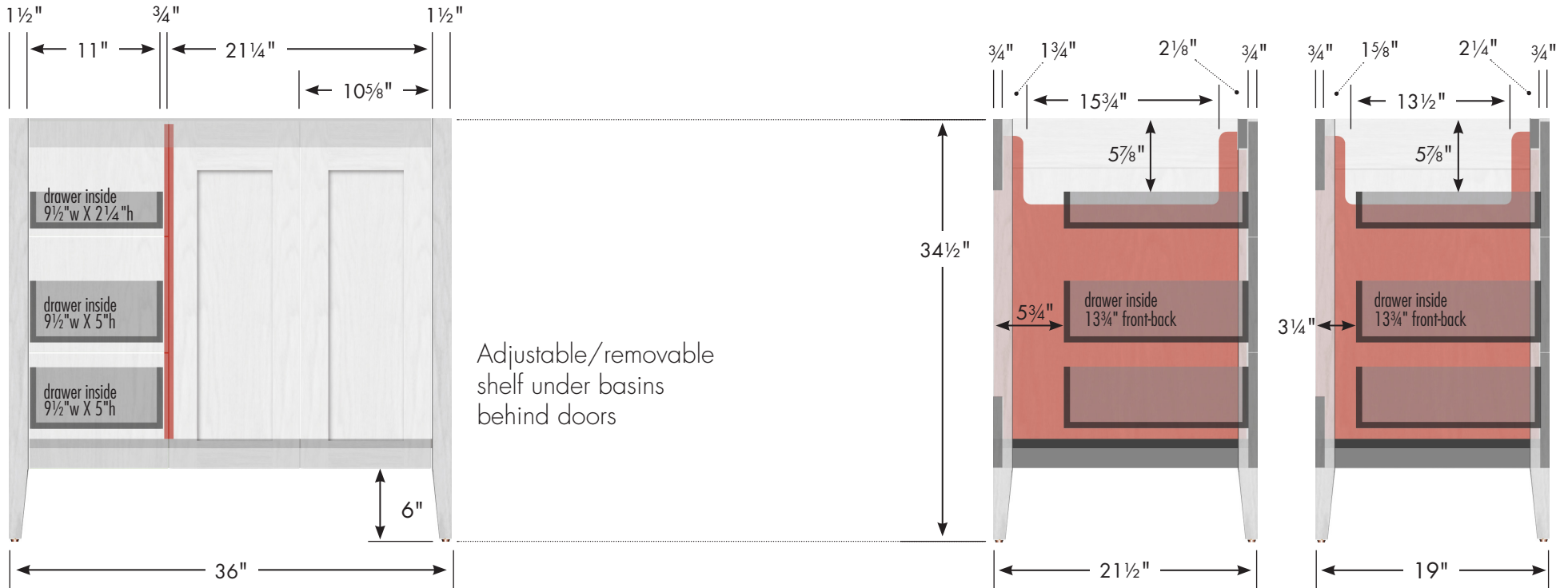

Adjustable/removable shelf under basins behind doors

internal dividers

Vanity back clear openings for plumbing (may need to cut adjustable shelf)

36" Newhalem Vanity
Drawers Left
 36" wide
 34½" tall
 21½" or 19" front-to-back

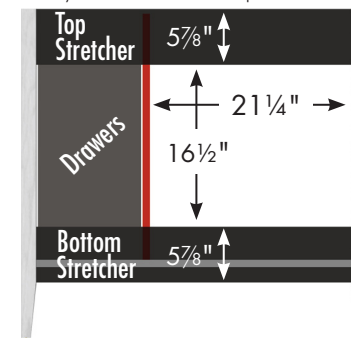

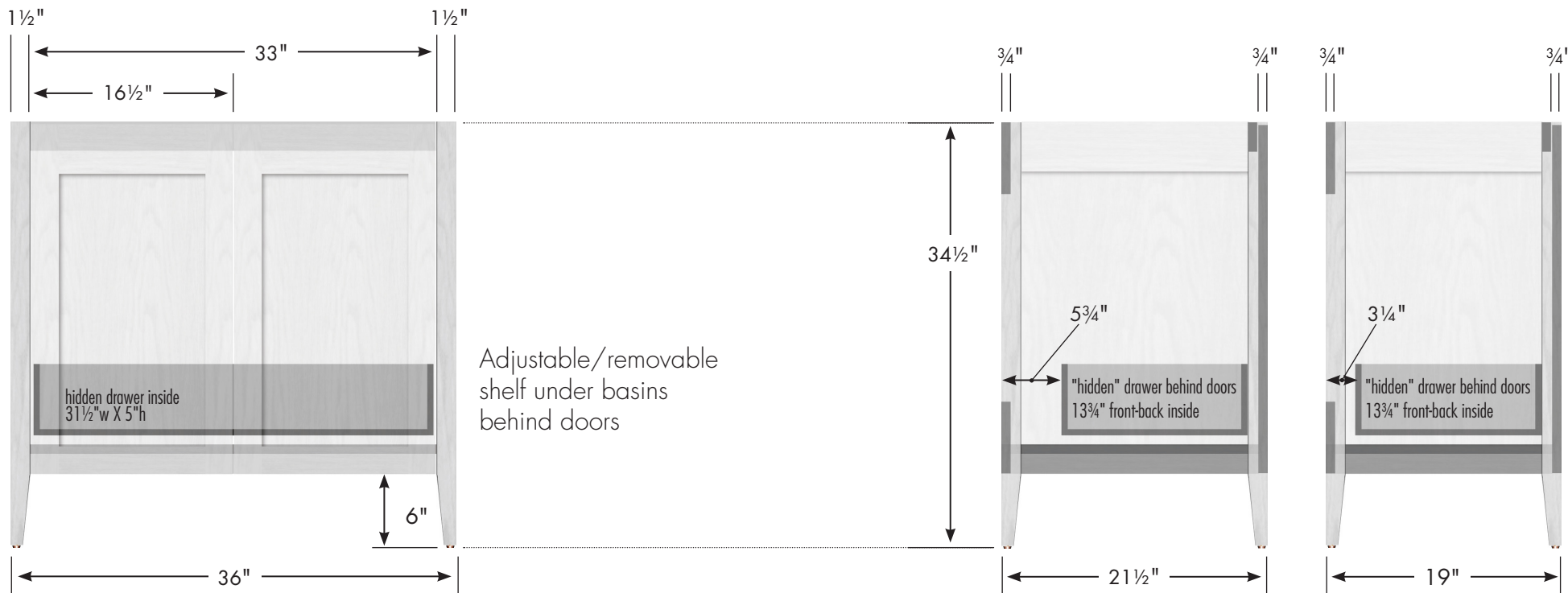

36" Newhalem Vanity
No Side Drawers
 36" wide
 34½" tall
 21½" or 19" front-to-back



Vanity back clear openings for plumbing
 (may need to cut adjustable shelf)

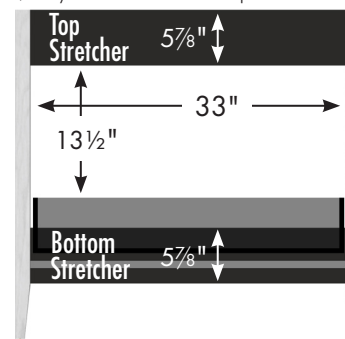

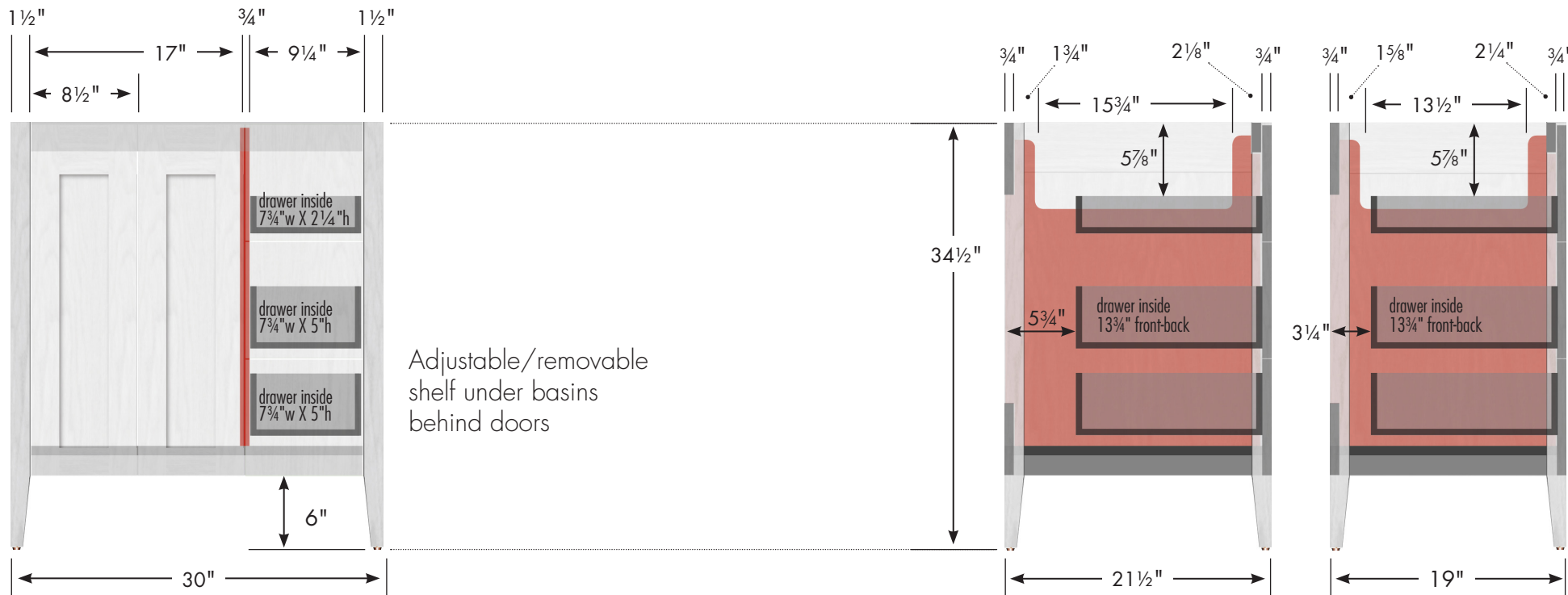

internal dividers

Vanity back clear openings for plumbing
(may need to cut adjustable shelf)

30" Newhalem Vanity
Drawers Right
30" wide
34½" tall
21½" or 19" front-to-back

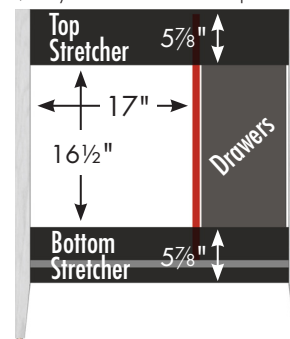

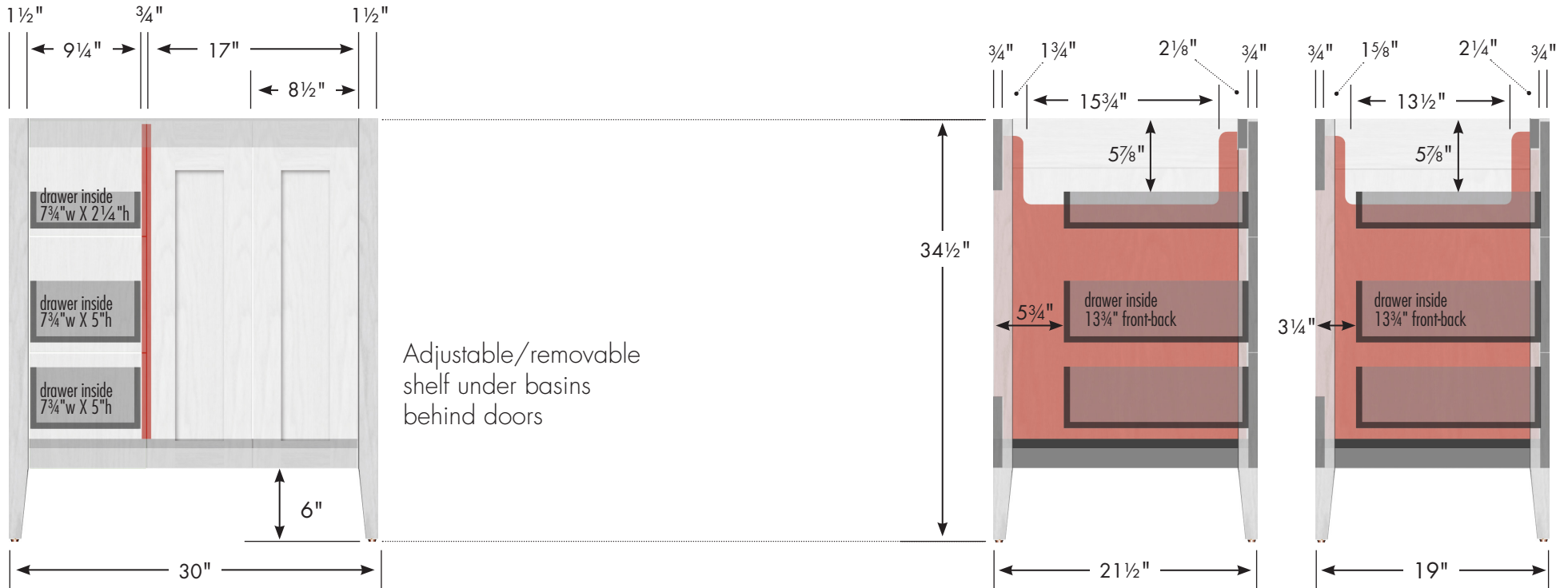

30" Newhalem Vanity
Drawers Left
 30" wide
 34½" tall
 21½" or 19" front-to-back



Vanity back clear openings for plumbing
 (may need to cut adjustable shelf)

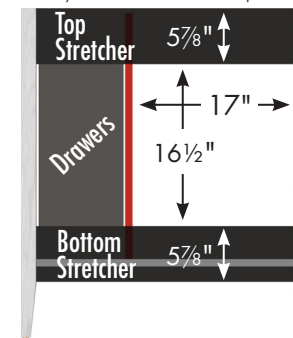

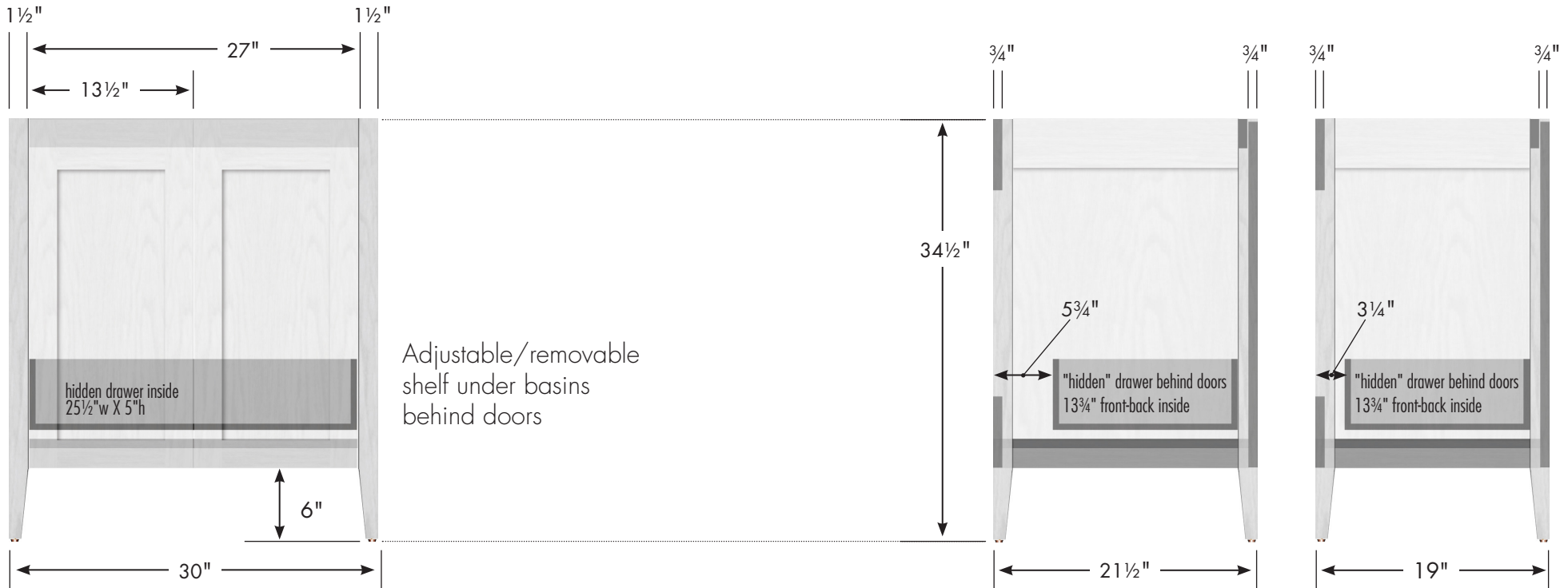

Adjustable/removable shelf under basins behind doors

30" Newhalem Vanity
No Side Drawers
 30" wide
 34½" tall
 21½" or 19" front-to-back



Vanity back clear openings for plumbing
 (may need to cut adjustable shelf)

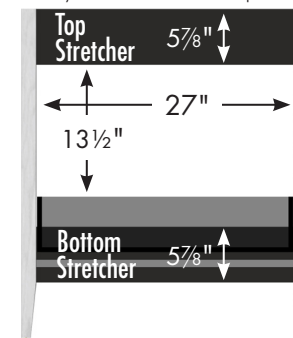

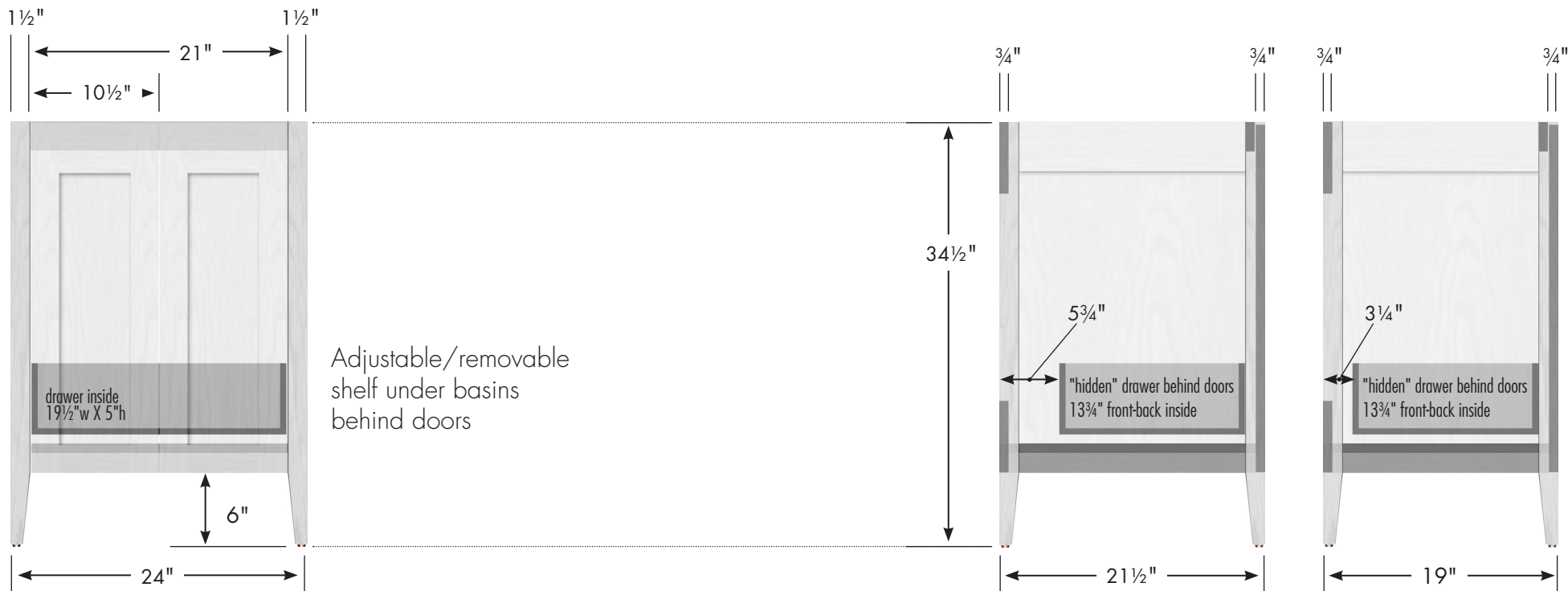

Adjustable/removable shelf under basins behind doors

24" Newhalem Vanity

24" wide
34½" tall
21½" or 19" front-to-back



Vanity back clear openings for plumbing (may need to cut adjustable shelf)

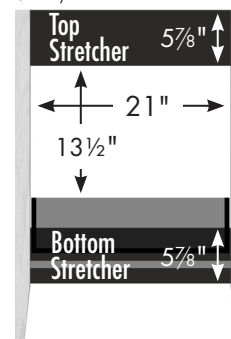

SPECIAL NOTE

Serious or fatal crushing injuries can occur from a linen cabinet tipping over.

To help prevent tipover:

- Install provided tipover restraint
- Place heaviest items in the lower drawers
- Do not place heavy objects on top of this product
- Never allow children to climb or hang on drawers, doors or shelves
- Do not open more than one drawer at a time.

Use of tipover restraints may only reduce, but not eliminate, the risk of tipover.

We supply attachment hardware with your order but some applications may need different/additional hardware. Manufacturer assumes no liability for improper installation or excessive loads placed on screws, brackets or straps.

19½" Newhalem Linen

19½" wide
70" tall
21½" or 19" front-to-back



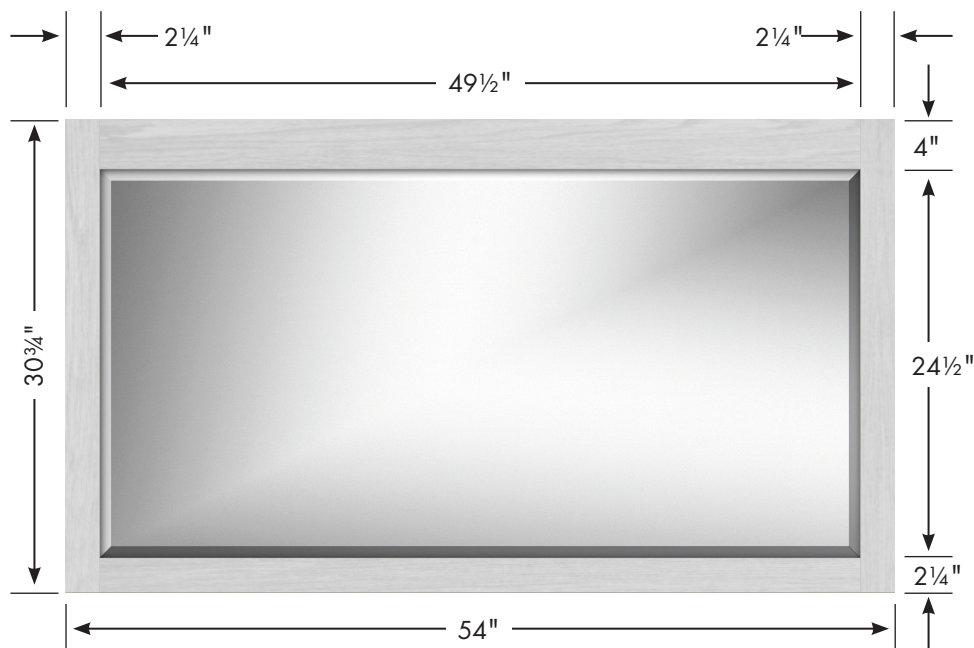

SPECIAL NOTE

These large mirrors with ¹/₄" plate glass are especially heavy and require careful consideration and execution in hanging.

We include attached cleats but you may need to re-install them so that spacing will allow attachment to structural wall studs.

Consult with a professional if you are not familiar with construction practices.

Newhalem Mirror

54" wide
30³/₄" tall

