



Mike & Marlene Calverley, Founders, Calverley Supply Co., Inc.

Since our inception in 1974, Calverley Supply Co. has evolved to become one of Michigan's largest heating, ventilation, and air conditioning (HVAC) wholesale distributors. We take pride in delivering the highest quality products and services to our customers. This philosophy has helped us grow into an industry leader, providing the best value for a complete line of HVAC products to customers throughout the Lower Peninsula.

As our many satisfied customers have come to know, Calverley Supply offers not only products and services on which you can depend, but also a convenient, cost-effective partnership that will help your business succeed.

If you have any questions or would like to learn more about what Calverley Supply has to offer, please feel free to call us at any one of our locations or visit our website at [www.calverleysupply.com](http://www.calverleysupply.com)

Sincerely,

Anthony Calverley

Jason Calverley

---

---

## About Calverley

---

---

### Who We Are

Calverley Supply Co is one of Michigan's leading suppliers of the very best products known to the HVAC industry. Our complete inventories and outstanding service set us apart from the competition. Savvy HVAC contractors rely on us for all of their product needs.

Mike and Marlene Calverley founded the company on June 6th, 1974. In the beginning, the Calverleys worked out of their home and made deliveries with the family car. Since then, we've grown impressively, developing many enduring partnerships with our vendors and customers along the way.

Our founding vision was based on providing top quality products at fair prices, with value added to every transaction. With Calverley sons Anthony and Jason now in charge, that vision continues to inspire us for the present and future.

Today, we have seven fully stocked locations spanning the state. Headquartered in Sterling Heights, we have additional Detroit metro locations in Livonia, Waterford, and Almont, plus branches in Lansing, Grand Rapids and Saginaw. We support all of your HVAC needs from these sites, providing the kind of friendly, trustworthy personal service our customers have come to expect.

We know you have choices out there, and we appreciate your business. As we look to the future, we eagerly anticipate building new relationships based on our strong work ethic, vast inventories, competitive pricing and sheer dedication to helping our customers succeed.

### CALVERLEY CAPABILITIES ARE THE REASONS TO CALL US FIRST!



(Left) Anthony Calverley and  
(right) Jason Calverley

- 1) We care about your business and will go the extra mile
- 2) Large (In Stock) Inventory
- 3) Experienced, knowledgeable, trustworthy sales people
- 4) Competitive pricing with the most value added services
- 5) Friendly, helpful counter staff to service you quickly and accurately
- 6) Seven statewide facilities for convenient pickup
- 7) High quality industry leading residential and commercial product
- 8) Free job-site or storefront delivery from our veteran warehouse and delivery crew
- 9) Willingness to work through any difficult situation
- 10) Trustworthy, likeable, and caring employees!!!!!!!

### Mission Statement

From our humble beginning in 1974 through today, we at Calverley Supply have and will always strive to build long-term quality professional relationships with our customers. We will continue to bring the very best products known to the HVAC industry to the market place. Value added service and communication will always be held at the highest priority with our customers and vendors. We pride ourselves on our commitment to serve as a one-stop-shop for all the HVAC needs for the Add On/Replacement, New Construction and Light Commercial contractors through all of our seven locations. Our employees know that our continued success goes hand in hand with our customers continued success.

---

---

## Inventory, Delivery, & Our Team

---

---



### Vast In-Stock Inventory

Calverley Supply's large branch warehouses are your complete "one-stop shop." We keep everything you need in stock at every one of our branches. That's our standard for the kind of quality service our valuable customers deserve. Providing full support for your entire job at a single location is just one way we show you how important your business is to us. We can keep you supplied with parts for your service trucks as well. **From the smallest screw to 25-ton rooftop units, we've got you covered.**

### Top Product Lines

What good is having a lot of products if they don't last! Calverley Supply Company can assure you get excellent quality because we are aligned with some of the very best HVAC manufacturers on the planet. We handle Luxaire as our main equipment line. Names like Selkirk-Metalbestos, White-Rodgers, Slant/Fin, GeneralAire, Empire Comfort Systems, Modine, Fujitsu, State Industries, and Owens Corning also abound in our inventory. We are proud to have the resources and reputation to be a preferred distributor of their fine products. Calverley has the buying power to negotiate good deals and keep our inventories at the highest levels. Bringing you the best products at highly competitive prices is always one of our major goals.

### Timely Delivery - No Problem!

**Calverley Supply** provides job-site or storefront delivery. Our vehicles and veteran delivery team are on the road everyday, bringing your HVAC products to you where and when you need them. We coordinate our shipping activities to meet your schedules. For example, we can arrange delivery of a rooftop unit to coincide with your crane rental. We know your time is valuable. Our goal is to help you stay focused on core profit-making installation activities while we see that all your equipment requirements are met. Our experienced counter people also save you time when you are picking up products at our locations. We fill your order quickly and get you on your way! **At Calverley Supply, the customer is king.**

### Customer-Friendly Team

**At Calverley Supply**, our friendly, caring employees operate as a cohesive team. There is no bureaucracy here. Management and staff work closely to promote fast and efficient response to customer requirements. If any difficulty arises, you can trust our caring people to work through it to your satisfaction. Though our company has grown and expanded over the decades, we never lose sight of our customer-oriented roots.

# IMPORTANT - TERMS AND CONDITIONS

## **Pricing: Subject to Change Without Notice:**

All Prices in this catalog are meant to be used as a guide only for comparison with other items in this catalog. The list pricing is subject to change without notice. Due to the constant fluctuation of our costs from vendors, we can not guarantee pricing. We encourage your request for net price sheets when exact prices must be known. List prices do not include State, Federal or other taxes where applicable.

## **Credit:**

All orders received are subject to credit approval unless full payment is received at time of shipment or delivery. For credit line approval call (586) 979-1370.

## **Terms:**

Orders received in one month are due and payable on or before the 10<sup>th</sup> of the following month. Invoices dated in one month will be considered past due if payment is not received on or before the 30<sup>th</sup> of the following month. A service charge of 1-1/2% per month will be made on all past due invoices.

## **Warranties:**

Warranty returns must be made within 30 days of Failure, and shall be limited to guarantees covered by the manufacturer.

## **Return Goods:**

We have a 25% restocking fee on APPROVED returns. All products being returned must have prior written approval. Electrical products, custom made material, special orders, non-stocks and items that cannot be sold as new may not be returned for credit.

## **Return Policy:**

- 25% re-stocking charge
- Customer must have receipt
- Special orders not returnable
- No returns on electrical parts
- Item must be in original carton and in saleable condition
- No returns after 45 days

## **Delivery Shortage and Damaged Materials:**

All material should be inspected during the receiving process. Any shortages or damaged material must be claimed with the driver at the time of delivery. If the product is delivered by common carrier, all claims must be made with the trucking company.

## **Returned Checks:**

All checks returned unpaid by your bank will be charged a return check charge currently at \$30.00 subject to change without notice.

## **Code Compliance:**

The State of Michigan has codes and regulations governing the sale, installation and use of products for specific purposes. Calverley Supply does not guarantee compliance with such codes and regulations and is not responsible for how products are installed or used. Please refer to all installation instructions and applicable codes and regulations when purchasing merchandise.

## **Catalog:**

All items in this catalog are based off of information given by the manufacturers at the time of publication. Such information being subject to clerical error and subject to change without notice, is therefore presented as a convenience for estimating purpose only. Please call any of our locations for current up-to-date information when necessary.

**Calverley Supply Co., Inc.**

**Sterling Heights**

Main Branch & Corporate Headquarters  
6306 15 Mile Road  
Sterling Heights, MI 48312  
Hours: Monday - Friday (7:30 - 5:00)  
Phone: (586) 979-1370 Fax: (586) 979-3937

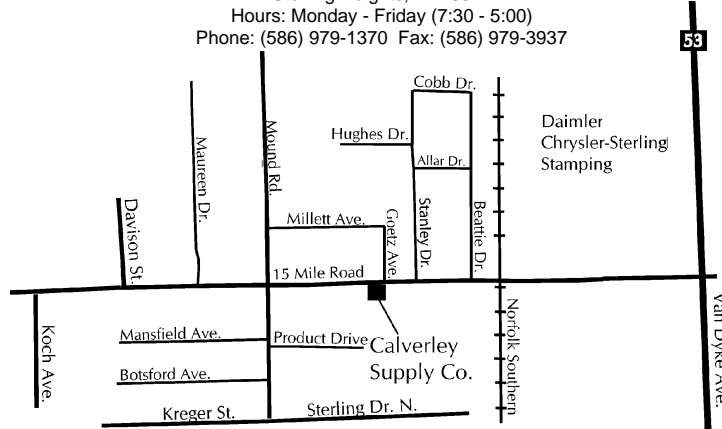

**Lansing**

5636 Commerce Drive  
Lansing, MI 48911  
Hours: Monday - Friday (7:30 - 4:30)  
Phone: (517) 887-2424 Fax: (517) 887-6226



**Livonia**

38995 Schoolcraft  
Livonia, MI 48150  
Hours: Monday - Friday (7:30 - 5:00)  
Phone: (734) 462-1108 Fax: (734) 462-2563

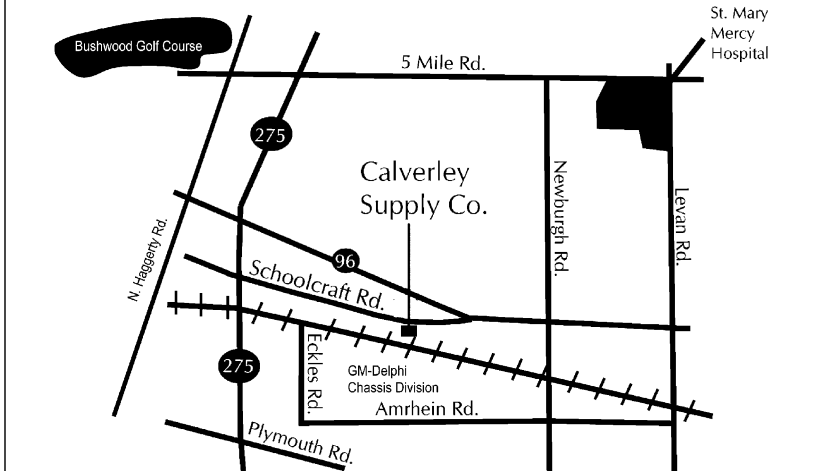

**Sterling Hts, MI - Livonia, MI - Lansing, MI - Grand Rapids, MI - Waterford, MI - Almont, MI - Saginaw, MI**

**Calverley Supply Co., Inc.**

**Waterford**

1165 Seba Rd.  
Waterford, MI 48328  
Hours: Monday - Friday (7:30 - 4:30)  
Phone: (248) 674-7132 Fax: (248) 674-7309

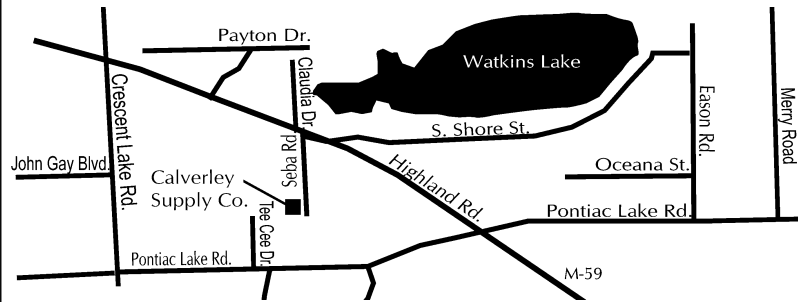

**Grand Rapids**

2748 Courier Drive N.W.  
Grand Rapids, MI 49534  
Hours: Monday - Friday (7:30 - 4:30)  
Phone: (616) 791-8580 Fax: (616) 791-8766

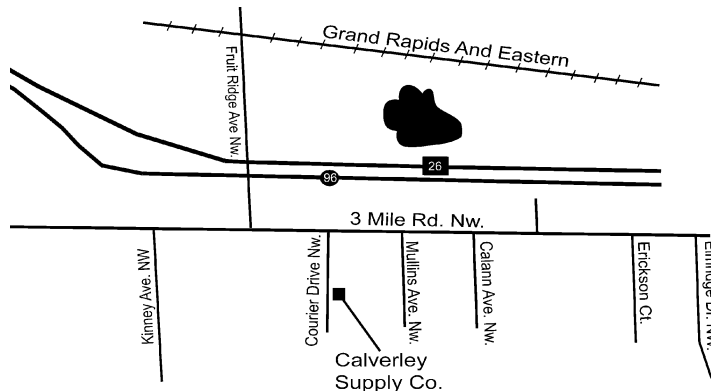

**Almont**

3644 Van Dyke  
Almont, MI 48003  
Hours: Monday - Friday (7:30 - 4:30)  
Phone: (810) 798-0551 Fax: (810) 798-0342

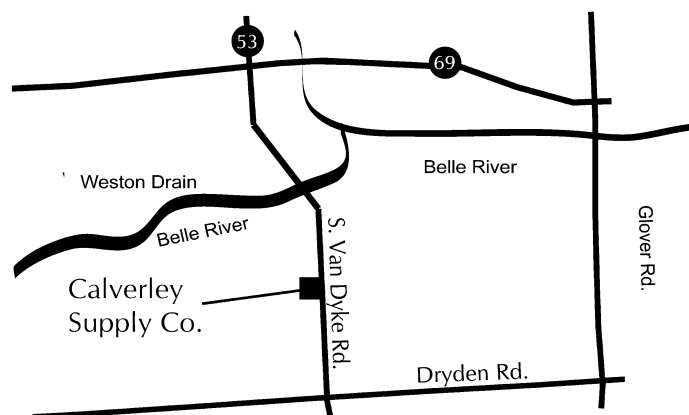

**Calverley Supply Co., Inc.**

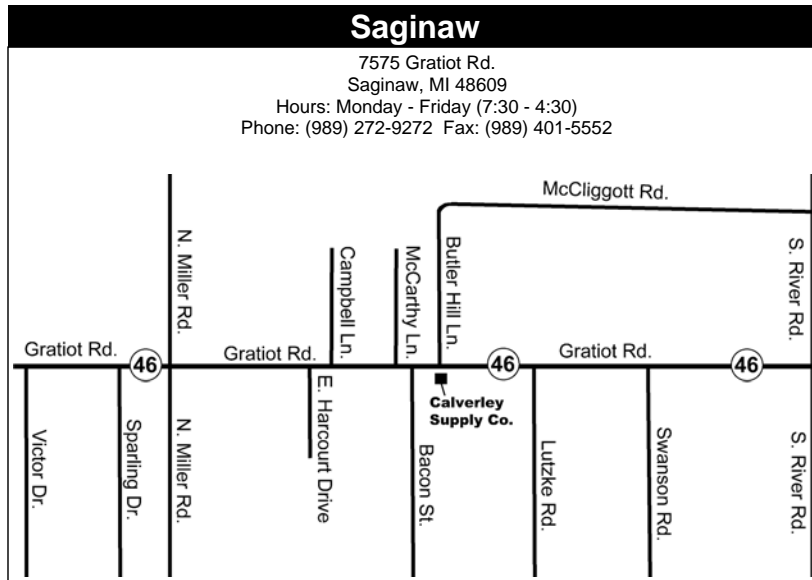

### AIR CLEANERS

Field Controls (Air Cleaners)  
GeneralAire (Media)  
Honeywell (Media Replacement)  
Luxaire (Electronic & Media)  
Repair and Cleaning Service  
Trion (Air Cleaners & Media)  
UV Lights - Field Control  
White Rodgers -(Media Repl)

### AIR COND. SUPPLIES

A/C Covers (Special Order)  
Aspen A/C Coils  
Beckett Pumps  
Bramec Fittings  
Coil Cleaners  
Condenser Pads  
Copper Fittings  
Diversitech Pumps  
Gas Exchanges  
Hard Start Kits  
Harris Solder,Flux & Torches  
Linesets - Standard & Minisplit  
Little Giant Pumps  
Mighty Bracket  
Novent Ref. Locking Caps  
NuCalgon RX-11 & Chemicals  
PVC Pipe & Fittings  
R22,R410A,R421A,R407C  
Refrigeration Fittings  
Saueremann Lineset Hide  
Saueremann Mini-Split Pumps  
Sharkbite Fittings  
Easy Seal  
Yellow Jacket Pumps & Gauges  
Watsco Products

### BLACK PIPE

1/2" - 3/4" - 1" x 10' Black Pipe  
Flexible Gas Pipe Connector  
Flexible Gas Piping -TracPipe  
Malleable Fittings & Nipples

### BLOWERS & WHEELS

Belt & Direct Drive Wheels  
Blowers Wheels  
Fan Blades & Hubs  
Pulleys & Shafts

### CHIMNEY / VENTING

Chimney Liner Kits 25' & 35'  
Class "A" All Fuel Venting  
Class B Pipe & Fittings- 3"-14"  
Double Wall 4" Flex. Gas Vent  
Oval Pipe & Fittings

### CONTROLS

Duct Detectors  
Honeywell  
ICM Controls  
ISI - Ignitors  
Jackson Temp. Stat  
Neuco Controls  
Stat Guards  
Source 1 - Luxaire, York, Fraser  
Johnston, Coleman, Guardian  
White Rogers  
Zebra Instruments

### DAMPERS

Arzel Zoning Systems  
Barometric Dampers  
Ceiling Radiation - Special Order  
Die Lock  
Durozone Dampers  
Field Control Ventilation Damper  
Fire Dampers - Special Order

### ELECTRICAL

A/C Convenience Whips  
Alum Service Cable  
Conduit & Straps  
Connectors & Wire Nuts  
Disconnects & Fuses  
Greenfield & Romex Wire  
Mini-Split Wire  
Thermostat Wire

### EQUIPMENT

Concentric Diffusers Available  
Curb Adapters Available  
Empire Comfort Products  
Empire Fireplaces - Direct Vent  
Fujitsu Mini-Splits  
Geothermal Equipment  
Guardian Mobile Home  
Luxaire Residential  
Luxaire Rooftop 2 to 25 Ton  
Magic-Aire Air Handlers -  
Special Order  
Modine Hot Dawg Unit Heaters,  
M.U.A. & Tube Heaters  
Monsma Wood Burning  
Fireplaces  
Olsen Oil Furnaces - DMO  
Special Order  
PTAC'S - Special Order  
Portable A/C's - Special Order  
Spacepak - Hi Velocity  
State Water Heaters -  
Residential & Commercial  
Tankless State Water Heaters

### FANS & ACCESSORIES

Broan Products  
D&W Rotor Vents  
Delta Breez  
Duct Boosters  
Famco Roofcaps  
Fantech Fans - Special Order  
Field Controls  
S & P Fans Special Order  
Tjernlund - Special Order

### FASTENERS

Arrow Stapler & Staples  
Basset Products  
B-Line Products - Strut  
Bostich Staples  
Caddy Clips & Beam Clamps  
Duro Dyne Products  
Malco Screws & Rivets  
Nylon Ties  
Panning Nails / Anchor Kits  
Quick Sling Stands & Hangers  
Threaded Rods & Couplings

### FILTERS

Disposable Filters 1" & 2"  
General Media  
Honeywell Filters  
Luxaire Filters  
Pleated Filters 1",2" & 4"  
Space Guard Media  
Trion Air Bear Media  
White Rodgers Media  
We Special Order Filters

### FLEX / INSULATION PROD.

Dif-Flex Aluminum Flex  
Insulated & Uninsulated -  
Flex & Sleeve R4.2,R6,R8  
Owens Corning -  
Duct Board - 1" & 1-1/2"  
Duct Liner - 1/2" & 1"  
Foil Duct Wrap - R4.2.R6.R8.5  
Foil Insulation Bubble Wrap

### GALVANIZED

Cold Air Drops  
Complete Line of Pipe  
Custom Galvanized &  
Duct Board  
Fittings & Accessories -  
3" to 24" & Special Order  
Flange Products -  
Commercial by Ward & Family  
Flat Stock Sheets -  
Assorted Sizes & Gauges  
Gray Metal Products  
Metal Access Doors  
Oval Pipe & Fittings  
Spiral Galvanized - 6"-16"  
Special Order  
Thermo Panning  
Trunkline

### HUMIDIFIERS

Aprilaire Pads  
Auto Flo Parts  
General Aire  
Honeywell Pads  
Lobb Pads & Parts  
Luxaire  
Make Up Air Units  
Skuttle Parts

### HYDRONICS

Antifreeze - Noburst  
Boiler Accessories -  
Controls,Valves,Purgers,etc..  
Chemicals -  
Cleaner,Lubricant, Leak Stop  
Expansion Tanks  
Grundfos Pumps  
Heat Transfer Products  
Indirect Fired Water Heaters  
Pex & Manifolds  
SlantFin - Boilers & Baseboard  
Taco Pumps  
Toe Kick Heaters -Twin Flow III

### MISCELLANEOUS

Aluminum Pipe & Hoods  
Brass Fittings

### MISCELLANEOUS - Cont.

Copper Pipe & Fittings  
Deflecto Vent Hoods  
Gas Cocks  
1/2" - 3/4" - 2" - 2 1/2" - 3"  
PVC Pipe & Fittings  
1/2" & 3/4" CPVC Pipe & Fittings  
Rooftop Blocks  
Tough Pads (knee pad)

### MOTORS

Belt & Direct Drive Motors  
Capacitors  
Condensing Motors  
ECM Rescue Motors  
Motor Mounting Kits  
Replacement Ventor Motors  
Timesaver Universal Motors

### OIL

Olsen Furnaces -Special Order  
Replacement Oil Cartridges

### PCD UNDERGROUND

Pipe & Fittings 6" to 16"  
- Special Order

### REGISTERS

2 x 2 Ceiling diffusers  
Continental Residential  
Easy Air Products  
Egg Crate  
Paramount Register Frames  
Reliable Commercial (Alum)

### TAPE & PAINT

PCD-Electrical-Cork-Insulation  
Covalence Adhesives -  
Polyken Kendall Tapes  
Variety of Spray Paint  
Wasp Spray

### TARS-DOPE-GLUE-CAULK

Dark Cutting Oil  
DeWitt Roofing Products  
Duro Dyne Adhesives  
Fire Caulk  
Furnace Cement  
Hardcast Duct Seal & Tapes  
PVC Glues & Cement  
Silicone Caulk - Assorted

### TOOLS

Arzel Tool Kit  
Cimport SSPIN & FSPIN  
Ebinger Tools (EMC)  
Fieldpiece Testers  
Harris Torch Kits  
Lenox Hole Saws & Blades  
Malco Hand Tools  
Midwest Tools  
Smart Tools  
Spectronics Testers  
Turbo Torch Kits  
Yellow Jacket

### V-BELTS

A/4L - B/5L - AX - BX



	<b>Customer Service #</b> (248) 332-3900 <b>Web Site:</b> www.ap-ccom		<b>Technical Support #</b> (800) 367-6668 <b>Web Site:</b> www.dormont.com
	<b>Customer Service #</b> (800) 611-8312 <b>Web Site:</b> www.arzelzoning.com		<b>Customer Service #</b> (800) 899-3876 <b>Web Site:</b> www.durodyne.com
	<b>Customer Service #</b> (800) 423-9007 <b>Web Site:</b> www.aspenmfg.com	 A BRAND OF THE NIDEC MOTOR CORPORATION	<b>Customer Service #</b> (855) 487-6686 <b>Web Site:</b> www.usmotors.com
	<b>Customer Service/Tech #</b> (800) 433-7184 <b>Web Site:</b> www.atcoflex.com		<b>Customer Service #</b> (800) 851-3153 <b>Web Site:</b> www.empirecomfort.com
	<b>Customer Service #</b> (888) 232-5388 <b>Web Site:</b> www.beckett pumps.com		<b>Technical Support #</b> (937)-898-0391 <b>Web Site:</b> www.espcompany.com
	<b>Customer Service #</b> (800) 851-7415 <b>Web Site:</b> www.cooperindustries.com		<b>Technical Support #</b> (800) 800-234-1903 <b>Web Site:</b> www.famcomfg.com
	<b>Customer Service #</b> (847) 683-7990 <b>Web Site:</b> www.bestairpro.com		<b>Technical Support #</b> (800) 742-8368 <b>Web Site:</b> www.fieldcontrols.com
	<b>Customer Service #</b> (800) 558-1711 <b>Web Site:</b> www.broan.com		<b>Technical Support #</b> (714) 634-1844 <b>Web Site:</b> www.fieldpiece.com
	<b>Customer Service/Tech #</b> (888) 368-7233 <b>Web Site:</b> www.buildersbest.com		<b>Technical Support #</b> (888) 888-3424 <b>Web Site:</b> www.fujitsugeneral.com
	<b>Customer Service/Tech #</b> (800) 959-0374 <b>Web Site:</b> www.bassetproducts.com		<b>Customer Service/Tech #</b> (866) 476-5101 <b>Web Site:</b> www.generalaire.com
	<b>Customer Service/Tech #</b> (800) 735-5272 <b>Web Site:</b> continentalindustries.com		<b>Customer Service</b> (585) 226-9660 <b>Web Site:</b> www.graymetal.com
	<b>Customer Service/Tech #</b> (800) 589-5553 <b>Web Site:</b> www.cresline.com		<b>Customer Service</b> (913) 227-3400 <b>Technical Support #</b> (800) 333-1366 <b>Web Site:</b> www.grundfos.com
	<b>Customer Service #</b> (800) 665-4328 <b>Web Site:</b> www.deflecto.com		<b>Technical Support #</b> (888) 229-2199 <b>Web Site:</b> www.carlislehvac.com
	<b>Customer Service #</b> (800) 995-2222 <b>Web Site:</b> www.diversitech.com		

Sterling Hts, MI - Livonia, MI - Lansing, MI - Grand Rapids, MI - Waterford, MI - Almont, MI - Saginaw, MI

	Customer Service/Tech # (800) 733-4533 Web Site: www.harrisproductsgroup.com		Customer Service # (800) 328-3530 Web Site: www.malcotools.com
	Customer Service/Tech # (800) 323-9651 Web Site: www.htproducts.com		Technical Support # (800) 445-4155 Web Site: www.marsdelivers.com
	Customer Service # (800) 328-5111 Technical Service # (800) 468-1502 Web Site: www.honeywell.com		Customer Service # (800) 782-4659 Web Site: www.midwestsnips.com
	Customer Service/Tech # (800) 222-0060 Web Site: www.genescable.com		Customer Service # (469) 209-6500 Web Site: www.mitexint.com
	Customer Service/Tech # (800) 365-5525 Web Site: www.icmcontrols.com		Customer Service # (800) 828-4328 Web Site: www.modinhvac.com
	Technical Support # (888) 652-9663 Web Site: www.jacksonsystems.com		Technical Support # (866) 635-6888 Web Site: www.ndlinc.com
	Technical Support # (586) 268-1220 Web Site: jomar.com		Technical Support # (800) 878-5788 Web Site: www.noblecompany.com
	Technical Support # (800) 645-2860 Web Site: www.lambro.net		Customer Service # (800) 554-5499 Web Site: www.nucalgon.com
	Technical Support # (888) 995-7414 Web Site: www.lascofittings.com		Customer Service # (800) 321-9532 Web Site: www.oatey.com
	Technical Support # (800) 752-2082 Web Site: www.legendvalve.com		Customer Service# (800) 671-8622 Web Site: www.omegaflex.com
	Customer Service # (800) 628-3030 Web Site: www.lenoxsaw.com		Technical Support # (800) GET-PINK Web Site: www.owenscorning.com
	Customer Service # (849) 250-4982 Web Site: www.littlegiant.com		Technical Support # (800) 334-1769 Web Site: www.packardonline.com
	Customer Service/Tech # (800) 536-6112 Technical Service # (877) 874-7378 Web Site: www.luxaire.com		Customer Service # (937) 219-8552 Web Site: paramountconceptsltd.com
			Customer Service # (800) 328-4822 Web Site: www.berryplastics.com

	<p><b>Customer Service #</b> (866) 247-4827 <b>Web Site:</b> www.purolatorair.com</p>		<p><b>Customer Service/Tech #</b> (800) 365-8170 <b>Web Site:</b> www.statewaterheaters.com</p>
	<p><b>Customer Service/Tech #</b> (800) 699-0453 <b>Web Site:</b> www.quick-sling.com</p>		<p><b>Customer Service #/Tech #</b> (800) 925-4440 <b>Web Site:</b> www.stylecrestproducts.com</p>
	<p><b>Customer Service/Tech #</b> (800) 231-3345 <b>Web Site:</b> www.rectorseal.com</p>		<p><b>Customer Service #/</b> (800) 331-9125 <b>Web Site:</b> www.supco.com</p>
	<p><b>Customer Service/Tech #</b> (800) 239-4621 <b>Web Site:</b> www.reliablehvac.com</p>		<p><b>Customer Service/Tech #</b> (401) 942-8000 <b>Web Site:</b> www.taco-hvac.com</p>
	<p><b>Customer Service/Tech #</b> (800) -769-8370 <b>Web Site:</b> www.yellowjacket.com</p>		<p><b>Customer Service/Tech #</b> (250) 545-7749 <b>Web Site:</b> www.tekmarcontrols.com</p>
	<p><b>Customer Service #</b> (631) 234-7600 <b>Web Site:</b> www.sauermannpumps.us</p>		<p><b>Customer Service/Tech #</b> (888) 678-3709 <b>Web Site:</b> www.thermopan.com</p>
	<p><b>Technical Support #</b> (800) 848-2149 <b>Web Site:</b> www.selkirkcorp.com</p>		<p><b>Customer Service/Tech #</b> (800) 844-0002 <b>Web Site:</b> www.trioniaq.com</p>
	<p><b>Customer Service/Tech #</b> (877) 700-4242 <b>Web Site:</b> www.cashacme.com</p>		<p><b>Customer Service/Tech #</b> (248) 318-5001 <b>Web Site:</b> www.turbotorch.com</p>
	<p><b>Customer Service/Tech #</b> (888) 758-8853 <b>Web Site:</b> www.skuttle.com</p>		<p><b>Technical Support #</b> (800) 777-7473 <b>Web Site:</b> www.united-pipe.com</p>
	<p><b>Customer Service</b> (516) 484-2600 <b>Technical Support #</b> (800) 873-4346 <b>Web Site:</b> www.slantfin.com</p>		<p><b>Technical Support #</b> (888) 725-9797 <b>Web Site:</b> www.white-rodgers.com</p>
	<p><b>Customer Service #</b> (800) 536-6112 <b>Technical Service #</b> (877) 874-7378 <b>Web Site:</b> www.source1parts.com</p>		<p><b>Customer Service/Tech #</b> (888) HI-ZEBRA <b>Web Site:</b> www.zebrainstruments.com</p>
	<p><b>Technical Support #</b> (413) 564-5530 <b>Web Site:</b> www.spacepak.com</p>		
	<p><b>Technical Support #</b> (800) 274-8888 <b>Web Site:</b> www.spectroline.com</p>		

Sterling Hts, MI - Livonia, MI - Lansing, MI - Grand Rapids, MI - Waterford, MI - Almont, MI - Saginaw, MI



## A. Equipment

1. Special Orders.....	1
2. Luxaire Serial Number Nomenclature 1981-2004.....	2
3. Luxaire Serial Number Nomenclature After 2004.....	3
4. Luxaire Residential Heating & Cooling.....	4
5. Guardian Residential Heating & Cooling.....	12
6. Luxaire Cased Coils.....	14
7. Luxaire Extended Warranties.....	16
8. Source 1 Air Conditioner & Furnace Accessories/Luxaire IAQ.....	18
9. Aspen Evaporator Coils.....	21
10. Luxaire Commercial Equipment.....	24
11. Air Products and Controls.....	37
12. Fujitsu Heating & Cooling Equipment.....	38
13. Flaretite Products.....	50
14. Llneset Hide.....	50
15. VRF Mini-Splits.....	52
16. Fujitsu Airstage Parts & Accessories.....	58
17. Spacepak Mini Duct Systems & Accessories.....	61
18. Modine Heaters.....	67
19. Modine Make Up Air Quote Request Form.....	70
20. Modine Replacement Make Up Air Quote Request Form.....	71
21. Empire Residential Furnaces & Accessories.....	72
22. Empire Fireplaces & Accessories.....	72
23. State Water Heaters.....	74
24. Manufactured Housing Equipment.....	83
25. Roof Jack Selection Info.....	86

## B. Indoor Air Quality

1. GeneralAire IAQ Products.....	87
2. GeneralAire Fuel Oil Replacement Cartridge.....	93
3. Nucaigon IAQ Product.....	93
4. Field Controls Air Purification Systems.....	94
5. Aprilaire Air Cleaners.....	95
6. Honeywell Air Cleaners & Accessories.....	96
7. Lobb Humidifiers & Parts.....	96
8. Autoflo Humidifier Parts & Accessories.....	96
9. Skuttle Humidifier Parts & Accessories.....	97
10. Trion Media Air Cleaners & Accessories.....	97
11. Air Filters.....	98
12. Honeywell Zoning.....	100
13. Duro Dyne Zoning.....	101

# Table of Contents



---

## B. Indoor Air Quality (Cont)

14. Arzel Zoning.....	102
-----------------------	-----

## C. T-Stats & Controls

1. White-Rodgers Thermostats & Controls.....	105
2. Ecobee Thermostats.....	118
3. Honeywell Thermostats & Controls.....	118
4. Universal Igniters.....	124
5. Starlite Hot Surface Igniters.....	125
6. Starlite Cross Reference.....	126
7. Cam-Stat Controls.....	128
8. ICM Corp. Controls.....	128
9. Jackson Systems Thermostats.....	129
10. Diversitech Thermostat Guards.....	130

## D. A/C Supplies

1. Harris Brazing & Soldering Products.....	131
2. Turbotorch Torches & Torch Kits.....	132
3. Gas & Tanks.....	133
4. Refrigerant.....	133
5. Linesets.....	134
6. Lineset Flex Guards.....	135
7. Copper Refrigeration Tubing.....	135
8. Therm-O-Mfg A/C Supplies.....	136
9. Diversitech A/C Supplies.....	136
10. Source 1 A/C Supplies.....	137
11. Diversitech A/C Supplies.....	137
12. 5-2-1 Capacitors.....	138
13. Little Giant Pumps & Accessories.....	138
14. Beckett Pumps.....	139
15. MA-Line Nylon Barbed Fittings.....	140
16. Bramec Thumb Gum.....	141
17. Robinair Tools & Testers.....	141
18. Yellow Jacket Refrigeration Products.....	141
19. J/B Industries A/C Supplies.....	144
20. NuCalgon Cleaners & Accessories.....	144
21. Oatey Leak Detector.....	149
22. Diversitech Leak Detector.....	150

## E. Hydronics

1. Slant/Fin Baseboard.....	151
2. Slant/Fin Boilers.....	153
3. Heat Transfer Products.....	155
4. Beacon/Morris.....	156
5. Expansion Tanks.....	156
6. Grundfos Pumps & Accessories.....	156
7. Tekmar.....	157
8. Hydronic Products.....	158
9. Anti-Freeze Products.....	159
10. Boiler Cleaner & Stop Leak.....	159
11. PVC Schedule 40 Hydronic Fittings.....	160
12. Cash Acme Valves.....	160
13. Honeywell.....	160
14. Legend Valve & Fitting, Inc.....	162
15. Webstone Hydronic Products.....	163
16. Taco, Inc.....	164
17. McDonnell & Miller.....	165
18. Wilkins Regulator Co.....	165
19. NDL Wrot Copper Fittings.....	165

## F. Galvanized

1. Galvanized Pipe & Fittings.....	167
2. Paxton Co. Dampers.....	178
3. Thermo Panning Products.....	178
4. Galvanized Sheets.....	179
5. Spiral Galvanized & PCD Underground Duct.....	180
6. Commercial Duct Products.....	181
7. DuroDyne Galvanized Duct Products.....	182

## G. Ventilation

1. Selkirk Type "B" Gas Vent Pipe & Fittings.....	183
2. Selkirk Chimney Systems.....	187
3. AL29-4C Single Wall Vent Pipe & Fittings.....	187
4. National Chimney Products.....	188
5. Field Controls Draft, Venting, & Combustion Air Products.....	189
6. Broan Ventilation Products.....	190
7. Delta Breez Ventilation Fans.....	192
8. Famco Roof Caps.....	193
9. Deflect-O Ventilation Products.....	193

# Table of Contents



---

---

## G. Ventilation (Cont)

10. Lambro Wall Vent Hoods.....	194
11. D & W Grilles.....	194
12. Builder's Best Pipe & Fittings.....	194
13. Diversitech Ventilation Products.....	195
14. Special Orders.....	195

## H. Registers & Grilles

1. Continental Industries Registers, Grilles, & Diffusers.....	197
2. Paramount Concepts Installation Frames.....	200
3. Egg Crate Louvers.....	200
4. Reliable Registers, Grilles, & Diffusers.....	201
5. Easy Air Diffusers.....	201
6. Special Orders.....	201

## I. Insulation

1. Owens Corning Insulation Products.....	203
2. Atco Flex Duct.....	203
3. rFOIL Duct Insulation Products.....	204

## J. Tools

1. Midwest Snips Tools.....	205
2. Malco Tools.....	206
3. DuroDyne Tools.....	210
4. Diablo Blades, Hole Saws & Tools.....	210
5. Cimport Intl - Flaring/Swaging Tools.....	215
6. Diversitech Tools.....	215
7. Stanley Bostitch Fasteners.....	217
8. J.C. Whitlam Towels.....	217
9. EMC Tools.....	217
10. Misc. Tools.....	218

## K. Testers & Meters

1. Fieldpiece Testers & Meters.....	219
2. AAB Smart Tools.....	222
3. UEI Testers.....	222
4. Diversitech Testers & Meters.....	224
5. MA-Line Smoke Cartridges.....	224



## L. Motors

1. Motors.....	225
2. Ma-Line Mounting Brackets.....	226
3. V-BELTS.....	226
4. Misc Motor Accessories.....	227
5. Diversitech Motor & Capacitors.....	227
6. Source 1 Motors, Blades, Capacitors, Contactors & Wheels.....	229

## M. Piping

1. Black Malleable Iron Pipe & Fittings.....	231
2. Black Pipe Nipples.....	232
3. OmegaFlex Flexible Gas Pipe & Fittings.....	233
4. PVC Pipe.....	235
5. PVC Sch 40 Fittings.....	235
6. PVC Sch 40 P-Traps.....	237
7. CPVC Pipe & Fittings.....	237
8. Copper Refrigeration Tubing.....	239
9. NDL Wrot Copper Fittings.....	240
10. Copper Press Fittings.....	241
11. Brass Gas Ball Valves.....	242
12. Legend Valves & Fittings.....	242
13. Insulated Tubing & Misc Brass/Black Pipe Fittings.....	242
14. Special Orders.....	243

## N. Tapes & Sealants

1. Polyken Tapes & Adhesives.....	245
2. Diversitech Tapes & Sealants.....	246
3. EMC Teflon & Electrical Tape.....	246
4. Caulk Sealants & Adhesives.....	246
5. Oatey Sealants, Primer & Cleaner.....	247
6. Thread Sealant.....	249
7. DeWitts Sealants.....	249
8. Hardcast Sealants and Tapes.....	250
9. DuroDyne Sealants.....	251
10. Special Orders.....	251

## O. Fasteners

1. Malco Fasteners.....	253
2. PrimeSource Nails.....	253

# Table of Contents



---

---

## O. Fasteners (Cont)

3. Cable Ties & Clamps.....	253
4. J T Products Fasteners.....	254
5. Basset Pipe Brackets, Hangers, Hooks, & Straps.....	254
6. B-Line Channels, Channel Hardware, & Channel Fittings.....	256
7. DuroDyne Fasteners.....	258
8. EMC Fasteners.....	258
9. Special Orders.....	259

## P. Electrical

1. Disconnect Boxes.....	261
2. Thermostat Wire.....	261
3. Fuses.....	262
4. Wire & Electrical Supplies.....	262
5. Diversitech Electrical Supplies.....	263
6. EMC Electrical Supplies.....	264
7. Diversitech Fuses.....	264
8. MARS Electrical Supplies.....	264

## Q. Information

1. Important Terminology.....	265
2. Important Conversions.....	267
3. Drill Sizes & Decimal Equivalentents.....	270
4. Important Formulas.....	271
5. Residential Duct Sizing Guide.....	272
6. Airflow VS Temperature Rise.....	273
7. Gas Piping Information.....	274
8. Meter Clocking Method.....	275
9. Compressor Guide.....	276
10. Technical Support & Troubleshooting.....	277
11. Refrigeration Cycle Information.....	279
12. Refrigeration Troubleshooting.....	280
13. Modulating Furnace Fault Codes.....	282
14. Special Orders.....	288

**Special Order**

Equipment



**Fire Dampers, Radiation Dampers**



**FanTech Residential in-line fans, ceiling, duct mounted, roof mounted etc.**

HEAT CONTROLLER, INC.  
Heatcontroller.com

**Packaged Terminal Units(PTAC), Portable Coolers, Packaged Wall Mounted Units, Geothermal**



**Heat Transfer Products Boilers & Parts**



**Linesets Inc - Made to Order Any Length**



**Lloyd Smoke & Fire Dampers**



**Concentric Diffusers, curbs, mixing boxes, supports, etc.**



**Mortex - Hydronic Coils & Custom Commercial Coils**



**Make Up Airs, Direct/Indirect Fired**



**Reznor Special Order Parts**



**Commercial ERV's, Economizers, & Concentric Diffusers**

*Curb Adaptors* – Made to fit exactly over existing curb.

*Custom Aluminum Commercial Registers and Diffusers* – White or Brushed Aluminum – Multi-shutter or Opposed Blade Dampers

*Custom made Galvanized Fittings and Boots* – Plenums, Return Air Drops, Insulated and Non- Insulated Duct etc.

*ERV's & HRV's* - Available from GeneralAire, Honeywell, Lifebreath, & Broan

*Spiral Galvanized Duct and Fittings* - ordered to the Job Specifications.

*Custom made Filters - Made to Size - 1", 2" or 4" - several different merv ratings available*

*Custom made Air Conditioner Covers for winter storage*

**General Information**

**Luxaire Serial Number Information 1981- October 6, 2004**

Equipment

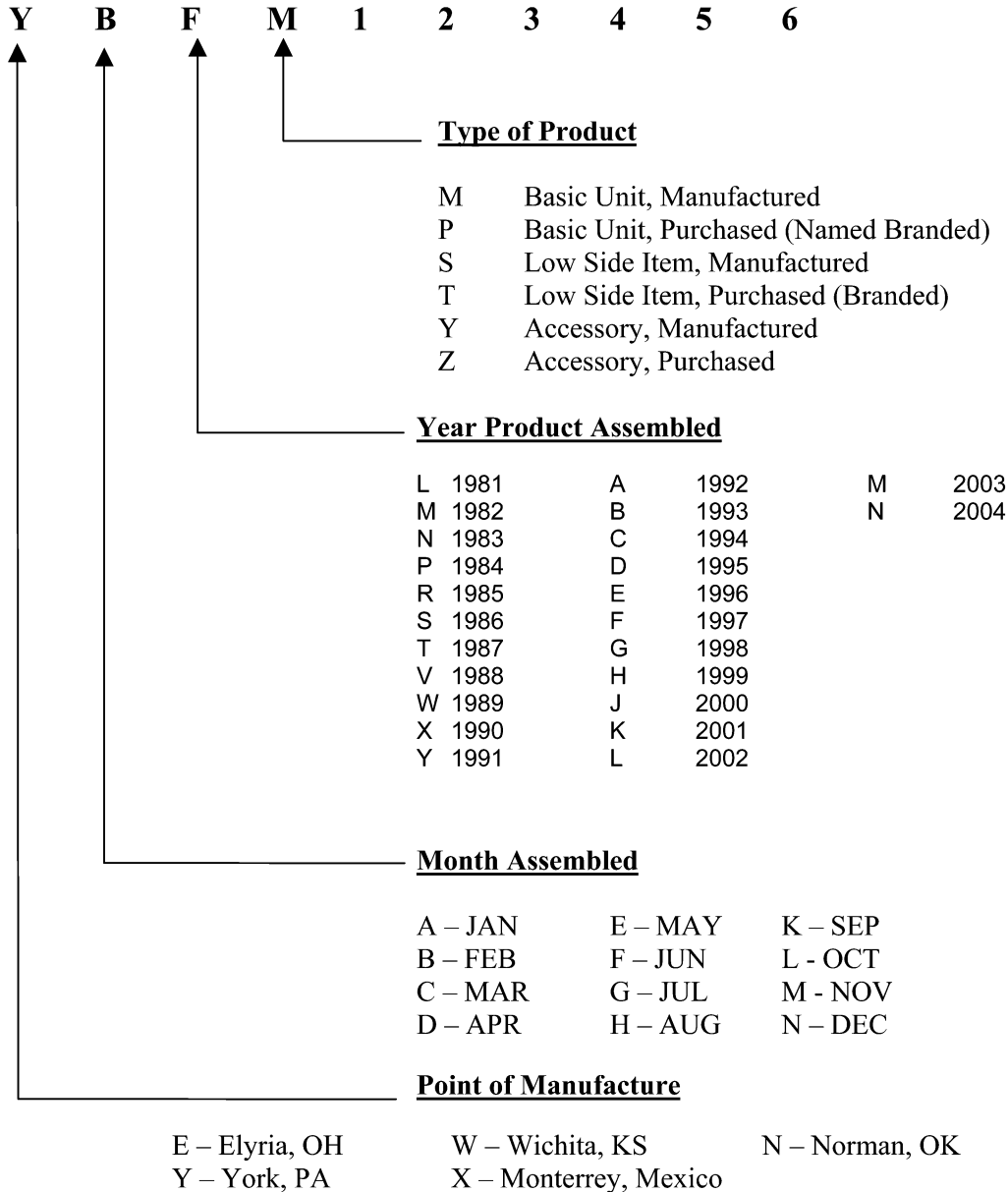

General Information

Luxaire Serial Number Nomenclature  
After October 6, 2004

The letter Represents when it was manufactured

A= January	G= July
B= February	H= August
<b>C= March</b>	<b>K= September</b>
D= April	L= October
E= May	M= November
F= June	N= December

The last 6 digits are a sequenced number

**N0L4123456**

The 0 and the 4 represent the year in which it was manufactured

Example:  
0\*4= 2004  
0\*5= 2005  
1\*6= 2016

The N represents where it was manufactured

N= Norman  
**W= Wichita**  
A= Apodaca (Mexico)  
S= Source 1

**Equipment**

Equipment

**Acclimate AL19B - Up to 19 SEER R410-A 2-Stage Split System A/C - ENERGY STAR**

- Standard 5-Years parts / 10-Years Compressor limited warranty
- Extended 10-Years parts & Limited Lifetime Compressor warranty when registered on-line within 90 days
- Two Speed , Protected Compressor - 67% & 100%
- Communicating Capable - Self-Commissioning on Start-Up with full system check available. MUST USE THX Luxaire stat for Communication functionality.
- Louvered Jacket for an appealing look and coil protection
- A suction accumulator tank protects the compressor from harm
- Composite Base Pan - Corrosion resistant while adding strength and reducing sound
- Liquid line filter-drier / Top Discharge (Ball Bearing ECM Fan Motors)
- 208/230-1-60 / Durable pre-painted steel
- Premium Low operating sound level / U.L. and C.U.L. listed
- **Better Service Access** - Diagonal base valves with open access for low-loss fittings, single panel access to the electrical controls, swing out control box for full corner access, and removable fan guard allow easy access for unit maintenance.



Prod ID#	CSI#	Cooling Tons	Liquid Line OD	Vapor Line OD	Dimensions H x D x W (Inches)	Max Fuse	Compr	Sound (dBA)	TXV	Price
78332	AL19B2421S	2	3/8"	3/4"	40.25 x 38.25 x 34.5	25A	Scroll	68/67	1TVMBH1	5042.27
78333	AL19B3621S	3	3/8"	3/4"	46.5 x 38.25 x 34.5	35A	Scroll	69/73	1TVMBA1	5877.19
78334	AL19B4821S	4	3/8"	7/8"	46.5 x 38.25 x 34.5	45A	Scroll	72/73	1TVMBC1	6437.08
78335	AL19B6021S	5	3/8"	*1-1/8"	46.5 x 38.25 x 34.5	50A	Scroll	74/74	1TVMBC1	6957.68

\* Unit has 7/8" valve, requires a field supplied 1-1/8" x 7/8" adapter

**LX series TC7B - Up to 17 SEER R410-A Split System A/C - ENERGY STAR**

- Standard 5-Years parts / 10-Years Compressor limited warranty
- Extended 10-Years parts limited warranty when registered on-line within 90 days
- QR code on unit allows quick access to technical data and warranty information
- Louvered Jacket for an appealing look and coil protection
- Compressor is internally protected against high pressure and temperature
- Easy access to electrical compartment
- Aluminum microchannel tubing and enhanced aluminum fins
- 18 Gauge G90 galvanized formed base pan
- Liquid line filter-drier / Top Discharge (Ball Bearing Fan Motors)
- 208/230-1-60 / Durable pre-painted steel
- Low operating sound level / U.L. and C.U.L. listed
- **Better Service Access** - Diagonal base valves with open access for low-loss fittings, single panel access to the electrical controls, swing out control box for full corner access, and removable fan guard allow easy access for unit maintenance.



Prod ID#	CSI#	Cooling Tons	Liquid Line OD	Vapor Line OD	Dimensions H x D x W (Inches)	Max Fuse	Compr	Sound (dBA)	TXV	Price
73736	TC7B1821S	1-1/2	3/8"	3/4"	30 x 29.25 x 29.25	20A	Scroll	72	1TVMBA1	2840.08
73737	TC7B2421S	2	3/8"	3/4"	30 x 29.25 x 29.25	25A	Scroll	72	1TVMBA1	2946.31
73738	TC7B3021S	2-1/2	3/8"	3/4"	36.25 x 35.25 x 31.75	30A	Scroll	72	1TVMBH1	3414.97
73739	TC7B3621S	3	3/8"	3/4"	36.25 x 35.25 x 31.75	35A	Scroll	72	1TVMBA1	3658.67
73740	TC7B4221S	3-1/2	3/8"	7/8"	39.5 x 38 x 34.25	40A	Scroll	73	1TVMBB1	4355.41
73741	TC7B4821S	4	3/8"	7/8"	39.5 x 38 x 34.25	40A	Scroll	74	1TVMBC1	4727.22
73742	TC7B6021S	5	3/8"	*1-1/8"	42.75 x 38 x 34.25	50A	Scroll	74	1TVMBG1	5211.50

\* Unit has 7/8" valve, requires a field supplied 1-1/8" x 7/8" adapter

**Shaded items are Non-Stock special order & Subject to Freight**

**Sterling Hts, MI - Livonia, MI - Lansing, MI - Grand Rapids, MI - Waterford, MI - Almont, MI - Saginaw, MI**

**Equipment**

**LX series TW4B 14 SEER R410-A Split System A/C's**

- **Standard 5-Years parts / 10-Years Compressor limited warranty**
- **Extended 10-Years parts limited warranty when registered on-line within 90 days**
- Louvered Jacket for an appealing look with independent panels for quick cleaning and set up
- Compressor is internally protected against high pressure and temperature
- Easy access to electrical compartment - swing out control box
- QR code on unit for quick access to tech documents and warranty info
- Liquid line filter-drier / Top Discharge (Ball Bearing Fan Motors)
- 208/230-1-60 / Durable pre-painted steel / 18Ga G90 Galv formed base pan
- Low operating sound level / U.L. and C.U.L. listed
- **Better Service Access** - Diagonal base valves with open access for low-loss fittings, single panel access to the electrical controls, swing out control box for full corner access, and removable fan guard allow easy access for unit maintenance.



Equipment

Prod ID#	CSI#	Clg Tons	Liquid Line OD	Vapor Line OD	Dimensions H x D x W (Inches)	Max Fuse	Compr.	Sound (dBA)	TXV	Price
74499	TW4B1821S	1-1/2	3/8"	3/4"	33.25 x 24 x 24	20A	Scroll	70	1TVMBA1	2386.21
74500	TW4B2421S	2	3/8"	3/4"	30 x 29.25 x 29.25	20A	Scroll	72	1TVMBA1	2538.25
74476	TW4B3021S	2-1/2	3/8"	3/4"	30 x 29.25 x 29.25	30A	Scroll	73	1TVMBB1	2712.02
74532	TW4B3621S	3	3/8"	3/4"	36.25 x 29.25 x 29.25	35A	Scroll	72	1TVMBC1	2947.85
75151	TW4B4221S	3.5	3/8"	7/8"	33.25 x 35.25 x 31.75	35A	Scroll	74	1TVMBC1	3357.45
75152	TW4B4821S	4	3/8"	7/8"	33.25 x 35.25 x 34.25	45A	Scroll	75	1TVMBC1	3739.12
75153	TW4B6021S	5	3/8"	*1-1/8"	36.25 x 38 x 34.25	50A	Scroll	76	1TVMBD1	4272.83

\* Unit has 7/8" valve, requires a field supplied 1-1/8" x 7/8" adapter

**LX series TC3B 13+ SEER R410-A MicroChannel (MC<sup>2</sup>) Split System A/C**

- **Standard 5-Years parts / 10-Years Compressor limited warranty**
- **Extended 10-Years parts limited warranty when registered on-line within 90 days**
- **No TXV Required (If a TXV is used, unit must have hardstart kit installed)**
- Compressor is internally protected against high pressure and temperature
- Easy access to electrical compartment
- Aluminum microchannel tubing and enhanced aluminum fins
- 18 Gauge G90 galvanized formed base pan / Louvered Jacket for an appealing look
- Liquid line filter-drier / Top Discharge (Ball Bearing Fan Motors)
- 208/230-1-60 / Durable pre-painted steel
- Low operating sound level / U.L. and C.U.L. listed
- **Better Service Access** - Diagonal base valves with open access for low-loss fittings, single panel access to the electrical controls, swing out control box for full corner access, and removable fan guard allow easy access for unit maintenance.



Prod ID#	CSI#	Cooling Tons	Liquid Line OD	Vapor Line OD	Dimensions H x D x W (Inches)	Max Fuse	Compressor	Sound (dBA)	Price
72491	TC3B1822S	1-1/2	3/8"	3/4"	26.75 x 24 x 24	15A	Scroll	74	2070.84
72492	TC3B2422S	2	3/8"	3/4"	26.75 x 24 x 24	20A	Scroll	74	2169.45
72493	TC3B3022S	2-1/2	3/8"	3/4"	30 x 24 x 24	20A	Scroll	74	2385.16
72494	TC3B3622S	3	3/8"	3/4"	33.25 x 24 x 24	30A	Scroll	75	2628.60
72495	TC3B4222S	3-1/2	3/8"	7/8"	30 x 29.25 x 29.25	35A	Scroll	75	2973.74
72496	TC3B4821S	4	3/8"	7/8"	30 x 29.25 x 29.25	50A	Scroll	76	3349.70
72497	TC3B6021S	5	3/8"	*1-1/8"	36.25 x 29.25 x 29.25	60A	Scroll	77	3855.08

\* Unit has 7/8" valve, requires a field supplied 1-1/8" x 7/8" adapter

**Shaded items are Non-Stock special order & Subject to Freight**

**Sterling Hts, MI - Livonia, MI - Lansing, MI - Grand Rapids, MI - Waterford, MI - Almont, MI - Saginaw, MI**

**Equipment**

Equipment

**LX series TH16 16 SEER / 9 HSPF Modulating R410-A Heat Pump**

- Standard 5-Years parts / 10-Years Compressor limited warranty
- Extended 10-Years parts limited warranty when registered on-line within 90 days
- Using a 2-stage stat, system will modulate capacity & airflow from 50%-100% in 10% increments to meet the comfort of the consumer while minimizing energy bills.
- Compressor is internally protected against high pressure and temperature
- Compressor is externally protected by high and low pressure switches
- Ball Bearing fan motors / Liquid line filter-drier / 208/230-1-60 / U.L. and C.U.L Listed
- Enhanced aluminum fins are mechanically bonded to copper tubing
- 18 Gauge G90 galvanized formed base pan / Louvered Jacket for an appealing look
- **Better Service Access** - Diagonal base valves with open access for low-loss fittings, single panel access to the electrical controls, swing out control box for full corner access, and removable fan guard allow easy access for unit maintenance.
- See Tabular Data Sheet and AHRI for TXV match ups and approved ratings



Prod ID#	CSI#	Cooling Tons	Liquid Line OD	Vapor Line OD	Dimensions H x D x W (Inches)	Max Fuse	Compr	Sound (dBA)			Price
								Clg	Htg	TXV	
74950	TH16B2421S	2	3/8"	3/4"	33.25 x 29.25 x 29.25	30A	Rotary	70	72	1TVMBA1	4426.59
74896	TH16B3621S	3	3/8"	3/4"	39.5 x 29.25 x 29.25	35A	Rotary	74	79	1TVMBC1	5010.81
74951	TH16B4821S	4	3/8"	7/8"	39.5 x 35.25 x 31.75	30A	Rotary	75	76	1TVMBC1	5980.23
74952	TH16B6021S	5	3/8"	*1-1/8"	39.5 x 35.25 x 31.75	35A	Rotary	76	74	1TVMBG1	6638.28

\* Unit has 7/8" valve, requires a field supplied 1-1/8" x 7/8" adapter

**LX series TH4B 14 SEER / 8.2 HSPF R410-A Heat Pump**

- Standard 5-Years parts / 10-Years Compressor limited warranty
- Extended 10-Years parts limited warranty when registered on-line within 90 days
- Compressor is internally protected against high pressure and temperature
- Compressor is externally protected by high and low pressure switches
- Ball Bearing fan motors / Liquid line filter-drier / 208/230-1-60 / U.L. and C.U.L Listed
- Enhanced aluminum fins are mechanically bonded to copper tubing
- 18 Gauge G90 galvanized formed base pan / Louvered Jacket for an appealing look
- **Better Service Access** - Diagonal base valves with open access for low-loss fittings, single panel access to the electrical controls, swing out control box for full corner access, and removable fan guard allow easy access for unit maintenance.
- See Tabular Data Sheet and AHRI for TXV match ups and approved ratings



Prod ID#	CSI#	Cooling Tons	Liquid Line OD	Vapor Line OD	Dimensions H x D x W (Inches)	Max Fuse	Compr	Sound (dBA)			Price
								Clg	Htg	TXV	
73775	TH4B1821S	1-1/2	3/8"	3/4"	33.25 x 29.25 x 29.25	20A	Scroll	72	72	1TVMBA1	2937.15
73776	TH4B2421S	2	3/8"	3/4"	36.25 x 29.25 x 29.25	25A	Scroll	72	72	1TVMBA1	3222.84
73777	TH4B3021S	2-1/2	3/8"	3/4"	39.5 x 35.25 x 31.75	30A	Scroll	74	74	1TVMBB1	3383.34
73778	TH4B3521S	3	3/8"	3/4"	39.5 x 35.25 x 31.75	35A	Scroll	72	73	1TVMBE1	3630.51
73779	TH4B4221H	3-1/2	3/8"	7/8"	39.5 x 35.25 x 31.75	40A	Recip	75	75	1TVMBF1	4339.92
73781	TH4B4822S	4	3/8"	7/8"	39.5 x 38 x 31.75	50A	Scroll	75	74	1TVMBC1	4712.28
73782	TH4B6022S	5	3/8"	*1-1/8"	42.75 x 38 x 34.25	50A	Scroll	74	75	1TVMBG1	5190.57

\* Unit has 7/8" valve, requires a field supplied 1-1/8" x 7/8" adapter

**Shaded items are Non-Stock special order & Subject to Freight**

**Sterling Hts, MI - Livonia, MI - Lansing, MI - Grand Rapids, MI - Waterford, MI - Almont, MI - Saginaw, MI**



**Equipment**

**Acclimate™ LP9C 97-98% Modulating ECM Gas Furnaces - ENERGY STAR**



- Lifetime limited warranty on heat exchanger to original purchaser
- 10-year warranty on heat exchanger in commercial applications
- Modulating gas valve, inducer and variable speed ECM blower operation. Modulates from 100% input to 35% in 1% increments
- Adjustable delay timer allows two stage operation with single stage thermostat
- 33" Tall cabinet - upflow, downflow, horizontal left & right
- Tubular aluminized steel primary heat exchanger
- 24V, 40 vA Control transformer & blower relay
- Rotatable, multi-speed inducer
- Convertible to Propane
- Blower-off delay for cooling SEER improvement
- High efficiency condensing
- 20-year limited Heat Exchanger warranty from installation to subsequent purchaser
- 5-Year limited parts warranty; 10-Year parts when registered on-line within 90 days
- May be installed as either two-pipe (sealed combustion) or single pipe vent (using indoor combustion air)
- Secondary (condensing) heat exchanger of 29-4C high-grade stainless steel
- Category IV listed, may be either side-wall or thru-roof vented
- 100% Shut off main gas valve
- Self-diagnostics with fault code memory
- Top intake & vent connection
- Timed on, adjustable off blower capability
- No special vent termination kit require
- Insulated blower compartment

**ACCLIMATE™  
SERIES**



Equipment

Prod ID#	CSI#	Tons	Input		Output		Nom CFM	AFUE %	Width (Inches)	Plenum (Inches)	Price
			Hi/Low MBH	Hi/Low MBH	Cabinet	Cabinet					
58296	LP9C060B12MP13C	3	60/21	58/20	B	1200	97.5	17-1/2	16-3/8 x 20	4492.20	
58297	LP9C080B12MP13C	3	80/28	77/27	B	1200	97.5	17-1/2	16-3/8 x 20	4665.22	
58298	LP9C080C16MP13C	4	80/28	77/27	C	1600	97.7	21	19-7/8 x 20	4753.30	
58299	LP9C100C16MP13C	4	100/35	97/34	C	1600	97.7	21	19-7/8 x 20	4920.03	
58300	LP9C100C20MP13C	5	100/35	97/34	C	2000	97.7	21	19-7/8 x 20	5011.26	
58301	LP9C120D20MP13C	5	120/42	116/40	D	2000	98.0	24-1/2	23-3/8 x 20	5184.28	

**LX Series™ TM9V 96% Variable Speed Multi-Position ECM Gas Furnaces ENERGY STAR**



- Lifetime limited warranty on heat exchangers to original purchaser
- 10-Year limited warranty on heat exchangers in commercial applications
- 5-Year limited warranty on parts; 10-year when registered online within 90 days
- Variable speed ECM blower motor
- 2-Stage gas valve, 2-stage inducer
- 33" Tall cabinet - upflow, downflow, horizontal left & right
- Tubular aluminized steel primary heat exchanger
- 24V, 40 vA control transformer and blower relay
- Electronic hot surface ignition
- Convertible to propane
- 100% Shut off main gas valve
- Adjustable delay timer
- Secondary (condensing) heat exchanger of 29-4C high-grade stainless steel
- Category IV venting may be either side-wall or thru-roof vented
- Install as either two-pipe (sealed combustion) or one-pipe vent (indoor combustion air)
- Airflow leakageless than 1%
- Self-diagnostics with fault code memory



Prod ID#	CSI#	Tons	Input		Output		Nom CFM	AFUE %	Width (Inches)	Plenum (Inches)	Price
			Hi/Low MBH	Hi/Low MBH	Cabinet	Cabinet					
65775	TM9V040A10MP12C	2.5	40/26	38/25	A	1000	96.0	14-1/2"	13-3/8" x 20"	3452.46	
61494	TM9V060B12MP12C	3	60/39	58/37	B	1200	96.0	17-1/2"	16-3/8" x 20"	3680.54	
61495	TM9V080B12MP12C	3	80/52	77/50	B	1200	96.0	17-1/2"	16-3/8" x 20"	3864.88	
61274	TM9V080C16MP12C	4	80/52	77/50	C	1600	96.0	21"	19-7/8" x 20"	3983.61	
61496	TM9V100C16MP12C	4	100/65	96/62	C	1600	96.0	21"	19-7/8" x 20"	4196.07	
61275	TM9V100C20MP12C	5	100/65	96/62	C	2000	96.0	21"	19-7/8" x 20"	4286.68	
61497	TM9V120D20MP12C	5	120/78	115/75	D	2000	96.0	24-1/2"	23-3/8" x 20"	4639.73	

**Shaded items are Non-Stock special order & Subject to Freight**

**Sterling Hts, MI - Livonia, MI - Lansing, MI - Grand Rapids, MI - Waterford, MI - Almont, MI - Saginaw, MI**

**Equipment**

Equipment

**LX Series™ TM9Y 96% Multi-Position 2-Stg ECM Gas Furnaces ENERGY STAR**

- Lifetime limited warranty on heat exchangers to original purchaser
- 10-Year limited warranty on heat exchangers in commercial applications
- 5-Year limited warranty on parts; 10-year when registered online within 90 days
- 5-Speed, direct drive ECM motor blower
- 2-Stage gas valve, 2-stage inducer
- 33" Tall cabinet - upflow, downflow, horizontal left & right
- Tubular aluminized steel primary heat exchanger
- 24V, 40 vA control transformer and blower relay
- Electronic hot surface ignition
- Convertable to propane
- Protection from intake, exhaust or condensate blockage
- 100% Shut off main gas valve
- Adjustable delay timer
- Secondary (condensing) heat exchanger of 29-4C high-grade stainless steel
- Category IV venting may be either side-wall or thru-roof vented
- Install as either two-pipe (sealed combustion) or one-pipe vent (indoor combustion air)
- Airflow leakage less than 1%
- Self-diagnostics with fault code memory



Prod ID#	CSI#	Tons	Input		Output		Nom CFM	AFUE %	Width (Inches)	Plenum (Inches)	Price
			Hi/Low MBH	MBH	Hi/Low MBH	MBH					
72392	TM9Y040A10MP11	2.5	40/26		38/25		1000	96.0	14-1/2"	13-3/8" x 20"	2401.72
72393	TM9Y060B12MP11	3	60/39		58/37		1200	96.0	17-1/2"	16-3/8" x 20"	2469.99
72394	TM9Y080B12MP11	3	80/52		77/50		1200	96.0	17-1/2"	16-3/8" x 20"	2606.52
72395	TM9Y080C16MP11	4	80/52		77/50		1600	96.0	21"	19-7/8" x 20"	2755.46
72396	TM9Y100C16MP11	4	100/65		96/62		1600	96.0	21"	19-7/8" x 20"	2764.77
72397	TM9Y100C20MP11	5	100/65		96/62		2000	96.0	21"	19-7/8" x 20"	2957.16
72398	TM9Y120D20MP11	5	120/78		115/75		2000	96.0	24-1/2"	23-3/8" x 20"	3062.66

**LX Series TM9E 95% Multi-Position 1-Stg ECM Gas Furnaces ENERGY STAR**

- Lifetime limited warranty on heat exchanger to original purchaser
- 20-Year limited warranty from original installation date to subsequent purchaser
- 10-Year warranty on heat exchanger in commercial applications
- 5-Year limited parts warranty; 10 years when registered on-line within 90-days
- 5-Speed, Direct Drive ECM DC Blower Motor, 100% Shut off Main Gas Valve
- 33" Compact Design - Timed on, adj. off Blower - Electronic Hot surface Ignition
- Tubular Aluminized Steel Primary Heat Exchanger - 24v, 40vA Transformer
- Blower-off delay for cooling SEER improvement - Low flame sense indicator
- 29-4C Stainless Steel Secondary Heat Exchanger - one or two pipe system
- Built-in LED diagnostics with fault code memory - Insulated Blower compartment



Prod ID#	CSI#	Tons	Input		Output		Nom CFM	AFUE %	Width (Inches)	Plenum (Inches)	Price
			MBH	MBH	MBH	MBH					
69771	TM9E040A10MP11	2-1/2	40		38		1000	95	14-1/2"	13-3/8" x 20"	2122.45
69772	TM9E060B12MP11	3	60		57		1200	95	17-1/2"	16-3/8" x 20"	2234.16
69773	TM9E080B12MP11	3	80		76		1200	95	17-1/2"	16-3/8" x 20"	2293.12
69774	TM9E080C16MP11	4	80		76		1600	95	21"	19-7/8" x 20"	2594.11
69775	TM9E100C16MP11	4	100		95		1600	95	21"	19-7/8" x 20"	2712.02
69776	TM9E100C20MP11	5	100		95		2000	95	21"	19-7/8" x 20"	2842.35
69777	TM9E120D20MP11	5	120		114		2000	95	24-1/2"	23-3/8" x 20"	2926.13

Shaded items are Non-Stock special order & Subject to Freight

Sterling Hts, MI - Livonia, MI - Lansing, MI - Grand Rapids, MI - Waterford, MI - Almont, MI - Saginaw, MI

**Equipment**

**Climasure™ TG9S 95.5% Multi-Position High-Efficiency Gas Furnaces**



- Lifetime limited warranty on heat exchanger to original purchaser
- 20-Year limited warranty from original installation date to subsequent purchaser
- 10-Year warranty on heat exchanger in commercial applications
- 5-Year limited parts warranty; 10 years when registered on-line within 90-days
- 4-Speed, Direct Drive PSC Blower Motor, 100% Shut off Main Gas Valve
- 33" Compact Design - Timed on, adj. off Blower - Electronic Hot surface Ignition
- Tubular Aluminized Steel Primary Heat Exchanger - 24v, 40vA Transformer
- Blower-off delay for cooling SEER improvement - Low flame sense indicator
- 29-4C Stainless Steel Secondary Heat Exchanger - one or two pipe system
- Built-in LED diagnostics with fault code memory - Insulated Blower compartment



Equipment

Prod ID#	CSI#	Tons	Input MBH	Output MBH	Cabinet	Nom CFM	AFUE %	Width (Inches)	Plenum (Inches)	Price
58282	TG9S040A08MP11	2	40	38	A	800	95.5	14-1/2	13-3/8 x 20	1956.82
60562	TG9S060A10MP11	2.5	60	57	A	1000	95.5	14-1/2	13-3/8 x 20	2009.20
58283	TG9S060B12MP11	3	60	57	B	1200	95.5	17-1/2	16-3/8 x 20	2024.61
58284	TG9S080B12MP11	3	80	76	B	1200	95.5	17-1/2	16-3/8 x 20	2135.55
58285	TG9S080C16MP11	4	80	76	C	1600	95.5	21	19-7/8 x 20	2363.59
58286	TG9S100C16MP11	4	100	95	C	1600	95.5	21	19-7/8 x 20	2428.30
58287	TG9S100C20MP11	5	100	95	C	2000	95.5	21	19-7/8 x 20	2566.97
58288	TG9S120D20MP11	5	120	114	D	2000	95.5	24-1/2	23-3/8 x 20	2674.83
58289	TG9S130D20MP11	5	130	123.5	D	2000	95.5	24-1/2	23-3/8 x 20	2791.93

**LX Series™ TM8V 80% Multi-Position 2-Stg Variable Speed ECM Gas Furnaces**

- 20-Year limited warranty on heat exchangers
- 10-Year limited warranty on heat exchangers in commercial applications
- 5-Year limited warranty on parts; 10-year when registered online within 90 days
- Variable Speed ECM blower motor
- 2-Stage gas valve, 2-stage inducer
- Tubular aluminized steel primary heat exchanger
- 24V, 40 vA control transformer and blower relay
- Electronic hot surface ignition
- 33" Tall cabinet - upflow, downflow, horizontal left & right
- 100% Shut off main gas valve
- Adjustable delay timer
- Airflow leakage less than 1%
- Self-diagnostics with fault code memory
- Convertible to propane
- Category I listed, may be common vented with another gas appliance as allowed by National Fuel Gas Code



Prod ID#	CSI#	Tons	Input/Cab Hi/Low MBH	Output Hi/Low MBH	Cabinet	Nom CFM	AFUE %	Width (Inches)	Plenum (Inches)	Price
61630	TM8V060A12MP12C	3	60/39	47/31	A	1200	80.0	14-1/2"	13-3/8" x 20"	2762.01
61631	TM8V080B12MP12C	3	80/52	63/42	B	1200	80.0	17-1/2"	16-3/8" x 20"	2906.72
61632	TM8V080C16MP12C	4	80/52	63/42	C	1600	80.0	21"	19-7/8" x 20"	3013.68
61633	TM8V100C16MP12C	4	100/65	80/52	C	1600	80.0	21"	19-7/8" x 20"	3117.49
61634	TM8V100C20MP12C	5	100/65	80/52	C	2000	80.0	21"	19-7/8" x 20"	3224.45
61635	TM8V120C20MP12C	5	120/78	96/62	C	2000	80.0	21"	19-7/8" x 20"	3450.94

**Shaded items are Non-Stock special order & Subject to Freight**

**Sterling Hts, MI - Livonia, MI - Lansing, MI - Grand Rapids, MI - Waterford, MI - Almont, MI - Saginaw, MI**

**Equipment**

Equipment

**LX Series™ TM8Y 80% Multi-Position 2-Stg STD ECM Gas Furnaces**

- 20-Year limited warranty on heat exchangers
- 10-Year limited warranty on heat exchangers in commercial applications
- 5-Year limited warranty on parts; 10-year when registered online within 90 days
- Standard ECM blower motor
- 2-Stage gas valve, 2-stage inducer
- Tubular aluminized steel primary heat exchanger
- 24V, 40 vA control transformer and blower relay
- Electronic hot surface ignition
- 33" Tall cabinet - upflow, downflow, horizontal left & right
- 100% Shut off main gas valve
- Adjustable delay timer
- Airflow leakage less than 1%
- Self-diagnostics with fault code memory
- Convertible to propane
- Category I listed, may be common vented with another gas appliance as allowed by National Fuel Gas Code



Prod ID#	CSI#	Tons	Input/Cab Hi/Low MBH	Output Hi/Low MBH	Cabinet	Nom CFM	AFUE %	Width (Inches)	Plenum (Inches)	Price
77269	TM8Y060A12MP11	3	60/39	48/31	A	1200	80.0	14-1/2"	13-3/8" x 20"	1899.04
76097	TM8Y080B12MP11	3	80/52	64/41	B	1200	80.0	17-1/2"	16-3/8" x 20"	1998.33
79426	TM8Y080C16MP11	4	80/52	64/41	C	1600	80.0	21"	19-7/8" x 20"	2079.01
77270	TM8Y100C16MP11	4	100/65	80/52	C	1600	80.0	21"	19-7/8" x 20"	2141.07
76627	TM8Y100C20MP11	5	100/65	80/52	C	2000	80.0	21"	19-7/8" x 20"	2218.65
72985	TM8Y120C20MP11	5	120/78	96/62	C	2000	80.0	21"	19-7/8" x 20"	2376.90

**Climasure™ TG8S 80% Multi-Position Single Stage Gas Furnaces**



- 20-Year limited warranty on heat exchangers
- 10-Year warranty on heat exchanger in commercial applications
- 5-Year limited parts warranty; 10-year when registered on-line within 90-days
- 4-Speed, PSC, direct-drive blower motors
- 1/4 turn knobs for easy door removal
- High heat transfer tubular heat exchangers
- Blower-off delay for cooling SEER improvement
- 24V, 40 vA control transformer and blower relay
- Rollout safety control
- Electronic hot surface ignition
- Standard terminals for controlling humidifiers and EAC's
- Category I listed, may be common vented with another gas appliance as allowed by National Fuel Gas Cod
- 100% Shut off main gas valve
- Adjustable delay timer
- Airflow leakage less than 1%
- Induced combustion, quiet inducer motor
- Built-in diagnostics with fault code memory
- Adjustable fan-off setting
- Convertible to propane
- 33" Tall cabinet - upflow, downflow, horizontal left & right



Prod ID#	CSI#	Tons	Input MBH	Output MBH	Cabinet	Nom CFM	AFUE %	Width (Inches)	Plenum (Inches)	Price
58079	TG8S040A08MP11	2	40	32	A	800	80.0	14-1/2"	13-3/8 x 20	1201.82
58138	TG8S060A12MP11	3	60	48	A	1200	80.0	14-1/2"	13-3/8 x 20	1322.01
58139	TG8S080B12MP11	3	80	64	B	1200	80.0	17-1/2"	16-3/8 x 20	1389.80
58140	TG8S080C16MP11	4	80	64	C	1600	80.0	21	19-7/8 x 20	1494.58
58141	TG8S100B12MP11	3	100	80	B	1200	80.0	17-1/2"	16-3/8 x 20	1559.29
58142	TG8S100C16MP11	4	100	80	C	1600	80.0	21	19-7/8 x 20	1602.43
58143	TG8S100C20MP11	5	100	80	C	2000	80.0	21	19-7/8 x 20	1651.74
58144	TG8S120C20MP11	5	120	96	C	2000	80.0	21	19-7/8 x 20	1793.49
58145	TG8S130D20MP11	5	130	104	D	2000	80.0	24-1/2"	23-3/8 x 20	1901.35

**Shaded items are Non-Stock special order & Subject to Freight**

**Sterling Hts, MI - Livonia, MI - Lansing, MI - Grand Rapids, MI - Waterford, MI - Almont, MI - Saginaw, MI**

**Equipment**

**MP Single Phase Modular Air Handlers with PSC Blower Motor**

- Standard 5-Year Parts warranty
- Extended 10-Year Parts when registered on-line within 90 days
- Direct-drive, multi-speed blower motors
- Achieves 2% or less total airflow leakage rate
- Powder-painted G30 galvanized steel cabinet
- For match-up with "CM" multi-position coils
- 20.5" Case Depth for ease of attic access and tight applications



Equipment

Prod ID#	CSI#	Tons	CFM	Voltage	Cabinet	HP	Height	Ship Wt.(Lbs)	Width	Price
72483	MP08BN21	2	800	208/230-1-60	B	1/4	21.5"	52	17-1/2"	899.83
72484	MP12BN21	3	1200	208/230-1-60	B	1/2	21.5"	52	17-1/2"	996.68
72485	MP16CN21	4	1600	208/230-1-60	C	1/2	22.5"	68	21"	1106.04
72486	MP20DN21	5	2000	208/230-1-60	D	1	22.5"	75	24-1/2"	1159.15



**Shaded items are Non-Stock special order & Subject to Freight**

**Sterling Hts, MI - Livonia, MI - Lansing, MI - Grand Rapids, MI - Waterford, MI - Almont, MI - Saginaw, MI**

Equipment

Equipment

**Guardian R407C 14SEER R407C MicroChannel (MC<sup>2</sup>) A/C's**

- 5-Year limited warranty on compressor and parts
- Louvered Jacket for an appealing look
- Compressor is internally protected against high pressure and temperature
- Easy access to electrical compartment
- Aluminum microchannel tubing and enhanced aluminum fins
- 18 Gauge G90 galvanized formed base pan
- Liquid line filter-drier / Top Discharge
- 208/230-1-60 / Durable pre-painted steel
- Low operating sound level / U.L. and C.U.L. listed



Prod ID#	CSI#	Cooling Tons	Liquid Line OD	Vapor Line OD	Dimensions H x D x W (Inches)	Max Fuse	Compressor	Sound (dBA)	Price
75889	GAW14L18C22S	1.5	3/8"	3/4"	30 x 29-1/4 x 29-1/4	15A	Scroll	72	1878.00
74133	GAW14L24C22S	2	3/8"	3/4"	30 x 29-1/4 x 29-1/4	25A	Scroll	74	1997.58
74135	GAW14L30C21S	2-1/2	3/8"	3/4"	36-1/4 x 29-1/4 x 29-1/4	30A	Scroll	74	2133.47
75890	GAW14L36C21S	3	3/8"	3/4"	33-1/4 x 35-1/4 x 31-3/4	30A	Scroll	72	2310.13

**Guardian RAC13L 13 SEER R410-A MicroChannel (MC<sup>2</sup>) Split System Air Conditioners**

- Standard 5-Year limited warranty on compressor and parts
- Extended 10-Year compressor and parts when registered on-line within 90 days
- No TXV Required (If a TXV is used, unit must have hardstart kit installed)
- Louvered Jacket for an appealing look
- Compressor is internally protected against high pressure and temperature
- Easy access to electrical compartment
- Aluminum microchannel tubing and enhanced aluminum fins
- 18 Gauge G90 galvanized formed base pan
- Liquid line filter-drier / Top Discharge
- 208/230-1-60 / Durable pre-painted steel
- Low operating sound level



Prod ID#	CSI#	Cooling Tons	Liquid Line OD	Vapor Line OD	Dimensions H x D x W (Inches)	Max Fuse	Compressor	Sound (dBA)	Price
72433	RAC13L18B22S	1-1/2	3/8"	3/4"	26.75 x 24 x 24	15A	Scroll	74	1899.25
72436	RAC13L24B22S	2	3/8"	3/4"	26.75 x 24 x 24	20A	Scroll	74	2002.57
72438	RAC13L30B22S	2-1/2	3/8"	3/4"	30 x 24 x 24	20A	Scroll	74	2190.97
72440	RAC13L36B22S	3	3/8"	3/4"	33.25 x 24 x 24	30A	Scroll	75	2406.73
72443	RAC13L42B22S	3-1/2	3/8"	7/8"	30 x 29.25 x 29.25	35A	Scroll	75	2744.04
72441	RAC13L48B21S	4	3/8"	7/8"	30 x 29.25 x 29.25	50A	Scroll	76	3075.27
72442	RAC13L60B21S	5	3/8"	1-1/8"	36.25 x 29.25 x 29.25	60A	Scroll	77	3546.28

\* Unit has 7/8" valve, requires a field supplied 1-1/8" x 7/8" adapter

Shaded items are Non-Stock special order & Subject to Freight

Sterling Hts, MI - Livonia, MI - Lansing, MI - Grand Rapids, MI - Waterford, MI - Almont, MI - Saginaw, MI

**Equipment**

**Guardian RGF 95.5% Multi-Position High-Efficiency Gas Furnaces**

- Lifetime limited warranty on heat exchanger when registered on-line within 90 days
- 20-Year limited warranty from original installation date to subsequent purchaser
- 10-Year warranty on heat exchanger in commercial applications
- 5-Year limited parts warranty; 10 years when registered on-line within 90-days
- 4-Speed, direct drive PSC motor blower
- 33" Compact Design for all applications
- Timed on, adj. off blower capability
- Tubular aluminized steel primary heat exchanger
- 24v, 40 vA control transformer and blower relay
- Electronic hot surface ignition
- High efficiency condensing
- Top intake & vent connection
- Protection from intake, exhaust or condensate blockage
- 100% Shut off main gas valve
- Blower-off delay for cooling SEER improvement
- Low flame sense indicator
- Secondary (condensing) heat exchanger of 29-4C high-grade stainless steel
- Install as either two-pipe (sealed combustion) or one-pipe vent (indoor combustion air)
- Built-in LED diagnostics with fault code memory
- Insulated blower compartment
- No special vent termination kit req'd



Equipment

Prod ID#	CSI#	Tons	Input MBH	Output MBH	Cabinet	Nom CFM	AFUE %	Width (Inches)	Plenum (Inches)	Price
70343	RGF19040AP08MP11	2	40	38	A	800	95.5	14-1/2	13-3/8 x 20	1774.92
70344	RGF19060BP12MP11	3	60	57	B	1200	95.5	17-1/2	16-3/8 x 20	1905.24
70345	RGF19080BP12MP11	3	80	76	B	1200	95.5	17-1/2	16-3/8 x 20	1970.41
70346	RGF19080CP16MP11	4	80	76	C	1600	95.5	21	19-7/8 x 20	2150.38
70347	RGF19100CP16MP11	4	100	95	C	1600	95.5	21	19-7/8 x 20	2243.47
70348	RGF19100CP20MP11	5	100	95	C	2000	95.5	21	19-7/8 x 20	2339.66
70349	RGF19120DP20MP11	5	120	114	D	2000	95.5	24-1/2	23-3/8 x 20	2438.96

***If you need a product not listed in this catalog, please check with us. We have not listed every product we can get for you.***

**Shaded items are Non-Stock special order & Subject to Freight**

**Sterling Hts, MI - Livonia, MI - Lansing, MI - Grand Rapids, MI - Waterford, MI - Almont, MI - Saginaw, MI**

**Equipment**

Equipment

**Luxaire Coils - Aluminum "N"**

**CF Full Cased Flex Upflow/Downflow Coils**



- 5-year limited warranty
- Extended 10-Year limited warranty when registered on-line within 90days
- Insulated cabinet with no external screws to reduce thermal transmission paths (sweating)
- MaxAlloy Coil - Long life aluminum coils
- Powder-painted durable finish inside & out - Optimum heat transfer
- **Must use tabular data sheet of outdoor unit for proper coil match-up**

Prod ID#	CSI#	Tons	Cabinet	Width (Inches)	Height (Inches)	Depth (Inches)	Lineset Connection	Weight (lb)	Price
72446	CF18AXA1	1-1/2	A	14-1/2	19.5	21.5	3/8" x 3/4"	38	699.35
72447	CF18BXA1	1-1/2	B	17-1/2	19	21.5	3/8" x 3/4"	40	728.63
72448	CF24AXA1	2	A	14-1/2	19.5	21.5	3/8" x 3/4"	41	777.42
72449	CF24BXA1	2	B	17-1/2	19	21.5	3/8" x 3/4"	42	800.19
72450	CF30AXA1	2-1/2	A	14-1/2	21-5/8	21.5	3/8" x 3/4"	47	884.76
72451	CF30BXA1	2-1/2	B	17-1/2	23	21.5	3/8" x 3/4"	50	891.27
72452	CF30CXA1	2-1/2	C	21	21	21.5	3/8" x 3/4"	51	894.52
72453	CF36AXA1	3	A	14-1/2	25-1/2	21.5	3/8" x 3/4"	51	923.80
72454	CF36BXA1	3	B	17-1/2	25-5/8	21.5	3/8" x 3/4"	53	966.08
72455	CF36CXA1	3	C	21	23	21.5	3/8" x 3/4"	54	1008.37
73086	CF42BXA1	3-1/2	B	17-1/2	25	21.5	3/8" x 7/8"	57	1044.15
72457	CF42CXA1	3-1/2	C	21	25	21.5	3/8" x 7/8"	59	1053.91
72456	CF42DXA1	3-1/2	D	24-1/2	25	21.5	3/8" x 7/8"	62	1073.42
72458	CF48CXA1	4	C	21	27	21.5	3/8" x 7/8"	63	1109.20
72459	CF48DXA1	4	D	24-1/2	27	21.5	3/8" x 7/8"	65	1148.24
72460	CF60CXA1	5	C	21	33	21.5	3/8" x 7/8"	73	1262.09
72461	CF60DXA1	5	D	24-1/2	32-3/4	21.5	3/8" x 7/8"	75	1291.36
73765	CF64DXA1	5	D	24-1/2	32-3/4	21.5	3/8" x 7/8"	75	1629.65

**CM Full Cased Multi-Position Flex Coils**



- Standard 5-Year limited warranty
- Extended 10-Year Limited warranty when registered on-line within 90days
- Insulated cabinet with no external screws to reduce thermal transmission paths (sweating)
- MaxAlloy Coil - Long life aluminum coils
- Powder-painted durable finish inside & out - Optimum heat transfer
- Comes with horizontal pan installed
- **Must use tabular data sheet of outdoor unit for proper coil match-up**

Prod ID#	CSI#	Tons	Cabinet	Width (Inches)	Height (Inches)	Depth (Inches)	Lineset Connection	Weight (lb)	Price
72463	CM24AXA1	1-1/2, 2	A	14-1/2	19.5	21.5	3/8" x 3/4"	43	852.23
72464	CM24BXA1	1-1/2, 2	B	17-1/2	19	21.5	3/8" x 3/4"	44	832.72
72465	CM30AXA1	2-1/2	A	14-1/2	25-1/2	21.5	3/8" X 3/4"	49	959.58
72466	CM30BXA1	2-1/2	B	17-1/2	23	21.5	3/8" x 3/4"	52	975.84
72467	CM30CXA1	2-1/2	C	21	23	21.5	3/8" x 3/4"	53	995.36
72468	CM36AXA1	3	A	14-1/2	25-1/2	21.5	3/8" X 3/4"	53	1021.38
72469	CM36BXA1	3	B	17-1/2	25-5/8	21.5	3/8" X 3/4"	55	1083.18
72470	CM36CXA1	3	C	21	25	21.5	3/8" X 3/4"	56	1086.44

**Shaded Items are Non-Stock special order**

**Sterling Hts, MI - Livonia, MI - Lansing, MI - Grand Rapids, MI - Waterford, MI - Almont, MI - Saginaw, MI**



**Equipment**

**CM Full Cased Multi-Position Flex Coils (Continued)**

Prod ID#	CSI#	Tons	Cabinet	Width (Inches)	Height (Inches)	Depth (Inches)	Lineset Connection	Weight (lb)	Price
72471	CM42CXA1	3-1/2	C	21	27	21.5	3/8" x 7/8"	61	1187.27
72472	CM42DXA1	3-1/2	D	24-1/2	27	21.5	3/8" x 7/8"	64	1203.54
72473	CM48CXA1	4	C	21	33	21.5	3/8" x 7/8"	65	1323.89
72474	CM48DXA1	4	D	24-1/2	32-3/4	21.5	3/8" x 7/8"	67	1414.97
72475	CM60CXA1	5	C	21	33	21.5	3/8" x 7/8"	75	1613.39
72476	CM60DXA1	5	D	24-1/2	32-3/4	21.5	3/8" x 7/8"	77	1649.17
77120	CM64DXA1	5	D	24-1/2	32-3/4	21.5	3/8" x 7/8"	83	2098.06

Equipment

**FC Full Cased Flex Upflow/Downflow Coils - ON PHASE OUT**

- 5-year limited warranty
- Insulated cabinet - Left or Right Drain
- Durable finish inside & out - Optimum heat transfer
- **Must use tabular data sheet of outdoor unit for proper coil match-up**



Prod ID#	CSI#	Tons	Cabinet	Width (Inches)	Height (Inches)	Depth (Inches)	Lineset Connection	Weight (lb)	Price
57021	FC32A3XC1	2, 2-1/2	A	14-1/2	20	21.5	3/8" x 3/4"	49	832.72
56339	FC35C3XC1	2, 2-1/2	C	21	20	21.5	3/8" x 3/4"	55	923.80
53434	FC48D3XC1	4	D	24.5	28	21.5	3/8" x 7/8"	71	1118.96
62207	FC64D3XC1	5	D	24-1/2	36	21.5	3/8" x 7/8"	92	1502.79

**MC Full Cased Multi-Position Flex Coils- ON PHASE OUT**

- 5-Year limited warranty on parts
- Durable inside & outside finish - Insulated Cabinet
- Optimum heat transfer
- Comes with horizontal pan installed
- **Must use tabular data sheet of outdoor unit for proper coil match-up**



Prod ID#	CSI#	Tons	Cabinet	Width (Inches)	Height (Inches)	Depth (Inches)	Lineset Connection	Weight (lb)	Price
53441	MC18A3XC1	1, 1-1/2	A	14-1/2	22	21.5	3/8" x 3/4"	51	679.84
57023	MC32A3XC1	2, 2-1/2	A	14-1/2	22	21.5	3/8" X 3/4"	59	992.10
56344	MC35C3XC1	2, 2-1/2	C	21	22	21.5	3/8" x 3/4"	67	1083.18



**Shaded Items are Non-Stock special order**

**Sterling Hts, MI - Livonia, MI - Lansing, MI - Grand Rapids, MI - Waterford, MI - Almont, MI - Saginaw, MI**

**Luxaire Extended Warranties**

**Residential Comfort Plan  
(Single Phase Product)**

**"Performance Promise™"**

Equipment

**Extended Warranties / Residential Home Comfort Plans**

- Comfort Plan Warranties must be submitted within 12 months of installation date.
- All Comfort Plans include Parts Mark Up, Labor and Trip Charge.

**Gas Or Electric Furnaces (Includes Evaporator Coils)**

Prod ID#	CSI#	Description	Price
37062	PRCPFURN060LM	31D-5Y Labor Furnace Plus Trip and Parts Mark Up	146.80
64816	PRCPFURN120LM2	2-10Y Labor Furnace Plus Trip and Parts Mark Up	411.95
60827	PRCPFURN120LM	31D-10Y Labor Furnace Plus Trip and Parts Mark Up	504.83

**A/C Outdoor Unit - 1.5 - 5 Tons (Includes Evaporator Coils) Single Phase**

Prod ID#	CSI#	Description	Price
47921	PRCPUNIT060LM	31D-5Y Labor Air Conditioner Plus Trip and Parts Mark Up	176.76
64812	PRCPUNIT120LM2	2-10Y Labor Air Conditioner Plus Trip and Parts Mark Up	599.20
60829	PRCPUNIT120LM	31D-10Y Labor Air Conditioner Plus Trip and parts Mark Up	725.03

**Split System A/C & Furnace (Gas/Oil) Or Air Handler,  
Includes Evaporator Coil Or Packaged Unit -Single Phase 1.5-5 Tons**

Prod ID#	CSI#	Description	Price
52340	PRCPSSPK060LM	31D-5Y Labor System Plus Trip and Parts Mark Up	296.60
64821	PRCPSSPK120LM2	2-10Y Labor System Plus Trip and Parts Mark Up	843.37
57166	PRCPSSPK120LM	31D-10Y Labor System Plus Trip and Parts Mark Up	991.68

**Split System Heat Pump (Includes Evaporator Coil Only) 1.5-5 Tons Single Phase Warranty**

Prod ID#	CSI#	Description	Price
59840	PRCPHP060LM	31D-5Y Labor Heat Pump Plus Trip and Parts Mark Up	266.46
67756	PRCPHP120LM2	2-10Y Labor Heat Pump Plus Trip and Parts Mark Up	979.69
60828	PRCPHP120LM	31D-10Y Labor Heat Pump Plus Trip and Parts Mark Up	1157.95

**Split System Heat Pump With Furnace (Gas/Oil) or Air Handler, Includes Evaporator Coil or Packaged Heat  
Pump Single Phase 1.5 - 5 Tons Warranty**

Prod ID#	CSI#	Description	Price
59843	PRCPHPSS060LM	31D-5Y Labor Heat Pump System Plus Trip and Parts Mark Up	356.52
67758	PRCPHPSS120LM2	2-10Y Labor Heat Pump System Plus Trip and Parts Mark Up	1099.53
57167	PRCPHPSS120LM	31D-10Y Labor Heat Pump System Plus Trip and Parts Mark Up	1339.21

**Shaded Items are Non-Stock special order**

**Sterling Hts, MI - Livonia, MI - Lansing, MI - Grand Rapids, MI - Waterford, MI - Almont, MI - Saginaw, MI**

**Luxaire Extended Warranties**

**CCE & Luxaire SELECT Dealer Promotional Extended Warranties  
(Single Phase Product)**

**Only Available to CCE & Luxaire SELECT Dealers**

**CCE & Luxaire SELECT Dealers Promotional Extended Warranties (PEW)**

- Discount Comfort Plan Warranties must be submitted within 45 days of installation date.

**Premium Equipment Promotional Extended Warranties**

- **CCE and Luxaire SELECT Dealers Only**
- LP9C, TM9V, TM9Y, TM9E, TM9T, AL21, HL20, AL19, HL19, AL8B, HL8B, TC7, TC17, TH16, MV, AVC
- Premium Systems must include **both** A/C and Furnace **Premium** Product (ex: TC7 & LP9C)
- If there is one Standard product within the system, then the Promotional Warranty is Standard (See Next Section)

Prod ID#	CSI#	Description	Price
73284	PRCPFURN120LMEPWP	Prem - PEW - 31D-10Y Labor Furnace Plus Trip and Parts Mark Up	252.52
73285	PRCPUNIT120LMEPWP	Prem - PEW - 31D-10Y Labor A/C Plus Trip and Parts Mark Up	361.66
73286	PRCPSSPK120LMEPWP	Prem - PEW - 31D-10Y Labor A/C Syst Plus Trip and Parts Mark Up	496.48
73287	PRCPHP120LMEPWP	Prem - PEW - 31D-10Y Labor H.P. Plus Trip and Parts Mark Up	579.94
73288	PRCPHPSS120LMEPWP	Prem - PEW - 31D-10Y Labor H.P. Syst Plus Trip and Parts Mark Up	669.82

**Standard Equipment Promotional Extended Warranties**

- **CCE and Luxaire SELECT Dealers Only**
- TG9S, LPLC, TM8V, TM8T, TM8Y, TG8S, TW4, TF4, TC4, TF3, TC3, TH4
- Systems include all product combinations with the above product (Ex: LP9C & TC3B - or - AL8B & TG9S)
- If there is one Standard product within the system, then the Promotional Warranty is Standard

Prod ID#	CSI#	Description	Price
73279	PRCPFURN120LMEPWS	Stand - PEW - 31D-10Y Labor Furnace Plus Trip and Parts Mark Up	306.02
73280	PRCPUNIT120LMEPWS	Stand - PEW - 31D-10Y Labor A/C Plus Trip and Parts Mark Up	440.84
73281	PRCPSSPK120LMEPWS	Stand - PEW - 31D-10Y Labor A/C Syst Plus Trip and Parts Mark Up	601.34
73282	PRCPHP120LMEPWS	Stand - PEW - 31D-10Y Labor H.P. Plus Trip and Parts Mark Up	704.06
73283	PRCPHPSS120LMEPWS	Stand - PEW - 31D-10Y Labor H.P. Syst Plus Trip and Parts Mark Up	813.20



**Shaded Items are Non-Stock special order**

**Sterling Hts, MI - Livonia, MI - Lansing, MI - Grand Rapids, MI - Waterford, MI - Almont, MI - Saginaw, MI**

Equipment

Equipment

**Luxaire Equipment Accessories**

**TXV Kit - Thermostatic Expansion Valve Kits - R410, 3/4 Chatleff Conn TC7B & TC3B**

- Check Tabular Data Sheet for TXV Selection

Prod ID#	CSI#	SEER	Nominal Tonnage	Refrigerant	Price
73150	S1-1TVMBA1	13 thru 18	See Match Up Charts for Tonnage	R-410	151.95
73151	S1-1TVMBB1	13 thru 18	See Match Up Charts for Tonnage	R-410	151.95
73152	S1-1TVMBC1	13 thru 18	See Match Up Charts for Tonnage	R-410	152.70
73153	S1-STVMBD1	13 thru 18	See Match Up Charts for Tonnage	R-410	153.45
73727	S1-1TVMBE1	13 thru 18	See Match Up Charts for Tonnage	R-410	194.48
73728	S1-1TVMBF1	13 thru 18	See Match Up Charts for Tonnage	R-410	194.48
73729	S1-1TVMBG1	13 thru 18	See Match Up Charts for Tonnage	R-410	151.36
73730	S1-STVMBH1	13 thru 18	See Match Up Charts for Tonnage	R-410	149.90

**TVM4 Series Thermal Expansion Valve Kits - R410A - AL8B & TCJF's**

- Check Tabular Data Sheet for TXV selection

Prod ID#	CSI#	SEER	Nominal Tonnage	Refrigerant	Price
50017	S1-1TVM4F1	13 thru 18	See Match Up Charts for Tonnage	R-410A	188.61
48589	S1-1TVM4G1	13 thru 18	See Match Up Charts for Tonnage	R-410A	190.42
48590	S1-1TVM4H1	13 thru 18	See Match Up Charts for Tonnage	R-410A	188.61
48591	S1-1TVM4J1	13 thru 18	See Match Up Charts for Tonnage	R-410A	188.61
48592	S1-1TVM4K1	13 thru 18	See Match Up Charts for Tonnage	R-410A	190.42

**Thermostat**

**Touch Screen Communicating Thermostats**

- 5-Year Warranty
- 7 Day Programable / Non-programable
- Complete Integration of Temperature, Humidity and Ventilation in every season
- Intuitive on-screen prompts for ease of installation and service



Prod ID#	CSI#	Description	Price
65065	S1-02815909000	Decorative Mounting Kit	69.48
75177	S1-THXU280B	2.8" TStat,Prgrm,4H/2C,WIFI,Black,Communicating	630.72
78958	S1-THXU430W	4.3" TStat,Prgrm,4H/2C,WIFI,White,Communicating	687.03

**Humidifiers**

**Bypass Humidifiers 24Volt**

- Mounts easily on the warm or return plenum
- Includes a Manual Humidistat
- Branded Luxaire to match your Luxaire furnace
- 6" Diameter bypass duct
- Quick left-right bypass conversion. Reversible housing, nameplate & drain spud/plug
- 5-Year limited warranty on parts



Prod ID#	CSI#	Capacity (gpd)	Unit Dimensions	Plenum Opening	Price
68578	S1-BP5000MT	12	15-5/8"W x 13"H x 10-1/4"D	9-1/2"W x 9-1/2"H	283.79
68579	S1-BP6000MT	17	15-3/8"W x 15-3/4"H x 10-1/4"D	10"W x 12-3/4"H	316.69

Sterling Hts, MI - Livonia, MI - Lansing, MI - Grand Rapids, MI - Waterford, MI - Almont, MI - Saginaw, MI

**Equipment**

Equipment

**Power Humidifiers**

- Fan-powered ----- 120V
- Mounts easily on the warm or return plenum
- Uses #35 water panel
- Branded Luxaire to match your Luxaire furnace
- Includes manual humidistat
- 5-Year limited warranty on parts



Prod ID#	CSI#	Capacity (gpd)	Unit Dimensions	Plenum Opening	Price
68580	S1-FP7000MT	18	16W x 18"H x 10-11/32"D	14-3/4"W x 14-5/16"H	488.43

**Electronic Air Cleaners**

**High Efficiency Hybrid Electronic/Media Air Cleaner**

- Rated #1 overall whole-home air cleaner 3 years in a row by a leading consumer ratings magazine
- The filter media, S1-FM501 has a surface area of 72.3 ft<sup>2</sup>
- Equivalent to MERV 16, the highest MERV rating achievable
- 80% efficient on virus-size particles 1000 times smaller than you can see
- 94% efficient on Respirable dust
- 5-Year limited warranty on parts



Prod ID#	CSI #	Cabinet Dimension	Duct Opening	Filter Size	Price
68575	S1-HEAC3000T	18-1/4" x 31" x 12"	15-1/2" x 24-5/8"	S1-FM501	1354.96

**High Efficiency Electronic Air Cleaners**

- Designed to fit virtually any configuration in the return air duct, and as an exact match with your Luxaire furnace
- Carbon Filters that remove gaseous odors.
- Dual Indicator Lights show unit is operating at a glance.
- Electronic Air Proving Switch automatically powers the unit during operational cycles.
- The quietest operation compared to other brands.
- User friendly and easy to maintain. Efficiency - 1.0 to 3.0 microns
- 5-Year limited warranty on parts



Prod ID#	CSI #	Cabinet Dimension	Duct Opening	Filter Size	Price
57853	GA50A14 (4710)	19-13/16" x 25-13/16" x 7-1/2"	13-9/16" x 24-1/8"	16" x 25" x 5"	875.23
57854	GA50A20 (4700)	25-11/16" x 25-13/16" x 7-1/2"	18" x 23-1/3"	20" x 25" x 5"	941.41

**Media Air Cleaners**

**Merv 11 High Efficiency Media Air Cleaners**

- Designed to fit virtually any configuration in the return air duct, and as an exact match with your Luxaire furnace
- Unit comes complete with metal cabinet and pleated filter assembly
- Offers great dust holding capacity at very low air resistance
- MERV 11 filter assembly
- 5-Year limited warranty on parts



Prod ID#	CSI #	Cabinet Dimension	Duct Opening	Filter Size	Price
68576	S1-TM11PAC16252	17-3/4" x 23-7/8" x 6-3/4"	15-7/16" x 23-7/8"	S1-FM410	243.36
68577	S1-TM11PAC20252	22-1/16" x 21-3/16" x 6-3/4"	19-3/4" x 21-3/16"	S1-FM210	243.36

Equipment

Equipment

**Accessories**

Prod ID#	CSI#	Description	Price
69441	S1-FM410	16X25 MEDIA For TM11PAC MERV11	63.76
69442	S1-FM210	20X25 MEDIA For TM11PAC MERV11	68.01
44105	SG501	MEDIA For S1-HEAC3000T	92.45
1294	GA10 (7900)	Replacement Media Pad for S1-BP5000MT	23.17
21200	GA35 (7902)	Replacement Media Pad for S1-BP6000MT & S1-FP7000MT	29.80
61740	1CB0514	Comb Floor Base 14.5" for 33" furnace	220.42
36938	1CK0604	4" Draft Hood Kit 80% Up/Dn	405.92
22181	CVENT-2	2" Concentric Kit 40-100mbh 90%	85.70
31246	CVENT-3	3" Concentric Kit 120-140mbh 90%	97.97
59262	1HT0902	Horiz Only Sidewall Vent Kit 90% 2"	37.65
48872	1HT0901	Horiz Only Sidewall Vent Kit 90% 3"	44.62
21360	1NP0347	Natural to LP Conversion Kit	118.51
59361	1NP0501	130MBH LP Conversion Kit	126.86
62116	1NP0681	LP Kit For All Modulating Furnaces ending in <b>MP12C</b>	121.27
59200	S1-2LA06700424	Low Ambient Kit, R410A	286.55
58791	S1-ADDWIRE	T-Stat Add-a-Wire Kit	55.35
62798	NS2-0000-03	Universal Pressure Switch	57.21
72885	NT02	N-Take 2, Alt Intake/Combustion Alr	38.52
77303	S1-11-293	1/4" x 5' Alum Pilot Kit	41.45

**Crankcase Heater Kits**

Prod ID#	CSI#	Description	Price
66796	S1-02519961701	Heater,CC,Band,45W,240V,24-30" TC3B1.5-2.5T	42.02
73535	S1-02547272000	Heater,CC,240V(W/Temp Switch) TC3B 4 & 5T	99.44

**Think of us for all  
your product needs!**

**Equipment**

Equipment

**CA Series R410A Uncased "A" Coils**

- ARI certified w/OEM condensing units (TC3B 13seer & TCJF 14.5 seer **R410A**)
- Swaged coils
  - 3/4" Drain
- Hi-Temp Plastic Drain Pans
- Left hand Drain Access
- Full 5-year factory warranty.  
10 Years if registered on-line within  
60 Days at www.aspenmfg.com
- **R-410A - 3 row coils**
- **NON-TXV COILS - Must add TXV w/TCJF's**
- Enhanced louvered fins and rifled  
copper tubing



Prod ID#	CSI#	Tons	Piston	SUQ	LIQ	Size (W x D x H)	Price
64897	CA24A3G-130L-003	1.5-2.0	.055	3/4"	3/8"	13" x 19-1/2" x 13"	604.76
64898	CA24A3G-160L-003	1.5-2.0	.055	3/4"	3/8"	16" x 19-1/2" x 13"	604.76
64899	CA30A3G-130L-003	2.5	.059	3/4"	3/8"	13" x 19-1/2" x 15"	643.28
64900	CA30A3G-160L-003	2.5	.059	3/4"	3/8"	16" x 19-1/2" x 15"	639.43
64902	CA36A3G-160L-003	3.0	.068	3/4"	3/8"	16" x 19-1/2" x 17"	701.06
64903	CA36A3G-195L-003	3.0	.068	3/4"	3/8"	19-1/2" x 19-1/2" x 17"	701.06
64904	CA42A3G-160L-003	3.5	.074	7/8"	3/8"	16" x 19-1/2" x 19"	760.13
64905	CA42A3G-195L-003	3.5	.074	7/8"	3/8"	19-1/2" x 19-1/2" x 19"	760.13
64906	CA48A3G-195L-003	4.0	.080	7/8"	3/8"	19-1/2" x 19-1/2" x 21"	803.68
64907	CA48A3G-230L-003	4.0	.080	7/8"	3/8"	23" x 19-1/2" x 21"	803.68
64908	CA60A3G-195L-003	5.0	.089	7/8"	3/8"	19-1/2" x 19-1/2" x 25"	914.53
64909	CA60A3G-230L-003	5.0	.089	7/8"	3/8"	23" x 19-1/2" x 25"	914.53

\*\*\* These Coils can be used in 10 SEER applications. \*\*\*

\*\*\* CA/CC24A3G's can be used up to 3 ton 10 Seer, but must have the appropriate piston kit changed out.

\*\*\* CA/CC42A3G's can be used from 3.5 to 5 ton 10 Seer, but must have the appropriate piston kit changed out.

\*\*\* CA/CC48A3G can be used for 5 ton 10 Seer 23" Wide, but must have the appropriate piston kit changed out.

**CC Series R410A CASED "A" Coils**

- ARI certified w/OEM condensing units (TC3B 13seer **R410A**)
- Swaged coils
  - 3/4" Drain
- Hi-Temp Plastic Drain Pans
- Left hand Drain Access
- Full 5-year factory warranty.  
10 Years if registered on-line within  
60 Days at www.aspenmfg.com
- **R-410A - 3 Row Coils**
- **NON-TXV COILS**
- Enhanced louvered fins and rifled  
copper tubing



Color of cabinet matches Furnace

Prod ID#	CSI#	Tons	Piston	SUQ	LIQ	Size (W x D x H)	Price
65543	CC24A3G-145L-043	1.5-2.0	.055	3/4"	3/8"	14.5" x 21-1/2" x 16"	777.25
65403	CC24A3G-175L-043	1.5-2.0	.055	3/4"	3/8"	17.5" x 21-1/2" x 16"	777.25
65544	CC30A3G-145L-043	2.5	.059	3/4"	3/8"	14.5" x 21-1/2" x 16"	811.49
65545	CC30A3G-175L-043	2.5	.059	3/4"	3/8"	17.5" x 21-1/2" x 16"	811.49
65547	CC36A3G-175L-043	3.0	.068	3/4"	3/8"	17.5" x 21-1/2" x 20"	879.97
65548	CC36A3G-210L-043	3.0	.068	3/4"	3/8"	21" x 21-1/2" x 20"	879.97
65549	CC42A3G-175L-043	3.5	.074	7/8"	3/8"	17.5" x 21-1/2" x 20"	934.75
65550	CC42A3G-210L-043	3.5	.074	7/8"	3/8"	21" x 21-1/2" x 20"	934.75
65551	CC48A3G-210L-043	4.0	.080	7/8"	3/8"	21" x 21-1/2" x 24"	989.54
65552	CC48A3G-245L-043	4.0	.080	7/8"	3/8"	24.5" x 21-1/2" x 24"	989.54
65553	CC60A3G-210L-043	5.0	.089	7/8"	3/8"	21" x 21-1/2" x 28"	1088.83
65554	CC60A3G-245L-043	5.0	.089	7/8"	3/8"	24.5" x 21-1/2" x 28"	1088.83

**Equipment**

Equipment

**Metering Orifice Piston Kits R410A & R22**



Prod ID#	CSI#	Size	Price
64912	ASP4006	.049 Orifice Kit 1.5T R410A	10.59
64913	ASP3999	.055 Orifice Kit 1.5T R22, 2T R410A	10.59
64914	ASP4000	.059 Orifice Kit 2T R22, 2.5T R410A	10.59
64915	ASP3987	.068 Orifice Kit 2.5T R22, 3T R410A	10.59
64916	ASP4001	.074 Orifice Kit 3T R22, 3.5T R410A	10.59
64917	ASP3990	.080 Orifice Kit 3.5T R22, 4T R410A	10.59
64918	ASP3991	.084 Orifice Kit 4T R22	10.59
64920	ASP3960	.089 Orifice Kit 5T R410A	10.59
64919	ASP3998	.092 Orifice Kit 5T R22	10.59

**Bolt on TXV's**

Prod ID#	CSI#	Description	Price
64921	ASP4200	1.5-3.5 Ton R-410A TXV Kit (X5-3)	143.81
64922	ASP4202	4-5 Ton R-410A TXV Kit (X5-5)	143.81

**Drain Pans**

Prod ID#	CSI#	Description	Price
65428	Z30-ML	13" X 19 1/2" Metal Drain Pan	119.84
65415	Z31-ML	16" X 19 1/2" Metal Drain Pan	119.84
65429	Z32-ML	19 1/2" X 19 1/2" Metal Drain Pan	119.84
65430	Z33-ML	23" X 19 1/2" Metal Drain Pan	119.84
64931	ASP1826	13" X 19 1/2" GLPP Plastic Drain Pan	119.84
64933	ASP1827	16" X 19 1/2" GLPP Plastic Drain Pan	119.84
64934	ASP8591	19 1/2" X 19 1/2" GLPP Plastic Drain Pan	119.84
64935	ASP8593	23" X 19 1/2" GLPP Plastic Drain Pan	119.84

**Your Business is Important to Us. We Offer  
the Best in Service, Quality and Price.**



**Equipment**

**CC Series R410A CASED "A" Coils With TXV's Factory Installed**

- ARI certified w/OEM condensing units (TC3B 13seer **R410A**)
  - Swaged coils
  - Hi-Temp Plastic Drain Pans
  - Left hand Drain Access
  - Full 5-year factory warranty.  
10 Years if registered on-line within  
60 Days at www.aspenmfg.com
  - **\*\*\*\*Only stocking this product in Grand Rapids**
- 3/4" Drain
  - **R-410A - 3 Row Coils**
  - **20% Bleed Type TXV Factory Installed**
  - Enhanced louvered fins and rifled  
copper tubing



Color of cabinet matches Furnace

Prod ID#	CSI#	Tons	Meter	SUQ	LIQ	Size (W x D x H)	Price
78911	CC24A36-145L-025	1.5-2.0	TXV	3/4"	3/8"	14.5" x 21-1/2" x 16"	869.70
78912	CC24A36-175L-025	1.5-2.0	TXV	3/4"	3/8"	17.5" x 21-1/2" x 16"	869.70
78913	CC30A36-145L-025	2.5	TXV	3/4"	3/8"	14.5" x 21-1/2" x 16"	914.21
78914	CC30A36-175L-025	2.5	TXV	3/4"	3/8"	17.5" x 21-1/2" x 16"	914.21
78915	CC36A36-175L-025	3.0	TXV	3/4"	3/8"	17.5" x 21-1/2" x 20"	989.54
78916	CC36A36-210L-025	3.0	TXV	3/4"	3/8"	21" x 21-1/2" x 20"	989.54
78917	CC42A36-175L-025	3.5	TXV	7/8"	3/8"	17.5" x 21-1/2" x 20"	1030.62
78918	CC42A36-210L-025	3.5	TXV	7/8"	3/8"	21" x 21-1/2" x 20"	1030.62
78919	CC48A36-210L-025	4.0	TXV	7/8"	3/8"	21" x 21-1/2" x 24"	1092.26
78920	CC48A36-245L-025	4.0	TXV	7/8"	3/8"	24.5" x 21-1/2" x 24"	1092.26
78921	CC60A36-210L-025	5.0	TXV	7/8"	3/8"	21" x 21-1/2" x 28"	1188.13
78922	CC60A36-245L-025	5.0	TXV	7/8"	3/8"	24.5" x 21-1/2" x 28"	1188.13



Equipment

**Equipment**

Equipment

**TCD Series 13 SEER R410A 3-Phase Split System A/C's 3-5T**

- 5-Year limited warranty on the compressor
- 1-Year limited warranty on the parts
- Stamped coil guard to protect outdoor coil
- Molded composite bulkhead isolates compressor
- Low operating sound levels
- Ball Bearing Cond Fan Mtrs
- Diagonal base valves, swing panel for easy service
- Each compressor is protected against high and low pressure and excessive temperature with internal pressure relief valve
- Microchannel aluminum coils
- UL & CUL Listed



Prod ID#	CSI#	Cooling Tons	Liquid Line OD	Vapor Line OD	Comp	Fuse Amp	Voltage	Dimensions H x W x D	Price
74981	TCD36B31S	3	3/8"	3/4"	Recip	20	208/230-3-60	36.25 x 29.25 x 29.25	2350.23
74985	TCD48B31S	4	3/8"	7/8"	Scroll	30	208/230-3-60	33.25 x 35.25 x 31.75	2994.90
74987	TCD60B31S	5	3/8"	1-1/8"	Scroll	35	208/230-3-60	36.25 x 38 x 34.25	3396.10
74988	TCD60B41S	5	3/8"	1-1/8"	Scroll	15	460-3-60	36.25 x 38 x 34.25	3396.10

**\*\* TCD60 has a 7/8" valve - 7/8" x 1-1/8" adapters needed**

**PCG4 - 14 SEER R410A 81% AFUE Gas/Elec 1-Phase Package Heat/Cool 2-5T**

- 5-Year limited compressor warranty - 10yr if registered on-line within 90days
- 20-Year limited heat exchanger warranty - Lifetime if registered on-line within 90days
- 5-Year limited parts warranty - 10yr if registered on-line within 90days
- Non-corrosive condensate pan
- Durable powder-painted galvanized steel
- Stainless steel tubular heat exchanger
- ECM fans for higher efficiency and lower sound



Prod ID#	CSI#	Cooling Tons	Input BTU	Output BTU	AFUE %	Curb	Voltage	Compr	Sound (dBA)	Price
71543	PCG4A240752X1	2	75	60	81	S1-1RC0502	208-230-1-60	Recip	75	5383.68
71544	PCG4A300752X1	2-1/2	75	60	81	S1-1RC0502	208-230-1-60	Recip	75	5727.72
71545	PCG4A361002X1	3	100	80	81	S1-1RC0502	208-230-1-60	Recip	74	5892.74
71546	PCG4A421002X1	3-1/2	100	80	81	S1-1RC0502	208-230-1-60	Scroll	74	6650.56
71547	PCG4B481252X1	4	125	100	81	S1-1RC0504	208-230-1-60	Scroll	74	6953.89
71548	PCG4B601252X1	5	125	100	81	S1-1RC0504	208-230-1-60	Scroll	76	7651.26

**Luxaire Accessories - PCG4 2-5 Ton**

Prod ID#	CSI#	Description	Price
71549	S1-1FA0501	FRESH AIR DAMPER 0-50% PCG4A/PCE4A'S 2-3.5 Ton	295.00
71550	S1-1FA0502	FRESH AIR DAMPER 0-50% PCG4B'S 4-5 Ton	306.56
71551	S1-1FF0601	FILTER FRAME KIT PCG4A/PCE4A's 2-3.5 Ton	120.31
71552	S1-1FF0602	FILTER FRAME KIT PCG4B 4-5 Ton	130.49
71553	S1-1NP0703	LP KIT PCG4A 2-3.5 Ton	84.17
71554	S1-1NP0702/1NP0704	LP KIT PCG4B 4-5 Ton	79.29
71555	S1-1RC0502	CURB PCG4A/PCE4A's 2-3.5 Ton 14" Tall	317.82
71556	S1-1RC0504	CURB PCG4B 4-5 Ton 14" Tall	338.99
71557	S1-2EE04710024	ECONOMIZER DOWNFLOW DRY BULB PCG4A/PCE4A's 2-3.5 Ton	1982.78
71558	S1-2EE04710124	ECONOMIZER DOWNFLOW DRY BULB PCG4B 4-5 Ton	2004.20
33650	S1-2EC06700124	TRANSFORMER KIT - ECON 1 PHASE	43.37

**Shaded items are non-stock and subject to freight and ship time**

**Sterling Hts, MI - Livonia, MI - Lansing, MI - Grand Rapids, MI - Waterford, MI - Almont, MI - Saginaw, MI**

**Equipment**

Equipment

**ZD Single Package Htg/Clg 14-SEER R410A 81% AFUE 1-Phase 3-5T**

- 5-Year limited warranty on compressors
- 10-Year limited warranty on heat exchangers
- 1-Year limited warranty on parts
- Simplicity SE Control Board
- Powder paint finish -- Permanently lubricated motors
- Bottom or side air discharge configuration capability(field convertible)
- Aluminum Microchannel Condenser Coil -- Rigging holes in base rails
- Complete factory package - tested, charged, and wired
- Direct drive indoor blower -- CSA agency listing on all units
- 81% AFUE 208/230V 1PHASE -- 32-5/8"H x 44-7/8"D x 82-1/4"



Prod ID#	CSI#	Cooling tons	Heat Input	Heat Output	Voltage	Curb	Weight (lb)	Price
72192	ZD-03H10A1A1ABA1A1	3	100	81	208/230-1-60	1RC0434	475	6156.79
72193	ZD-04H12A1A1ABA1A1	4	125	101	208/230-1-60	1RC0434	605	6697.24
72194	ZD-05H12A1A1ABA1A1	5	125	101	208/230-1-60	1RC0434	640	7809.74

**ZD Single Package Htg/Clg Units 14-SEER R410A 3-PHASE 3-5T**

- 5-Year limited warranty on compressors
- 10-Year limited warranty on heat exchangers
- 1-Year limited warranty on parts
- Compressor is internally protected against high pressure and temperature
- Gas heat, electric cool rooftop unit
- 3, 4 and 5 ton - 14 SEER, 11.8 - 12 EER
- Grooved copper tubes and aluminum-fin construction
- 32-5/8"H x 44-7/8"D x 82-1/4"W
- Convertible between side and down airflow
- Full-perimeter base rails
- Aluminized steel tubular heat exchanger --- 81% AFUE
- 208/230V 3ph and 460V 3ph
- Simlicity Lite Control
- Direct Drive Blower Motor



Prod ID#	CSI#	Cooling tons	Heat Input	Heat Output	Voltage	Curb	Weight (lb)	Price
74992	ZD-03H10A2A1ABA1A1	3	100	81	208/230-3-60	1RC0434	475	6047.82
74993	ZD-03H10B4A1ABA1A1	3	100	81	460-3-60	1RC0434	475	6852.07
74994	ZD-04H12A2A1ABA1A1	4	125	101	208/230-3-60	1RC0434	605	6577.14
74996	ZD-04H12B4A1ABA1A1	4	125	101	460-3-60	1RC0434	605	7379.33
74997	ZD-05H12A2A1ABA1A1	5	125	101	208/230-3-60	1RC0434	640	7662.50
74998	ZD-05H12B4A1ABA1A1	5	125	101	460-3-60	1RC0434	640	8464.69

**Shaded items are non-stock and subject to freight and ship time**

**Sterling Hts, MI - Livonia, MI - Lansing, MI - Grand Rapids, MI - Waterford, MI - Almont, MI - Saginaw, MI**

**Equipment**

Equipment

**ZD-A6 Single Package Htg/Clg Unit R410A 3-Phase 6Ton**

- 5-Year limited warranty on compressors
- 10-Year limited warranty on heat exchangers
- 1-Year limited warranty on parts
- Compressor is internally protected against high pressure and temperature
- IntelliSpeed™ VFD for Multi-speed supply fan operation.
- 2-Stg Gas Heat, 2-Stg electric Clg rooftop unit
- 11 EER - 14.2 IEER
- Grooved copper tubes and aluminum-fin construction
- 32-5/8"H x 44-7/8"D x 82-1/4"W
- Convertible between side and down airflow
- Full-perimeter base rails
- Aluminized steel tubular heat exchanger --- 81% AFUE
- 208/230V 3ph and 460V 3ph
- SE Controller
- Belt Drive Blower Motor



Prod ID#	CSI#	Cooling tons	Heat Input	Heat Output	Voltage	Curb	Weight (lb)	Price
79145	ZD-A6N12B2A1AAA1A1	6	125	100	208/230-3-60	1RC0434	665	9466.68

**Luxaire Accessories - For ZD-03/A6 3-6Ton**

Prod ID#	CSI#	Description	Price
24371	1FA0403	0-35% F.A.D. ZD03-A6	159.22
23296	1RC0434	CURB ZD03-A6 14" TALL	356.10
75172	2EE04709324	ECONOMIZER, LOW LEAK, SINGLE ENTHALPY ZD03-05	1362.02
79146	2EE04709024	ECONOMIZER, LOW LEAK, SINGLE ENTHALPY ZD-A6	1740.08

**ZS - Single Package Htg/Clg Units R410-A ASHRAE 90.1 6.5-12.5T - ON PHASE OUT**

- 5-Year limited warranty on compressors
- 10-Year limited warranty on aluminized steel tubular heat exchangers
- 1-Year limited warranty on the complete unit
- Two compressors with independent refrigeration circuits to provide two stages of cooling
- 2-stage heating
- 10.0 - 11.2 EER, 80% AFUE
- Convertible between side and down airflow
- Unit control board and ignition control board uses flash codes to aid in malfunction diagnosis
- Non-corrosive drain pan
- Suction line freezestats supplied



ZS 6.5 - 12.5 TON

Prod ID#	CSI#	Cooling Tons	Heat Input	Heat Output	Airflow	Voltage	Curb	Weight (lb)	Price
62684	ZS-07N18B4A1AAA1A1	7.5	180	144	Std Motor	460	1RC0471	975	10034.62
62693	ZS-10N24D2A1AAA1A1	10	240	192	Hi Static Motor	208/230-3-60	1RC0471	1200	12725.00
62694	ZS-10N24D4A1AAA1A1	10	240	192	Hi Static Motor	460	1RC0471	1200	12873.09

**Shaded items are non-stock and subject to freight and ship time**

**Sterling Hts, MI - Livonia, MI - Lansing, MI - Grand Rapids, MI - Waterford, MI - Almont, MI - Saginaw, MI**

**Equipment**

**ZS - Single Package Htg/Clg Units R410-A ASHRAE 90.1 6.5-12.5T**

- 5-Year limited warranty on compressors
- 10-Year limited warranty on aluminized steel tubular heat exchangers
- 1-Year limited warranty on the complete unit
- IntelliSpeed™ VFD for Multi-speed supply fan operation.
- Two compressors with independent refrigeration circuits to provide two stages of cooling
- 2-stage heating
- R410-A standard efficiency
- Convertible between side and down airflow
- Unit control board and ignition control board uses flash codes to aid in malfunction diagnosis
- Non-corrosive drain pan
- Foil faced insulation used throughout
- Suction line freezestats supplied



ZS 6.5 - 12.5 TON

Equipment

Prod ID#	CSI#	Cooling Tons	Heat Input	Heat Output	Airflow	Voltage	Curb	Weight (lb)	Price
78237	ZS-07N12R2A1AAA1A2	7.5	120	96	Hi Static Motor	208/230-3-60	1RC0471	975	11419.92
77803	ZS-07N18R2A1AAA1A2	7.5	180	144	Hi Static Motor	208/230-3-60	1RC0471	975	11767.13
78240	ZS-07N18R4A1AAA1A2	7.5	180	144	Hi Static Motor	460	1RC0471	975	11929.50
77800	ZS-10N24R2A1AAA1A2	10	240	192	Hi Static Motor	208/230-3-60	1RC0471	1200	14756.15
77174	ZS-10N24R4A1AAA1A2	10	240	192	Hi Static Motor	460	1RC0471	1200	14918.52
78239	ZS-12N24R2A1BAA1A1	12.5	240	192	Hi Static Motor	208/230-3-60	1RC0471	1475	16642.29
78243	ZS-12N24R4A1BAA1A1	12.5	240	192	Hi Static Motor	460	1RC0471	1475	16804.66

**Luxaire Accessories - ZS06-12 (6.5-12.5ton)**

Prod ID#	CSI#	Description	Price
36276	1FA0413	FRESH AIR DAMP 0-35% 6.5-12.5T ZS06-12	318.43
36277	1RC0471	CURB 6.5-12.5T ZS06-12 14" Tall	616.49
36674	1-5010-5035	CURB ADAPTER SUNLINE > PREDATOR	1757.07
71154	2EE04717424	ECON,DWN,HRZ END, DRY BULB LOW LEAK ZS06-07	1840.55
71155	2EE04717624	ECON,DWN,HRZ END, DRY BULB LOW LEAK ZS08-12	1887.15
71156	2EE04706924	HORZ. ECONOMIZER, SIDE, DRY BULB ZS06-12	1686.22
69823	2EC0403	SINGLE ENTHALPY ECON KIT w/SSE	284.83

**Shaded items are non-stock and subject to freight and ship time**

**Sterling Hts, MI - Livonia, MI - Lansing, MI - Grand Rapids, MI - Waterford, MI - Almont, MI - Saginaw, MI**

**Equipment**

Equipment

**ZS - Single Package Htg/Clg Units R410-A ASHRAE 90.1 15-25T**

- 5-Year limited warranty on compressors
- 10-Year limited warranty on aluminized steel tubular heat exchangers
- 1-Year limited warranty on the complete unit
- IntelliSpeed™ VFD for Multi-speed supply fan operation.
- Two compressors with independent refrigeration circuits to provide two stages of cooling
- 2-stage heating
- R410-A standard efficiency
- Convertible between side and down airflow
- Unit control board and ignition control board us flash codes to aid in malfunction diagnosis
- Non-corrosive drain pan
- Foil faced insulation used throughout
- Suction line freezestats supplied
- \*\*\*\*\* FRESH AIR DAMPER SHIPPED WITH UNIT \*\*\*\*\*



ZS 15 - 25TON

Prod ID#	CSI#	Cooling Tons	Heat Input	Heat Output	Airflow	Voltage	Curb	Weight (lb)	Price
78298	ZS-15N30R2A1AAA1A1	15.0	300	240	Hi Static Motor	208/230-3-60	1RC0436	1900	23881.30
78299	ZS-15N30R4A1AAA1A1	15.0	300	240	Hi Static Motor	460-3-60	1RC0436	1900	23999.01
78300	ZS-20N40R2A1AAA1A1	20.0	400	320	Hi Static Motor	208/230-3-60	1RC0437	2550	27547.79
78301	ZS-20N40R4A1AAA1A1	20.0	400	320	Hi-Static Motor	460-3-60	1RC0437	2550	27664.53
78302	ZS-25N40R2A1AAA1A2	25.0	400	320	Hi-Static Motor	208/230-3-60	1RC0437	2650	29634.45
78303	ZS-25N40R4A1AAA1A2	25.0	400	320	Hi-Static Motor	460-3-60	1RC0437	2650	29751.19

**Luxaire Accessories - ZS15, ZS20, ZS25 (15-25ton)**

Prod ID#	CSI#	Description	Price
30516	1RC0436	CURB 15 TON 3PH ZS15 14" TALL	733.32
30517	1RC0437	CURB 20&25T 3PH ZS20 & ZS25 14" TALL	783.03
69823	2EC0401	SINGLE ENTHALPY ECON KIT w/SSE	284.83
71285	2EE04707924	Dry Bulb Low Leak Economizer ZS15	2800.70
42804	2EE04708024	Dry Bulb Low Leak Economizer ZS20-25	2808.98



Shaded items are non-stock and subject to freight and ship time

**Sterling Hts, MI - Livonia, MI - Lansing, MI - Grand Rapids, MI - Waterford, MI - Almont, MI - Saginaw, MI**

**Equipment**

Equipment

**ZQ - Eclipse Single Package Htg/Clg 14SEER R410-A ASHRAE 90.1 - 3-5 Ton**

- Sits directly on many common competitors footprints
- Designed to match up directly to competitors electrical, gas and controls
- 2" or 4" filter capable
- 1000 hour salt spray power coated paint
- 14 SEER 12 EER, 81% AFUE
- Simplicity SE control comes standard
- **5-Year limited warranty on compressors**
- **10-Year limited warranty on aluminized steel tubular heat exchangers**
- **1-Year limited warranty on the complete unit**



Prod ID#	CSI#	Cooling Tons	Heat Input	Heat Output	Airflow	Voltage	Curb	Weight (lb)	Price
74999	ZQG04E2B1AA1A111A2	3	112	90	Med Static Mtr	208/230-3-60	1RC0456	515	7177.48
75000	ZQG04E4B1AA1A111A2	3	112	90	Med Static Mtr	460	1RC0456	515	7420.52
75001	ZQG05E2B1AA1A111A2	4	112	90	Med Static Mtr	208/230-3-60	1RC0456	550	8083.68
75002	ZQG05E4B1AA1A111A2	4	112	90	Med Static Mtr	460	1RC0456	550	8327.74
75003	ZQG06E2B1AA1A111A2	5	112	90	Med Static Mtr	208/230-3-60	1RC0456	625	8850.87
75004	ZQG06E4B1AA1A111A2	5	112	90	Med Static Mtr	460	1RC0456	625	9093.88

**ZX - Eclipse Single Package Htg/Clg R410-A ASHRAE 90.1 - 7.5-12.5 Ton**

- IntelliSpeed™ VFD for multi-speed supply fan operation
- Sits directly on many common competitors footprints
- Designed to match up directly to competitors electrical, gas and controls
- 2" or 4" filter capable
- 1000 hour salt spray power coated paint
- Simplicit SE control comes standard
- **5-Year limited warranty on compressors**
- **10-Year limited warranty on aluminized steel tubular heat exchangers**
- **1-Year limited warranty on the complete unit**



Prod ID#	CSI#	Cooling Tons	Heat Input	Heat Output	Airflow	Voltage	Curb	Weight (lb)	Price
78182	ZXG08E2B3AA1A111A2	7.5	180	144	Med Static Mtr	208/230-3-60	1RC0457	893	11692.59
78307	ZXG08E4B3AA1A111A2	7.5	180	144	Med Static Mtr	460	1RC0457	893	11932.58
78304	ZXG12E2B3AA1A111A2	10	220	176	Med Static Mtr	208/230-3-60	1RC0457	985	14606.02
78308	ZXG12E4B3AA1A111A2	10	220	176	Med Static Mtr	460	1RC0457	985	14846.02
78305	ZXG14E2B3AA1A111A2	12.5	220	176	Med Static Mtr	208/230-3-60	1RC0457	1047	16082.67
78309	ZXG14E4B3AA1A111A2	12.5	220	176	Med Static Mtr	460	1RC0457	1047	16324.70

**Shaded items are non-stock and subject to freight and ship time**

**Sterling Hts, MI - Livonia, MI - Lansing, MI - Grand Rapids, MI - Waterford, MI - Almont, MI - Saginaw, MI**

Equipment

Equipment

**Luxaire Accessories - ZX / ZQ 04-14 (3-12.5ton)**

Prod ID#	CSI#	Description	Price
69816	1RC0456	14" CURB ZQ04-06 & ZX04-07	597.57
69817	1RC0457	14" CURB ZX08-14	726.66
70164	1FA0415	0-25% F.A.D. 2-POS ZQ04-06 & ZX04-07	369.79
70165	1FA0416	0-25% F.A.D. 2-POS ZX08-14	391.62
69823	2EC0403	SINGLE ENTHALPY ECON KIT w/SSE	284.83
69818	2EE04706124	ECONMIZR DRY BULB DNFL ZX04-07 Generation "1"	1561.93
72204	2EE04706724	ECONMIZR DRY BULB DNFL ZQ04-06 & ZX04-07 Generation "2"	1686.22
72205	2EE04706824	ECONMIZR DRY BULB DNFL ZX08-14 Generation "2"	1686.22
69820	2EE04707024	ECONMIZR DRY BULB HORZ ZQ04-05 & ZX04-06 "2"	1526.71
75501	2EE04707124	ECONMIZR DRY BULB HORZ ZQ06 & ZX07 "2"	1526.71
69821	2EE04707224	ECONMIZR DRY BULB HORZ ZX08 "2"	1526.71
69822	2EE04707324	ECONMIZR DRY BULB HORZ ZX09-14 "2"	1526.71



Shaded items are non-stock and subject to freight and ship time

**Sterling Hts, MI - Livonia, MI - Lansing, MI - Grand Rapids, MI - Waterford, MI - Almont, MI - Saginaw, MI**



**Roof Curb**

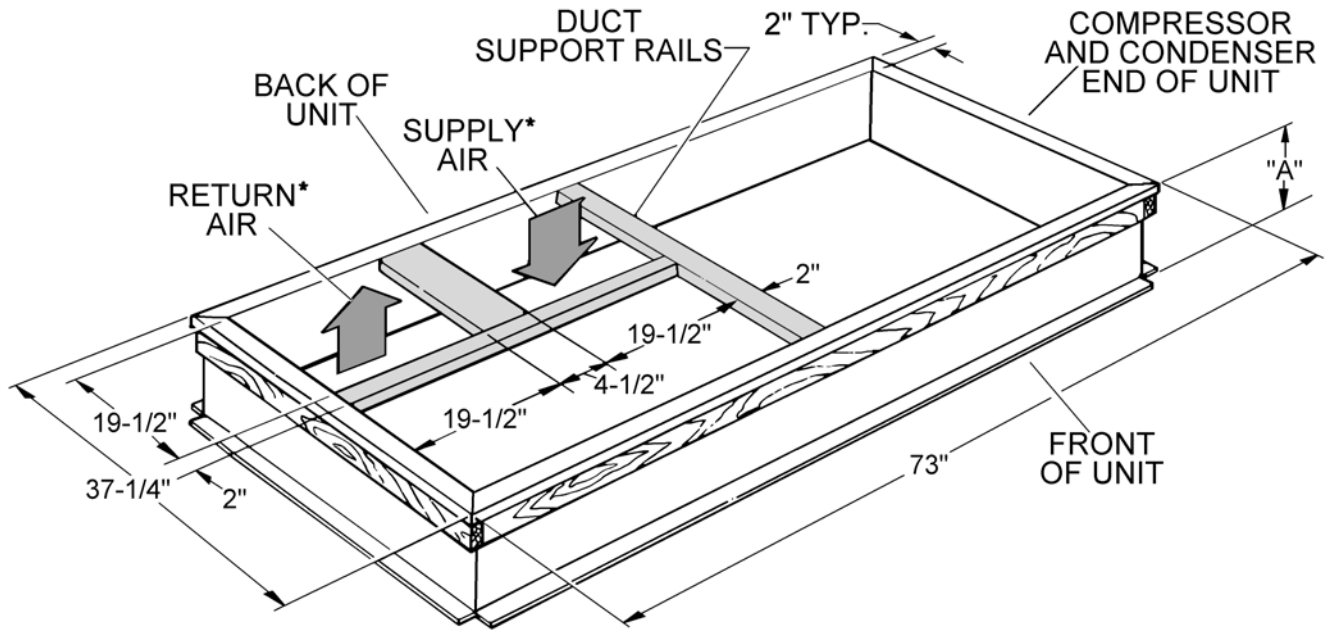

Duct Size:  
 Supply Air = 19-1/4" x 19-1/4"  
 Return Air = 19-1/4" x 19-1/4"

\* Supply and Return Air (including duct support rails) shown are typical for bottom duct applications

For location of horizontal duct applications (on back of unit) refer to Unit Dimension details.

<u>Model</u>	<u>Dimension "A"</u>
1RC0465	8"
1RC0434	14"

**Note:**

1. Roof curb is built to NRCA standards
2. Roof curb is constructed of 18 gauge G90 steel
3. Unit duct supports are provided
4. Full perimeter 4 wood nailer
5. Curbs are shipped unassembled
6. Corner hinge pins are used for assembly

**Suggested roof opening; 43-1/2" long x 33-1/4" wide**

Refer to price pages for other details

Subject to change without notice. Printed in the U.S.A

Equipment

**Roof Curb**

Equipment

\* Supply and Return Air (Including duct support rails) as shown, are typical for bottom duct applications.

For location of horizontal duct applications (On back of unit), refer to Unit Dimension details.

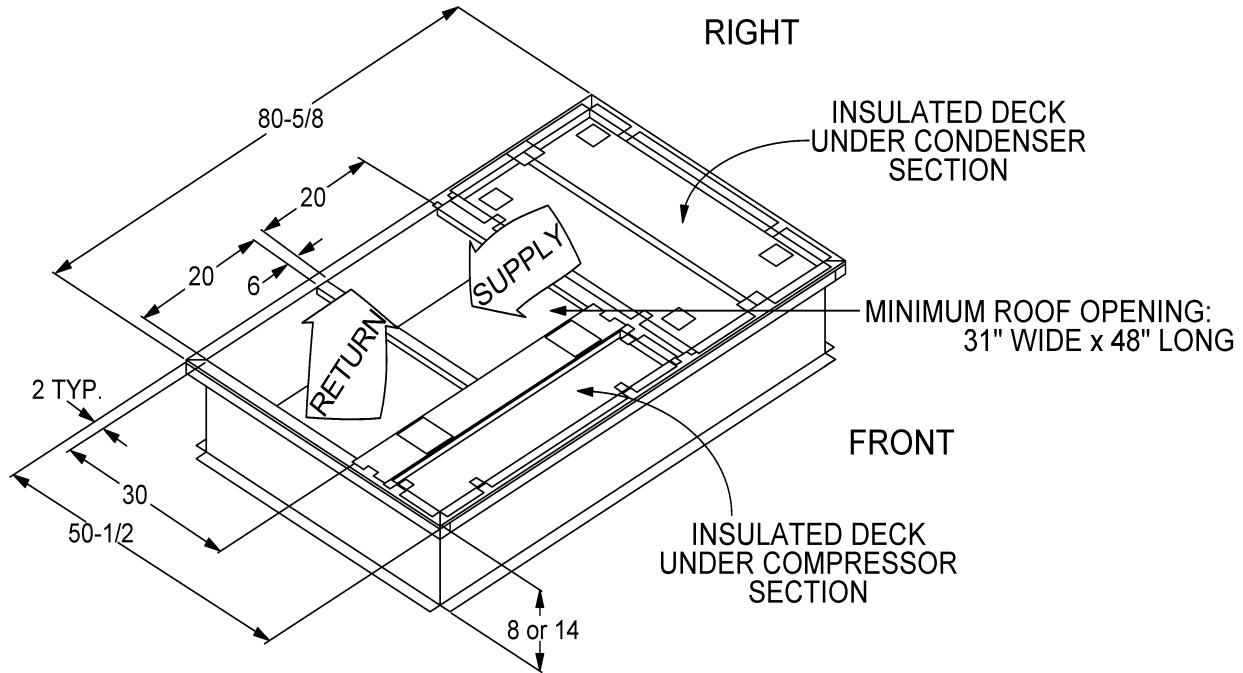

**Roof Curb Model Number**

8" - 1RC0470

14" - 1RC0471

**Note:**

1. Roof curb is built to NRCA standards
2. Roof curb is constructed of 18 gauge G90 steel
3. Unit duct supports are provided
4. Full perimeter 4 wood nailer
5. Curbs are shipped unassembled
6. Corner hinge pins are used for assembly

Subject to change without notice. Printed in the U.S.A.

**Roof Curb**

\* Supply and Return Air (Including duct support rails) as shown, are typical for bottom duct applications.

For location of horizontal duct applications (On back of unit), refer to Unit Dimension details.

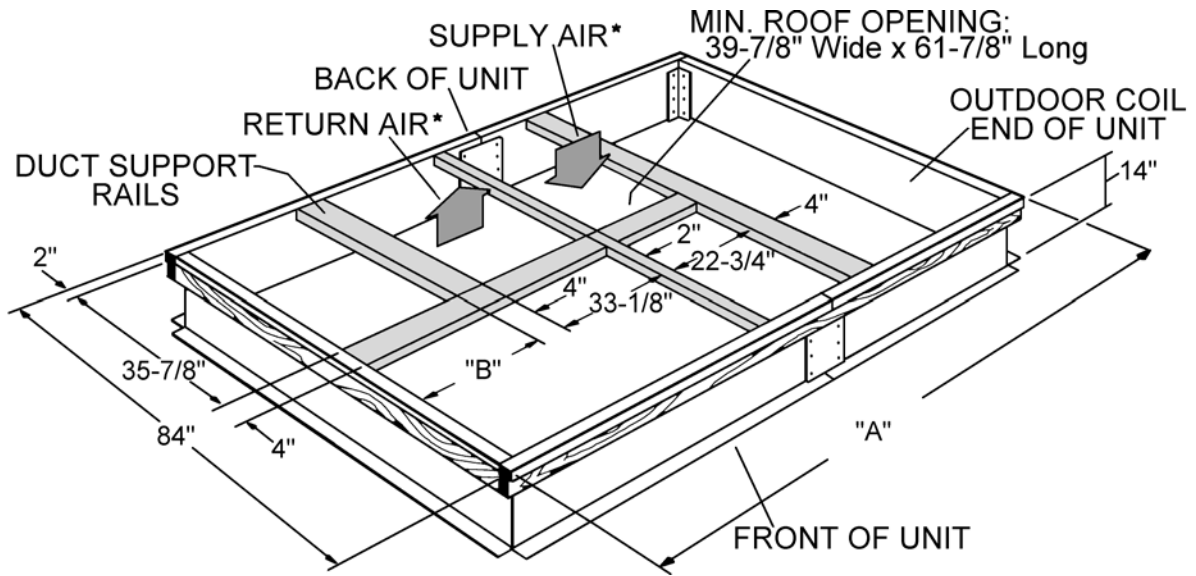

**Duct Sizes:**

Supply Air = 22-1/2" x 35-5/8"

Return Air = 32-7/8" x 35-5/8"

<u>Roof Curb Model Number</u>	<u>Dimension "A"</u>	<u>Dimension "B"</u>
1RC0436	115-1/4"	14-1/4"

<u>SUGGESTED ROOF OPENING</u>		
<u>Model</u>	<u>Length</u>	<u>Width</u>
1RC0436	76"	80"

**Note:**

1. Roof curb is built to NRCA standards
2. Roof curb is constructed of 18 gauge G90 steel
3. Unit duct supports are provided
4. Full perimeter 4 wood nailer
5. Curbs are shipped unassembled
6. Corner hinge pins are used for assembly

Subject to change without notice. Printed in the U.S.A.

**Roof Curb**

Equipment

\* Supply and Return Air (Including duct support rails) as shown, are typical for bottom duct applications.

For location of horizontal duct applications (On back of unit), refer to Unit Dimension details.

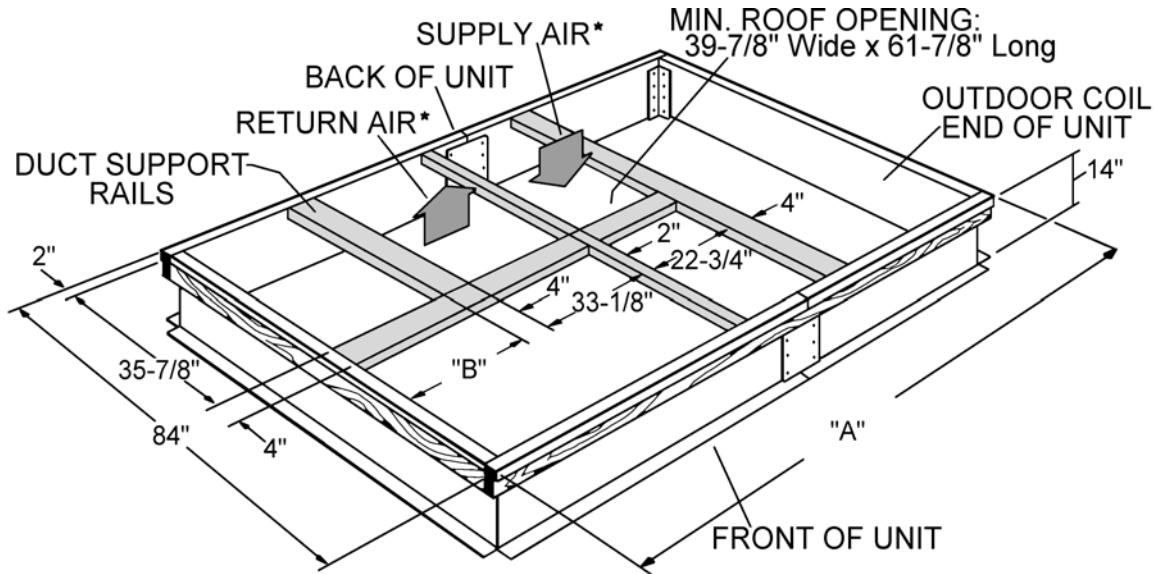

**Duct Sizes:**

Supply Air = 22-1/2" x 35-5/8"

Return Air = 32-7/8" x 35-5/8"

Roof Curb Model Number  
1RC0437

Dimension "A"  
126-1/4 "

Dimension "B"  
25-1/4"

Suggested Roof Opening

<u>Model</u>	<u>Length</u>	<u>Width</u>
1RC0437	87"	80"

**Note:**

1. Roof curb is built to NRCA standards
2. Roof curb is constructed of 18 gauge G90 steel
3. Unit duct supports are provided
4. Full perimeter 4 wood nailer
5. Curbs are shipped unassembled
6. Corner hinge pins are used for assembly

Subject to change without notice. Printed in the U.S.A.

**Roof Curb**

1068153-BTG-F-0414

**ZX04-07, ZY04-06 Unit Clearances**

Direction	Distance (in.)	Direction	Distance (in.)
Top <sup>1</sup>	72	Right	18
Front	36	Left	12
Rear	18 <sup>2</sup> /36 <sup>3</sup>	Bottom <sup>4</sup>	1

1. Units must be installed outdoors. Over hanging structure or shrubs should not obscure condenser air discharge outlet.
2. Units without economizer or power exhaust.
3. Units equipped with an Economizer or Power Exhaust. Flue products must not be discharged within 10 Feet of the rear of the unit.
4. Units may be installed on combustible floors made from wood or class A, B or C roof covering materials.

**ZX08-14, ZY07-12 Unit Clearances**

Direction	Distance (in.)	Direction	Distance (in.)
Top <sup>1</sup>	72	Right	18
Front	48	Left	12
Rear	18 <sup>2</sup> /36 <sup>3</sup>	Bottom <sup>4</sup>	1

1. Units must be installed outdoors. Over hanging structure or shrubs should not obscure condenser air discharge outlet.
2. Units without economizer or power exhaust.
3. Units equipped with an Economizer or Power Exhaust. Flue products must not be discharged within 10 Feet of the rear of the unit.
4. Units may be installed on combustible floors made from wood or class A, B or C roof covering materials.

**ZX04-14/ZY04-12 Unit Roof Curb Dimensions**

**1RC0456, 1RC0458 Roof Curb Dimensions**

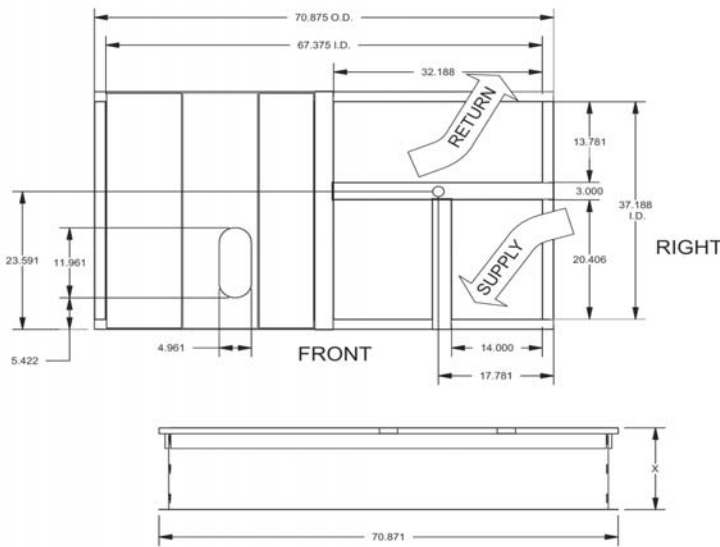

1RC0456 X= 14" Height  
1RC0458 X= 24" Height

**Notes:**

1. Sides, ends and cross support are 18-G90. Deck pans, R/A & S/A supports are 20-G90.
2. Full perimeter wood nailer.
3. Insulated deck pans.

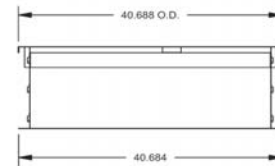
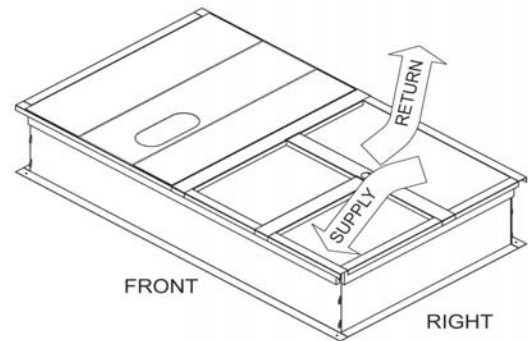

**Unit Models used with 1RC0456, 1RC0458 Roof Curb**

ZX04	ZY04
ZX05	ZY05
ZX06	ZY06
ZX07	

Roof Curb

1068153-BTG-F-0414

1RC0457, 1RC0459 Roof Curb Dimensions

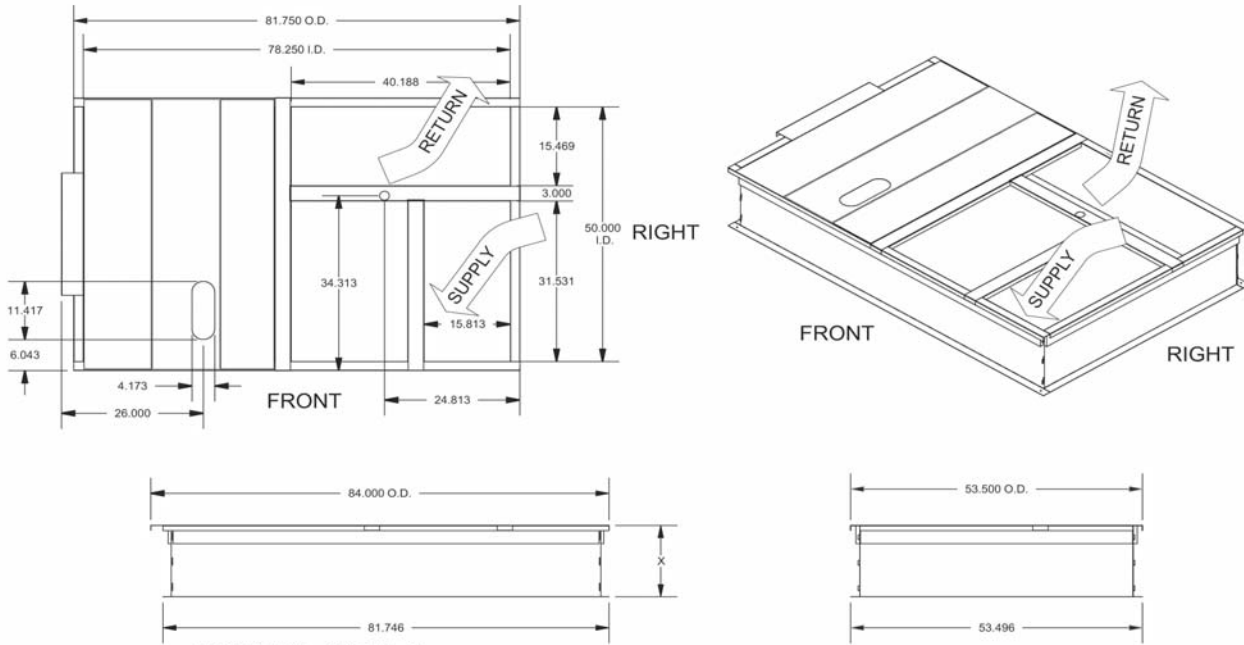

1RC0457 X= 14" Height  
1RC0459 X= 24" Height

**Notes:**

1. Sides, ends, unit locator and cross support are 18-G90. Deck pans, R/A & S/A supports are 20-G90.
2. Full perimeter wood nailer.
3. Insulated deck pans.

**Unit Models used with 1RC0457, 1RC0459 Roof Curb**

ZX08	ZY07
ZX09	ZY08
ZX12	ZY09
ZX14	ZY12

**Equipment**

**Smoke Detectors**

**Air Products Duct Mounted Smoke Detectors**

- Designed to prevent the spread of smoke by air handling systems, fans, and blowers
- Complete systems may be shut down in the event of smoke detection
- Allows up to 30 detectors to be connected for many common functions
- Two sets of 10A form "C" alarm contacts
- Rugged Grey plastic back box, clear plastic cover
- Patent Pending "No-Tools Required" sampling tube install
- Visual indication (LED)
- Factory set tube alignment
- 230 VAC, 115 VAC, 24 VAC, 24 VDC in one model
- Rated to 155°F
- UL 268A listed
- Low-Flow Technology: velocities between 100-4000 ft/min.



Prod ID#	CSI#	Description	Price
57938	SL-2000-N	4 Wire Ionization Detector, Univ Voltage	271.42

**Air Products Duct Smoke Detector Accessories**

Prod ID#	CSI#	Description	Price
37943	MS-KA/R	Remote Alarm LED (Red), Key Operated Test/Reset Switch	95.65
36844	MS-RH/KA/P/A/T	Remote Alarm Horn & LED's, Key Operated	156.01
62723	MSR-50RKAV/W/C	Remote Accessories W/Horn/Strobe Access w/cover Key Operated	193.31

**Smoke Alarm Accessories**

Prod ID#	CSI#	Description	Price
57963	TG-2000	Smoke Emitter for Duct Detectors -Test Gas for SL	98.42

**Duct Smoke Alarm Sampling Tubes**



Prod ID#	CSI#	Description	Price
57939	STN-2.5	Sampling Tube 2.5' (.5' to 2.5' Duct Width)	20.22
57940	STN-5.0	Sampling Tube 5.0' (2.5' to 5.0' Duct Width)	23.73

**Let Us be Your Source of QUALITY PRODUCTS  
and Top-Grade Merchandise from Leading  
Manufacturers.**

Equipment

Equipment

Single Zone Ductless Split Heat Pump Systems

16 SEER Wall Mount Heat Pump System 9RL2/12RL2

- Auto louver, restart/reset, & changeover
- Sleep & 24 hour timers
- Dry, auto, quiet, & coil dry modes
- R-410A
- Now with Inverter
- Wireless remote
- Low ambient
- 115V/60/1



Prod ID#	CSI#	Nom Cool BTU/H	Nom Heat BTU/H	SEER	HSPF	Fuse	FLARE Lineset	Indoor/ Outdoor Combo	Price
67913	9RL2	9,000	10,000	16	9	15	3/8x1/4	ASU9RL2 In AOU9RL2 Out	1951.32
67916	12RL2	12,000	14,000	16	9	20	3/8x1/4	ASU12RL2 In AOU12RL2 Out	2099.60

Indoor Heat Pump Air Handler Units

Prod ID#	CSI#	Nom Cool BTU/H	Nom Heat BTU/H	SEER	HSPF	H x W x D	Price
67914	ASU9RL2	9,000	10,000	16	9	10-5/16" x 32-9/32" x 8-1/8"	780.79
67917	ASU12RL2	12,000	14,000	16	9	10-5/16" x 32-9/32" x 8-1/8"	839.84

Outdoor Heat Pump Condensing Units

Prod ID#	CSI#	Nom Cool BTU/H	Nom Heat BTU/H	SEER	HSPF	H x W x D	Price
67915	AOU9RL2	9,000	10,000	16	9	21-1/4" x 26" x 11-11/32"	1170.54
67918	AOU12RL2	12,000	14,000	16	9	21-1/4" x 26" x 11-11/32"	1259.76

25.3+ SEER Wall Mount Heat Pump Systems

- Auto louver, restart/reset, & changeover
- Sleep & 24 hour timers
- Dry, auto, quiet modes
- R-410A
- Apple Catechin Filter
- Wireless remote
- Economy Mode
- 208-230V/60/1



Indoor Heat Pump Air Handler Units

- Can be used with AOU\*RLS & AOU\*RLSH units
- WIFI Capable

Prod ID#	CSI#	Nom Cool BTU/H	Nom Heat BTU/H	SEER	HSPF	H x W x D	Price
75276	ASU9RLS3Y	9,000	12,000	33	14.2	11-5/8" x 37" x 10-5/8"	1335.89
75275	ASU12RLS3Y	12,000	16,000	29.3	14	11-5/8" x 37" x 10-5/8"	1456.63
75274	ASU15RLS3Y	14,500	18,000	25.3	13.4	11-5/8" x 37" x 10-5/8"	1558.97

Outdoor Heat Pump Condensing Units

- -5 Deg Heating Outdoor units

Prod ID#	CSI#	Nom Cool BTU/H	Nom Heat BTU/H	SEER	HSPF	H x W x D	Price
71065	AOU9RLS3	9,000	12,000	33	14.2	24-7/16" x 31-1/8" x 11-7/16"	1852.91
71068	AOU12RLS3	12,000	16,000	29.3	14	24-7/16" x 31-1/8" x 11-7/16"	2022.18
71071	AOU15RLS3	14,500	18,000	25.3	13.4	24-7/16" x 31-1/8" x 11-7/16"	2166.53



**Equipment**

Equipment

**Outdoor Heat Pump Condensing Units**

- 15 Deg Heating Outdoor Units

Prod ID#	CSI#	Nom Cool BTU/H	Nom Heat BTU/H	SEER	HSPF	H x W x D	Price
71066	AOU9RLS3H	9,000	12,000	33	14	24-7/16" x 31-1/8" x 11-7/16"	2204.58
71069	AOU12RLS3H	12,000	16,000	29.3	13.8	24-7/16" x 31-1/8" x 11-7/16"	2406.66
71072	AOU15RLS3H	14,500	18,000	25.3	13.3	24-7/16" x 31-1/8" x 11-7/16"	2577.25

**15.5-19 SEER Wall Mount Heat Pump 1 to 1 Systems**

- Wireless remote
- Auto louver (4-way), restart/reset, & changeover
- Auto, & quiet modes
- Apple Catechin Filter
- Sleep & 24 hour timers
- Minimum Heat Mode
- Ion Deoderizing Filter
- Economy Mode
- 208-230V/60/1
- R-410A



**Indoor Mini-Split Air Handler Units**

- 14 - 115 deg F Cooling operating Range
- 5 - 75 deg F Heating operating Range



Prod ID#	CSI#	Nom Cool BTU/H	Nom Heat BTU/H	Volts	SEER	H x W x D	Price
71036	ASU18RLB	18,000	18,000	230/208	19.0	12-5/8"x39-5/16"x9"	1363.42
71042	ASU24RLB	24,000	24,000	230/208	18	12-5/8"x39-5/16"x9"	1473.64
71044	ASU30RLXB	30,000	30,000	230/208	16.5	12-5/8"x39-5/16"x9"	2048.43
71046	ASU36RLXB	33,000	34,000	230/208	15.5	12-5/8"x39-5/16"x9"	2732.11

**Outdoor Mini-Split Condenser Units**

- 18mbh and 24mbh - 1/4 x 1/2" Lineset
- 30mbh and 36mbh - 3/8" x 5/8" Lineset



Prod ID#	CSI#	Nom Cool BTU/H	Nom Heat BTU/H	Volts	SEER	H x W x D	Price
71037	AOU18RLB	18,000	18000	230/208	19.0	24-7/16"x31-1/8"x11-7/16"	2041.86
71043	AOU24RLB	24,000	24,000	230/208	18	24-7/16"x31-1/8"x11-7/16"	2209.82
71045	AOU30RLXB	30,000	30,000	230/208	16.5	32-11/16"x35-7/16"x13"	3074.59
71047	AOU36RLXB	33,000	34,000	230/208	15.5	32-11/16"x35-7/16"x13"	4098.14

**Single Zone Ductless 21+ Seer Heat Pump Systems**

**21+ SEER Wall Mount Air Heat Pump System**

- Wireless remote
- R410A
- 24 hour timers
- Auto louver (up/down) & restart/reset
- Dry Mode
- Cooling range F (14-115deg) Heating range F (5-75deg)
- Low ambient
- Energy Star Qualified
- Dry, auto, & quiet modes
- 230V/60/1
- 3/8" X 1/4" Lineset



**Indoor Mini-Split Air Handler Units**

Prod ID#	CSI#	Nom Cool BTU	Nom Heat BTU	Volts	SEER	H x W x D	Price
69253	ASU9RLF1	9,000	12,000	230/208	23	10-1/2" x 33-1/16" x 8"	1069.48
69254	ASU12RLF1	12,000	16,000	230/208	22	10-1/2" x 33-1/16" x 8"	1178.39

**Sterling Hts, MI - Livonia, MI - Lansing, MI - Grand Rapids, MI - Waterford, MI - Almont, MI - Saginaw, MI**

**Equipment**

Equipment

**Outdoor Mini-Split Condenser Units**

Prod ID#	CSI#	Nom Cool BTU/H	Nom Heat BTU	Volts	SEER	H x W x D	Price
69252	AOU9RLFW1	9,000	12,000	230/208	23	21-1/4" x 26" x 11-7/16"	1604.87
69251	AOU12RLFW1	12,000	16,000	230/208	22	21-1/4" x 31" x 11-7/16"	1768.90

**18+ SEER Wall Mount Heat Pump Systems**

- Wireless remote
- R410A
- Sleep & 24 hour timers
- Low ambient
- Extended Lineset length
- 3/8" x 5/8" Linesets
- Dry, auto, and quiet modes
- Cold prevention
- Auto louver
- 208-230V/60/1
- Ion Deoderizing Filter



**Indoor Heat Pump Air Handler Units**

Prod ID#	CSI#	Nom Cool BTU/H	Nom Heat BTU/H	SEER	HSPF	H x W x D	Price
63081	ASU18RLF	See Outdoor	See Outdoor	See Outdoor	See Outdoor	12-5/8" x 39-1/4" x 9"	1810.90
63082	ASU24RLF	See Outdoor	See Outdoor	See Outdoor	See Outdoor	12-5/8" x 39-1/4" x 9"	1929.00

**Outdoor Heat Pump Condensing Units - 18mbh 14 deg Clg / 5 deg Htg - 24mbh 0 deg Clg / 0 deg Htg**

Prod ID#	CSI#	Nom Cool BTU/H	Nom Heat BTU/H	SEER	HSPF	H x W x D	Price
64706	AOU18RLXFW	18,000	21,600	19.2	10	32-3/4" x 35-3/8" x 13"	2593.01
64707	AOU24RLXFW	22,000	27,600	18.0	10	32-3/4" x 35-3/8" x 13"	2805.57

**Outdoor Heat Pump Condensing Units -5 deg Clg / -5 deg Htg**

Prod ID#	CSI#	Nom Cool BTU/H	Nom Heat BTU/H	SEER	HSPF	H x W x D	Price
74625	AOU18RLXFW1	18,000	21,600	20	10.5	32-3/4" x 35-3/8" x 13"	2702.24
75254	AOU24RLXFW1	22,000	25,200	19.5	10.6	32-3/4" x 35-3/8" x 13"	3196.76

**Outdoor Heat Pump Condensing Units -5 deg Clg / -15 deg Htg**

Prod ID#	CSI#	Nom Cool BTU/H	Nom Heat BTU/H	SEER	HSPF	H x W x D	Price
74173	AOU18RLXFWH	18,000	21,600	20	10.4	32-11/16" x 35-7/16" x 13"	3040.70
74172	AOU24RLXFWH	24,000	25,200	19.5	10.5	32-11/16" x 35-7/16" x 13"	3556.19

**16 SEER Wall Mount Heat Pump System 30RLX**

- Wireless remote
- R410A
- Sleep & 24 hour timers
- 0 deg. Low ambient
- Dry, auto, and quiet modes
- Cold prevention
- Auto restart/reset & changeover
- Extended piping 165'



Prod ID#	CSI#	Nom Cool BTU/H	Nom Heat BTU/H	SEER	HSPF	Fuse	FLARE Lineset	Indoor/ Outdoor Combo	Price
63077	30RLX	30,000	32,000	17.5	9.5	30	5/8 x 3/8	ASU30RLX In AOU30RLX Out	5570.49

**Indoor Heat Pump Air Handler Units**

Prod ID#	CSI#	Nom Cool BTU/H	Nom Heat BTU/H	SEER	H x W x D	Price
63070	ASU30RLX	30,000	32,000	17.5	12-5/8" x 39-1/4" x 9"	2228.19

**Sterling Hts, MI - Livonia, MI - Lansing, MI - Grand Rapids, MI - Waterford, MI - Almont, MI - Saginaw, MI**

**Equipment**

Equipment

<b>Outdoor Heat Pump Condensing Units</b>						
Prod ID#	CSI#	Nom Cool BTU/H	Nom Heat BTU/H	SEER	H x W x D	Price
63071	AOU30RLX	30,000	32,000	17.5	32-3/4" x 35-3/8" x 13"	3342.31

**18.7 SEER Wall Mount Heat Pump System 30RLXEH**

- Wireless remote
- R410A
- Sleep & 24 hour timers
- -5 deg. Low ambient
- -15 deg. Heating
- Dry, auto, and quiet modes
- Cold prevention lock out function
- Auto restart/reset & changeover
- Extended piping 246'
- Lead Lag Control



**Indoor Heat Pump Air Handler Units**

Prod ID#	CSI#	Nom Cool BTU/H	Nom Heat BTU/H	SEER	H x W x D	Price
74519	ASU30RLE	30,000	32,000	18.7	13-3/8" x 45-1/4" x 11"	2893.78

**Outdoor Heat Pump Condensing Units**

Prod ID#	CSI#	Nom Cool BTU/H	Nom Heat BTU/H	SEER	H x W x D	Price
74518	AOU30RLXEH	30,000	32,000	18.7	50-16/16" x 35-3/8" x 13"	4339.32

**Hybrid Flex Inverter Heat Pump Systems**

- 7-Year compressor warranty
- 5-Year parts warranty

**Up to 16 SEER Wall, Ceiling, Concealed and Floor Mount Multi-Zone Systems**

- Wireless remote
- Energy Saver
- Sleep & 24 hour timers
- Coil Dry Mode
- Auto Louver : Up/Down
- Auto Restart/Reset & Auto Changeover
- Low ambient
- Long piping 165ft +
- Pump down operation
- Quiet Mode
- 208-230V/60/1
- R-410A

**Indoor Hybrid Air Handler Wall Unit**



Prod ID#	CSI#	Nom Cool BTU/H	Lineset	SEER	H x W x D	Price
69250	ASU7RLF1	7,000	3/8" x 1/4"	See Configuration Table	10-1/2 x 33-1/16 x 8	964.50
69253	ASU9RLF1	9,000	3/8" x 1/4"	See Configuration Table	10-1/2 x 33-1/16 x 8	1069.48
69254	ASU12RLF1	12,000	3/8" x 1/4"	See Configuration Table	10-1/2 x 33-1/16 x 8	1178.39
75224	ASU15RLF1	15,000	1/2" x 1/4"	See Configuration Table	10-1/2 x 33-1/16 x 8	1263.71
63081	ASU18RLF	18,000	1/2" x 1/4"	See Configuration Table	12-5/8 x 39-1/4 x 9	1810.90
63082	ASU24RLF	24,000	5/8" x 1/4"	See Configuration Table	12-5/8 x 39-1/4 x 9	1929.00

Equipment

Equipment

Indoor Hybrid Compact Cassette



Prod ID#	CSI#	Nom Cool BTU/H	Lineset	SEER	H x W x D	Price
69249	AUU7RLF	7,000	3/8" x 1/4"	See Configuration Table	9-11/16 x 22-7/16 x 22-7/16	1265.00
63083	AUU9RLF	9,000	3/8" x 1/4"	See Configuration Table	9-11/16 x 22-7/16 x 22-7/16	1314.79
63084	AUU12RLF	12,000	3/8" x 1/4"	See Configuration Table	9-11/16 x 22-7/16 x 22-7/16	1547.13
63085	AUU18RLF	18,000	1/2" x 1/4"	See Configuration Table	9-11/16 x 22-7/16 x 22-7/16	2180.97

Indoor Hybrid Cassette - Accessory

Prod ID#	CSI#	Description	Price
63087	UTG-CCGF	Compact Cassette Grill	351.67

Indoor Hybrid Slim Duct Air Handler Unit

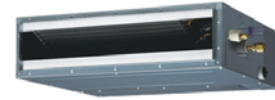

Prod ID#	CSI#	Nom Cool BTU/H	Lineset	SEER	H x W x D	Price
69248	ARU7RLF	7,000	3/8" x 1/4"	See Configuration Table	7-25/32 x 27-9/16 x 24-13/32	1381.79
63088	ARU9RLF	9,000	3/8" x 1/4"	See Configuration Table	7-25/32 x 27-9/16 x 24-13/32	1432.99
63089	ARU12RLF	12,000	3/8" x 1/4"	See Configuration Table	7-25/32 x 27-9/16 x 24-13/32	1485.48
63090	ARU18RLF	18,000	1/2" x 1/4"	See Configuration Table	7-25/32 x 35-7/16 x 24-13/32	1939.49
63092	ARU24RLF	24,000	5/8" x 1/4"	See Configuration Table	7-25/32 x 43-5/16 x 24-13/32	2544.44

Indoor Hybrid Floor Mount Air Handler Unit

- 2-Fan and Wide Airflow



Prod ID#	CSI#	Nom Cool BTU/H	Lineset	SEER	H x W x D	Price
69245	AGU9RLF	9,000	3/8" x 1/4"	See Configuration Table	23-5/8 x 29-1/8 x 7-7/8	1558.94
69246	AGU12RLF	12,000	3/8" x 1/4"	See Configuration Table	23-5/8 x 29-1/8 x 7-7/8	1700.68
69247	AGU15RLF	15,000	1/2" x 1/4"	See Configuration Table	23-5/8 x 29-1/8 x 7-7/8	1822.65

Outdoor Hybrid Condenser Heat Pump Units



Prod ID#	CSI#	Nom Cool BTU/H	Nom Heat BTU/H	Zone	SEER	HSPF	H x W x D	Price
64691	AOU18RLXFZ	18,000	22,000	Multi	See Configuration Table	9.0	27-9/16" x 35-7/16" x 13"	3001.12
64692	AOU24RLXFZ	22,000	24,000	Multi	See Configuration Table	9.0	27-9/16" x 35-7/16" x 13"	3409.21
71063	AOU36RLXFZ1	33,800	36,400	Multil	See Configuration Table	8.7	32-11/16" x 35-7/16" x 13"	5289.68

**Equipment**

Equipment

**Multi Zone Outdoor Unit**

- The compact size of the outdoor units allows for many installation opportunities



Prod ID#	CSI#	Nom Cool BTU/H	Nom Heat BTU/H	Zone	SEER	HSPF	H x W x D	Price
74168	AOU45RLXFZ	45,000	36,900	Multi	See Configuration Table	9.3+	39-5/16" x 38-3/16" x 14-9/16"	6267.63

**Outdoor Hybrid Condenser Heat Pump Units -15 DEG**



Prod ID#	CSI#	Nom Cool BTU/H	Nom Heat BTU/H	Zone	SEER	HSPF	H x W x D	Price
71061	AOU18RLXFZH	18,000	22,000	Multi	See Configuration Table	9	32-11/16" x 35-7/16" x 13"	4192.63
71062	AOU24RLXFZH	22,000	24,000	Multi	See Configuration Table	9	32-11/16" x 35-7/16" x 13"	4935.37
74169	AOU36RLXFZH	35,200	36,400	Multi	See Configuration Table	9.3+	39-5/16" x 38-3/16" x 14-9/16"	6854.01

**Outdoor Hybrid Condenser Heat Pump Unit**

- Up to 8- Heads
- 80% - 130% connectable capacity
- Connect 39,000 to 62,000 BTU's
- Long Lineset Length Capable
- 156 Combinations Possible based on BTU

**\*Requires Certification to Purchase and Install\***



Prod ID#	CSI#	Nom Cool BTU/H	Nom Heat BTU/H	Zone	SEER	HSPF	H x W x D	Price
63093	AOU48RLXFZ1	48,000	54,000	Multi	See Configuration Table	9.0+	36" x 38-1/4" x 14-5/8"	6104.59

**Outdoor Hybrid AOU48RLXFZ - Accessories**

Prod ID#	CSI#	Description	Price
63096	UTP-PU03A	3EEV BRANCH BOX-PRIMARY FLEX	793.91
63679	UTP-PU03B	3EEV BRANCH BOX-SECONDARY FLEX	717.81
63680	UTP-SX248A	SEPARTION TUBE ASSY KIT FLEX	227.01

**Outdoor Condenser Heat Pump Units**

- These outdoor units can only be used with the AUU (Compact Cassette) & ARU (Compact Duct)
- They must be in a 1 to 1 configuration



Prod ID#	CSI#	Nom Cool BTU/H	Nom Heat BTU/H	Zone	SEER	HSPF	H x W x D	Price
67919	AOU9RLFC	9,000	12,000	Sng	21.5+	12.2	24.5" x 31-3/32"x 11-1/3"	1848.95
67920	AOU12RLFC	12,000	16,000	Sng	20.0+	11.5	24.5"x31-3/32"x11-1/3"	2015.62
67921	AOU18RLFC	18,000	21,600	Sng	19.7+	11.3	24.5"x31-3/32"x11-1/3"	2686.18

**Outdoor Condenser Heat Pump Units - LOW TEMPERATURE Minus 15 Degrees**

- These outdoor units can only be used with the AGU\*RLF Floor Mount Indoor Units
- They must be in a 1 to 1 configuration



Prod ID#	CSI#	Nom Cool BTU/H	Nom Heat BTU/H	Zone	SEER	HSPF	H x W x D	Price
69256	AOU9RLFFH	9,000	12,000	Sng	26	12.4	24-7/16"x31-1/8"x11-7/16"	2119.28
69257	AOU12RLFFH	12,000	16,000	Sng	22.7	11.3	24-7/16"x31-1/8"x11-7/16"	2313.33
69258	AOU15RLFFH	14,200	18,000	Sng	20.3	11	24-7/16"x31-1/8"x11-7/16"	2477.51

**Sterling Hts, MI - Livonia, MI - Lansing, MI - Grand Rapids, MI - Waterford, MI - Almont, MI - Saginaw, MI**

Equipment

Equipment

## Single Zone And Multi-Zone Systems Lineup

Minimum Ambient Heating Temperatures: ■ +14°F ■ +5°F ■ 0°F ■ -5°F ■ -15°F

SINGLE ZONE WALL MOUNTED MINI-SPLITS		9,000			12,000			15,000		
Good	Wall Mount Entry Level Heat Pump									
	Wall Mount High SEER									
Best	Wall Mount Highest Efficiency									
	Wall Mount Built-In Wi-Fi, Highest Efficiency									
	Wall Mount Extra Low Temp Heating									
	Wall Mount Built-In Wi-Fi, Extra Low Temp Htg									
SINGLE ZONE NON-WALL MOUNTED MINI-SPLITS										
Good	Universal Mount Floor/Ceiling									
	Ceiling Suspended									
	Large Cassette									
Best	Slim Duct Horizontal/Vertical									
	Compact Cassette									
	Floor Mount Highest Efficiency									
	Floor Mount Extra Low Temp Heating									
MULTI ZONE MINI-SPLITS - INDOOR UNITS										
BTU	7,000	9,000	12,000	15,000	18,000	24,000				
Compact Wall Mount										
Large Wall Mount										
Slim Duct										
Compact Cassette										
Floor Mount										

6

**Equipment**

Equipment

Minimum Ambient Heating Temperatures: ■ +14°F ■ +5°F ■ 0°F ■ -5°F ■ -15°F

BTU	18,000	24,000	30,000	36,000	42,000
BTU	18,000 (2 Indoor Units)	24,000 (2 - 3 Indoor Units)	36,000 (2* - 4 Indoor Units)	45,000 (2 - 5 Indoor Units)	48,000 (2 - 8 Indoor Units)
<b>Better</b>					
<b>Best</b>					

\* If AOU36RLXFZ1 is paired with two 18,000 BTU indoor units, you have to purchase optional kit Part #K9FZ1818.  
 + The only combinations that qualify for ENERGY STAR® are:  
 AOU18RLXFZ with (2) ASU9RLF1  
 AOU18RLXFZ with (1) ASU7RLF1 + (1) ASU12RLF1  
 AOU18RLXFZ with (1) ASU9RLF1 + (1) ASU12RLF1  
 AOU18RLXFZH with (2) ASU9RLF1  
 AOU24RLXFZ with (2) ASU7RLF1 + (1) ASU9RLF1  
 AOU24RLXFZH with (2) ASU7RLF1 + (1) ASU9RLF1  
 AOU36RLXFZ1 with (4) ASU9RLF1  
 AOU36RLXFZH with (4) ASU9RLF1

2017 Products



**Equipment**

Equipment

**Ceiling & Universal Mounted Heat Pump Systems**

- 6 Year compressor warranty
- 2 Year parts warranty

**14-16 SEER Ceiling Cassette Heat Pump System 18RLCX/24RLCX/36RLCX**

- Full function wired remote, remote control sensor
- Weekly timer
- Dry, auto, & high ceiling modes
- Auto louver (up/down), restart/reset, & changeover
- Low ambient
- Cold prevention
- Pump down operation
- Branch duct capable
- 208-230V/60/1
- R-410A



Prod ID#	CSI#	Nom Cool BTU/H	Nom Heat BTU/H	SEER	HSPF	Fuse	FLARE Lineset	Indoor/Outdoor Combo	Price
53208	18RCLX	17,800	21,000	16.0	8.5	20	1/2" x 1/4"	AUU18RCLX In AOU18RLX Out	6739.68
53209	24RCLX	22,200	24,200	15.0	8.5	20	5/8" x 3/8"	AUU24RCLX In AOU24RLX Out	7743.58
53210	36RCLX	34,100	36,000	14.0	8.5	30	5/8" x 3/8"	AUU36RCLX In AOU36RLX Out	9601.73
55811	42RCLX	42,700	45,200	15.0	8.5	30	5/8" x 3/8"	AUU42RCLX In AOU42RLX Out	10826.05

**Indoor Ceiling Cassette Heat Pump Air Handler Units**

Prod ID#	CSI#	Nom Cool BTU/H	Nom Heat BTU/H	SEER	HSPF	H x W x D	Price
53050	AUU18RCLX	17,800	21,000	16.0	8.5	9-3/4" x 32-3/4" x 32-3/4"	3343.60
53052	AUU24RCLX	22,200	24,200	15.0	8.5	9-3/4" x 32-3/4" x 32-3/4"	3839.64
53054	AUU36RCLX	34,100	36,000	14.0	8.5	11-5/8" x 32-3/4" x 32-3/4"	4825.15
55145	AUU42RCLX	42,700	45,200	15.0	8.5	11-5/8" x 32-3/4" x 32-3/4"	5413.02

**Outdoor Ceiling Heat Pump Condenser Units**

Prod ID#	CSI#	Nom Cool BTU/H	Nom Heat BTU/H	SEER	HSPF	H x W x D	Price
53051	AOU18RLX	17,800	21,000	16.0	8.5	32-3/4" x 35-1/2" x 13"	3396.09
53053	AOU24RLX	22,200	24,200	15.0	8.5	32-3/4" x 35-1/2" x 13"	3903.94
53055	AOU36RLX	34,100	36,000	14.0	8.5	32-3/4" x 35-1/2" x 13"	4776.58
55144	AOU42RLX	42,700	45,200	15.0	8.5	50-7/8" x 35-1/2" x 13"	5413.02

*If you don't find everything you need in this catalog, please let us know. We have not listed everything and can special order from most of our manufacturers.*



**Equipment**

Equipment

**Universal Mount Heat Pump System 18RULX/24RULX**

- Wireless remote
- 24 Hour timer
- Dry & auto modes
- Auto louver (4-way), restart/reset, & changeover
- Low ambient
- Cold prevention
- Pump down operation
- Fresh air intake
- R410A
- 208-230/60/1



Prod ID#	CSI#	Nom Cool BTU/H	Nom Heat BTU/H	SEER	HSPF	Fuse	FLARE Lineset	Indoor/ Outdoor Combo	Price
53205	18RULX	17,800	21,500	16.0	8.5	20	1/2" x 1/4"	ABU18RULX In AOU18RLX Out	4867.12
53206	24RULX	22,200	24,000	15.0	8.5	20	5/8" x 3/8"	ABU24RULX In AOU24RLX Out	5560.01

**Indoor Ceiling Suspended Heat Pump Air Handler units**

Prod ID#	CSI#	Nom Cool BTU/H	Nom Heat BTU/H	SEER	HSPF	H x W x D	Price
53056	ABU18RULX	17,800	21,500	16.0	8.5	7-7/8" x 39-1/8" x 25-7/8"	1471.04
53057	ABU24RULX	22,200	24,000	15.0	8.5	7-7/8" x 39-1/8" x 25-7/8"	1656.07

**Outdoor Ceiling Heat Pump Condenser Units**

Prod ID#	CSI#	Nom Cool BTU/H	Nom Heat BTU/H	SEER	HSPF	H x W x D	Price
53051	AOU18RLX	17,800	21,500	16.0	8.5	32-3/4" x 35-1/2" x 13"	3396.09
53053	AOU24RLX	22,200	24,000	15.0	8.5	32-3/4" x 35-1/2" x 13"	3903.94

**14 SEER Ceiling Suspended Heat Pump System 36RSLX**

- Wireless remote
- 24 Hour timer
- Dry & auto modes
- Pump down operation
- R-410A
- Auto louver (4-way), restart/reset, & changeover
- Low ambient
- Cold prevention
- Fresh air intake
- 208-230/60/1



Prod ID#	CSI#	Nom Cool BTU/H	Nom Heat BTU/H	SEER	HSPF	Fuse	FLARE Lineset	Indoor/ Outdoor Combo	Price
53207	36RSLX	34,100	36,500	14.0	8.5	30	5/8" x 3/8"	ABU36RSLX In AOU36RLX Out	7440.45

**Indoor Ceiling Suspended Heat Pump Air Handler units**

Prod ID#	CSI#	Nom Cool BTU/H	Nom Heat BTU/H	SEER	HSPF	H x W x D	Price
53058	ABU36RSLX	34,100	36,500	14.0	8.5	9-1/2" x 65-1/2" x 27-5/8"	2663.86

**Outdoor Ceiling Heat Pump Condenser Units**

Prod ID#	CSI#	Nom Cool BTU/H	Nom Heat BTU/H	SEER	HSPF	H x W x D	Price
53055	AOU36RLX	34,100	36,500	14.0	8.5	32-3/4" x 35-1/2" x 13"	4776.58

**Sterling Hts, MI - Livonia, MI - Lansing, MI - Grand Rapids, MI - Waterford, MI - Almont, MI - Saginaw, MI**

**Equipment**

Equipment

**Accessories/Parts**

Prod ID#	CSI#	Description	Price
61474	UTY-RNBYU	Wired Remote Controller for Compact Cassettes	283.99
66637	UTY-RNNUM	HFI-Wired Remote Control	283.99
69318	UTY-RSNUM	Simple Remote Control	167.25
66950	UTY-TWBXF1	Communic Kit RLS2/UTY-RNNNUM	188.75
71222	UTY-XCBX72	Com Kit RLF1 7, 9, 12 UTYRNNUM	188.75
75577	UTY-WIFI	Wire w/Con Wired WiFi	9.90
60957	K9R410A55	R-410A Charging Adapter 55 Deg Swivel	18.07
65200	10700108	14/4 Electrical Wire <b>Price Per Foot</b>	2.65
75751	10750108	14/4 Electrical Wire with Metal Jacket <b>Price Per Foot</b>	3.11
63330	K9FZ1818	Conv Adapt Kit for AOU36RLXFZ - (2) 18mbh Heads	77.04
65139	70 FUJK3PST	3 Pole - non revers manual switch	89.56

**QuickSling Mini-Split Stands and Wall Bracket**



Prod ID#	CSI#	Description	Price
69620	QSMS1201	12" Mini Split Stand	272.66
69619	QSMS1801	18" Mini Split Stand	301.98
70795	QSMS1202	12" Heavy Duty Mini Split Stand	278.52
70166	QSMS1802	18" Heavy Duty Mini Split Stand	316.63
78776	QSWB4000	Wall Bracket w/Rails-Heavy Duty	216.95

**Fujitsu Mini-Split Pad**

- 2" Pad for use under mini-split stand
- Not for use without mini-split stand

Plastic Pad >>>>



Prod ID#	CSI#	Description	Price
78526	X3244211	32" x 44" x 2" Hef-T-Pad	130.33

**Equipment**

Equipment

**Mini-Split Lineset**

- All Insulated
- 1/2" Insulation
- Plain End



**Series 406**

Prod ID#	CSI#	Length	Liq Line	Suct Line	Price
38969	40620250B6	25'	1/4"	3/8"	174.87
53250	40620500B6	50'	1/4"	3/8"	320.02

**Series 408**

Prod ID#	CSI#	Length	Liq Line	Suct Line	Price
38971	40820250B6	25'	1/4"	1/2"	180.78
53251	40820500B6	50'	1/4"	1/2"	330.70

**Series 410**

Prod ID#	CSI#	Length	Liq Line	Suct Line	Price
38973	41020250B6	25'	1/4"	5/8"	188.51
56271	41020500B6	50'	1/4"	5/8"	344.70

**Series 610**

Prod ID#	CSI#	Length	Liq Line	Suct Line	Price
49926	61020250B6	25'	3/8"	5/8"	204.92
53254	61020500B6	50'	3/8"	5/8"	370.11

**White Mini-Split Lineset**

- Tear Resistant
- UV Resistant
- Paintable
- 1/2" Insulated
- 1 foot markings for length cutting



**164' Rolls**

Prod ID#	CSI#	Length	Size	Price
70599	F100.GUS1416412	164'	1/4"	496.58
70600	F100.GUS3816412	164'	3/8"	702.47
71491	F100.GUS1216412	164'	1/2"	908.35
71634	F100.GUS5816412	164'	5/8"	1096.80

Equipment

Equipment

By The Foot - 1' pricing

Prod ID#	CSI#	Length	Size	Price
71653	PDM14PF	1'	1/4"	3.66
71654	PDM38PF	1'	3/8"	5.14
71655	PDM12PF	1'	1/2"	6.64
71656	PDM58PF	1'	5/8"	8.29



Flaretite Refrigeration Seals

- Rated -40 to 300 F Temperatures
- 45° SAE Flare



Prod ID#	CSI#	Description	Price
76871	CS104504CUSPP	1/4" Flaretite 10 Pack	67.41
76872	CS104506CUSPP	3/8" Flaretite 10 Pack	70.62
76873	CS104508CUSPP	1/2" Flaretite 10 Pack	77.04
76874	CS104510CUSPP	5/8" Flaretite 10 Pack	93.09



Condensate Removal Pumps

- For A/C units up to 5.5 tons
- Consists of pump unit and remote detection unit
- Pump dimensions: 2-3/8"H x 1-3/4"W x 2-5/8"L
- Float/Detection unit dimensions: 1-1/2"H x 1-1/2"W x 2-1/4"L
- 2-Year manufacturer's warranty



Prod ID#	CSI#	Max Flow Rate	Max Suction Head	Max Discharge Head	Voltage	Price
67249	SI-30-230V	5 gph	10'	33'	230	208.65

Mini Split Condensate Removal Pumps

- Quiet (<21dB(A) and Super Compact
- Pump fits easily in most linesets covers
- 115 Volt and 230 Volt available
- For systems up to 2.8 tons (34,000 btus)



Prod ID#	CSI#	Description	Price
78198	CP-M115	1.3-4 gph at 0-20 ft head, 6.6ft Shutoff Head, 115 Volt	185.18
78199	CP-M230	1.3-4 gph at 0-20 ft head, 6.6ft Shutoff Head, 230 Volt	185.18

Sterling Hts, MI - Livonia, MI - Lansing, MI - Grand Rapids, MI - Waterford, MI - Almont, MI - Saginaw, MI

**Mini Pumps & Lineset Hide**

**PVC Clear Tubing**

- For SI-30, SI-33, SI-10
- Connects pump to the discharge outlet

Prod ID#	CSI#	Description	Price
59088	ACC00105	16.4' For Mini Pumps 1/4" I.D.	27.29

**SpeediChannel - Diversitech Lineset Hide**

- Hides pipes and wiring in existing air conditioner installations
- No need for removing installed pipes



Prod ID#	CSI#	Description	Price
78200	230-D4	4 x 6.5" SpeediChannel Pipe	67.56
78201	230-CP4	4" Union Coupling	18.47
78202	230-EB4	4" 90 Deg Inside Elbow	40.75
78203	230-EIN4	4" 90 Deg Outside Elbow	40.75
78204	230-LFB4	4" 90 Deg Long Radius Bend	32.43
78205	230-FB454	4" 45 Deg Flat Bend	40.00
78206	230-FB4	4" 90 Deg Flat Bend	40.00
78207	230-FJ4	4" Flex Joint	29.81
78208	230-TJ4	4" Tee Joint	76.25
78209	230-DE4	4" Duct End	22.86
78210	230-DC4	4" Duct Cap	14.61
78211	230-WC4	4" Wall Penetration Cover	40.22
78212	230-WS2	2.5" Wall Sleeve	20.75
78213	230-WR4	4" Wall Escutcheon	17.55
78214	230-FR4	4" Flat Wall Escutcheon	15.71

**Floor Supports/Wall Brackets**

- Alternative to condensing pads
- UV-Resistant PVC floor
- Supports fitted with gasket for better adherence to ground

230-MB17W



230-B2L



Prod ID#	CSI#	Description	Price
56045	230-MB17W	17-3/4" x 3-15/16"	47.57
66862	230-B2L	HEF-T-BRACKET 21" (Type 2)	133.82

**Line Set Box**

- Rough-In Box for New Construction line set protection
- Easy to install and provides protection to refrigerant line sets and condensate drain lines
- Provides a clean terminatin point for new construction projects and reserves a bay.



Prod ID#	CSI#	Description	Price
78729	LSB10-W	Lineset Box - White	41.27

Equipment

**Equipment**

Equipment

**Airstage™ Multi-Zone VRF Mini-Splits**

**R-410A Airstage™ Compact Ceiling Cassette Multi-Zone VRF Ductless Mini-Split Heat Recovery Unit/Heat Pump**

- Inverter technology
- Compact design fits standard 23-5/8" x 23-5/8" ceiling tile
- 2-Stage turbo fan
- Quiet operation
- High lift drain pump
- Easy maintenance
- Long life filter
- Transparent drainage parts
- Cassette grille sold separately
- AHRI Certified
- cETLus Listed
- Limited warranty
  - 7-Year compressor and 5-year parts
  - Longer warranties available with registration, commissioning and Elite contractors status



Prod ID #	CSI #	Unit	Cap Cool BTUH	Cap Heat BTUH	Sound Pressure dBA	Electrical	Dimensions H x W x D	Net Weight	Price
77983	AUUA4TLAV1	Indoor	4,000	4,500	34/30/25	208/230-1-60	9-5/8" x 22-7/16" x 22-7/16"	32 lbs	1815.58
77373	AUUA7TLAV	Indoor	7,500	9,500	34/30/25	208/230-1-60	9-5/8" x 22-7/16" x 22-7/16"	33 lbs	2267.49
77374	AUUA9TLAV	Indoor	9,500	10,900	35/30/25	208/230-1-60	9-5/8" x 22-7/16" x 22-7/16"	33 lbs	2341.73
77376	AUUA12TLAV	Indoor	12,000	13,500	37/34/27	208/230-1-60	9-5/8" x 22-7/16" x 22-7/16"	33 lbs	2427.30
77377	AUUA14TLAV	Indoor	14,000	15,600	38/34/27	208/230-1-60	9-5/8" x 22-7/16" x 22-7/16"	33 lbs	2676.45
77378	AUUA18TLAV	Indoor	18,000	20,000	41/35/27	208/230-1-60	9-5/8" x 22-7/16" x 22-7/16"	37 lbs	3097.98
77379	AUUA24TLAV	Indoor	24,000	27,000	50/44/30	208/230-1-60	9-5/8" x 22-7/16" x 22-7/16"	37 lbs	3464.15

**R-410A Airstage™ Ceiling Cassette Multi-Zone VRF Ductless Mini-Split Heat Recovery Unit/Heat Pump**

- Inverter technology
- High efficiency turbo fan
- Quiet operation
- High lift drain pump
- Louvered design
- Wide airflow discharge
- Adjustable hanger position
- High ceiling mode
- AHRI Certified
- cETLus Listed
- Limited warranty
  - 7-Year compressor and 5-year parts
  - Longer warranties available with registration, commissioning and Elite contractors status



Prod ID #	CSI #	Unit	Cap Cool BTUH	Cap Heat BTUH	Sound Pressure dBA	Electrical	Dimensions H x W x D	Net Weight	Price
77381	AUUB18TLAV	Indoor	18,000	20,000	36/30/29	208/230-1-60	9-11/16" x 33-1/16" x 33-1/16"	49 lbs	3421.37
77382	AUUB24TLAV	Indoor	24,000	27,000	38/33/29	208/230-1-60	9-11/16" x 33-1/16" x 33-1/16"	49 lbs	3841.65
77383	AUUB30TLAV	Indoor	30,000	34,000	40/38/33	208/230-1-60	11-5/16" x 33-1/16" x 33-1/16"	60 lbs	4149.94
77384	AUUB36TLAV	Indoor	36,000	40,000	44/38/33	208/230-1-60	11-5/16" x 33-1/16" x 33-1/16"	60 lbs	4762.74

**Equipment**

Equipment

**R-410A Airstage™ Slim Compact Duct Multi-Zone VRF Ducted Mini-Split Heat Recovery Unit/Heat Pump**

- Inverter technology
- Slim design
- Can be mounted vertically or horizontally
- Condensate drain pump is standard (note: pump cannot be used when unit is in vertical position)
- Selectable external static pressure and air intake direction
- Optional auto louver grille kit available (sold separately)
- AHRI Certified
- cETLus Listed
- Limited warranty
  - 7-Year compressor and 5-year parts
  - Longer warranties available with registration, commissioning and Elite contractors status

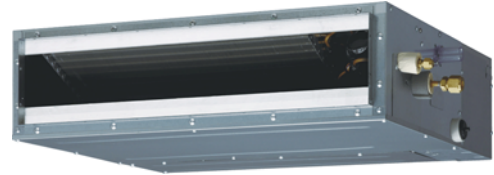

Prod ID #	CSI #	Unit	Cap Cool BTUH	Cap Heat BTUH	Sound Pressure dBA	Electrical	Dimensions H x W x D	Net Weight	Price
77386	ARUL7TLAV	Indoor	7,500	9,500	28/25/22	208/230-1-60	7-13/16" x 27-9/16" x 24-7/16"	37 lbs	2517.90
77387	ARUL9TLAV	Indoor	9,500	10,900	29/26/24	208/230-1-60	7-13/16" x 27-9/16" x 24-7/16"	37 lbs	2605.98
77388	ARUL12TLAV	Indoor	12,000	13,500	30/27/24	208/230-1-60	7-13/16" x 27-9/16" x 24-7/16"	40 lbs	2719.23
77389	ARUL14TLAV	Indoor	14,000	15,600	34/32/28	208/230-1-60	7-13/16" x 27-9/16" x 24-7/16"	40 lbs	3027.52
77390	ARUL18TLAV	Indoor	18,000	20,000	34/32/28	208/230-1-60	7-13/16" x 35-7/16" x 24-7/16"	49 lbs	3194.87

**R-410A Airstage™ Medium Static Pressure Duct Multi-Zone VRF Ducted Mini-Split Heat Recovery Unit/Heat Pump**

- Inverter technology
- Slim, compact design
- Easy installation and maintenance
- 2-Direction drain piping
- High efficiency DC fan motors
- AHRI Certified
- cETLus Listed
- Limited warranty
  - 7-Year compressor and 5-year parts
  - Longer warranties available with registration, commissioning and Elite contractors status



Prod ID #	CSI #	Unit	Cap Cool BTUH	Cap Heat BTUH	Sound Pressure dBA	Electrical	Dimensions H x W x D	Net Weight	Price
77391	ARUM24TLAV	Indoor	24,000	27,000	36/31/28	208/230-1-60	10-5/16" x 44-11/16" x 27-9/16"	86 lbs	3611.38
77392	ARUM30TLAV	Indoor	30,000	34,000	40/33/28	208/230-1-60	10-5/16" x 44-11/16" x 27-9/16"	86 lbs	4215.37
77393	ARUM36TLAV	Indoor	36,000	40,000	41/35/29	208/230-1-60	10-5/16" x 44-11/16" x 27-9/16"	86 lbs	4553.86

**Equipment**

Equipment

**R-410A Airstage™ High Static Pressure Duct Multi-Zone VRF Ducted Mini-Split Heat Recovery Unit/Heat Pump**

- Inverter technology
- Efficient casing design
- Capable of delivering hot or cold air at static pressures up to 1"wg (36-60MBTUH) or 1.2"wg (72-96MBTUH)
- Easy installation
- Compact and lightweight
- Non-metallic fan wheel and casing
- Quiet operation
- Duct layout flexibility
- AHRI Certified
- cETLus Listed
- Limited warranty
  - 7-Year compressor and 5-year parts
  - Longer warranties available with registration, commissioning and Elite contractors status



Prod ID #	CSI #	Unit	Cap Cool BTUH	Cap Heat BTUH	Sound Pressure dBA	Electrical	Dimensions H x W x D	Net Weight	Price
77394	ARUH36TLAV	Indoor	36,000	40,000	43/37/32	208/230-1-60	15-3/4" x 41-5/16" x 19-11/16"	97 lbs	4774.07
77395	ARUH48TLAV	Indoor	48,000	54,000	47/43/40	208/230-1-60	15-3/4" x 41-5/16" x 19-11/16"	101 lbs	5235.87
77396	ARUH60TLAV	Indoor	60,000	67,000	48/44/41	208/230-1-60	15-3/4" x 41-5/16" x 19-11/16"	101 lbs	5687.61

**R-410A Airstage™ Vertical Air Handler Multi-Zone VRF Ductless Mini-Split Heat Recovery Unit/Heat Pump**

- Inverter technology
- Optimized to fit in narrow spaces
- Front access panel
- Small footprint
- Broad static pressure range up to 0.8"wg
- Durable, powder-coated, thick steel cabinet
- 1" Acoustic and thermal insulation
- Equipped with standard MERV 3 filter
- Easily retrofitted into existing installations
- Front panel provides easy access for setup and maintenance
- AHRI Certified
- cETLus Listed
- Limited warranty
  - 7-Year compressor and 5-year parts
  - Longer warranties available with registration, commissioning and Elite contractors status



Prod ID #	CSI #	Unit	Cap Cool BTUH	Cap Heat BTUH	Sound Pressure dBA	Electrical	Dimensions H x W x D	Net Weight	Price
77398	ARUV12TLAV	Indoor	12,000	13,500	41/39/37	208/230-1-60	51" x 17-11/16" x 23-13/16"	139 lbs	3674.29
77399	ARUV18TLAV	Indoor	18,000	20,000	43/40/39	208/230-1-60	51" x 17-11/16" x 23-13/16"	148 lbs	3724.63
77400	ARUV24TLAV	Indoor	24,000	27,000	45/43/39	208/230-1-60	51" x 17-11/16" x 23-13/16"	151 lbs	3800.13
77401	ARUV30TLAV	Indoor	30,000	34,000	45/43/40	208/230-1-60	51" x 22-3/16" x 23-13/16"	174 lbs	3951.12
77402	ARUV36TLAV	Indoor	36,000	40,000	48/46/40	208/230-1-60	51" x 22-3/16" x 23-13/16"	179 lbs	4202.79
77403	ARUV48TLAV	Indoor	48,000	54,000	48/46/41	208/230-1-60	57-1/2" x 25-1/8" x 23-13/16"	212 lbs	4441.87
77404	ARUV60TLAV	Indoor	60,000	67,000	53/50/45	208/230-1-60	57-1/2" x 25-1/8" x 23-13/16"	223 lbs	5083.61

**Sterling Hts, MI - Livonia, MI - Lansing, MI - Grand Rapids, MI - Waterford, MI - Almont, MI - Saginaw, MI**



**Equipment**

Equipment

**R-410A Airstage™ Universal Floor/Ceiling-Mount Multi-Zone VRF Ductless Mini-Split Heat Recovery Unit/Heat Pump**

- Inverter technology
- Slim and lightweight design allows unit to be suspended from the ceiling or installed on the floor
- Auto-closing louvers with 4-way swing
- High power DC fan motor
- AHRI Certified
- cETLus Listed
- Limited warranty
  - 7-Year compressor and 5-year parts
  - Longer warranties available with registration, commissioning and Elite contractors status



Prod ID #	CSI #	Unit	Cap Cool BTUH	Cap Heat BTUH	Sound Pressure dBA	Electrical	Dimensions H x W x D	Net Weight	Price
77405	ABUA12TLAV	Indoor	12,000	13,500	36/32/28	208/230-1-60	7-13/16" x 39" x 25-13/16"	55 lbs	2505.32
77406	ABUA14TLAV	Indoor	14,000	15,600	40/36/34	208/230-1-60	7-13/16" x 39" x 25-13/16"	57 lbs	3100.50
77407	ABUA18TLAV	Indoor	18,000	20,000	46/39/35	208/230-1-60	7-13/16" x 39" x 25-13/16"	57 lbs	3348.39
77408	ABUA24TLAV	Indoor	24,000	27,000	47/42/37	208/230-1-60	7-13/16" x 39" x 25-13/16"	60 lbs	3389.91

**R-410A Airstage™ Ceiling-Mount Multi-Zone VRF Ductless Mini-Split Heat Recovery Unit/Heat Pump**

- Inverter technology
- Open, concealed or wall-mount (with field-supplied wall bracket kit) installation
- 4-Way louver swing
- Quiet, powerful airflow
- Slim and compact design
- Optional drain lift-up mechanism allows flexible installation
- High power DC fan motor
- High efficiency, long life air filter
- Fresh air intake
- AHRI Certified
- cETLus Listed
- Limited warranty
  - 7-Year compressor and 5-year parts
  - Longer warranties available with registration, commissioning and Elite contractors status



Prod ID #	CSI #	Unit	Cap Cool BTUH	Cap Heat BTUH	Sound Pressure dBA	Electrical	Dimensions H x W x D	Net Weight	Price
77409	ABUA30TLAV	Indoor	30,000	34,000	42/38/33	208/230-1-60	9-7/16" x 65-3/8" x 27-9/16"	101 lbs	3743.50
77410	ABUA36TLAV	Indoor	36,000	40,000	45/38/34	208/230-1-60	9-7/16" x 65-3/8" x 27-9/16"	106 lbs	4269.48

**Equipment**

Equipment

**R-410A Airstage™ Compact Wall-Mount Multi-Zone VRF Ductless Mini-Split Heat Recovery Unit/Heat Pump**

- Inverter technology
- Apple-catechin filter
- Ion deodorization filter can be used for approximately 3 years if washed under water when dirty
- Powerful, compact unit features a large, high pressure fan with a Lambda type heat exchanger
- High power DC fan motor
- Wide rotation range
- Auto swing louver
- Removable front panel for easy access and maintenance
- AHRI Certified
- cETLus Listed
- Limited warranty
  - 7-Year compressor and 5-year parts
  - Longer warranties available with registration, commissioning and Elite contractors status



Prod ID #	CSI #	Unit	Cap Cool BTUH	Cap Heat BTUH	Sound Pressure dBA	Electrical	Dimensions H x W x D	Net Weight	Price
77982	ASUA4TLAV1	Indoor	4,000	4,400	31/28/24	208/230-1-60	10-5/16" x 32-5/8" x 8-1/8"	17 lbs	1620.84
77411	ASUA7TLAV	Indoor	7,500	9,500	35/33/31	208/230-1-60	10-13/16" x 31-1/8" x 8-7/16"	20 lbs	1799.40
77412	ASUA9TLAV	Indoor	9,500	10,900	36/33/31	208/230-1-60	10-13/16" x 31-1/8" x 8-7/16"	20 lbs	2009.54
77413	ASUA12TLAV	Indoor	12,000	13,500	39/35/31	208/230-1-60	10-13/16" x 31-1/8" x 8-7/16"	20 lbs	2184.44
77415	ASUA14TLAV	Indoor	14,000	15,600	44/37/32	208/230-1-60	10-13/16" x 31-1/8" x 8-7/16"	20 lbs	2288.88

**R-410A Airstage™ Wall-Mount Multi-Zone VRF Ductless Mini-Split Heat Recovery Unit/Heat Pump**

- Inverter technology
- Apple-catechin filter
- Ion deodorization filter
- Compact and slim design
- Vertical or horizontal airflow
- Variable-speed DC fan motors
- Easy maintenance with improved drain pan design
- AHRI Certified
- cETLus Listed
- Limited warranty
  - 7-Year compressor and 5-year parts
  - Longer warranties available with registration, commissioning and Elite contractors status



Prod ID #	CSI #	Unit	Cap Cool BTUH	Cap Heat BTUH	Sound Pressure dBA	Electrical	Dimensions H x W x D	Net Weight	Price
77416	ASUB18TLAV	Indoor	18,000	20,000	41/39/35	208/230-1-60	12-5/8" x 39-5/16" x 9"	33 lbs	2501.54
77417	ASUB24TLAV	Indoor	24,000	27,000	48/43/35	208/230-1-60	12-5/8" x 39-5/16" x 9"	33 lbs	2657.57
77737	ASUB30TLAV1	Indoor	30,000	34,000	39/45/53	208/230-1-60	13-3/8" x 45-1/4" x 11"	40 lbs	2870.23
77736	ASUB36TLAV1	Indoor	34,000	38,000	39/45/53	208/230-1-60	13-3/8" x 45-1/4" x 11"	40 lbs	3099.24

**Equipment**

Equipment

**R-410A Airstage™ Outdoor Air Unit Multi-Zone VRF Ducted Mini-Split Heat Recovery Unit/Heat Pump**

- Supplies outdoor air to improve IAQ for ventilation
- Can be connected to the VRF outdoor condenser as an indoor unit conditioning outdoor air to comfort levels
- Flexible duct design
- DC Motor
- Lightweight, compact design installs easily even in a narrow space
- AHRI Certified
- cETLus Listed
- Limited warranty
  - 7-Year compressor and 5-year parts
  - Longer warranties available with registration, commissioning and Elite contractors status



Prod ID #	CSI #	Unit	Cap Cool BTUH	Cap Heat BTUH	Sound Pressure dBA	Electrical	Dimensions H x W x D	Net Weight	Price
77418	AAUA48TLAV	Indoor	48,000	30,000	42	208/230-1-60	16-3/4" x 53-13/16" x 22-1/2"	106 lbs	4801.75

**R-410A Airstage™ J-IIS Series Outdoor Multi-Zone VRF Ductless Mini-Split Heat Pump**

- Inverter technology
- Connectable indoor unit capacity up to 130%
- Compact size allows unit to be installed under windows and in tight spaces
- Easy installation
- DC Fan motor, twin rotary compressor and inverter control
- Large propeller fan
- 3-Row large heat exchanger
- Smooth airflow grille
- AHRI Certified
- cETLus Listed
- Limited warranty
  - 7-Year compressor and 5-year parts
  - Longer warranties available with registration, commissioning and Elite contractors status



Prod ID #	CSI #	Unit	Cap Cool BTUH	Cap Heat BTUH	EER (Ductless/ Ducted)	Electrical	Dimensions H x W x D	Net Weight	Price
77368	AOU36RLAVS	Outdoor	36,000	42,000	11.8/11.2	208/230-1-60	39-5/16" x 38-3/16" x 14-9/16"	190 lbs	5500.12
77369	AOU48RLAVS	Outdoor	48,000	54,000	9.6/9.1	208/230-1-60	39-5/16" x 38-3/16" x 14-9/16"	190 lbs	6427.50

Equipment

Equipment

**R-410A Airstage™ J-II Series Outdoor Multi-Zone VRF Ductless Mini-Split Heat Pump**

- Inverter technology
- Connectable indoor unit capacity up to 130%
- Compact size allows unit to be installed under windows and in tight spaces
- Easy installation
- DC Fan motor, twin rotary compressor and inverter control
- Large propeller fan
- 3-Row large heat exchanger
- Subcool heat exchanger
- AHRI Certified
- cETLus Listed
- Limited warranty
  - 7-Year compressor and 5-year parts
  - Longer warranties available with registration, commissioning and Elite contractors status



Prod ID #	CSI #	Unit	Cap Cool BTUH	Cap Heat BTUH	EER (Ductless/Ducted)	Electrical	Dimensions H x W x D	Net Weight	Price
77370	AOU36RLAVM	Outdoor	36,000	42,000	13.3/12.5	208/230-1-60	52-1/2" x 38-3/16" x 14-9/16"	260 lbs	6706.85
77371	AOU48RLAVM	Outdoor	48,000	54,000	12.5/11.8	208/230-1-60	52-1/2" x 38-3/16" x 14-9/16"	260 lbs	7562.50
77372	AOU60RLAVM	Outdoor	60,000	66,000	10.8/10.4	208/230-1-60	52-1/2" x 38-3/16" x 14-9/16"	269 lbs	9456.27

**Fujitsu Airstage Parts & Accessories**

**Communication Cable**

Prod ID #	CSI #	Description	Price
77738	K00250LW	Level 4 NEMA, 22 AWG, 250' Spool LonWorks® Shielded Communication Cable for All Airstage™ VRF Models	301.53
77739	K00500LW	Level 4 NEMA, 22 AWG, 500' Spool LonWorks® Shielded Communication Cable for All Airstage™ VRF Models	495.37

**Fresh Air Intake**

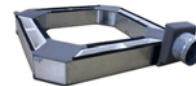

Prod ID #	CSI #	Description	Price
63983	UTZ-VXAA	Fresh Air Intake Kit for Compact Cassettes	447.06
77741	UTZ-VXGA	Fresh Air Intake Kit for Cassettes	702.13

**Grille**

Prod ID #	CSI #	Description	Price
77380	UTG-CCGV	VRF Compact Ceiling Cassette Grille for Airstage™ V-II	304.51
77385	UTG-LCGV	VRF Large Ceiling Cassette Grille for Airstage™	324.65

**Header**

Prod ID #	CSI #	Description	Price
77742	UTR-H0906L	VRF Less than 96.5MBTUH 3-6 Branches 2-Pipe Header	324.45

**Equipment**

Equipment

**Network Converter**

- Required when connecting single split units to the VRF communication network system
- Controls a maximum of (16) single indoor units

Prod ID #	CSI #	Description	Price
77758	UTY-VTGX	VRF Network Converter	356.73

**UTY-DCGY Central Remote Control**

- Individual control and monitoring of up to (100) indoor units, (16) groups
- Automatic clock adjustment
- Weekly timer
- Error history
- Control panel can be built into the wall or flush-mounted
- 5" TFT Color screen
- User-friendly view and easy operation
- External input/output contact
- Detachable power supply unit
- English, Chinese, French, German, Spanish, Russian and Polish language options

Prod ID #	CSI #	Description	Price
77755	UTY-DCGY	VRF Central Remote Control	2972.03

**UTY-DTGY Touch Panel Remote Control**

- Controls up to (400) indoor units
- 7-1/2" TFT LCD Color touchscreen with non-glare coating to minimize fingerprint marking
- Easy-to-understand user interface
- Data can be transferred to USB for further analysis
- Mounts flush to wall with no additional components required
- Easy-to-remove front cover
- Up-to-date status display
- Automatic clock adjustment
- Schedule timer function
- Emergency stop function through external input control
- Temperature upper and lower limit setting
- English, Chinese, French, German, Spanish, Russian and Polish language options
- Suffix Z1 = internet/LAN remote monitoring and control

Prod ID #	CSI #	Description	Price
77756	UTY-DTGY	VRF Touch Panel Remote Control	4655.78
77757	UTY-DTGYZ1	VRF Touch Panel Remote Control w/Internet/LAN Control	7235.34

**UTY-LNHU Wireless Remote Control**

- Controls up to (16) indoor units
- Selectable timer programs: on/off/program/sleep
- Code selector switch prevents indoor unit mix-up (sets up to 4 codes)
- Wide and precise transmitting range
- Requires infrared receiver for use with cassette and ducted indoor units (sold separately)

Prod ID #	CSI #	Description	Price
77750	UTY-LNHU	VRF Wireless Remote Control	220.85

**Sterling Hts, MI - Livonia, MI - Lansing, MI - Grand Rapids, MI - Waterford, MI - Almont, MI - Saginaw, MI**

**Equipment**

Equipment

**UTY-RNKU 3-Wire Remote Control**

- Built-in weekly/daily timer
- Controls up to (16) indoor units
- Up to (2) wired remote controls can be connected to a single indoor unit



Prod ID #	CSI #	Description	Price
77752	UTY-RNKU	VRF Wired Remote Control	424.68

**UTY-RNRUZ2 2-Wire Touch Remote Control**

- Built-in weekly/daily timer and temperature sensor
- Controls up to (16) indoor units
- Large, high definition, backlit STN-LCD touchscreen
- Room temperature display
- Automatic off timer
- Optimum start function
- Set temperature upper and lower limit setting
- Away mode
- Daylight savings adjustment option for regions that use it
- Child lock
- Indoor unit name registration for easy identification
- Maximum of 32 error incidents can be saved

Prod ID #	CSI #	Description	Price
77753	UTY-RNRUZ2	VRF Wired Remote Control Touch Pad	570.78

**UTY-RSKU Simple Wired Remote Control**

- Provides access to basic functions
- Controls up to (16) indoor units

Prod ID #	CSI #	Description	Price
77754	UTY-RSKU	VRF Simple Wired Remote Control	336.36

**Sensor**

Prod ID #	CSI #	Description	Price
77760	UTB-YWC	VRF Infrared Receiver for All Duct Types	220.85
77759	UTY-LRHYB1	VRF Infrared Receiver for Cassettes	220.85
77761	UTY-XSZX	VRF Remote Sensor for All Duct Types	202.70

**Separation Tube**

Prod ID #	CSI #	Description	Price
77743	UTP-AX090A	VRF Less than 96.5MBTUH 2-Pipe Separation Tube	283.12

**Equipment**

Equipment

**Service Tool Software**

- Monitors and controls a maximum of (400) indoor and (100) outdoor units
- Operation status can be checked and analyzed for small abnormalities
- Secure remote monitoring and control
- Offsite access to data storage on PC

Prod ID #	CSI #	Description	Price
77749	UTY-ASGXZ1	VRF Service Tool Software	1860.31

**Wire Kit**



Prod ID #	CSI #	Description	Price
77746	UTY-XWZXZA	External Connect Wire Kit for Touch Panel & Central Remote Controls	56.50
77747	UTY-XWZXZD	External Connect Wire Kit for Indoor Unit	56.50
77744	UTY-XWZXZ7	External Connect Wire Kit for Indoor Unit & Central Remote Control	56.50
77745	UTY-XWZXZ8	External Connect Wire Kit for Central Remote Control	56.50

**Parts & Accessories**

Prod ID #	CSI #	Description	Price
77748	VRFCOMMJ	Commissioning Fee per Day for Airstage™ J-Series VRF	1887.48

**Order on-line when it's convenient  
for you-[www.CalverleySupply.com](http://www.CalverleySupply.com)**

**Equipment**

Equipment

**ESP-J Series DX Horizontal Fan Coil Unit  
ECM Motor**



Prod ID#	CSI#	MFG #	Capacity Nom Tons	Electric	Ref	Connections		-Dimensions-			Ship Weight (Lbs)	Price
						Suc	Liq	H	W	L		
73851	ESP2430JH	ESP-2430JH	2, 2-1/2	1-60-208/230	R-401A	7/8"	3/8"	14-1/8"	24-1/8"	29-3/8"	105	4227.68
73853	ESP3624JH	ESP-3642JH	3, 3-1/2	1-60-208/230	R-401A	7/8"	3/8"	14-1/8"	33-1/8"	29-3/8"	123	4488.50
73852	ESP4860JH	ESP-4860JH	4, 5	1-60-208/230	R-401A	7/8"	3/8"	14-1/8"	43-1/8"	29-3/8"	144	4927.31

**Components & Accessories Required Per System**

Prod ID#	CSI#	MFG #	Description	-----Fan Coil Unit Model-----			Price
				ESP-2430D	ESP-3642DE	SP-4860D	
42183	BM-6808-10	SPC-4	Return Air Duct -10'	1 Each			303.51
42182	BM-6809-10	SPC-5	Return Air Duct -10'		1 Each		426.87
42181	BM-6839-10	SPC-6	Return Air Duct -10'			1 Each	569.81
42186	BM-9149	SPC-1D	Return Air Box	1 Each			352.46
42185	AC-RBF-3	AC-RBF-3	Return Air Box		1 Each		454.41
42184	BM-9169	SPC-3D	Return Air Box			1 Each	561.97

**Ductboard Accessories**

Prod ID#	CSI#	Description	Price
58204	SPS-PD-6	BM-3001 4' DUCTBOARD PLENUM	106.52
58205	SPS-90-4	BM-3004 DUCTBOARD PLENUM 90 DEG ELBOW	159.76
58455	SPS-T-4	BM-3002 DUCTBOARD PLENUM TEE10 X 10	153.50
58206	SPS-EC-10	BM-3003 DUCTBOARD PLENUM END CAP	47.48

**Installation Kits**

Prod ID#	CSI#	Description	Sound ATT Tubes	Kwik Conn	Balance Orifice	Term Plates	Winter Shutoff	Price
50416	AC-IKLT-2	2 Outlet Installation Kit	2	4	3	2	2	231.06
50414	AC-IKLT-5	5 Outlet Installation Kit	5	10	6	5	5	581.56

**Supply Tubing**

Prod ID#	CSI#	Description	Price
68116	AC-ST8-75	75' R-8 Supply Tubing	752.50
65262	AC-ST6-100	100' R6 Supply Tubing	722.54

**Take-Off Kits**

Prod ID#	CSI#	Description	Price
53314	AC-TKFS-2	2-Pc Take Off Kit/Ductboard Including Gaskets & Clips	53.26
53315	AC-TKFS-5	5 Pc Take Off Kit/Ductboard Including Gaskets & Clips	117.49
50417	AC-TKMR-2	2-Pc Take Off Kit Rnd Metal Including Gaskets & Clips	68.93
50415	AC-TKMR-5	5 Pc Take Off Kit Rnd Metal Including Gaskets & Clips	158.61



**Equipment**

**Components & Accessories**

Prod ID#	CSI#	MFG #	Description	Price
42190	BM-6818	SPC-38-10	Kwik Connects	23.17
42191	BM-6898	SPC-72	Pliers(Pro Clip Spreader)	113.18
73926	45AC-PAJSQ		10 x 10 Plenum Adapter Plate to ductboard J Series	88.77
73927	45AC-PAJ		9" Spiral Plenum Takeoff	102.08

**Parts**

Prod ID#	CSI#	Description	Price
42196	BM-6815	Plenum Takeoff Fastener Clips	5.08
43842	BM-6819	Winter Shut-Off (EA)	19.90
45228	BM-6845	Replacement Terminator Plate	39.16

LOEM-4



TYPICAL LIST OF EQUIPMENT AND COMPONENTS ~ For Reference Only  
Refer to SpacePak Trade Price Book for other components and parts.

**9" ROUND SHEET METAL PLENUM DUCT**

MODEL NUMBER	DESCRIPTION	COOLING SYSTEM ONLY					
		2 Tons	2 1/2 Tons	3 Tons	3 1/2 Tons	4 Tons	5 Tons
ESP-2430	2 & 2 1/2 ton Fan Coil Unit	1 unit	1 unit				
ESP-3642	3 & 3 1/2 ton Fan Coil Unit			1 unit	1 unit		
ESP-4860	4 & 5 ton Fan Coil Unit					1 unit	1 unit
AC-BASE-2	Secondary Drain Pan (2 & 2 1/2 ton units)	1 pc	1 pc				
AC-BASE-3	Secondary Drain Pan (3 & 3 1/2 ton units)			1 pc	1 pc		
AC-BASE-5	Secondary Drain Pan (4 & 5 ton units)					1 pc	1 pc
AC-IKLT-2	Installation Kit for 2 Terminators includes: 2 Sound Attenuating Tubes (w/ assembled Kwik Connects), 4 Kwik Connects, 2 Terminator Plates (w/ clips & screws), 3 Balancing Orifices (1 each: 15%, 35%, 50% reduction), 2 Winter Supply Air Shut-offs	2 Kits	4 Kits	3 Kits	—	4 Kits	—
AND		AND	AND	AND		AND	
AC-TKMR-2	Plenum Take-off Kit for 2 Terminators includes: 2 Plenum Take-offs (w/ clips & gaskets)	2 Kits	4 Kits	3 Kits	—	4 Kits	—
AC-IKLT-5	Installation Kit for 5 Terminators includes: 5 Sound Attenuating Tubes (w/ assembled Kwik Connects), 10 Kwik Connects, 5 Terminator Plates (w/ clips & screws), 6 Balancing Orifices (2 each: 15%, 35%, 50% reduction), 5 Winter Supply Air Shut-offs	2 Kits	2 Kits	3 Kits	5 Kits	4 Kits	7 Kits
AND		AND	AND	AND	AND	AND	AND
AC-TKMR-5	Plenum Take-off Kit for 5 Terminators includes: 5 Plenum Take-offs (w/ clips & gaskets)	2 Kits	2 Kits	3 Kits	5 Kits	4 Kits	7 Kits
<b>These Items to be Field Supplied by Others</b>	9" Plenum Duct	25 ft.	25 ft.	35 ft.	35 ft.	45 ft.	50 ft.
	9" Plenum Tee	1 pc	1 pc	1 pc	1 pc	1 pc	1 pc
	9" 90° Rigid Elbow	1 pc	1 pc	1 pc	1 pc	1 pc	1 pc
	9" Plenum End Cap	2 pcs	2 pcs	2 pcs	2 pcs	2 pcs	2 pcs
AC-PAJ	9" Round Plenum Adaptor	1 pc	1 pc	1 pc	1 pc	1 pc	1 pc
AC-ST6-100	Supply Tubing (100ft. per box) OR AC-ST8-75 = R8 Available See Notes Below *	2 boxes	3 boxes	3 boxes	3 boxes	4 boxes	5 boxes
SPC-1D	Return Air Box w/ washable filter (2 & 2 1/2 ton)	Select (1): standard or air cleaner model					
AC-RBC-2	PurePak Air Cleaner (2 & 2 1/2 ton)						
AC-RBF-3	Return Air Box w/ washable filter (3 & 3 1/2 ton)	Select (1): standard or air cleaner model					
AC-RBC-3	PurePak Air Cleaner (3 & 3 1/2 ton)						
SPC-3D	Return Air Box w/ washable filter (4 & 5 ton)						
AC-RBC-5	PurePak Air Cleaner (4 & 5 ton)	Select (1): standard or air cleaner model					
SPC-4	Return Air Duct - 10 foot long (2 & 2 1/2 ton)	1 pc	1 pc				
SPC-5	Return Air Duct - 10 foot long (3 & 3 1/2 ton)			1 pc	1 pc		
SPC-6	Return Air Duct - 10 foot long (4 & 5 ton)					1 pc	1 pc
To Be Determined	Condensing Unit: to be selected by installing contractor	2 Ton	2 1/2 Ton	3 Ton	3 1/2 Ton	4 Ton	5 Ton

\* Number of boxes above calculated with standard supply tubing only (100ft. per box). Model # AC-ST8-75 R8 Supply Tubing (75ft. per box); adjust # of boxes as required.

260 NORTH ELM ST. WESTFIELD, MA 01085 (413) 564-5530 FAX (413) 564-5815  
7555 TRANMERE DRIVE, MISSISSAUGA, ONT. L5S 1L4 CANADA (905) 670-5888 FAX (905) 670-5782

11/16

Equipment

Equipment

Equipment

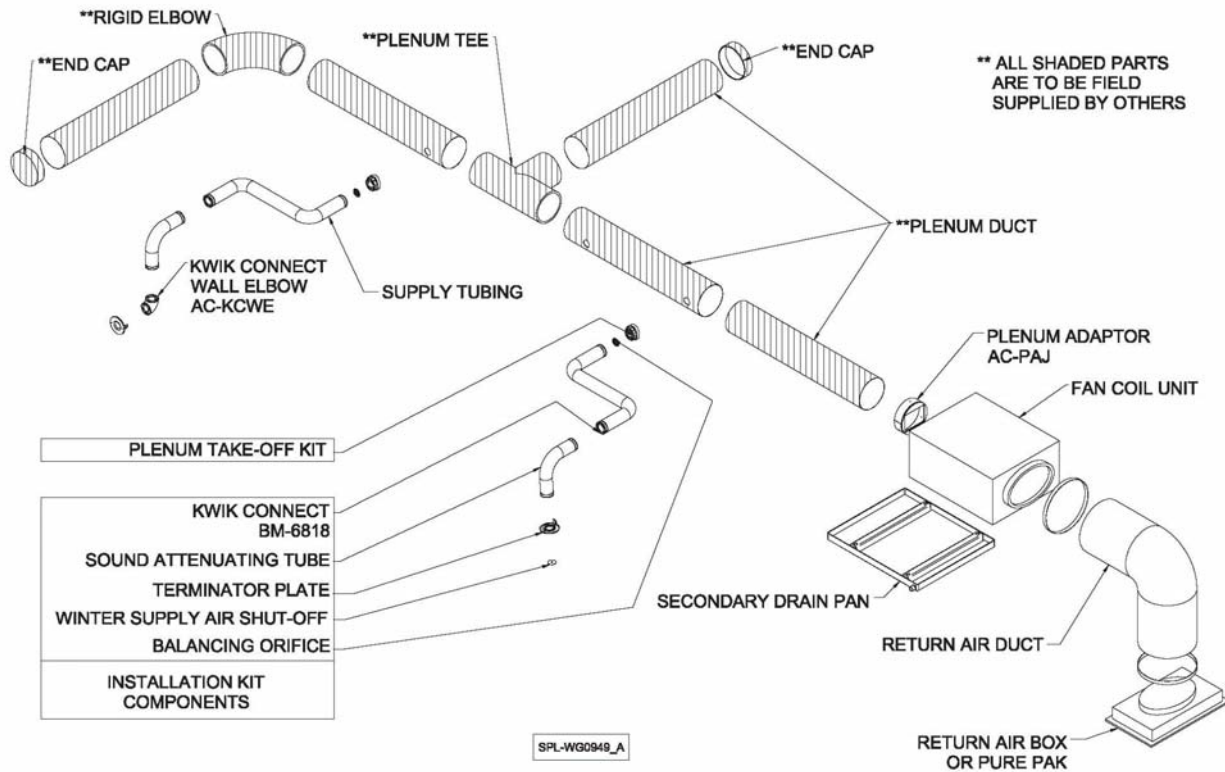

SPACEPAK  
DESCRIPTION: PLENUM TAKE OFF ROUND SHEET METAL DUCT  
DWG NO.: SPL-WG0949 REV.: A

If you don't find everything you need in this catalog, please let us know. We have not listed everything and can special order from most of our manufacturers.

**Equipment**

Equipment

LOES-4



TYPICAL LIST OF EQUIPMENT AND COMPONENTS ~ For Reference Only  
Refer to SpacePak Trade Price Book for other components and parts.

**10" x 10" (O.D.) SQUARE FIBERBOARD PLENUM DUCT**

MODEL NUMBER	DESCRIPTION	Quantities based upon 7 take-offs per ton and supply air runs of 15ft. each (12ft. of supply tubing plus the 3ft. sound attenuating tube)	COOLING SYSTEM ONLY						
			2 Tons	2 1/2 Tons	3 Tons	3 1/2 Tons	4 Tons	5 Tons	
ESP-2430	2 & 2 1/2 ton Fan Coil Unit		1 unit	1 unit					
ESP-3642	3 & 3 1/2 ton Fan Coil Unit				1 unit	1 unit			
ESP-4860	4 & 5 ton Fan Coil Unit						1 unit	1 unit	
AC-BASE-2	Secondary Drain Pan (2 & 2 1/2 ton units)		1 pc	1 pc					
AC-BASE-3	Secondary Drain Pan (3 & 3 1/2 ton units)				1 pc	1 pc			
AC-BASE-5	Secondary Drain Pan (4 & 5 ton units)						1 pc	1 pc	
AC-IKLT-2	Installation Kit for 2 Terminators includes: 2 Sound Attenuating Tubes (w/ assembled Kwik Connects), 4 Kwik Connects, 2 Terminator Plates (w/ clips & screws), 3 Balancing Orifices (1 each: 15%, 35%, 50% reduction), 2 Winter Supply Air Shut-offs		2 Kits	4 Kits	3 Kits	—	4 Kits	—	
AND			AND	AND	AND		AND		
AC-TKFS-2	Plenum Take-off Kit for 2 Terminators includes: 2 Plenum Take-offs (w/ clips & gaskets)		2 Kits	4 Kits	3 Kits	—	4 Kits	—	
AC-IKLT-5	Installation Kit for 5 Terminators includes: 5 Sound Attenuating Tubes (w/ assembled Kwik Connects), 10 Kwik Connects, 5 Terminator Plates (w/ clips & screws), 6 Balancing Orifices (2 each: 15%, 35%, 50% reduction), 5 Winter Supply Air Shut-offs		2 Kits	2 Kits	3 Kits	5 Kits	4 Kits	7 Kits	
AND			AND	AND	AND	AND	AND	AND	
AC-TKFS-5	Plenum Take-off Kit for 5 Terminators includes: 5 Plenum Take-offs (w/ clips & gaskets)		2 Kits	2 Kits	3 Kits	5 Kits	4 Kits	7 Kits	
SPS-PD-6	Plenum Duct - 4 foot lengths		6 pcs	6 pcs	8 pcs	8 pcs	12 pcs	12 pcs	
SPS-T-4	Plenum Tee		1 pc	1 pc	1 pc	1 pc	1 pc	1 pc	
SPS-90-4	90° Plenum Elbow		1 pc	1 pc	1 pc	1 pc	1 pc	1 pc	
SPS-EC-10	Plenum End Cap		2 pcs	2 pcs	2 pcs	2 pcs	2 pcs	2 pcs	
SPS-PA	Plenum Adaptor		1 pc	1 pc	1 pc	1 pc	1 pc	1 pc	
AC-ST6-100	Supply Tubing (100ft. per box) OR AC-ST8-75 = R8 Available See Notes Below *		2 boxes	3 boxes	3 boxes	3 boxes	4 boxes	5 boxes	
SPC-1D	Return Air Box w/ washable filter (2 & 2 1/2 ton)		Select (1): standard or air cleaner model						
AC-RBC-2	PurePak Air Cleaner (2 & 2 1/2 ton)		Select (1): standard or air cleaner model						
AC-RBF-3	Return Air Box w/ washable filter (3 & 3 1/2 ton)		Select (1): standard or air cleaner model						
AC-RBC-3	PurePak Air Cleaner (3 & 3 1/2 ton)		Select (1): standard or air cleaner model						
SPC-3D	Return Air Box w/ washable filter (4 & 5 ton)		Select (1): standard or air cleaner model						
AC-RBC-5	PurePak Air Cleaner (4 & 5 ton)		Select (1): standard or air cleaner model						
SPC-4	Return Air Duct - 10 foot long (2 & 2 1/2 ton)		1 pc	1 pc					
SPC-5	Return Air Duct - 10 foot long (3 & 3 1/2 ton)				1 pc	1 pc			
SPC-6	Return Air Duct - 10 foot long (4 & 5 ton)						1 pc	1 pc	
To Be Determined	Condensing Unit: to be selected by installing contractor		2 Ton	2 1/2 Ton	3 Ton	3 1/2 Ton	4 Ton	5 Ton	

\* Number of boxes above calculated with standard supply tubing only (100ft. per box). Model # AC-ST8-75 R8 Supply Tubing (75ft. per box); adjust # of boxes as required.

11/16 260 NORTH ELM ST. WESTFIELD, MA 01085 (413) 564-5530 FAX (413) 564-5815  
7555 TRANMERE DRIVE, MISSISSAUGA, ONT. L5S 1L4 CANADA (905) 670-5888 FAX (905) 670-5782

**WE ARE A FULL LINE WHOLESALER.**

**For products not shown in this catalog,  
contact us for complete information.**

Equipment

Equipment

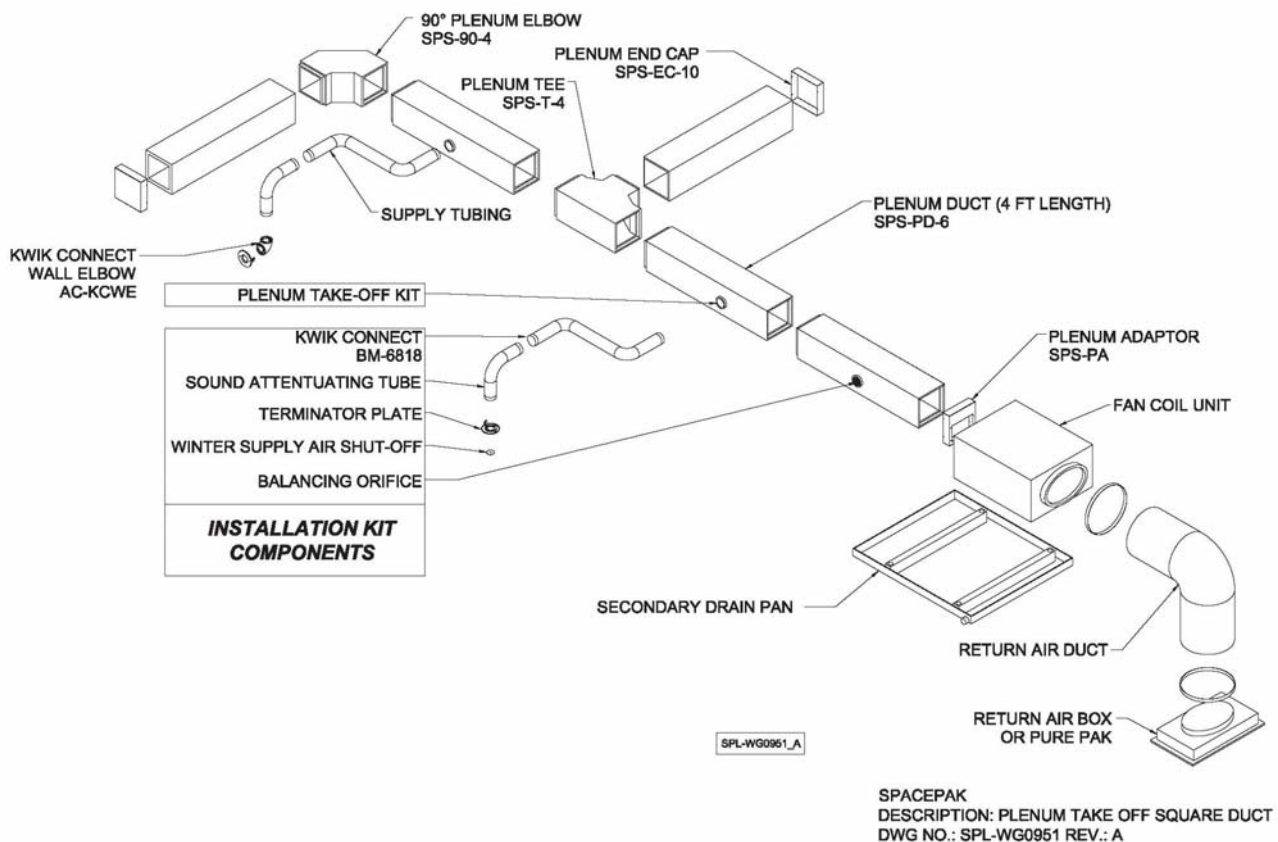

*We Feature The Brand Name Products  
You Are Looking For*

**Equipment**

**Hot Dawg® Gas-Fired Unit Heaters**

**Certified for Residential, Commercial & Industrial Use**

**Power-Exhausted Gas-Fired Unit Heater**

- Hush puppy quiet operator
- Uses natural or propane gas (L.P. Kit Available)
- Certified for residential, commercial and industrial use
- Lightweight, easily installs 1" from ceiling with only 2 angle brackets (included on sizes 30-75, accessory for 100, 125)
- Install quickly and easily with field wiring connections and knockouts for quick access to gas and electricity
- Low-profile design and neutral color to blend in with decor
- Standard power exhaust simplifies side-wall or roof venting with small diameter vent pipe
- Right or left hand controls available on all 30-75 units
- Gas, electrical and flue connections can be changed by simply flipping the Hot Dawg over
- Permanently-lubricated motor for trouble-free dependability
- **Full 10-year warranty on heat exchanger- 2-year on all other Parts**



Equipment

Part #	Mfg #	Type Gas	BTUH Input	BTUH Output	Air Vent Dia	Entering Air CFM	Air Temp Rise	Max Mount Height	Heat Throw	Ship Wt	Price
68323	HD30	NG	30,000	24,000	3"	505	44°F	10'	25'	55 lbs	1199.69
68324	HD45	NG	45,000	36,000	3"	720	46°F	10'	27'	60 lbs	1245.27
68325	HD60	NG	60,000	48,000	3"	990	45°F	12'	36'	80 lbs	1424.96
68326	HD75	NG	75,000	60,000	4"	1,160	48°F	14'	38'	85 lbs	1467.99
68327	HD100	NG	100,000	80,000	4"	1,490	50°F	12'	42'	125 lbs	1702.11
68328	HD125	NG	125,000	100,000	4"	1,980	47°F	16'	56'	125 lbs	1838.77

**Hot Dawg® L.P. Kits**

Part #	Mfg #	Description	Price
68381	53079	30,000 - 75,000 BTU LP Gas Conversion Kit For HD30-75, HDS30-75	120.18
68379	53080	100,000 BTU LP Gas Conversion Kit For HD100, HDS100	130.97
68380	53081	125,000 BTU LP Gas Conversion Kit For HD125, HDS125	130.97

**Quick Sling Brackets for Hot Dawg Unit Heaters**

- These are for use with HD30 thru HD125 only

QSWI1000



QSWI3000



Part #	Mfg #	Description	Price
69621	QSWI1000	Swivel Unit Htr U Bracket - HD30 thru HD125	233.08
69622	QSWI3000	Swivel Unit Htr Flush Bracket - HD30 thru HD125	216.95

**THANK YOU!**  
*We appreciate  
your business*

Equipment

Equipment

**Gas-Fired Power Exhausted High-Efficiency II™ Propeller Unit Heaters**

- CSA Certification for use in the US and Canada
- 80% Thermal efficiency
- Power exhauster motor
- Differential pressure switch for proof of venting
- Aluminized steel heat exchanger
- Aluminized steel burner with stainless steel separator strip
- Certified to 0.5"wc external static pressure
- High limit safety control
- Control terminal board
- Adjustable motor sheaves on blower motors
- Totally enclosed fan/blower motors
- 115-1-60
- 10-Year warranty on heat exchanger - 2-Year on all other Parts



**Natural Gas Propeller Unit Heater**

Part #	Mfg #	BTUH Input	BTUH Output	Vent Dia	Air CFM @70°F	Max Temp Rise	Max Mounting Height	Max Throw	Motor HP	Price
68329	PDP150	150,000	120,000	4"	2,180	51°F	16'	55'	1/8PSC	2019.75
68330	PDP175	175,000	140,000	5"	2,550	51°F	17'	59'	1/6PSC	2181.74
68331	PDP200	200,000	160,000	5"	2,870	52°F	15'	51'	1/6PSC	2310.82
68333	PDP250	250,000	200,000	6"	3,700	50°F	19'	67'	1/3PSC	2885.36
68334	PDP300	300,000	240,000	6"	4,460	50°F	21'	74'	1/2PSC	3190.35
68335	PDP350	350,000	280,000	6"	4,870	53°F	20'	70'	3/4PSC	3557.34
68336	PDP400	400,000	320,000	6"	5,440	54°F	19'	69'	3/4PSC	3801.60

**PHASE OUT - Gas-Fired Low-Intensity Pressurized Infrared Unit Heaters**

These units are on phase out and will be replaced with the IPT units

- Simple chain mounting
- Single-burner positive pressure infrared heater
- Approved for vented or unvented commercial and industrial applications
- Weatherproof water-resistant control compartment
- Heat-treated 16 gauge aluminized steel heat exchanger and combustion chamber
- Gas valve closure in the event of blocked vent
- Four-trial hot surface ignition with separate flame sensor
- 115 Volt, 24Volt Control Voltage
- **5- Year Tube and 2- Year all other parts**



Part #	Mfg #	Model #	BTUH Input	Type of Gas	System Length	Recommended Mtg Hgt	Tube Kit Selection	Price
68345	40813	TLP175H34	175,000	Nat Gas	50',60',70'	18' - 28'	50'-B+C 60'-B+D 70'-B+E	1186.23
68346	40815	TLP200H34	200,000	Nat Gas	50',60',70'	20' - 30'	50'-B+C 60'-B+D 70'-B+E	1249.16

**Equipment**

**Gas-Fired Low-Intensity Infrared Unit Heaters Model IPT**

- Heat-treated darkened aluminized steel tubes
- Polished aluminum reflectors
- Removable side-access panels on both sides of the burner box
- Durable polyester-powder paint
- Permanently-lubricated combustion blower motor
- 180 degree-rotating gas valve
- Sealed burner compartment
- Weatherproof, water-resistant casing
- Four-trial separate flame sensor



Equipment

Part #	Mfg #	Model #	BTUH Input	Type of Gas	System Length	Recommended Mtg Hgt	Tube Kit Selection	Price
73334	77794	IPT50S0111	50,000	Nat Gas	20',30'	10' - 12'	20'-A 30'-E	1186.23
73316	77796	IPT75S0111	75,000	Nat Gas	20',30',40'	12' - 14'	20'-A 30'-E 40'-A+D	1186.23
73315	77797	IPT100S0111	100,000	Nat Gas	30',40'	12' - 14'	30'-E 40'-A+D 50'-E+D	1186.23
73314	77798	IPT125S0111	125,000	Nat Gas	40',50',60'	15' - 22'	40'-A+D 50'-E+D 60'-A+D+D	1186.23
73313	77799	IPT150S0111	150,000	Nat Gas	50',60'	15' - 25'	50'-B+C 60'-B+D	1186.23
73312	77800	IPT175S0111	175,000	Nat Gas	50',60',70'	18' - 28'	50'-B+C 60'-B+D 70'-B+E	1186.23
73311	77801	IPT200S0111	200,000	Nat Gas	50',60',70'	20' - 30'	50'-B+C 60'-B+D 70'-B+E	1186.23

**Tube Kits**

Part #	Mfg #	Description	Price
68347	40835	Tube Kit "A" 20' Tube Reflector	729.16
68348	40836	Tube Kit "B" 40' Tube Reflector	1298.33
68349	40837	Tube Kit "C" 10' Tube Reflector	286.22
68350	40838	Tube Kit "D" 20' Tube Reflector	570.25
68351	45687	Tube Kit "E" 30' Tube Reflector	1014.27
68352	32452	U-Tube Kit - Can only be used with the 20', 40' or 60' systems	218.74

**Modine Parts**

Part #	Mfg #	Description	Price
68382	32468	40' Hanging Chain Set	165.50

Table 2.3 - Stocking Tube Kit Selection

Tube (ft.)	Input MBH	Required Tube Kits
20	50,60	A
30	50,60,75,100	E
40	60,75,100,125	A+D
50	100,125	E+D
	150,175,200	B+C
60	125	A+D+D
	150,175,200	B+D
70	175,200	B+E

\*\*\* L.P. Options Differ from above: Please Call

**Quote Request Form**

Equipment



**Modine Direct Fired MAU Worksheet**



<b>Unit Application</b>	<input type="checkbox"/> 100% Makeup Air	<input type="checkbox"/> Heating & MUA	
<b>Unit Configuration</b>	<input type="checkbox"/> Horizontal	<input type="checkbox"/> Vertical	
<b>Discharge</b>	<input type="checkbox"/> Horizontal (Straight)	<input type="checkbox"/> Downturn (Bottom)	<input type="checkbox"/> Vertical (Top)
<b>Location</b>	<input type="checkbox"/> Indoor	<input type="checkbox"/> Outdoor w/ Rainhood	<input type="checkbox"/> Painted - Yes or No
<b>Rating</b>	<input type="checkbox"/> CFM	<input type="checkbox"/> Temp Rise or MBH Input	<input type="checkbox"/> External Static
<b>Filters</b>	<input type="checkbox"/> Permanent	<input type="checkbox"/> Farr Aeropleat III	<input type="checkbox"/> Farr 30/30
<b>Dampers</b>	<input type="checkbox"/> Inlet	<input type="checkbox"/> Outlet	<input type="checkbox"/> None
<b>Supply Voltage</b>	<input type="checkbox"/> Voltage	<input type="checkbox"/> Phase	
<b>Motor Type</b>	<input type="checkbox"/> ODP - Standard	<input type="checkbox"/> TE	<input type="checkbox"/> High Efficiency
<b>Gas Type</b>	<input type="checkbox"/> Natural	<input type="checkbox"/> Propane	<input type="checkbox"/> Gas Pressure PSI / "WC
<b>Gas Control Type</b>	<input type="checkbox"/> Duct Sensing	<input type="checkbox"/> Room Sensing	<input type="checkbox"/> DDC / 4-20mA or 0-10 VDC
<b>Insurance</b>	<input type="checkbox"/> IRI Standard (ETL)	<input type="checkbox"/> FM w/ Restriction	
<b>Add. Safety Switches</b>	<input type="checkbox"/> None	<input type="checkbox"/> Low & High Gas Press.	
<b>Control Access Side</b>	<input type="checkbox"/> Right Hand - Standard	<input type="checkbox"/> Left Hand	<input type="checkbox"/> Looking into Inlet End (FA)
<b>Roof Curb (Flat Roof Only)</b>	<input type="checkbox"/> Yes - 14" or 24"	<input type="checkbox"/> No	<input type="checkbox"/> Stand for Vert. Unit 24", 48" or 72"
<b>Service Door Interlocks</b>	<input type="checkbox"/> None	<input type="checkbox"/> Blower / Burner / Piping / Electrical or ALL (Circle Needed)	

**Options & Accessories**

<input type="checkbox"/> Pillow Block Bearings	<input type="checkbox"/> Control Relay DPDT
<input type="checkbox"/> 3 or 4 Way Discharge Louver	<input type="checkbox"/> Vibration Isolation
<input type="checkbox"/> Extended Grease Line	<input type="checkbox"/> Disc - Field or Factory
<input type="checkbox"/> Timed Freeze Protection	<input type="checkbox"/> Smoke Detector
<input type="checkbox"/> Mild Temp Stat	<input type="checkbox"/> Fire Stat
<input type="checkbox"/> E/F Interlock Terminals	<input type="checkbox"/> Room Override Stat
<input type="checkbox"/> Service Receptacle	<input type="checkbox"/> Circuit Analyzer

**Customer Info:**

Date: \_\_\_\_\_  
 Distributor: \_\_\_\_\_  
 Distributor Contact: \_\_\_\_\_  
 Job Name: \_\_\_\_\_  
 Contractor: \_\_\_\_\_

Quote will be based on the information supplied on this form so please answer and complete all questions.



Raley Brothers Inc. - PH. 616-742-0150 / FX. 616-742-0152





**Quote Request Form**



**Modine Indirect Fired MAU Worksheet**



Location	<input type="checkbox"/> Indoor	<input type="checkbox"/> Outdoor w/ Rainhood	
Venting	<input type="checkbox"/> Gravity	<input type="checkbox"/> Power	<input type="checkbox"/> Separated Combustion
Unit Application	<input type="checkbox"/> 100% Makeup Air	<input type="checkbox"/> Htg. & Makeup Air	<input type="checkbox"/> Heating Only
Unit Configuration	<input type="checkbox"/> Horizontal Discharge	<input type="checkbox"/> Downturn Discharge	
Dampers	<input type="checkbox"/> 2 Position	<input type="checkbox"/> Modulating	<input type="checkbox"/> Other - Please Note
Cooling Cabinet w/ Coil	<input type="checkbox"/> Yes	<input type="checkbox"/> No	<input type="checkbox"/> If Yes - Tons and 1 or 2 Circuit
Control Access Side	<input type="checkbox"/> Right Hand - Standard	<input type="checkbox"/> Left Hand	<input type="checkbox"/> Looking into discharge end
Rating	<input type="checkbox"/> CFM	<input type="checkbox"/> Temp Rise or MBH Input	<input type="checkbox"/> External Static Pressure
Filters	<input type="checkbox"/> 1" Permanent	<input type="checkbox"/> 2" Permanent	
	<input type="checkbox"/> 2" Farr Aeropleat	<input type="checkbox"/> 2" Far 30/30	
Supply Voltage	<input type="checkbox"/> Voltage	<input type="checkbox"/> Phase	
Motor Type	<input type="checkbox"/> ODP - Standard	<input type="checkbox"/> TE	<input type="checkbox"/> High Efficiency
H/E & Burner Material	<input type="checkbox"/> Stainless Steel	<input type="checkbox"/> Aluminized	
Gas Type	<input type="checkbox"/> Natural	<input type="checkbox"/> Propane	<input type="checkbox"/> Gas Pressure PSI / " WC
Gas Control Type	<input type="checkbox"/> Single Stage	<input type="checkbox"/> 2 Stage*	<input type="checkbox"/> *Duct or Room Sensing
	<input type="checkbox"/> Electronic Modulation*	<input type="checkbox"/> DDC 4-20mA or 0-10VDC	<input type="checkbox"/> *Room Override Stat
Add. Safety Switches	<input type="checkbox"/> Low Gas Pressure	<input type="checkbox"/> High Gas Pressure	<input type="checkbox"/> Both High & Low Gas Pressure
Roof Curb (Flat Roof Only)	<input type="checkbox"/> Insulated	<input type="checkbox"/> Uninsulated	<input type="checkbox"/> None

**Options & Accessories**

<input type="checkbox"/> Double Wall Const.	<input type="checkbox"/> Circuit Analyzer 6 or 10
<input type="checkbox"/> Vibration Isolation	<input type="checkbox"/> Convenience Outlet
<input type="checkbox"/> Air Flow Proving Switch	<input type="checkbox"/> Dirty Filter Press.Switch
<input type="checkbox"/> Timed Freeze Protection	<input type="checkbox"/> Control Relay
<input type="checkbox"/> Mild Temp Stat	<input type="checkbox"/> Disc. - Field/Factory
<input type="checkbox"/> Fire Stat	<input type="checkbox"/> Smoke Detector
<input type="checkbox"/> Service Switches	<input type="checkbox"/> Remote Panel

**Customer Info:**

Date: \_\_\_\_\_  
Distributor: \_\_\_\_\_  
Distributor Contact: \_\_\_\_\_  
Job Name: \_\_\_\_\_  
Contractor: \_\_\_\_\_

Quote will be based on the information supplied on this form so please answer and complete all questions.



**Raley Brothers Inc. - PH. 616-742-0150 / FX. 616-742-0152**



Equipment

Equipment

Equipment

**Empire Residential Console Wall Furnaces**

**Direct Vent Wall Furnaces**

- Must field supply a thermostat
- Standing Pilot/Piezo ignition system
- LP available for order



DV-210/DV-215

Prod ID#	CSI#	Input BTUH	Desc	Ship Wt (lb)	Price
34958	DV210SGXNAT	10,000	NG	40	1274.40
34959	DV215SGXNAT	15,000	NG	51	1454.67

DV-25/DV-35

- Millivolt wall thermostat control
- Standing Pilot/Piezo ignition system
- LP available for order



Prod ID#	CSI#	Input BTUH	Desc	Ship Wt (lb)	Price
34960	DV25SG	25,000	NG	93	1815.22
34961	DV35SG	35,000	NG	96	1967.76

**Direct Vent Wall Furnace Accessories**

Prod ID#	CSI#	Description	Price
34965	DRB1	Blower Assy for DV25/35	347.54
34964	DVB1	Blower Assy for DV210/215	347.54
34966	DV822	Vinyl Siding Vent Kit For DV	136.51
36202	17080/682253	NG to LP Conv Kit DV210	136.96
40607	17082/682254	NG to LP Conv Kit DV215	119.84
49264	17084/682249	NG to LP Conv Kit DV25	128.40
44855	17086/682250	NG to LP Conv Kit DV35	125.19

**Empire Residential Wall Furnaces**

**Direct Vent Counterflow Wall Furnaces**

- Thermostat must be field supplied
- LP available for order

Standing Pilot/Piezo



Prod ID#	CSI#	Input BTUH	Desc	Ship Wt (lb)	Price
39719	DVC35SPPXNAT	35,000	NG	107	2591.78
34962	DV55SPPXNAT	55,000	NG	123	2910.73

**Counterflow Vented Wall Furnaces**

- Thermostat must be field supplied
- LP available for order

Standing Pilot/Piezo Ignition System



Prod ID#	CSI#	Input BTUH	Desc	Ship Wt (lb)	Price
35822	FAW40SPPXNAT	40,000	NG	110	2245.10
34963	FAW55SPPXNAT	55,000	NG	135	2577.91

**Direct Vent Gas Fireplaces**

**Deluxe Model Features:**

- Contour tube-style Burner
- Large heat-resistant, tempered class window for unobstructed view of the log set
- Barrier screen comes with Fireplace and must be installed for code compliance

**Deluxe Direct-Vent Fireplace**

- IP Electronic Ignition
- 20,000 BTU
- Natural Gas
- Intermittent Pilot models eliminate the standing pilot for even greater energy savings. IP requires 120V AC to operate on a daily basis but can run on battery backup to provide heat during a power outage.
- Barrier screen comes with Fireplace and must be installed for code compliance



Prod ID#	CSI#	Description	Price
71276	DVD36FP70N	Deluxe 36" F/P DV w/Bar Screen	1550.75
71698	DVD42FP70N	Deluxe 42" F/P DV w/Bar Screen	1946.40

**Equipment**

**Tahoe Deluxe Direct Vent Gas Fireplace**

- Millivolt Ignition with Standing Pilot/Pieze
- Barrier screen comes with Fireplace and must be installed for code compliance



Brass Leaf Trim



Prod ID#	CSI#	Input BTUH	Gas Type	Ship Wt	Price
72859	DVD32FP30N	18,000	NG	96 lbs	1647.24
72860	DVD36FP30N	20,000	NG	102 lbs	1376.70

**Tahoe Deluxe Direct Vent Gas Fireplace+**

- Standing Pilot
- Barrier screen comes with Fireplace and must be installed for code compliance
- Blower factory Installed



Prod ID#	CSI#	Input BTUH	Gas Type	Ship Wt	Price
72861	DVD36FP31N	20,000	NG	105 lbs	2030.59
72863	DVD42FP31N	28,000	NG	145 lbs	1946.40

**Tahoe Deluxe Clean Face Direct Vent Gas Fireplace**

- Millivolt Ignition with Standing Pilot/Piezo
- Barrier screen comes with Fireplace and must be installed for code compliance



Prod ID#	CSI#	Input BTUH	Gas Type	Ship Wt	Price
72867	DVCD32FP30N	18,000	NG	96 lbs	1803.51
72858	DVCD36FP30N	20,000	NG	109lbs	1895.71

**Remotes**



Prod ID#	CSI#	Description	Price
59631	FRBC	Battery Remote, On/Off	239.68
70863	FRBTC	Battery Remote, T'Stat	364.70

**Variable Speed Blower**



Prod ID#	CSI#	Description	Price
69701	FBB4	Variable Speed Blower	382.63

**Direct Vent Kit for Homes with Vinyl Siding**

- Compatible with all Products vented with 4x6 Pipe
- Includes:
  - (1) Slimline rectangular vinyl siding wall plate and shield
  - (1) Small round beige vent cap
  - (1) Wall thimble
  - (1) Collar
  - (1) Adaptor plate
  - (1) 4" x 36" Exhaust vent
  - (1) 7" x 36" Intake vent

Prod ID#	CSI#	Description	Price
69625	DVVK-4RE-VS	4x6 DV Horizontal Vent Kit	257.12

**Direct Vent Chimney Systems**

- For use with direct vent gas or propane stoves, heaters, and fireplaces

**4DT Double Wall 4x6 Fireplace Vent Pipe**

- Outer walls constructed of heavy duty galvanized steel
- 304 Stainless Steel inner pipe
- No sealant required
- Pipe rotates to easily align and lock into place



Prod ID#	CSI#	Description	Price
73596	4DT-06	4x6 6" Vent Pipe (Galv)	59.22
67244	4DT-09	4x6 9" Vent Pipe (Galv)	63.85
73338	4DT-12	4x6 12" Vent Pipe (Galv)	72.13
73598	4DT-24	4x6 24" Vent Pipe (Galv)	94.71
73599	4DT-36	4x6 36" Vent Pipe (Galv)	116.33
73600	4DT-48	4x6 48" Vent Pipe (Galv)	139.97
73337	4DT-EL45	4x6 45 Deg Vent Elbow (Galv)	99.05
73603	4DT-90S	4x6 90 Deg Vent Elbow (Galv)	122.20
75011	4DT-VT	4x6 Vertical Termination (Galv)	179.70
75967	4DT-SC	4x6 Storm Collar (Galv)	19.26



Equipment

Equipment

Equipment

**Tankless Residential Gas Water Heaters**

**PVC Vented Models**

- 15-Year limited warranty on heat exchanger (6-Year Commercial)
- 5-Year warranty on all parts
- On-board diagnostics
- Energy Star Qualified
- Energy Factor of .95
- Easy Link up to 4 units (GTS540 Only)
- 3" Concentric Kit used for Venting - CVENT-3
- PVC (not foam core), CPVC of ABS for intake and exhaust



Prod ID#	CSI#	Gal Cap	BTU Input		Ship Wt. (lbs)	Gas	Price
			Min	Max			
74003	GTS-140-NIH	6.6	15,000	120,000	44	Natural	1621.55
67597	GTS-340-NIH	8.0	15,000	180,000	62	Natural	2192.75
67603	GTS-540-NIH	10	15,000	199,000	63	Natural	2652.96

**GTS-540P-NIH - With Integrated Recirculation Pump**

- 15-Year limited warranty on heat exchanger (6-Year Commercial)
- 5-Year warranty on all parts
- On-board diagnostics
- Energy Star Qualified
- Energy Factor of .95
- Easy Link up to 4 units (GTS540 Only)
- 3" Concentric Kit used for Venting - CVENT-3
- PVC (not foam core), CPVC of ABS for intake and exhaust
- Integrated Recirculation Pump
- Integrated Temperature and Pump Controls with advanced diagnostics



Prod ID#	CSI#	Gal Cap	BTU Input		Ship Wt. (lbs)	Gas	Price
			Min	Max			
75767	GTS-540P-NIH	6.6	15,000	120,000	61	Natural	3113.17

**Tankless Plumbing Kit**



Prod ID#	CSI#	Description	Price
58604	101-149NL	3/4" Tankless Plumbing Valve Kit - No Lead	208.63

Shaded items are Non-Stock special order & Subject to Freight

Sterling Hts, MI - Livonia, MI - Lansing, MI - Grand Rapids, MI - Waterford, MI - Almont, MI - Saginaw, MI

**Equipment**

Equipment

**ProLine® Residential Water Heaters**

**ProLine® Atmospheric Vent High Recovery**

- 6-Year Tank Warranty
- 6-Year Parts Warranty
- Commercial Grade Water Heater for the Home
- Fully automatic controls w/safety shut off
- Green choice gas burner
- Self cleaning dip tube
- Push button piezo igniter
- CoreGard™ Advanced Anode Rod Protection
- Blue Diamond® glass coating
- Enhanced-Flow brass drain valve
- Meets UBC,CEC & ICC National Codes
- CSA certified & ASME rated T&P Valve
- Max hydrostatic working pressure of 150PSI



Prod ID#	CSI#	Gal Cap	Input BTU/Hr	Gas Type	90° Rise Recovery (GPH)	Dimensions Ht(w/DH) x Dia (in)	Ship Wt (lbs)	Price
51362	GS6-75-XRRS	74	75,100	Natural	81	61 x 26-1/2	275	2402.15

**ProLine® High Output Gas Water Heaters NAECA Compliant**

- 6-Year Tank Warranty
- 6-Year Parts Warranty
- Commercial Grade Water Heater for the Home
- Self Cleaning Dip Tube
- Blue Diamond® Glass Coating
- Enhanced-Flow Brass drain valve
- Core-Gard™ Advanced Anode Rod Protection
- Heat-trap nipples
- Self Powered Electronic Gas Valve



Prod ID#	CSI#	Gal Cap	Input BTU/Hr	Gas Type	90° Rise Recovery (GPH)	Dimensions Ht(w/DH) x Dia (in)	Ship Wt (lbs)	Price
71443	GS6-50-XCT	50	60,000	Natural	61	65-1/2 x 22	190	1794.93

**Shaded items are Non-Stock special order & Subject to Freight**

**Sterling Hts, MI - Livonia, MI - Lansing, MI - Grand Rapids, MI - Waterford, MI - Almont, MI - Saginaw, MI**

Equipment

Equipment

**ProLine® Tall Gas Water Heaters NAECA Compliant**

- 6-Year Tank Warranty
- 6-Year Parts Warranty
- Commercial Grade Water Heater for the Home
- Self Cleaning Diffuser dip tube
- Blue Diamon® Glass Coating
- Easy-to-light piezo igniter
- Enhanced-Flow Brass drain valve
- Heat Trap Nipples
- CoreGard™ Advanced Anode Rod Protection
- Self-Powered Electronic Gas Valve
- Thick, CFC-free foam insulation
- 3" or 4" vent connections



Prod ID#	CSI#	Gal Cap	Input BTU/Hr	Gas Type	90° Rise Recovery (GPH)	Dimensions Ht(w/DH) x Dia (in)	Ship Wt (lbs)	Price
75495	GS6-40-BRBT	40	40,000	Natural	42	62 x 18	130	1094.17
71317	GS6-40-BCT	40	40,000	Natural	42	58-1/4 x 20	138	1034.96
71318	GS6-50-BRT	50	40,000	Natural	41	57-1/4 x 21	148	1196.74
71709	GS6-40-HBCT	40	40,000	Propane	41	58-1/4 x 20	138	1327.01
50867	GS6-50-HBRT	50	40,000	Propane	41	57-1/4 x 20	148	1466.11
72783	GS6-50-RCTL	50	50,000	Natural	54	57-1/4 x 22	165	1706.65

**ProLine® Short Gas Water Heaters NAECA Compliant**

- 6-Year Tank Warranty
- 6-Year Parts Warranty
- Commercial Grade Water Heater for the Home
- Enhanced-Flow Brass Drain Valve
- Blue Diamond® Glass Coating
- Self Cleaning Dip Tube
- CoreGard™ Advanced Anode Rod Protection
- Heat Trap Nipples
- Push-Button Piezo Ignitor
- Glasslined tank, 3/4" water connections
- Enhanced Flow Brass drain valve
- 3" or 4" Vent connection



Prod ID#	CSI#	Gal Cap	Input BTU/Hr	Gas Type	90° Rise Recovery (GPH)	Dimensions Ht(w/DH) x Dia (in)	Ship Wt (lbs)	Price
71436	GS6-40-BCS	40	40,000	Natural	41	51-1/2 x 22	135	1034.96
71710	GS6-40-HBCS	40	40,000	Propane	41	51-1/2 x 22	135	1327.01

Shaded items are Non-Stock special order & Subject to Freight

**Sterling Hts, MI - Livonia, MI - Lansing, MI - Grand Rapids, MI - Waterford, MI - Almont, MI - Saginaw, MI**

**Equipment**

Equipment

**ProLine® Tall Electric Water Heaters NAECA Compliant**

- 6-Year Tank Warranty
- 6-Year Parts Warranty
- Commercial Grade Water Heaters for the Home
- Enhanced-Flow Brass Drain Valve
- Self Cleaning Dip Tube
- Blue Diamond® Glass Coating
- Glass-lined tank
- Coregard Advanced Anode Rod Protection
- Dual 4500-watt heating elements
- Heat Trap Nipples



Prod ID#	CSI#	Gal Cap	Voltage	Dimensions Ht(w/DH) x Dia (in)	Ship Wt. (lbs)	Price
71437	EN6-40-DORT	40	240V	60-1/4" x 20"	118	1024.53
71438	EN6-50-DORT	50	240V	60-1/2" x 22"	134	1212.95

**ProLine® Short Electric Water Heaters NAECA Compliant**

- 6-Year Tank Warranty
- 6-Year Parts Warranty
- Commercial Grade Water Heaters for the Home
- Enhanced Flow Tamper resistant brass drain valve
- Longlasting PEX polymer dip tube
- Foam insulation
- Blue Diamond® Glass-lined tank
- Coregard Advanced Sacrificial Anode Rod
- Dual 4500-watt heating elements
- Factory-installed Safety Valve (relief valve)
- U.L. Listed Energy Cut-Off



Prod ID#	CSI#	Gal Cap	Voltage	Dimensions Ht(w/DH) x Dia (in)	Ship Wt. (lbs)	Price
71435	EN6-30-DOLS	28	240V	31-1/4" x 24"	115	1246.55

*We Feature The Brand Name Products  
You Are Looking For*

**Shaded items are Non-Stock special order & Subject to Freight**

**Sterling Hts, MI - Livonia, MI - Lansing, MI - Grand Rapids, MI - Waterford, MI - Almont, MI - Saginaw, MI**

Equipment

Equipment

**ProLine® Master Residential Water Heaters**

**ProLine® Master - Tall Gas Water Heaters NAECA Compliant**

- 8-Year Tank Warranty
- 8-Year Parts Warranty
- Commercial Grade Water Heater for the Home
- Self Cleaning Diffuser dip tube
- Core-Gard™ Advanced Anode Rod Protection
- Easy-to-light piezo igniter
- Enhanced-Flow Brass drain valve
- Heat Trap Nipples
- Blue Diamond® Glass Coating
- 3" or 4" vent connections
- Increase Anode Rod protection



Prod ID#	CSI#	Gal Cap	Input BTU/Hr	Gas Type	90° Rise Recovery (GPH)	Dimensions Ht(w/DH) x Dia (in)	Ship Wt (lbs)	Price
75764	GW8-40-BCT	40	40,000	Natural	41	61-3/4 x 20	138	1106.01
75762	GW8-50-BRT	50	40,000	Natural	41	60-3/4 x 21	148	1270.46

**ProLine® Master - Short Gas Water Heaters NAECA Compliant**

- 8-Year Tank Warranty
- 8-Year Parts Warranty
- Commercial Grade Water Heater for the Home
- Self Cleaning Diffuser dip tube
- Easy-to-light piezo igniter
- Enhanced-Flow Brass drain valve
- Heat Trap Nipples
- Blue Diamond® Glass Coating
- 3" or 4" vent connections
- Core-Gard™ Advanced Anode Rod protection



Prod ID#	CSI#	Gal Cap	Input BTU/Hr	Gas Type	90° Rise Recovery (GPH)	Dimensions Ht(w/DH) x Dia (in)	Ship Wt (lbs)	Price
75765	GW8-40-BCS	40	40,000	Natural	41	51-1/2 x 22	135	1106.01

Shaded items are Non-Stock special order & Subject to Freight

**Sterling Hts, MI - Livonia, MI - Lansing, MI - Grand Rapids, MI - Waterford, MI - Almont, MI - Saginaw, MI**



**Equipment**

**ProLine® XE Residential Power Vent Water Heaters**

**ProLine® XE Power Vent Gas Water Heaters - ENERGY STAR QUALIFIED**

- **6-Year Tank Warranty**
- **6-Year Parts Warranty**
- Commercial Grade Water Heaters for the Home
- Power-vent design, system permits combined horizontal and vertical vent runs up to 120' with 3" pipe, up to 160 equivalent feet with 4" pipe on 40,000 BTU and 50,000 BTU models
- Diffuser dip tube made of PEXAN™ - can withstand long-term exposure to water temps up to 400°F
- Intelli-Vent™ power gas control - silicon nitride hot surface igniter
- Quiet modular blower - 110/120V (rating 3 amps or less), 6' cord with standard 3-prong male connector
- Green-Choice™ Eco-Friendly gas burner reduces NOx emissions by 33%
- Enhanced Flow Brass tamper-resistant drain valve - Max. hydrostatic working pressure: 150 psi
- Blue Diamond® Glasslined tank - Thick, CFC-free foam insulation - 3/4" Male water connections
- CoreGard™ Advanced Anode Rod Protection - Factory-installed T&P relief valve
- No chimney required - vented through outside wall or roof



Equipment

Prod ID#	CSI#	Gal Cap	Input BTU/Hr	Gas Type	90° Rise Recovery (GPH)	Dimensions Ht(w/DH) x Dia (in)	Ship Wt (lbs)	Price
67953	GS6-40-YBVIS	40	40,000	Natural	44.7	59 x 22	174	2029.23
67954	GS6-50-YBVIS	50	40,000	Natural	44.7	60-1/8 x 24	198	2073.15
74470	GS6-40-HBVIS	40	40,000	Propane	44.7	59 x 22	174	2455.65
55583	GS6-50-HBVIS	50	40,000	Propane	44.7	60-1/8 x 24	198	2606.73
68070	GS6-40-YRVIT	40	50,000 - .70EF	Natural	55.9	68-1/2 x 20	176	2380.75
68072	GS6-50-YRVHSL5	50	62,000 - .70EF	Natural	69.3	60-1/8 x 24	212	3413.30
68849	GS6-75-YRVHTL	75	76,000	Natural	81.9	70-5/8 x 26	277	3501.58

**Premier Power Direct Vent Hi-Efficiency Gas Water Heater**

- **6-Year Limited Tank Warranty**
- **6-Year Limited Parts Warranty**
- T&P Relief Valve
- Top 3/4" Water Connection
- Energy Star Rated
- Electronic Ignition
- Pilot Reset Button
- Sacrificial Anode Rod
- Large LCD Display
- Side-Mounted hot & cold recirculating taps
- Helical internal heat exchanger



Prod ID#	CSI#	Gal Cap	Input BTU/Hr	Gas Type	90° Rise Recovery (GPH)	Dimensions Ht(w/DH) x Dia (in)	Ship Wt (lbs)	Price
60513	GP6-50-YTPDT	50	100,000 - 96%	Natural	129	66-3/4 x 22	255	6510.95

**Shaded items are Non-Stock special order & Subject to Freight**

**Sterling Hts, MI - Livonia, MI - Lansing, MI - Grand Rapids, MI - Waterford, MI - Almont, MI - Saginaw, MI**

Equipment

Equipment

**Premier Power Vent Hi-Efficiency Gas Water Heater**

- 6-Year Limited Tank Warranty
- 6-Year Limite Parts Warranty
  - T&P Relief Valve
  - Top 3/4" Water Connectio
  - Energy Star Rated
  - Electronic Ingition
  - Pilot Reset Button
  - Sacrificial Anode Rod



Prod ID#	CSI#	Gal Cap	Input BTU/Hr	Gas Type	Dimensions Ht(w/DH) x Dia (in)	Ship Wt (lbs)	Price
53996	GP6-50-YTVIT	50	76,000 - 90%	Natural	71 x 22	210	5125.30

**ProLine® XE Hybrid Electric Heat Pump Residential Water Heaters**

- 6-Year Tank Warranty
- 6-Year Parts Warranty
- Up to a 3.24 Energy Factor EF Rating - ENERGY STAR
- Backup Electric Elements
- Dry Fire Protection
- Electronic User Interface
- Dehumidifies and cools the ambient air
- Reduces water heating cost by up to 72%



Prod ID#	CSI#	Gal Cap	Input BTU/Hr	Gas Type	90° Rise Recovery (GPH)	Dimensions Ht(w/DH) x Dia (in)	Ship Wt (lbs)	Price
71760	HP6-50-DHPT	50	3.24 EF	Electric	67.5	63 x 22	196	2616.15



Shaded items are Non-Stock special order & Subject to Freight

Sterling Hts, MI - Livonia, MI - Lansing, MI - Grand Rapids, MI - Waterford, MI - Almont, MI - Saginaw, MI

**Equipment**

Equipment

**ProLine® Manufactured Housing Water Heaters**

- 6-Year Tank Warranty
- 2-Year Parts Warranty

**ProLine® Direct-Vent Gas Water Heaters-Manufactured Housing NAECA Compliant**

- 6-Year Limited Tank Warranty
- 2-Year Parts Limited Warranty
- Commercial Grade Water Heater for the Home
- Complies with HUD standards for manufactured housing installation
- Gas control is convertible for natural & propane gas
- Side-mounted 3/4" cold water inlet
- Factory-installed T&P relief valve
- CSA design certified
- Blue Diamond® Glass Coating
- Core-Gard™ Advanced Anode Rod Protection
- Self-Cleaning Dip Tube



Prod ID#	CSI#	Gal Cap	Input BTU/Hr	Gas Type	90° Rise Recovery (GPH)	Dimensions Ht(w/DH) x Dia (in)	Ship Wt (lbs)	Price
71439	GS6-30-MDV	30	30,000	Natural	31	61" x 18"	129	1474.46
71440	GS6-40-MDV	40	33,000	Natural	33	61 3/4" x 20"	153	1582.96

**ProLine® Mobile Home Atmospheric Vent NAECA Compliant**

- Complies with HUD standards for manufactured housing installation
- CSA design certified
- Gas control is convertible for natural & propane gas
- Side-mounted 3/4" cold water inlet
- Blue Diamond® glass coating
- Core-Gard™ Advanced Anode Rod Protection
- Enhanced-Flow Brass Drain Valve
- Comes from factory set for Natural Gas - (Propane Burner is supplied for Conversion)



Prod ID#	CSI#	Gal Cap	Input BTU/Hr	Gas Type	90° Rise Recovery (GPH)	Dimensions Ht(w/DH) x Dia (in)	Ship Wt (lbs)	Price
71711	GS6-30-MHG	30	35,500	Convertible	36	61-1/2" x 18"	129	1432.73
75992	GS6-40-MHG	40	35,500	Convertible	36	61.75" x 20"	153	1452.53

**Shaded items are Non-Stock special order & Subject to Freight**

**Sterling Hts, MI - Livonia, MI - Lansing, MI - Grand Rapids, MI - Waterford, MI - Almont, MI - Saginaw, MI**

Equipment

Equipment

**ProLine® Manufactured Housing Electric Water Heaters**

- 6-Year Tank Warranty
- 6-Year Parts Warranty
- HUD compliant for manufactured housing installations
- Enhanced Flow Tamper resistant brass drain valve
- Blue Diamond® Glass-lined tank
- Coregard Advanced Sacrificial Anode Rod
- CSA Certified and ASME rated T&P Relief Valve
- Side Water Connections for ease of installation



Prod ID#	CSI#	Gal Cap	Voltage	Dimensions Ht(w/DH) x Dia (in)	Ship Wt. (lbs)	Price
78013	MHE6-30H-035D	30	3500	46.75 x 19	98	1233.18

**Expansion Tanks**

**Expansion Tanks For Potable Water Heaters**

- 3/4" Stainless Steel Connection



Prod ID#	CSI#	Description	Price
62457	12-A102 (TE12)	4.5Gal Expansion Tank for Potable Water	113.29

**Relief Valve**

Prod ID#	CSI#	Description	Price
598	NCLX-5	3/4" x 6" Long T & P Valve	36.85

**Accessories**

Prod ID#	CSI#	Description	Price
51104	9002964/100093832	12" Non Adjustable Roof Jack Kit	388.51
52918	9006299/100111073	16" Zinc Anode Rod for smelly water	103.58

**Water Heater Pans**

**Aluminum**

- Round-shaped
- Pre-drilled for 1" PVC drain



Prod ID#	CSI#	Size	Price
59044	AWHP-22-5	22" Round	58.39
73400	AWHP-26-5	26" Round	63.67
72667	AWHP-30-5	30" Round	81.60

**Extended Warranties**

**4-Yr Extended Warranty for 6Y Select W/H's**

Prod ID#	CSI#	Description	Price
54613	100109798/9004329	4-Yr Ext Warranty for 6-year Select Water Htrs	312.98
75104	100111229/9006480	4-Yr Ext Warranty for 6-year Power Vent Water Htrs	497.55

Shaded items are Non-Stock special order & Subject to Freight

**Sterling Hts, MI - Livonia, MI - Lansing, MI - Grand Rapids, MI - Waterford, MI - Almont, MI - Saginaw, MI**

**Equipment**

Equipment

**Manufactured Housing Equipment - Style Crest - Revolv**

**Vexar 95% High-Efficiency Gas Furnaces**

- Lifetime limited warranty on both heat exchangers to original purchaser, 20-year limited warranty from original installation date to subsequent purchaser (10-year warranty on heat exchanger in commercial applications)
- 5-Year limited warranty on parts
- 57" Tall 18"Wide 25-3/4"Deep
- Energy Star Certified
- A/C Ready To 3-Ton
- Heavy-Duty 18-Guage Heat Exchanger
- 24v, 40 vA control transformer and blower relay
- Timed on, adjustable off blower capability
- High efficiency condensing
- ETL Listed
- Concentric Vent Kit Available for easy venting
- Sealed Combustion Design
- Silicon Nitride Igniter
- Standard Footprint - Replaces older M/H
- 100% Shut off main gas valve
- Easy Conversion to L.P.
- PSC four speed direct-drive blower motors
- Timed on, adjustable off blower capability
- Insulated blower compartment



Prod ID#	CSI#	Tons	Input BTUH	Output BTUH	Nom CFM	AFUE %	Width (Inches)	Price
71240	08540005/VMC50N	3	50	48	1200	95	18	3705.53
71241	08540006/VMC75N	4	75	71	1200	95	18	3804.10

**Vexar 95% Furnace Accessories**

Prod ID#	CSI#	Description	Price
64811	0856001	Combustible Base for Vexar 95% Furnace	368.82
71313	904106	Hi-Eff Mfg Housing Vent Kit	96.86

**MG9S 95.5% Multi-Position High-Efficiency Gas Furnaces - Guardian**

- 15-Year Heat Exchanger Warranty
- 2-Year Parts & 1 Labor warranty
- 33" Tall 29.5" deep
- Secondary (condensing) heat exchanger of 29-4C high-grade stainless steel
- Blower-off delay for cooling SEER improvement
- Tubular aluminized steel primary heat exchanger
- May be installed as either two-pipe (sealed combustion) or single pipe vent (using indoor combustion air)
- 24v, 40 vA control transformer and blower relay
- Timed on, adjustable off blower capability
- High efficiency condensing
- Built-in LED diagnostics with fault code memory
- Protection from intake, exhaust, or condensate blockage
- Multi-Position for all Configurations
- Electronic hot surface ignition
- Top intake & vent connection
- Insulated blower compartment
- 100% Shut off main gas valve
- 1/4 turn knobs for easy door removal
- PSC four speed direct-drive blower motors
- Timed on, adjustable off blower capability
- No special vent termination kit req'd
- LP Kit shipped with furnace
- 29.5" Deep



Prod ID#	CSI#	Tons	Input MBH	Output MBH	Cabinet	Nom CFM	AFUE %	Width (Inches)	Plenum (Inches)	Price
60464	MG9S060B12MP11	3	60	57	B	1200	95.5	17-1/2	16-3/8 x 20	2096.13
60465	MG9S080B12MP11	3	80	76	B	1200	95.5	17-1/2	16-3/8 x 20	2211.69

**Shaded Items are Non-Stock special order**

**Sterling Hts, MI - Livonia, MI - Lansing, MI - Grand Rapids, MI - Waterford, MI - Almont, MI - Saginaw, MI**

**Equipment**

Equipment

**DGAA 80% Downflow Mobile Home Natural Gas Furnaces - Guardian**

- 2-Year Parts & 1 Labor Warranty
- 10- Year Heat Exchanger
- Air conditioning ready to 4 tons, built-in coil cabinet
- Standard replaceable filters (included)
- Zero clearance on back and sides
- Fail-safe automatic hot surface ignition system
- Full louver high impact plastic return air door
- Sealed combustion design
- LP convertible



Prod ID#	CSI#	Input MBH	Output MBH	AFUE %	Dimensions H x W x D(in)	Weight (lb)	Filter Size (in)	Price
47293	DGAA056BDTD	56	45	80	76 x 19-1/2 x 24-3/4	145	16 x 20 x 1	1595.58
47294	DGAA070BDTD	70	56	80	76 x 19-1/2 x 24-3/4	145	16 x 20 x 1	1646.94
47295	DGAA077BDTD	77	62	80	76 x 19-1/2 x 24-3/4	146	16 x 20 x 1	1653.79
47296	DGAA090BDTD	90	72	80	76 x 19-1/2 x 24-3/4	159	16 x 20 x 1	1681.18

**DGAH 80% Downflow Mobile Home Natural Gas Furnaces**

- 2 - Year Parts & 1 Labor Warranty
- 10 - Year Heat Exchanger
- Fail-safe automatic hot surface ignition system
- Standard replaceable filters (included)
- Sealed combustion design
- LP convertible
- Heating only
- Full louver high impact plastic return air door
- Approved for mobile/modular homes
- Zero clearance on back and sides



Prod ID#	CSI#	Input MBH	Output MBH	AFUE %	Dimensions H x W x D(in)	Weight (lb)	Filter Size (in)	Price
47297	DGAH056BBSD	56	45	80	59-1/2 x 19-1/2 x 24-3/4	131	16 x 20 x 1	1516.83
47298	DGAH077BBSD	77	62	80	59-1/2 x 19-1/2 x 24-3/4	131	16 x 20 x 1	1553.02

**Manufactured Housing Roof Jacks, Parts & Accessories**

**Adjustable Roof Jacks**

- Measure from bottom of furnace to outside roof line for roof jack dimension
- Must replace old roof jack



Prod ID#	CSI#	Description	Price
19608	4000-7101/C	Roof Jack 86"-95" Adjustable	262.15
19610	4000-7121/C	Roof Jack 91"-102" Adjustable	265.90
19612	4000-7141/C	Roof Jack 99"-120" Adjustable	310.84
19613	4000-7151/C	Roof Jack 106"-132" Adjustable	337.05

**Crowns**



Prod ID#	CSI#	Description	Price
29655	S1-4000-6941/C	Removable Crown For 4000 Series	223.84

Shaded Items are Non-Stock special order

Sterling Hts, MI - Livonia, MI - Lansing, MI - Grand Rapids, MI - Waterford, MI - Almont, MI - Saginaw, MI

**Equipment**

**Accessories**

Prod ID#	CSI#	Description	Price
23069	7680B6541	18" Exterior Roof Jack Extension	101.78
10064	7900-6061/A	2 Speed A/C Blower Package w/o Control	421.15
10062	7900A6041/18400001	Control Pkg For 4 Wire Thermostat	288.32
23259	7900A6171	17" Interior Roof Jack Extension	119.33
37576	7900-7611	Lower Door DGAA's M/H Tall	105.29
61074	7900-7631	Upper Door DGAA's & DGAH's M/H	154.42

**Manufactured Housing Coils & TXV's**

**Manufactured Housing 13 SEER R410A Coils**

- 5 - Year Warranty on Aspen CM series
- When matching the CM48E34-177L-006 to a TC3B42 A/C unit you must add a Hard Start Kit \*\*\*\*\*



Prod ID#	CSI#	Description	Price
64910	CM24A3G-177L-006	1.5t-2t 13seer Manf Coil R410A - sweat 17 3/4"w x 19 1/2"d x 13"h	616.32
64911	CM36A3G-177L-006	2.5t-3t 13seer Manf Coil R410A - sweat 17 3/4"w x 19 1/2"d x 17"h	704.92
72855	CM48E36-177L-006	3.5t-4t 13seer Manf Coil R410A - sweat 17 3/4"w x 19 1/2"d x 19.5"h w/Bleed TXV	905.22

**Manufactured Housing TXV Kits**

Prod ID#	CSI#	Description	Price
56048	R72DB0003	1.5t-3t Manf Housing TXV Kit - R410A	183.61
56049	R72DB0004	3.5t-5t Manf Housing TXV Kit - R410A	183.61

**Shaded Items are Non-Stock special order**

**Sterling Hts, MI - Livonia, MI - Lansing, MI - Grand Rapids, MI - Waterford, MI - Almont, MI - Saginaw, MI**

SWIVEL FLASHING ADJUSTS FROM 0/12 TO 5/12 PITCH		INSTALLATION DIMENSIONS	
		"A" ADJUSTABLE HEIGHT 59-1/2" CASING	"B" ADJUSTABLE HEIGHT 76" CASING
<b>STANDARD ROOF JACK</b>			
4000-7101/C		70" to 79"	86" to 95"
4000-7121/C		75" to 86"	91" to 102"
4000-7141/C		83" to 104"	99" to 120"
4000-7151/C		90" to 116"	106" to 132"
4000-7171/C	*** No Longer Available ***	127" to 157"	143" to 173"

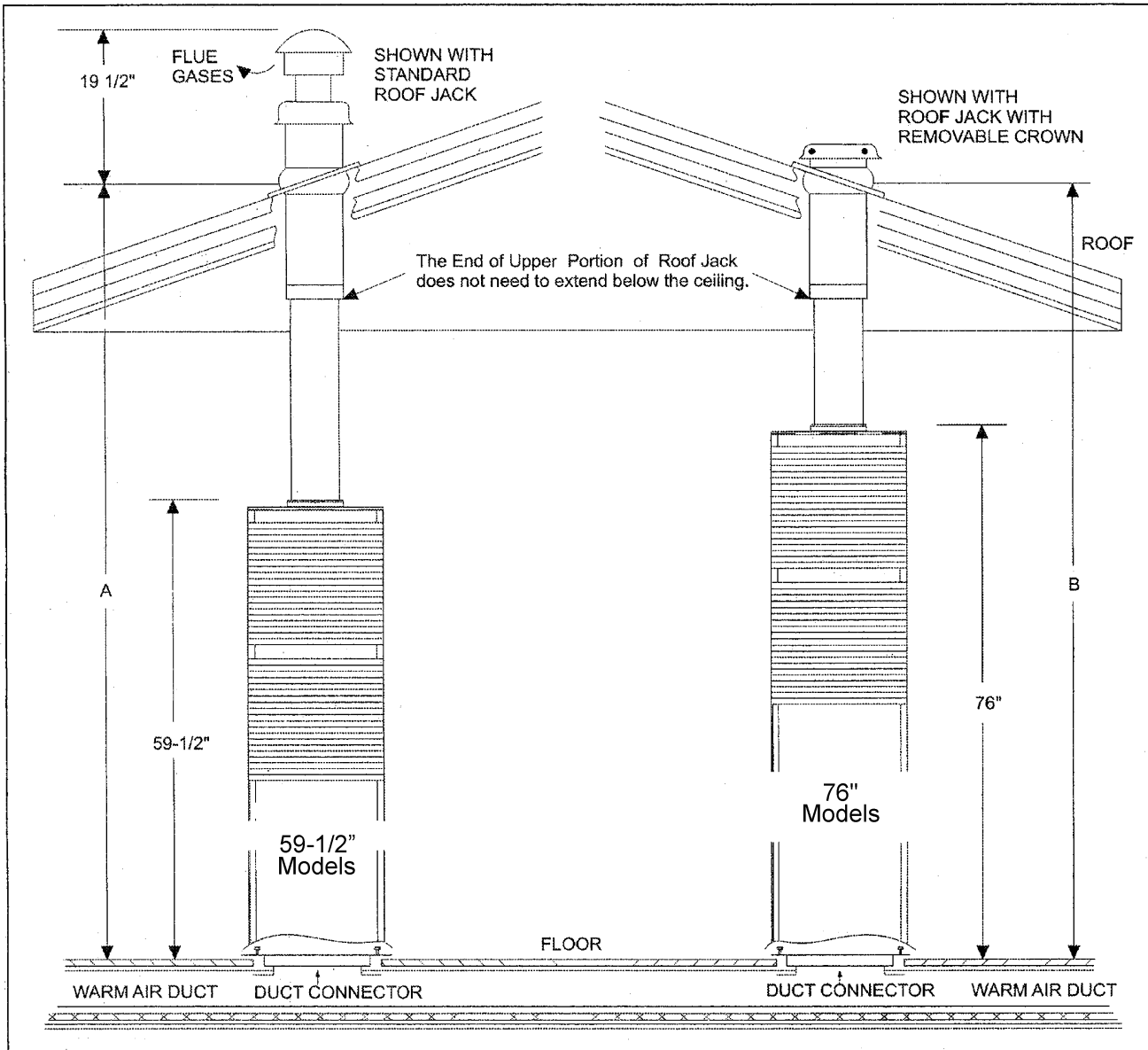



**Indoor Air Quality**

**Air Cleaners**

**TERSus Whole House 3-In-1 Air Cleaner**

- Removes Particulates (dust,smoke,pollen etc)
- UV Light disinfection removes germs, bacteria, fungi and more.
- Photocatalytic Purification removes VOC (Volatile Organic Compounds) emitted by solvents, pesticides, dyes, fuel oils etc.
- 5-Year limited warranty on parts
- User friendly and easy to maintain
- Replace (2) UV Bulbs every 12 months. LTO16 (GFI# 4564) two required
- Replace Merv 13 Filter every 6-12 months. (GFI# 4562)
- Merv 13 Filtration



Prod ID#	CSI #	Description	Price
67223	TERSus2000 (4560)	TERSus2000 3-IN-1 Premium Air Cleaner	1711.04

**High Efficiency Electronic Air Cleaners**

- Carbon Filters that remove gaseous odors
- The quietest operation compared to other brands
- Designed to fit virtually any configuration in the return air duct, and as an exact match with your Luxaire furnace
- 5-Year limited warranty on parts
- User friendly and easy to maintain
- Dual Indicator Lights show unit is operating at a glance
- Electronic Air Proving Switch automatically powers the unit during operational cycles.
- Efficiency - 1.0 to 3.0 microns



Prod ID#	CSI #	Cabinet Dimension	Duct Opening	Filter Size	Price
57853	GA50A14 (4710)	15-29/32" x 25-13/16" x 7-1/2"	13-9/16" x 24-1/8"	16" x 25" x 5"	875.23
57854	GA50A20 (4700)	20-13/16" x 25-13/16" x 7-1/2"	18" x 23-5/16"	20" x 25" x 5"	941.41

**Media Air Cleaners**

- High efficiency cartridge type
- Opti-fiber media yields high performance MERV ratings
- 10-year cabinet warranty



Prod ID#	CSI#	Dimensions (H x W x D)	MERV Rating	Minimum Avg. Efficiency	Filter Size	Price
51289	MAC1200 (4520)	16-1/4" x 25" x 5"	8	53.1	16" x 24-1/4" x 3"	177.33
51288	MAC1400 (4510)	16-1/4" x 25" x 7"	11	61.8	16" x 24-1/4" x 5"	185.39
51287	MAC2000 (4500)	20-1/4" x 25" x 7"	11	61.8	20" x 24-1/4" x 5"	185.39

**Replacement Media For MAC Media Air Cleaners**

Prod ID#	CSI#	Dimensions (H x W x D)	MERV Rating	For:	Price
32552	GF4521 (3FM1625)	16" x 25" x 3"	8	Fits MAC1200M, Trion Air Bear Cub	45.79
40055	GF4541 (6FM1625)	16" x 25" x 5"	11	MAC1400	56.26
72602	GF4551 (6FM2025)	20" x 25" x 5"	11	MAC2000 & MAC-L	51.05

Indoor Air Quality

## Indoor Air Quality

Indoor Air Quality

### AC22 Media Air Cleaners

- 10Year Warranty
- MERV 11 Microfiber media
- 97% Efficient by weight of airborne particles ranging as low as 0.01 microns
- Replacement media: 12758



Prod ID#	CSI#	Dimensions (H x W x D)	MERV Rating	Minimum Avg. Efficiency	Price
57721	AC22 (4422)	22-1/8" x 25-9/16" x 10"	11	75	380.12

### 4545 Perfect Platform Air Cleaner

- 28" Wide x 43" Long x 14.5" Tall
- 22 guage, galvanized cabinet with metal door
- 75% minimum average efficiency 1.0 to 3.0 microns. Merv 11
- Adjustable inlet duct opening: 10" or 12" x 26.5"
- Furnace Opening adjusts from 19" or 22.5" x 26.5"



Prod ID#	CSI#	Dimensions (H x W x D)	MERV Rating	Minimum Avg. Efficiency	Price
71724	GF4545	14.5" x 28" x 43"	11	75	467.93

### Air Purification

#### PC02450 VectorFlo

- Kills Germs, Bacteria and Viruses reducing the occurrences of Flu, Colds and Infections
- Reduces levels of airborne fungus and mold helping respiratory problems
- Neutralizes odors from cooking, pets, tobacco and other VOC's
- Replace Bulb (LT-50, GFI# 4884) every two years or 18,000 hours
- 5-Year Warranty



Prod ID#	CSI#	Description	Price
57417	PC02450 (4840)	50W Hybrid 18" UV Air Purifier 120V	679.13

#### GUV100A83 Air Purifier

- Kills Germs, Bacteria and Viruses reducing the occurrences of Flu, Colds and Infections
- Reduces levels of airborne fungus and mold helping respiratory problems
- Replace Bulb (LSk36, GFI# 4447) every two years or 18,000 hours
- 5-Year Ballast Warranty



Prod ID#	CSI#	Description	Price
66830	GUV100A83 (4142)	16" UV Air Purifier 120/240V	310.73

### Flow Thru Humidifiers

#### Model 570 Elite Series Humidifier w/ MHX3C Wall/Duct Mount Humidistat

- Kinetic flo
- Stainless steel valve seats
- Mounts easily on warm or return plenum
- 10-Year limited warranty
- Plenum opening 8-3/4" x 9-1/2"
- 6" Diameter bypass duct
- Replace GA10 pad once a year



Prod ID#	CSI#	Description	GPD	Unit Size	Electrical	Price
54303	570M (5705)	Flow-Through	12	11-7/8" x 13-3/8" x 9-1/2"	24V/60Hz	242.03

**Sterling Hts, MI - Livonia, MI - Lansing, MI - Grand Rapids, MI - Waterford, MI - Almont, MI - Saginaw, MI**

**Indoor Air Quality**

**Model 900 Elite Series Humidifier with manual MHX3C Wall/Duct Mount Humidistat**

- Kinetic flo
- Stainless steel valve seats
- Mounts easily on warm or return plenum
- 10-Year limited warranty
- Plenum opening 8-3/4" x 9-1/2"
- 6" Diameter bypass duct
- Replace GA19 pad once a year



Prod ID#	CSI#	Description	GPD	Unit Size	Electrical	Price
59449	900M (5725)	Flow-Through	17	12" x 16-1/2" x 10"	24V/60Hz	286.53

**Model 900 Elite Series Humidifier w/ GFX3 Digital Automatic Humidistat**

- Kinetic flo
- Stainless steel valve seats
- Mounts easily on warm or return plenum
- 10-Year limited warranty
- Plenum opening 8-3/4" W x 12" H
- 6" Diameter bypass duct
- Replace GA19 pad once a year



Prod ID#	CSI#	Description	GPD	Unit Size	Electrical	Price
54304	900A (5720)	Flow-Through	17	12" x 16-1/2" x 10"	24V/60Hz	377.01

**Model 1000 Elite Series Humidifier w/ Humidistat w/Humidistat**

- Kinetic flo
- Mounts easily on warm or return plenum
- 10-Year limited warranty
- Plenum opening 14" W x 12" H
- Stainless steel valve seats
- Replace GA19 pad once a year



Prod ID#	CSI#	Description	GPD	Unit Size	Electrical	Price
54306	1000A (5730)	Flow-Through w/Fan	18	16" x 16-1/2" x 10"	24V/60Hz	554.63
67165	1000M (5735)	Flow-Through w/Fan	18	16" x 16-1/2" x 10"	24V/60Hz	467.50

**Model 1042LH Flow-Through By-Pass Humidifier**

- No motor, fan or pump to wear out or lime up
- Manual air shutter
- Made of non-corrosive, high temperature materials
- 5-Year limited warranty
- Replace 990-13 pad once a year
- Bypass duct: 6" diameter
- Plenum opening: 10-1/4" x 9-1/2"
- Easy access to the distribution trough, drain pan & evaporative pad
- Reversible installation



Prod ID#	CSI#	Description	GPD	Unit Size	Electrical	Price
15727	1042LH (5144)	Flow -Through	17	15" x 11-1/2" x 9"	24V/60Hz	268.08

**Model 1099LHS Flow-Through By-pass Humidifier**

- Manual air shutter
- No motor, fan or pump to wear out or lime up
- 5-Year limited warranty
- Replace GA23 pad once a year
- Plenum opening: 13-1/4" x 9-1/4"
- Bypass duct: 7" diameter
- Reversible installation



Prod ID#	CSI#	Description	GPD	Unit Size	Electrical	Price
280	1099LHS (5015)	Flow-Through	19	16" x 16" x 11"	24V/60Hz	322.71

Indoor Air Quality

## Indoor Air Quality

### Replacement Media

#### Replacement Evaporator Pads

- Aluminum evaporator material enclosed in heavy wire frame and channeling
- Pad has super absorbent coating



Prod ID#	CSI#	Description	Price
1294	GA10 (7900)	Evap Pad for Elite 570 and Aprilaire 110,220,550, & 558 and Honeywell HE220, HE225, & Gen 570	23.17
54320	GA19 (7919)	Evaporator Pad for Elite Model 900 & 1000	26.48
310	990-13 (7002)	Evaporator Pad for Model 1042LH, 1137, SL16 (9-3/4"W x 11-3/4"H)	29.45
322	1099-20 (7047)	Evaporator Pad for Model 1099LH (14-1/4"W x 12"H)	38.05

### Drum-Type Humidifiers

#### Model 81 Drum Type Power Humidifiers

- Easy open cover for convenient service
- Fits any forced warm air furnace
- Exceptional impact & high temperature resistant cabinet
- Easy slide out water pan
- MXH3 Manual Humidistat included
- Plenum opening: 8"W x 7-1/2"H
- Powered by an economical 3 watt motor
- Corrosion resistant, anodized aluminum cover
- 1-Year Warranty

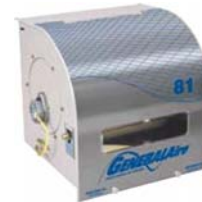

Prod ID#	CSI#	Description	GPD	Unit Size	Electrical	Price
56492	GF81 (5048)	Low Voltage Drum Type	16.0	12"W x 11-1/2"H x 11"D	24V	359.01

### Steam Humidifiers

#### DS15/25 Elite Steam Humidifiers With DMNKIT Duct Mount Kit

- Comes with DMNKIT - Duct Mount Kit
- Duct mount, room mount, remote mount
- Self contained immersed electrode design
- High water level & foam detection monitoring
- Drain tempering
- 20% Adjustable capacity from rated max output
- Integrated AHU fan relay for on demand humidification
- GFX3 Digital automatic humidistat
- 5 Year Warranty



Prod ID#	CSI#	Description	Steam Output	Unit Size	Electrical	Price
79191	DS15w/DMNK-5578	15 Gal Steam Humid	15.8 GPD	13-1/8" W x 23-3/4" H x 8-1/4" D	230V 50/60Hz	1221.02
78990	DS25w/DMNK-5574	25 Gal Steam Humid	25-35 GPD	13-1/8" W x 23-3/4" H x 8-1/4" D	230V 50/60Hz	1505.64

Indoor Air Quality

**Indoor Air Quality**

**DS-15 / DS25 Elite Steam Humidifiers**

- Requires Installation Kit
- Duct mount, room mount, remote mount
- Self contained immersed electrode design
- High water level & foam detection monitoring
- Drain tempering
- 20% Adjustable capacity from rated max output
- Integrated AHU fan relay for on demand humidification
- GFX3 Digital automatic humidistat
- 5 Year Warranty



Prod ID#	CSI#	Description	Steam Output	Unit Size	Electrical	Price
63200	DS25 (5524)	25 Gal Steam Humid	25-35 GPD	13-1/8" W x 23-3/4" H x 8-1/4" D	230V 50/60Hz	1075.10
59806	DS25LC (5527)	25 Gal Steam Humid Low Cond.	25-35 GPD	13-1/8" W x 23-3/4" H x 8-1/4" D	230V 50/60Hz	1075.09

**DS-25/15 Duct Mount Kit**

- Includes:
  - 8' Steam hose
  - 9' Condensate hose
  - Water line fill connector
  - GFX3 Digital humidistat
  - Code valve
  - Water supply tubing kit
  - Air proving pressure switch



Prod ID#	CSI#	Description	Price
54759	DMNKIT (7525)	Duct Mount Kit For DS15P, DS25 & DS25LC	515.25

**Replacement Cylinders**

35-14



35-15



Prod ID#	CSI#	Description	Price
62147	15-14 (7523)	Replacement Steam Cylinder DS15 & RS15	196.91
55728	35-14 (7524)	Replacement Steam Cylinder DS25/RS25/DS35/RS35	196.91
58646	35-15 (7543)	Low Conductivity Repl. Steam Cylinder DS25LC RS35LC	246.14

**Humidistats**

**Digital Humidistats**

- Outdoor temperature compensating feature
- Operates in manual or automatic mode
- Adjustable calibration
- Wall or duct mount
- Large digital display
- Humidifier operation indicator



Prod ID#	CSI#	Description	Price
53615	GFX3 (7050)	Automatic Digital Humidistat	213.55

Indoor Air Quality

Indoor Air Quality

WALL MOUNT HUMIDISTAT



MHX3C



WMH3

Prod ID#	CSI#	Description	Price
66288	MHX3C (7038)	Wall/Duct Mount Humidistat	66.92
66295	WMH3 (7053)	Wall Mount Housing for MHX3 Stat	23.85

General Filters Replacement Parts



727-40

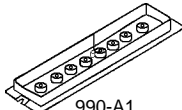

990-A1

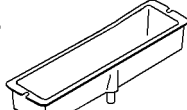

990-2



990-37-76

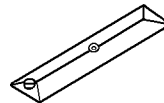

990-38A

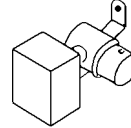

990-52/990-53

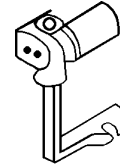

1137-17

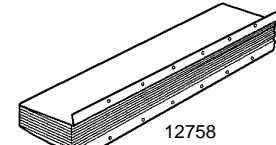

12758

Prod ID#	CSI#	Description	Price
284	65-5 (7312)	Replacement Evaporator Sleeve for GF65	25.33
285	81-4 (7092)	Water Pan f/81 Series	30.83
286	81-15 (7099)	Repl Evap Sleeve for Gen 81, 90, 91, WA1, AD1	28.36
287	81-21 (7096)	Float Valve Assembly, Contains: Valve Washer, Splash Guard, Valve Shield, Orifice Fitting, Valve Seat, Cotter Pin, Float Arm, Float, Orifice Nut	39.86
288	81-22 (7104)	Drum Assembly for Model 81	55.30
291	727-12 (7107)	727 / 747 Evaporator Pad	34.25
295	727-40 (7113)	Motor Assembly 45 / 65 / 81 / 727	65.60
296	727-58 (7118)	24V Transformer (12VA)	33.42
307	975-1 (6004)	Valve Seat	1.41
315	990-37-76 (7008)	Orifice & Strainer Assembly (Standard Water Pressure 40 - 120 psi) 1040	21.49
314	990-53 (7014)	1042, LH, 1040 Valve Assembly - for 1042 (Includes Fittings), 24 Volt and for 709	101.42
21129	1042-5 (7364)	Distributor Tube 1042, -L, -LH	29.20
23095	1099-12 (7045)	Distributor Tube for 1099 & 1099-L/LH	29.20
325	1099-42 (7052)	24V Solenoid Valve Assembly f/1099, LH	117.12
321	1099-9 (7043)	Thumb Nut for All Legacy Flo-Through Models	6.16
18627	1137-3 (7347)	Drain Pan for 1137/1042/1042 LH	53.69
21211	1137-4 (7333)	Distribution Trough for 1137 & 1042	50.70
43386	16-20 (7604)	Solenoid Valve Assembly for SL-16	110.46
35125	1042-3 (7358)	Damper Assembly f/1042	23.77
172	12758 (4001)	Glass Microfiber Filter Media For AC1/AC3/AC22 MERV11	63.49
326	12853 (7302)	Drum Assembly f/Model 65	53.58
1295	GA12 (7901)	Repl Media for Aprilaire Models 112, 136, 224, 440 & 445	29.80
54321	GA23 (7923)	Evaporator Pad for Elite Model 950 & 1099LHS	28.14
21200	GA35 (7902)	Repl Media for Aprilaire Models 350,360,560,568,600,700,760,768 & Honeywell Models HE260,HE265,HE360, & HE365	29.80
24272	GA50 (7026)	24V Current Sensing Relay for Elite Flow Through	42.47
384	P188 (7157)	Retainer Clip f/ Model 65, 81, 747, 747L	5.01
56756	GA4040 (7221)	7221 Solenoid Valve, 24V, Fits Aprilaire and GeneralAire 570,900,950,hu12,hu17, & 1099LHS	93.48
55785	GA4238 (7586)	7586 Relay Circuit Board for 1000 & 1137	97.77
62147	GF7523 (15-14)	15-14 Repl Steam Cyl DS15/RS15	196.91

Indoor Air Quality

**Indoor Air Quality**

**HRV Heat Recovery Ventilator**

- Warranty: 5yr Electronic - 10yr Motor - Limited Lifetime Core
- 30 to 160 CFM
- 120v 1.5amp
- Cross-Flow Polypropylene Heat Exchanger



Prod ID#	CSI#	Description	Price
61070	8160 HRV (4660)	8160 GeneralAire HRV 30-160 CFM	1442.57

**Fuel Oil Replacement Cartridges**

- 10 Micron wool felt
- Center core bonded to prevent media migration



Prod ID#	CSI#	Description	Price
1883	1A30 (2000)	Wool Felt - for Filter 1A-25A 10GPH Firing Rate	7.24



**GPS by Nu-Calgon IAQ Purifiers**

- High-output ion generatora
- Treats air in residential duct system
- Positive and Negative ions actively purify the supply air
- Kills Mold, Bacteria and Viruses



Prod ID#	CSI#	Description	Price
75740	4900-20	iWave-R Self Cleaning ion generating Air Purifier	759.49
78006	4900-35	iWave-M ion generating Air Purifier	442.81
75741	4900-40	iWave-V ion generating Air Purifier	625.81

**We Welcome the Opportunity to Answer Your Questions Regarding Any Products You Require.**

Indoor Air Quality

**Indoor Air Quality**

Indoor Air Quality



**Healthy Home System Control Plus**

- Intellegently manages the central fan, allowing the Fresh Air Damper
- to provide FRESH air in the home all year round
- Durable, Stainless steel construction
- Remains closed when fresh air is not needed
- MUST purchase an intake hood seperately



Prod ID#	CSI#	Description	Price
63510	FAS-6	Fresh Air System Control & Damper 6" 24V	386.12

**Make Up Air**

- No Electricity required
- Easy to read airflow guage
- Adjustable Gate provides percise airflow control
- Intake Air Hood Included



Prod ID#	CSI#	Description	Price
67891	MAS-1	6" Fresh Air/Make-Up Damper Kit	151.98

**Media Air Cleaners**

- Use 5" Wide Filter
- Meets ANSI/ASHRAE 52.2 standards
- Easy Installation and media replacement
- Captures particles as small as 1.0 Microns Including pollen, dust, mold and dander.

FC8



FCRA-2000



Prod ID#	CSI#	Description	Price
67894	FC8-1625HS	16"x25"x5" Merv 8 Media Air Cleaner	184.75
67892	FC8-2025HS	20"x25"x5" Merv 8 Media Air Cleaner	190.95
67890	FCRA11-2025	20"x25"x5" Merv 11 Right Angle Media Air Cleaner	293.96
77549	HW8-1625PDG4	16"x25"x5" Merv 8 Plain Galv Media Air Cleaner	145.64

**Replacement Media Filters**

Prod ID#	CSI#	Description	Price
73006	46568600	20"x25"x5" Merv 11 Replacement Media Filter	64.32

**UV16 Compact Remote In-Duct Model**

- Includes an aluminized reflector panel
- 16" UV Germicidal lamp kills airborne mold, bacteria, viruses & fungi
- Built-in safety switch
- Minimum Duct Width 16



Prod ID#	CSI#	Control Size	Voltage	Amps	Watts	Max Sq Ft	Price
53807	UV-16/120	120	120	0.5	30	2000	331.60



**Indoor Air Quality**

**UV-AIRE™ Replacement Lamps**

Prod ID#	CSI#	Description	Price
41842	46365401	UV12 Replacement Lamps	109.75
41843	46365402	UV18 Replacement Lamps	126.03
53999	46511200	UV16 Replacement Lamps	120.63

**PCUV-16UA Optional PRO-Cell Upgrade Assembly**

- 3,110 sq. inch PRO-Cell Surface Area
- 1.5 to 5 Tons
- 93.7% Bioaerosol & VOC Reduction
- .02 in WC @ 2000cfm
- Upgrades the UV-16

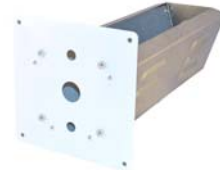

Prod ID#	CSI#	Description	Price
72682	PCUV-16UA	PRO-Cell 16" UV Upgrade Assembly	316.29

**Aprilaire®**

**Air Cleaners - Spaceguard/Aprilaire**

- Renewed performance when replaced regularly
- Individually packaged with complete instructions
- MERV 10



Prod ID#	CSI#	Fits Models	Price
687	SG201	2200 & 2250 MERV 10	67.62
27878	SG401	2400 MERV 10	65.91
44105	SG501	5000 MERV 10	92.45

**Water Panels**

**Evaporator Pad Replacements**

- Provide like-new performance to all Aprilaire® humidifiers when replaced regularly
- Individually packaged with complete instructions



Prod ID#	CSI#	Fits Models	Price
54426	AA10	10,220,550,570	23.93
54466	AA12	112,224,440,445,136	41.02
54427	AA35	350,360,560,600,700,760	31.91

**Generic Evaporator Pad Replacements**

- Provide like-new performance to humidifiers when replaced regularly



Prod ID#	CSI#	Fits Models	Price
76678	S1-HUPAD10	10,220,550,570	20.51
76744	S1-HUPAD35	350,360,560,600,700,760	27.35

Indoor Air Quality

## Indoor Air Quality

### F300 Air Cleaner Accessories

#### PreFilters

Prod ID#	CSI#	Description	Price
2163	203371	16" Prefilter for F50A, E, & F300	76.94
2164	203372	20" Prefilter for F50A, E, & F300	76.94

### BestAIR Pro

### Lobb Humidifier Parts & Accessories

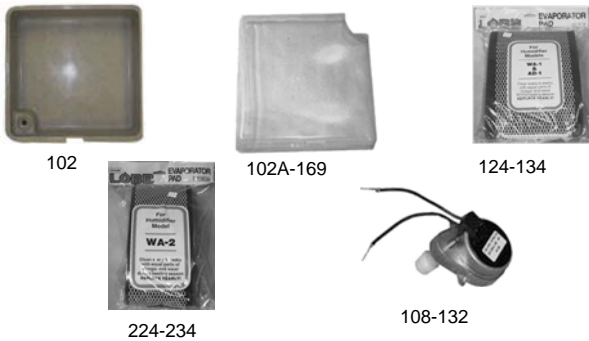

Prod ID#	CSI#	Description	Price
356	LOB102A/169	WA-1 Pan Liner	18.73
358	LOB104	WA-1 Pan Clips	10.83
359	LOB108/132	Motor Kit (All Models)	74.15
362	LOB124/134	WA-1/WA-2700 Evap Pad	30.82
365	LOB188/191	Univ Float Valve Assembly	49.43
371	LOB224/234	WA-2/WA-1700 Evap Pad	38.52
21077	LOB424	Evaporator Pad For FT-20	56.50
32937	LOB826	Solenoid- Water Saver/FT20	112.99
70971	UHS24	Universal Humidifier Solenoid	89.02

### Model 200P Parts

- Drum type by-pass
- Made of stainless steel for durability & longevity
- Can be used with any forced air furnace & is ideal for most of today's new homes

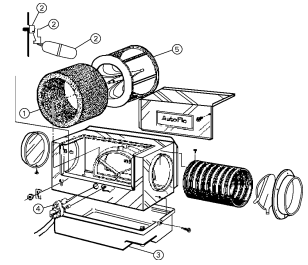

### Model 200P Replacement Parts

Prod ID#	CSI#	Description	Price
243	200EP	Evaporator Pad Also for 800BP	44.08
365	LOB188/191	Complete Float/Orifice Assembly Also for #40	49.43
250	20028	Motor Assembly Also for 400BP - Phase Out	93.99

### Model 250 Parts

- High capacity flow thru
- Can be used with any forced air furnace & mounted on either the warm air supply or the cold air return

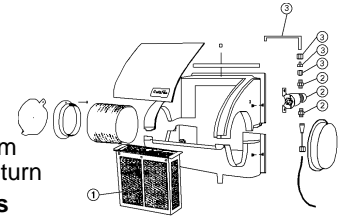

### Model 250 Replacement Parts

Prod ID#	CSI#	Description	Price
241	40EP	Evaporator Pad	41.20
251	25019	Complete Solenoid Assembly	114.62
62200	401839	40 EP Frame - Phase Out	29.06

### Model 400BP & 400BPR Replacement Parts



Prod ID#	CSI#	Description	Price
244	450EP	Evaporator Pad - Phase Out	26.23

### Model SC-15 Parts

- "Revolutionary" design requires only one plenum hole to be cut into your duct work, most require two

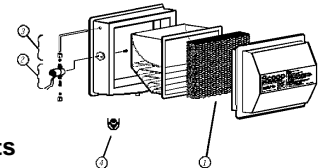

### Model SC-15 Replacement Parts

Prod ID#	CSI#	Description	Price
20013	SCEP	1. Evaporator Pad	32.51

## autoflo®

### Humidifier Replacement Parts

#### Model 97 Parts

- Drum type by-pass
- Will work with any forced air furnace & assures trouble-free performance

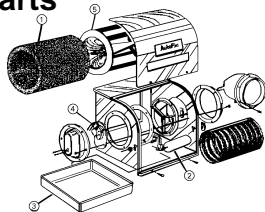

#### Model 97 Replacement Parts

Prod ID#	CSI#	Description	Price
242	97EP	Evaporator Pad	28.43
365	LOB188/191	Complete Float/Orifice Assembly	49.43
266	800018	Water Pan - Phase Out	35.44

**Indoor Air Quality**

**Skuttle Accessories**

**Model 216 Self-Adjusting Barometric Make-Up Air Controls**

- Reduces Drafts & Uncontrolled air infiltration to provide year-round comfort
- Combats interior air pollution
- Improves furnace efficiency
- Durable, corrosion-resistant stainless steel construction
- Includes 6" inlet hood



Prod ID#	CSI#	Description	Price
399	216-2	6" Make-Up-Air	166.61
398	216-1	4" Make-Up-Air w/6"x4" Reduc	159.37

**A50 Interface Relay for Humidifiers & HVAC Equipment**

- Controls Electrically-Activated Humidifiers Make-Up Air Controls, Zone Damper & EACs



Prod ID#	CSI#	Description	Price
24272	GA50	24V Current Sensing Relay	42.47

**Humidifier Replacement Media**

Prod ID#	CSI#	For Model #'s:	Price
403	A041725033	45	21.91
404	A041725034	90, H-100, 109, 190	26.60
24387	A041725051	2001, 2101, 2102, 2002 w/Wick	41.02
28458	A041725052	2000, 2100 w/Wick	33.70

**Solenoid Valves**

- Universal 24V



Prod ID#	CSI#	Description	Price
34463	A010814148	Universal 24 Volt Valve Kit fits Skuttle 24VAC Units & Most Other Manufacturers	111.34

**Drum Assemblies**

- Drum & media



Prod ID#	CSI#	Description	Price
400	A011722018	For 45-SH-1	91.81

**Floats**



Prod ID#	CSI#	Description	Price
46294	A171731013	Float Valve Assy	62.69

**Water Pans**



Prod ID#	CSI#	Description	Price
507	A000602041	Water Pan f/Models 90 & 190	55.66

**TRION®**  
air purification systems

**Media Air Cleaners**

**Air Bear® Supreme 2000**

- MERV 8 rating
- Low air resistance
- 10-year limited warranty on cabinet
- 2000 CFM



Prod ID#	CSI#	Outside Size (in)	Price
29704	AIRBEAR	20-1/4"H x 24-7/8"D x 7-1/8"W	197.61

**Air Bear Media Filters - Merv 8**

Prod ID#	CSI#	Use For:	Price
67117	255649-101	16" x 25" x 3" Air Bear®	47.72
67118	255649-105	26" x 25" x 5" Air Bear®	48.15
29772	255649-102	20" x 25" x 5" Air Bear®	48.15

**Trion Parts & Accessories**

Prod ID#	CSI#	Description	Price
33347	G2066	Replacement Water Filter G206	44.78



Indoor Air Quality

**Indoor Air Quality**

Indoor Air Quality

**Standard Capacity Pleated Filters**

- Heavy Duty Beverage-Board Grade
- Moisture resistant Media
- UL Class 90



**1" MERV 8**

Prod ID#	CSI#	Size	Price
66469	10.24.1PF	10" x 24" x 1"	13.67
69106	12.20.1PF	12" x 20" x 1"	14.54
52814	14.20.1PF	14" x 20" x 1"	11.13
46908	14.24.1PF	14" x 24" x 1"	15.73
51985	14.25.1PF	14" x 25" x 1"	12.02
33721	16.20.1PF	16" x 20" x 1"	9.82
44934	16.24.1PF	16" x 24" x 1"	14.59
29625	16.25.1PF	16" x 25" x 1"	10.50
69992	18.24.1PF	18" x 24" x 1"	15.56
36978	20.20.1PF	20" x 20" x 1"	10.45
57935	20.24.1PF	20" x 24" x 1"	16.04
33722	20.25.1PF	20" x 25" x 1"	12.23
60448	24.24.1PF	24" x 24" x 1"	16.44
33723	25.25.1PF	25" x 25" x 1"	19.96

**2" MERV 8**

Prod ID#	CSI#	Size	Price
73954	14.14.2PF	14" x 14" x 2"	33.71
60632	14.20.2PF	14" x 20" x 2"	13.27
63451	14.25.2PF	14" x 25" x 2"	15.09
68401	15.20.2PF	15" x 20" x 2"	13.32
66461	16.16.2PF	16" x 16" x 2"	15.87
35128	16.20.2PF	16" x 20" x 2"	10.11
61174	16.24.2PF	16" x 24" x 2"	14.82
24915	16.25.2PF	16" x 25" x 2"	11.41
70942	16.30.2PF	16" x 30" x 2"	62.26
68722	18.18.2PF	18" x 18" x 2"	15.17
73721	18.20.2PF	18" x 20" x 2"	17.39
59549	18.24.2PF	18" x 24" x 2"	16.00
35127	20.20.2PF	20" x 20" x 2"	11.36
63060	20.24.2PF	20" x 24" x 2"	15.97
29324	20.25.2PF	20" x 25" x 2"	13.29
63452	20.30.2PF	20" x 30" x 2"	19.52
46447	24.24.2PF	24" x 24" x 2"	15.12

**4" MERV 8**

Prod ID#	CSI#	Size	Price
9742	16.25.4PF	16" x 25" x 4"	24.85
9743	20.25.4PF	20" x 25" x 4"	27.73
43535	24.24.4PF	24" x 24" x 4"	30.09

**Disposable Panel Filters**

- Economic disposable panel "Furnace" filter
- Many other sizes available - call for price & delivery
- Residential & commercial applications
- Polyester
- MERV 5 UL Class 2



**1" & 2" POLY Throw Away Filters**

Prod ID#	CSI#	Size	Price
70357	12.20.1Poly	12" x 20" x 1"	5.83
65066	14.20.1Poly	14" x 20" x 1"	6.31
65985	14.24.1Poly	14" x 24" x 1"	8.19
65067	14.25.1Poly	14" x 25" x 1"	6.02
71881	15.20.1Poly	15" x 20" x 1"	7.22
65068	16.20.1Poly	16" x 20" x 1"	5.99
71882	16.24.1Poly	16" x 24" x 1"	8.67
65069	16.25.1Poly	16" x 25" x 1"	6.42
71883	18.20.1Poly	18" x 20" x 1"	7.70
65070	20.20.1Poly	20" x 20" x 1"	6.42
70360	20.24.1Poly	20" x 24" x 1"	7.85
65071	20.25.1Poly	20" x 25" x 1"	7.17
70561	20.30.1Poly	20" x 30" x 1"	9.24
71884	25.25.1Poly	25" x 25" x 1"	9.84
70354	12.24.2Poly	12" x 24" x 2"	9.44
66965	14.20.2Poly	14" x 20" x 2"	10.49
65180	14.25.2Poly	14" x 25" x 2"	10.49
70358	15.20.2Poly	15" x 20" x 2"	9.29
65072	16.20.2Poly	16" x 20" x 2"	10.33
71885	16.24.2Poly	16" x 24" x 2"	10.69
65073	16.25.2Poly	16" x 25" x 2"	10.81
70359	18.24.2Poly	18" x 24" x 2"	11.13
65074	20.20.2Poly	20" x 20" x 2"	10.81
65075	20.25.2Poly	20" x 25" x 2"	11.72
70353	20.30.2Poly	20" x 30" x 2"	39.34
73579	24.24.2Poly	24" x 24" x 2"	12.25
66966	25.25.2Poly	25" x 25" x 2"	11.99

**1" Thick Throw aways ON PHASE OUT**

Prod ID#	CSI#	Size	Price
1688	25.25.1F	25" x 25"	7.55

**2" Thick Throw aways ON PHASE OUT**

Prod ID#	CSI#	Size	Price
31966	12.24.2F	12" x 24"	8.30
31967	14.25.2F	14" x 25"	7.47
1690	16.25.2F	16" x 25"	8.03

**Indoor Air Quality**

**2" Thick Throw aways ON PHASE OUT (Continued)**

Prod ID#	CSI#	Size	Price
31971	18.24.2F	18" x 24"	7.32
1691	20.20.2F	20" x 20"	8.13
1693	20.25.2F	20" x 25"	8.95
50571	20.30.2F	20" x 30"	31.54

**Air Cleaner Replacement Media**

Prod ID#	CSI#	Size	Price
32552	GF4521	Rpl Media Filt 16X25X3 MERV 8	45.79
40055	GF4541	Rpl Media Filt 16X25X5 MERV 11	56.26
72602	GF4551	Rpl Media Filt 20X25X5 MERV 11	51.05
47550	SGMPR	RPL Filt #2200,AC-1,31MF MERV11	79.76
59663	SG6202511	Space Guard 20X25X6 MERV 8	73.85
78520	GF4365	Honeywell 16"x20"x5" MERV 11	62.36
78521	GF4366	Honeywell 16"x25"x5" MERV 11	56.26
78518	GF4368	Honeywell 20"x25"x5" MERV 11	57.56
25011	WR51626-8	16" For WR F825-0548 MERV 8	51.83
25012	WR52026-8	20" For WR F825-0549 MERV 8	51.83

**Permalast® Precut Filter**

- Rigid, Self Supporting
- Washable
- Extra Heavy Weight Polyester Fiber



Prod ID#	CSI#	Size	Price
2477	01810104	20" x 25" x 1" Precut Filter	16.85

You are only a click away from seeing pricing and availability at [www.CalverleySupply.com](http://www.CalverleySupply.com)

**Proudly Serving You from 7 Convenient Michigan Locations**



**Almont**

**Grand Rapids**

**Lansing**

**Livonia**

**Saginaw**

**Sterling Heights**

**Waterford**

Indoor Air Quality

Residential Thermostats / Zoning

Indoor Air Quality

**TrueZONE® Panels**

**HZ322 TrueZONE® Zone Control for Conventional & Heat Pump Applications Up to (3) Zones**

- Intuitive installer setup, digital display uses real language to guide installer through (4) easy steps
- Controls up to 2 heat/2 cool conventional or 2 heat/1 cool heat pump
- Standard checkout procedure
- Robust push terminals
- Common sense LEDs
- Variable-speed fan control
- RedLINK™ enabled for wireless operation when used with THM4000R1000 wireless adapter (sold separately)
- 5-Year limited warranty



Part #	Mfg #	Description	Price
78279	HZ322/U	Panel for Conventional & Heat Pump Applications up to (3) Zones (2 Heat/2 Cool), RedLink	500.91

**Zone Control Dampers**

**TrueZONE® ARDTZ Automatic Round Damper**

- Direct replacement for today's legacy dampers
- Open and close lights and visual position indicator for quick setup and diagnostics
- Push terminals and easy wiring to Honeywell® TrueZONE® panel
- Adjustable range stops



Part #	Mfg #	Size	Price
78283	ARD6TZ/U	6"	345.12
77193	ARD8TZ/U	8"	357.09
78284	ARD10TZ/U	10"	366.59
78427	ARD12TZ/U	12"	383.68

**TrueZONE® ZD Damper**

- Power close, spring open
- 24V Spring-return motor used to control circulating air in HV systems
- Used when a normally open damper is required, typically used with the TrueZONE® systems and other electronic zoning damper systems
- Adjustable range stops
- Solid construction using extruded aluminum frame and blades
- Parallel blade design for low leakage performance
- Optional LED indicator wire (sold separately)



Part #	Mfg #	Size	Shape	Motor Mount	Price
78596	ZD8X10TZ/U	8" x 10"	Rectangular	Side	447.24
78594	ZD8X12TZ/U	8" x 12"	Rectangular	Side	464.43
78429	ZD8X14TZ/U	8" x 14"	Rectangular	Side	471.35
78430	ZD8X16TZ/U	8" x 16"	Rectangular	Side	476.58
78595	ZD8X18TZ/U	8" x 18"	Rectangular	Side	485.16
78431	ZD8X20TZ/U	8" x 20"	Rectangular	Side	492.12
77815	ZD10X16TZ/U	10" x 16"	Rectangular	Side	509.35
77817	ZD10X20TZ/U	10" x 20"	Rectangular	Side	530.07
78597	ZD12X8TZ/U	12" x 8"	Rectangular	Side	464.43
78282	ZD16X8TZ/U	16" x 8"	Rectangular	Side	476.58

**Sterling Hts, MI - Livonia, MI - Lansing, MI - Grand Rapids, MI - Waterford, MI - Almont, MI - Saginaw, MI**

**Indoor Air Quality**

**DuroZone Systems**

**SMZ Series Panels**



Prod ID#	CSI#	Description	Price
34640	SMZ2SW	2-Zone Control Panel	327.38

**Digital Panels**

- Built in Circuit Breaker



Prod ID#	CSI#	Description	Price
49700	RED4	4-Zone Digital Panel	440.00

**Multi-Blade Zoning Dampers**

- Non-motor side x motor side dimensions
- Durable extruded aluminum
- Custom size dampers can be made up to 500 sq in
- Power Open / Power Closed
- Opposed Blade Operating Design



Prod ID#	CSI#	Size	Mount	Price
39097	8.8BMD	8" x 8"	Side/Bottom	345.70
35185	10IN.8SMD	10" x 8"	Side	345.70
35186	12IN.8SMD	12" x 8"	Side	377.14
35187	14IN.8SMD	14" x 8"	Side	377.14
35188	16IN.8SMD	16" x 8"	Side	377.14
35190	20IN.8SMD	20" x 8"	Side	405.95
35191	24IN.8SMD	24" x 8"	Side	447.85
35192	8.10INBMD	8" x 10"	Bottom	345.70
35193	8.12INBMD	8" x 12"	Bottom	377.14
35194	8.14INBMD	8" x 14"	Bottom	377.14
35218	8.16INBMD	8" x 16"	Bottom	377.14
35219	8.18INBMD	8" x 18"	Bottom	405.95
35220	8.20INBMD	8" x 20"	Bottom	405.95
35221	8.24INBMD	8" x 24"	Bottom	447.85
42708	10IN.20INBMD	10" x 20"	Bottom	447.85
36925	10IN.24INBMD	10" x 24"	Bottom	476.66

**Replacement Damper Motors**



Prod ID#	CSI#	Description	Price
35362	RMMB	For Type MB Dampers	180.72
73780	RM-PMB	For Type PMB Dampers	191.18

**Round Zone Dampers**

- Galvanized Steel Construction
- High-Torque Motor
- Low Leakage, Single Blade Design



Prod ID#	CSI#	Nom Dia	Nom Length	Price
37942	RD6	6"	9"	311.65
34567	RD8	8"	9"	332.61
48651	RD10	10"	9"	358.80

**24V Spring Return Round**

- Shipped spring closed
- Reversible motor for spring open operation
- Gasketing Included for High Integrity Seal



Prod ID#	CSI#	Voltage	Size	Price
35222	NSPRD024-6	24	6"	343.09

**Round Pressure Relief Dampers**

- Plated steel counterbalance rod & weight
- Sintered bronze oil impregnated bushings
- Thumb screw adjustment
- Galvanized steel



Prod ID#	CSI#	Model	Nom Dia	Bypass @ 1200 FPM	Price
36303	DDR8	DDR-8	8"	400 CFM	240.94
39707	DDR10	DDR-10	10"	650 CFM	240.94
35223	DDR12	DDR-12	12"	950 CFM	240.94

**Sensors**



Prod ID#	CSI#	Description	Price
35239	FPS	Freeze Protection Sensor	77.84
50494	LAT	Supply Air Temp Sensor	94.28

**Thank You for Using this Catalog  
as Your Reference to Our  
Broad Line of Products.**



Indoor Air Quality

**Zoning**

Indoor Air Quality



**AirBoss™ Panels**

- Exceptional compatibility with both single and 2-stage systems and with virtually all 24VAC thermostats
- Built-in fossil fuel kit
- Leaving air temperature (LAT) controls
- KnowItAll™ panel which quickly lets you identify the status of each zone
- Enhanced energy conservation program
- Easy heat pump programming
- Fan control and convenient 45° angled terminal blocks for ease of installation



Prod ID#	CSI#	Description	Price
70103	PAN-AB003	3-Zone	1279.65

**HeatPumPro™ Zone Panels**

- Provides features and controls needed for any heat pump, furnace or A/C, suited for variable speed equipment
- Menu driven "Set-up Wizard"
- Displays all operation at a glance
- Works with standard 4-wire thermostats
- Pro-Active Staging with outdoor reset
- Dual fuel control
- Leaving air temperature (LAT) and outdoor sensor included
- Modulating bypass port



Prod ID#	CSI#	Description	Price
70059	PAN-HPP02	2-Zone	1054.49
70061	PAN-HPP03	3-Zone	1204.23
70105	PAN-HPP04	4-Zone	1326.79

**MPS Series Zone Panels**

- Compatible on single stage, dual fuel, heat pump, or high velocity equipment
- Compatible with any standard 24vac thermostat
- Additional zones may be added
- Used for single stage equipment only



Prod ID#	CSI#	Description	Price
71822	PAN-00202	2-Zone	853.15
71847	PAN-00203	3-Zone	1012.85

**Modulating Bypass Kits**

- Adjust pressure range .05"wc to 1.0"wc
- True damper modulation
- Provides the most stable static pressure environment
- Eliminates the hunting effect associated with variable speed ECM blowers



Prod ID#	CSI#	Description	Price
70077	MOD-BYP08	8" Round	443.44
70078	MOD-BYP10	10" Round	519.60

**RegiDamper™ Dampers**

- Easily retrofit damper installation in difficult situations such as hidden ductwork, finished basements or ductboard applications
- By using plenum rated tubing, the airline is fished back thru the ductwork. Damper slips easily into register boot.

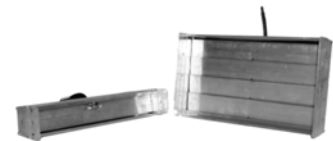

Prod ID#	CSI#	Size	Price
70248	REG-4X10	4" x 10"	206.04

**EZFIT Damper**

- Available in 5", 6" and 7"
- Mix and match with other dampers
- Creates less turbulence in the boot
- Fits easily in boot-end, angled or straight or any type of metal duct work: horizontal or vertical



Prod ID#	CSI#	Size	Price
70455	STK-EZFT6	6"	296.77

Shaded items are Non-Stock special order and subject to freight.

**Sterling Hts, MI - Livonia, MI - Lansing, MI - Grand Rapids, MI - Waterford, MI - Almont, MI - Saginaw, MI**



**Zoning**

**Inserta® Dampers**

- For counterflow slab applications or metal, clay-tile, or poly duct systems
- Spring-loaded bellyband for any type of round duct
- Mounts inside round duct take-offs and is held in place by internal damper clamp
- Uses plenum rated air tubing
- Can be used with other Arzel dampers

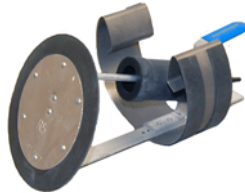

Prod ID#	CSI#	Size	Price
70076	INSRT-6	6"	264.78

**Static Pressure Barometric Dampers**

- Weighted arm barometric
- Best used with a ducted return



Prod ID#	CSI#	Description	Price
70079	SPD-R0008	8" Round	178.20
70080	SPD-R0010	10" Round	185.60

**EzySlide® Dampers**

- Includes template to easily install on duct

**EzySlide® R-Series Round Damper**

- Unique motorless design
- Inserts into existing ductwork for retrofit applications
- Operates on low pressure air



Prod ID#	CSI#	Size	Price
70064	STK-ER0005	5"	106.39
70113	STK-ER0006	6"	106.39
70114	STK-ER0007	7"	122.36
70115	STK-ER0008	8"	129.28

**EzySlide® Rectangular Bottom-Mount Damper**

- Easy to install into existing duct work
- Unique motorless design
- Operates on low pressure air



Prod ID#	CSI#	Size	Price
70065	STKSB-E 8X10	8" x 10"	214.29
70066	STKSB-E 8X12	8" x 12"	222.20
70067	STKSB-E 8X14	8" x 14"	233.22
70068	STKSB-E 8X16	8" x 16"	239.51
70069	STKSB-E 8X20	8" x 20"	252.09

**EzySlide® Rectangular Bottom-Mount Damper (Continued)**

Prod ID#	CSI#	Size	Price
70070	STKSB-E 8X24	8" x 24"	267.89

**EzySlide® Rectangular Side-Mount Damper**

- Easy to install into existing duct work
- Unique motorless design
- Operates on low pressure air



Prod ID#	CSI#	Size	Price
70071	STKSS-E 8X8	8" x 8"	206.41
70072	STKSS-E 8X10	8" x 10"	214.29
70073	STKSS-E 8X12	8" x 12"	222.20
70074	STKSS-E 8X14	8" x 14"	233.22
70075	STKSS-E 8X16	8" x 16"	239.51
73437	STKSS-E 8x20	8" x 20"	252.09

**Plenum Air Line Tubing 250' Roll**

- Choose colors to distinguish each zone



Prod ID#	CSI#	Description	Price
70092	PLENUM-BLACK	Black	88.83
70093	PLENUM-BLUE	Blue	88.83
70094	PLENUM-GREEN	Green	88.83

**Black PVC Tubing 200' Roll**

- Colored striped to distinguish each zone

Prod ID#	CSI#	Description	Price
70085	PVC-BLUE	Blue - 200'	54.08
70087	PVC-GREEN	Green - 200'	54.08
70088	PVC-ORANGE	Orange - 200'	54.08
70089	PVC-RED	Red - 200'	54.08
70090	PVC-WHITE	White - 200'	54.08

Shaded items are Non-Stock special order and subject to freight.

**Sterling Hts, MI - Livonia, MI - Lansing, MI - Grand Rapids, MI - Waterford, MI - Almont, MI - Saginaw, MI**

**Zoning**

**Fittings**

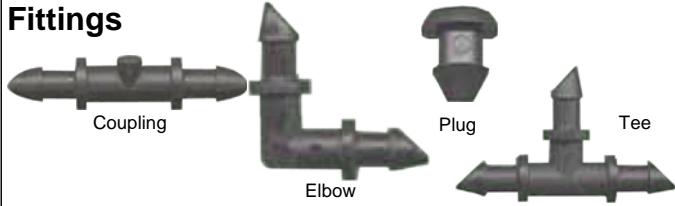

Prod ID#	CSI#	Description	Price
70081	FIT-TC025	Black Coupling 4mm-25/Pk	25.58
70082	FIT-TE025	Black Elbow 4mm-25/Pk	37.33
70083	FIT-TP025	Black Plug 4mm-25/Pk	17.14
70084	FIT-TT025	Black Tee 4mm-25/Pk	38.23

**Parts & Accessories**

Prod ID#	CSI#	Description	Price
70097	PAN-SOLO4	24VDC Solenoid Valve for MPS Series® & AirBoss®	97.64
70098	PAN-SOLO5	24VDC Solenoid Valve for HeatPumPro®	86.91
70095	SEN-RESPRO	Sensor LAT/OAT for HeatPumPro™	74.21
70099	TRANS-40VARS	24VAC, 40VA Resettable Transformer (2 - 4 Zone)	47.04

**Pump/Pressure Vacuum Assembly**

Prod ID#	CSI#	Description	Price
70096	PMP-PUMP1	Pump/Pressure Vacuum Assembly	123.73

**Tool Kit with Case**

- Includes:
  - Duct Finder™
  - EzyHub™ air distribution organizer
  - Air flow indicator
  - Stapler



Prod ID#	CSI#	Description	Price
70244	TOOL-KIT	Tool Kit with Case	359.87

**Arrow® Staples**

**T-59™ Arrow® Tubing Staples**



Prod ID#	CSI#	Size	Qty	Price
70243	TOOL-STPLS	5/16"	300/Pk	22.47



**THANK YOU!**  
*We appreciate your business!*

Shaded items are Non-Stock special order and subject to freight.

Sterling Hts, MI - Livonia, MI - Lansing, MI - Grand Rapids, MI - Waterford, MI - Almont, MI - Saginaw, MI

**Thermostats & Controls**

**90 Series WiFi Sensi Touch Thermostat**

- WiFi capable
- No "C" wire needed unless Heating only or Cooling only
- \*\*\*\* **When used with a LP9C furnace, the common wire must be used \*\*\*\***
- Auto heat/cool changeover option
- Easy access battery compartment or hardwired
- Indoor Humidity Sensor
- Touchscreen color display
- Integrates with Apple HomeKit, Amazon Alexa and Wink
- Circulating Fan Feature Satisfies Residential Code
- 5-Year warranty



Prod ID#	CSI#	Description	Price
76083	1F95U-42WF	Sensi Touch WiFi Thermostat 4H/2C	354.84

**90 Series™ EZ Install Universal WIRELESS Blue Thermostat**

- Wireless Indoor/Outdoor remote sensors available
- Humidification and Dehumidification Control with sensing at the thermostat
- Use up to 3 indoor sensors and thermostat for temperature averaging
- Meets Commercial Code for continuous fan in occupied mode
- Universal Staging
- Intuitive Menu Driven Set-Up
- 7 day Programmable or Non-Programmable
- Service Indicator alerts homeowner to call for service
- Large 6" display
- 5- Year Warranty



Prod ID#	CSI#	Typical Application	Programming	System Switch	Price
66718	1F98EZ-1621	Gas, Oil, Electric, <b>Humidification</b>	7/0 Day	Heat, Off, Cool, Auto, 4H/2C	517.13
66719	F145RF-1600	Wireless Indoor / Outdoor Sensor			156.42

**90 Series™ EZ Install Blue Touchscreen Thermostat**

- ONLY (4) Four wires needed to upgrade to multistage humidification, etc...
- Humidification and Dehumidification Control with sensing at the thermostat
- Includes Remote outdoor sensor (F145-1378)
- Blue touchscreen controls - Universal Staging
- Quick Connect Wiring
- Hardwired - Intuitive Menu Driven Set-Up
- 7 day Programmable or Non-Programmable
- Service Indicator alerts homeowner to call for service
- Large 12" touchscreen display
- 5- Year Warranty



Prod ID#	CSI#	Typical Application	Programming	System Switch	Price
65317	1F98EZ-1441	Gas, Oil, Electric, <b>Humidification</b>	7/0 Day	Heat, Off, Cool, Auto, 4H/2C	397.15

T-Stats & Controls

**Thermostats & Controls**

**90 Series™ Blue Touchscreen Thermostats**

- Blue touchscreen controls - Universal Staging
- 24 Volt or Millivolt System
- Hardwired or battery powered
- Programmable or Non-Programmable
- Service Indicator alerts homeowner to call for service
- Selectable automatic heat/cool system changeover
- Large 12" touchscreen display
- Intuitive menu-driven programming, with audio prompt
- 5- Year Warranty

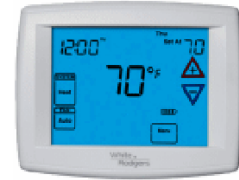

Prod ID#	CSI#	Typical Application	Programming	System Switch	Price
58722	1F95-1291	Gas, Oil, Electric, <b>Humid/Dehumid</b>	5+1+1 / 7 / 0 Day	Heat, Off, Cool, Auto, 4H/2C	437.77
54591	1F95-1277	Gas, Oil, Electric, 3-Wire Zone	5+1+1 / 7 / 0 Day	Heat, Off, Cool, Auto, 2-Stage	390.54
54590	1F97-1277	Gas, Oil, Electric, 3-Wire Zone	5+1+1 / 7 / 0 Day	Heat, Off, Cool, Auto, 1-Stage	349.66

**90 Series™ EZ Reader Universal Blue Thermostat**

- Dual Fuel capable without an outdoor sensor (Indoor Logic)
- Universal Staging
- Temperature set point limits
- Configurable for Heat Only / Cool Only
- Intuitive Menu Driven Set-Up
- Ships Non-Programmable - can be configured for 7-day
- Service Indicator alerts homeowner to call for service
- Large 6" display
- 5- Year Warranty



Prod ID#	CSI#	Typical Application	Programming	System Switch	Price
60847	1F95EZ-0671	Gas, Oil, Electric, 3-Wire Zone	0 / 7 Day	Heat, Off, Cool, Auto, 4H/2C	262.11

**90 Series™ Commercial Universal Blue Thermostat**

- Dual Fuel capable with an outdoor sensor (F145-1378)
- Remote sensing Indoor and at the Thermostat
- Universal Staging
- Temperature set point limits
- Configurable for Heat Only / Cool Only
- Intuitive Menu Driven Set-Up
- Pre-occupancy Purge and/or Programmable Fan
- Keypad Lockout - Total or Partial
- Large 6" display
- 5- Year Warranty



Prod ID#	CSI#	Typical Application	Programming	System Switch	Price
66861	1F95-0680	Gas, Oil, Electric, 3-Wire Zone	5+1+1 / 7 / 0 Day	Heat, Off, Cool, Auto, 4H/2C	275.35

**Thermostats & Controls**

**Accessories for 90 Series™ Blue Touchscreen Thermostats**

Prod ID#	CSI#	Color	Dimensions	For	Price
58703	F61-2600	Classic White Wall Plate	8-1/8" x 5-3/8"	90 Series	27.86

**Remote Sensors**

- Digital signal output provides superior temperature control, even over long wire runs
- No temperature variance caused by wire resistance
- Perfect for securing the thermostat in one area or room while sensing temperature in the conditioned space

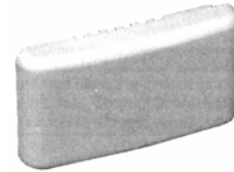

Prod ID#	CSI#	Color	Dimensions	Model	Range	Price
41381	F145-1328	Classic White	2-1/8" x 3-1/2" x 3/4"	Indoor	40 to 99°F	81.53
42362	F145-1378	Classic White	2-1/8" x 3-1/2" x 3/4"	Outdoor	40 to 99°F	85.09

**80 Series WiFi Sensi Thermostat**

- WiFi capable
- No "C" wire needed unless Heating only or Cooling only
- \*\*\*\* When used with a LP9C furnace, a common wire must be used \*\*\*\*
- Auto heat/cool changeover option– auto switch between heating & cooling programs
- Easy access battery compartment or hardwired
- Circulating Fan Feature satisfies Residential Code
- 5-Year warranty



Prod ID#	CSI#	-----System-----		Programming	Power Method	Price
		Switch	Fan			
76082	1F87U-42WF	Heat/Cool	Heat-Off-Cool-Auto	7,0	Battery/Hardwired	274.43

**Sensi Wall Plate (goof plate)**

Prod ID#	CSI#	Color	Dimensions	For	Price
71014	F61-2663	Classic White Wall Plate	6-3/4" x 4-1/2"	Sensi Wifi	14.11

**80 Series™ Conventional Thermostats**

- Single Stage (1H/1C) Digital Thermostat
- Backlit Display
- 24 Volts or Millivolt
- System Switch-Heat, Off, Cool, Fan Switch-Auto, On
- Keypad Lockout
- Temperature Limits
- Dual Power: Hardwire And/Or Battery
- Range 45-99 degrees F
- Terminals - RH,RC,C,W,Y,G,O/B



Prod ID#	CSI#	-----System-----		Programming	Power Method	Price
		Switch	Fan			
72830	1F83C-11PR	1Heat/1Cool	Heat-Off-Cool-Auto	7 Day, 5+1+1	Battery/Hardwired	131.79
72831	1F83C-11NP	1Heat/1Cool	Heat-Off-Cool-Auto	Non-Prog	Battery/Hardwired	100.01

T-Stats & Controls

Thermostats & Controls

**80 Series™ 5" Universal Dual Fuel Thermostats**

- Universal Single Stage, Multi-Stage (2H/2C) or Heat Pump (4H/2C) with Dual Fuel Option
- 3 Wire Zone Valve
- Backlit Display
- 24 Volts or Millivolt
- System Switch-Heat, Off, Cool
- Keypad Lockout
- Temperature Limits
- Dual Power: Hardwire And/Or Battery
- Range 45-99 degrees F
- Terminals - RH,RC,C,W/E,W2,Y,Y2,G,O/B/6, L



Prod ID#	CSI#	-----System-----		Programming	Power Method	Price
		Switch	Fan			
72828	1F85U-42PR	4Heat/2Cool	Heat-Off-Cool-Auto	7 Day, 5+1+1	Battery/Hardwired	188.29
72829	1F85U-42NP	4Heat/2Cool	Heat-Off-Cool-Auto	Non-Prog	Battery/Hardwired	154.05

**Classic 80 Series Thermostats**

**Single Stage Electronic Thermostats for Gas, Oil, Electric Residential/Light Commercial Applications**

- Battery powered or hardwired
- Gas / Oil / Electric heat compatible
- Permanent program retention during power loss (1F80-361 only)
- Millivolt Compatible
- 5 - year Warranty



Prod ID#	CSI#	-----System-----		Programming	Power Method	Price
		Switch	Fan			
12337	1F80-361	Heat-Off-Cool	On-Auto	5+1+1 Day	Hardwired &/or Battery	136.55
23353	1F86-344	Heat-Off-Cool	On-Auto	Non-Program	Hardwired &/or Battery	100.66

**Accessory Wall Plates**

Prod ID#	CSI#	Color	Dimensions	For	Price
42353	F61-2500	Classic White	4-5/8" x 7-5/8"	1F80 Series	18.38
57226	F61-2634	Classic White	5" x 6-1/2"	80 or 90 Series	14.29

**70 Series Single Stage Economy Thermostats (Horizontal)**

**Single Stage Thermostats**

- Fossil fuel or electric heat compatible
- Selectable Celsius or Fahrenheit temperature display
- 5-Year Warranty

1F78-144



1F78-151



Prod ID#	CSI#	-----System-----		Programming	Power Method	Voltage	Price
		Switch	Fan				
40113	1F78-144	Heat/Cool	Heat-Off-Cool	Auto-On	Non-Prog	Battery Powered	74.94
39440	1F78-151	Heat/Cool	Heat-Off-Cool	Auto-On	5+2 Day	Battery Powered	85.02

**Thermostats & Controls**

**70 Series Single Stage Economy Thermostats (Vertical)**

- Fossil fuel or electric heat compatible
- Large LCD with backlight
- Selectable Celsius or Fahrenheit temperature display
- Includes B/O terminals
- Electronic accuracy
- Cool-Off-Heat system switches
- Auto-On fan switches
- 5- Year Warranty



1E78-151



1E78-144



1E78-140

Prod ID#	CSI#	System	Program Options	Additional Applications	Power Source	Terminal Designations	Price
54647	1E78-144	Single Stg	Non-Prog	Millivolt, SS HP	Battery	RC,RHH,W,Y,G,O,B	69.92
51886	1E78-151	Single Stg	5 + 2	Millivolt, SS HP	Battery	RC,RH,W,Y,G,O,B	83.49
56772	1E78-140	Single Stg	Non-Prog Heat Only	Millivolt, SS HP	Battery	RH,W	67.43

**Accessories for 1E70 Series**

Prod ID#	CSI#	Color	Dimensions	For	Price
54735	F61-2593	Classic White	4-1/2" x 6-19/32"	1D70 Or 1E70 Series	11.88
66230	F61-2550	Classic White	6-1/2" x 4-1/2"	1F70 Series	11.16

**Single Stage Low Voltage Thermostats**

**Economy Mechanical Thermostats**

- Bi-metal Thermostat
- 5-1/8" x 5" white wall plate optional
- Temp range: 50 - 90°F



Prod ID#	CSI#	Application	Style	Diff	Color	Price
4230	1C20-102	Heat Only Snap-Action Contacts Gas, Oil	VERT	2°	White	39.38

**Universal Replacement Mechanical Thermostats**

**Universal Design Horizontal:**

- Replaces hundreds of White-Rodgers and competitive models
- Mercury free
- 24V Switch rating
- Vibration resistant



Prod ID#	CSI#	Application	Switching	Dif	Style	Color	Price
57351	1F56N-444	Gas, Oil or Electric	SPDT	1°F/1.5°F	Horizontal	Classic White	79.16

T-Stats & Controls

**Thermostats & Controls**

**Universal Design Vertical**

- Replaces hundreds of White-Rodgers and competitive models
- Mercury free
- 24V Switch rating
- Vibration resistant



Prod ID#	CSI#	Application	Switching	Dif	Style	Color	Price
60908	1E50N-301	Gas, Oil or Electric	SPDT	1°F/1.5°F	Vertical	Classic White	79.16

**Line Voltage Thermostats**

**Light Duty Line Voltage Thermostat**

- For direct control of fan coils, fans, motor starters, circulator motors, contactors, valves for heating, cooling or SPDT applications
- Mounts on 2" x 4" electrical box
- Set point locking feature
- 125VA pilot duty, 120V or 240/277V



Prod ID#	CSI#	Temp Range	Differential	Switching	Color	Price
45723	1A10-651	36° - 90°F	1.5°F	SPDT	Beige	172.74

**Ignition Controls**

**Single-Stage/ HSI Furnace Control (Goodman Replacement)**

- Replaces 50T55-289 and 50A55-289 and Virtually All Goodman 1-Stg HSI with 120V Igniters
- 5 Amp Fuse protection
- 120 VAC Igniter output, Humidifier output, Electronic Air Cleaner Output & 2-Spd PSC Circ Output
- Heat Fan OFF Delay (Dipswitch Selectable)
- Y,W,R,G,C, TWIN Terminals
- LED diagnostic indicator



Prod ID#	CSI#	Description	Price
67802	50A55-743	Single Stage HSI Integrated Furnace Control Kit (Goodman Repl)	103.80

**Universal Intermittent Pilot Spark Control**

- Gas ignition control
- Designed for all gases
- Microcomputer-based
- Field replacement for most Honeywell, Robertshaw, Johnson Controls and Utec intermittent pilot ignition controls
- Works with single rod or dual rod remoter sensor
- LED diagnostic indicator



Prod ID#	CSI#	Description	Price
48436	50D50-843	Universal Pilot Spark Control	215.72

T-Stats & Controls



**Thermostats & Controls**

**Universal Ignition Module for Hot Surface Ignition Systems**

- For gas-fired non-integrated forced air furnaces and boilers
- Replaces all White-Rodgers 50E47-XXX Modules and many competitors
- Nine program keys & color-coded timing label included
- Ambient operating range: -40 - +175°F (-40 - +80°C)
- Direct & indirect flame sense compatible
- Tri-colored LED indicator for diagnostics



Prod ID#	CSI#	Description	Price
45397	50E47-843	Universal Ignition Module	261.06

**Single Stage HSI Furnace Control Kit (Many LENNOX)**

- Kit Includes: (1) 50A66-843 Control Board
- (1) Wire Harness - 9-pin to 12-pin
- (1) Wire Harness - 4-pin to 6-pin
- (1) Mounting Panel
- (4) Stand-off Fasteners
- (1) Circuit Breaker
- (1) 4" Blue Wire
- (1) Wiring Diagram
- Includes 21D64-2 Universal 120V Nitride Igniter Kit

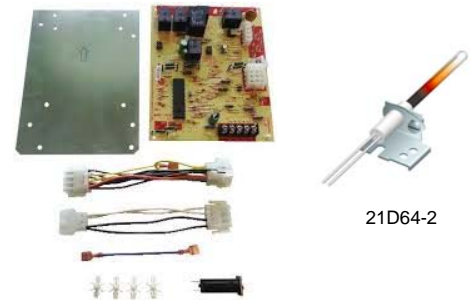

Prod ID#	CSI#	Description	Price
67803	21D83M-843	Single Stage HSI Integrated Furnace Control Kit ( Lennox repl)	424.92

**Universal 2-Stage HSI Furnace Control Kits**

- Includes 21D64-2 Universal 120V Nitride Igniter Kit
- Tri-Color Furnace Status LED
- 2-Stage Gas Valve Output
- Fuse Protection - 3 Amp
- Pressure Switch Inputs and Monitoring



Prod ID#	CSI#	Description	Price
63872	21V51U-843	Universal 2-Stage HSI Variable Speed (ECM) Furnace Kit	421.79

**Universal Single Stage HSI Furnace Control Kits**

- Includes 21D64-2 Universal 120V Nitride Igniter Kit
- Replaces over **200** competitive modules
- Furnace Status LED
- Single Stage Gas Valve Output
- Fuse Protection - 3 Amp
- System Diagnostics, with Fault Recall (Stored)



Prod ID#	CSI#	Description	Price
62355	50M56U-843	Universal Single Stage HSI Furnace Kit	281.19

T-Stats & Controls

**Thermostats & Controls**

**Trane Single Stage - 80V Igniter HSI Furnace Control Kit**

- Direct Replacement
- Ignition Control Module
- Replaces single stage Trane HSI Controls with 80V igniters



Prod ID#	CSI#	Description	Price
71886	50A56-5165	Trane Single Stage 80V Igniter HSI Integrated Furnace Control Kit	211.13

**Universal Hot Surface Upgrade Kit**

- No need to replace existing module
- 15-1/2" Leads
- Replaces most silicon carbide ignitors
- Super tough nitride ignitor construction
- 3-Year warranty



Prod ID#	CSI#	Description	Price
40542	21D64-2	Kit Includes Nitride Ignitor, Universal Mounting Bracket, and 2 Ceramic Wire Nuts	67.72

**Carbide Igniters - OEM Direct Replacements**



Prod ID#	CSI#	Description	Price
77518	767A-361	Igniter, Surface 5.25" Leads	35.31
77516	767A-369	Igniter 5.5" Leads A-Block	33.71
77520	767A-370	Igniter 5.25" Leads M-Block	33.71
77517	767A-371	Igniter 19" Leads W-Block	33.71
77519	767A-372	Igniter 5.25" Leads N-Block	33.71
77521	767A-373	Igniter 5.25" Leads NM--Block	32.90

Go to Google Play Store or the App Store to get the White-Rodgers Mobile App!  
Get up to date information on current product and quick cross references!

**Thermostats & Controls**

**Gas Burner Controls**

**36C Snap Open, Single Function & Standing Pilot Gas Valves**

- Valve may be mounted in any position except upside down
- Gas cock knob, pilot adjust screw & regulator adjustment are on top of control
- Easy-grip pipe boss simplifies installation
- Use w/thermocouples
- Natural gas, includes LP conversion kit & reducer bushing kit
- -333 does not include inlet pressure tap, -433 does



Prod ID#	CSI#	Coil Voltage	Inlet/Outlet Size	Capacity AGA Standard Gas	LP Gas	Side Taps	Price
3701	36C03-300	24VAC, 60Hz	1/2" x 3/4"	230,000	372,600	No	211.72
45720	36C03-433	24VAC, 60Hz	3/4" x 3/4"	280,000	453,600	Yes	286.10
45721	36C03U-433	750 mV	3/4" x 3/4"	280,000	453,600	Yes	413.07

**36H Series Universal Gas Valves**

- For intermittent & direct spark applications
- All valves are 3/4" x 3/4" pipe size
- Equipped w/a redundant pilot solenoid line valve
- 0.6A

36H32-423



Prod ID#	CSI#	Coil Voltage	Inlet/Outlet Size	Capacity AGA Std Gas	Opening	Price
59543	36H32-304	24VAC, 50/60 Hz	1/2" x 3/4"	230,000	Fast Open	284.33
59544	36H33-412	24VAC, 50/60 Hz	3/4" x 3/4"	300,000	Slow Open	299.50
45719	36H32-423	24VAC, 50/60 Hz	3/4" x 3/4"	300,000	Fast Open	275.19
57873	36H64-463	24VAC, 50/60 Hz	3/4" x 3/4"	300,000	2-Stg Fast Open	360.89

**36J Series Electronic Ignition Gas Valves**

- HSI/DSI electronic Ignition Systems
- All valves are 1/2" x 1/2" pipe size
- Adjustable Regulators
- Inlet/Outlet Screens
- Electric On-Off Switch

36J Single Stage



36J Two Stage



Prod ID#	CSI#	Coil Voltage	Inlet/Outlet Size	Capacity AGA Std Gas	Opening	Price
64575	36J22-214	24VAC, 50/60 Hz	1/2" x 1/2"	140,000	Fast Open	147.23
66677	36J24-214	24VAC, 50/60 Hz	1/2" x 1/2"	140,000	Slow Open	147.23
64193	36J54-214	24VAC, 50/60 Hz	1/2" x 1/2"	140,000	2-Stg Fast Open	215.71

**Accessories**

Prod ID#	CSI#	Color	Dimensions	For	Price
62671	F92-0656	LP-NG CONV KIT FOR 36C00 VALVE			26.89

T-Stats & Controls

Thermostats & Controls

**Pilot Relite & Lockout Timers**

**Pilot Relite Controls**

- Ignition control generates spark pulses to ignite pilot gas
- AGA design certified & CGA certified



Prod ID#	CSI#	Input Volts	Electric Rating	Description	Price
3718	5059-23	24VAC	0.03A	Spark Plug & 1/4" Spade Connection	236.31

**Hydronic Controls**

**Hydronic Zone Controls**

- Self aligning barrel-type valve stem uses line pressure to seal off binding on opening & closing
- Valve stem made of stainless steel
- Built-in auxiliary contacts to control burner or circulator relay



**3-Wire, 24V Valves w/Screw Terminal Wiring Panel & Auxiliary Switch**

Prod ID#	CSI#	Tubing Size (ID)	24V AC Thermostat Circuit Rating	Time Cycle Open/Close	Max Water Temperature	Price
3666	1311-102	3/4"	0.4A	45 Sec/45 Sec	240°F / 116°C	319.98
3667	1311-103	1"	0.4A	45 Sec/45 Sec	240°F / 116°C	371.24

**2-Wire, 24V Valves w/Screw Terminal Wiring Panel & Auxiliary Switch**

Prod ID#	CSI#	Tubing Size (ID)	24V AC Thermostat Circuit Rating	Time Cycle Open/Close	Max Water Temperature	Price
3669	1361-102	3/4"	0.2A	45 Sec/60 Sec	240°F / 116°C	375.20

**Warm Air Controls**

**Fan & Limit Controls for Universal Replacement**

- Slotted mounting holes for easy installation
- Long terminal screws for wiring
- Limit switch has universal contact structure & can handle 240VAC
- Limit switch has adjustable stop to limit maximum setting



Prod ID#	CSI#	Element Length	Temp Range	Differential	Switching	Price
45399	5D51-35	5"	50 - 265°F	Adj 15°F Fixed 25°F	Close on Rise Open on Rise	229.74
45401	5D51-78	11"	100 - 300°F	Adj 15°F Fixed 25°F	Close on Rise Open on Rise	234.20
45400	5D51-90	8"	100 - 300°F	Adj 15°F Fixed 25°F	Close on Rise Open on Rise	234.20

**Thermostats & Controls**

**Snap Disc Controls**

- Adjustable snap disc thermostat allows setting temperature set point to match specific needs
- 1/4" quick contact terminals are standard



3F05 Series

**Snap Disc Fan Controls - Adjustable**

- Includes thermostat & tab-to-screw terminals

Prod ID#	CSI#	Temp Range	Differential	Switching	Function	Price
3682	3F05-1	90 - 130°F	20°F	SPST	Close on Rise	39.65
3683	3F05-2	140 - 180°F	20°F	SPST	Close on Rise	39.65

**Snap Disc Limit Controls - Adjustable**

- 1/4" quick connect terminals



3L05 Series

Prod ID#	CSI#	Temp Range	Differential	Switching	Function	Price
3684	3L05-1	135 - 175°F	40°F	SPST	Open on Rise	39.65
3685	3L05-2	175 - 215°F	40°F	SPST	Open on Rise	39.65
3686	3L05-3	210 - 250°F	40°F	SPST	Open on Rise	39.65

**Source 1 Contactor/Relay**

**1 Pole Definite Purpose Contactors 40A**

**WR/RBM Type 121**

- Straight-through wiring, replaces 1-1/2 pole devices used primarily in residential central air conditioning
- Coils are class B
- Temp range: -40° - 150°F
- Made of close grain cast iron w/lacquer finish



Prod ID#	CSI#	Amps	Voltage AC	Res DC OHMS	Current MA	Nominal Va	Price
78895	S1-DP130024	30	24	16.5	208	5	15.71
22226	S1-02425837700	40	24	-	-	-	61.59

**2-Pole Definite Purpose Contactors (30A thru 40A)**

**WR/RBM Type 122**

- Low VA coil for cooler operation & increased life
- Universal mounting bracket fits existing mounting holes
- Temp range: -40° - 150°F



Prod ID#	CSI#	Amps	Voltage AC	Res DC OHMS	Current MA	Nominal Va	Price
4930	S1-DP230024	30	24	11	250	6	20.27
38845	S1-DP240024	40	24	11	250	6	21.75

T-Stats & Controls

Thermostats & Controls

**3-Pole Definite Purpose Contactors (25A thru 40A)**

**WR/RBM Type 154**

- Mechanical life (no load): conforms to UL & ARI specifications
- Frequency: 50/60Hz
- 600V 3-pole normally open
- Temp range: -40° - 150°F



Prod ID#	CSI#	Amps	Voltage AC	Res DC OHMS	Current MA	Inrush Va	Price
5481	S1-DP340024	40	24	7.2	187	4.5	39.85

**Enclosed Fan Relays**

**WR/RBM Type 84**

- Used for switching single or two speed fan motors, solenoids, relays, resistive loads & general purpose switching
- Totally enclosed
- Temp range: -40° - 150°F
- Mechanical life (no load): 1,000,000 operations, 60/minute
- **90-293Q** Frequency: 50/60Hz
- SPNO - Single pole normally open
- SPDT - Single pole double throw



90-290Q



90-293Q

Prod ID#	CSI#	Type	Coil Voltage (50/60Hz)	DC Res	Nom Current MA	Nom VA Sealed	Inrush VA	Price
11422	90-290Q	SPNO	24	90	125	3	4	20.65
206	90-293Q	SPDT	24	90	125	3	4	21.85

**Switching Relays**

**Two Pole WR/RBM Type 91**

- For power or pilot duty, for vending machines, appliances, fan controls, heating & air conditioning applications and general purpose switching
- Temp range: -40°F - 130°F
- Two pole double throw semi-enclosed relay
- Mechanical life (no load): 1,000,000 operations, 120/min
- Frequency: 50/60Hz
- Fits receptacles
- SPDT - Two pole double throw

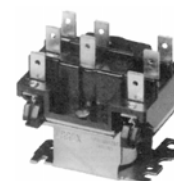

Prod ID#	CSI#	Coil Voltage (50/60Hz)	Terminals 1-2-3	Terminals 4-5-6	DC Res	Nom Current MA	Price
5483	90-340	24	Power	Power	17.5	334	24.66

**Fan Control Center Relays & Transformers**

**Steveco® Fan Control Centers**

- Line voltage connections are pre-wired
- Color coded pre-stripped leads
- Low voltage connections on terminal board



Prod ID#	CSI#	Primary Voltage	Primary HZ	Secondary Voltage	Secondary VA	Relay	Price
202	90-113	120	60	24V	40	SPDT	82.73

T-Stats & Controls

**Thermostats & Controls**

**Sure Switch Contactor/Relay**

- 5 - YEAR Warranty
- Sealed to keep out ants and debris
- Microprocessor control nearly eliminates contactor welding and pitting
- Brown out and short cycle protection
- Applications up to 40 Amps
- 1 or 1.5 Pole
- Zero Chatter latching relay
- Compressor test and cycle count by pushbutton



Prod ID#	CSI#	Description	Price
68014	49P11-843	Sure Switch Contactor/Relay 24VAC Coil Voltage 24VAC contact Rating	97.50

**Class 2 Transformers**

- Compact, totally enclosed design
- For heating & cooling applications & general switching
- Quiet, reliable & economical

Prod ID#	CSI#	Coil Voltage	Res.	-----Coil Data-----			Price
				Nom Current MA	Nom VA Seated	Inrush VA	
44484	90-T40M3	40	50/60	120/208/240V	Leads	24V Leads	38.62
66837	90-T50F3	50	50/60	120/208/240V	Leads	24V Leads	53.51
62350	90-T75C3	75	50/60	120/208/240V	Leads	24V Leads	91.26

T-Stats & Controls

**White-Rodgers™**

## Thermostats & Controls

### Ecobee Thermostats

- WiFi Smart Thermostat
- Room Sensor to manage cold and hot spots
- Come w/built-in Amazon Alexa Voice Service
- Ask to order Groceries, read the news and more
- Contractor Website to connect with Homeowners
- Alerts and Status updates about your customers
- Programmable Fan
- 3-Year Warranty



Prod ID#	CSI#	Description	Price
76303	ECOBEE4	Ecobee4 WiFi Thermostat with Room Sensor	511.46
76304	ECOBEE3LP	Ecobee3 Lite Pro Smart WiFi Thermostat	353.85
76305	ECOBEEERS	Ecobee Room Sensors (2-pack)	167.78

## Honeywell

### Programmable Thermostats

- 5-Year Warranty

#### PRO™ 2000 Programmable Thermostats

- Vertical mounting
- 5-2 programmable thermostat
- Precise Comfort Control:  $\pm 1^{\circ}\text{F}$  of your set temperature.
- Simplified Operation: Soft-key controls.
- Preset Program Settings
- Temporary and permanent override of schedule



Prod ID#	CSI#	Description	Price
76322	TH2110DV1008/U	1Heat/1Cool Vertical Digital 5/2 Day Programmable Thermostat	85.68

#### PRO™ 4000 Programmable Thermostats

- Horizontal mounting
- 5-2 programmable thermostat
- Precise Comfort Control:  $\pm 1^{\circ}\text{F}$  of your set temperature.
- Simplified Operation: Soft-key controls.
- Simultaneously displays both room temperature and temperature setting.
- Easy Change Battery Holder.
- Programmable to save up to 33% on annual heating/cooling costs



Prod ID#	CSI#	Description	Price
51818	TH4110D1007	1 Heat / 1 Cool Digital 5/2 Day Programmable Thermostat	134.51



**Thermostats & Controls**

**Focus PRO™ 6000 Programmable Thermostats**

- 5-1-1 / 5-2 programmable thermostat
- Adaptive Intelligent Recovery - Ensures programmed temp is reached at programmed time
- Precise Comfort Control: ±1°F of your set temperature.
- Simplified Operation: Soft-key controls.
- Easy Change Battery Holder.



Prod ID#	CSI#	Description	Price
73261	TH6110D1021	1 Heat / 1 Cool Digital 5/1/1 Day Programable Digital Thermostat	216.97
71523	TH6220D1002	2 Heat / 2 Cool Digital 5/1/1 Day Programable Digital Thermostat	250.93

**T6 PRO™ Smart Thermostat**

- 7 Day programmable thermostat
- Control from anywhere using your smartphone or tablet
- Energy Star certified
- WiFi stat
- Geofencing
- Works with Apple HomeKit and Amazon Echo



Prod ID#	CSI#	Description	Price
75194	TH6220WF2006/U	7 Day WiFi T6 Pro Smart Stat	280.15

**Transformer**

**40VA Transformer 24 Vac**

- Color-coded lead wires for primary connections
- Includes fixed 1/4" Male Quick-connects
- Meets UL 1585 standards



Prod ID#	CSI#	Description	Price
72610	AT140A1000	40VA Transformer 24Vac	42.18

**Fan & Limit Controllers**

**L4064B series Fan & Limit**

- Three wiring terminal options for easy installation
- Field adjustable fan and high limit settings
- Auxiliary screw terminals
- Push-in receptacles for stripped wire
- Female receptacles for 1/4 inch male flag connectors



Prod ID#	CSI#	Description	Price
70506	L4064B2228	5" Insert Fan & Limit Controller	247.62
72419	L4064B2236	8" Insert Fan & Limit Controller	252.40
70507	L4064B2210	11-1/2" Insert Fan & Limit Controller	254.68

T-Stats & Controls

Thermostats & Controls

**Combination Gas Controls**

**Standard Features for Combination Gas Valves Include:**

- Safety shutoff, manual valve, two automatic operators, pressure regulator & pilot adjustment
- Two automatic valves
- Solenoid-operated first automatic valve opens on thermostat call for heat; closes when call for heat ends. diaphragm-operated second automatic valve opens under control of regulator; closes if gas or power supply is interrupted
- Meets codes requiring dual safety shutoff
- Standard & slow opening natural gas models include natural to LP gas conversion kits; LP to natural gas conversion kits are also available
- All adjustments, wiring connections & pilot outlets are accessible from the top of controls
- Mounting: 0 to 90°, any direction from upright position of gas control knob, including vertically

**VR8345 Universal Electronic Ignition Combination Gas Control**

- For use with direct spark ignition, hot surface ignition or intermittent pilot ignition in 24VAC, gas-fired appliances, w/capacities from 30 to 415 CFH
- Control includes manual valve, two automatic operators, pressure regulator, pilot adjustment, pilot plug & ignition adapter
- Replaces virtually any IP, HSI or DSI gas control
- For use with natural or manufactured gas or LP gas
- 4" Swing radius allows easy rotation into position inside the tightest furnace vestibules
- Clearly marked, keyed terminal block allows quick attachment wires & IP/DSI/HSI jumper
- Internal inlet screen blocks contaminants in gas line from entering valve



Prod ID#	CSI#	Inlet/Outlet Size	Capacity cfh	Capacity m3/hr	Prs Regulator Setting In wc	Type Setting kPa	Type of Gas	Pressure Regulator	Price
21125	VR8345M4302	3/4x3/4	30-415	8.5	3.5	0.87	Nat'l	Std	328.84

**Gas Burner/Ignition Controls**

**Universal Retrofit Intermittent Pilot Gas Burner Ignition System**

- Complete kit for converting conventional standing pilot systems to intermittent pilot systems for use with 24VAC gas-fired atmospheric furnaces, boiler & heating appliances
- Includes: Intermittent Pilot Module; Intermittent Pilot Dual Valve Combo Gas Control (VR8304 with ON-OFF manual valve), pressure regulator & two automatic main gas valve operators & reducer bushings
- Includes 392431 Ignitor-Sensor Assembly including ceramic-insulated Kantahal rod that attaches to existing pilot burner in place of the thermocouple; 394800-30 Ignition Cable - 30" cable with connectors, 30" wiring harness with 1/4" quick-connect terminals, reducer bushings for gas control, adhesive mounting tape for S8610 & misc installation hardware
- Y8610U kits are for use with Natural or LP gas; 100% pilot gas shutoff & include 393691 LP gas conversion kit, 393690-14 flange assembly



Prod ID#	CSI#	Description	Price
8228	Y8610U6006	S8610U1003, VR8304M3558 1/2x3/4 Reducer Bushings & Flange Kit, Conversion Kit, ECO Adapter & Vent Damper Plug	746.66

**Thermostats & Controls**

**S8610U Universal Intermittent Pilot Module**

- Replaces over 400 White-Rodgers, Robertshaw and Honeywell intermittent pilot ignition modules
- Provides ignition sequencing, flame monitoring and safety shutoff for intermittent pilot warm air furnaces and heating appliances
- Provides 100% Pilot gas shutoff if pilot fails to light, after 6-minute delay, trial for ignition is repeated. Ignition trial/delay sequence is repeated until the appliance lights or the call for heat is removed.
- For use with Natural Gas or L.P. Gas
- For use in single rod or dual rod/remote sense applications
- Includes spark cable adapters to allow field replacement of both Honeywell and competitive controls without replacing existing spark cable



Prod ID#	CSI#	Description	Price
7611	S8610U3009	Nat'l or LP Gas, 90 Second Trial for Ignition, 5 Minute Wait	319.33

**S8910U Universal Hot Surface Ignition Module**

- Replaces over 800 W/R, Robertshaw & Honeywell hot surface ignition modules
- For 120Vac (up to 5.1A) surface igniter (Norton 201/271 or equivalent)
- LED status indicator and microammeter ports for easy trouble shooting
- Contains easy-to-use cross reference and instructions plus the acces required to replace the existing hot surface ignition module.



Prod ID#	CSI#	Description	Price
75320	S8910U3000	Works with Single & Dual Rod Sensors, Built-In LED Diagnostics 1 or 3 Trials for Ignition, 4 Sec/7 Sec Ignition Trial Time	360.23

**S9200U Hot Surface Ignition Control**

- Universal hot surface ignition integrated furnace control
- Controls a standard induction-type circulating fan motor
- Can be used with conventional thermostats as well as the EnviraCOM™ enabled VisionPRO™ IAQ and FocusPRO™
- Main burner ignition using a 120V hot surface igniter
- Flame rectification circuit to monitor flame presence
- Monitors system pressure switch, high temperature limit, and rollout functions



Prod ID#	CSI#	Description	Price
59411	S9200U1000	Universal Integrated Furnace Control	299.03

**Universal Electric Fan Timer Control w/LED Diagnostics**

- Replaces 40+ existing Honeywell electronic fan timers
- Integrates control of all combustion blower & circulating fan operations in gas warm air appliance
- Replaceable Fuse
- LED Lights for easy diagnostics



Prod ID#	CSI#	Description	Price
64158	ST9120U1011	Universal Elec Fan Timer w/LED Diagnostics	332.80

T-Stats & Controls

Thermostats & Controls

**Q313 Replacement Thermopile Generators**

- Provides power for a millivoltage, self-powered control system
- Includes spade terminals
- Use with Q314, Q324, Q327, Q382 pilot burners



Prod ID#	CSI#	Description	Price
756	Q313A1170	600-750mV Replacement Thermopile Generator, 35" Lead, PG9 Adapter	138.94

**Pilot Burners**

**Q314 Pilot Burner**

- Non-primary aerated, insert orifice-type, for main burner ignition w/Q340 or Q390 thermocouple for pilotstat safety control operation
- Use with Q313 Thermopile generator for 750mV powerpile applications
- Natural Gas orifice, LP gas orifice, 1/4" cc inlet fitting
- Special mounting bracket with screws for converting "B" bracket to "A"



Prod ID#	CSI#	Description	Price
757	Q314A4586	B Bracket, .018 Orifice, 1/4" Ftg, F Tip, w/Extra .010 Orifice, Unassembled	89.46

**Q340 Thermocouples**

- Push-in Clip, split nut or adapter assembly available for easy pilot burner installation
- Available in a variety of lead lengths



Prod ID#	CSI#	Description	Price
759	Q340A1066	18" Lead 30mV Replacement Thermocouple	22.96
760	Q340A1074	24" Lead 30mV Replacement Thermocouple	23.96
761	Q340A1082	30" Lead 30mV Replacement Thermocouple	25.38
7752	Q340A1090	36" Lead 30mV Replacement Thermocouple	26.27
762	Q340A1108	48" Lead 30mV Replacement Thermocouple	26.66

**Q3400 Igniter Flame Rod Assy**

- Used with : SV9500,SV9600, Field replacement for Q3450, Q3480 hot surface pilot burner.



Prod ID#	CSI#	Description	Price
71431	Q3400A1024/U	30" Ignition Flame Rod Assembly	161.99

**Q3200 Hot Surface Igniter Kit**

- 120V Silicon Nitride Igniter
- Six Different Brackets included in kit for 100's of replacements
- Silicon nitride igniter construction



Prod ID#	CSI#	Description	Price
61917	Q3200U1004	Glowfly™ Universal Igniter Kit	77.05

T-Stats & Controls

**Thermostats & Controls**

**Q345A Igniter-Burner**

- Non-primary aerated combination pilot burner & igniter
- Used with S86, S860 S8610 or S8670 in intermittent pilot systems
- Includes pilot burner with bracket, ceramic insulated Kanthal flame rod/spark igniter & ground strap



Prod ID#	CSI#	Description	Price
765	Q345A1321	B Bracket, .018 Orifice, 1/4" Fitting, K Tip	116.73

**Hydronic Controls**

**V8043 Low Voltage Hydronic Zone Valves**

**Two Position Normally Closed Straight-Through Motorized Valve**

- For controlling flow of hot & cold water
- With end switch & manual opener
- Terminal board w/5 terminals
- 125°F maximum ambient temperature
- 24V, 50/60Hz



Prod ID#	CSI#	Description	Price
832	V8043F1036	3/4" Swt, 3.5 Cv Flow Capacity, with Auxiliary Switch Zone Valve	231.59
833	V8043F1051	1" SWT, 3.5 Cv Flow Capacity, with Auxiliary Switch Zone Valve	263.70

**Sail Switch**

- Used in force air systems to activate electronic air cleaners, humidifiers or other auxiliary equipment in response to airflow from system fan



Prod ID#	CSI#	Description	Price
800	S688A1007	NO Contact: Make @ 250 FPM; Break @ 75 FPM; NC Contact: Make @ 75 FPM; Break @ 250 FPM	142.43
848	123773A	Sail Assembly for S688A	34.00

**S483 Winter Watchman**

- Used as freeze warning device
- Completes circuit to household lamp on temperature fall, indicating inoperative heating equipment



Prod ID#	CSI#	Description	Price
798	S483B1002	Winter Watchman Freeze Warning Device, 30° - 60°F, Adjustable	87.46

T-Stats & Controls

**Igniters**

**Universal Smart-Lite Igniter**

- 24 Volt
- Silicon Nitride Hot Surface Igniter
- 18GA Copper Insulated Lead Wires
- Low Power Consumption



Prod ID#	CSI#	Description	Price
67404	IG9500	Universal Smart-Lite Igniter	74.47

**Universal TrueStart Igniter**



Prod ID#	CSI#	Description	Price
71095	IGN-001	Universal TrueStart Igniter	43.78

T-Stats & Controls

**Thank You for Using this Catalog as Your Reference to Our Broad Line of Products.**

**Thermostats & Controls**

**Starlite® Hot Surface Ignitors- On Phase Out - See White-Rodgers**

- Manufactured of high purity, self-bonded silicon carbide



Prod ID#	CSI#	Size	Price
51598	ISI111201001401	5-1/2" Leads w/Connect	36.11
51599	ISI111201001402	19" Leads w/Wire Nuts	36.11
51600	ISI111201001405	5-1/2" Leads w/Wire Nuts	36.11
51602	ISI111201001408	5-1/2" Lead w/Connect	36.11
51603	ISI111201001409	5-1/2" Leads w/Connect	36.11
51604	ISI111201001412	5-1/2" Leads w/Connect & Bracket	37.72



T-Stats & Controls

**Seven stand alone locations state wide to serve your needs!**

**Sterling Hts, MI - Livonia, MI - Lansing, MI - Grand Rapids, MI - Waterford, MI - Almont, MI - Saginaw, MI**

## Furnace & Heating Igniters

OEM	OEM Part No.	Starlite Part No.	1090 KIT Compatible	OEM	OEM Part No.	Starlite Part No.	1090 KIT Compatible
Amana	B1336102	1401	no	Lochinvar	PLT2400	1406	no
	D99182	1401	no		PLT3400		no
	10041601	1401	no	Metzger	201N	1402	YES
	10735003		YES		201W	1402	YES
Amer Water Htr	5395415	no	no	Modine	5H075032B	1121	no
Armstrong Air	38322B001	1402	YES	Nordyne/ Frigidaire, Maytag, Philco, Tappan, Westinghouse	632-250	no	no
Carrier	LH33ZS001	1409	YES		632-363	1405	YES
	LH33ZS002	1409	YES		902499		
	LH33ZS003	1409	no		902661	no	no
	LH33ZS004	1409	no		903110	no	no
Clare	C238	1033, 1402	YES		Norton	903758 kit	1405 <sup>2</sup>
	C238-1	no	no	201A		1401	no
	C242	1402	YES	271A		1401	no
Coleman	1474-051P	1061	no	201D		1405	YES
	1474-052P	1061	no	271D		1405	YES
Comfort Zone	150114-04-01	1406	no	201N		1402, others	YES <sup>3</sup>
Detroit Radiant	201D	1405	YES	271N		1402, others	YES <sup>3</sup>
DMO Ind. / Olsen	20834	1056, 1402	YES	271NM		1412, others	no
	26789	1056	YES	271Q		no	no
Dornback	271W	1402	YES	201W		1402, others	YES <sup>3</sup>
Ducane	20015201	1409	YES	271W	1402, others	YES <sup>3</sup>	
Enerco Tech	10399	1402	YES	271Y	1406	no	
Gemline	IG100	no	no	271 or 271M	1403, others	YES <sup>3</sup>	
	IG101	no	no	Pentair	472216	no	no
	IG102	no	no	Perf. Schwank	108803-G1	1406	no
	IG1000	1090	YES	Raypak	600915	1403	YES
Glowcore	HSRK-5	1109	no	601559	no	no	
	1950006	1109	no	Rheem	AP12553		no
	HSRK-7	1406	no		62-22441-01	1402, 1408	YES
Goodman	B1401009	1412 <sup>1</sup>	no		62-22669-92	1034	no
	B1401015	1121	no		62-22868-82	1411	Some
	B1401018S	1121	no		62-22868-92	1408	YES
GSW / J Woods	86483	1106	no	62-22868-93	1408	YES	
Hayward Pool	1503051401	8028	no	Roberts Gordon	90434300	no	no
HB Smith	50006	0106	no		90436600	no	no
	50018	1405	YES		90436603	no	no
Hupp Industries	09050	1402	YES	Shenandoah	10423600	8025	no
Intercity	1009604	1412 <sup>1</sup>	no	Snyder General	1380654	1403	YES
LB White	120-07549	1402	YES		1380672	1409	YES
Lennox	33J37	1119	YES		1380680	1409	YES

T-Stats & Controls



**Furnace & Heating Igniters**

OEM	OEM Part No.	Starlite Part No.	1090 KIT Compatible	OEM	OEM Part No.	Starlite Part No.	1090 KIT Compatible
Trane	B138196P01	1403	YES	White Rodgers (continued)	767A-356	1401	no
	B144676P01	1410	YES		767A-357	0557	no
	B144676P02	1407	YES		767A-361	0561	YES
	B340039P01	1408	YES		767A-365	0565	YES
	IGN21	no	no	Williamson	09050	1402	YES
	IGN23	1402	YES	York	025-27766-000	1405	YES
	IGN26	1403, 1409	YES		025-27774-000	1405	YES
	IGN30	1403, 1407	YES		025-29043-000	1405	YES
340039P01	1402	YES	025-29050-000		1405	YES	
Trianco-Htmker	2600-359	1401	no		025-32625-000	1124	no
	Uni-Line/ Robertshaw	41-238	1033, 1402		YES	025-32626-000	no
41-242		1402	YES		373-05342-700	no	no
41-401		1401	no		473-12509-001	no	no
41-402		1402	YES	Starlite	➡	0552	YES
41-403		1403	YES		➡	0557	no
41-405		1405	YES		➡	0561	YES
41-406		1406	no		➡	0565	YES
41-407		1407	YES		➡	1033	YES
41-408		1408	YES		➡	1034	no
41-409		1409	YES		➡	1056	YES
41-410		1410	YES		➡	1061	no
41-411		1411	Some		➡	1062	YES
41-412		1412 <sup>1</sup>	no		➡	1106	no
41-413		no	no		➡	1109	no
41-414	1412 <sup>4</sup>	no	➡		1119	YES	
Viessman	9302-094	1405	YES		➡	1121	no
Waterpik/Teldyne	W00431	no	no		➡	1124	no
Weil McLain	511-330-139	1409	YES		➡	1401	no
	511-330-188	1406	no	➡	1402	YES	
	511-330-193	1403	YES	➡	1403	YES	
White Rodgers	767A-301	0561	YES	➡	1405	YES	
	767A-303	0557	no	➡	1406	no	
	767A-306	0561	YES	➡	1407	YES	
	767A-309	1401	no	➡	1408	YES	
	767A-310	0565	YES	➡	1409	YES <sup>3</sup>	
	767A-350	0561	YES	➡	1410	YES	
	767A-352	0552	YES	➡	1411	Some	
	767A-353	0557	no	➡	1412	no	
	767A-354	0561	YES	➡	8028	no	

T-Stats & Controls

<sup>1</sup> – P/N 1412 does not come with clip-on bracket. Use clip-on bracket from old igniter.

<sup>2</sup> – Bracket from Nordyne kit 903758 must already be in place. P/Ns 1090 & 1405 do not come with bracket from Nordyne kit 903758.

<sup>3</sup> – The adapter brackets contained in the 1090 Kit are designed to replace these style igniters. However, in some applications only a replacement with a ceramic block identical to the OEM igniter can be used. Refer to the OEM part number in the above cross reference for the exact Starlite replacement.

<sup>4</sup> – P/N 1412 does not come with clip-on bracket or other brackets contained in the Robertshaw 41-414. Use brackets from old igniter.

**Thermostats & Controls**

**Fan & Limit Controls**

**Time Delay Relay**

- 35 to 55 seconds on
- 50 to 100 seconds off



Prod ID#	CSI#	Description	Price
914	S106-1A-45-75C	SPST Time Delay Relay	155.19

**Flame Sensor Cleaner**

- Handy flame sensor cleaner, useful in any technician's tool kit
  - Easily cleans sensors
  - Prevents false starts
  - Convenient key ring



Prod ID#	CSI#	Description	Price
71304	FSC10	Flame Sensor Cleaner	18.19

**HVAC Strap - Manifold Gauge Hanger**

Constructed from heavy-duty woven material, with a vinyl coated magnet.

- Decreases work time - put gauges where YOU want them
- Safe - keeps high voltage away from gauges
- Vinyl coated magnet will not scratch or damage unit
- Increases readability and convenience



Prod ID#	CSI#	Description	Price
73796	HVAC-STRAP	HVAC Strap - Manifold Gauge Hanger	56.71



**Bryant/Carrier Replacment Module**

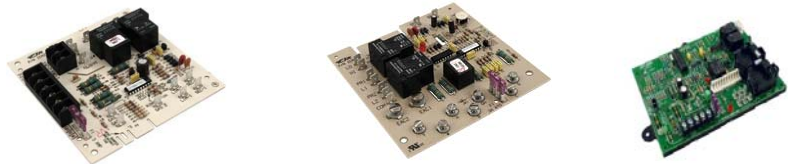

Prod ID#	CSI#	Description	Price
65899	ICM282A	Bryant / Carrier Replacement Module	365.99
70366	ICM271	Fan Blower Board OEM Replacement	132.82
70367	ICM275	Fan Blower Board OEM Replacement	145.49

**Thermostats & Controls**

**Low Ambient Kit**



Prod ID#	CSI#	Description	Volt	Price
36547	S1-ICM326HN	Low Ambient Kit	120V, 208/240V, 50/60Hz	284.50

**Jackson Systems, LLC**

**Temp-Stat™ Thermostats**

**Standard Temperatures**

- Low cost, non-adjustable, temporary construction thermostat preset to a given temperature
- Mercury-free - safe for the environment
- Heating application

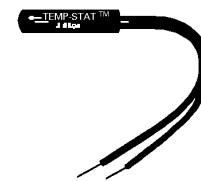

Prod ID#	CSI#	Description	Price
34805	IOTS65	Preset to 65°F	19.69

T-Stats & Controls

**Let Us be Your Source of QUALITY PRODUCTS  
and Top-Grade Merchandise from Leading  
Manufacturers.**

## Thermostats & Controls

### Thermostat Guards

#### 585-TG4

- Old No. BTG-UWM
- Most versatile guard - solid steel
- Beige steel, ring base included
- 6"H x 4"W x 3"D



Prod ID#	CSI#	Description	Price
215	585-TG4	Beige Steel, Ring Base, Metal	36.93

#### 585-TG5

- Old No. BTG-EK
- Compact design ideal f/pneumatic t-stats as well as small t-stats
- Solid base included
- 3-1/2"H x 3-1/4"W x 2-1/4"D

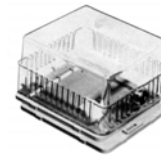

Prod ID#	CSI#	Description	Price
210	585-TG5	Clear Plastic, Solid Base	40.18

#### 585-TG6

- Old # BTGDK
- Engineered for electronic thermostats
- Ring base & solid base included
- 6-1/4"H x 3-3/4"W x 1-3/4"D



Prod ID#	CSI#	Description	Price
216	585-TG6	Clear Plastic, 2 Bases	27.15

#### 585-TG

- Old No. BTG-UK2
- Perfect for most applications
- Ring & solid bases included
- 8-1/4"H x 4-1/2" x 3-1/4"

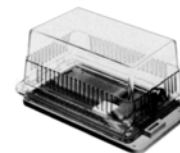

Prod ID#	CSI#	Description	Price
919	585-TG	Clear Plastic, 2 Bases	28.89

#### 585-TG2

- Old No. BTG-K
- Medium size
- Ring & solid bases included
- 4-3/4"H x 4-1/4"W x 2-3/4"D

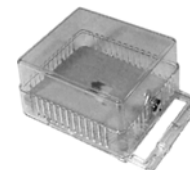

Prod ID#	CSI#	Description	Price
211	585-TG2	Clear Plastic, 2 Bases	23.89

T-Stats & Controls

**Air Conditioning Supplies**

**Torch Kits**

**HVAC Port-A-Torch Oxy-Acetylene**

- Model: 15HV601-200A DLX
- Cuts up to 1" Thick Plate
- Welds to 1/16" Plate
- Medium Duty
- Torch Handle, mixer, Cutting Tip, Cutting Attachment, Weld/Braze Tips
- Goggles, Striker, 20' 1/4" Hose, MC and 20cu Oxygen Tanks



Prod ID#	CSI#	Description	Price
74562	4400174	OXY-ACETYLENE TORCH KIT W/TANK	703.42

**Inferno® Quick Connect Acetylene Kit**

- B Tank Connection
- Tips are configured to provide reliable, repeatable flame performance
- 3/16" x 12' AxA Red Hose
- 5.20 lbs
- Crafted from 304 stainless steel tube stock



Prod ID#	CSI#	Description	Price
74563	4400084	Inferno Torch Kit Air Acetylene	494.88

**Heavy Duty Trigger Torch**

- For MAP-Pro and Propane
- Piezo igniter for instant flame
- Swirl combustion tip
- Ignition button lock for continuous use



Prod ID#	CSI#	Description	Price
74901	1400350	Heavy Duty Torch/Map-Pro LP	183.08

**Brazing Alloys**

**Dynaflo 6%**

- Oxy-Acetylene(neutral flame)
- Cu - 87.9%
- P - 6.1%
- Ag - 6%
- Melting Range: 1190°F solidus, 1465°F liquidus



Prod ID#	CSI#	Size	Price
65246	D620FMPOP	6% .050 x 1/8" x 20", 7 Sticks	30.92
3861	D620F1/66000	6% .050 x 1/8" x 20", 28 Sticks	107.83

**Stay-Silv®/Silvaloy #15**

- Oxy-Acetylene(neutral flame)
- Cu - 80%
- P- 5%
- Ag - 15%
- Melting Range: 1190°F solidus, 1480°F liquidus



Prod ID#	CSI#	Size	Price
65245	1520FMPOP	15% .050 x 1/8" x 20", 7 Sticks	58.21
59516	61035	15% .050 x 1/8" x 20", 28 Sticks	224.21

**Solder**

**Bridgit® Lead-Free**

- Contains Nickel for strong joints
- 460°F Solidus
- 630°F Liquidus



Prod ID#	CSI#	Description	Price
3860	16000/BRGT61	1/8" wire, 1 lb Spool Lead-Free	59.59

**Fluxes**

**Stay-Clean® Paste Flux**

- Works w/Leaded & Lead Free solder compositions
- Up to 700° F / 371° C
- Works w/Copper, brass, bronze, steel & galvanized



Prod ID#	CSI#	Description	Price
4107	SCPF4	4 oz Paste	11.17

**Oatey No. 5 Paste Flux**

- Effective on all metal (except Alum & Stainless Steel)
- 100% Lead Free
- Safe for potable water
- Will not tarnish copper



Prod ID#	CSI#	Description	Price
60619	30014	8 oz No. 5 Paste	15.62

**Your Business is Important to Us. We Offer the Best in Service, Quality and Price.**

A/C Supplies

**Torches & Torch Kits**

**Acetylene Torches**

**Extreme™ Self-Igniting Torch Kits**

- Extreme™ Swirl Technology
- Quick disconnect handle and tip
- AH-12 Hose
- G4 handle
- MC tank connections
- Includes gauge guards, cylinder wrench and instruction manual
- Color-coded "O" rings
- Regulator: AR-MC
- 3-Year warranty



Prod ID#	CSI#	Tip	AA Soft Solder To:	Price
63278	PL-8ADLX-MC (0386-0834)	PL-8A	2"	387.88

**Propane & MAPP Torches**

**Extreme™ STK Torches**

- Extreme™ Swirl Technology
- 360° Interchangeable swivel tips
- STK-R Pressure Regulator w/CGA-600 Connection
- Easy to clean orifice screws
- Includes instruction manual
- 3-Year Warranty



Prod ID#	CSI#	Tip	LP Soft Solder To:	MAPP Soft Solder To:	Price
63276	STK-99 (0386-0851)	ST-33	1/4" - 3"	1/4" - 3-1/2"	162.91

**Extreme™ Self-Lighting Torches**

- Ideal for HVAC and high capacity applications
- Self-lighting triggers
- Quick disconnect couplings between handle & tips
- MAP-Pro/LP Gas
- 3-Year warranty



Prod ID#	CSI#	LP Soft Solder To:	MAPP Soft Solder To:	Price
63279	TX-504	3/4" - 3"	3/4" - 4"	192.23

**Turbo Torch Accessories**

Prod ID#	CSI#	Description	Price
65276	L-1	Single Flint Striker	15.34
65281	F-1	Flints for L-1 (5 Pack)	12.39

**Oxy-Acetylene Kits**

**CutSkill - CST Series Kits - With Tanks**

- Ideal for light-duty cutting, brazing and heating jobs
- Braze/weld 1/4" to 1-1/2" & cut 1/2" for HVAC, maintenance & repair
- Kits include:
  - Handle SKH-7A
  - Oxygen regulator SKR-540R
  - Fuel regulator SKR-200R
  - 12-1/2" Dual "A" 3/16 hose 252-03P
  - Brazing nozzles 0-W-J & 2-W-J
  - Goggle/glasses 1423-0017
  - Striker 1423-0023
  - Check Valves
  - Hose 252-03P
  - Tote case 1421-0084
- 3-year Warranty



Prod ID#	CSI#	Fuel Cylinder	Oxy Cylinder	Price
63281	CST-CPT (0386-1323)	Type MC 10cu. ft.	Type R 20cu. ft.	709.76

**Nitrogen Purge Kits**

**Applications include:**

- Pressure checking HVAC and refrigeration lines
- Flush drainage lines
- Blow clean components
- Purge lines prior to brazing



**Kits include:**

- 36" x 1/4" Standard charging hose (CH-36)
- 72" x 1/4" Standard charging hose (CH-72)
- Blow gun (BG-NPK)
- Nitrogen regulator (245-03P) 0-500 PSI
- CO<sub>2</sub> Adapter (CO2-NPK)
- Turbo Tornado™ (TT-1)
- 1/2" Cone plug (CP-1)
- 3/4" Cone plug (CP-2)
- Needle tip (NT-1)
- 3-Year Warranty

Prod ID#	CSI#	Description	Price
63282	NPK-TT (0386-1370)	Nitrogen Purge & Blow Gun Kit	414.63

A/C Supplies

**Torches & Torch Kits**

**Nitrogen Regulator**

- H.P. Guage 4,000PSIG 28,000 KPA
- L.P. Guage 600PSIG 4,200 KPA
- Delivery Range 0-500 PSIG 0-3500KPA



Prod ID#	CSI#	Description	Price
69690	245-03P	Nitrogen Regulator	160.50

**Gas & Tanks**



**Acetylene**

Prod ID#	CSI#	Type	Price
60643	MC	MC	341.48
60640	B	B	458.39

**Oxygen**

Prod ID#	CSI#	Weight	Price
60642	20CF OXYGEN	20 cf	379.42
60646	40CF OXYGEN	40 cf	481.50

**CO2**

Prod ID#	CSI#	Weight	Price
60649	5LB CO2	5 lb	341.48
60651	10LB CO2	10 lb	514.33
60653	15LB CO2	15 lb	581.78
60656	20LB CO2	20 lb	766.55

**Nitrogen**

Prod ID#	CSI#	Weight	Price
60658	20CF NITROGEN	20 cf	379.42
60660	40CF NITROGEN	40 cf	543.84

**Gas Refill Kits**

**Acetylene Refill Kits**

Prod ID#	CSI#	Type	Price
60710	MC REFILL	MC	63.24
60711	B REFILL	B	77.04

**Oxygen Refill Kits**

Prod ID#	CSI#	Weight	Price
60712	20CF OXYGEN REFILL	20 cf	34.44
60713	40CF OXYGEN REFILL	40 cf	53.93

**CO2 Refill Kits**

Prod ID#	CSI#	Weight	Price
60714	5LB CO2 REFILL	5 lb	37.94
60715	10LB CO2 REFILL	10 lb	54.81
60716	15LB CO2 REFILL	15 lb	71.67
60717	20LB CO2 REFILL	20 lb	80.89

**Nitrogen Refill Kits**

Prod ID#	CSI#	Weight	Price
60718	20CF NITROGEN REFILL	20 cf	42.16
60719	40CF NITROGEN REFILL	40 cf	50.59

**Refrigerant**

**Freon Refrigerants**

- Please call for pallet pricing



Prod ID#	CSI#	Description	Price
47260	R410A	R-410A 25# Refrigerant	241.56
19872	R22	R-22 30# Refrigerant	1194.39
74526	R421A	R-421A Freon 25#	479.36
74144	R407C	R-407C Freon 25#	298.85

*We feature the  
brand name  
products you  
are looking for!*

A/C Supplies

**Air Conditioning Supplies**

**Line Sets**

**1/2" Insulation with 90° Bends**

- 610 - 3/8" X 5/8"
- 612 - 3/8" x 3/4"
- 614 - 3/8" x 7/8"
- 618 - 3/8" x 1-1/8"



Prod ID#	CSI#	Length	Liq Line	Suct Line	Price
68265	2061012B	20'	3/8"	5/8"	161.56
68267	3061012B	30'	3/8"	5/8"	212.89
69638	3561012B	35'	3/8"	5/8"	254.17
68268	5061012B	50'	3/8"	5/8"	328.77
68269	2061212B	20'	3/8"	3/4"	177.99
68270	3061212B	30'	3/8"	3/4"	240.94
69985	3561212B	35'	3/8"	3/4"	275.96
68271	5061212B	50'	3/8"	3/4"	370.43
68272	2061412B	20'	3/8"	7/8"	229.90
68273	3061412B	30'	3/8"	7/8"	311.59
71189	3561412B	35'	3/8"	7/8"	356.98
68274	5061412B	50'	3/8"	7/8"	479.51
52544	2061812B	20'	3/8"	1-1/8"	308.45
52545	3061812B	30'	3/8"	1-1/8"	418.39
69672	5061812B	50'	3/8"	1-1/8"	644.41

**Line Sets**

**3/4" Insulation with 90° Bends**

- 610 - 3/8" x 5/8"
- 612 - 3/8" x 3/4"
- 614 - 3/8" x 7/8"
- 618 - 3/8" x 1-1/8"



Prod ID#	CSI#	Length	Liq Line	Suct Line	Price
77680	2061034B	20'	3/8"	5/8"	171.80
77681	3061034B	30'	3/8"	5/8"	230.93
77682	5061034B	50'	3/8"	5/8"	356.79
77683	2061234B	20'	3/8"	3/4"	184.03
77684	3061234B	30'	3/8"	3/4"	260.01
77685	5061234B	50'	3/8"	3/4"	401.22
77694	2061434B	20'	3/8"	7/8"	237.73
77695	3061434B	30'	3/8"	7/8"	336.34
77696	5061434B	50'	3/8"	7/8"	519.44
77697	2061834B	20'	3/8"	1-1/8"	319.01
77698	3061834B	30'	3/8"	1-1/8"	451.71
77699	5061834B	50'	3/8"	1-1/8"	698.14

**White PE Defender Linesets**

- Flexible Polyethylene PE Coated Therma Ins.
- White in Color
- Meets ASTM C 1427 Specification
- Temperature Range -200 to 200 deg F



Prod ID#	CSI#	Length	Liq Line	Suct Line	Price
75682	W12-20612B	20'	3/4"	3/8"	178.38
75684	W12-30612B	30'	3/4"	3/8"	241.10
73787	W12-50612B	50'	3/4"	3/8"	390.34
75686	W12-20614B	20'	7/8"	3/8"	252.52
75687	W12-30614B	30'	7/8"	3/8"	326.26
73790	W12-50614B	50'	7/8"	3/8"	507.44

**Mini-Split Lineset**

**1/2" Insulated with Plain End**

- 406 - 1/4" x 3/8"
- 408 - 1/4" x 1/2"
- 410 - 1/4" x 5/8"
- 610 - 3/8" x 5/8"



Prod ID#	CSI#	Length	Liq Line	Suct Line	Price
38969	40620250B6	25'	1/4"	3/8"	174.87
53250	40620500B6	50'	1/4"	3/8"	320.02
38971	40820250B6	25'	1/4"	1/2"	180.78
53251	40820500B6	50'	1/4"	1/2"	330.70
38973	41020250B6	25'	1/4"	5/8"	188.51
56271	41020500B6	50'	1/4"	5/8"	344.70
49926	61020250B6	25'	3/8"	5/8"	204.92
53254	61020500B6	50'	3/8"	5/8"	370.11

**Mini-Split Lineset**

**3/4" Insulated with Plain End**

- 406 - 1/4" x 3/8"
- 408 - 1/4" x 1/2"
- 410 - 1/4" x 5/8"
- 610 - 3/8" x 5/8"



Prod ID#	CSI#	Length	Liq Line	Suct Line	Price
78444	40630250B6	25'	1/4"	3/8"	204.00
78342	40630500B6	50'	1/4"	3/8"	371.50
78360	40830250B6	25'	1/4"	1/2"	209.90
78343	40830500B6	50'	1/4"	1/2"	381.46
78445	41030500B6	50'	1/4"	5/8"	399.60
78347	61030250B6	25'	3/8"	5/8"	241.81
78348	61030500B6	50'	3/8"	5/8"	429.55



**Air Conditioning Supplies**

**White Mini-Split Lineset**

- **1/2" Insulated**
- Tear Resistant
- UV Resistant
- Paintable
- 1 foot markings for length cutting



**164' & 82' Rolls**

Prod ID#	CSI#	Length	Size	Price
70599	F100.GUS1416412	164'	1/4"	496.58
70600	F100.GUS3816412	164'	3/8"	702.47
71491	F100.GUS1216412	164'	1/2"	908.35
71634	F100.GUS5816412	164'	5/8"	1096.80
73464	F100.GUS348212	82'	3/4"	758.96

**By The Foot - 1' pricing - 1/2" Insulation**

Prod ID#	CSI#	Length	Size	Price
71653	12-PDM14PF	1'	1/4"	3.66
71654	12-PDM38PF	1'	3/8"	5.14
71655	12-PDM12PF	1'	1/2"	6.64
71656	12-PDM58PF	1'	5/8"	8.29
77765	12-PDM34PF	1'	3/4"	11.09

**White Mini-Split Lineset**

- **3/4" Insulated**
- Tear Resistant
- UV Resistant
- Paintable
- 1 foot markings for length cutting



**50' Rolls**

Prod ID#	CSI#	Length	Size	Price
77178	F100.GUS145034	50'	1/4"	219.27
77179	F100.GUS385034	50'	3/8"	302.85
77180	F100.GUS125034	50'	1/2"	382.63
77181	F100.GUS585034	50'	5/8"	473.50
77182	F100.GUS345034	50'	3/4"	637.65



**Lineset Flex Guards**

**Fits over 1/2" Insulation on:**

- 5/8", 3/4" & 7/8" tubing



Prod ID#	CSI#	Size	Price
75030	72E-B	1/2" Insul. E-Flex Guard 6'	75.63

**Fits over 3/4" Insulation on:**

- 5/8", 3/4" & 7/8" tubing

**Fits over 1/2" Insulation on:**

- 1-1/8" tubing



Prod ID#	CSI#	Size	Price
77972	72C-B	3/4" Insul. E-Flex Guard 6'	76.46

**Aluminum Tubing Pilot Kit**



Prod ID#	CSI#	Size	Price
77303	S1-11-293	1/4" x 5' Alum Pilot Kit	41.45

**Type M Copper - Color Code Red**

**Type M Hard Red Straight Lengths**

**Type M Hard Red - 10' Lengths**



Prod ID#	CSI#	Size	Price
3583	58OD.10CT	5/8"OD x 10' Cop Pipe (1/2"Nom)	29.47
3584	78OD.10CT	7/8"OD x 10' Cop Pipe (3/4"Nom)	46.46

A/C Supplies

**Piping**

**Type M Copper - Red - 10' Lengths**



Prod ID#	CSI#	Size	Price
61323	11D.10CP	1" ID x 10" Cop Pipe (7/8"Nom)	56.62
61322	114ID.10CP	1 1/4" ID x 10' Cop Pipe (1"Nom)	82.34

**A/C Refrigeration Copper Tubing - Blue**

Refrigeration Tubing Blue Coils  
Refrigeration ASTM B280 - 50' Coils



Prod ID#	CSI#	Size	Price
3585	14OD.50CT	1/4"OD x 50' Refrig Tubing	71.48
3586	38OD.50CT	3/8"OD x 50' Refrig Tubing	105.43
3587	12OD.50CT	1/2"OD x 50' Refrig Tubing	150.10

**Copper Flare Nuts & Unions**

Prod ID#	CSI#	Size	Price
67682	ANS4C	1/4" Forged Flare Nut	3.18
67683	ANS4E	3/8" Forged Flare Nut	3.18
67686	ANS4F	1/2" Forged Flare Nut	4.33
67679	DU2-4	1/4" OD Flare Union	3.89
67680	A42E	3/8" OD Flare Union	4.17
67681	A42F	1/2" OD Flare Union	6.39

**ZurnPEX Non-Barrier Tubing & Accessories**

- Cross-Linked high density polyethylene
- ASTM F876/F877 & CSA B137.5
- Use for hot and cold water distribution



Prod ID#	CSI#	Size	Price
74823	Q0PC50	1/4"OD x 50' Pex Tubing	39.44
74824	QBF0	1/4" OD Pex Ferrule (100pk)	57.78



**Lineset Snap Clamps**

**Universal Mounting Brackets**



- Pre-mounted brackets provide an easy one-man installation job that is literally a snap
- UV protected
- Multi-use applications including copper, PVC & ABS pipe
- Maintenance free - use indoors or out
- Eliminates vibrations & noise call backs
- Easy to re-open for an addition or custom adjustment

Prod ID#	CSI#	Description	Price
29698	118.4LSC (41118)	Residential 1-1/2" OD	1.39
79028	2.4LSC (41125)	Commercial 2" OD	3.58



**Equipment Pads**

**Plastic Condensor Pads**



- Lightweight - 80% lighter than pre-cast concrete
- Solid wall construction
- Chemical resistant, UV stable

Prod ID#	CSI#	Description	Price
34321	EL1838-3	18" x 38" x 3"	69.14
65006	EP2424-3	24" x 24" x 3"	47.74
65007	EP3030-3	30" x 30" x 3"	69.46
74433	EP3232-3	32" x 32" x 3"	80.63
65008	EP3636-3	36" x 36" x 3"	87.97
65196	EP3648-3	36" x 48" x 3"	130.93
65249	EL3842-3	38" x 42" x 3"	142.32

A/C Supplies

**Air Conditioning Supplies**

**Hef-T-Pad Polypropylene Condensor Pads**

- Stabilization foot standard
- Stabilization flange flared out from outer walls
- Suitable for drilling to secure equip
- Heavy Duty

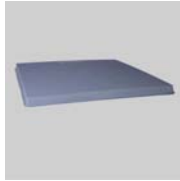

Prod ID#	CSI#	Description	Price
76424	X2424311	24" x 24" x 3" Hef-T-Pad	52.35
76425	X3030311	30" x 30" x 3" Hef-T-Pad	75.63
76426	X3232311	32" x 32" x 3" Hef-T-Pad	89.97
78526	X3244211	32" x 44" x 2" Hef-T-Pad	130.33

**Condensate Sensors**

**Aquaguard Pan Condensate Sensors**



Prod ID#	CSI#	Description	Price
56591	AG-1200+ (96106)	Float Switch	35.78
57883	AG-3150 E (96124)	2In1 Condensate Sensor w/Time Delay	64.20
78883	AG-3180 E (96128)	Plenum Rated Micro Pan Sensor w/Time Delay	59.92

**A/C Mounting Bracket**



Prod ID#	CSI#	Description	Price
53674	ACB-42	42" A/C Mounting Bracket	87.10

**8" The Heat Pump Pad**

- Includes 8 Anti-vibration pads
- Made from Recycled Polypropylene
- Ideal for raising units off the ground



Prod ID#	CSI#	Description	Price
76579	HP3636-8	36" X 36" X 8" H.P. Pad	147.40

**Drain Trap Kit**

- Clear PVC trap
- Multiple Cleanouts
- Easy Maintenance
- For Condensate drain lines



Prod ID#	CSI#	Description	Price
74080	DTK113B	3/4" Drain Trap Kit w/Brush	27.15



**Suction Line Driers**



Prod ID#	CSI#	Description	Price
4273	S1-060250	3/4" SWT Suct Line Drier 13 Cu In	109.72
39200	S1-060262	7/8" SWT Suct Line Drier 13 Cu In	108.68

**Condensate Drain Pans**

**A/C Secondary Condensate Drain Pans**

- Rolled edges for durability
- Ribbed bottoms for rigidity
- 3/4" PVC Ftg's included



Prod ID#	CSI#	Bottom Dim	Drain Line Outlets	Price
42226	63263L	32" x 63" x 2"	Long side	101.40
44456	63636L	36" x 36" x 2"	Long side	81.52

**High Rise Drain Pans**

- Designed for horizontal installation
- Includes Float Switch
- ABS Construction
- Heat/Cold Resistant



Prod ID#	CSI#	Size	Price
59548	6-HK3060	30" x 60" x 4.5"	183.63

**Liquid Line Filter Driers**

- High moisture & acid capacity
- Compatible w/all existing & new refrigerants/blends
- Compatible with new polyester oils
- Spring loaded
- Solid copper SWT fittings



Prod ID#	CSI#	Description	Cu In	Price
4266	S1-LFD083S	3/8 SWT	8	23.79
4268	DAD-163	3/8 Flare	16	55.43
4270	S1-LFD163S	3/8 SWT	16	26.49

A/C Supplies

**Air Conditioning Supplies**

**Sight Glass**

Prod ID#	CSI#	Description	Price
61507	DPSG-3S	3/8 SWT Sight Glass	45.25

**Nitrogen Purge Tool**

- Adjustable Dial
- Accurately regulates flow and volume for purging or brazing
- Quickly switch between Braze, Purge or Off



Prod ID#	CSI#	Description	Price
76881	DP-1	Nitrogen Purge Tool Adj Dial	117.58

**Super Change™**

- Convert system from non-POE based oils to HFC Refrigerants
- Do not need to flush the system (excluding compressor burnouts)
- Add Super Change with the new refrigerant and oil.



Prod ID#	CSI#	Description	Price
74961	981	Super Change System Retrofit	97.31

**Flex Inject® Sealant**

- No tools required
- Works on all compressors
- Won't plug metering devices
- Meets ASHRAE ARI 700



Prod ID#	CSI#	Description	Price
79108	985	Flex Inject Sealant	130.39

**Compressor Parts**

**Term Lok Compressor Repair Kit**

- Standard factory 600V, 65 strand machine wire
- Repairs burned or damaged spade terminals

Prod ID#	CSI#	Description	Price
56521	TLC-3-10	Repair Kit	84.20

**Copper Tube Fitting Brush**



Prod ID#	CSI#	Description	Price
61509	B-129	7/8" CopTube Fitting Brush	8.19

**5-2-1 COMPRESSOR SAVER®**

**5-2-1 Compressor Saver**

- Uses a multi-layer starting capacitor and smart switch to boost the compressor with less power



Prod ID#	CSI#	Description	Price
56389	CSRU1	For 1-3 Ton A/C Units, Scroll/Reciprocating	71.73
55999	CSRU2	For 3.5-5 Ton A/C Units, Scroll/Reciprocating	88.85

**Little GIANT**



**Automatic Condensate Removal Pumps**

- Fully automatic
- 1/2 Gallon leakproof, rustproof, high impact ABS tank
- 3 Drain holes
- Thermal overload protection
- 3/8" OD barbed tubing



**VCMA Series - without Tubing**

Prod ID#	CSI#	Description	Price
41494	554401 (VCMA15UL)	15' Lift - No switch	92.58
41495	554405 (VCMA15ULS)	15' Shutoff w/Safety Switch	99.24

**VCC Series**

- Pump engages in 1" of water & disengages in .45" of water
- 1/3 Gallon ABS tank



Prod ID#	CSI#	Description	Price
41496	554200 (VCC20ULS)	20' Shutoff, 115V, w/Safety Switch	149.57

A/C Supplies

**Air Conditioning Supplies**

**VCMXSeries - NxtGen**

- Slimmer Footprint
- 1/4 turn check valve - easier service
- External test/run lever



Prod ID#	CSI#	Description	Price
63609	554530 (VCMX20ULS)	21' Shutoff w/Safety Switch	125.47

**Accessories**

Prod ID#	CSI#	Description	Price
42061	CV-10 (599065)	Check Valve - Cond Pump	14.96

**Mini Ductless Condensate Pumps**

- Quiet Operation
- Designed for ductless systems
- Floatless Sensor



Prod ID#	CSI#	Description	Price
68383	CVMINI	Clear View Mini 120v or 240v	250.80

**Heat Pump Risers**

- One Piece Heavy Duty Plastic
- Butyl Matsic on Top and Bottom
- For no slipping.
- Reduced Vibration and Noise



Prod ID#	CSI#	Description	Price
59712	HPR-6	Heat Pump Riser - 6"	10.41
59713	HPR-12	Heat Pump Riser - 12"	21.52



**Medium Condensate Pump**

- Patented airflow design resulting in quiet pump operation
- Dual-float design
- Stronger motor for increased flow
- Mount the pump from either side
- Max lift is 17'
- Pump comes with a 6' cord set



Prod ID#	CSI#	Description	Price
73116	CB151LSUL	No Switch Beckett 15' Pump	88.08
73117	CB151UL	Beckett 15' Pump/Switch	94.41

**Wet Switch Flood Detector**

- Solid state control designed to help prevent flooding
- Turns system off when detecting moisture due to condensate or drain leaks
- Connects to 24VAC



Prod ID#	CSI#	Description	Price
44668	WS-1	Wet Switch Flood Detector	114.90



**Condensate Pumps**

**Condensate Pumps**

- Vertical type pumping unit
- High impact ABS tank, ABS motor and tank covers, volute & impeller
- Thermally protected motor, stainless steel shaft
- Engages in 2.5" of water, disengages in 1.125"
- UL & CSA Approved



Prod ID#	CSI#	Description	Price
57063	CP-22	22' Lift 120V Condensate Pump	95.68

**Hard Start Kits**

- Solid state for all PSC compressors from 1/2 to 10 hp
- Can be used on units that operate on 120V - 288



Prod ID#	CSI#	Description	Price
3786	S1-SPP5	Starter Power Pack 300% Torque Multiplier	24.92
3787	S1-SPP6	Starter Power Pack 500% Torque Multiplier	40.14

A/C Supplies

## Air Conditioning Supplies

### Time Delays

#### Adjustable Delay on Make Timer

- Ideal for random starting of multiple units
- Adjusts from 6 seconds to 8 minutes
- Spin-proof knob
- Works with 24, 120 or 240VAC control circuits
- Supports up to 1.5 Amps
- 2 Wire hookup



Prod ID#	CSI#	Description	Price
1942	ADM-1	Adjustable Delay on Make	21.49

### Piercing Valves

#### "MAC" Line Piercing Valve

- Uniport, one connection for piercing & servicing
- Needle automatically back seats after servicing



Prod ID#	CSI#	Tube Size	Price
4254	QTM-1	1/4", 5/16", 3/8" OD Tube Size	15.54
4256	QTM-2	1/2", 5/8" OD Tube Size	16.77

### Valve Core Storer

- All steel valve core remover & storage container
- Knurled for easier grip



Prod ID#	CSI#	Description	Price
3838	VCR-1	Core Remover & Storer	21.76

### Polyethylene Tubing

- Ideal for drinking water lines, evaporator coolers, & radiant heating
- Non-toxic
- PSI @ 70F: 150



Prod ID#	CSI#	Description	Price
2345	PE-104	1/4" OD x 100'	43.35

### Clear Vinyl Tubing

- For air conditioning & refrigeration condensate drains, condensate pump discharge lines & humidifier overflows



Prod ID#	CSI#	Description	Size	Price
56597	7-14	1/4" ID	100'/Roll	34.95

### Clear Vinyl Tubing (Continued)

Prod ID#	CSI#	Description	Size	Price
2346	7-38	3/8" ID	100'/Roll	33.71
60786	7-38P	3/8" ID	100'/Roll	34.58
22764	7-12	1/2" ID	100'/Roll	41.09
2344	7-58	5/8" ID	100'/Roll	63.90
4177	7-34	3/4" ID	100'/Roll	86.14

### Nylon Barbed Fittings

#### Adapters

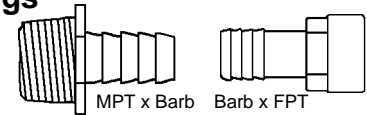

Prod ID#	CSI#	Description	Price
2370	MA-22010	1/2" Barb x 3/4" MPT	3.91
2365	MA-22012	5/8" Barb x 3/4" MPT	2.09
72614	MA-22013	3/8" Barb x 3/4" MPT	2.29

#### 90° Elbows

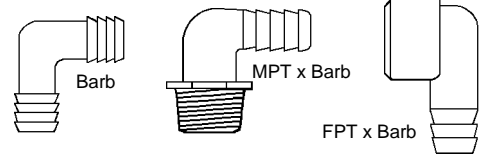

Prod ID#	CSI#	Description	Price
2367	MA-22154	5/8" Barb	3.52
2369	MA-22117	1/2" Barb x 3/4" MPT	3.26
2364	MA-22120	5/8" Barb x 3/4" MPT	3.53
36456	MA-22122	3/4" Barb x 3/4" MPT	3.69
2361	MA-22065	1/2" Barb x 3/4" FPT	6.36
2362	MA-22064	5/8" Barb x 3/4" FPT	7.03
2363	MA-22066	3/4" Barb x 3/4" FPT	6.55

#### Barb Hose Menders

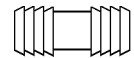

Prod ID#	CSI#	Description	Price
2357	MA-12032	3/8" Barb Hose Mender	2.29

#### Flux & Acid Brush



Prod ID#	CSI#	Description	Price
62717	AMA-001-10	3/8" Tin Hdl Flux/Acid Brush	6.26

A/C Supplies

**Air Conditioning Supplies**

**Tape**

**Cork Insulation Tape**

- Black
- Adheres firmly to all metals
- Use on hot or cold pipes to stop condensation

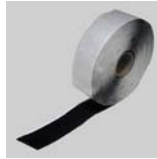

Prod ID#	CSI#	Description	Price
3258	6-330	1/8" x 2" x 30' Roll (Black)	26.94

**Foam Insulation Tape**

- Black self-adhesive foam tape use on hot or cold pipes
- Fits well around valves & Ftgs

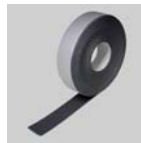

Prod ID#	CSI#	Description	Price
3259	2.30IT (69718)	1/8" x 2" x 30' Roll (Black)	17.02

**Economy Electrical Tape**



Prod ID#	CSI#	Description	Price
3256	A7 (13229)	3/4" x 60' Black Elect. Tape	2.79

**BRAMEC®**

**THUM-GUM™ Sealing Compounds**

- Non-hardening putty for larger sealing jobs
- For plugging openings through foundations & refrigeration tube entry
- Does not contain asbestos



Prod ID#	CSI#	Description	Price
2347	2TG (1004)	2 lb Box	11.27

**ROBINAIR®**

**RG3 Refrigerant Recovery Machine**

- Compact & Lightweight - 40% smaller
- Oil-less Compressor
- High Pressure Safety Shut-off Switch
- IEC Connector and power cord
- Easy to operate, rugged case



Prod ID#	CSI#	Description	Price
75774	RG3	RG3 Refrigerant Recovery Machine 115V	993.01

**Filter Dryer for recovery unit**

- 1/4" MFL x 1/4" MFL



Prod ID#	CSI#	Description	Price
76502	100343	Filter Dryer, RG3 Rec. Unit	47.24

**YELLOW JACKET®**

**Vacuum Pump Systems**

**Bullet**

- 115V/60 cycle voltage
- 25 Micron field blankoff
- 1/4" & 3/8" Male flare intake
- 6" Motor-mounted switch
- 28 oz Oil capacity
- Two stage rotary vane evacuates quickly
- 16.25"L x 6"W x 11.5"H



Prod ID#	CSI#	CFM	Motor	RPM	Weight	Price
62985	93600	7.0	1/2hp	1725rpm	31 lbs	705.72

**Vacuum Pump Oil**

- Refined & formulated for extremely low vapor pressure & high pump efficiency at all temperatures



Prod ID#	CSI#	Size	Quantity/Case	Price
1729	1PVPO	1 pt	24	15.76
76421	1QVPO	1 qt	12	21.10
1730	1GVPO	1 gal	4	65.94

## Air Conditioning Supplies

### Test Equipment

#### ManTooth™ Wireless Dual Pressure Gauge Set

- No hose or manifolds necessary
- Free downloadable ManTooth™ app wirelessly calculates and displays actual pressure, temperature, superheat, and subcooling on your iPhone®, iPad®, or Android™ device
- Screenshot feature allows you to save pressure and temperature readings which can be automatically organized by location and unit being serviced
- Built-in Schrader ports to easily adjust refrigerant charge
- Range up to 400'
- Rechargeable lithium polymer battery provides up to 10 hours battery life
- Pressure range: 0 - 700 psia
- Temperature range: -40 - 266°F
- Maximum cord temperature: 176°F
- Maximum clamp temperature: 203°F
- (98) NIST Refrigerant profiles included
- Includes:
  - P/T Module
  - Tether unit with boots
  - (2) Temperature probe clamps
  - (2) USB cables
- 2-Year warranty



Prod ID#	CSI#	Description	Price
71450	67002	ManTooth™ Wireless Digital Dual P/T Gauge	520.88

### SealRight™ Quick Couplers

- SealRight™ fitting traps refrigerant in hose when disconnected helping meet non-venting regulations & preventing finger burns
- 1 Piece design - attaches quickly
- Works with or without Schrader core
- Field serviceable

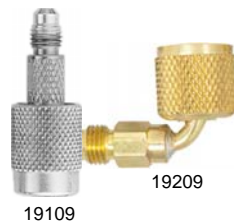

Prod ID#	CSI#	SealRight™ x Male	Price
51098	19109	1/4" Straight x 1/4" Flare	34.69
51099	19209	1/4" 90° x 1/4" Flare	35.40

### Series 41 Manifolds

- No hoses
- 2-Valve
- Forged brass
- 1% Accuracy over full range
- 3-1/8" Gauges



Prod ID#	CSI#	Description	Price
50315	42001	R-22/404A/410A	129.89

### Series 41 Manifold Sets With Hoses

- 2-Valve
- Forged brass
- 1% Accuracy over full range
- Includes 60" Plus II™ RYB hose
- 3-1/8" Gauges



Prod ID#	CSI#	Description	Price
50317	42004	R-22/404A/410A	216.30

### Yellow Jacket® Vacuum & Charging Hoses

#### Yellow Jacket® Plus II™ 1/4" Charging Hoses With Double Barrier Protection

- Double barrier protection for CFC, HCFC & HFC control & system performance
- Nylon permeation barrier
- Moisture barrier
- 4000 psi Minimum burst
- 800 psi Maximum working pressure = 5 to 1 safety factor
- Replaceable gaskets
- Performance-proven six-sided crimping
- Date coded with year of manufacture to help in safety program management
- Full size brass nuts for easier tightening & longer life

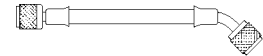

#### With Comact Ball Valve End



Prod ID#	CSI#	Color	Length	Price
62986	29985	R/Y/B	60"	218.18
64868	29660	RED	60"	76.56
64867	29060	YELLOW	60"	82.80
61197	29260	BLUE	60"	86.77

A/C Supplies



**Air Conditioning Supplies**

**HAV Type Standard with SealRight Low Loss Anti-Blowback fitting**

- 45° End for use in tight areas
- Low loss Anti-Blow back seals
- Hoses rated for 800PSI (55BAR) Max working pressure



Prod ID#	CSI#	Color	Length	Price
61435	22985	R/Y/B	60"	168.78

**Ball Valve Adapter 3-Pk Set**

- Contains: 29001, 29201, 29601



Prod ID#	CSI#	Description	Price
56480	29980	R/Y/B 9" Ball Valve Adapt (3pk)	164.10

**Manifold Parts**

**Pressure Gauges (°F)**

Prod ID#	CSI#	Description	Price
54045	49137	3-1/8" Red Compound 0-800 psi R-22, R-404A, R-410A	45.42
54046	49138	3-1/8" Blue Compound 0-300 psi R-22, R-404A, R-410A	45.42

**Replacement Lens**

Prod ID#	CSI#	Description	Price
50844	49100	80mm Replacement Lens for 3-1/8" Gauges	16.50

**Charging Accessories**

**4-In-1 Vacuum/Charge Ball Valve & Core Tool**

- Extra 1/4" side port to attach electronic micron vacuum gauge right at system for greater accuracy
- Core removal access to evacuate & charge through an unrestricted line for increased speed & higher vacuum
- Core replacement
- Core removal allows recovery unit to work at maximum efficiency, speeding the recovery process



Prod ID#	CSI#	Description	Price
58302	18975	Vacuum Charge Ball Valve	116.56

**Quick Coupler Gaskets**

- Designed for optimum performance with Yellow Jacket® charging hoses
- Works with all refrigerants
- Manufactured to strict tolerances to resist blow-out



Prod ID#	CSI#	Description	Price
56476	19020	CH20 for 1/4" Hose, 5/16" Hose, and 1/2" Acme Hose, 10/Pk	16.09
53991	19037	1/4" SealRight™ O-Ring, 10/Pk	23.94

**Yellow Jacket® Tools**

**Fan Blade Puller**

- Heavy duty steel construction
- 5/8" Steel center shaft
- 4 Pull fingers
- Removes pulleys & sheaves
- Removes squirrel cage type blower wheel



Prod ID#	CSI#	Description	Price
58645	MA-FB2	Fan Blade Puller Complete	83.83

**Service Wrench - Offset**

- Knuckle-Saver™ design for tight areas
- Square openings 1/4" & 3/16" at one end; 3/8" & 5/16" at other end



Prod ID#	CSI#	Description	Price
54496	60616	Offset Service Wrench	31.98

**Deluxe 45° Flaring Tool**

- Automatic tube height gauge for correct tubing height
- Designed for R410A
- Self-centering yoke grips without marring or constricting tube
- Made in the USA



Prod ID#	CSI#	Description	Price
78515	60278	Delux 45 Deg Flaring Tool	249.76

**Eccentric Cone Flaring Tool - ON PHASE OUT**

- Black oxide-finished steel flaring bars
- Recommended for soft materials such as copper and aluminum



Prod ID#	CSI#	Description	Price
58303	60295	Eccentric Cone Flaring Tool	225.28

## Air Conditioning Supplies

### Oil Injector Tool



Prod ID#	CSI#	Description	Price
71579	69562	4 oz. Oil Injector Tool	154.04

### 8 Head Torque Kit 10-80 MM



- Designed to accommodate the full range of ductless mini-split flare nut sizes and torque requirements.
- Fully adjustable to accommodate a variety of flare nut sizes
- Durable, easy-to-use and more adjustable than other flare nut torque wrenches on the market.
- Intuitive, easy-to-use settings and adjustments

Prod ID#	CSI#	Description	Price
72130	60652	8 Head torque Kit 10-80MM	274.98

### Tubing Tools

#### Multiswage



- Handy all-in-one tool
- Produces perfect solder cups for 9 OD tube sizes

Prod ID#	CSI#	Description	Price
1750	T21000	3/16", 1/4", 5/16", 3/8", 7/16", 1/2", 5/8", 3/4" & 7/8" O.D.	111.45

### Copper Tube Extensions



Prod ID#	CSI#	Description	Price
1700	A31002	1/8 OD Tube Extension -5PK	31.64
1701	A31003	3/16OD x 1/8ID Tube Extens-5PK	31.89
1702	A31004	1/4OD x 3/16ID Tube Extens-5PK	32.14
1704	A31006	3/8OD x 5/16ID Tube Extens-5PK	36.55



### Refrigeration Leak Sealant

#### A/C EasySeal Direct Inject



- Seals and prevents A/C leaks
- Up to a 5 Ton System
- Eliminates expensive leak search

Prod ID#	CSI#	Description	Price
71577	4050-08	EasySeal Direct Inject	122.11
76242	4050-11	EasySeal Direct Inj. w/UV Dye	124.33

### UV Leak Detection Kit



- High Intensity light finds UV leak
- Up to a 5 Ton System
- Eliminates expensive leak search
- UV Light and Glasses included

Prod ID#	CSI#	Description	Price
78005	4050-15	UV Leak Detection Kit	70.20



### Tools & Replacement Parts

#### 1/4" Valve Core Tool



- Hollow handle for storage
- Furnished with 6 extra cores

Prod ID#	CSI#	Description	Price
1721	JBA32004	1/4" (5Pk)	23.08

### O-Ring Quick Seal Caps



- Refrigeration or deep vacuum service
- Finger tight sealing for all male SAE connections

Prod ID#	CSI#	Description	Price
1745	NFT54	1/4" SAE Cap (10/Pk)	17.10

### 1/4" Replacement Valve Cores



Prod ID#	CSI#	Description	Price
1720	A31999	1/4" Valve Cores (5Pk)	10.08

A/C Supplies

**Air Conditioning Supplies**

**Refrigeration & Air Conditioning Flush**

**Rx11-Flush®**

- Ozone-safe solvent for flushing refrigeration and air conditioning systems/line sets
- Rinses away particulate, sludge, carbon residues, acids, oils and water
- Flushes line sets for R-410A conversions



Prod ID#	CSI#	Description	Price
63047	4300-08	Rx-11 Starter Kit	246.45
53888	4300-09	1 lb Canister	109.05
58404	4300-10	Start-Up Pack 2+1	553.03
58405	4300-50	Rx-11 Line Set Tool	27.08
63198	4300-51	Rx-11 Flush Gun	72.08
64958	4300-89	Rx-11 Flush Injection Valve	66.39

**Evaporator Coil, Condensor Coil & Filter Cleaners**

**Blackhawk™**

- Expanding Foam, Non-Fragrant Coil Cleaner HVAC/R Equipment in Food Processing Areas
- Non-Rinse for Evaporators
- Nonflammable & Biodegradable



Prod ID#	CSI#	Description	Price
77990	4127-75	18oz Blackhawk Expand Foam Coil Cleaner	17.55

**Special HD CalClean®**

- Evaporator Coil Cleaner, Condensor Coil Cleaner, EAC Filters, Permanent Filters, and Fan Blades
- For removing tobacco tars & other stubborn stains on electronic air filters
- Biodegradable degreaser



Prod ID#	CSI#	Description	Price
50726	4143-08	1 gal Special HD CalClean®	63.37

**Evap-Fresh®**

- Indoor Evaporator Coil Cleaner
- Effectively cleans as well as kills mold, slime and bacteria
- "No rinse required" condenser coil cleaner
- One-step cleaner



Prod ID#	CSI#	Description	Price
58395	4166-75	18 oz Aerosol Can	24.47

**Evap Pow'r®**

- Indoor Evaporator Coil Cleaner
- Cleans & emulsifies
- No-rinse product
- Metal safe
- Highly Concentrated - Use 3 to 1 water ratio



Prod ID#	CSI#	Description	Price
18916	4168-08	1 gal Evap Pow'r®	44.61

**Evap Foam®**

- Indoor Evaporator Coil Cleaner
- Self-Rinsing, fast-breaking foam
- Pleasant lemon scent
- Cleans and deodorizes
- Spray from any angle - right side up, or upside down
- 18 Oz Can



Prod ID#	CSI#	Description	Price
53958	4171-75	Evap Foam No Rinse	22.05

**Foam Brite™**

- Condensor Coil Cleaner
- Biodegradable
- Extremely high foam
- Do **NOT** use on evaporator coils
- Not recommended for Mini-Splits



Prod ID#	CSI#	Description	Price
50725	4178-08	1 gal Foam-Brite® Non-Acidic	51.84

**Green Clean**

- Evaporator Coil & Condensor Coil Cleaner, Fan Blades too
- All purpose cleaner
- Rapidly removes grease & other heavy soils
- Non-corrosive



Prod ID#	CSI#	Description	Price
58390	4186-24	1 qt Spray Cond/Evap Coil Clnr	29.66

A/C Supplies

## Air Conditioning Supplies

### Cal-Green®

- Condensor Coil Cleaner
- Non-Foaming
- Brightens as it cleans
- Biodegradable - Environmentally Friendly
- Can be used on Mini-Split Condensor Coils



Prod ID#	CSI#	Description	Price
60956	4190-08	1 gal Green Select Coil Cleaner	50.88

### Nu-Blast® Condenser Coil Cleaner

- Condenser Coil Cleaner
- "No rince required"
- High pressure blast plus solvent cleaning
- Only use with adequate ventilation



Prod ID#	CSI#	Description	Price
53959	4290-75	18 oz Aerosol Can	32.19

### Nu-Brite™

- Condensor Coil Cleaner
- Biodegradable
- High Foaming
- Brightens the condenser coil
- Safer than acid
- Cuts through grease and grime better than acids



Prod ID#	CSI#	Description	Price
10823	4291-08	1 gal Nu-Brite® Non-Acidic	42.04

### Tri-Pow'r™ HD

- Evaporator Coil & Condensor Coil Cleaner
- General purpose coil cleaner
- Detergency, degreasing & deodorizing capability
- Non-acid, non-toxic & biodegradable
- Residential coil cleaner



Prod ID#	CSI#	Description	Price
58401	4371-88	1gal Tri-Pwr HDCond/Evap Clnr	36.50

### TriClean 2x Coil Cleaner

- Condensor Coil Cleaner
- Quart sprayer with hose connector
- For the annual cleaning of residential and light commercial outdoor air conditioning coils



Prod ID#	CSI#	Description	Price
66898	4372-24	TriClean 2x Coil Cleaner, 1 Quart	48.14

### Talon® Flexible Aerosol Wand

- 27" Length Accessory
- Used with Evap-Fresh No Rinse
- Used with Evap Foam No Rinse
- Used with Penetrate HD



Prod ID#	CSI#	Description	Price
76241	4776-0	27" Flexible Aerosol Wand	44.36

### Penetrate HD®

- Frees frozen, rusted or seized parts
- 12oz can
- Lubricates and protects metals
- For Industrial and Professional use



Prod ID#	CSI#	Description	Price
76243	61105	12 oz Aerosol Can	30.54

### A/C Shine Aerosol Cleaner

- Clean and protect painted metal surfaces of outdoor A/C condensing units
- Sprays on and wipes off without water



Prod ID#	CSI#	Description	Price
69696	61118	A/C Shine Aerosol Cleaner	27.01

### Gas Leak Detectors

#### Cal-Blue® Plus Gas Leak Detector

- Complete, detects smallest leak
- High viscosity liquid stays in contact with applied surface for extended time
- Non-corrosive and will not effect ultraviolet lights
- Freeze protected to 5°F
- USDA approved



Prod ID#	CSI#	Description	Price
58393	4182-24	1 qt Spray Bottle	21.72

A/C Supplies

**Air Conditioning Supplies**

**Cal-Blue® Plus Gas Leak Detector (Continued)**

Prod ID#	CSI#	Description	Price
77991	4182-35	7oz Pressurized Spray	15.25
58392	4182-53	6 oz Bottle With Dauber	13.37

**No 4184 Gas Leak Detectors**

- Fluorescent Formula
- Non-Corrosive to metal
- Freeze protected to 5 Deg F
- USDA approved



Prod ID#	CSI#	Description	Price
58391	4184-53	Gas Leak Detector-Fluorescent	14.48

**Specialty Products**

**A/C Re-new (Unpressurized) 4 oz.**  
A/C Re-New is an exciting, new branding of Zerol Ice for residential air conditioning systems.

- Quiets noisy compressors.
- Reduces energy consumption.
- Improves heat transfer in the evaporator and condenser.
- Great for new and old systems.



Prod ID#	CSI#	Description	Price
71580	4057-55	A/C Re-New (Unpressurized) 4 oz.	158.38

**Break-n-Lube**

- Penetrates, lubricates, displaces moisture, and provides superior resistance to corrosion
- Made with CERFLON®



Prod ID#	CSI#	Description	Price
58394	4128-03	12 oz Aerosol Can	18.81

**Great Wipes**

- Disposable
- Premoistened
- Industrial Strength Hand Towel



Prod ID#	CSI#	Description	Price
53970	4185-75	80 Count Bucket	41.09

**Nu-Kill Max Strike Wasp Spray**

- Instant Kill
- Provides residual kill as insects return to nest
- Does not contain any CFC's
- Kills Wasps, Hornets, Yello Jackets and scorpions



Prod ID#	CSI#	Description	Price
77989	4292-75	13.5 oz Nu-Kill Max Wasp Spray	23.04

**Pan Spray**

- Water proof rubberized coating
- Seals out rust and corrosion
- Repairs leaky condensate pans, cooling towers, swamp coolers, roofing, gutters and down spouts
- White



Prod ID#	CSI#	Description	Price
58396	4296-50	16 oz Aerosol Can	46.87

**Spray-n-Bond®**

- Web Spray-Insulation & Duct Liner Applications
- Waterproof, flexible
- Transparent, Non-staining
- VOC Compliant



Prod ID#	CSI#	Description	Price
58399	4369-75	Spray n Bond Aerosol	17.45

**Vital-Flo Tankless Water Heater Descaler Kit**

- Restores Heat and Flow Capabilities
- Desolves Scale formed by minerals in the water.
- Residential, Commercial, Industrial



Prod ID#	CSI#	Description	Price
64849	4387-01	Descaler Kit - Tankless Wtr Htr	449.74
69671	4387-02	8oz Descaler Solution Refill	19.34

**Thermo-Trap®**

- Heat absorbant to isolate heat encountered in soldering, welding, and brazing
- USDA approved



Prod ID#	CSI#	Description	Price
78004	4371-32	1qt. Spray Bottle	45.03
58400	4371-36	11 oz Tube	28.69

A/C Supplies

**Air Conditioning Supplies**

**ClenAir Odor Neutralizers**

- 1/2 lb. Tub
- Eliminates unpleasant odors from air.
- Neutralizing odors caused by smoke, mold, mildew, cat litter and pets.



Prod ID#	CSI#	Description	Price
69958	61010	1/2lb Cherry Air Neutralizer	17.06
70170	61020	1/2lb Orange Air Neutralizer	17.06

**A/C Drain Sucker Kit**

- A/C condensate drain clog repair and treatment kit



Prod ID#	CSI#	Description	Price
69984	61308	A/C Condensate drain clog repair and treatment kit	74.44

**NFP-75 Wall Sleeve**

- Telescoping 3" x 5"-7-3/4"
- Used to provide a seal when penetrating walls



Prod ID#	CSI#	Description	Price
72323	83017	Wall Sleeve 3" x 5"-7-3/4"	17.37

**EZT-113 & EZT-113B - EZ Trap Kit**

- 3/4" Economy Blow Molded Trap Kit
- Clear Trap Line
- Light Duty Applications



Prod ID#	CSI#	Description	Price
72623	83113 (EZT-113)	EZ Trap 3/4" Trap Kit NO Brush	26.75
71934	83114 (EZT-113B)	EZ Trap 3/4" Trap Kit W/Brush	27.43

**EZT-225 - Inline Universal overflow switch**

- 3/4" Kit
- Primary or Secondary Overflow



Prod ID#	CSI#	Description	Price
68784	83225 (EZT-225)	3/4" EZ-Trap Overflow Swtich	48.15

**Installation Products**

**Mighty Bracket MS Support Tool**

- Mini Split Installation Support Tool
- Hook onto mini-split mounting plate to hold mini-split unit securely in place while installing refrigerant lines, condensate line and electrical hookup.



Prod ID#	CSI#	Size	Price
71309	97705	Mighty Bracket MS Support Tool	231.87

**Insulation Products**

**Cork-Tite™ Insulation Tape**

- Insulates cold pipes
- Stops condensation problems



Prod ID#	CSI#	Size	Price
58388	4217-12	2" x 1/8" x 30' Roll	28.25

**Foam-Tite™ Insulation Tape**

- Utilizes closed-cell construction and can be used with cold water pipes, chilled water lines and refrigerant lines to prevent sweating and condensation
- Also for use on hot water lines to prevent heat loss



Prod ID#	CSI#	Size	Price
58389	4219-12	2" x 1/8" x 30' Roll	24.54

**Vacuum Pump Oil**

- High viscosity index
- Very low vapor pressure



Prod ID#	CSI#	Description	Price
58402	4383-24	1 qt Bottle	27.20

A/C Supplies

**Air Conditioning Supplies**

**Sprayers**

**Coil Gun®**

- Quick-disconnect feature
- Foam wand to enhance foaming
- 5 Mix ratio settings
- Hose-end sprayer



Prod ID#	CSI#	Description	Price
58385	4774-0	2 Quart Capacity Sprayer	165.70

**Novent Locking Refrigerant Caps**



Prod ID#	CSI#	Description	Price
66902	86662	R22 Tamper Resist Cap 2Pk	34.73
66903	86660	R22 Screwdriver Key Lock	29.85
65462	86682	R410A Tamper Resist Cap 2Pk	34.73
66904	86688	R410A Screwdriver Key Lock	29.85
66905	86698	Multi Key - Fits all caps	23.22

**Mini-Split Non-Insulated Hose**

- 16mm (5/8?) Drain Hose
- 20' Retail Pack
- Standard weight drain hose in retail pack



Prod ID#	CSI#	Description	Price
72322	83003	Mini-Split Non-Insulated Hose	34.24

**Desolv™ Cleaning Kit - Mini-Splits**

- Desolv Cleaning Solution
- C-Band Frame Assembly
- Single Use Replacement bag
- Wedge Sheets
- Drain Pail
- Instructions



Prod ID#	CSI#	Description	Price
74968	82560	Desolv Cleaning Kit - Mini-Splits	342.46



**Megabubble Leak Detector**

- Detects leaks quickly on all types of tubing valves, cylinders, pressure tanks or other systems under air, gas or oxygen pressure
- Functions in a -50 to +200°F temp range
- Slow evaporation rate



Prod ID#	CSI#	Size	Price
4681	45802	1 qt Spray Bottle	31.29

**All-Flash® No-Calk® Roof Flashings/Thermoplastic Base**

- Patented All-Flash® design allows use on multiple pipe sizes.
- Thermoplastic base.
- Rated 180°F continuous heat and approved for Type B installations.
- Plastic base for pitch from 0-45°.
- Self-sealing collar slides over pipe and requires no caulking.
- Do not use petroleum based products or paint on flashing collar or plastic base. Not for hot-mopped or built-up roofs.



Prod ID#	CSI#	Size	Price
72293	11919	1 1/2" - 3" Thermoplastic NCF	11.17
72294	11920	3" - 4" Thermoplastic NCF	22.47

**Access Panel**

- Installs between all studs or ceiling joints
- Flush or surface-mounted frame
- Paintable
- Door requires screwdriver for child safety



Prod ID#	CSI#	Size	Price
77496	34056	14"x14" Plastic Access Panel	40.15

A/C Supplies

**Air Conditioning Supplies**

**DWV J-Hooks - White**

- 7-1/2" Long
- Pre-loaded Nails in stem
- Locking finger for thigh hold
- Temp range: -40 to 180 F



Prod ID#	CSI#	Size	Price
79114	33741	2" DWV J-Hook	1.54
79115	33742	3" DWV J-Hook	1.66



**Leak Detectors**

**Flash™ UV Detection Kit**

- 3 Cans of Flash Dye
- Reusable Hose
- Heavy-duty storage case
- Rechargeable UV LED Light



Prod ID#	CSI#	Description	Price
76456	98087KIT	Flash UV Leak Detection Kit	311.20

**Radiant Leak-Finder**

- Viscous leak detector w/radiant color
- Withstands temperatures down to 0°F before freezing



Prod ID#	CSI#	Description	Price
3843	RLF-8	8 fl oz Radiant Leak Finder	15.53

**Proudly Serving You  
from 7 Convenient  
Michigan Locations**



A/C Supplies

**Let Us be Your Source of QUALITY PRODUCTS  
and Top-Grade Merchandise from Leading  
Manufacturers.**



**Hydronics**

**BaseLine 2000 Baseboard Radiation**

- Compact hot water baseboard radiation
- Rigid, channeled front panel
- Fully modulating damper, interchangeable elements
- 7" 3/8" High, 2-11/16" deep; high strength support brackets



**Complete Baseboard Package - Baseline 2000**

- Complete baseboard package contains:
  - Fully assembled baseboard
  - Damper vane
  - Heating element and expansion cradles
  - 2" Splice plate set packed with lengths 5' and over
  - 10' assemblies contain (2) elements

Part #	Mfg #	Description	Price
67831	2-BL-75	2' Complete Baseboard	39.87
67832	3-BL-75	3' Complete Baseboard	59.80
67834	4-BL-75	4' Complete Baseboard	79.74
67835	5-BL-75	5' Complete Baseboard	99.67
67836	6-BL-75	6' Complete Baseboard	119.60
67837	7-BL-75	7' Complete Baseboard	139.54
67838	8-BL-75	8' Complete Baseboard	159.47
67839	10-BL-75	10' Complete Baseboard	199.34

**Enclosure Only - BaseLine 2000**

- Complete assembly without element

Prod ID #	CSI #	Description	Price
67840	2-BL-D	2' Enclosure Only BL B Board	25.62
67841	3-BL-D	3' Enclosure Only BL B Board	38.42
67842	4-BL-D	4' Enclosure Only BL B Board	51.23
67843	5-BL-D	5' Enclosure Only BL B Board	64.04
67844	6-BL-D	6' Enclosure Only BL B Board	76.85
67845	7-BL-D	7' Enclosure Only BL B Board	89.66
67846	8-BL-D	8' Enclosure Only BL B Board	102.46

**Snap-On Accessories - BaseLine 2000**



End Cap



Inside Corner



Outside Corner



Splice Plate

Prod ID #	CSI #	Description	Price
67826	104-004	2" Right End Cap - Non Hinged	19.58
67824	104-005	2" Left End Cap - Non Hinged	19.58
67827	104-015	90° Inside Corner	27.29
67828	104-016	135° Inside Corner	30.17
67829	104-017	90° Outside Corner	56.12
67830	104-018	135° Outside Corner	58.80

**Snap-On Accessories - BaseLine 2000 (Continued)**

Prod ID #	CSI #	Description	Price
67863	104-021	2" Splice Plate	15.41

**Fine/Line® 30 Baseboard Radiation**

- For residential hot water heating
- Made with commercial grade, rust-resistant galvanized steel
- Fully modulating damper
- Extra-heavy support brackets with cutouts for return piping
- Double vent aluminum fins
- 7-7/8" High, 2-11/16" deep
- Nu-White baked enamel finish



**30-75 Complete Baseboard Package - Fine/Line® 30**

- Complete baseboard package contains:
  - 3/4" Copper/aluminum heating element & enclosure
  - Expansion cradles
  - Support brackets
  - Damper vane
  - 2" Wide splice plate with 5' lengths and longer

Prod ID #	CSI #	Description	Price
63960	2-30-75	2' Complete Baseboard	48.60
61083	3-30-75	3' Complete Baseboard	72.90
61084	4-30-75	4' Complete Baseboard	97.20
61085	5-30-75	5' Complete Baseboard	121.50
61086	6-30-75	6' Complete Baseboard	145.80
61087	7-30-75	7' Complete Baseboard	170.10
61071	8-30-75	8' Complete Baseboard	194.40
61088	10-30-75	10' Complete Baseboard	243.00

**30-DW Enclosure Only - Fine/Line® 30**

- Complete assembly without element or expansion cradles

Prod ID #	CSI #	Description	Price
61089	3-30-DW	3' Enclosure	51.91
61090	4-30-DW	4' Enclosure	69.21
61091	5-30-DW	5' Enclosure	86.51
61092	6-30-DW	6' Enclosure	103.81
61093	7-30-DW	7' Enclosure	121.11
61094	8-30-DW	8' Enclosure	138.42

Hydronics

**Hydronics**

Hydronics

**Snap-On Accessories - Fine/Line® 30**

- Precision piano hinged
- Nu-White enamel finish

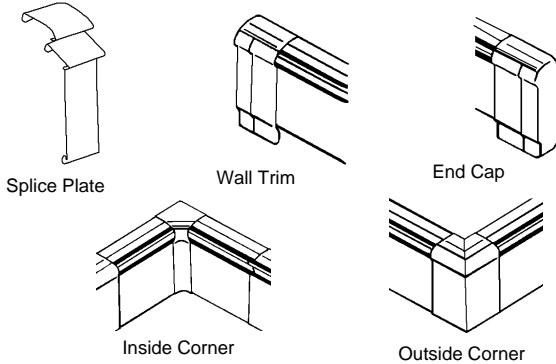

Prod ID #	CSI #	Description	Price
61102	101-422	2" Splice Plate	17.07
61108	101-641	4" Wall Trim	11.46
60842	101-405	4" Right End Cap	22.37
61104	101-404	4" Left End Cap	22.37
61105	101-410	90° Inside Corner	16.88
61107	101-414	90° Outside Corner	33.16
61126	101-411	135° Inside Corner	32.10
61106	101-415	135° Outside Corner	35.18
61103	101-020	Support Bracket w/Damper Pivot	12.33
61697	102-650	SlantFin Nu-White Paint	31.83

***THANK YOU!***  
***We appreciate  
your business***

**Revital/Line™ Baseboard**

- Fits over 90% of all brand of standard residential baseboard.
- Up to 8.5" H x 3" D
- Available 2'-8'
- No tools needed for most installations
- Lab tested for Maximum Heat Output
- Standard Color is Brite White - Powder Coated



Part #	Mfg #	Description	Price
78129	061-000-020	2' Revital Line Baseboard Cover	70.62
78131	061-000-030	3' Revital Line Baseboard Cover	105.93
78132	061-000-040	4' Revital Line Baseboard Cover	141.24
78133	061-000-050	5' Revital Line Baseboard Cover	176.55
78135	061-000-060	6' Revital Line Baseboard Cover	211.86
78137	061-000-070	7' Revital Line Baseboard Cover	247.17
78138	061-000-080	8' Revital Line Baseboard Cover	282.48
78139	061-004-002	Right End Revital Line	28.25
78140	061-004-001	Left End Revital Line	28.25
78141	061-008-000	90 Deg Inside Corner Rev Line	29.66
78142	061-007-000	End Plate Revital Line	28.25
78143	061-006-000	2" Filler Sleeve Revital Line	17.37
78144	061-009-040	4" Filler Sleeve Revital Line	21.76

**Hydronics**

**CHS Condensing High Efficiency Stainless Steel Gas Boilers**

- 95% AFUE
- Certified Internal Low water cut off with test button
- Wall-hung
- Top or Bottom connections
- Direct spark ignition system
- Full Modulation 5 to 1 turn down
- Built in DHW and space heating control
- Quiet operation
- Stainless Steel Internal Heat Exchanger
- PVC/CPVC or Stainless steel vent pipe
- Low NOx operation
- Outdoor Reset Control
- ASME Certified boiler
- 15-Year limited warranty with 5-year parts & labor warranty



\*\*\* Field convertible to L.P.

\*\*\* **PUMP NOT INCLUDED** \*\*\*

Part #	Mfg #	Fuel Rate Input		Boiler Water		Dimensions H x W x D	Weight Uncrated	Price
		Max BTUH	Min BTUH	Volume	AFUE			
67352	CHS-85	85,000	17,000	3.2 gal	95%	38-3/8" x 19-3/4" x 14-1/2"	125 lbs	6219.38
67353	CHS-110	108,000	21,600	3.2gal	95%	38-3/8" x 19-3/4" x 14-1/2"	125 lbs	6497.58
75650	CHS-154	154,000	15,400	4.9 gal	95%	33-3/8" x 19-3/4" x 18-1/2"	170 lbs	7998.25
67356	CHS-175	175,000	35,000	4.9 gal	95%	33-3/8" x 19-3/4" x 18-1/2"	170 lbs	8824.83
67357	CHS-200	200,000	40,000	4.9 gal	95%	33-3/8" x 19-3/4" x 18-1/2"	170 lbs	9298.30

**VSLII Condensing High Efficiency Stainless Steel Gas Boilers**

- 92% AFUE
- Intuitive control system
- Wall-hung
- Bottom connections
- Direct spark ignition system
- Modulation up to 5:1 turn down
- DHW (Domestic Hot Water) prioritization
- Quiet operation
- Stainless Steel Internal Heat Exchanger
- PVC/CPVC or Stainless steel vent pipe
- Automatic Control and Component Diagnostics
- Outdoor Reset Control
- ASME Certified boiler
- 15-Year limited warranty with 5-year parts & labor warranty



\*\*\* Field Convertible to L.P.

\*\*\* **PUMP NOT INCLUDED** \*\*\*

Part #	Mfg #	Fuel Rate Input		AFUE	Dimensions H x W x D	Weight Uncrated	Price
		Max BTUH	Min BTUH				
74697	VSLII-150	150,000	36,000	92%	30-1/2" x 17-1/2" x 19"	100 lbs	6647.59
74698	VSLII-200	198,000	43,000	92%	30-1/2" x 17-1/2" x 19"	110 lbs	7909.23

Hydronics

**Hydronics**

Hydronics

**Sentry Cast-Iron Gas Boiler**

**S Series**

- Cast iron heat exchanger
- Heavy-duty vent damper saves energy
- Natural draft, insulated base, long-life burners
- All metal push nipples - Integral draft diverter
- 30 psi relief valve standard
- Taco 007 w/1-1/4" flange standard
- Includes Hydrolevel 3200 Plus with LWCO
- Thermal Targeting and High Limit
- **Lifetime limited warranty on cast iron section to original owner**
- **1-Year parts warranty**



**Equipment Suffixes:**

- EDP - Intermittent pilot ignition system with vent damper, packaged

Prod ID #	CSI #	AGA Input MBH	DOE Capacity MBTUH	Net I=B=R MBH	AFUE	Fuel	Chimney or "B" Vent	Price
60579	S90EDP	90	76	66	84.2	Natural	5"	3514.04
60580	S90EDPLP	90	76	66	84.2	Propane	5"	3865.34
60581	S120EDP	120	101	88	84.1	Natural	6"	3824.47
61708	S150EDP	150	125	109	83.4	Natural	7"	4211.90

**Sentinel Cast-Iron Gas Boilers**

**SE Series**

- High efficiency, S-Series cast-iron heat exchanger
- Natural draft design - Vent damper
- Metal push nipples
- Heavy-duty vent damper saves energy
- Insulated base, long-life burners
- Includes Hydrolevel 3200 Plus with LWCO
- Thermal Targeting and High Limit
- **Lifetime limited warranty on cast iron section to original owner**
- **1-Year parts warranty**



**Equipment Suffixes:**

- EDP - Intermittent pilot ignition system, with vent damper, packaged

Prod ID #	CSI #	AGA Input MBH	DOE Capacity MBTUH	Net I=B=R MBH	AFUE	Fuel	Chimney or "B" Vent	Price
61123	SE70EDP	70	58	50	82.0	Natural	4"	3291.75
60583	SE105EDP	105	87	76	82.1	Natural	5"	3548.14
60585	SE105EDPLP	105	87	76	82.1	Propane	5"	3902.95
61709	SE140EDP	140	116	101	82	Natural	5"	3984.00
60587	SE140EDPLP	140	116	101	82.2	Propane	5"	4382.39
67533	SE175EDP	175	143	135	82.2	Natural	5"	4364.31
60937	SE210EDP	210	173	150	82.3	Natural	7"	5056.56

**Hydronics**

**Galaxy Steam Boilers**

**GXHA Series**

- Spark Ignition
- High efficiency, low clearance
- Cast iron heat exchanger
- Heavy-duty vent damper saves energy
- 15 PSI Relief Valve
- Mounted Low Water Cutoff
- Natural draft, insulated base, long-life burners
- All metal push nipples
- Integral draft diverter
- 10Yr Limited warranty on cast iron section to original owner
- **1-Year parts warranty**



Hydronics

Prod ID #	CSI #	CSA Input MBH	DOE Capacity MBTUH	Net I=B=R MBH	Net I=B=R Steam Sq.Ft.	AFUE	Chimney or "B" Vent	Price
61694	GXHA-100EDPZ	100	81	61	254	81%	5"	3801.05
61986	GXHA-120EDPZ	120	97	73	304	81.2%	6"	4022.95
62636	GXHA-160EDPZ	160	130	98	408	81.2%	6"	4769.91



**Super Stor Ultra Indirect Fired Water Heaters**

- Durable plastic jacket
- High output cupronickel heat exchanger
- Fast response immersion type control
- Working pressure: 150 psi
- 316L Stainless steel construction
- 2" to 3" CFC-Free water-blown foam insulation
- 1" NPT Boiler connection
- Lifetime warranty against leaks



Prod ID #	CSI #	Capacity	Height x Diameter	Inlet/Outlet	Approx Ship Wt	Price
61047	SSU-45	45 gal	52-1/2" x 19-1/4"	3/4"	84 lbs	2410.36
61048	SSU-60	60 gal	52-1/2" x 23-1/4"	1"	106 lbs	3518.89
61049	SSU-80	80 gal	72" x 23-1/4"	1-1/2"	141 lbs	4134.08
61050	SSU-119	119 gal	73-1/2" x 27"	1-1/2"	210 lbs	6668.64

Hydronics

Hydronics

**Twin-Flo III™ Heaters**

**Twin-Flo III™ Kickspace Kits**

- Install in kickspace under cabinets, in between floor joists & other tight spaces
- Works with home hot water heating system
- Made in USA
- Five year warranty
- Mounting kits available: recessed, surface & floor



Prod ID #	CSI #	BTUs	Price
61422	K42	4,200	403.94
61423	K84	8,400	509.85

**Twin-Flo III™ Hose Kits**

- Allows for installation of any "K" kickspace heater in new or retro-fit construction situations
- Includes:
  - (2) 1/2" female bronze barbed hose connections
  - (2) 1/2" male bronze barbed hose connections
  - (4) Constant tension hose clamps
  - (1) 10' length of 1/2" flexible hose

Prod ID #	CSI #	Description	Price
61425	HK10	Twin-Flo III™ Hose Kit	156.49



**Expansion Tanks**

- 16 Ga cold rolled steel tank
- Brass valve with o-ring seal
- Welded system connection
- Patented double diaphragm design constructed of 100% butyl rubber
- Appliance quality paint finish
- 5-Year limited warranty



**Hydronic**

- Constructed of deep drawn welded steel domes

Prod ID #	CSI #	Gallon Capacity	System Connection	Price
61710	H-15	2.1	1/2" MNPT	67.41
60918	H-30	4.5	1/2" MNPT	77.04
60919	H-60	6	1/2" MNPT	160.50
60920	H-90	15	3/4" MNPT	231.12
60921	SXHT30	15	1" FNPT	392.65
60922	SXHT40	20	1" FNPT	465.23



**UP Circulator Pumps**

- 60 Hz, 2-pole motor, single phase
- Max. liquid temperature: 230°F
- Min. liquid temperature: 36°F
- Max. system pressure 145 psi
- Flange - (2) 1/2" dia bolt holes
- Built-in motor protection
- Quiet, maintenance-free performance
- Flushed bearing design
- Cast iron construction



**UP 15-42F**

- 0-17 gpm Flow, 0-15' head range
- For residential and light commercial applications
- 3-Year warranty

Prod ID #	CSI #	Amps	Volts	HP	Price
60913	UP1542F	.74	115	1/25	211.43

**UPS 15-58FC (3-Speed Motor) SuperBrute**

- 0-17.5 gpm Flow, 0-19' head range
- Fits most standard hydronic applications
- Includes removable check valve
- 3-Year warranty



Prod ID #	CSI #	Amps	Volts	HP	Price
60923	UPS1558FC	.55 - .75	115	1/25	222.00

**UPS 26-99FC (3-Speed Motor) SuperBrute**

- 0-33 gpm Flow, 0-29' head range
- For applications requiring higher head
- Includes removable check valve
- 3-Year warranty



Prod ID #	CSI #	Amps	Volts	HP	Price
60924	UPS2699FC	1.3 - 1.8	115	1/6	777.57

**UPS 43-44FC (3-Speed Motor) SuperBrute**

- 0-64 gpm Flow, 0-14' head range
- For applications requiring lower head with higher flow
- Includes removable check valve
- Requires 539605 flanges
- 3-Year warranty



Prod ID #	CSI #	Amps	Volts	HP	Price
60978	UPS4344FC	1.8	115	1/6	897.20

**Hydronics**

**UPS 15 Stainless Steel (3-Speed Motor) SuperBrute**

- 0-21GPM, 0-12' Head UPS1535
- 0-25GPM, 0-18' Head UPS1555
- Fits most Potable applications
- Includes removable check valve
- 3-Year warranty



Prod ID #	CSI #	Amps	Volts	HP	Price
61449	UPS15-35SFC	.60 - .95	115	1/15	818.24
63997	UPS15-55SFC	.53 - .75	115	1/12	858.91

**15-55F/LC ALPHA AUTO ADAPT PUMP**

- Up to 80% Energy Savings
- Measures systems changes automatically
- 0-21GPM, 0-19' Head Pressure
- 5-45 Watts
- 3-Year warranty



Prod ID #	CSI #	Amps	Volts	Price
61273	15-55F/LC	.65	115	460.17

**Flange Sets**

**Dielectric Isolation Flanges**

- Full port shut-off ball valve with lever handle
- Service pump without draining system
- Swivel flange allows optimum pump mounting position
- All hardware included



Prod ID #	CSI #	Description	Price
60925	96806135	3/4" SWT	116.28
60926	96806136	1" SWT	137.15
60927	96806137	1-1/4" SWT	152.05

**Cast Iron Threaded Flanges**

- For Cast Iron Body Flange Mount Pumps
- Includes:
  - (2) Flanges
  - (2) Gaskets
  - (8) Nuts & Bolts



Prod ID #	CSI #	Description	Price
60928	519602	1" Threaded	31.68
60929	519603	1-1/4" Threaded	31.68
60930	539605	1-1/2" Threaded for UP43-75F	61.61

**Grundfos Flange Gaskets**

Prod ID #	CSI #	Description	Price
60292	510179	Round Stand. Flange Gasket	24.72
62360	91130069	Fits 3/4" & 1" Ball Valve Flange	45.65
62005	91130185	Fits 1-1/4", 1-1/2" Ball Vlv Flng	45.65



**tekmar® Thermostats**

- Microprocessor-based (PI), intended for single stage heating applications
- Not to be used as a safety (limit) control
- Air operation controls, adjustable heat cycles
- 24VAC Rated relay outputs
- CSA C US Listed
- Error messages

**519 Thermostat**

- Microprocessor-based (PI), intended for single stage heating applications
- Not to be used as a safety (limit) control
- Indoor use only
- 3-11/16"H x 3"W x 15/16"D
- (1) Auxiliary temperature sensor input
- Includes #79 auxiliary sensor



Prod ID #	CSI #	Description	Price
61159	519	Floor Sensing Stat	240.61

**tekmar® Setpoint Controls**

- Microprocessor based control
- Extremely accurate +/- 0.5°F
- Wide temperature ranges
- Remote sensing up to 500 feet
- Large load relay capacity
- Low power consumption

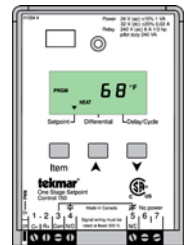

Prod ID #	CSI #	Description	Price
61356	T150	One Stage Setpoint Control	429.46

Hydronics

## Hydronics

Hydronics

### Legend Pex Tubing

- Made of high-quality cross-linked polyethylene
- Meets the requirements of ASTM F876 and F877
- Oxygen barrier
- Compatible with crimp ring & compression-sleeve fittings



### Oxygen Barrier Pipe

Prod ID #	CSI #	Size	Price
61370	38.500PEX 850-125	3/8" x 500' PEX W/OXY BARRIER	442.02
61371	12.300PEX 850-133	1/2" x 300' PEX W/OXY BARRIER	282.89
61372	12.1000PEX 850-139	1/2" x 1000' PEX W/OXY BARRIER	942.97
61373	58.400PEX 850-144	5/8" x 400' PEX W/OXY BARRIER	471.48
61374	58.1000PEX 850-149	5/8" x 1000' PEX W/OXY BARRIER	1178.71
61375	34.100PEX 850-151	3/4" x 100' PEX W/OXY BARRIER	155.40
61376	34.500PEX	3/4" x 500' PEX W/OXY BARRIER	777.00
61377	1.100PEX 850-161	1" x 100' PEX W/ OXY BARRIER	298.21
61378	1.500PEX 850-165	1" x 500' PEX W/OXY BARRIER	1491.07

### Brass Manifolds

#### Legend Precision Manifold

- Use with 3/8", 1/2", 5/8" and 3/4" with Legend Flex
- Complete with:
  - Instruction booklet
  - 1" NPT supply and return manifold isolation valves
  - Air vent/fill ports
  - Visual flow gauges (0-2 GPM) on supply side
  - Balancing valves with memory stop
  - Automatic air vent
  - Thermometer
  - Mounting brackets
- Maximum flow is 2.0 gpm per circuit



Prod ID #	CSI #	Manifold Stations	Length	Price
68983	8200P-10-2	2	8 3/8"	553.55
65377	8200P-10-3	3	10 3/8"	657.04
67181	8200P-10-4	4	12 3/8"	748.49
67557	8200-10-5	5	14 3/8"	809.86
61367	8200-10-6	6	16 3/8"	896.51

### Legend Precision Manifold (Continued)

Prod ID #	CSI #	Manifold Stations	Length	Price
68984	8200-10-7	7	18 3/8"	987.96

### Brass Manifold Accessories

#### Connections for 8200 Series Brass Manifolds

- 3/8", 1/2" & 5/8" fittings include insert with O-ring, split brass ring and compression nut
- Sold per pair



Prod ID #	CSI #	Description	Price
68100	800-142	Legend 3/8" Manifold Adaptor	21.37
67182	800-143	Legend 1/2" Manifold Adaptor	21.67
67012	800-144	Legend 5/8" Manifold Adaptor	21.67

### Compression Nut Fittings

#### Dual MPT/Copper Adapters

- Connects RAUPEX pipe to threaded fitting or copper pipe



Prod ID #	CSI #	Descriptions	Price
61397	260477	1" x 1" MPT or 3/4" C Female (Sweat)	110.73

### Heat Transfer Plates

#### Joint Space Heating

- For use with 1/2" Pex and may be used in conjunction with PE sleeves and RAILFIX fixing rails



Prod ID #	CSI #	Size	Price
63522	298926-001	8"x 4' Pex PLATE- 1/2" Pex	32.47

Shaded items are Non-Stock special order & Subject to Freight

Sterling Hts, MI - Livonia, MI - Lansing, MI - Grand Rapids, MI - Waterford, MI - Almont, MI - Saginaw, MI



**Hydronics**

**Installation Tools**

**Pressure Testers**

- Threads into 1" isolation valve on a manifold & connects to an air hose
- 0-100 PSI gauge



Prod ID #	CSI #	Description	Price
67191	800-668	Air Pressure Tester	41.67



**Anti-Freeze & Heat Transfer Fluids**

**Noburst-100**

- Non-Toxic
- For use in Contact or Potential Contact with Potable Water
- At 50/50 Water/ Noburst-100 ratio:
  - Freeze point: 0 Deg F
  - Flow Point: -10 Deg F
  - Burst Point: -60 Deg F



Prod ID#	CSI#	Description	Price
62576	Noburst-100	5 GAL ANTIFREEZE/HT XFER FLUID	162.91

**Noburst AL**

- **NOT** Safe for use when possible contact to potable water
- For systems that contain aluminum components
- At 50/50 - Water/NoburstsAL ratio:
  - Freeze Point: 0 Deg F
  - Flow Point: -10 Deg F
  - Burst Point: -60 Deg F



Prod ID#	CSI#	Description	Price
62577	NoburstAL	5 GAL ALUM SAFE ANTIFREEZE	186.18



**Anti-Freeze & Heat Transfer Fluids**

**#5 Clean/Inhibitor with Silicone SK-471**

- Inhibits corrosion, prevents scale, frees & lubricates stuck zone valves
- Dissolves insulating sludge
- Protects & lubricates pump seals, quiets noisy circulators
- Insures maximum heat transfer
- Compatible with propylene glycol & ethylene anti-freeze



Prod ID#	CSI#	Description	Price
64060	#5 Hydronic Formula	Boiler Cleaner	24.82

**Steam Boiler Cleaner/Inhibitor**

- Absorbs grease, oil, rust, dirt and suspended solids
- Prevents formation of insulating scale
- Neutralizes free oxygen, prevents corrosion, protects metal
- Prevents surging or priming
- Maximizes heat transfer
- Contains no petroleum, Non-Hazardous, safe to use in all boilers



Prod ID#	CSI#	Description	Price
64061	Squick	Steam Boiler Cleaner	24.31

**Safe Boiler Stop Leak**

- Quickly stops leaks in all steel and cast iron boilers
- Both steam & hot water systems including baseboards & radiant heating
- Contains no petroleum - Safe to use in all boilers
- Will not sludge submerged coils, or clog
- Non-hazardous
- Compatible with propylene glycol & ethylene glycol anti-freeze



Prod ID#	CSI#	Description	Price
64062	Safe	Leak Sealant	24.82

Hydronics

**Shaded items are Non-Stock special order & Subject to Freight**

**Sterling Hts, MI - Livonia, MI - Lansing, MI - Grand Rapids, MI - Waterford, MI - Almont, MI - Saginaw, MI**

**Hydronics**

Hydronics

**PVC Schedule 40 Conduit Fittings**

**90° Conduit Elbows**

- Tubing bend support



Part #	Mfg #	Description	Price
61461	PVCEL07590D	3/4" for 1/2" PEX	2.31

**ASME Hot Water Boiler Safety Relief Valves**

- For hot water boilers and hydronic heating systems
- Protects against excessive water pressure and steam generated when BTU input controls fail
- Brass finish
- Stainless steel springs
- Maximum temperature service to 250°F
- Rated @ 535,000 BTU
- Set pressure: 30 psig

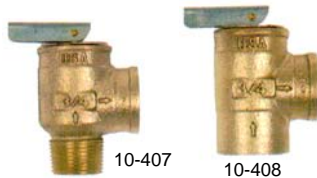

**10 Series - (MNPT Inlet x FNPT Outlet)**

Prod ID #	CSI #	Size	Wt/100 lbs	Price
61031	20166-0030	3/4"	62	32.53

**10 Series - (FNPT Inlet x FNPT Outlet)**

Prod ID #	CSI #	Size	Wt/100 lbs	Price
61030	22887-0030	3/4"	65	32.53

**Honeywell**

**Thermometer with Thermowell**

- Steel Case, brass well
- Temperature range: 32° to 250°F



Prod ID #	CSI #	Connection	Dial	Price
61026	GS200	1/2" SWT	2" Dia	45.16

**Tridicators**

- Pressure/temp gauge with relief set point indicator for boilers & shut-off valves
- Temperature range: 60° to 320°F
- Max operating pressure: 150 psi



Prod ID #	CSI #	Connection	Dial	Price
61029	TD165/800-662	1/4" NPT	3-1/8" Dia	44.24

**Air Purgers**

- Air separator for closed heating systems
- Tappings: 1/2" bottom, 1/8" top
- Max operating temperature: 275°F
- Max operating pressure: 125 psi
- Cast iron body



Prod ID #	CSI #	Connection	Price
60981	AP400/110-346	1" FNPT	36.33
60962	AP401/110-346	1-1/4" FNPT	36.33

**Air Vents**

**GoldTop™ - Universal Air Vent**

- For residential and commercial heating and cooling systems
- Max operating temperature: 240°F
- Max operating pressure: 150 psi
- Brass body



Prod ID #	CSI #	Connection	Price
60963	FV180	1/8" NPT	23.29

**Air Eliminators**

**Supervent™ Air Eliminators**

- Eliminates air from hydronic heating systems without bleeding
- No clog vent, dirt and debris resistant
- 360° Adjustable collar ring
- Max operating temperature: 240°F
- Max operating pressure: 150 psi
- Bronze body



Prod ID #	CSI #	Connection	Price
60976	PV100S	1" SWT	222.02
60977	PV125S	1-1/4" SWT	299.56
61800	PV150	1-1/2" NPT	410.12
62219	PV200	2" NPT	507.31

**Think of us for all your product needs!**

**Hydronics**

**Backflow Preventers**

**Double Check with Intermediate Vacuum Breaker**

- Ideal for boiler feed lines, trailer park water hookups and numerous other applications
- Suitable for hot or cold water service
- Max operating temperature: 205°F
- Max operating pressure: 175 psi



Prod ID #	CSI #	Connection	Price
60984	BP900	1/2" NPT	86.28

**FM - Boiler Fill Valves**

- Fast fill feature
- 1/2" NPT connection
- Built-in check valve
- Max operating pressure: 150 psi
- Regulating pressure range: 4 psi to 60 psi
- Especially constructed for expansion tank mounting



FM911 - Combo

Prod ID #	CSI #	Description	Price
60964	VF06-100-SUS UT/U	Boiler Fill Valve	149.38
60967	FM911	Boiler Fill Valve & Backflow Preventer Combination Assy	210.85

**Hydronic Zone Valves**

**V8043 - Low Voltage Hydronic Zone Valves**

**Two-Position Normally Closed Straight-Through Motorized Valve**

- Spring return to close valve action
- Includes auxiliary switch zone valve
- Terminal board with (5) terminals
- Max ambient temperature: 125°F
- Temperature range: 50°F to 200°F
- 24V, 50/60Hz
- Brass body & seat, stainless steel stem



Prod ID #	CSI #	Connection	Flow Cap	Price
63902	V8043E1012	3/4" SWT	3.5 Cv	213.72
832	V8043F1036	3/4" SWT	3.5 Cv	231.59
833	V8043F1051	1" SWT	3.5 Cv	263.70
61057	V8043F1093	3/4" SWT	8.0 Cv	233.88
63255	V8043F1101	1" SWT	8.0 Cv	315.94

**Replacement Parts**

Prod ID #	CSI #	Description	Price
60980	40003916-048	Replacement Powerhead Assembly for V8043F	164.02

**1311 Series 3-Wire Hydronic Zone Controls**

- 24V AC Thermostat circuit rating: 0.4A
- Time cycle (open/close): 45 Sec/45 Sec
- Includes: screw terminal, wiring panel and auxiliary switch



**White-Rodgers**

1311-102

Prod ID #	CSI #	Tubing Size (ID)	Price
3666	1311-102	3/4"	319.98
3667	1311-103	1"	371.24

**1361 Series 2-Wire Hydronic Zone Controls**

- 24V AC Thermostat circuit rating: 0.2A
- Time cycle (open/close): 45 Sec/60 Sec
- Includes: screw terminal, wiring panel and auxiliary switch

**White-Rodgers**

Prod ID #	CSI #	Tubing Size (ID)	Price
3669	1361-102	3/4"	375.20

**Aquastats®**

- Stop factory-set at 240°F, well adapter & heat-conductive compound
- Totally enclosed Micro Switch™ snap-acting switches operate on temperature rise to setpoint
- Visible control point scale and external adjustment screw permit easy setting
- Horizontal or vertical insertion of the sensing element
- Direct or well immersion



L4006H & L6006A

L6006C

**L4006H - Strap-On Mount Aquastat Controls & High Limit, SPST**

- Contacts break on temp rise

Prod ID #	CSI #	Temp Range	Diff Temp	Price
60973	L4006H1004	110° to 290°F	Manual Reset	405.72

**L6006A - Immersion Type, Circulator Control & High Limit or Low Limit, SPDT**

Prod ID #	CSI #	Temp Range	Diff Temp	Price
60974	L6006A1145	100° to 240°F	5 to 30°F Adj	281.94

**L6006C - Strap-On Mount, Circulator Control & High Limit & Low Limit, SPDT**

Prod ID #	CSI #	Temp Range	Diff Temp	Price
60975	L6006C1018	65° to 200°F	5 to 30°F Adj	258.45

Hydronics

Hydronics

**L8148 Aquastat Controls**

- High Limit Protection
- Switching Relay
- Horiz or Vert Mounting



Prod ID #	CSI #	Description	Price
63018	L8148E1265	High Limit Aquastat Relay	577.59
63019	L8148J1009	Aquastat Relay 8 Deg Fixed Diff	530.92
65895	121371A	1/2" Insertion Well 3/8 X 3"	68.48

**Thermostatic 3-Way Mixing or Diverting Valves**

- Controls loop temperature in radiant heating systems
- Plastic handle for manual operation
- Max operating temperature: 248°F
- Max operating pressure: 232 psi
- Use with T100R actuator
- Bronze body



Prod ID #	CSI #	Connection	Price
60983	V135A1006	3/4" SWT	375.40
60966	V135A1014	1" SWT	393.40
60982	V135A1022	1-1/4" NPT	479.54

**Thermostatic Valve Actuators**

**T100R - Thermostatic Mixing or Diverting Valve Actuator**

- Includes strap-on pipe sensor
- Knurled ring on T100R control head for easy attachment to V135
- Remote sensor, remote setpoint
- Temperature range: 50° to 122°F



Prod ID #	CSI #	Collar	Capillary Length	Price
60979	T100R1004	1-3/16"	80"	260.25

*We feature the brand name products you are looking for!*

**LEGEND VALVE**

**Forged Brass Ball Valves**

**S-1001 - Full Port Regular Pattern Ball Valves**

- Heavy duty forged brass
- Designed for residential & commercial use on steam, water, oil, or gas
- NSF Approved for use on potable water
- Full ports allow for a maximum of flow & a minimum of pressure drop or turbulence
- Heavy duty bottom loaded stem utilizes both a Teflon® thrust washer & Viton® o-ring
- 1/4" - 3" CSA Certified, 1/2" - 2" UL Listed, FM Approved



Prod ID #	CSI #	Size	Price
62356	101-043	1/2" C x C	20.20
51203	101-044NL	3/4" C x C	28.05
61354	101-045	1" C x C	41.22
61355	101-046	1-1/4" C x C	66.67
63111	101-026	1-1/4" IPS	66.67

**Y-Strainer**

- 150 WSP/300 WOG
- 304 Stainless steel
- 20 Mesh screen



**T-16 Bronze Y-Strainer**

Prod ID #	CSI #	Size	Price
61353	105-706	1 1/4 ID IPS Y-Strainer	68.91

**In-Line Check Valve - Bronze**

**T-456 - I.P.S. Ball Check**

- High Flow / Low Pressure
- Spring Loaded
- Positive Shut-off
- Silent Operation



Prod ID #	CSI #	Size	Price
61806	105-625	1" Bronze	78.71
61807	105-626	1-1/4" Bronze	102.14

**T-521 - Boiler Drains**

- Heavy brass construction
- Screwed-in bonnet creates metal-to-metal leak-proof seat



Prod ID #	CSI #	Size	Price
61350	107-143	1/2" MIP	9.42
3550	107-144	3/4" MIP	11.28

**Hydronics**

**Bronze Heating & Radiator Valves  
S-464 Series**



Prod ID #	CSI #	Size	Price
61351	110-404	3/4" C x C	25.23

**Heating Specialties  
T-77 Coin Key Air Vent**

- Threaded



Prod ID #	CSI #	Size	Price
61346	18IDCKV(110-338)	1/8" IPS	3.66

**T-77 Key-Only**

Prod ID #	CSI #	Description	Price
61347	110-340	Key Only for T-77	1.51

**Steam Air Vents**

**Chrome Plated Steam Air Vents**



Prod ID #	CSI #	Size	Price
62110	110-301	1/8" Angle Steam Vent	28.62
62109	110-305	1/8" Adj Angle Steam Vent	41.05
62111	110-304	3/4" MIP Steam Vent	45.61

**Dielectric Fittings**

**T-571 - Forged Steel Dielectric Unions- No Lead**

- Forged steel dielectric unions
- Prevents corrosion caused by galvanic action resulting from connection of dissimilar metals
- Maximum operating temperature: 180°F
- Conforms to ANSI B16.39



Prod ID #	CSI #	Size	Price
61348	301-105NL	1" FIP x 1" SWT	13.95
61349	301-106NL	1-1/4" FIP x 1-1/4" SWT	23.97
64802	301-107NL	1-1/2" FIP x 1-1/2" SWT	29.25

**Auto Fill with Gauge**

**1/2" Auto Fill with Gauge**

- Built in system pressure gauge
- Adjustable from 7 to 45 PSI (pre-set to 12 PSI)



Prod ID #	CSI #	Size	Price
71238	800-842	1/2" Auto Fill with Gauge	144.63

**Webstone**

**Webstone Hydronic Products**

**Ball Drains & Tank Valves**

- Time saver
- Great for Servicing System



Prod ID #	CSI #	Description	Price
75694	41672	1/2" Exp Tank Service Valve	46.74
75696	50613	3/4" SW Ball Valve w/Drain	41.49
75695	50614	1" SW Ball Valve w/Drain	57.55
75697	50615	1-1/4" SW Ball Valve w/Drain	83.35

**Let us know how we may best serve you. Suggestions help us improve.**

Hydronics

Hydronics

Hydronics

**Taco Pumps**

- Quiet Efficient Operation
- Self Lubricating
- Single speed



Prod ID #	CSI #	Description	Price
63097	007-F7	1/25 HP 0-20gpm Head 0-10'	219.16
62557	0010-F3	1/8 HP 0-32gpm Head 0-10'	347.24
62558	0011-F4	1/8 HP 0-31gpm Head 0-31'	589.82

**Taco Zone Valve Relays**

- External Indicator Lights
- Switchable Priority
- Two Isolated End Switches
- 100% Factory Tested



Prod ID #	CSI #	Description	Price
63759	ZVC404-2	4 Zone Valve Cont. W.Priority	307.20
62358	ZVC406-4	6 Zone Valve Cont. W.Priority	416.58

**Taco Zone Pump Relays**

- External Indicator Lights
- Switchable Priority
- Isolated End Switches
- 100% Factory Tested



Prod ID #	CSI #	Description	Price
66335	SR501	1 Zone Pump Relay	146.37
63678	SR502	2 Zone Pump Relay w/Priority	320.57
66336	SR503	3 Zone Pump Relay w/Priority	341.54
66337	SR504	4 Zone Pump Relay w/Priority	390.64
66338	SR506	6 Zone Pump Relay w/Priority	485.99



**Low Water Cutoffs**

- Protection for all types of boilers
- Can act as primary or secondary low water cutoff on low-pressure steam boilers; the primary limit control on hot water boilers
- Can activate an alarm or automatic water feeders

**LF - Foam Compensating Low Water Cutoff**

- DualVision™ technology protects against false water level detection due to the probe being in foam
- Test button
- Maximum probe temperature: 250°F
- Maximum ambient temperature: 150°F
- NEMA 1 Enclosure for indoor use only
- CSD1 Compliant



Prod ID #	CSI #	Description	Price
60988	LFM1203S1	Manual Reset, 120V, 3/4" NPT, Standard Probe	340.03
63108	LFM0243S1	24V, 3/4" NPT, Standard Probe Electrode W/Reset	340.03

**LTA-2 Model - Low Water Cutoff**

- Integrated test switch for testing safety shutdown
- Automatic reset when water level returns to safe level
- Maximum probe rating: hot water only - 250 psi @ 250°F
- Ambient temperature: 32° to 150°F
- NEMA 1 Enclosure for indoor use only



Prod ID #	CSI #	Description	Price
60987	LTA1203S2	120V, 3/4" NPT, Standard Probe Electrode	200.45

**LTR Model - Residential Low Water Cutoff**

- Integrated test switch for testing safety shutdown
- Automatic reset when water level returns to safe level
- Maximum probe rating: hot water only - 160 psi @ 250°F
- Ambient temperature: 32° to 120°F
- NEMA 1 Enclosure for indoor use only



Prod ID #	CSI #	Description	Price
60989	LTR0243T1	24V, 3/4" NPT, Standard Wire Harness	200.45

**Hydronics**

**Low Water Cut Off**

- For Hot Water Boiler



Prod ID #	CSI #	Description	Price
61562	RB24E	24V Low Water Cut Off	245.14

**Automatic Fill Valve**

- For Steam Boilers



Prod ID #	CSI #	Description	Price
61271	WFE-24V	24V Auto Fill Valve- Steam	605.19



**Bell & Gossett Pump Coupler  
Pump Coupler**



Prod ID #	CSI #	Size	For Model	Price
62299	118705	1/2 x 1/2	Coupler B&G	51.84
65204	118473	1/2 X 1/2	Offset Coupler B&G	129.30

**Wrot  
Copper  
Fittings**

**Copper Wrot Pipe & Pressure Fittings  
Type M Copper - Red - 10' Lengths**



Prod ID #	CSI #	ID Size	Price
61323	1ID.10CP	1"	56.62
61322	114ID.10CP	1 1/4"	82.34

**Wrot Adapters (C x MIP)**



Prod ID #	CSI #	ID Size	Price
3795	12CMIPA (450-753)	1/2"	3.61
3796	34CMIPA (450-754)	3/4"	5.49
61318	1IDCMA (450-755)	1"	15.50
61320	114IDCMA (450-756)	1-1/4"	22.92

**Wrot Adapters (C x FIP)**



Prod ID #	CSI #	ID Size	Price
61317	12IDCFM (450-703)	1/2"	5.20
3798	34IDCFMA (450-704)	3/4"	7.13
61319	1IDCFM (450-705)	1"	18.01
61321	114IDCFA (450-706)	1-1/4"	26.34

**Wrot Flush Bushings (FTG x C)**



Prod ID #	CSI #	ID Size	Price
30524	34.58ODCREDBU 119-IF	3/4" x 5/8"	6.64
30525	78.34ODCREDBU N-1325	7/8" x 3/4"	7.68

**Wrot Reducing Couplings (C x C)**



Prod ID #	CSI #	ID Size	Price
61304	1.12IDCREDCPG	1" x 1/2"	10.29
41826	1.34IDCREDCPG	1" x 3/4"	8.27
61284	114.34IDCREDCPG	1-1/4" x 3/4"	12.26
61302	114X1IDCREDCPG	1-1/4" x 1"	12.75

**Wrot Couplings with  
Dimpled Stops (C x C)**



Prod ID #	CSI #	ID Size	Price
61299	114IDCCPG(N-1055)	1-1/4"	9.79

Hydronics

**Hydronics**

Hydronics

**Tees (C x C x C)**



Prod ID #	CSI #	ID Size	Price
62081	34IDCT (450-154)	3/4"	6.40
61300	1IDCT (N-4048)	1"	23.08
61306	1.34.1IDCREDT	1" x 3/4" x 1"	21.57
61307	1.1.34IDCREDT	1" x 1" x 3/4"	15.41
61311	114.34.34IDCREDT	1-1/4" x 3/4" x 3/4"	32.97
61310	114.34.114IDCREDT	1-1/4" x 3/4" x 1-1/4"	32.97
61309	114.1.1IDCREDT	1-1/4" x 1" x 1"	29.93
61308	114.1.114IDCREDT	1-1/4" x 1" x 1-1/4"	33.71
61679	114.114.34IDCREDT	1-1/4" x 1-1/4" x 3/4"	26.66
61680	114.114.1IDCREDT	1-1/4" x 1-1/4" x 1"	32.78
61301	114IDCT (N-4068)	1-1/4"	23.65

**Female Tees (C x C x FIP)**

Prod ID #	CSI #	ID Size	Price
61312	34.34.12IDF1PT	3/4" x 3/4" x 1/2"	13.60
61313	1.1.34IDFIPT	1" x 1" x 3/4"	21.19
61686	114.114.34IDFIPT	1-1/4" x 1-1/4" x 3/4"	36.61

**Female Baseboard Tees (C x FIP x C)**

Prod ID #	CSI #	ID Size	Price
61314	12.18.12IDCXFIPXC	1/2" x 1/8" x 1/2"	8.42
61315	34.18.34IDCXFIPXC	3/4" x 1/8" x 3/4"	7.99

**Mono-Flow Tees (C x C)**

Prod ID #	CSI #	ID Size	Price
61316	34.12IDMT	3/4" x 1/2"	12.48

**Wrot 90° Close Rough Elbows (C x C)**



Prod ID #	CSI #	ID Size	Price
61297	1IDCSR90 (N-1647)	1"	9.15
61298	114IDCSR90(N-2084)	1-1/4"	12.80

**Wrot 90° Street Close Rough Elbows (FTG x C)**



Prod ID #	CSI #	ID Size	Price
61681	114IDCST90	1-1/4"	22.15

**Wrot 45° Street Elbows (FTG x C)**



Prod ID #	CSI #	ID Size	Price
61683	114IDCST45	1-1/4"	18.90

***If you don't find everything you need in this catalog, please let us know. We have not listed everything and can special order from most of our manufacturers.***



**Galvanized Products**

**Sheet Metal Pipe**

**30" Round Sheet Metal Pipe**



Prod ID#	CSI#	Size	Ga	Price
1224	3.30IN26GAP	3" x 30"	26	18.95
1225	4.30IN26GAP	4" x 30"	26	13.08
1226	5.30IN26GAP	5" x 30"	26	16.67
1227	6.30IN26GAP	6" x 30"	26	19.74
1228	7.30IN26GAP	7" x 30"	26	19.47
1229	8.30IN26GAP	8" x 30"	26	25.03
1230	9.30IN26GAP	9" x 30"	26	28.84
1231	10IN.30IN26GAP	10" x 30"	26	33.26
1232	12IN.30IN26GAP	12" x 30"	26	39.69
1233	14IN.30IN26GAP	14" x 30"	26	50.04

**36" Round Sheet Metal Pipe**

Prod ID#	CSI#	Size	Ga	Price
1234	16IN.36IN26GAP	16" x 36"	26	53.48
1235	18IN.36IN24GAP	18" x 36"	24	130.50
1236	20IN.36IN24GAP	20" x 36"	24	125.43

**60" Round Sheet Metal Pipe - 26 Ga**

Prod ID#	CSI#	Size	Ga	Price
3984	4.60IN26GAP	4" x 60"	26	28.24
1239	5.60IN26GAP	5" x 60"	26	27.04
1240	6.60IN26GAP	6" x 60"	26	36.92
43314	7.60IN26GAP	7" x 60"	26	36.97
1241	8.60IN26GAP	8" x 60"	26	39.44
1242	10IN.60IN26GAP	10" x 60"	26	50.72
1243	12IN.60IN26GAP	12" x 60"	26	62.95
1244	14IN.60IN26GAP	14" x 60"	26	83.67

**60" Round Sheet Metal Pipe - 30 Ga**

Prod ID#	CSI#	Size	Ga	Price
8012	3.60IN30GAP	3" x 60"	30	20.43
1255	4.60IN30GAP	4" x 60"	30	15.73
1257	5.60IN30GAP	5" x 60"	30	15.35
26724	U6.6030GAP	6" x 60" Unboxed	30	14.06
1260	7.60IN30GAP	7" x 60"	30	25.28
1261	8.60IN30GAP	8" x 60"	30	28.33
1263	10IN.60IN30GAP	10" x 60"	30	49.91
1264	12IN.60IN30GAP	12" x 60"	30	65.27

**Plain Round Galvanized Pipe**

Prod ID#	CSI#	Size	Ga	Price
3280	4.10PRGP	4" x 10'	30	41.16

**120" Boxed Pipe**

Prod ID#	CSI#	Size	Ga	Price
41210	B6.12030GAP	6" x 120	30	43.90

**24" Round Sheet Metal Pipe**



Prod ID#	CSI#	Size	Ga	Price
73273	6.24IN30GAP	6" x 24"	30	11.32

**Adjustable Elbows**

**90° Elbows**



Prod ID#	CSI#	Size	Ga	Price
1265	326GA90	3"	26	8.91
1266	426GA90	4"	26	8.55
1267	526GA90	5"	26	12.18
1268	626GA90	6"	26	10.64
1269	726GA90	7"	26	18.61
1270	826GA90	8"	26	13.77
1271	926GA90	9"	26	23.23
1272	10IN26GA90	10"	26	22.33
1273	12IN26GA90	12"	26	30.11
1274	14IN26GA90	14"	26	35.89
1275	16IN26GA90	16"	26	61.17
1276	18IN24GA90	18"	24	103.34
1277	20IN24GA90	20"	24	124.40
1280	330GA90	3"	30	9.66
1281	430GA90	4"	30	5.19
1282	530GA90	5"	30	8.68
1283	630GA90	6"	30	4.71
1284	730GA90	7"	30	7.93
1285	830GA90	8"	30	9.51

**Round/Round Take-Offs**

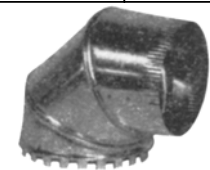

Prod ID#	CSI#	Description	Price
3058	6.5RD.RDGTTO	5" Top Take-off	18.10
3059	7.6RD.RDGTTO	6" Top Take-off	8.74
3060	8.7RD.RDGTTO	7" Top Take-off	18.77
3061	9.8RD.RDGTTO	8" Top Take-off	28.81

Galvanized

**Galvanized Products**

Galvanized

**Fittings**

**Universal Straight Back Boots**



Prod ID#	CSI#	Size	Price
3161	214.10IN.6GUNIB	2-1/4" x 10" x 6"	14.94
3162	214.12IN.6GUNIB	2-1/4" x 12" x 6"	15.77
2795	314.10IN.6GUNIB	3-1/4" x 10" x 6"	16.34
2796	314.10IN.7GUNIB	3-1/4" x 10" x 7"	17.06
2797	314.12IN.6GUNIB	3-1/4" x 12" x 6"	17.71
2798	314.12IN.7GUNIB	3-1/4" x 12" x 7"	17.71
68628	4.10IN.4GUNIB	4" x 10" x 4"	15.02
3165	4.10IN.6GUNIB	4" x 10" x 6"	9.06
3166	4.10IN.7GUNIB	4" x 10" x 7"	14.40
3167	4.12IN.6GUNIB	4" x 12" x 6"	14.29
3168	4.12IN.7GUNIB	4" x 12" x 7"	17.49
57829	4.12IN.8GUNIB	4" x 12" x 8"	18.80
3169	4.14IN.8GUNIB	4" x 14" x 8"	22.59
3171	6.10IN.6GUNIB	6" x 10" x 6"	16.03
3172	6.12IN.6GUNIB	6" x 12" x 6"	20.62
3173	6.12IN.7GUNIB	6" x 12" x 7"	25.83
59546	6.12IN.8GUNIB	6" x 12" x 8"	31.25
3174	6.14IN.8GUNIB	6" x 14" x 8"	35.41

**Center End Boots**

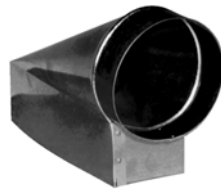

Prod ID#	CSI#	Size	Price
3181	214.10IN.6GCEB	2-1/4" x 10" x 6"	15.23
3182	214.12IN.6GCEB	2-1/4" x 12" x 6"	20.24
2801	314.10IN.6GCEB	3-1/4" x 10" x 6"	15.16
2803	314.12IN.6GCEB	3-1/4" x 12" x 6"	19.50
67300	314.12IN.7GCEB	3-1/4" x 12" x 7"	22.53
3184	4.10IN.5GCEB	4" x 10" x 5"	15.40
3185	4.10IN.6GCEB	4" x 10" x 6"	9.06
3186	4.10IN.7GCEB	4" x 10" x 7"	16.27
3187	4.12IN.6GCEB	4" x 12" x 6"	14.63
3188	4.12IN.7GCEB	4" x 12" x 7"	18.03
64130	4.12IN.8GCEB	4" x 12" x 8"	17.57
3190	6.10IN.6GCEB	6" x 10" x 6"	18.03
66486	6.12IN.7GCEB	6" x 12" x 7"	38.42

**90° Boots**



Prod ID#	CSI#	Size	Price
3193	214.10IN.6G90B	2-1/4" x 10" x 6"	13.64
3194	214.12IN.6G90B	2-1/4" x 12" x 6"	15.35
2789	314.10IN.6G90B	3-1/4" x 10" x 6"	14.90
2791	314.12IN.6G90B	3-1/4" x 12" x 6"	19.00
2792	314.12IN.7G90B	3-1/4" x 12" x 7"	20.87
44099	4.8.6G90B	4" x 8" x 6"	21.37
66913	4.10IN.4G90B	4" x 10" x 4"	16.93
3195	4.10IN.5G90B	4" x 10" x 5"	15.24
3196	4.10IN.6G90B	4" x 10" x 6"	9.06
3197	4.10IN.7G90B	4" x 10" x 7"	14.02
3198	4.12IN.6G90B	4" x 12" x 6"	14.48
3199	4.12IN.7G90B	4" x 12" x 7"	15.23
57828	4.12IN.8G90B	4" x 12" x 8"	24.66
3200	4.14IN.8G90B	4" x 14" x 8"	24.91
22826	6.10IN.6G90B	6" x 10" x 6"	14.87
3201	6.12IN.6G90B	6" x 12" x 6"	21.61
22798	6.12IN.7G90G	6" x 12" x 7"	21.61
4052	6.14IN.8G90B	6" x 14" x 8"	33.56

**Basement Heat Boxes**

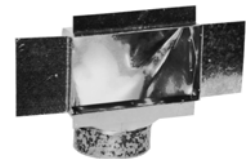

Prod ID#	CSI#	Size	Price
3205	6.10IN.6BHB	6" x 10" x 6"	15.86

**Misc Galv Boots**

Prod ID#	CSI#	Size	Price
67082	214.12.6TKB	2-1/4" x 12" x 6" Toe Kick Boot	43.84
3205	6.10.690w/CP	6 x 10 x 6 90 w/16" Ceiling Plate	15.86

**Drawband**



Prod ID#	CSI#	Size	Price
3282	6SDB	6" Snappy	14.89

**Galvanized Products**

**Cap Reducers**



Prod ID#	CSI#	Size	Price
2927	4.3GCRED	4" x 3"	8.13
2930	5.4GCRED	5" x 4"	11.73
2932	6.4GCRED	6" x 4"	13.18
2933	6.5GCRED	6" x 5"	12.66
2935	7.4GCRED	7" x 4"	18.96
2936	7.5GCRED	7" x 5"	18.96
2937	7.6GCRED	7" x 6"	17.13
2939	8.4GCRED	8" x 4"	16.15
2941	8.6GCRED	8" x 6"	17.75
2942	8.7GCRED	8" x 7"	16.15
2946	9.8GCRED	9" x 8"	21.22
2947	10IN.6GCRED	10" x 6"	23.12
2949	10IN.8GCRED	10" x 8"	19.55
2950	10IN.9GCRED	10" x 9"	24.16
2951	12IN.6GCRED	12" x 6"	27.39
2952	12IN.8GCRED	12" x 8"	27.39
2953	12IN.10INGCRED	12" x 10"	25.03
2954	14IN.8GCRED	14" x 8"	37.75
2955	14IN.10INGCRED	14" x 10"	37.75
2956	14IN.12INGCRED	14" x 12"	37.75

**Tapered Reducers**



Prod ID#	CSI#	Size	Price
2957	4.3GTRED	4" x 3"	14.55
2958	5.3GTRED	5" x 3"	15.69
2959	5.4GTRED	5" x 4"	16.91
2960	6.3GTRED	6" x 3"	18.53
2961	6.4GTRED	6" x 4"	15.35
2962	6.5GTRED	6" x 5"	17.75
2964	7.4GTRED	7" x 4"	19.05
2965	7.5GTRED	7" x 5"	19.05
2966	7.6GTRED	7" x 6"	18.51
2967	8.5GTRED	8" x 5"	22.37
2968	8.6GTRED	8" x 6"	16.95
2969	8.7GTRED	8" x 7"	18.62
2972	10IN.6GTRED	10" x 6"	23.54
2973	10IN.7GTRED	10" x 7"	25.79
2974	10IN.8GTRED	10" x 8"	19.88
2976	12IN.6GTRED	12" x 6"	27.25
2977	12IN.8GTRED	12" x 8"	24.91
2978	12IN.10INGTRED	12" x 10"	23.06

**Tapered Reducers (Continued)**

Prod ID#	CSI#	Size	Price
3988	14IN.8GTRED	14" x 8"	46.07
2979	14IN.10INGTRED	14" x 10"	32.45
3989	14IN.12INGTRED	14" x 12"	37.25
34259	16IN.12INGTRED	16" x 12"	41.88
34370	16IN.14INGTRED	16" x 14"	45.00

**Tees**



Prod ID#	CSI#	Size	Ga	Price
3027	326GAT	3"	26	21.03
3028	426GAT	4"	26	17.86
3029	526GAT	5"	26	21.37
3030	626GAT	6"	26	20.61
3031	726GAT	7"	26	26.87
3032	826GAT	8"	26	24.87
3034	10IN26GAT	10"	26	39.03
3035	12IN26GAT	12"	26	55.71
3036	14IN26GAT	14"	26	63.72
3037	16IN26GAT	16"	26	104.59
3038	18IN26GAT	18"	26	157.45
3039	20IN24GAT	20"	24	205.02

**Drip Tees**



Prod ID#	CSI#	Size	Ga	Price
3042	5.5.426GAT	5" x 5" x 4"	26	21.01
3044	6.6.426GAT	6" x 6" x 4"	26	22.29
3047	7.7.426GAT	7" x 7" x 4"	26	32.30

**Tee Caps**

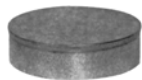

Prod ID#	CSI#	Size	Ga	Price
3899	3GTC	3"	26	8.72
3900	4GTC	4"	26	7.40
3901	5GTC	5"	26	8.20
3902	6GTC	6"	26	8.37
3903	7GTC	7"	26	9.45
3904	8GTC	8"	26	10.12

Galvanized

**Galvanized Products**

**Tee Caps (Continued)**

Prod ID#	CSI#	Size	Ga	Price
3905	9GTC	9"	26	12.80
3906	10INGTC	10"	26	12.42
3907	12INGTC	12"	26	17.66
3908	14INGTC	14"	26	27.39
3909	16INGTC	16"	26	30.09
3910	18INGTC	18"	26	37.63
3911	20INGTC	20"	26	48.57
3978	24INGTC	24"	26	68.40

**Wyes**



Prod ID#	CSI#	Size	Ga	Price
4680	4.4.426GAY	4" x 4" x 4"	26	30.89
3053	5.4.326GAY	5" x 4" x 3"	26	32.32
14226	5.4.426GAY	5" x 4" x 4"	26	37.85
28434	5.5.426GAY	5" x 5" x 4"	26	39.77
6781	5.5.526GAY	5" x 5" x 5"	26	45.62
24497	6.4.426GAY	6" x 4" x 4"	26	44.20
18809	6.5.426GAY	6" x 5" x 4"	26	44.20
7960	6.6.426GAY	6" x 6" x 4"	26	44.20
7959	6.6.626GAY	6" x 6" x 6"	26	44.20
3056	8.6.626GAY	8" x 6" x 6"	26	59.46

**Cold Air Boots**



Prod ID#	CSI#	Size	Price
3237	20IN.8CAB	20" x 8"	125.25
23257	20IN.10INCAB	20" x 10"	143.28
3238	24IN.8CAB	24" x 8"	144.20
3239	24IN.10INCAB	24" x 10"	144.20
6613	24IN.16IN.24IN.8GCAB	24" x 16" - 24" x 8" A/C Return Boot	143.72
6616	24.20.24.10CAB	24" x 20" - 24" x 10" A/C Return Boot	135.80
42296	22.14.24.8CAB	22" x 14" - 24" x 8" A/C Return Boot	133.63
42293	22.18.24.10CAB	22" x 18" - 24" x 10" A/C Return Boot	143.72
46559	25.10CAB	25 x 10	144.20
65968	24.10.24.16GCAB	24" x 10" - 24" x 16" A/C Return Boot	113.88

**Return Air Drops & Plenums**

**Cold Air Packages (Cross Broke)**

- Package Includes:
  - 4' Section of duct
  - S-cleats
  - Drive cleats
  - Cold air boot
  - Canvass Connector

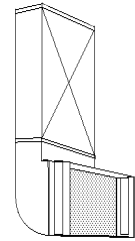

Prod ID#	CSI#	Size	Price
17879	20IN.8CAPCB	20" x 8"	246.38
23300	20IN.10INCAPCB	20" x 10"	293.50
17880	24IN.8CAPCB	24" x 8"	293.50
17881	24IN.10INCAPCB	24" x 10"	313.19
17882	24.16.24.8CAPCB	24" x 16" - 24" x 8"	278.15
17883	24.20.24.10CAPCB	24" x 20" - 24" x 10"	302.03
65969	24.10.24.16GCAP	24" x 10" - 24" x 16"	310.91

**Plenum Packages**

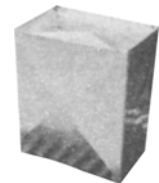

Prod ID#	CSI#	Size	Price
59946	1338.2012.36PP	13-3/8" x 20-1/2" x 36"	126.18
59947	1338.2012.48PP	13-3/8" x 20-1/2" x 48"	162.05
70485	1338.2012.60PP	13-3/8" x 20-1/2" x 60"	205.97
59948	1638.2012.36PP	16-3/8" x 20-1/2" x 36"	138.15
59950	1638.2012.48PP	16-3/8" x 20-1/2" x 48"	165.76
70486	1638.2012.360PP	16-3/8" x 20-1/2" x 60"	209.32
59951	1978.2012.36PP	19-7/8" x 20-1/2" x 36"	154.44
59952	1978.2012.48PP	19-7/8" x 20-1/2" x 48"	185.08
70487	1978.2012.60PP	19-7/8" x 20-1/2" x 60"	216.31
59953	2338.2012.36PP	23-3/8" x 20-1/2" x 36"	165.57
59954	2338.2012.48PP	23-3/8" x 20-1/2" x 48"	200.24
70488	2338.2012.60PP	23-3/8" x 20-1/2" x 60"	231.18
73837	1338.1914.36PP	13-3/8" x 19-1/4" x 36"	138.76
73170	1338.1914.48PP	13-3/8" x 19-1/4" x 48"	178.25
74185	1338.1914.60PP	13-3/8" x 19-1/4" x 60"	205.32
73838	1638.1914.36PP	16-3/8" x 19-1/4" x 36"	145.79
73171	1638.1914.48PP	16-3/8" x 19-1/4" x 48"	183.39
74186	1638.1914.60PP	16-3/8" x 19-1/4" x 60"	208.70
73839	1978.1914.36PP	19-7/8" x 19-1/4" x 36"	154.44
73840	1978.1914.48PP	19-7/8" x 19-1/4" x 48"	187.13
74187	1978.1914.60PP	19-7/8" x 19-1/4" x 60"	215.86
73841	2338.1914.36PP	23-3/8" x 19-1/4" x 36"	165.34
73842	2338.1914.48PP	23-3/8" x 19-1/4" x 48"	200.21
74188	2338.1914.60PP	23-3/8" x 19-1/4" x 60"	230.53

**Galvanized Products**

**Rectangular Duct & Fittings**

**Cross Broke Rectangular Duct With Cleats**

- Drives turned

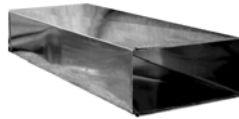

Prod ID#	CSI#	Size	Price
24327	8.8.48D	8" x 8" x 48"	31.86
24328	10.8.48D	10" x 8" x 48"	32.49
68529	10.10.48D	10" x 10" x 48"	33.23
24329	12.8.48D	12" x 8" x 48"	32.64
65170	12.10.48D	12" x 10" x 48"	34.79
68542	14.7.48D	14" x 7" x 48"	44.75
24330	14.8.48D	14" x 8" x 48"	40.15
68530	14.10.48D	14" x 10" x 48"	37.92
24331	16.8.48D	16" x 8" x 48"	46.61
68446	16.10.48D	16" x 10" x 48"	41.21
24332	18.8.48D	18" x 8" x 48"	52.38
68531	18.10.48D	18" x 10" x 48"	49.21
24333	20.8.48D	20" x 8" x 48"	55.20
24514	20.10.48D	20" x 10" x 48"	62.28
24334	22.8.48D	22" x 8" x 48"	63.00
24335	24.8.48D	24" x 8" x 48"	65.63
24336	24.10.48D	24" x 10" x 48"	77.48
50175	25.10.48D	25" x 10" x 48"	96.26

**Drives Turned Cross Broke Rectangular Duct w/Cleats & Drives Turned**

Prod ID#	CSI#	Size	Price
27948	8.8.96DK	8" x 8" x 96"	56.88
27949	10.8.96DK	10" x 8" x 96"	62.34
27950	12.8.96DK	12" x 8" x 96"	66.19
27951	14.8.96DK	14" x 8" x 96"	68.30
27952	16.8.96DK	16" x 8" x 96"	76.27
27953	18.8.96DK	18" x 8" x 96"	105.53
27954	20.8.96DK	20" x 8" x 96"	100.54
27955	22.8.96DK	22" x 8" x 96"	118.58
27956	24.8.96DK	24" x 8" x 96"	102.71
27957	24.10.96DK	24" x 10" x 96"	127.64

**Drives Turned Cross Broke Rectangular Duct Less Cleats w/Drives Turned**

Prod ID#	CSI#	Size	Price
27192	NC8.8.96D	8" x 8" x 96"	53.91
27194	NC10.8.96D	10" x 8" x 96"	58.74
27195	NC12.8.96D	12" x 8" x 96"	62.49
68767	NC12.10.96D	12" x 10" x 96"	65.38
27196	NC14.8.96D	14" x 8" x 96"	64.85
68766	NC14.10.96D	14" x 10" x 96"	72.24

**Drives Turned Cross Broke Rectangular Duct Less Cleats w/Drives Turned (Continued)**

Prod ID#	CSI#	Size	Price
27197	NC16.8.96D	16" x 8" x 96"	83.50
68765	NC16.10.96D	16" x 10" x 96"	82.85
27198	NC18.8.96D	18" x 8" x 96"	100.45
27199	NC20.8.96D	20" x 8" x 96"	95.70
69709	NC20.10.96D	20" x 10" x 96"	103.39
27200	NC22.8.96D	22" x 8" x 96"	113.32
27201	NC24.8.96D	24" x 8" x 96"	97.84
27202	NC24.10.96D	24" x 10" x 96"	122.54

**Galvanized End Caps**

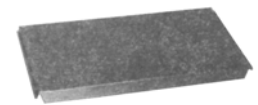

Prod ID#	CSI#	Size	Price
2810	314.10INGEC	3-1/4" x 10"	11.50
2811	314.12INGEC	3-1/4" x 12"	14.40
2812	8.8GEC	8" x 8"	10.03
2813	10IN.8GEC	10" x 8"	10.56
2814	12IN.8GEC	12" x 8"	10.56
66956	12IN.10INGEC	12" x 10"	12.60
2815	14IN.8GEC	14" x 8"	11.21
2816	16IN.8GEC	16" x 8"	11.64
68752	16IN.10INGEC	16" x 10"	12.94
2817	18IN.8GEC	18" x 8"	12.38
2818	20IN.8GEC	20" x 8"	13.64
43465	20IN.10INGEC	20" x 10"	16.68
2819	22IN.8GEC	22" x 8"	18.66
2820	24IN.8GEC	24" x 8"	19.93
2821	24IN.10INGEC	24" x 10"	21.73
68758	25.10EC	25" x 10"	25.22

Galvanized

**Galvanized Products**

Galvanized

**Vertical 45° Angles**



Prod ID#	CSI#	Size	Price
25390	214.10INGV45	2-1/4" x 10"	14.97
25389	214.12INGV45	2-1/4" x 12"	17.99
2776	314.10INGV45	3-1/4" x 10"	17.18
2777	314.12INGV45	3-1/4" x 12"	17.18
4002	8.8GV45	8" x 8"	31.01
2863	10IN.8GV45	10" x 8"	33.03
2864	12IN.8GV45	12" x 8"	33.97
68739	12IN.10INGV45	12" x 10"	28.98
2865	14IN.8GV45	14" x 8"	35.53
68740	14IN.10INGV45	14" x 10"	31.10
2866	16IN.8GV45	16" x 8"	37.37
68741	16IN.10INGV45	16" x 10"	38.76
2867	18IN.8GV45	18" x 8"	43.01
68743	18IN.10INGV45	18" x 10"	41.29
2868	20IN.8GV45	20" x 8"	43.01
68757	20IN.10INGV45	20" x 10"	47.54
2870	24IN.8GV45	24" x 8"	58.21
36156	24IN.10INGV45	24" x 10"	66.47

**Horizontal 45° Angles**

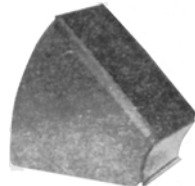

Prod ID#	CSI#	Size	Price
2779	314.10INGH45	3-1/4" x 10"	26.09
2871	8.8GH45	8" x 8"	37.60
2872	10IN.8GH45	10" x 8"	30.32
2873	12IN.8GH45	12" x 8"	31.89
68747	12IN.10INGH45	12" x 10"	35.85
2874	14IN.8GH45	14" x 8"	35.71
68748	14IN.10INGH45	14" x 10"	40.18
2875	16IN.8GH45	16" x 8"	37.58
68749	16IN.10INGH45	16" x 10"	43.06
2876	18IN.8GH45	18" x 8"	42.05
68750	18IN.10INGH45	18" x 10"	44.96
2877	20IN.8GH45	20" x 8"	55.08
2878	22IN.8GH45	22" x 8"	55.57
2879	24IN.8GH45	24" x 8"	68.95
36158	24IN.10INH45	24" x 10"	74.05

**Vertical 90° Elbows**



Prod ID#	CSI#	Size	Price
2780	214.10INGV90	2-1/4" x 10"	13.36
2782	314.10INGV90	3-1/4" x 10"	18.78
2781	214.12INGV90	2-1/4" x 12"	17.90
2783	314.12INGV90	3-1/4" x 12"	19.96
4003	8.8GV90	8" x 8"	39.44
2880	10IN.8GV90	10" x 8"	44.99
2881	12IN.8GV90	12" x 8"	44.53
68735	12IN.10INGV90	12" x 10"	48.82
70583	14IN.7GV90	14" x 7"	44.57
2882	14IN.8GV90	14" x 8"	48.28
2883	16IN.8GV90	16" x 8"	48.62
68737	16IN.10INGV90	16" x 10"	56.88
2884	18IN.8GV90	18" x 8"	54.25
68738	18IN.10INGV90	18" x 10"	63.01
2885	20IN.8GV90	20" x 8"	55.42
57457	20IN.10INV90	20" x 10"	65.07
2886	22IN.8GV90	22" x 8"	67.96
2887	24IN.8GV90	24" x 8"	62.75
36155	24IN.10INV90	24" x 10"	76.53

**Horizontal 90° Elbows**

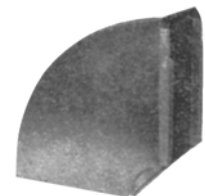

Prod ID#	CSI#	Size	Price
2778	314.10INGH90	3-1/4" x 10"	33.54
4004	8.8GH90	8" x 8"	47.66
2888	10IN.8GH90	10" x 8"	40.77
2889	12IN.8GH90	12" x 8"	45.61
68744	12IN.10INGH90	12" x 10"	51.42
2890	14IN.8GH90	14" x 8"	52.57
68745	14IN.10INGH90	14" x 10"	55.12
2891	16IN.8GH90	16" x 8"	53.18
2892	18IN.8GH90	18" x 8"	67.44
68746	18IN.10INGH90	18" x 10"	68.53
2893	20IN.8GH90	20" x 8"	72.90
70617	20IN.10INGH90	20" x 10"	85.21
2894	22IN.8GH90	22" x 8"	80.60
2895	24IN.8GH90	24" x 8"	95.19
39098	24IN.10INH90	24" x 10"	101.49

**Galvanized Products**

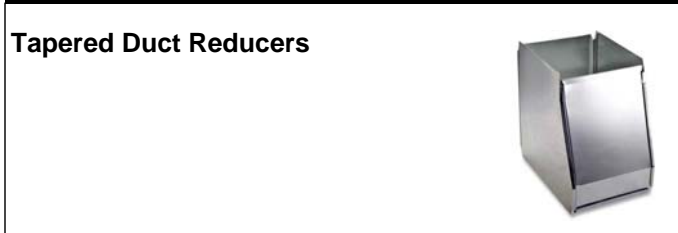

Prod ID#	CSI#	Size	Price
2896	12IN.8.8.GTDRED	12" x 8" - 8" x 8"	56.71
2897	12IN.8.10IN.8.GTDRED	12" x 8" - 10" x 8"	56.71
2899	14IN.8.10IN.8.GTDRED	14" x 8" - 10" x 8"	56.95
2898	14IN.8.12IN.8.GTDRED	14" x 8" - 12" x 8"	56.95
22801	16IN.8.10IN.8.GTDRED	16" x 8" - 10" x 8"	56.95
2900	16IN.8.12IN.8.GTDRED	16" x 8" - 12" x 8"	56.95
2901	16IN.8.14IN.8.GTDRED	16" x 8" - 14" x 8"	56.95
22790	18IN.8.12IN.8.GTDRED	18" x 8" - 12" x 8"	58.05
2902	18IN.8.14IN.8.GTDRED	18" x 8" - 14" x 8"	58.05
2903	18IN.8.16IN.8.GTDRED	18" x 8" - 16" x 8"	71.10
22792	20IN.8.14IN.8.GTDRED	20" x 8" - 14" x 8"	58.05
2904	20IN.8.16IN.8.GTDRED	20" x 8" - 16" x 8"	70.82
2905	20IN.8.18IN.8.GTDRED	20" x 8" - 18" x 8"	64.89
4006	22IN.8.16IN.8.GTDRED	22" x 8" - 16" x 8"	80.06
2906	22IN.8.18IN.8.GTDRED	22" x 8" - 18" x 8"	80.06
2907	22IN.8.20IN.8.GTDRED	22" x 8" - 20" x 8"	80.06
41585	24IN.8.18IN.8.GTDRED	24" x 8" - 18" x 8"	90.55
2908	24IN.8.20IN.8.GTDRED	24" x 8" - 20" x 8"	68.69
2909	24IN.8.22IN.8.GTDRED	24" x 8" - 22" x 8"	90.55
41643	24IN.10IN.20IN.8GTDR	24" x 10" - 20" x 8"	95.73
34510	24IN.10IN.24IN.8GTDR	24" x 10" - 24" x 8"	95.39

**Straight Take-Offs**

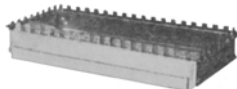

Prod ID#	CSI#	Size	Price
4058	8.8GSTO	8" x 8"	19.74
2910	10IN.8GSTO	10" x 8"	21.20
2911	12IN.8GSTO	12" x 8"	21.70
2912	14IN.8GSTO	14" x 8"	22.83
2913	16IN.8GSTO	16" x 8"	24.00
2914	18IN.8GSTO	18" x 8"	26.33
2915	20IN.8GSTO	20" x 8"	28.59
2916	24IN.8GSTO	24" x 8"	29.96
68112	12IN.10INGSTO	12" X 10"	32.22
77856	16IN.10INGSTO	16" x 10"	31.26
24719	20IN.10INGSTO	20" x 10"	41.40
24720	24IN.10INGSTO	24" x 10"	51.62
50176	25IN.10INGSTO	25" x 10"	60.26

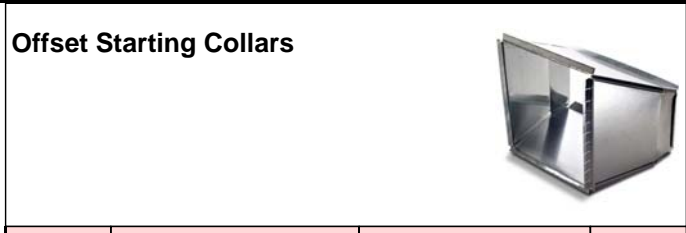

Prod ID#	CSI#	Size	Price
45076	8.8OSC	8" x 8"	55.46
4007	12IN.10IN.10IN.8GOSC	10" x 8" - 12" x 10"	54.02
2917	12IN.12IN.12IN.8GOSC	12" x 8" - 12" x 12"	54.02
2918	14IN.12IN.14IN.8GOSC	14" x 8" - 14" x 12"	55.75
2920	18IN.12IN.18IN.8GOSC	18" x 8" - 18" x 12"	61.49
2921	20IN.12IN.20IN.8GOSC	20" x 8" - 20" x 12"	78.70

**Reducing Plenum Starter**

- Center 2" Rise
- Duct to plenum take off

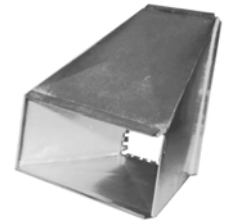

Prod ID#	CSI#	Size	Price
25077	12IN.8.8.12INGRPS	12" x 8" - 8" x 12"	68.83
25078	14IN.8.10IN.12INRPS	14" x 8" - 10" x 12"	70.70
25079	16IN.8.10IN.13INRPS	16" x 8" - 10" x 13"	72.91
25080	18IN.8.10IN.15INRPS	18" x 8" - 10" x 15"	75.23
25081	20IN.8.10IN.16INRPS	20" x 8" - 10" x 16"	79.19
25082	22IN.8.10IN.18INRPS	22" x 8" - 10" x 18"	84.75
25083	24IN.8.12IN.16INRPS	24" x 8" - 12" x 16"	84.08
43565	24IN.10.12IN.22INGRPS	24" x 10" - 12" x 22"	93.78

**Ductboard Collars**

**Ductboard Top Collars Without Damper**



Prod ID#	CSI#	Size	Price
3208	6GDBTC	6"	11.58
3209	7GDBTC	7"	14.17
3210	8GDBTC	8"	13.88
3212	10INGDBTC	10"	17.48
3213	12INGDBTC	12"	22.60
3214	14INGDBTC	14"	32.52
3215	16INGDBTC	16"	39.42
3216	18INGDBTC	18"	47.77

Galvanized

**Galvanized Products**

Galvanized

**Wall Stack & Fittings**

**Wall Stack**

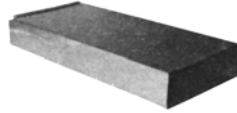

Prod ID#	CSI#	Size	Price
10481	214.10IN.96INGW	2-1/4" x 10" x 96"	72.45
10482	214.12IN.96INGWS	2-1/4" x 12" x 96"	77.66
18841	314.10IN.24INGWS	3-1/4" x 10" x 24"	20.96
2774	314.10IN.102INGWS	3-1/4" x 10" x 102"	59.47
2775	314.12IN.102INGWS	3-1/4" x 12" x 102"	68.16

**Galvanized Stack Heads**

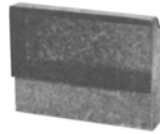

Prod ID#	CSI#	Size	Price
25084	214.10.10.6GSH	2-1/4" x 10" - 10 x 6	22.43
25085	214.12.12.6SH	2-1/4" x 12" - 12 x 6	26.73
2807	314.10IN.10IN.6GSH	3-1/4" x 10" - 10 x 6	19.19
2808	314.12IN.12IN.6GSH	3-1/4" x 12" - 12 x 6	23.45
63358	314.10IN.10IN.4DSH	3-1/4" x 10" - 10 x 4	31.46

**Floor Sleeves**



Prod ID#	CSI#	Size	Price
2805	314.10IN.4.10INGFS	3-1/4" x 10" - 4" x 10"	21.86
2806	314.12IN.4.12INGFS	3-1/4" x 12" - 4" x 12"	26.21

**Filter Racks**



Prod ID#	CSI#	Size	Price
39614	16.25FR	16" x 25"	63.60

**Oval Pipe**



Prod ID#	CSI#	Size	Ga	Price
5432	6.100IN30GAOVP	6" x 100"	30	28.21
65849	6.113IN30GAOVP	6" x 113"	30	38.24
3134	7.100IN30GAOVP	7" x 100"	30	44.22
73612	8.100IN30GAOVP	8" x 100"	30	44.61

**Oval Fittings**

**Oval Vertical 90° Elbows**



Prod ID#	CSI#	Size	Price
3121	6GOVV90	6"	8.74
3136	7GOVV90	7"	18.51
73613	8GOVV90	8"	21.83

**Oval Vertical 45° Angles**

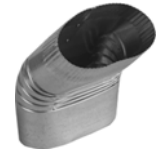

Prod ID#	CSI#	Size	Price
3119	6GOVV45	6"	8.79
3135	7GOVV45	7"	16.15
73614	8GOVV45	8"	18.93

**Oval Horizontal 90° Elbows**



Prod ID#	CSI#	Size	Price
3122	6GOVH90	6"	19.65
3139	7GOVH90	7"	27.91
73615	8GOVH90	8"	45.28

**Oval Horizontal 45° Angles**



Prod ID#	CSI#	Size	Price
3120	6GOVH45	6"	15.59
3138	7GOVH45	7"	24.82
73616	8GOVH45	8"	26.41

**Oval 90° Boots**

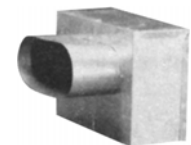

Prod ID#	CSI#	Size	Price
40743	314.10IN.6GOV90	3-1/4" x 10" x 6"	25.29
3150	4.10IN.6GOV90B	4" x 10" x 6	21.70
3151	4.10IN.7GOV90B	4" x 10" x 7	26.17
3152	4.12IN.7GOV90B	4" x 12" x 7	27.73



**Galvanized Products**



Prod ID#	CSI#	Size	Price
3147	4.10IN.6GOV45B	4" x 10" x 6	23.24
3149	4.12IN.7GOV45B	4" x 12" x 7	27.77

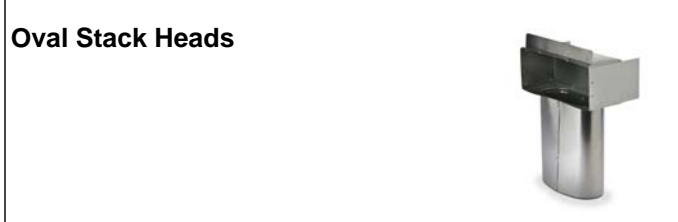

Prod ID#	CSI#	Size	Price
63423	4.10IN.6GOVSH	4" x 10" x 6"	21.06
3154	6.10IN.6GOVSH	6" x 10" x 6"	15.78
73420	6.10IN.6GOVSH12	6" x 10" x 6"-12"LNG	16.97
3155	6.10IN.7GOVSH	6" x 10" x 7"	22.17
3156	6.12IN.6GOVSH	6" x 12" x 6"	29.71
3157	6.12IN.7GOVSH	6" x 12" x 7"	25.98
73515	6.14IN.7GOVSH	6" x 14" x 7"	27.96
73623	6.14IN.8GOVSH	6" x 14" x 8"	25.45
70361	6.10.6DOSH	6x10x6 Double OSH	21.32



Prod ID#	CSI#	Size	Price
3123	6GRD.OVUNIB	6"	18.16
3126	6GRD.OVNCUNIB	6" No Crimp	18.16
9014	7GRD.OVNCUNIB	7" No Crimp	26.09
73620	8GRD.OVNCUNIB	8" No Crimp	39.67

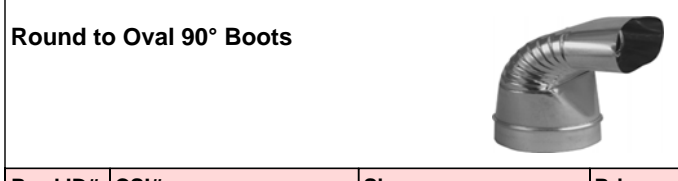

Prod ID#	CSI#	Size	Price
3127	6GRD.OV90B	6"	18.25
3129	6GRD.OVNC90B	6" No Crimp	20.04
9013	7GRD.OVNC90B	7" No Crimp	26.07
73618	8GRD.OVNC90B	8" No Crimp	27.49

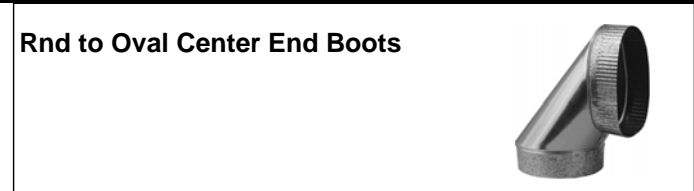

Prod ID#	CSI#	Size	Price
3130	6GRD.OVCEB	6"	19.28
3132	6GRD.OVNCCEB	6" No Crimp	19.28
9012	7GRD.OVNCCEB	7" No Crimp	24.16
73617	8GRD.OVNCCEB	8" No Crimp	49.25

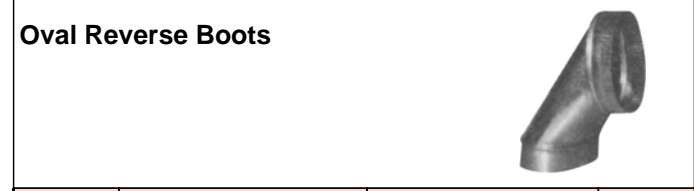

Prod ID#	CSI#	Size	Price
3133	6GOVRB	6"	33.17
73622	8GOVRB	8"	85.84

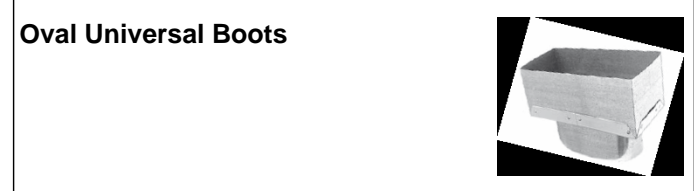

Prod ID#	CSI#	Size	Price
3144	4.10IN.6GOVUNIB	4" x 10" x 6	26.29

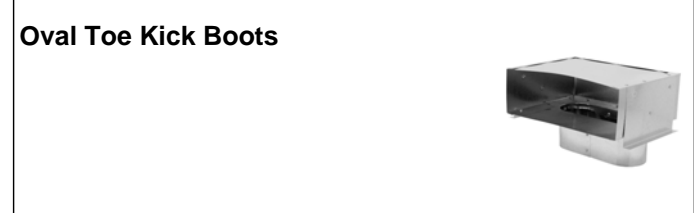

Prod ID#	CSI#	Size	Price
73421	314.10.6OTKB	3-1/4" x 10" x 6	43.84



Prod ID#	CSI#	Size	Price
3158	6GOVF	6" (Pr)	5.07

Galvanized

**Galvanized Products**

Galvanized

**Sheet Metal Accessories**

**Drive Cleats**



Prod ID#	CSI#	Size	Price
2992	10INGDC	10" OD For 8" Duct	0.94
2993	12INGDC	12" OD For 10" Duct	1.08
3979	14INGDC	14" OD For 12" Duct	1.22
2997	60INGDC	60"	4.03

**"S" Cleats**



Prod ID#	CSI#	Size	Price
4043	8INGSC	8"	1.26
2998	10INGSC	10"	1.59
2999	12INGSC	12"	1.67
3000	14INGSC	14"	1.96
3001	16INGSC	16"	1.93
3002	18INGSC	18"	2.15
3003	20INGSC	20"	2.18
3981	22INGSC	22"	2.56
3004	24INGSC	24"	2.56
3006	60INGSC	60"	5.80

**Standing "S" Cleat L-Bar**



Prod ID#	CSI#	Size	Ga	Price
3007	10SSC24GA	10'	24	24.58

**"A" Collars**



Prod ID#	CSI#	Size	Price
3070	3GAC	3"	4.49
3071	4GAC	4"	4.37
3072	5GAC	5"	4.49
3073	6GAC	6"	3.00
3074	7GAC	7"	3.92
3075	8GAC	8"	4.18
3077	10INGAC	10"	6.29
3078	12INGAC	12"	7.09
3079	14INGAC	14"	11.12
3080	16INGAC	16"	15.81

**"B" Collars**



Prod ID#	CSI#	Size	Price
3082	4GBC	4"	3.70
3083	5GBC	5"	3.96
3084	6GBC	6"	3.00
3085	7GBC	7"	4.07
3086	8GBC	8"	4.52
3088	10INGBC	10"	6.70
3089	12INGBC	12"	7.09
3090	14INGBC	14"	11.01

**Flex Collars**



Prod ID#	CSI#	Size	Price
64865	4GFC	4"	7.65
3091	5GFC	5"	7.09
3092	6GFC	6"	6.21
3093	7GFC	7"	6.52
3094	8GFC	8"	7.04
3096	10INGFC	10"	9.52
3097	12INGFC	12"	11.17
3098	14INGFC	14"	20.43
3099	16INGFC	16"	39.08
3100	18INGFC	18"	45.56
3101	20INGFC	20"	53.43
51799	6FCWD	6" w/Damper	26.20
51800	8FCWD	8" w/Damper	37.40

**AirTite Takeoffs**



Prod ID#	CSI#	Size	Price
64283	6ATT	6"	11.33
66103	7ATT	7"	11.98
64284	8ATT	8"	13.62
64285	10ATT	10"	18.15
64286	12ATT	12"	21.94
64287	14ATT	14"	26.47
73508	16ATT	16"	36.80
75413	18ATT	18"	49.43

**Galvanized Products**

**AirTite Takeoffs With Dampers**



Prod ID#	CSI#	Size	Price
72215	6ATTD	6" with Damper	15.49
72217	8ATTD	8" with Damper	18.22
72218	10ATTD	10" with Damper	23.52
72219	12ATTD	12" with Damper	32.27
73052	14ATTD	14" with Damper	37.67
73053	16ATTD	16" with Damper	44.56

**Adhesive Saddle Tap With Damper**

Prod ID#	CSI#	Size	Price
74636	6ASTw/Damper	6" Adh Saddle Tap w/Damper	20.85

**Adjustable Storm Collars**



Prod ID#	CSI#	Size	Price
3103	4GASC	4"	18.37
3105	6GASC	6"	20.70
3106	7GASC	7"	24.99
3107	8GASC	8"	24.93
3108	10INGASC	10"	31.77
3109	12INGASC	12"	37.03

**Cold Air Grounds**



Prod ID#	CSI#	Size	Price
66819	4.10.24PF	4x10x24 Plaster Frm	8.75
69567	4.12.24PF	4x12x24 Plaster Frm	9.50

**Angles**



Prod ID#	CSI#	Size	Price
68633	1.2.48ANG	1" x 2" x 48" Long	9.33
3306	1.3ANG	1" x 3" x 17" Long	3.41

**Plaster Frames**

Prod ID#	CSI#	Size	Price
27313	60INCAG	60"	5.93
3243	96INCAG	96"	11.12

**Canvas Connectors**

Prod ID#	CSI#	Size	Price
3271	10IN.8CC	10" x 8"	38.55
3272	12IN.8CC	12" x 8"	40.19
3273	14IN.8CC	14" x 8"	42.97
3274	16IN.8CC	16" x 8"	47.12
3275	18IN.8CC	18" x 8"	40.99
3276	20IN.8CC	20" x 8"	48.54
23256	20IN.10INCC	20" x 10"	50.85
3277	22IN.8CC	22" x 8"	55.50
3278	24IN.8CC	24" x 8"	51.68
4013	24IN.10INCC	24" x 10"	55.69

**Panning**



Prod ID#	CSI#	Size	Price
3281	1612IN.30INSP	16-1/2" x 30" w/Pitts	10.60
3283	33IN.30INDP	33" x 30" Dbl w/Pitts	20.98
76290	24IN.32INDP	24" x 32" Dbl w/Pitts	117.59

**Duct Adapters**

Prod ID#	CSI#	Size	Price
3307	2GDA	2"	16.82
3308	4GDA	4"	17.28

**Hanging Straps**

Prod ID#	CSI#	Size	Ga	Price
3319	1.1018GAHS	1" x 10'	18	10.04

**Rain Caps**



Prod ID#	CSI#	Size	Price
3913	4GRC	4"	22.16
3915	6GRC	6"	27.29
3917	8GRC	8"	42.78
3919	10INGRC	10"	49.22
3920	12INGRC	12"	54.72

Galvanized

**Galvanized Products**

Galvanized

**Make Up Air Units**

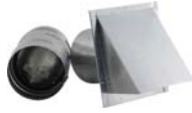

Prod ID#	CSI#	Size	Price
18311	RDWVG4	4"	52.75
18310	RDWVG6	6"	54.57

**Vent Caps Only For Make Up Air**



Prod ID#	CSI#	Size	Price
4608	4MUAH	4"	40.16
4609	6MUAH	6"	42.84
59515	8MUAH	8"	58.45
70791	10MUAH	10"	76.16

**Warm Air Double Bearing Dampers**



Prod ID#	CSI#	Size	Price
3266	10INWAD	10"	15.79
3267	12INWAD	12"	18.73
3268	14INWAD	14"	20.84
3269	16INWAD	16"	37.69

**Access Doors**



Prod ID#	CSI#	Size	Price
3298	6.6AD	6" x 6"	32.74
3299	8.8AD	8" x 8"	35.07
3300	10IN.10INAD	10" x 10"	34.16
3301	12IN.12INAD	12" x 12"	38.38
3302	14IN.14INAD	14" x 14"	65.86

**Accessories**

**Filter Rack with Cover**

Prod ID#	CSI#	Description	Price
76181	16.25.1EFR	16x25x1 Econ Filt Rack w/cover	43.19

**Furnace Literature Rack**

Prod ID#	CSI#	Description	Price
57859	PAPERPOCKET	Literature Rack	17.96

**Fusible Links**



Prod ID#	CSI#	Size	Ga	Price
26236	LINK165-3	LINK165-3		9.80
26237	LINK212-3	LINK212-3		9.80

**Warm Air Dampers**

- Single Bearing Damper
- Completely die cut



Prod ID#	CSI#	Size	Price
71260	4WAD	4"	4.20
3262	5WAD	5"	6.25
3263	6WAD	6"	4.71
3264	7WAD	7"	6.47
3265	8WAD	8"	6.47

**Joist Bridging**

- Bend a bracket bridging
- V-shaped for maximum strength



Prod ID#	CSI#	Size	Gauge	Price
10642	2022GAJB	3/4" x 20"	22	1.56

**THERM-O-MFG., INC.**

**Thermo-Panning Return Air Panning**

- Fire Resistant
- Thermo-Pan is a high quality, lightweight alternative to sheet metal in constructing return air ducts between joists
- Consists of corrugated insulation faced with aluminum
- Significantly reduces duct noises & labor
- Requires no shop fabrication

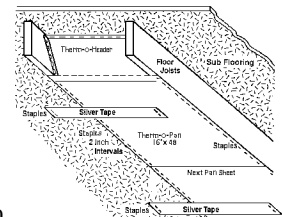

Prod ID#	CSI#	Size	Price
12180	16.48FRTP T-ST-16-48	16"x48" Fire Resistant Thermo Panning	8.95
20349	195.48FRTP T-ST-19-48	19-1/2"x48" Fire Resist Thermo Panning	14.42
13051	32.36FRTP T-ST-32-36	32"x36" Fire Resistant Thermo Panning	13.82

**Thermo Panning Products**

**Thermo Panning Headers**

**For Tight Sealing Air Blocks**

- Fire Resistant
- T-Rap Headers are pre-cut & scored to fit easily between joists



Prod ID#	CSI#	Size	Price
42723	16.12FRHD (T-16013)	16"x12" Fire Resistant I-Joist Header	6.20
43135	16.17FRHD (T-16018)	16"x17" Fire Resistant I-Joist Header	9.94
47411	19.16FRHD (T-16020)	19"x16" Fire Resistant I-Joist Header	12.81

**Thermo Panning Frame**



**Return Air Grille Dry Wall Frames**

- Precision molded polypropylene...No product loss on truck or on the job site
- Safety edged...all sides & ends
- Frames can be cut for use as a single frame
- Place grille over frame and screw into precision molded frame holes on finished dry wall

**Standard - Allows Unfiltered Air Flow**

Prod ID#	CSI#	Size	Price
15975	30.6EP (14630)	30"x6" or 2 @ 14"x6"	7.34

**Galvanized Sheets**

- Call for lift quotes (2500lbs)
- Grade 1 prime

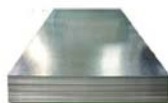

Prod ID#	CSI#	Gauge	Size	Price
3287	36IN.96IN30GASHE	30	36" x 96"	42.37
3286	36IN.96IN28GASHE	28	36" x 96"	43.64
3285	36IN.96IN26GASHE	26	36" x 96"	42.53
3284	36IN.96IN24GASHE	24	36" x 96"	61.48
4624	48IN.96IN26GASHE	26	48" x 96"	58.89
17244	48IN.96IN24GASHE	24	48" x 96"	72.08
77311	48IN.120IN26GASHE	26	48" x 120"	75.33

**We appreciate your business!**

Galvanized

**Galvanized Products**

Galvanized

**Spiral Galvanized Product**

**Spiral Galvanized Pipe**



Prod ID#	CSI#	Size	Price
31540	6.10SGP	6" x 10'	49.69
31541	8.10SGP	8" x 10'	65.71
31542	10IN.10SGP	10" x 10'	81.93
31543	12IN.10SGP	12" x 10'	99.04
31544	14IN.10SGP	14" x 10'	114.98
31545	16IN.10SGP	16" x 10'	149.98

**Spiral Galvanized Elbows 90Deg**



Prod ID#	CSI#	Size	Price
31555	6SG90	6"	26.40
31556	8SG90	8"	33.44
31557	10INSG90	10"	44.38
31558	12INSG90	12"	56.22
31559	14INSG90	14"	65.08
31560	16INSG90	16"	77.65

**Spiral Galvanized Connectors**



Prod ID#	CSI#	Size	Price
31561	6SGCON	6"	11.11
31562	8SGCON	8"	15.76
31563	10INSGCON	10"	18.87
31564	12INSGCON	12"	23.48
31565	14INSGCON	14"	26.01
31566	16INSGCON	16"	31.15

**Spiral Galvanized End Caps**



Prod ID#	CSI#	Size	Price
40982	6SGEC	6"	20.80
31568	8SGEC	8"	25.71
31569	10INSGEC	10"	30.95
31570	12INSGEC	12"	44.28
31571	14INSGEC	14"	54.72
31572	16INSGEC	16"	63.77

**Spiral Galvanized Tapered Reducers**



Prod ID#	CSI#	Size	Price
31587	10IN.8SGTR	10" x 8"	60.94
31581	12IN.8SGTR	12" x 8"	82.69
31579	12IN.10INSGTR	12" x 10"	82.58
31578	14IN.10INSGTR	14" x 10"	90.80
31577	14IN.12INSGTR	14" x 12"	82.00

**Spiral Galvanized Shoe Taps**



Prod ID#	CSI#	Size	Price
31590	6SGST	6" -Fits 6"-10" Pipe	54.96
31591	8SGST	8" -Fits 8"-12" Pipe	57.42
31592	10INSGST	10" -Fits 10"-14" Pipe	62.76
31593	12INSGST	12" -Fits 12"-16" Pipe	69.39
36034	6SGSTA	6" -Fits 12"-16" Pipe	55.00
33785	8SGSTA	8" -Fits 12"-18" Pipe	57.42

**PCD Underground Duct**

**PCD Pipe - 4 x 4**



Prod ID#	CSI#	Size	Price
1816	6.10PCDP	6" x 10'	141.71
1819	8.10PCDP	8" x 10'	187.55
1820	10IN.10PCDP	10" x 10'	275.33
1821	12IN.10PCDP	12" x 10'	331.51

**PCD 90° Elbow - 4 x 4**



Prod ID#	CSI#	Size	Price
1833	6PCD90	6"	51.20
1835	8PCD90	8"	56.47
1836	10INPCD90	10"	73.96
1837	12INPCD90	12"	101.99

**PCD 45° Elbow - 4 x 4**



Prod ID#	CSI#	Size	Price
1829	6PCD45	6"	38.01
1830	8PCD45	8"	37.00
1831	10INPCD45	10"	52.11
1832	12INPCD45	12"	73.10

Shaded Items are Non-Stock special order

Sterling Hts, MI - Livonia, MI - Lansing, MI - Grand Rapids, MI - Waterford, MI - Almont, MI - Saginaw, MI

**Galvanized Products**

**PCD Connectors - 4 x 4**



Prod ID#	CSI#	Dia	Gauge	Price
1823	6PCDCON	6"	26	23.48
1825	8PCDCON	8"	26	26.07
1826	10INPCDCON	10"	24	33.52
1827	12INPCDCON	12"	24	39.14

**PCD Tapered Reducer 4 x 4**



Prod ID#	CSI#	Size	Price
1872	8.6PCDTRED	8" x 6"	97.44
1873	10IN.6PCDTRED	10" x 6"	110.38
1874	10IN.8PCDTRED	10" x 8"	113.53
1875	12IN.8PCDTRED	12" x 8"	138.46
1876	12IN.10INPCDTRED	12" x 10"	138.46

**PCD Tee - 4 x 4**



Prod ID#	CSI#	Size	Price
1839	6PCDTEE	6"	78.62
1840	8PCDTEE	8"	98.31
1841	10INPCDTEE	10"	117.08
1842	12INPCDTEE	12"	152.77

**PCD End Caps - 4 x 4**



Prod ID#	CSI#	Size	Price
1847	6PCDCAP	6"	28.16
1849	8PCDCAP	8"	36.63
1850	10INPCDCAP	10"	46.03
1851	12INPCDCAP	12"	64.65

**PCD Saddles - 4 x 4**



Prod ID#	CSI#	Size	Price
1853	4.10INPCDS	4" x 10"	87.48
1854	4.12INPCDS	4" x 12"	63.64

**PCD 90° Boots - 4 x 4**



Prod ID#	CSI#	Size	Price
1863	314.10IN.6PCD90	3-1/4" x 10 x 6	96.66
1864	4.10IN.6PCD90	4" x 10" x 6"	99.51
1865	4.12IN.6PCD90	4" x 12" x 6"	102.39

**PCD Center End Boots - 4 x 4**



Prod ID#	CSI#	Size	Price
1860	4.10IN.6PCDCEB	4" x 10" x 6"	102.31

**PCD Shoe Taps - 4 x 4**



Prod ID#	CSI#	Size	Price
1866	6PCDST	6"	79.47
1867	8PCDST	8"	66.15
4219	10INPCDST	10"	81.73

**PCD Parts & Accessories**

Prod ID#	CSI#	Size	Price
2516	PCDSP	PCD Spray Paint f/Touch-Up Use Only	57.11



**Commercial Duct Connection Products**

**Flange-Galvanized**

- J-rated flange meets SMACNA rigidity class J for traverse joints (steel)

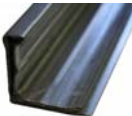

Prod ID#	CSI#	Description	Price
33417	LJ15GA	J-Flange, 20ga x 20'	55.00

**Corners**

- 11ga galv steel
- Nuts & bolts included



Prod ID#	CSI#	Description	Price
33419	LJCGA	J System Corner, 200-Pc/Bx	440.67

Shaded Items are Non-Stock special order

Sterling Hts, MI - Livonia, MI - Lansing, MI - Grand Rapids, MI - Waterford, MI - Almont, MI - Saginaw, MI

### Galvanized Products

#### Cleats, Galvanized



Prod ID#	CSI#	Description	Price
33421	LW6CGA	6" Metal Cleat, 400-Pc/Bx	251.32

#### Gasket Tape

##### Butyl

- Will adhere to a variety of clean, dry surfaces
- Enhanced sealing and aging characteristics
- Will not crack or separate while being applied at low temperature ranges
- 3/16" x 5/8" x 30'
- Provides a non-drying, permanently flexible gasket
- UL listed

Prod ID#	CSI#	Size	Price
33423	WBG	Butyl gasket, 30' Roll	11.56

#### Vane & Rail

- Roll formed galvanized steel



Prod ID#	CSI#	Description	Gauge	Price
33426	2VGA26	2" x 10' Hollow Vane	26	27.16
33427	L2RGA22	2" x 10' Rail	22	27.45
33428	4VGA24	4" x 10' Hollow Vane	24	53.59
33429	L4RGA22	4" x 10' Rail	22	45.66



#### Flexible Duct Connectors

##### Metal Fab - 24 Gauge

- 3" metal - 3" fabric - 3" metal



Prod ID#	CSI#	Description	Price
3571	MBX	Black Excelon - 100'	542.65

##### Junior Connector - 28 Gauge

- 1-3/4" metal - 3" fabric - 1-3/4" metal



Prod ID#	CSI#	Description	Price
45058	JFF	Black Excelon - 100'	282.48

#### Duro Vane Rails

- 24 Gauge
- Precision stamped and slotted for uniform spacing

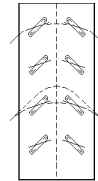

Prod ID#	CSI#	Description	Price
3572	VR2	Continuous Coil - 100'	258.88

#### Rapit™ Regulators

- Rattle-free

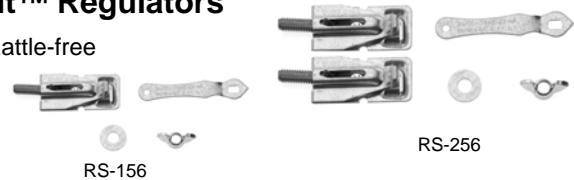

Prod ID#	CSI#	Description	Price
3575	RS156	1 Spring Bearing, 1 Washer, Handle & Wing Nut (10/Pk)	35.97
3576	RS256	2 Spring Bearings, 1 Washer, Handle & Wing Nut (10/Pk)	55.43

#### Rapit™ Bearings And Accessories



Prod ID#	CSI#	Description	Price
3578	RP1	Handles (100 Pk)	47.33
3580	RP2	Wing Nut (100 Pk)	57.67
3581	RP3	Washer (100 Pk)	19.86
3582	RB50	Rapit Spring Bearing	171.02

#### Quadline® Damper Quadrant Sets

##### 3/8" Quadrant Sets

- For dampers up to 20"



Prod ID#	CSI#	Description	Price
3577	KS385	3/8" Quad Set: K-4 Quadrant, KP-7 Spring Loc Bearing, KP-9S Sq End Bearing, KP7 Spring Loc Bearing	21.86

#### Stampline Regulator

##### 3/8" Dial Regulator

- For dampers up to 20"



Prod ID#	CSI#	Description	Price
69412	KR3-8058	3/8" Regulator for sq rod (100pk)	493.80

Shaded Items are Non-Stock special order

Sterling Hts, MI - Livonia, MI - Lansing, MI - Grand Rapids, MI - Waterford, MI - Almont, MI - Saginaw, MI



Ventilation

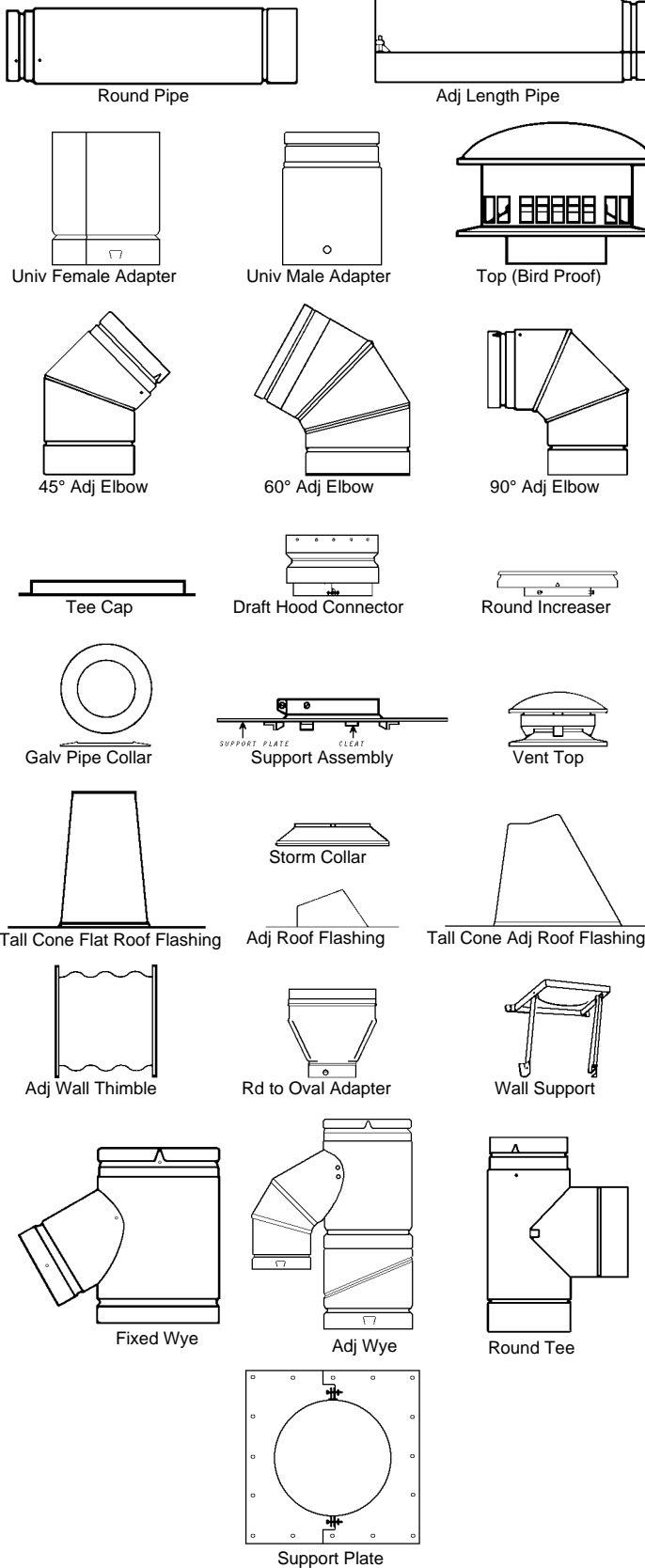

**Type "B" Gas Vent Pipe & Fittings**  
**3" Gas Vent Round**

Prod ID#	CSI#	Description	Pkg Qty	Price
40364	3RV-TF (103815)	3" Tall Cone Flashing	6	40.72

**4" Gas Vent Round**

Prod ID#	CSI#	Description	Pkg Qty	Price
40115	4RV-6 (104006)	4"x6" Round Pipe	6	22.22
40114	4RV-12 (104012)	4"x12" Round Pipe	6	24.86
40125	4RV-AJ (104082)	4"x12" Adj Length Pipe	6	26.12
40089	4RV-18 (104018)	4"x18" Round Pipe	6	24.58
40124	4RV-2 (104024)	4"x24" Round Pipe	6	30.58
40084	4RV-3 (104036)	4"x36" Round Pipe	6	41.68
40138	4RV-4 (104048)	4"x48" Round Pipe	6	54.27
40083	4RV-5 (104060)	4"x60" Round Pipe	6	64.79
40086	4RV-EL45/60 (104222)	4" 45°/60° Adj Elbow	6	38.94
40085	4RV-EL90 (104230)	4" 90° Adj Elbow	6	54.47
40106	4RV-RT (104800)	4" Top	6	26.19
40090	4RV-HWT (104802)	4" Hi-Wind Top	6	40.07
40091	4RV-SC (104810)	4" Storm Collar	6	5.35
40092	4RV-AF (104825)	4" Adj Roof Flashing 0-6/12 Pitch	6	18.30
40128	4RV-AF12 (104830)	4" Adj Roof Flashing 6/12-12/12 Pitch	6	58.05
40129	4RV-TF (104815)	4" Tall Cone Flashing	6	38.56
40369	4RV-TS (104100)	4" Tee	6	84.18
40370	4RV-TC (104180)	4" Tee Cap	6	6.54
40779	4RV-4FY (104134)	4" x 4" Fixed Wye	3	84.18
40139	4RV-I5 (104305)	4" x 5" Increaser	6	46.70
40278	4RV-I6 (104306)	4" x 6" Increaser	6	45.34
40375	4RV-UAF (104080)	4" Univ Female Adapter	6	52.49

Ventilation

Ventilation

**4" Gas Vent Round (Continued)**

Prod ID#	CSI#	Description	Pkg Qty	Price
40373	4RV-UAM (104081)	4" Univ Male Adapter	6	52.49
40372	4RV-WT (187704)	4" Wall Thimble	6	38.75
40371	4RV-DH (104240)	4" Draft Hood Connector	6	23.92
41063	4OV-RV4 (164370)	4" Adapter-RV to WV Oval	6	61.06

**5" Gas Vent Round**

Prod ID#	CSI#	Description	Pkg Qty	Price
40117	5RV-6 (105006)	5"x6" Round Pipe	6	25.38
40116	5RV-12 (105012)	5"x12" Round Pipe	6	29.33
40127	5RV-AJ (105082)	5"x12" Adj Length Pipe	6	32.96
40093	5RV-18 (105018)	5"x18" Round Pipe	6	31.50
40126	5RV-2 (105024)	5"x24" Round Pipe	6	41.56
40081	5RV-3 (105036)	5"x36" Round Pipe	6	54.61
40140	5RV-4 (105048)	5"x48" Round Pipe	6	70.28
40080	5RV-5 (105060)	5"x60" Round Pipe	6	75.19
40095	5RV-EL45/60 (105222)	5" 45°/ 60° Adj Elbow	6	41.56
40094	5RV-EL90 (105230)	5" 90° Adj Elbow	6	63.75
40107	5RV-RT (105800)	5" Vent Top	6	35.98
40096	5RV-HWT (105802)	5" Hi-Wind Top	6	53.39
40097	5RV-SC (105810)	5" Storm Collar	6	11.90
40098	5RV-AF (105825)	5" Adj Roof Flashing 0-6/12 Pitch	6	31.63
40130	5RV-AF12 (105830)	5" 12" Adj Roof Flashing 6/12-12/12 Pitch	6	62.96
40131	5RV-TF (105815)	5" Tall Cone Flashing	6	47.72
40144	5RV-TS (105100)	5" Tee	6	91.76
40376	5RV-TC (105180)	5" Tee Cap	6	8.57
40378	5RV4-FY (105134)	5" x 5" x 4" Wye	3	91.81

**5" Gas Vent Round (Continued)**

Prod ID#	CSI#	Description	Pkg Qty	Price
40102	5RV4-4FY (1051344)	5" x 4" x 4" Wye	3	118.03
41018	5RV-T4 (105104)	5" x 5" x 4" Tee	6	106.07
40141	5RV-I6 (105306)	5" x 6" Increaser	6	46.28
40399	5RV-UAF (105080)	5" Univ Female Adapter	6	54.99
40397	5RV-WT (187705)	5" Wall Thimble	6	44.35
40396	5RV-DH (105240)	5" Draft Hood Connector	6	24.72

**6" Gas Vent Round**

Prod ID#	CSI#	Description	Pkg Qty	Price
40119	6RV-6 (106006)	6"x6" Round Pipe	6	31.07
40118	6RV-12 (106012)	6"x12" Round Pipe	6	32.49
40133	6RV-AJ (106082)	6"x12" Adj Length Pipe	6	41.15
40101	6RV-18 (106018)	6"x18" Round Pipe	6	34.11
40132	6RV-2 (106024)	6"x24" Round Pipe	6	47.17
40100	6RV-3 (106036)	6"x36" Round Pipe	6	60.62
40142	6RV-4 (106048)	6"x48" Round Pipe	6	77.78
40099	6RV-5 (106060)	6"x60" Round Pipe	4	88.29
40111	6RV-EL45/60 (106222)	6" 45°/60° Adj Elbow	6	48.75
40110	6RV-EL90 (106230)	6" Adjustable 90° El	6	76.39
40108	6RV-RT (106800)	6" Vent Top	6	45.57
40103	6RV-HWT (106802)	6" Hi-Wind Cap	4	69.77
40104	6RV-SC (106810)	6" Storm Collar	6	11.67
40112	6RV-AF (106825)	6" Adj Roof Flashing 0-6/12 Pitch	6	42.00
40135	6RV-AF12 (106830)	6" Adj Roof Flashing 6/12-12/12 Pitch	6	85.12
40134	6RV-TF (106815)	6" Tall Cone Flashing	6	57.09
40277	6RV-TS (106100)	6" Tee	6	98.73

Ventilation

Ventilation

6" Gas Vent Round (Continued)				
Prod ID#	CSI#	Description	Pkg Qty	Price
40391	6RV-TC (106180)	6" Tee Cap	6	10.03
40393	6RV-4FY (106134)	6" x 6" x 4" Wye	3	97.69
40394	6RV-I7 (106307)	6" x 7" Increaser	4	58.05
40710	6RV-UAM (106081)	6" Univ Male Adapter	6	61.35
41034	6RV-WT (187706)	6" Wall Thimble	6	53.25
41100	6RV-DH (106240)	6" Draft Hood Connector	6	28.30

**Quick Grip Firestop/Spacer**

- Use on type B double wall gas vents
- Firestop/spacer
- Produces rigid vent installation, can support up to 30'
- Can be placed anywhere on pipe
- No screws in vent pipe

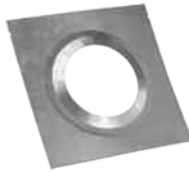

Prod ID#	CSI#	Description	Pkg Qty	Price
3291	4RV-FSP (104406)	4" Firestop/Spacer		36.06
3292	5RV-FSP (105406)	5" Firestop/Spacer		35.22
3293	6RV-FSP (106406)	6" Firestop/Spacer		38.52

**7" Gas Vent Round**

Prod ID#	CSI#	Description	Pkg Qty	Price
40440	7RV-6 (107006)	7"x6" Round Pipe	4	42.47
40441	7RV-12 (107012)	7"x12" Round Pipe	4	50.33
40442	7RV-AJ (107082)	7"x12" Adj Length Pipe	4	53.91
40444	7RV-2 (107024)	7"x24" Round Pipe	4	88.93
40445	7RV-3 (107036)	7"x36" Round Pipe	4	114.07
40447	7RV-5 (107060)	7"x60" Round Pipe	4	164.69
40459	7RV-EL90 (107230)	7" 90° Adj Elbow	4	155.51
40449	7RV-RT (107800)	7" Vent Top	4	88.09

7" Gas Vent Round (Continued)				
Prod ID#	CSI#	Description	Pkg Qty	Price
40451	7RV-SC (107810)	7" Storm Collar	4	17.04
40452	7RV-AF (107825)	7" Adj Roof Flashing 0-6/12 Pitch	4	64.83
40453	7RV-AF12 (107830)	7" Adj Roof Flashing 6/12-12/12 Pitch	4	111.16
40458	7RV-TF (107815)	7" Tall Cone Flashing	4	83.71
40461	7RV-TC (107180)	7" Tee Cap	4	17.18
40448	7RV-TS (107100)	7" Tee	4	114.73

**8" Gas Vent Round**

Prod ID#	CSI#	Description	Pkg Qty	Price
40237	8RV-12 (108012)	8"x12" Round Pipe	4	58.19
40463	8RV-AJ (108082)	8"x12" Adj Length Pipe	4	63.84
40236	8RV-2 (108024)	8"x24" Round Pipe	4	99.72
40235	8RV-3 (108036)	8"x36" Round Pipe	4	127.78
40234	8RV-5 (108060)	8"x60" Round Pipe	4	189.07
40238	8RV-EL90 (108230)	8" 90° Adj Elbow	4	165.72
40240	8RV-RT (108800)	8" Vent Top	4	113.23
40241	8RV-SC (108810)	8" Storm Collar	4	17.56
40242	8RV-AF (108825)	8" Adj Roof Flashing 0-6/12 Pitch	4	70.29
40243	8RV-TF (108815)	8" Tall Cone Flat Roof Flashing	4	93.74
40465	8RV-TS (108100)	8" Tee	4	157.81
40466	8RV-TC (108180)	8" Tee Cap	4	20.24

10" Model R Gas B-Vent Round				
Prod ID#	CSI#	Description	Pkg Qty	Price
74720	10R18-S	10"x18" Round Pipe	2	185.59
74171	10R18A-S	10"x18" Round Pipe Adj	2	269.91
74177	10R3-S	10"x36" Round Pipe	2	276.69
74178	10R45-S	10" 45° Fixed Elbow	2	271.98
74180	10C-S	10" Universal Cap	1	267.18

Ventilation

Ventilation

10" Model R Gas B-Vent Round (Continued)

Prod ID#	CSI#	Description	Pkg Qty	Price
74181	10RSC-S	10" Storm Collar	1	25.85
74713	10RF-S	10" Adj Roof Flashing 0-6/12 Pitch	1	136.53
74179	10RFT-S	10" Tall Cone Flashing	1	164.78
74724	10RTC-S	10" Tee Cap	1	49.95
74150	10RT-S	10" Tee	1	484.97

12" Model R Gas B-Vent Round

Prod ID#	CSI#	Description	Pkg Qty	Price
74725	12R18-S	12"x18" Round Pipe	2	219.20
74726	12R18A-S	12"x18" Adj Length Pipe	2	279.18
74175	12R3-S	12"x36" Round Pipe	2	329.65
74685	12R45-S	12" 45° Adj Elbow	2	290.15
74174	12C-S	12" Universal Cap	1	324.95
74688	12RSC-S	12" Storm Collar	1	39.55
74723	12RF-S	12" Adj Roof Flashing 0-6/12 Pitch	1	176.55
74689	12RFT-S	12" Tall Cone Flashing	1	207.34
74687	12RTC-S	12" Tee Cap	1	65.72
74686	12RT-S	12" Tee	1	498.25

Gas Vent Oval Pipe & Fittings

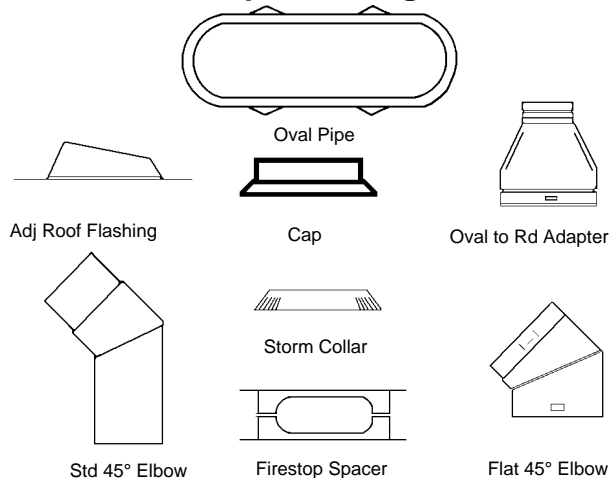

4" Gas Vent Oval

Prod ID#	CSI#	Description	Pkg Qty	Price
41061	4OV-60 (164060)	60" Oval Pipe	6	124.30
41064	4OV-45S (164215)	Standard 45° Elbow	6	88.98
41065	4OV-FS (164460)	Fire Stop Spacer	6	26.41
41062	4OV-RV4 (164380)	Adapter-WV Oval to RV Rnd	6	61.06
41063	4RV-OV4 (164370)	Adapter- RV Rd to WV Oval	6	61.06

Flexible Double Wall Gas Vent Connectors

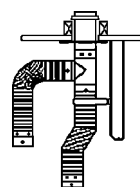

4" Flexible Gas Vent

Prod ID#	CSI#	Description	Pkg Qty	Price
41262	4DWC-2 (1740022)	2' Connector	6	108.81
40889	4DWC-3 (1740033)	3' Connector	6	121.25
40832	4DWC-4 (1740044)	4' Connector	6	141.33
40833	4DWC-5 (1740066)	5' Connector	6	155.93

**THANK YOU!**  
*We appreciate  
your business*

Ventilation

**Chimney Systems**

- Rugged all fuel chimney
- Meets all UL® requirements
- Model SSII-Type HT tested to 2100°F
- Model SSII tested UL®-103 max temp of 1700°F
- Gravity venting only

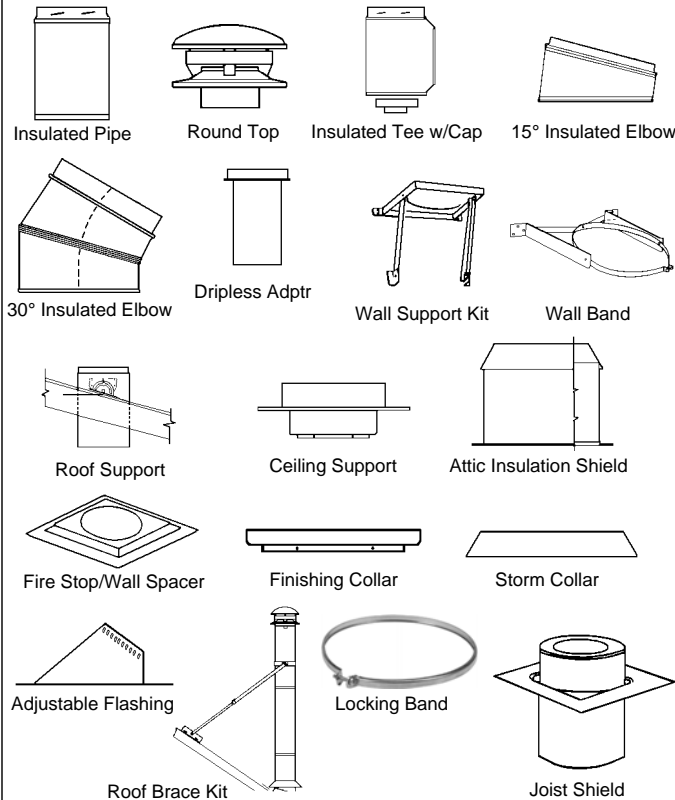

**SSII-Type HT 6" Insulated Pipe & Fittings**

Prod ID#	CSI#	Description	Price
41564	5/6ST-SC (206810)	6" Metal Storm Collar	20.09
41565	6T-AF6 (206825)	6" Adj Flashing	112.77
41563	6T-CT (206800)	Round Top	124.29
41571	6T-TWK (206622)	6" Thru-the-wall kit	1034.28
41562	6UT-36 (206036U)	6x36 Pipe	251.83

**SSII-Type HT 8" Insulated Pipe & Fittings**

Prod ID#	CSI#	Description	Price
41576	7/8T-SC (208810)	8" Metal Storm Collar	22.74
41577	8T-AF6 (208825)	Adj Flashing	166.33

**SSII-Type HT 8" Insulated Pipe & Fittings (Continued)**

Prod ID#	CSI#	Description	Price
41575	8T-CT (208800)	Round Top	227.78
41578	8T-EL30KIT (208211)	30° Elbow Kit 2-PC	672.05
41580	8T-FCK (208620)	8" Flat Ceiling Supp Kit	866.87
41581	8T-PCK (208621)	8 Pitched Ceiling Kit	703.78
41582	8T-TWK (208622)	8" Thru-the-Wall Kit	1506.55
41573	8UT-18 (208018U)	8x18 Insulated Pipe	203.02
41574	8UT-36 (208036U)	8x36 Insulated Pipe	380.62

**AL29-4C Stainless Steel Venting**

- Factory built-in Silicone Seal
- Tested and Listed to UL1738/ULCS636 by Underwriters Laboratories, Inc.
- Patented Ring-And-Tab Closure System allows installation without tools or RTV Silicone

**3" Single Wall Venting**

- Commonly used for horizontal venting of boilers and unit heaters.

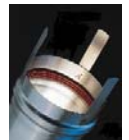

Prod ID#	CSI#	Description	Pkg Qty	Price
67564	9324	3" SS 6"-9" Adj Pipe	6	117.91
70802	9301	3"x6" SS EZ Seal Pipe	6	46.55
68810	9302	3"x12" SS EZ Seal Pipe	6	57.41
67561	9305	3"x2' SS EZ Seal Pipe	6	97.74
67562	9307	3"x3' SS EZ Seal Pipe	6	128.77
68616	9308	3"x4' SS EZ Seal Pipe	6	197.04
69176	9360	3"x5' SS EZ Seal Pipe	6	226.52
68617	9314	3" EZ Seal 90 Deg Elbow	6	145.84
67563	9314LR	3" EZ Seal Long Rad Elb.	6	145.84
68909	9311	3" EZ Seal 45 Deg Ang	6	122.57
69178	9316	3" EZ Seal Tee	6	136.53
70803	9317	3" EZ Seal Tee Cap	6	55.85
69181	5390CI	3"EZ Seal Wall Penetrate	6	462.35
70806	010921	3" Vent Cap Baffled	6	64.44

Ventilation

Ventilation

**4" Single Wall Venting**

- Commonly used for horizontal venting of boilers and unit heaters.



Prod ID#	CSI#	Description	Pkg Qty	Price
70808	9401	4"x6" SS EZ Seal Pipe	6	52.75
70809	9402	4"x12" SS EZ Seal Pipe	6	66.73
70810	9405	4"x2' SS EZ Seal Pipe	6	107.05
70811	9407	4"x3' SS EZ Seal Pipe	6	155.15
70814	9414	4" EZ Seal 90 Deg Elbow	6	190.83
70815	9414LR	4" EZ Seal Long Rad Elb.	6	190.85
70816	9416	4" EZ Seal Tee	6	144.29
70817	9417	4" EZ Seal Tee Cap	6	55.85
70835	5490CI	4"EZ Seal Wall Penetrate	6	510.44
68439	010922	4" Vent Cap Baffled	3	74.47

**Flexi-Sleeves**

- Minimize condensation and down-drafting, particularly if:
  - Flue gas temperature is below 280°F
  - Flexi-Liner is installed in exterior chimney
  - Liner is venting gas-assisted appliances
  - Masonry chimney is contaminated with fossil fuels residue
  - Appliance is equipped with a vent damper



Prod ID#	CSI#	Size	Price
26624	AF4-FS	4" x 10'	75.18
26625	AF5-FS	5" x 10'	84.58

**10' Extension Kits**

**Kit Contains:**

- 10' Extension Liner Tube
- Joiner



Prod ID#	CSI#	Size	Price
1317	DB410EXT	4" x 10'	69.96
1318	DB510EXT	5" x 10'	85.80

**B Vent Universal Adapters**

- For connecting Chimney Liner to Gas B-Vent



Prod ID#	CSI#	Size	Price
7033	AF4-BVA	4"	53.32
7034	AF5-BVA	5"	57.73
20946	AF6-BVA	6"	65.74

**M-FLEX Liner Kits**

National Chimney manufactures the M-FLEX liner kits for appliances with A.F.U.E. of 83% or lower

**Aluminum Kit Contains:**

- UL listed and tested 2 ply aluminum liner
- Aluminum mortar collar for slipping the liner through the thimble
- Aluminum top plate with at 16"x16" plate and a 2" high collar
- Aluminum cap and installation instructions
- All M-FLEX aluminum liner kits come with a 25 year warranty and are listed to UL441.



Prod ID#	CSI#	Size	Price
5469	DB425KIT	4" x 25'	138.51
5470	DB525KIT	5" x 25'	162.40
5471	DB625KIT	6" x 25'	254.83
1312	DB435KIT	4" x 35'	146.06
1313	DB535KIT	5" x 35'	187.53
1314	DB5.535KIT	5-1/2" x 35'	307.02
1315	DB635KIT	6" x 35'	325.67
4114	DB735KIT	7" x 35'	480.07

Ventilation

**Barometric Draft Controls**

**Type RC For Oil or Coal Systems - Residential & Commercial**

- Standard equipment on many leading brands of oil or coal heating equipment
- Calibrated to allow for easy adjustment to the furnace or boiler specifications
- Designed for settings from .02" - .08" this control is so sensitive that instrumentation should be used when adjusting the unit during installation



Prod ID#	CSI#	Control Size	Nom Capacity Sq In	Dia(In)	Recommended Pipe Sizes Circum	Dimensions	Price
1943	FC6RC	6"	28.3"	5-6-7	15-3/4" - 22"	6" x 1-7/8" x 3"	83.08
1946	FC8RC	8"	50.3"	7-8-9	22" - 28-1/8"	8" x 4-3/8" x 4"	141.45

**EvenAir® Air Boosters**

- Improves air flow & distribution of conditioned air to "problem" rooms in homes & businesses
- Mounted under ductwork & improve air flow by up to 305 CFM improving heating/cooling system efficiency & saving energy



Prod ID#	CSI#	-----Motor Data-----				Protection	CFM	Price
		Volts	Amps	Hz	Watts			
51700	AB1(46012102)	120 AC	.5	60	38	Thermally	305	260.27



**Seven stand alone locations state wide to serve your needs!**

**Sterling Hts, MI - Livonia, MI - Lansing, MI - Grand Rapids, MI - Waterford, MI - Almont, MI - Saginaw, MI**

Ventilation

**Bath Ventilation**

**Economy Fan/Lights**

- Compact units
- Provide ventilator and 100-watt light capacity (bulbs not included)
- Molded 11-1/8" x 10-5/8" plastic grille and shatter resistant lens
- 8" x 8-1/4" x 5-3/4" high housing
- Fits 4" round duct
- Type IC



Prod ID#	CSI#	CFM	Sones	Sensor	Price
532	679	70	3.5	Fan/Light	166.85

**Premium Fans**

- Easy installation
- Designer style white polymeric grille
- Centrifugal blower wheel & 4 pole motor
- Durable dampers prevent cold air backdraft
- Fits 4" round duct



Prod ID#	CSI#	CFM	Sones	Price
531	676	110	4.0	179.76
533	684	80	2.5	162.13

**Ceiling/Wall Mount Fans**

- Easy installation
- Torsion spring grille mounting
- Durable dampers prevent cold air bac
- Fits 3" round duct
- Compact housing fits easily between joists or wall studs



Prod ID#	CSI#	CFM	Sones	Price
534	688	50	4.0	41.19
530	671	70	6.0	83.85

**ULTRA GREEN Series 80 CFM Fan**

- Easy installation
- With (L model) or without light
- ULTRASmart DC Motor & Control Technology
- Durable dampers prevent cold air backdraft
- Fits 4" or 6" round duct
- < .3 Sones



Prod ID#	CSI#	CFM	Sones	Price
70137	ZB80	80	<.3	359.48
73381	ZB80L	80	<.3	512.28

**InVent Series Single-Speed Fan**

- Easy installation
- 80 CFM
- ENERGY STAR Certified
- Fits 4" round duct
- 1.5 Sones



Prod ID#	CSI#	CFM	Sones	Price
68785	AE80B	80	1.5	132.00

**Home Ventilation & Heat**

**LoSone Select Commercial Ventilators**

- Quiet, automatic backdraft damper
- Low profile white polymeric grille
- Heavy galvanized steel housing
- Sound-absorbing acoustic insulation
- Quiet, low RPM motor
- AMCA licensed for both air & sound
- Impact-resistant balanced centrifugal blower wheel
- White polymer, grille



**LoSone Select Ceiling Mount Ventilator - 100 CFM**

- 109 CFM, 0.9 sones horizontal
- 112 CFM, 1.0 sones vertical
- 6" round duct connector



Prod ID#	CSI#	Volts	CFM	Price
519	L100	120V	100	303.69

**LoSone Select Ceiling Mount Ventilator - 150 CFM**

- 157 CFM, 1.5 sones horizontal
- 160 CFM, 1.6 sones vertical
- 6" round duct connector

Prod ID#	CSI#	Volts	CFM	Price
520	L150	120V	150	322.09

**LoSone Select Ceiling Mount Ventilator - 200 CFM**

- 210 CFM, 1.7 sones horizontal
- 207 CFM, 2.0 sones vertical
- 8" round duct connector

Prod ID#	CSI#	Volts	CFM	Price
521	L200	120V	200	357.62

Ventilation



Ventilation

**LoSone Select Ceiling Mount Ventilator - 250 CFM**

- 259 CFM, 2.2 sones horizontal
- 259 CFM, 2.7 sones vertical
- 8" round duct connector

Prod ID#	CSI#	Volts	CFM	Price
39323	L250	120V	250	381.70

**LoSone Select Ceiling Mount Ventilator - 300 CFM**

- 308 CFM, 2.9 sones horizontal
- 313 CFM, 3.0 sones vertical
- 8" round duct connector

Prod ID#	CSI#	Volts	CFM	Price
522	L300	120V	300	385.05

**Black Steel Roof Caps**



634



636

Prod ID#	CSI#	Venting	Price
525	634	3-1/4" x 10" or 8" Rd Duct	77.18
526	636	For 3" or 4" Round Duct	42.56

**Hi Capacity Roof Cap**



- Up to 1200 CFM
- Black electronically-bonded epoxy finish
- Built-in spring-loaded backdraft damper and bird screen
- For use with high performance blower system

Prod ID#	CSI#	CFM Sones	Desc	Price
69739	437	Up to 1200 CFM		315.66

**Wall Caps**

639



641



Prod ID#	CSI#	Venting	Price
529	639	For 3-1/4" x 10" Duct	52.94
70009	641	For 6" Round Duct	98.51

**Pressure Relief Damper w/Wall Cap**

- 6" round duct
- 30 gauge
- Built in Bird Screen
- Can be used for Intake or Exhaust



Prod ID#	CSI#	Venting	Price
73757	BROBD6	6" Press Relief Damp w/Wall Cap	138.02

**Univ. Automatic Make-Up-Air Damper with Pressure Sensor Kit**

- Provides outside air when required to keep the in home fresher by allowing range hood to operate
- Meets IRC Code for range hoods over 400CFM
- Fresh air wall caps are required



Prod ID#	CSI#	Description	Price
69735	MD10TU	10" Make Up Air Damper w/Pressure Sensor Kit	453.29

Ventilation

Ventilation

**Delta Breez Energy Star Ventilation Fans**

**BreezSignature Series w/Dual Speed**



- Energy Star Qualified
- Quiet operation - Low Sones
- Energy savings up to 71%
- Green LED indicator light to show fan is On
- Engineered to run continuously for a min 70,000 hours
- For continuous low speed mode, the fan runs at 4 preset lower levels.
- Delay time preset positions (0.5,5,15,30,45 or 60 minutes)



Prod ID#	CSI#	CFM	Sones	Watts	Accy	Price
72206	SIG80D	80	.3	8.7		293.75
73813	SIG110D	110	.3	9.0		328.02
70049	SIG110HL	110	.4	9.0	26CFL & Humidity Sens	487.86
77092	SIG80-110D	80-110	.3	8.2	Dual Spd	328.02
75878	SIG80-110DLED	80-110	.3	12.7	Dual Spd & 26wCFL	438.14

**Green Builder Series**



- Exceeds Energy Star Requirements
- UL Listed for both Ceiling and Wall mount installations
- DC brushless motor for long life, low noise, and low power consumption



GBR80, GBR100 GBR100L GBR80LED

Prod ID#	CSI#	CFM	Sones	Watts	Accy	Price
68823	GBR50	50	.3	4		155.85
68824	GBR80	80	.8	10.5		155.85
70729	GBR80LED	80	.8	11.6	LED Light	229.74
69609	GBR100	100	1.4	12.6		174.17
69610	GBR100L	100	1.4	13.9	Light	248.68
76444	GBR100LED	100	1.4	13.9	LEDLight	240.65

**Delta Breez Integrity Series**

- Exceeds Energy Star Requirements
- DC brushless motor engineered to run continuously for a minimum of 70,000 hours
- 4" duct



ITG50, ITG80 ITG80LED

Prod ID#	CSI#	CFM	Sones	Watts	Accy	Price
75862	ITG50	50	.7	5		91.19
75962	ITG50LED	50	.7	5	LED Light	186.28
75863	ITG80	80	1.3	9.5		97.09
76086	ITG80LED	80	1.3	9.5	LED Light	205.39
78437	ITG100ELED	100	1.5	17	LED Light	224.73

**Ceiling Radiation Dampers**



SIG Series



GBR Series



Integrity Series

Prod ID#	CSI#	Description	Price
72207	SIG-CRD	SIG Ceiling Radiation Damper	136.53
71608	GBR-CRD	GBR Ceiling Radiation Damper	145.34
76087	ITG-CRD	ITG Ceiling Radiation Damper	145.34

**Sterling Hts, MI - Livonia, MI - Lansing, MI - Grand Rapids, MI - Waterford, MI - Almont, MI - Saginaw, MI**

Ventilation

**Roof Caps**

**Plastic**

- Resistant to cold, heat, and UV rays
- Comes with damper, screen, and removable stem

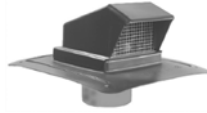

Prod ID#	CSI#	Size	Price
39471	BVDS4BK	4" Black	35.91
38609	BVDS4DBR	4" Dark Brown	35.91
42690	BVDS6BK	6" Black	43.37
38889	BVDS6DBR	6" Dark Brown	43.37

**Backdraft Damper**

- Horizontal or Vertical Installation
- Closes by gravity



Prod ID#	CSI#	Description	Price
56101	BD-4	4" Backdraft Butterfly Damp	34.51
60359	BD-6	6" Backdraft Butterfly Damp	35.50
70574	BD-8	8" Backdraft Butterfly Damp	41.48

**Wall Vent**

- Hooded with Screen



Prod ID#	CSI#	Description	Price
60357	SWV6A	6" AlumWall Vent w/Screen	42.69

**Hooded Wall Vent**

- Spring Loaded Damper
- Gasket and Screen
- Aluminum



Prod ID#	CSI#	Description	Price
76708	WVEB6A	6" Alum Hooded Vent w/Scrm & Spring Damper	42.85

**Rectangular Appliance Wall Vent**

- Powder Coated Galvanized Steel
- Damper & Screen
- 3-1/4" x 10"



Prod ID#	CSI#	Description	Price
75735	WV310HDBK	3-1/4" X 10" Rect. Bck. Wall Vent	70.78

**Round Soffit**

- Under Eave Vent -Plastic



Prod ID#	CSI#	Description	Price
75880	UEV6WH	6" Soffit/Under Eave Vent	21.62

**deflecto®**

**Venting**

**Aluminum Wallcap**



Prod ID#	CSI#	Description	Price
31965	DAHC7	7" Hood w/3" Tailpiece	63.40

**SUPURR-VENT® Louvered Vent Hood**

**Replacement Vent Hoods (Vent Only)**



Prod ID#	CSI#	Description	Price
1938	HS4B/48	4" Brown Vent Hood	16.18
1934	HS4W/48	4" White Vent Hood	16.18
1940	HS6B/12	6" Brown Vent Hood	16.40
1936	HS6W/12	6" White Vent Hood	16.40

**Fresh Air Intake Vents**

- With molded 1/4" plastic screen



Prod ID#	CSI#	Description	Price
37820	HSM4W/24	4" White Louvered Hood	11.86
37821	HSM4B/24	4" Brown Louvered Hood	11.86
25329	HSM6W	6" White Louvered Hood	20.10
25462	HSM6B	6" Brown Louvered Hood	19.97

**Soffit Vents**

- Vents exhaust ducts running through an attic to the outside
- Also fresh air intake vents

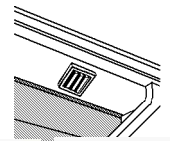

**Assembled - Hood & Pipe**



Prod ID#	CSI#	Description	Price
20402	RVMAB4	4" Brown Wide-Mouth	21.61
20403	RVMAW4	4" White Wide-Mouth	21.75

**SUPURR-VENT® Louvered Vent Hood**

- Includes hood, aluminum pipe & collar



Prod ID#	CSI#	Description	Price
41028	SVHAB4	4" Brown Hood	13.95

Ventilation

Ventilation

**Wide Mouth Hood**

- Includes hood, aluminum pipe & collar
- Includes bird guard



**Assembled**

Prod ID#	CSI#	Description	Price
1932	RVHAW3	3" White Hood	16.83
1931	RVHAB3	3" Brown Hood	16.83
1933	RVHAW4	4" White Hood	19.11
1930	RVHAB4	4" Brown Hood	16.94

**Dryer Vent Box**

- Saves Space- Recessed design
- Allows dryer to sit 4-6" closer to wall
- Reduces fire hazard
- Easy Installation
- Clean Appearance



Prod ID#	CSI#	Description	Price
70797	DVBOX	Dryer Vent Box with Metal Conn.	54.05

**Clothes Dryer Transition Duct**

- 4" x 25'
- Supurr-Flex® Multi-Layered Duct
- Fire Resistant
- Flexible, easy to install



Prod ID#	CSI#	Description	Price
70798	F0425	4" X 25' Supurr-Flex Duct	48.78



**Wall Vent Hoods**

- With dampers



Prod ID#	CSI#	Description	Price
7737	3510G	6" Gray Wall Vent Hood - Plastic	43.53
69910	389G	8" Gray Wall Vent Hood - Plastic	46.15
19544	348	8" Wall Vent Hood - Aluminum	51.20
50004	587	10" Wall Vent Hood - Aluminum	135.20



**Roto-Vent Grille  
With screen**



Prod ID#	CSI#	Size	Color	Price
19670	4WRVS	4"	White	15.84
19726	4BRVS	4"	Brown	15.84
69137	4DBRVS	4"	Dura-Beige	15.84
74598	6WRVS	6"	White	23.54



**Rigid Metal Pipe & Fittings  
Rigid Aluminum Pipe**

- One crimped end and one plain end
- Snap together assembly



Prod ID#	CSI#	Size	Price
3316	4.24INAP	4" x 24"	8.40
26687	4.60INAP	4" x 60"	24.67

**Standard Aluminum Adjustable Elbows**

- Turns 90° within 6", 4-Pc construction
- One crimped end
- 4-piece sectional adjustability



Prod ID#	CSI#	Size	Gauge	Price
3318	4A90	4"	26	6.75

**Flexible Pipe**

**V220 Aluminum Flexible Pipe**

- Light-weight aluminum
- Two plain untreated ends



Prod ID#	CSI#	Size	Price
3398	3.10ALUM	3" x 10'	16.62
3399	4.10ALUM	4" x 10'	21.35
3401	6.10ALUM	6" x 10'	34.66
3402	7.10ALUM	7" x 10'	48.97
3403	8.10ALUM	8" x 10'	54.08
7936	3.20ALUM	3" x 20'	22.28
7937	4.20ALUM	4" x 20'	28.42

Ventilation

**Ventilation**

**Dryer Vent Hoods**

- 11-1/2" tailpipe
- Back plate, back-draft flapper
- Fully assembled, riveted tailpipe



Prod ID#	CSI#	Size	Price
3288	3DVH	3" Aluminum	10.52
3289	4DVH	4" Aluminum	8.50

**Heavy Duty Galv Vent Hood**

- 26 guage galvanized
- 4 mounting holes for secure connections
- 6" tailpipe
- 1/4" x 1/4" Screen



Prod ID#	CSI#	Size	Price
72622	111080	6" 26ga Vent Hood 6" Tailpipe	25.19
76575	111082	8" 26ga Vent Hood 6" Tailpipe	30.21

**Dryer Outlet Box**

- One self trimming unit: 18"w 24"h
- Fits all 16" centers 2x4 and 2x6
- 6 prescored, true 4" knockouts
- 6 Starburst knockouts for gas connections and venting



Prod ID#	CSI#	Description	Price
68769	110696	Dryer Outlet Box	39.14

**Dryer Box**

- 22 Guage Aluminum Steel
- 21"h x 12-1/2"w x 4-3/8"d
- Inside measures 9-1/2w x 18-1/4"h
- Distance from nailing flange to rear of box is 3-1/2"
- Top port measures 4-15/16" X 3-5/32" oval shape
- For 2x4 walls



Prod ID#	CSI#	Description	Price
68977	DB-350	3.5" Deep Box, 2x4, Upflow	58.49

**Dryer Box**

- 22 Guage Aluminum Steel
- 21"h x 12-1/2"w x 5-1/8"d
- Inside measures 9-1/2w x 18-1/4"h
- For 2x6 Walls
- Distance from nailing flange to rear of box is 4-1/4"
- Top port measures 4-1/8" with very slight oval shape



Prod ID#	CSI#	Description	Price
73564	DB-425	4.25" Deep Box, 2x6, Upflow	58.49

**Dryer Box**

- 22 Guage Aluminum Steel
- 19"h x 16-3/4"w x 4-3/8"d DB-3D
- 19"h x 16-3/4"w x 5-1/8"d DB-4D
- Inside measures 14"w x 16"h
- For 2x4 Walls
- Distance from nailing flange to rear of box is 3-1/2"



Prod ID#	CSI#	Description	Price
77605	DB-3D	3.5" Deep Box, 2x4, Downflow	58.49
74847	DB-4D	4.25" Deep Box, 2x4, Downflow	58.49

**Dryer Box**

- 22 Guage Aluminum Steel
- 21" h x 12-1/2" w x 5-1/8" d
- Inside measures 9-1/2w x 18-1/4" h
- For 2x6 Walls
- Distance from nailing flange to rear of box is 4-1/4"

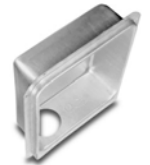

Prod ID#	CSI#	Description	Price
73564	DB-425	4.25" Deep Box, 2x6, Downflow	58.49



**Ventilation Products**

**Booster Fans**

- Hard to heat or cool rooms
- Installs in branch duct



Prod ID#	CSI#	Description	Price
26713	625-AF6 (13033)	6" Draft Booster 240 CFM	73.51
26714	625-AF8 (13034)	8" Draft Booster 420 CFM	98.57



**Versa Cap™ Flue & Hot Stack Caps**

- Non-clogging positive draft design
- Adj clamp Ftg, UL listed
- Aluminum



Prod ID#	CSI#	Description	Price
3922	6-3050	2-7/8" - 5" OD Pipe	52.92
3923	6-5070	4-7/8" - 7" OD Pipe	70.41
3924	6-7090	6-7/8" - 9" OD Pipe	69.77
3925	6-9011	8-7/8" - 11" OD Pipe	143.22
3926	6-1200	12" Adj	272.57

**Special Order**



**Fire Dampers, Radiation Dampers**



**FanTech Residential in-line fans, ceiling, duct mounted, roof mounted etc.**

HEAT CONTROLLER, INC.  
Heatcontroller.com

**Packaged Terminal Units(PTAC), Portable Coolers, Packaged  
Wall Mounted Units, Geothermal**



**Heat Transfer Products Boilers & Parts**



**Linesets Inc - Made to Order Any Length**



**Lloyd Smoke & Fire Dampers**



**Concentric Diffusers, curbs, mixing boxes, supports, etc.**



**Mortex - Hydronic Coils & Custom Commercial Coils**



**Make Up Airst, Direct/Indirect Fired**



**Reznor Special Order Parts**



**Commercial ERV's, Economizers, & Concentric Diffusers**

*Curb Adaptors* – Made to fit exactly over existing curb.

*Custom Aluminum Commercial Registers and Diffusers* – White or Brushed Aluminum – Multi-shutter or Opposed Blade Dampers

*Custom made Galvanized Fittings and Boots* – Plenums, Return Air Drops, Insulated and Non- Insulated Duct etc.

*ERV's & HRV's* - Available from GeneralAire, Honeywell, Lifebreath, & Broan

*Spiral Galvanized Duct and Fittings* - ordered to the Job Specifications.

*Custom made Filters - Made to Size - 1", 2" or 4" - several different merv ratings available*

*Custom made Air Conditioner Covers for winter storage*

**Registers, Grilles, Diffusers & Accessories**

**Registers**

**28 Series Floor Perimeter Registers**

- All steel construction
- Opposed blade damper
- Heavy gauge, stamped, rolled face
- 1-Piece wrap-around collar for reinforced strength



Prod ID #	CSI #	Size	Color	Price
61826	28B0210	2-1/4" x 10	Brown	20.47
61828	28B0212	2-1/4" x 12	Brown	18.08
61829	28B0214	2-1/4" x 14	Brown	22.03
61830	28B0408	4" x 8"	Brown	20.54
61831	28B0410	4" x 10"	Brown	10.63
61832	28B0412	4" x 12"	Brown	15.22
61833	28B0414	4" x 14"	Brown	28.07
61834	28B0610	6" x 10"	Brown	28.09
61835	28B0612	6" x 12"	Brown	30.13
61836	28W0210	2-1/4" x 10	White	21.53
61837	28W0212	2-1/4" x 12	White	18.08
61838	28W0410	4" x 10"	White	10.63
61839	28W0412	4" x 12"	White	15.22

**32 Series Sidewall/Ceiling 2-Way Deflection Registers**

- All steel construction
- 1/3" Spaced fins
- Lanced face
- Multi-shutter damper

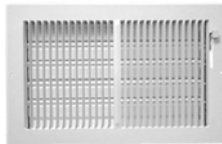

Prod ID #	CSI #	Size	Color	Price
39985	32W0804	8" x 4"	White	36.40
61744	32W0806	8" x 6"	White	36.94
61745	32W1004	10" x 4"	White	17.92
61746	32W1006	10" x 6"	White	19.79
61747	32W1008	10" x 8"	White	49.14
61748	32W1204	12" x 4"	White	20.97
61749	32W1206	12" x 6"	White	21.81
61750	32W1208	12" x 8"	White	35.88
61751	32W1404	14" x 4"	White	36.31
61752	32W1406	14" x 6"	White	20.33
61753	32W1408	14" x 8"	White	37.13

**Toe Hot Registers**

Prod ID #	CSI #	Size	Color	Price
35921	51W1003	10"x3"	White	33.59
35922	T32W1203	12"x3"	White	14.99

**We appreciate your business!**

**Grilles**

**F25 Series Bar-Faced Floor Grilles**

- All steel construction
- Bar-faced
- Extremely rigid firm, smooth surface



Prod ID #	CSI #	Size	Color	Price
61840	F25B0610	6" x 10"	Brown	54.77
61841	F25B0612	6" x 12"	Brown	58.32
61842	F25B0614	6" x 14"	Brown	49.07
61843	F25B0624	6" x 24"	Brown	87.75
61844	F25B0630	6" x 30"	Brown	96.99
61845	F25B0814	8" x 14"	Brown	58.40
61846	F25B1214	12" x 14"	Brown	84.47

**G35 Series Return Air Grilles**

- All steel construction
- 1/3" Spaced fins
- Lanced face
- Ceiling and sidewall applications
- One piece standard face
- Heads of mounting screws are painted



Prod ID #	CSI #	Size	Color	Price
61754	G35W0806	8" x 6"	White	21.31
61755	G35W0808	8" x 8"	White	22.21
61756	G35W1004	10" x 4"	White	20.49
61757	G35W1006	10" x 6"	White	15.41
61758	G35W1008	10" x 8"	White	22.04
61759	G35W1010	10" x 10"	White	20.17
61760	G35W1204	12" x 4"	White	25.29
61761	G35W1206	12" x 6"	White	21.38
61762	G35W1208	12" x 8"	White	25.36
61763	G35W1210	12" x 10"	White	26.02
61764	G35W1212	12" x 12"	White	25.41
61765	G35W1404	14" x 4"	White	24.85
2624	G35W1406	14" x 6"	White	11.32
61766	G35W1408	14" x 8"	White	22.47
61767	G35W1410	14" x 10"	White	26.89
61768	G35W1412	14" x 12"	White	26.51
61769	G35W1414	14" x 14"	White	27.65
61770	G35W1606	16" x 6"	White	22.40
61771	G35W1608	16" x 8"	White	25.34
61772	G35W1616	16" x 16"	White	30.55
61773	G35W1806	18" x 6"	White	28.54
61774	G35W1812	18" x 12"	White	32.05
61775	G35W1818	18" x 18"	White	57.57
61776	G35W2006	20" x 6"	White	30.12
61777	G35W2008	20" x 8"	White	30.82

Registers & Grilles

Registers, Grilles, Diffusers & Accessories

**G35 Series Return Air Grilles (Continued)**

Prod ID #	CSI #	Size	Color	Price
61778	G35W2010	20" x 10"	White	31.31
61779	G35W2012	20" x 12"	White	35.55
61780	G35W2014	20" x 14"	White	43.55
61781	G35W2016	20" x 16"	White	48.17
61782	G35W2020	20" x 20"	White	42.46
2625	G35W2406	24" x 6"	White	19.29
61783	G35W2408	24" x 8"	White	27.86
61784	G35W2410	24" x 10"	White	42.18
61785	G35W2412	24" x 12"	White	65.61
61786	G35W2414	24" x 14"	White	57.27
61787	G35W2416	24" x 16"	White	65.11
61788	G35W2420	24" x 20"	White	74.40
61789	G35W2424	24" x 24"	White	93.17
61790	G35W3004	30" x 4"	White	28.33
61791	G35W3006	30" x 6"	White	18.61
61792	G35W3008	30" x 8"	White	27.86
61793	G35W3010	30" x 10"	White	44.16
61794	G35W3012	30" x 12"	White	51.72
61795	G35W3014	30" x 14"	White	66.40
61796	G35W3016	30" x 16"	White	74.63
61797	G35W3024	30" x 24"	White	108.53

**G35 Series Toe Grilles**

Prod ID #	CSI #	Size	Color	Price
61888	G35B1003	10" x 3"	Brown	9.74
61886	G35W1003	10" x 3"	White	9.74
61889	G35B1203	12" x 3"	Brown	10.61
61887	G35W1203	12" x 3"	White	10.61
2631	G35W1403	14" x 3"	White	26.41

**BEG31 Series Baseboard Grilles**

- Steel construction
- 7/8" Top, 3-1/4" extension bottom
- 1/3" Spaced fins
- Lanced face



Prod ID #	CSI #	Size	Color	Price
40175	BEG31W1406	14" x 6"	White	41.71
40176	BEG31W1408	14" x 8"	White	45.39
40178	BEG31W3006	30" x 6"	White	58.47

**BG31 Series Baseboard Grilles**

- Steel construction
- 7/8" Extension
- 1/3" Spaced fins
- Lanced face



Prod ID #	CSI #	Size	Color	Price
61848	BG31W1006	10" x 6"	White	28.13
61849	BG31W1206	12" x 6"	White	31.53
61850	BG31W1406	14" x 6"	White	27.69
61851	BG31W1408	14" x 8"	White	28.41
61852	BG31W2406	24" x 6"	White	37.14
61853	BG31W2408	24" x 8"	White	51.68
61854	BG31W3006	30" x 6"	White	44.28
61855	BG31W3008	30" x 8"	White	51.63

**FG2 Series Filter Grilles**

- All steel construction
- 1/2" Spaced fins
- Lanced face
- Uses standard 1" filter (not included)
- Removable hinged face for easy installation and cleaning
- With filter retainer
- Thumb latch for easy opening



Prod ID #	CSI #	Size	Color	Price
61808	FG2W1420	14" x 20"	White	71.33
61809	FG2W1424	14" x 24"	White	105.85
61810	FG2W1425	14" x 25"	White	83.35
61811	FG2W1620	16" x 20"	White	103.34
61812	FG2W1625	16" x 25"	White	123.79
61813	FG2W2014	20" x 14"	White	108.87
61814	FG2W2016	20" x 16"	White	89.53
61815	FG2W2020	20" x 20"	White	76.85
61817	FG2W2025	20" x 25"	White	105.69
61819	FG2W2516	25" x 16"	White	117.46

**T Series T-Bar Filter Grilles**

- Louvered face 1/2" spaced fins
- White Finish Steel construction
- Fits 24" x 24" "T" bar
- Flush removable hinged face
- Hidden latch & hinge



Prod ID #	CSI #	Description	Price
61821	TL2106	2' x 2' Louver, 1/2 R6 Plen	127.55

Registers & Grilles

You are only a click away from seeing pricing and availability at [www.CalverleySupply.com](http://www.CalverleySupply.com)



**Registers, Grilles, Diffusers & Accessories**

**Diffusers**

**AE4 Series Square Ceiling  
4-Way Diffusers**

- Extruded aluminum
- Multi-shutter damper



Prod ID #	CSI #	Size	Color	Price
61876	AE4W06MS	6" x 6"	White	73.86
61877	AE4W08MS	8" x 8"	White	85.31
61878	AE4W10MS	10" x 10"	White	110.35
61879	AE4W12MS	12" x 12"	White	137.13
61880	AE4W14MS	14" x 14"	White	175.50

**150/180 Series Sunburst Baseboard Diffusers**

- Steel construction, sunburst design
- 1/3" Spaced fins
- Lanced face



Prod ID #	CSI #	Size	Color	Price
61859	150W	15"	White	34.72
61860	180W	18"	White	41.94

**B32 Series Baseboard Diffusers**

- Steel construction
- 7/8" Extension
- 1/3" Spaced fins
- Lanced face
- Multi-shutter damper

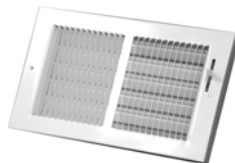

Prod ID #	CSI #	Size	Color	Price
61856	B32W1006	10" x 6"	White	32.16
61857	B32W1206	12" x 6"	White	40.83
61858	B32W1406	14" x 6"	White	41.91

**P20 Round Ceiling Diffusers**

- Step down design
- 360° Throw pattern
- Use with 6" - 8" flex duct
- Diffuser, damper and outlet assembly all in one



Prod ID #	CSI #	Size	Color	Price
39552	P20W08	6"-8"	White	73.95

**16 Series Round Ceiling Diffusers**

- Steel construction, Step down design
- 360° Deflection



Prod ID #	CSI #	Size	Color	Price
61861	1606	6"	White	27.00
61862	1608	8"	White	29.54

**16 Series Round Ceiling Diffusers (Continued)**

Prod ID #	CSI #	Size	Color	Price
61863	1610	10"	White	37.97
61864	1612	12"	White	52.23
61865	1614	14"	White	65.69

**Dampers**

**12B Series Butterfly Dampers  
with Duct Ring**

- Steel construction



Prod ID #	CSI #	Size	Color	Price
61866	12B06D	6"	Galv	28.47
61867	12B08D	8"	Galv	29.07
61868	12B10D	10"	Galv	43.98
61869	12B12D	12"	Galv	59.53
61870	12B14D	14"	Galv	71.09

**11 Series Duct Rings**

- For #16 damper
- Steel construction
- Allows rapid installation when damper not desired



Prod ID #	CSI #	Size	Color	Price
61871	1106DR	6"	Galv	16.22
61872	1108DR	8"	Galv	18.91
61873	1110DR	10"	Galv	23.90
61874	1112DR	12"	Galv	30.77
61875	1114DR	14"	Galv	34.84

**Imports**

**New Construction Import Registers**

- Steel construction

Prod ID #	CSI #	Size	Color	Price
70656	IMPX28B0410	4x10 Floor Hot	Brwn	9.89
70658	IMPX28W0410	4x10 Floor Hot	Wht	9.89
70652	IMPX32W1004	10X4 Wall Hot	Wht	15.50
70653	IMPX32W1006	10x6 Wall Hot	Wht	16.00

*We Feature The Brand Name Products  
You Are Looking For*

Registers & Grilles

## Layin Diffusers and Dampers

### Layin Diffusers and Dampers

#### Ceiling Layin Diffuser

- Steel construction
- 3-tier diffusion, 360° pattern
- Fixed collar and no collar models
- Non-Insulated
- White finish
- Made in the U.S.A.
- Packed 1 per carton, 36 per pallet



Prod ID#	CSI#	Size	Neck	Price
72280	BHV06NI	24" x 24"	6" Rnd	72.47
72281	BHV08NI	24" x 24"	8" Rnd	72.47
72282	BHV10NI	24" x 24"	10" Rnd	72.47
72283	BHV12NI	24" x 24"	12" Rnd	72.47
72284	BHV14NI	24" x 24"	14" Rnd	72.47

### Dampers

#### Radial Opposed Blade Dampers R-Series

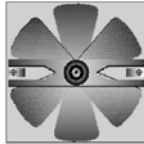

Prod ID#	CSI#	Size	Price
72285	3906	6" Rnd	28.43
72286	3908	8" Rnd	30.05
72287	3910	10" Rnd	30.32
72288	3912	12" Rnd	32.29
72289	3914	14" Rnd	43.30

### Diffusers

#### Plenum Backed Supply Diffuser Perforated For T-Bar Lay-In

- One-inch thick R6 molded fiberglass plenum back
- Steel with white finish



Prod ID#	CSI#	Size	Price
19538	CS106P	24" x 24"	66.35

#### Egg Crate Filter Grille

- Egg crate return
- T-Bar lay-in
- White

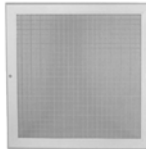

Prod ID#	CSI#	Size	Price
48061	ECFGW2222TB	24"x24" Egg Crate Fltr Grl	197.51

### Aluminum Egg Crate T-Bar Grille

- 1/2"x1/2"x1/2" Core Design
- T-Bar lay-in
- White

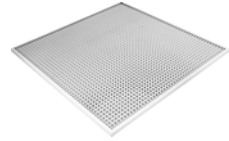

Prod ID#	CSI#	Size	Price
74106	ECGW1224TB	12"x24" Egg Crate T-Bar	53.63
74107	ECGW2424TB	24"x24" Egg Crate T-Bar	72.10

### Paramount H™ Installation Frames

- Adjustable overhead register installation frame
- Sliding mechanism adjusts from 8" to 14"
- Covers joist spacing from 16" to 24" on center
- 1/2" inside perimeter edge for smooth, accurate drywall cut
- Heat, cold and UV resistant, high impact material



Prod ID#	CSI#	Description	Price
46188	H4	4" Paramount H boot frame	14.12
46187	H6	6" Paramount H boot frame	14.12



### Egg Crate Louvers

- White polystyrene
- Nominal 2' x 4' panel size
- 1/2" Open cell grid

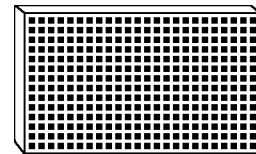

Prod ID#	CSI#	Size	Price
3324	2.4WEC (650-200)	2' x 4' x 3/8" White Egg Crate	26.72

Think of us for all  
your product needs!

**Registers, Grilles, Diffusers & Accessories**

**Floor Diffusers**

**RPD Series**

- Deflector blades set parallel to short dimension on 1/2" centers
- Extruded aluminum construction
- Clear Anodized finish
- Multi-shutter damper

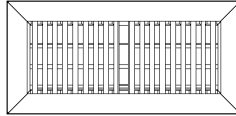

Prod ID#	CSI#	Size	Price
1571	RPD4.10	4" x 10"	51.47
1572	RPD4.12	4" x 12"	55.76
1573	RPD4.14	4" x 14"	71.09

**Sidewall Supply Air Registers**

**R1VM Series**

- 1 set of individually adjustable blades in vertical position on 3/4" centers
- Multi-shutter damper
- Extruded aluminum construction
- Clear anodized finish

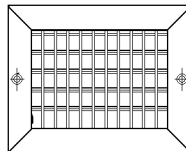

Prod ID#	CSI#	Size	Price
1513	R1VM8.8	8" x 8"	51.43
1514	R1VM10.4	10" x 4"	46.89
1515	R1VM10.6	10" x 6"	48.61
1516	R1VM10.8	10" x 8"	55.97
1517	R1VM10.10	10" x 10"	60.51
1518	R1VM12.4	12" x 4"	51.43
1519	R1VM12.6	12" x 6"	52.90
1520	R1VM12.8	12" x 8"	62.02
1521	R1VM12.10	12" x 10"	66.56
1522	R1VM12.12	12" x 12"	72.61
1524	R1VM14.6	14" x 6"	62.02
1525	R1VM14.8	14" x 8"	66.56
1527	R1VM14.12	14" x 12"	78.66
1528	R1VM14.14	14" x 14"	89.25
1529	R1VM16.6	16" x 6"	66.56
1530	R1VM16.8	16" x 8"	72.61
1531	R1VM18.6	18" x 6"	71.09
1533	R1VM20.6	20" x 6"	75.63
1534	R1VM20.8	20" x 8"	81.68
1535	R1VM20.10	20" x 10"	92.27
1536	R1VM20.12	20" x 12"	101.35
1537	R1VM24.6	24" x 6"	87.73
1538	R1VM24.8	24" x 8"	96.81
1539	R1VM24.10	24" x 10"	118.17
1540	R1VM24.12	24" x 12"	116.47
1542	R1VM30.6	30" x 6"	111.93
1543	R1VM30.8	30" x 8"	124.04

**Return Air Grilles**

**GFX Series**

- Extruded aluminum construction
- 40° deflection on face bars on 3/4" centers
- 1-1/4" nominal face margin
- Clear anodized finish

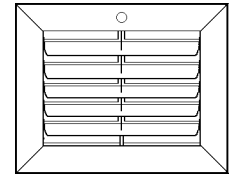

Prod ID#	CSI#	Size	Price
1546	GFX10.6	10" x 6"	40.84
1547	GFX10.8	10" x 8"	43.87
1548	GFX10.10	10" x 10"	46.89
1549	GFX12.6	12" x 6"	43.87
1551	GFX12.12	12" x 12"	57.48
1552	GFX14.6	14" x 6"	47.18
1554	GFX14.14	14" x 14"	71.09
1555	GFX16.8	16" x 8"	57.48
1557	GFX16.16	16" x 16"	86.22
1559	GFX18.18	18" x 18"	108.91
1560	GFX20.20	20" x 20"	131.60
1561	GFX24.6	24" x 6"	65.76
1562	GFX24.8	24" x 8"	77.14
1563	GFX24.10	24" x 10"	83.19
1564	GFX24.12	24" x 12"	90.76
1565	GFX30.6	30" x 6"	82.92
1566	GFX30.8	30" x 8"	98.32
1568	GFX30.12	30" x 12"	119.50

**EASYAIR**

**Ceiling & Wall Diffusers**

- Non-sweating
- Fully adjustable
- Ideal for heating & A/C ventilation duct systems
- Attractive white finish
- Lifetime warranty



Prod ID#	CSI#	Size	Price
48457	99-EAG6	6" Round	22.26
75449	99-EAG8	8" Round	35.05

**Special Order**



**Fire Dampers, Radiation Dampers**



**FanTech Residential in-line fans, ceiling, duct mounted, roof mounted etc.**

HEAT CONTROLLER, INC.  
Heatcontroller.com

**Packaged Terminal Units(PTAC), Portable Coolers, Packaged Wall Mounted Units, Geothermal**



**Heat Transfer Products Boilers & Parts**



**Linesets Inc - Made to Order Any Length**



**Lloyd Smoke & Fire Dampers**



**Concentric Diffusers, curbs, mixing boxes, supports, etc.**



**Mortex - Hydronic Coils & Custom Commercial Coils**



**Make Up Airs, Direct/Indirect Fired**



**Reznor Special Order Parts**



**Commercial ERV's, Economizers, & Concentric Diffusers**

*Curb Adaptors – Made to fit exactly over existing curb.*

*Custom Aluminum Commercial Registers and Diffusers – White or Brushed Aluminum – Multi-shutter or Opposed Blade Dampers*

*Custom made Galvanized Fittings and Boots – Plenums, Return Air Drops, Insulated and Non- Insulated Duct etc.*

*ERV's & HRV's - Available from GeneralAire, Honeywell, Lifebreath, & Broan*

*Spiral Galvanized Duct and Fittings - ordered to the Job Specifications.*

*Custom made Filters - Made to Size - 1", 2" or 4" - several different merv ratings available*

*Custom made Air Conditioner Covers for winter storage*

**Insulation**

**Quiet R Duct Board  
Class I Rigidaire Duct**

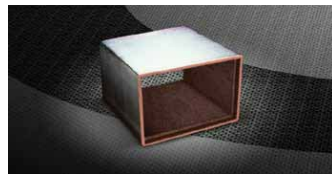

- Quiet system
- Fire-Resistant
- Reduces condensation
- GREENGUARD Children & Schools Certified
- GREENGUARD Indoor Air Quality Certified
- Operation Temps 40-250degF
- 6 per box

Prod ID#	CSI#	Description	Price
2769	1.48IN.120INDBB OXED	1" x 48" x 120" Quiet R R-4.3 SHIPLAP	98.71

**Soft R Duct Wrap**



- Used to insulate rectangular and round heating ventilating and air conditioning ductwork
- GREENGUARD Certified
- Type 75

Prod ID#	CSI#	Description	Price
2767	112.48IN.100FSK	1-1/2" x 48" x 100', R-4.2	349.15
66851	2.2.48IN.75FSKW	2.2" x 48" x 75', R-6.0	316.87
48923	3.48IN.50FSKW	3" x 48" x 50', R-8.3	300.14

**Quiet R- Rotary Duct Liner**



- Composed of Short glass fibers
- Quiet operation
- Thermal protection
- Moisture protection
- Low air resistance
- Durable & fire resistant
- Antimicrobial
- GREENGUARD Certified
- Easy to clean

Prod ID#	CSI#	Description	Price
2761	12.47IN.100DL	1/2" x 47" x 100', R-2.2	515.27
2764	1.47IN.100DL	1" x 47" x 100', R-4.2	561.40



**Insulated Flexible Duct**

**#070 Series R-Value 4.2**



- UL 181 listed class I air duct
- Gray polyethylene outer vapor barrier
- Double Ply

Prod ID#	CSI#	Size	R-Value	Price
47666	4.25IF	4" x 25'	4.2	42.22
47668	5.25IF	5" x 25'	4.2	61.16
47591	6.25IF	6" x 25'	4.2	55.19
47669	7.25IF	7" x 25'	4.2	74.99
47604	8.25IF	8" x 25'	4.2	65.36
47605	10IN.25IF	10" x 25'	4.2	82.11
47979	12IN.25IF	12" x 25'	4.2	105.12
47982	14IN.25IF	14" x 25'	4.2	127.43
47984	16IN.25IF	16" x 25'	4.2	148.27
48363	18IN.25IF	18" x 25'	4.2	163.09
48364	20IN.25IF	20" x 25'	4.2	198.49

**#076 Series R-Value 6.0**



- UL 181 listed class I air duct
- Gray polyethylene outer vapor barrier
- Double Ply

Prod ID#	CSI#	Size	R-Value	Price
47910	4.25R6	4" x 25'	6.0	49.16
47609	6.25R6	6" x 25'	6.0	64.62
47911	7.25R6	7" x 25'	6.0	70.49
47610	8.25R6	8" x 25'	6.0	76.69
47611	10IN.25R6	10" x 25'	6.0	96.33
48365	12IN.25R6	12" x 25'	6.0	119.21
48366	14IN.25R6	14" x 25'	6.0	153.42
48367	16IN.25R6	16" x 25'	6.0	181.56
48368	18IN.25R6	18" x 25'	6.0	207.55
51196	20IN.25R6	20" x 25'	6.0	253.17

**#078 Series R-Value 8.0**



- UL 181 listed class I air duct
- Gray polyethylene outer vapor barrier
- Double Ply

Prod ID#	CSI#	Size	R-Value	Price
65001	4.25R8	4" x 25'	8.0	73.61

Insulation

Insulation

Insulation

#078 Series R-Value 8.0 (Continued)

Prod ID#	CSI#	Size	R-Value	Price
49181	6.25R8	6" x 25'	8.0	83.82
65002	7.25R8	7" x 25'	8.0	93.51
49182	8.25R8	8" x 25'	8.0	102.60
49183	10IN.25R8	10" x 25'	8.0	122.03
65119	12IN.25R8	12" x 25'	8.0	151.09
65120	14IN.25R8	14" x 25'	8.0	190.89
65121	16IN.25R8	16" x 25'	8.0	217.62
65122	18IN.25R8	18" x 25'	8.0	256.42
65123	20IN.25R8	20" x 25'	8.0	311.22

Non-Insulated Flexible Duct

#050 Series

- Corrosion resistant
- Spring steel wire helix laminated with clear and metallized polyester film



Prod ID#	CSI#	Size	Price
48156	4.25UF	4" x 25'	41.37
48157	5.25UF	5" x 25'	49.84
48158	6.25UF	6" x 25'	56.09
48159	7.25UF	7" x 25'	63.75
48161	8.25UF	8" x 25'	73.38
48155	10IN.25UF	10" x 25'	92.78
48162	12IN.25UF	12" x 25'	113.58
48163	14IN.25UF	14" x 25'	137.94
48804	16IN.25UF	16" x 25'	165.37
48805	18IN.25UF	18" x 25'	208.38
48806	20IN.25UF	20" x 25'	255.14

Pipe Insulation

#011 Insulated Sleeve R-Value 6.0

Prod ID#	CSI#	Size	R-Value	Price
48815	4.5PSR6	4" x 5'	6.0	17.12
48816	6.5PSR6	6" x 5'	6.0	19.93
48817	7.5PSR6	7" x 5'	6.0	21.60
48818	8.5PSR6	8" x 5'	6.0	23.53
48819	10IN.5PSR6	10" x 5'	6.0	29.51
48820	12IN.5PSR6	12" x 5'	6.0	36.69
48821	14IN.5PSR6	14" x 5'	6.0	46.32

Insulated Sleeve R-Value 8.0

Prod ID#	CSI#	Size	R-Value	Price
65481	4.5VSR8	4" x 5'	8.0	28.41
51610	6.5VSR8	6" x 5'	8.0	22.13
65664	7.5VSR8	7" x 5'	8.0	24.79
51611	8.5VSR8	8" x 5'	8.0	27.10
54854	9.5VSR8	9" x 5'	8.0	32.27
65324	10.5VSR8	10" x 5'	8.0	34.93
65483	12.5VSR8	12" x 5'	8.0	43.18
76337	14.5VSR8	14" x 5'	8.0	49.01

\*\*\*MK+E & SLP Thermaflex Available for Special Order\*\*\*



Thermo Reflect Duct Insulation

- Two layers of ultra strong polyethylene bubbles bonded to and sandwiched between two aluminum foil sheets
- Provides reflective insulation
- Unaffected by moisture and humidity
- R-6 with air space
- Square edge
- **Must get local building inspector approval prior to using this product**



Prod ID#	CSI#	Description	Price
47808	T12222-16-125	16" x 125' Foil Insulation	241.39
47809	T12290-48-125	48" x 125' Foil Insulation	459.03

***We maintain well-stocked and conveniently located warehouses. Please call us, or stop in to see us in the branch location nearest you.***

Shaded items are Non-Stock special order and subject to freight.

**Sterling Hts, MI - Livonia, MI - Lansing, MI - Grand Rapids, MI - Waterford, MI - Almont, MI - Saginaw, MI**

**Tools**

**Aviation Snips**

**Compound Leverage**

- Hot drop-forged molybdenum alloy steel & austemper heat-treated blades
- 40 serrated blades per inch
- Meets all US government & ANSI/ASME cutting test standards for length & pressure of cut
- Heavy duty double-overwind spring guaranteed for life
- Thumb activated safety latch
- Made in USA
- Kush'n Power Grips

**Upright**

- 24ga cold-rolled sheet metal and 28ga stainless steel sheet metal capacity



P6900L



P6900R

Prod ID#	CSI#	Description	Price
51230	MWT-P6900L	Left-Cut Snip	50.28
51231	MWT-P6900R	Right-Cut Snip	50.28

**Regular w/Grips**

- 9-3/4" Nom length
- Cutting capacity: 18ga CR, 22ga SS+
- Kush'n Power Grips



Prod ID#	CSI#	Type	Length Of Cut	Price
51355	MWT-P6716S	Straight	1-1/2"	35.03
51375	MWT-6716-L	Left	1-3/8"	35.00
51374	MWT-6716-R	Right	1-3/8"	35.00

**Offset**

- Flow material away from blades
- Makes long cuts easier
- 9-3/4" Nom length
- Cut Length: 1-1/4"
- Cutting capacity: 18ga CR, 22ga SS
- Kush'n Power Grip



Prod ID#	CSI#	Type	Length Of Cut	Price
51377	MWT-6510-L	Left	1-1/4"	45.14
51376	MWT-6510-R	Right	1-1/4"	45.14

**Bulldog/Notch Cut**

- Cuts thick materials; through seams & multiple layers of material
- 9" Nom cut length
- Cutting capacity: 16ga CR, 18ga SS
- Kush'n Power Grip



Prod ID#	CSI#	Type	Length Of Cut	Price
51229	MWT-6716-B	Notching	7/8"	35.61

**Tinner Snips**

- Handles cast of magnesium for maximum strength and minimum weight
- High carbon steel replacement blades with hollow ground cutting edge
- 3-1/2" cut length
- 6° angled cutting edge for cutting circles & tight curves



Prod ID#	CSI#	Description	Price
51567	MWM1200	13" Comb Pattern	69.48

**HVAC/R Tools**

**5-Blade Crimper**

- Crimps Duct Ends to form tight fitting Joints.
- Kush'n power grips
- Made in the USA



Prod ID#	CSI#	Description	Price
78030	MWT-C5	5-Blade Crimper	58.17

**Duct Slitter**

- Used to scribe a line or pierce & enlarge hole in sheet metal duct



Prod ID#	CSI#	Description	Price
51444	MWT-X1	Duct Slitter	37.10

**Order on-line when it's convenient  
for you-[www.CalverleySupply.com](http://www.CalverleySupply.com)**

Tools

Tools

TOOLS

**Snips for Metal & Vinyl**

**Max2000™ Offset Aviation Snips**

- Cuts straight line & 5" diameter circles

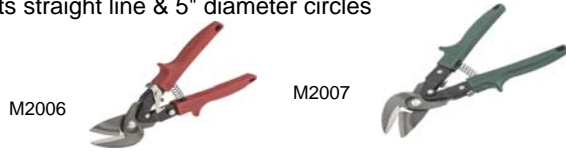

Prod ID#	CSI#	Description	Price
32090	M2006 (52621)	Cuts Left	72.81
32091	M2007 (52622)	Cuts Right	72.81

**Andy™ Aluminum Handled Snip**

- Suitable f/mild curve cuts, straight shearing, or cutting multiple layers sheet metal
- Ground blade edge
- Larger handle loops
- Extended blade tips
- 3" Cutting edge



Prod ID#	CSI#	Description	Price
56	M12N (52888)	12" Length	85.10

**Andy™ Aluminum Snips**

- Suitable f/straight shearing & left or right circular cuts down to 6" dia
- Beveled blade edge
- Lightweight aluminum handle
- Larger handle loops
- Extended blade tips
- 3-1/4" cutting length



Prod ID#	CSI#	Description	Price
4730	MC14N (52891)	14" Comb Andy Snips	96.92

**Replacement Blade Set & Rivets**



Prod ID#	CSI#	Description	Price
74840	M14NRB	Blade Set & Rivets-M14N	46.70
75547	MC14NRB	Blade Set & Rivets-MC14N	58.32

**Aviation Mini Snip**

- For tight/Akward spaces
- 3/4" legnth of cut
- Forged steel jaws



Prod ID#	CSI#	Description	Price
74220	AVM7	Right Cut AV Mini Split	33.14
74219	AVM6	Left Cut AV Mini Split	33.14

**Metal Duct Tools**

**Snap Lock Punches for Metal Duct**

- Punch impression spaced 3/8" from edge of metal
- Heavy forged cutting jaw
- Nickel plate & black oxide finish
- Ergonomic redline handles



Prod ID#	CSI#	Length	Throat Depth	Price
84	SL1R (53451)	8"	3/8"	139.03

**Hand Notchers**

- Hook design of cutting jaw facilitates notching corners or take-off tabs without slipping



Prod ID#	CSI#	Throat Depth	Cutting Angle	Price
65497	N1R (53449)	13/16"	30° Redline	111.68

**Crimping Tools**

**TurboCrimpter IMPACT**

- Impact Drill Needed
- No set-up or adjustment required
- 5 times faster than manual crimping
- Crimps 30 to 24 gauge round galvanized



Prod ID#	CSI#	Description	Price
74520	C5A2 (54709)	TurboCrimper IMPACT	307.22
74522	C5A2RD EV	TurboCrimp Repl Drive Shaft	52.24

**5-Blade Pipe Crimper**

- Longer shallower crimps replicate to factory precision indentations



Prod ID#	CSI#	Length	Throat Depth	Price
65501	C5R (53439)	9-5/8"	1-5/8" Redline	70.81

**Awls**

**Scratch Awls**

- High carbon alloy tool steel blade polished to resist rust
- May be re-sharpened many times
- Easy-to-spot orange handles

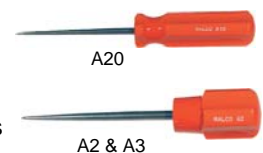

Prod ID#	CSI#	Blade Dia	Nom Length	Price
7	AO (50001)	1/8"	6-1/4"	12.59
9	A2 (50003)	1/4"	6-1/4"	17.89
19769	A3 (50004)	3/8"	7-1/2"	27.87
12	A20 (50006)	1/4"	7-3/4"	20.50



**Tools**

**Scribers**

**Sheet Metal Scribers**

**Pocket Size**

- Five teeth produce 10 scribing depths
- Compact scribe stores in pocket, pouch or tool box
- Use hang hole or magnet to keep handy on the job



Prod ID#	CSI#	Min/Max Adjustments	Price
38165	A40 (52608)	1/8" Thru 1" Depths	12.01

**Dividers**

- Accurate & fast adjusting
- Scratch awl points are easily re-sharpened or replaced
- Nickel plated steel body



Prod ID#	CSI#	Description	Price
126	18 (50845)	32" Max Circle dia	38.94
136	24 (50916)	42" Max Circle dia	43.18

**Seamers**

**Hand Seamers**

- Bends & flattens metal easily
- 1/4" - 1-1/4" Diameter
- Black vinyl cushion grips with handle stops
- All steel parts & hardware are nickel plated
- Makes permanent, tight fitting seams



Prod ID#	CSI#	Jaw Capacity	Length	Price
65500	S2R (53442)	3-1/4"W	8" Redline	103.37

**Offset Hand Seamers**

- Bends & flattens metal overhead or in confined areas



Prod ID#	CSI#	Jaw Capacity	Length	Price
65499	S3R (53443)	3-1/4"W	8" Redline	125.36

**6" Hand Seamers**

**Use for all the Metal Trades**

- Wider jaws minimizes buckling & bowing



Prod ID#	CSI#	Jaw Capacity	Length	Price
65498	S6R (53445)	6"W	8" Redline	161.27

**Folding Tools**

- Folding seams are formed from two steel halves, permanently joined together
- 3/8" & 1" Depths: 12F, 18F, 24F
- 3/8" & 1/2" Depths: 8



Prod ID#	CSI#	Length	Capacity	Price
120	12F(52246)	12"	24Ga	33.38
16943	18F (52247)	18"	24Ga	52.85
34940	24F (52615)	24"	24Ga	70.00

**Metal Duct Tools & Accessories**

**Duct Stretcher**

- Wheels can be changed to other side of tool for applications where side of duct is close to wall or obstruction
- Length: 16"



Prod ID#	CSI#	Description	Price
26	DS1 (50122)	16"	65.83
27	DS2 (50124)	16" w/Offset Handle	69.82

**Duct Stretcher Replacement Parts**

Prod ID#	CSI#	Description	Price
54197	DS1C (50123)	Wheels for DS1/DS2	22.90

**Turboshear™**

- Attaches to the chuck of a 1200 RPM, 12 volt cordless or an A/C cordless drill
- Makes fast cuts in sheet metal
- Capable of making precise 6" x 6" square hole cuts
- 20 Gauge capacity in Galv Steel
- Requires 2 hands to operate
- Material must be pre-set or held by an assistant
- Shear cuts to the left



Prod ID#	CSI#	Description	Price
43995	TS1 (53020)	Sheet Metal Cutter	121.91

**Hole Cutters**

- Cuts holes in up to 20ga sheet metal
- Use with any standard 1/4" electric drill
- Cast aluminum body
- All wearing parts made of special heat-treated steel



Prod ID#	CSI#	Hole Diameter	Price
40	HC1 (50406)	2" - 12"	150.85
19568	HC2 (52477)	2" - 20"	192.06

TOOLS

**Tools**

**Angle Drive Accessory**

- Fits 1/4", 3/8" electric drills
- Comes with own chuck
- Works well with HC1 & HC2 hole cutters



Prod ID#	CSI#	Description	Price
24373	HCAD (52597)	Angle Drive Accessory	90.99

**HC Replacement Parts**

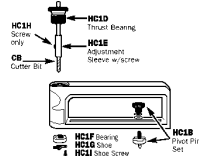

Prod ID#	CSI#	Description	Price
21	CB (50072)	Malco Bit for HC-1 & HC-2	28.94
41	HC1B (50407)	Pivot Pinset for HC-1	23.94
42	HC1E (50408)	Adjustable Sleeve f/HC-1	22.21

**Pipe & Duct Holders**

- Like an extra pair of hands
- Two clamps & 4' of 125 lb tensile strength linked chain
- Clamp handles are 8" long
- Both clamps & chain are nickel plated steel



Prod ID#	CSI#	Description	Price
129	2DH (50889)	1 Pr of Clamps & Chain	82.37

**Fiberglass Flex Duct Tools**

**Flex Duct Cutter & Shear**

- Double edged knife blade
- Thumb operated latch
- Easily resharpenable
- Handles feature non-slip vinyl grips
- Length: 12-1/4"



Prod ID#	CSI#	Description	Price
36141	FDC2 (52793)	Flex Duct Shear	95.43

**Tie Tools**

- Action tie tools feature long wearing, serviceable parts
- Comfortable handles reduce the pinch point area
- Works on all ties including thin designs



Prod ID#	CSI#	Description	Price
4122	TY4G (52143)	Manual Cut-Off Grippped	83.18
57628	TY6 (52144)	Tie Tool-Adj	125.22

**Measuring Tapes**

**Power Return Tapes**

- Ultraviolet curing extends blade life
- Impact resistant cases



**1" with Reinforced End Hook & Truss Marks**

- T425M has magnetic tip

Prod ID#	CSI#	Size	Blade Color	Price
48913	T425M (53071)	1" x 25'	Yellow	41.81

**Levels**

**Top Reading Torpedo Level**

- Three large vials - plumb, level & 45°
- White vial holders & top read feature
- Magnetic base



Prod ID#	CSI#	Length	# of Vials	Price
52	L9M (50442)	9" Magnetic	3	51.10

**Knives & Knife Blades**

**Utility Knife**

**Top Button Action**

- Retractable blade
- Includes 1 double point blade



Prod ID#	CSI#	Description	Price
38552	9PK (52845)	Quick Open	28.15

**Utility Blades**

**Crewline® Utility Knife Blades**



Prod ID#	CSI#	Description	Price
50	UBS5	Utility Blades 5/tube 24pack	8.61

**Cushioned Grip Duct Knife**

- Serrated Edge
- Resharpenable
- Double Edged



Prod ID#	CSI#	Description	Price
61704	DK6S (53117)	Double Edge Duct Knife	38.40

**Tools**

**Vent Saw & Blades**

**Venting Saw**

- Designed for cutting all types of hard and soft wood and plywood
- Webbed mandrel allows for easy plug removal
- Built-in arbor



Prod ID#	CSI#	Description	Price
70128	HSW97 (52263)	6" Vent Saw w/Arbor	278.56
67142	RBW97 (52272)	6" Repl Vent Saw Blade	82.68
69750	HSRD (52293)	Vent Saw Replacement Drill	56.52

**Hammers**

**Setting Hammers**

- Full polished head w/beveled face & pein



Prod ID#	CSI#	Head Size	Handle	Wt (oz)	Price
83	SH3 (50628)	5-1/2"	Leather	18	111.05

**Pliers**

**Electrical Cutter/Stripper/Crimper**

- Color coded up front crimping action
- Up front scissors action strips copper wire clean & cuts easily sizes 10-20 (red)



Prod ID#	CSI#	Crimping	Length	Price
114	WSC8 (50787)	22-10 Gauge	8-1/4"	57.44

**Wrenches**

**Ratchet Wrenches**

- For installing or servicing heating, air conditioning or refrigeration units



Prod ID#	CSI#	Square	Hex	Price
77	RRW4 (50603)	3/16", 1/4"	1/2" & 9/16"	46.05

**Hex Key Wrench Inserts**



Prod ID#	CSI#	Square	Hex	Price
23585	RRW316 (50600)	1/4"	3/16"	21.14
23586	RRW516 (50601)	1/4"	5/16"	21.14

**Hex Keys**

**"T" Handle in Plastic Pouch 3/32" - 1/4"**

- Extra Long
- Hardened Steel



Prod ID#	CSI#	Description	Price
115	WT9SG	8 Keys, 9" Long	77.62

**Nut Drivers**

HHD1

HHD2

**Long Drivers - Magnetic**



Prod ID#	CSI#	Hex	Shaft Length	Grips	Price
43	HHD1 (50409)	1/4"	10-1/8"	Red	30.99
44	HHD2 (50410)	5/16"	10-1/8"	Amber	33.26

**4IN1 Nut Driver**

- 3 Position Combinations
- Quick Release Shafts
- Hardened chrome steel
- Comforatble 3-lobe handle



Prod ID#	CSI#	Description	Price
74521	4IN1 (54449)	4IN1 Nut Driver	32.38

**Magnetic Hex Chuck Drivers**

**1/4" Hex Shank Power Bits**

**Dual Sided Hex Chuck Driver**

- Reversible 1/4" and 5/16"
- Easy to clean the magnetic tip
- Positive engagement of hex head fasteners



Prod ID#	CSI#	Hex Opening	Overall Length	Nose Dia	Price
75847	MSHC	1/4"&5/16"	2"	1/2"	14.95
79048	MSHMLC	1/4"&5/16"	4"	1/2"	32.30
79049	MSHXLC	1/4"&5/16"	6"	1/2"	43.17

**Magnetic Hex Driver**

- 1/4" Shank diameter
- Color coded for easy indentification



Prod ID#	CSI#	Hex Opening	Overall Length	Nose Dia	Price
63	MSH14 (50489)	1/4"	1-3/4"	7/16"	10.79
64	MSH516 (50491)	5/16"	1-3/4"	1/2"	13.10
65	MSH38 (50492)	3/8"	1-3/4"	9/16"	16.65

TOOLS

Tools

Long Style 1/4" Shank diameter



Prod ID#	CSI#	Hex Opening	Overall Length	Nose Dia	Price
66	MSHL14 (50493)	1/4"	2-9/16"	7/16"	16.44
68	MSHL516 (50494)	5/16"	2-9/16"	1/2"	19.05

Extra Long Style 1/4" Shank diameter



Prod ID#	CSI#	Hex Opening	Overall Length	Nose Dia	Price
56464	MSHML14 (50497)	1/4"	4"	7/16"	23.07
70	MSHXL14 (50498)	1/4"	6"	7/16"	28.01
29858	MSHXL516 (52844)	5/16"	6"	1/2"	32.90

Drill Bits

Double Enders



Prod ID#	CSI#	Bit Dia	Length	Price
24	DE30 (50118)	1/8"	2"	7.79

TOOLS



Duro Staplers & Staples

- Used to assemble flexible connector



Prod ID#	CSI#	Description	Price
3479	DS #10065	Duro Rapid 31 Stapler	202.41
3851	DSP1	Staples (5000)	54.93



Circular Saw Blades

Steel Demon™ Metal Cutting Saw Blade with TiCo™ Hi-Density Carbide

- For use cutting ferrous metals
- Triple-chip grind provides longer cutting life
- Perma-SHIELD® non-stick coating
- Pretensioned blades



D0530FM



D0648F



D0748F



D0770F

Part #	Mfg #	Diameter	Teeth	Price
78801	D0530FM	5-3/8"	30	56.59
78802	D0648F	6-1/2"	48	70.47
78803	D0748F	7-1/4"	48	71.08
78804	D0770F	7-1/4"	70	84.85

Framing Circular Saw Blade

- For use cutting wood
- Tracking Point™ tooth design
- Anti-vibration design
- Perma-Shield non-stick coating
- Laser-cut thin kerf provides less resistance and greater cutting efficiency
- Suffix X = bulk



Part #	Mfg #	Diameter	Teeth	Price
78805	D0724X	7-1/4"	24	31.29

Let Us be Your Source of QUALITY PRODUCTS and Top-Grade Merchandise from Leading Manufacturers.

**Diablo Blades, Hole Saws & Tools**

**Reciprocating Saw Blades**

**Steel Demon™ Carbide-Tipped Reciprocating Blade for Thick Metal Cutting**

- High performance carbide improves durability
- Carbide teeth spaced at 8 TPI
- Enhanced carbide tip to blade connection improves impact resistance
- 1" Oversized blade body for straighter cuts with less vibration
- Perma-SHIELD® non-stick coating reduces heat and friction



Part #	Mfg #	Length	Qty	Price
78806	DS0608CF3	6"	3	62.39
78807	DS0908CF3	9"	3	87.83

**Steel Demon™ Bi-Metal Reciprocating Blade for Thin/Medium Metal**

- For metals from 3/32" to 5/16"
- Full contact arched design provides more working teeth for faster cuts in fewer passes
- Dual Tooth design features double-tooth configuration with small gullets for faster material removal and increased durability
- 1" Demolition body for straighter cuts with less vibration



Part #	Mfg #	Length	Qty	Price
78794	DS0614BF5	6"	5	25.61
78798	DS0614BF25	6"	25	121.22
78795	DS0914BF5	9"	5	34.65

**Steel Demon™ Bi-Metal Reciprocating Blade for Thin Metal**

- For metals less than 1/8"
- Perma-shield coating protects blade from heat, gumming and corrosion
- 1" Demolition body
- Ultra-hardened edge provides Rockwell hardness of HRC 62



Part #	Mfg #	Length	Qty	Price
78796	DS0620BF5	6"	5	25.61
78799	DS0620BF25	6"	25	125.07
78797	DS0920BF5	9"	5	39.06

**Steel Demon™ Carbide Reciprocating Blade for Thin Metal**

- For metals less than 3/16"
- Solid carbide creates full barrier to heat resistance for maximum durability
- Carbide strip teeth are milled for smoother quality cuts and spaced at 20 TPI
- Perma-SHIELD® non-stick coating



Part #	Mfg #	Length	Qty	Price
78811	DS0620CF	6"	1	28.89
78812	DS0820CF	8"	1	36.94

**Steel Demon™ Carbide Reciprocating Blade for Medium Metal**

- For metals 1/16" - 1/8"
- High performance carbide blade for extreme impact resistance
- 10 TPI Tooth geometry for clean and smooth finishes
- 1" Oversized blade body



Part #	Mfg #	Length	Qty	Price
78808	DS0610CF3	6"	3	63.48
78809	DS0910CF3	9"	3	85.33
78810	DS1210CF3	12"	3	117.10

**Demo Demon Carbide Reciprocating Blade for General Purpose Cutting**

- Variable tooth design provides faster cuts with less vibration
- Oversized blade body
- Unique plunge tip design
- Perma-SHIELD® non-stick coating



Part #	Mfg #	Length	Qty	Price
78815	DS0609CGP3	6"	3	53.54
78816	DS0909CGP3	9"	3	71.42
78817	DS1209CGP3	12"	3	95.99

TOOLS

## Diablo Blades, Hole Saws & Tools

TOOLS

### Demo Demon Carbide-Tipped Reciprocating Blade for Nail-Embedded Wood

- 6/9 TPI Variable tooth design provides faster cuts with less vibration in nail-embedded wood
- High performance carbide for greater durability
- Enhanced carbide tip to blade connection improves impact resistance
- Plunge tip design enables faster and easier plunging
- 1" Oversized blade body for straighter cuts with less vibration



Part #	Mfg #	Length	Qty	Price
78813	DS0606CWS3	6"	3	48.57
78814	DS0906CWS3	9"	3	69.61

### Demo Demon Carbide-Tipped Reciprocating Blade for Pruning & Clean Wood

- Aggressive carbide tooth geometry delivers fast and effortless cuts
- Large blade gullets between teeth for fast chip removal
- Carbide-tipped cutting edge
- Strengthened, oversized blade body



Part #	Mfg #	Length	Qty	Price
78818	DS0903CP	9"	1	22.26

### Demo Demon Bi-Metal Reciprocating Blade for Nail-Embedded Wood

- Variable tooth design provides faster cuts with less vibration Perma-shield coating protects blade from heat, gumming and corrosion
- Ultra-hardened cutting edge



Part #	Mfg #	Length	Qty	Price
78790	DS0612BW5	6"	5	28.81
78791	DS0912BW5	9"	5	34.65
78896	DS1212BW5	12"	5	44.20

### Demo Demon Bi-Metal Reciprocating Blade for Nail-Embedded Wood, Metal & Plastic

- Variable tooth design provides faster cuts with less vibration
- Perma-SHIELD® coating protects blade from heat, gumming and corrosion
- Ultra-hardened cutting edge



Part #	Mfg #	Length	Qty	Price
78792	DS0614BGP5	6"	5	32.01
78793	DS0914BGP5	9"	5	34.65

### Hole Saws

#### High Performance Hole Saw

- Drills wood, plastic, aluminum, metal and stainless steel
- 2-3/8" Cutting depth
- Snap-Lock™ mandrel system allows for quick and easy change
- One size fits all mandrel
- Tool-free plug ejection
- Variable tooth design



DHS0750



DHS1000



DHS1125



DHS1500



DHS1375



DHS2000



DHS2250



DHS4125



DHS3000



DHS4500



DHS4750



DHS6000

Part #	Mfg #	Size	Price
78829	DHS0750	3/4"	18.54
78830	DHS0875	7/8"	20.22
78831	DHS1000	1"	21.19
78832	DHS1125	1-1/8"	22.15
78833	DHS1375	1-3/8"	24.99
78834	DHS1500	1-1/2"	25.52
78835	DHS1750	1-3/4"	27.64
78836	DHS1875	1-7/8"	28.84
78837	DHS2000	2"	25.98
78838	DHS2250	2-1/4"	31.20

**Diablo Blades, Hole Saws & Tools**

High Performance Hole Saw (Continued)			
Part #	Mfg #	Size	Price
78839	DHS2500	2-1/2"	32.79
79047	DHS2563	2-9/16"	26.69
78840	DHS2625	2-5/8"	33.61
78841	DHS2687	2-11/16"	34.48
78843	DHS3000	3"	36.59
78842	DHS3625	3-5/8"	37.28
78844	DHS4000	4"	55.52
78845	DHS4125	4-1/8"	59.18
78846	DHS4250	4-1/4"	62.93
78847	DHS4500	4-1/2"	66.21
78848	DHS4750	4-3/4"	69.48
78849	DHS6000	6"	101.12

**Carbide GP Hole Saw**

- Cuts wood and metal
- 2-3/8" Cutting Depth
- Tool-free plug ejection for fast material removal
- SnapLock Plus mandrel system includes:
  - Pilot bit
  - 5/8" Threaded adapter (fits diameters 1-1/4" - 6")
  - 1/2" Threaded adapter (fits diameters 9/16" - 3-1/16")



Part #	Mfg #	Size	Price
78819	DHS1000CT	1"	32.63
78820	DHS1125CT	1-1/8"	34.75
78821	DHS1375CT	1-3/8"	37.63
78822	DHS1500CT	1-1/2"	38.98
78823	DHS1875CT	1-7/8"	42.56
78824	DHS2000CT	2"	44.18
78825	DHS2500CT	2-1/2"	53.77
79046	DHS2563CT	2-9/16"	54.31
78826	DHS2625CT	2-5/8"	54.70
78827	DHS2687CT	2-11/16"	55.74
78828	DHS3000CT	3"	56.93

**Hole Saw Kits**

**9-Piece Carbide General Purpose Hole Saw Kit**

- Drill wood, plastic, aluminum, metal, and stainless steel
- Cutting depth: 2-3/8" (60 mm)
- 1-Size fits all mandrel fits from 5/8" to 6" diameter
- Tool-free plug ejection
- Includes: 1", 1-1/8", 1-3/8", 1-1/2", 2", mandril, pilot bit, and (2) adaptor nuts



Part #	Mfg #	Description	Price
78850	DHS09SGPCT	9-Pc Hole Saw Kit	185.00

**11-Piece Multi-Project Bi-Metal Hole Saw Kit**

- Drill wood, plastic, aluminum, metal, and stainless steel
- Cutting depth: 2-3/8" (60 mm)
- 1-Size fits all mandrel fits from 5/8" to 6" diameter
- Tool-free plug ejection
- Includes: 2-1/8", 2-9/16", 3", 3-5/8", 4-1/8", 4-3/4", heavy-duty mandril, (2) pilot bits, and (2) adapter nuts



Part #	Mfg #	Description	Price
78852	DHS11SLD	11-Pc Hole Saw Kit	211.94

**14-Piece General Purpose Bi-Metal Hole Saw Kit**

- Drill wood, plastic, aluminum, metal, and stainless steel
- Cutting depth: 2-3/8" (60 mm)
- 1-Size fits all mandrel fits from 5/8" to 6" diameter
- Tool-free plug ejection
- Includes: 7/8", 1", 1-1/8", 1-3/8", 1-1/2", 1-3/4", 2", 2-1/8", 2-1/2", 2-9/16", mandril, pilot bit, and (2) adaptor nuts



Part #	Mfg #	Description	Price
78851	DHS14SGP	14-Pc Hole Saw Kit	194.74

TOOLS

*We Feature The Brand Name Products You Are Looking For*

Diablo Blades, Hole Saws & Tools

TOOLS

Parts & Accessories

Hex Arbor

- For use with drill presses and hand-held drills
- Includes bit and nuts



Part #	Mfg #	Size	Price
78853	DHSAR500	7/16"	30.64

Hole Saw Adapter Nut

- For use with high-performance hole saws
- 1/2" Thread adaptor nut fits hole saws from 9/16" to 1-3/16"
- 5/8" Thread adaptor nut fits hole saws from 1-1/4" to 6"



Part #	Mfg #	Description	Price
78857	DHSNUT2	2/Pk Hole Saw Adapter Nut	11.46

Hole Saw Pilot Bit



Part #	Mfg #	Size	Price
78854	DHS4BITII	1/4" x 4" Pilot Drill Bit	7.56
78855	DHS4BITCB	1/4" x 4" Cobalt Pilot Drill Bit	13.82
78856	DHS4BITCT	1/4" x 4" Carbide Pilot Drill Bit	21.67

Hand Hacksaw Blades

- T2 Technology for longer blade life
- Shatter resistant Bi-Metal construction

Blister Packed - 1 Per Card

Prod ID#	CSI#	Length	TPI	Price
49833	20155-S224HE	12"	24	5.41

Hand Saws

Tri-Fold® Saw

- Complete with reciprocating blade
- Locks into three different positions for cutting multiple materials
- Uses any reciprocating blade with 1/2" tang



Prod ID#	CSI#	Description	Price
17681	20997 (TFHS618636)	Wood, Drywall & Non-Metallic	55.34

PVC/ABS Plastic Pipe Hand Saw

- Easily cuts plastic pipe
- Flush cutting option
- Rubberized handle for comfortable grip



Prod ID#	CSI#	Description	TPI	Price
2499	HSF120 (20985)	12" Blade & Handle	10	43.85

Tubing Cutters

Ergonomically Designed For Professional Performance

- Professional deburring
- Full stop feed system stops cutting wheel damage
- Easy to use - change out wheels quickly and easily



Prod ID#	CSI#	Tube Diameter Range	Price
55073	21008 (TC5/8)	1/8" - 5/8"	33.77
55074	21009 (TC1)	1/8" - 1"	57.54
46652	21010-TC11/8	1/8" - 1-1/8"	64.22
46653	21011-TC13/8	1/8" - 1-3/8"	89.79



Utility Knife

Gold Utility Knife

- Easy Blade Change
- Stores up to 5 Blades



Prod ID#	CSI#	Description	Price
55071	20350 (Gold5C)	Utility Knife	6.82

Lenox® Gold™ Locking Tradesman Utility Knife

- Easy open & close secure locking mechanism
- Ergonomic, rubberized comfort grip
- Multi-use tool; bottle opener, screwdriver & pipe reamer
- Built-in wire stripper



Prod ID#	CSI#	Description	Price
58235	10771-FLK1	Locking Tradesman Utility Knife	36.18



**Tools**

**Vari-Bits®**

**Vari-Bit® Step Drill Bits**

- Two flute design cuts fast, clean round holes
- Steam oxide coating for durability
- Split point design for faster penetration and less walking



Prod ID#	CSI#	Number Hole Sizes	Hole Sizes (in)	Price
55042	VB2 (30882)	9	1/2" - 1"	122.10
2511	VB3 (30883)	9	1/4" - 3/4"	112.56
4604	VB11 (30888)	2	7/8", 1-1/8"	146.78
55044	VB12 (30912)	5	7/8" - 1-3/8"	175.42

**Wood Bits**

**Bi-Metal self-feed wood drill bit**

- High speed steel cutting edge
- Clean holes and easy chip removal
- Fast, easy drilling
- Quick change Hex shank



Prod ID#	CSI#	Diameter	Price
26955	LL256(1787566)	2-9/16"	86.82

**Tools**

**Screwdrivers**



Prod ID#	CSI#	Description	Price
55068	23931 (285)	6-in-1 Screwdrivers	19.10
55069	23932	9-in-1 Screwdrivers	25.92



**Flaring and Swaging Spin Tools**

- Fits into any regular drill
- Must use 18 Volt drill
- Hot Temp flaring; More quality, less leakage
- No Deburring Tool Required



Prod ID#	CSI#	Description	Price
72297	FSPIN100	Flaring Spin-4 Tools 1/4-5/8	146.80
72705	SSPIN300	Swaging Spin-6 Tools 1/4-7/8	206.72



**Telescopic Inspection Mirrors**

- American Made
- Double ball joint links swivel mirrors for viewing to 360°
- Links are made from tempered spring steel to withstand stress



Prod ID#	CSI#	Description	Price
3459	M-1	1-1/4" Circular Ext 6.25" - 18.25"	20.59
3460	M-2	2-1/4" Circular Extends 10" to 14"	23.76
3461	M-3	2-1/8"x3.5" Rect Ext 11.25"-15.25"	23.76

**Kut-All Plastic Tube/Hose Cutter**



Prod ID#	CSI#	Description	Price
3435	PK-2	Plastic Tube & Hose Cutter	59.43

**Chip Brush**

- 100% pure bristle, wood handle



Prod ID#	CSI#	Description	Price
47088	B-503 (9227)	2" Paint Brush	2.94

**Abrasive Cloth Grip-Cut**

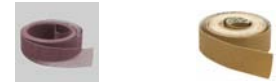

Prod ID#	CSI#	Description	Price
3468	SC-10	1-1/2" x 10 yds	16.07
54547	SCM-10	1-1/2" x 10 yds	28.50

**Fin Tools**

- All metal long lasting fin straightener
- Heavy duty spring wire bristles automatically adjust to ALL fin spacings

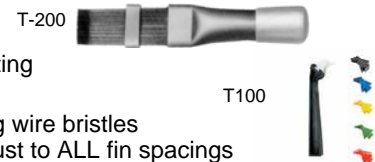

Prod ID#	CSI#	Description	Price
65297	T-100	Fin-Tool - Multi Head	33.07

Tools

**Fin Whisk**

- Plastic handled whisk for cleaning condenser & evaporator fins



Prod ID#	CSI#	Description	Price
3424	B-26	Fin Whisk Brush	6.98

**Rust Breaker**

- Loosens rusted bolts, screws, shafts, piping etc
- Telescoping spout applicator



Prod ID#	CSI#	Description	Price
27462	CR-1	4 oz Rust Breaker	11.85

**Rubber Anti-Vibration Pads**

**Mounting Pads**

- Anti-vibration pads

CP Pads



MP Pads

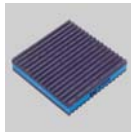

Prod ID#	CSI#	Size	Description	Price
2350	MP-2C	2"x2"x7/8"	Rubber/Cork	1.85
39455	MP-4C	4"x4"x7/8"	Rubber/Cork	4.97
69087	MP-2E	2"x2"x7/8"	Rubber/Polymetric	2.19
79016	MP-3E	3"x3"x7/8"	Rubber/Polymetric	7.19
69225	MP-4E	4"x4"x7/8"	Rubber/Polymetric	5.55

**Safety Supplies & Devices**

**Dust Masks**

- Extremely lightweight, metal nose clips



Prod ID#	CSI#	Description	Price
3456	5-500	Disposable Dust Mask	1.10

**Arrow Staple Gun & Staples**

- All steel construction
- Adjustable leg curl with 14954
- High carbon, hardened steel working parts
- 3/8", 1/2" & 9/16" Wedge-pointed staples



Prod ID#	CSI#	Description	Price
3478	T500C	Arrow® Outward Clinch Stapler	101.63
3853	540-508	1/2" Leg Staples f/T50 1250 Pk	14.85

**Plasti-kote™ Aerosol Paints**

**General Purpose Spray Paint**

- Resist temperatures to 180°F



Prod ID#	CSI#	Description	Price
2513	799-002	16 oz Flat Black Paint	18.49
2512	799-004	16 oz Flat White Paint	18.49

**Cable Staples**

- For NMB Cable (Romex) and copper insulated staples for thermostat wire



Prod ID#	CSI#	Description	Price
3411	625-1S5	Copper Insulated #5, 100/Pk	14.25

**Furnace Mounting Blocks**

- Easy peel and stick installation
- 1/4" of foam for vibration & noise



Prod ID#	CSI#	Description	Price
48666	FB1	Furnace Mounting Block	8.16

**Pull-A-Spout Oiler**

- All purpose oiler
- 14" telescoping spout



Prod ID#	CSI#	Description	Price
3965	CO-1	4 oz Oiler	8.99

**Channel Lock™ Products**



**Tongue & Groove Pliers**

- Patented undercut tongue & groove design
- Patented permalock fasteners & reinforcing edge
- Dipped plastic comfort grips



Prod ID#	CSI#	Description	Price
4029	545-430	10" Tongue & Groove Pliers	45.30
4030	545-440	12" Tongue & Groove Pliers	64.17

**Tools**

**Pliers**

- Slender, perfectly mated jaws w/no side wobble
- High polished finish
- Channellock Blue™ dipped plastic comfort grips

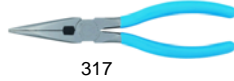

317

Prod ID#	CSI#	Description	Price
4022	545-317	7.25" Long Nose Plier-Side Cutter	84.28
4024	545-337	7" Lap Joint Cutting Pliers	65.91

**Duct Hanging Wire**

- 18 gauge galvanized on reel



Prod ID#	CSI#	Description	Price
3321	710-185G	5# Hanging Wire	60.87

**Duct Strap-Woven**



Prod ID#	CSI#	Description	Price
69390	710-100	1-3/4" Duct Strap-Woven	30.82

**Cliplight LED Lights**

- Magnetic
- LED

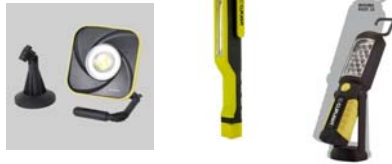

Prod ID#	CSI#	Description	Price
75332	111112	Clipstrip Pocket Flashlight	22.86
75333	111115	Pivoting Mini Light, 21 LED	32.69
76880	111121	LED Spotlight 1200 lumens	212.72

**Hose Clamps**

- Worm drive, adjustable .300 series SS 1/2" band with plated 5/16" slotted hex head & housing



Prod ID#	CSI#	Description	Price
59062	B-10H	No. 10, 9/16" - 1-1/16" Dia 3/8" - 5/8" Hose ID	16.71

**Rubber Tie Down Strap**

- Extra heavy steel "S" hooks on each end



Prod ID#	CSI#	Description	Price
3480	RS-31	31" Rubber Strap	6.45

**STANLEY BOSTITCH**  
Stanley Fastening Systems

**Heavy Duty PowerCrown™ Staples**

- 7/16" crown, .050" x .019" wire gauge

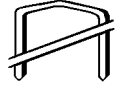

Prod ID#	CSI#	Length	Qty/ Ctn	Price
3852	STCR5019916-4M	9/16"	4M	38.46

**WHITLAM PLUMB-PRO**

**Tough-Boy Towels**

- 70 Count 10" x 12" wiping towels
- For removal of dirt, paint and adhesives
- Plastic dispenser



Prod ID#	CSI#	Description	Price
40407	TFB80	70 Count Towels	47.94

**EMC**

**Gloves**

- 9oz. Brown Jersey

J124



Prod ID#	CSI#	Description	Price
3441	J124	Brown Jersey (Untagged)	3.55

**Boot Covers**

- Non-skid Bottom
- Polypropylene Material



Prod ID#	CSI#	Description	Price
59939	1802-XL	X-Large Boot Covers (10pk)	6.56

**Nipple Trays**

- Rugged Steel holds sizes close thru 6"



Prod ID#	CSI#	Description	Price
3489	50R	1/2", holds 77	54.33
3490	75R	3/4", holds 66	58.23

Tools

**Drill Bit**



- 1/4" Carbide

Prod ID#	CSI#	Description	Price
3437	JRP9	1/4" Carbide Drill Bit	11.30

**Mastercraft Vacuum Bags**



Prod ID#	CSI#	Description	Price
3497	356883/MC4465	Vacuum Bags (5pack)	41.28

**Gases**



Prod ID#	CSI#	Description	Price
3962	EMG	14.1 oz Mapp Gas Cylinder	23.33

**EMC Miscellaneous**

Prod ID#	CSI#	Description	Price
3457	J680	Black Jumbo Marker	4.91

**Miscellaneous Tools**

**Cleaning Brushes**



Prod ID#	CSI#	Description	Price
22768	CLEANINGBRUSH	3" x 27" Bristled Cleaning Brush	20.33

**Copper Fitting Brush**



Prod ID#	CSI#	Size	Price
61509	B-129	7/8" OD Copper Fitting Brush	8.19

**NU-Kill Wasp & Hornet Spray**



Prod ID#	CSI#	Size	Price
58403	H-214/S1-200	SWAT Wasp/Hornet Spray 14oz.	12.07

**Dark Thread Cutting Oil**

- For high speed cutting machines
- Keep machines running cooler & extends the life of your dies
- Anti-mist & non-staining formula is not affected by weather



Prod ID#	CSI#	Size	Price
3355	30204	32 oz	33.32
3356	40220	1 gal	82.21

***We are a full line wholesaler. Contact us for information about items not listed in this catalog.***

TOOLS

**Testers & Meters**

**Stick Meters**

**Model HS36 StickStyle DMM**

- True RMS
- Auto-ranging
- Microamps f/ flame rectifier diode tests
- For variable frequency drives
- Thermocouple plugs in directly
- Non-contact voltage
- For motor-run and motor-start capacitors
- Backlight
- Includes rubberized case w/magnetic hanger, 400AAC clamp head, deluxe silicone test leads, alligator clips, k-type thermocouple, batteries, operator's manual & RFM66 fuse



Prod ID#	CSI#	Description	Price
49801	HS36	Stick Meter	470.81

**Gauges and Transmitters**

**Vacuum Gauge With Alarm**

- Rate calculator
- Schrader Depressor
- 1 Micron Resolution
- 0-9999 Micron Range
- Alarms and Stopwatch



Prod ID#	CSI#	Description	Price
71631	SVG3	Vacuum Gauge with Alarm	306.46

**Job Link Transmitter**

- Run your jobs through your iOS mobile device.
- Fill out inspection checklists, view live measurements, gather in-depth diagnostics, and adjust systems to live data.
- All reports can be emailed to customers and office, as well as saved in the cloud for access at anytime.
- Receives measurements from any Fieldpiece wireless manifold and the Fieldpiece wireless dual in-duct psychrometer via radio frequency for extra distance - up to 100' from instrument to phone.



Prod ID#	CSI#	Description	Price
71722	JL2	Job Link Transmitter	409.18

**Accessory Heads**

**Manometer Pressure Head**

- Maximum +/- 20" WC for gas pressure
- 9V battery
- Gas, static, positive & negative pressure



Prod ID#	CSI#	Description	Price
42508	AMN2	Manometer (Pressure) Head	168.53

**Air Velocity & Temperature Head**

- Measures air velocity
- Used to estimate CFM
- Range: 80 to 5900 ft./min
- Accuracy: +/- 3% +1dgt.
- Max operating temp: 120°F
- Output: 1mV/unit of measure (1mV/100ft/min above 2000 fpm)
- Temp Range: -4°F to 140°F



Prod ID#	CSI#	Description	Price
49920	AAV3	Anemometer Head	214.00

**Clamp Meters**

**SC260 Compact Clamp Meter**

- Volts AC/DC
- True RMS
- 400 Amps AC
- Temperature F/C
- Capacitance
- Non-contact voltage
- Continuity
- Diode Test
- Max/Min/Hold
- LCD Backlight
- Low Battery Indicator
- 40 Mega Ohm with 0.01 resolution



Prod ID#	CSI#	Description	Price
69752	SC260	Compact Clamp Meter W/True RMS	260.29

***For instructions as to proper installation, servicing, and troubleshooting, please refer to the Manufacturer's literature.***

Testers & Meters

## Testers & Meters

### Model SC440 - Essential Clamp Meter

- Volts AC/DC, True RMS
- Inrush current, Duty cycle %
- 400 amps AC, Magnetic strap
- Dual Display, Temp F/C
- Capacitance, Microamps DC
- Diode Test, Hold, LCD backlight
- Low Battery Indicator
- Hold, Continuity, Non-contact voltage
- 50 Mega Ohm w/.01 resolution



Prod ID#	CSI#	Description	Price
72753	SC440	Essential Clamp Meter	477.50

### Voltage Tester

#### Non-Contact Voltage Tester

- Detects live AC voltages without contact
- Bright red LED light & buzzer
- Range: 24VAC to 440VAC
- Senses 24VAC for thermostat power
- Conveniently clips to shirt pocket



Prod ID#	CSI#	Includes:	Price
48211	SNCV1	Non-Contact Voltage Tester	30.68

### In-Duct Thermometer

- Quick and easy in-duct measurement
- Hangin hooks for hands free temp
- Fits easily in pocket
- Bright Backlight
- 8000 hour battery life



Prod ID#	CSI#	Description	Price
54043	SPK2	In-Duct Style Thermometer	59.92

### Pocket Digital Psychrometer

- Wet Bulb, Dry Bulb, Dew Point, %RH



Prod ID#	CSI#	Description	Price
67022	PRH2	Pocket Digital Psychrometer	140.81

### Wireless Dual In-Duct Psychrometer

#### SDP2 Wireless Dual In-Duct Psychrometer

- Hands Free Testing
- Sends live indoor wet bulb readings to the SMAN4 Digital Manifold
- Dual Display



Prod ID#	CSI#	Description	Price
71723	SDP2	Wireless Dual In-Duct Psychrometer	511.90

### K-Type Thermocouples

- Works with all fieldpiece meters that measure temperature



Prod ID#	CSI#	Description	Price
44603	ATC1	Pipe Clamp (3/8" to 1-3/8" Open)	134.77

### Test Leads



ADLS2

Prod ID#	CSI#	Description	Price
50615	ADLS2	Deluxe Silicone Test Leads	48.69
52866	ASLS2	Silicone Test Leads	35.66
69534	RCT2	Molex Probe Tips -Thin-MiniSplits	24.94

### Stand Alone Meters

#### SDMN5 Dual Port Manometer

- Measures inches WC, mmWC, mBar, and PSI
- Rugged rubber boot
- Min/Max and hold
- Auto off to conserve battery life
- Accuracy: +/-1.5% FS
- Range: 0.00 to +/-60.0
- Resolution: .01 inch WC



Prod ID#	CSI#	Description	Price
52419	SDMN5	Dual Port Manometer	265.37

**Testers & Meters**

**Carbon Monoxide Detectors**

- Fast electrochemical sensor helps find CO sources
- Calibrate to ambient quickly with ZERO button
- Audio and visual alarms
- Bright blue backlit dual display
- Magentic hanger
- Auto Power-off
- Battery check
- 0 to 1000PPM



Prod ID#	CSI#	Description	Price
68932	SCM4	Carbon Monoxide Detector	451.97

**Infrared Refrigeration Leak Detector**

- Sensitivity better than 0.1 oz/yr
- 8-hr rechargeable lithium ion battery
- CFC, HFC, HCFC and blends
- Auto Recalibration
- Senses refrigerant level change



Prod ID#	CSI#	Description	Price
56541	SRL2K7	Infrared Refrigerant Leak Detector	761.85

**Digital Manifold - 3 Ports**

- 3 Ports
- Target superheat
- Automatically calculated from measurements taken
- No guesswork or manual calculations
- Superheat and subcooling calculated and displayed simultaneously
- Backlit display
- Micron gauge
- Alarm, stopwatch, and rate indicator
- 50 to 9,999 resolution



Prod ID#	CSI#	Description	Price
71952	SMAN360	Wireless Digital Manifold - 3 Ports	847.45

**Wireless Digital Manifold - 4 Valves**

- 4 Ports!
- Auto Target SuperHeat
- Displays both SuperHeat & SuperCool
- Built in micron vacuum
- Alarms & Stopwatch
- Large 3/8" Port
- WIRELESS Measurements



Prod ID#	CSI#	Description	Price
71259	SMAN460	Wireless Digital Manifold - 4 Valves	1070.01

**Residential Refrigerant Scale**

- Charging & recovery weight alarms
- Easy to Carry
- 0.25 oz (0.01kg) resolution
- Water Resistant



Prod ID#	CSI#	Description	Price
73445	SRS1	Residential Refrigerant Scale	316.73

**Wireless Refrigerant Scale**



Prod ID#	CSI#	Description	Price
70457	SRS2C	Wireless Refrigerant Scale	546.14

**Wireless Refrigerant Scale**

- Job Link Mobile System
- 252 lbs
- Water Resistant
- 200 Hour platform battery life



Prod ID#	CSI#	Description	Price
76661	SRS3	Wireless Refrig Scale- Job Link	546.14

**Charging Jacket**

- Charge from 37-70deg outside
- Service Maintenance contracts season
- Extend Billable hours



Prod ID#	CSI#	Description	Price
66847	S365	Charging Jacket	227.70

Testers & Meters

Testers & Meters

**Combustion Meters**

**SOX3 - Combustion Check Kit**

- Automatic Electric Pump w/ Pause
- Field Replaceable Oxygen Sensor
- Hands-free Testing
- Combustion Efficiency
- Custom Fuels



Prod ID#	CSI#	Description	Price
67398	SOX3	Combustion Check w/ Auto Pump	725.89

**Electronic Handles**

- MIN/MAX to record highest and lowest reading
- Ranges: 200mVAC, 2000mVAC, 200mVDC, 2000mVDC
- Resolution: 0.1mV



Prod ID#	CSI#	Description	Price
53001	EHDL1	Electronic Handle	79.61

**4 Pocket Meter Case**

- Holds 1 meter & 2 Access Stick Heads
- 10"H x 6.5"W x 1.5"D



Prod ID#	CSI#	Description	Price
64050	ANC1	4 Pocket Case	37.32



**ABM-200 Airflow & Environmental Meter**

- Wind Speed/Direction/Gusts
- Dry Bulb Temperature
- Wet Bulb Temperature
- Relative Humidity
- Dew Point
- Barometric Pressure
- Stores & Send Reports



Prod ID#	CSI#	Description	Price
74437	ABM-200	Airflow & Environmental Meter	160.38



**Combustion Gas Leak Detector**

**Combustible Gas Leak Detector**

- 50 ppm minimum detection
- Long 18" gooseneck
- Visual leak detection by color LED's
- Separate user adjustable alarms for predetermined level detection
- Precision sensor detects even the smallest leaks
- 'Tip-light' in sensor cap illuminates the search area
- Adjustable tick rate to locate leaks quickly and easily
- Fast response time of less than two seconds to 40% LEL
- Headphone jack
- 3 Year limited warranty



Prod ID#	CSI#	Description	Price
71403	CD200	Combustible Gas Leak Detector	453.55

**Digital Thermometer**

**PDT550 Digital**

- -58 to 571°F (-50 to 300°C)
- Waterproof
- Built-in magnetic mount
- Records min & max temperatures
- HOLD freezes the current temp reading
- Easy access battery compartment
- Enhanced accuracy of digital circuitry
- Includes battery & multipurpose cover
- 3-Year limited warranty



Prod ID#	CSI#	Description	Price
6633	PDT550	Pen Type	51.75

**Accessories**

**Test Leads**

- UL listed insulated



Prod ID#	CSI#	Description	Price
22938	ATL55	Insulated Test Leads, UL listed	35.13

Testers & Meters



**Leak Detection**

**EZ-Ject™ Dye Injection System**

- For small to medium systems
- Each cartridge treats up to 2 gallons of lubricant or 25 lbs of refrigerant
- No pouring, measuring or spilling of dyes
- Ideal for preventive maintenance programs

**EZ-Ject™ Dye Injection Kit**

- Contains: dye injector and hose assembly, (2) EZ-Ject™ universal dye cartridges, purge fitting and service labels



Prod ID#	CSI#	Description	Price
61426	EZ-100ECS	Universal Dye Injection Kit	232.85

**EZ-Ject™ Cartridges**



Prod ID#	CSI#	Description	Price
61427	EZ-4CS	EZ-Ject Dye Cartridges for Mineral Oil Sys. (6 x 0.5 oz.)	46.70
61481	EZ-4/ECS	EZ-Ject Universal Dye Cartridges (6 x 0.5 oz.)	47.23

**EZ-Ject™ Kit With OPTIMAX Jr™ Flashlight**

- DISCONTINUED - REPLACED BY OPK-40EZ/E
- Contains:
  - OPTIMAX Jr™ flashlight
  - Dye injector and hose assembly
  - 2) EZ-Ject™ universal dye cartridges
  - Purge fitting
  - 8 oz. GLO-AWAY™ dye cleaner
  - Fluorescence-enhancing glasses
  - Plastic case



Prod ID#	CSI#	Description	Price
61421	OPK-50EZ/E	EZ-Ject™ Kit w/ OPTIMAX Jr™ Flashlight	303.51

**Complete EZ-Ject™ Kit With Cordless Violet LED Leak Detection Flashlight**

- Contains:
  - Violet Light LED Flashlight - Cordless
  - Dye injector and hose assembly
  - 2) EZ-4/E 0.5oz universal/POE dye cartridges
  - Hose/Coupler w/check valve, low loss and Purge fittings
  - 8 oz. GLO-AWAY™ dye cleaner
  - Fluorescence-enhancing glasses
  - Plastic case



Prod ID#	CSI#	Description	Price
73797	OPK-40EZ/E	EZ-Ject™ Kit w/ Violet LED leak Detection Flashlight	343.13

**Lamps for Fluorescent Leak Detection**

**OPTIMAX Jr™ Mini Flashlight**

- Compatible with all leak detection dyes
- 100,000-hour LED bulb
- Over 4 hours of peak performance
- Choice of continuous or momentary illumination
- 3 "AAA" batteries (included)



Prod ID#	CSI#	Description	Price
61428	OPX-400CS	Flashlight w/UVS-40 Glasses	179.12

**Qwik Check - 2 Second Acid Test**

- Color Change Indicates Pass/Fail
- Works with All Refrigerants & Oils
- Meets EPA Venting Regulations
- unique Patented Disposable Design
- Tests for Inorganic Acids to the ARI-700 limit of 1ppm



Prod ID#	CSI#	Description	Price
68413	QT2000	Qwik Check 2-Sec. Acid Test	16.59

**THANK YOU!**  
*We appreciate your business!*

Testers & Meters

**Leak Detection**

**Qwik608**

- EPA-Approved Section 608 certification study guide
- 236 page, full color, fully illustrated study manual
- Two-hour video DVD, a CD-Rom study guide which includes over 400 practice questions
- One hour audio CD
- Available in English or Spanish
- Four types of certification available



Prod ID#	CSI#	Description	Price
74081	QT3000	608 Study Kit/Paper Test	211.23

**MA-LINE**  
MORTLAND ASSOCIATES, INC.

**Smoke Cartridges**

**White Smoke Cartridges**

- For testing leaks in duct work, heat exchangers etc
- 90 Sec/600 cu ft S/B Smoke Candle



Prod ID#	CSI#	Description	Price
3471	MA-SC600CF	Smoke Candle	5.17

**CLIGHT**  
LEADERS IN LIQUID SCIENCE.

**Cliplight High Resolution Universal Dye**

- Flashes into Refrigerant as mist
- Will not react to moisture
- No dye injector needed
- Compatible with all oils & refrigerants



Prod ID#	CSI#	Description	Price
70015	FLASH980	Flash High Resolution Dye	24.73

**DIVERSITECH**

**Pocket Thermometers**

- 1" dia dial w/5" stems
- Adjustable for recalibration
- 1% accuracy full scale
- Stainless steel construction, polycarbonate crystal



Prod ID#	CSI#	Description	Price
3839	TD-1	0 to +220°F	17.46

**Leak Test Gauge**

- 2" 30 PSI



Prod ID#	CSI#	Description	Price
38047	TG-30	3/4" FPT Conn. Leak Test Gauge	34.31

**If you need a product not listed in this catalog, please check with us. We have not listed every product we can get for you.**



**Motors**

**Motors**

**Multi-Speed Condenser Fan**

- ECM 1/8-1/3 HP
- 230 Volt 50/60Hz
- CW/CCW 825/1075 rpm
- 48 Frame - Ball Bearing
- 6.5" Shaft Length .5" diameter



Prod ID#	CSI#	Description	Price
74566	10874	1/8-1/3HP 230 825/1075 ECM	322.55
74568	08598	SURGE PROTECTOR 10874	22.11

**Multi-Speed Condenser Fan**

- PSC
- 208/230V 1075 rpm
- 48 Frame
- 1/2" Shaft Ball Bearing



Prod ID#	CSI#	Description	Price
74604	10458	1/6-1/3HP 230V 1075RPM PSC CFM	137.58
76805	10468	1/5-1/2HP 230V 1075RPM PSC CFM	184.60

**Multi-Speed Condenser Fan**

- PSC
- 208/230V 825 rpm
- 48 Frame 5" Shaft Length
- 1/2" Shaft Ball Bearing



Prod ID#	CSI#	Description	Price
76806	10469	1/6-1/3HP 230V 825RPM PSC CFM	175.87

**Multi-Speed Condenser Fan**

- PSC 1/4, 1/5, 1/6hp
- 208/230V 1625 rpm
- 42 Frame 3" Shaft Length
- 1/2" Shaft Ball Bearing



Prod ID#	CSI#	Description	Price
79201	10724	1/4-1/6HP 230V 1625RPM PSC CFM	140.29

**PSC Condenser Fan Motor - U.S. Motors**

- 5.6" Diameter
- Automatic reset thermal overload protector
- Reversible
- 60°C Ambient
- Self-aligning bearings have all angle thrust system
- Extended studs
- 30" Leads
- Drain holes both ends



Prod ID#	CSI#	HP	Mfd Cap	Volts	Price
71406	1860	1/4	5	230	164.35
71407	1861	1/3	7.5	230	174.52

**PSC Condenser Fan**

- 5.6" Diameter, 48 frame
- 230V, 1075 rpm, 1 Phase
- Reversible
- Totally enclosed, air over
- 60 C° Ambient design, stud mount, without capacitor, all angle mount
- Designed for 370V capacitors
- Automatic thermal overload protector
- 30" Leads



Prod ID#	CSI#	HP	Mfd Cap	Price
4596	10728	1/4	5	131.61
4601	10729	1/3	7.5	138.03
4735	10730	1/2	10	167.78
56752	10731	3/4		205.44

**Azure Digi-Motor**

- Outboard replaceable surge protector
- Adjustable speeds
- 625 RPM constant fan mode
- High Efficiency 85%
- Multi-horsepower
- Dual voltage



Prod ID#	CSI#	HP	Volt	Spds	Price
69942	10860	1/5-1/2	115/230	4	467.77
71346	10861	1/2-1	115/230	4	564.59

Motors

**Motors**

**ECM Prem. Dir. Drive Fan/Blower Mtrs - U.S. Motors**

- 5.6" Diameter
- 1075 rpm, 3 Speed
- Reversible
- Stud or hub ring mount (2.5")
- Automatic thermal overload protector
- Continuous duty, air over
- Sleeve bearing motors with all angle thrust system
- Class B insulation
- 24" Leads
- 48 Frame



Prod ID#	CSI#	HP	Mfd Cap	Volts	Price
65346	1864	1/3	7.5	115	182.77
65347	1865	1/2	10	115	220.85
65348	8904	3/4	15	115	250.94

**Multi-Speed Blower Motor**

- 1/5 - 3/4 HP PSC
- 115V 1075 rpm
- 48 Frame 5.8" Shaft Length
- 1/2" Shaft Ball Bearing
- Direct Drive



Prod ID#	CSI#	Description	Price
76804	10466	1/5-3/4HP DD Blw Mtr 115V	186.54

**Direct Drive Fan/Blower Motors**

- 5.6" Diameter
- 1075 rpm, 3 Speed
- Reversible
- Stud or hub ring mount (2.5")
- Automatic thermal overload protector
- Continuous duty, air over
- Sleeve bearing motors with all angle thrust system
- Class B insulation
- 24" Leads
- 48 Frame



Prod ID#	CSI#	HP	Mfd Cap	Volts	Price
8106	10583	1/4	5	115	130.63
2058	10585	1/3	5	115	147.66
2060	10587	1/2	5	115	182.97
2062	10589	3/4	15	115	183.10
71425	S1-FHM3595	1	20	115	333.47
2059	S1-FHM3586	1/3	5	230	157.71
2061	10588	1/2	10	230	182.97
2063	S1-FHM3590	3/4	10	230	204.21

**Direct Drive Blower**

- 5" Dia shaded pole
- 6.2 Amps
- Sleeve bearing, auto overload
- CW Facing shaft
- 42 Frame open, single shaft
- 2-1/2" Mounting rings

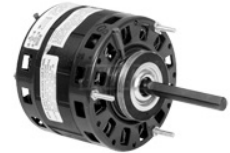

Prod ID#	CSI#	HP	Volt	RPM	Price	
2072	10810	1/5	115	1050	3	192.04

**Belted Fan and Blower**

- Split phase, 115V, 1725 rpm
- Class A insulation
- With threaded conduit hole
- Reversible rotation by easy reconnection
- Automatic thermal overload protector



Prod ID#	CSI#	HP	Price
2080	S1-02431417000	1/4	183.15
2083	S1-02431418000	1/3	187.87
2084	S1-02431419000	1/2	237.73

**Belly Band Mounting**



Prod ID#	CSI#	Description	Price
70162	KIT43	Belly Band Mtg Rng 42"	38.01
69374	KIT44	Belly Band Mtg Rng 48"	39.14

**A/4L V-Belts**

- For use in air conditioning, refrigeration, & appliance equipment
- Features concave sidewalls to give the belt full grip on pulley sides
- Rubber filled cords prevent separation of cores and rubber
- Protective fabric jacket for silent running, oil, and heat-resistance
- 1/2" Top width



Prod ID#	CSI#	Description	Price
73659	A20/4L220	22" x 1/2"	11.13
1584	A21/4L230	23" x 1/2"	15.30
1585	A22/4L240	24" x 1/2"	15.30
1586	A23/4L250	25" x 1/2"	11.18
1588	A25/4L270	27" x 1/2"	11.18
1589	A26/4L280	28" x 1/2"	11.18
1594	A31/4L330	33" x 1/2"	11.77
1595	A32/4L340	34" x 1/2"	11.77

**Motors**

<b>A/4L V-Belts (Continued)</b>			
Prod ID#	CSI#	Description	Price
1596	A33/4L350	35" x 1/2"	14.71
1597	A34/4L360	36" x 1/2"	14.71
1598	A35/4L370	37" x 1/2"	14.71
1599	A36/4L380	38" x 1/2"	15.30
1600	A37/4L390	39" x 1/2"	14.71
1601	A38/4L400	40" x 1/2"	14.71
1602	A39/4L410	41" x 1/2"	14.71
1603	A40/4L420	42" x 1/2"	14.71
1604	A41/4L430	43" x 1/2"	14.71
1605	A42/4L440	44" x 1/2"	17.66
1606	A43/4L450	45" x 1/2"	14.71
1607	A44/4L460	46" x 1/2"	14.71
1610	A45/4L470	47" x 1/2"	14.71
1611	A46/4L480	48" x 1/2"	14.71
1612	A47/4L490	49" x 1/2"	15.30
1613	A48/4L500	50" x 1/2"	15.30
1614	A49/4L510	51" x 1/2"	15.30
1615	A50/4L520	52" x 1/2"	15.30
1616	A51/4L530	53" x 1/2"	15.60
1617	A52/4L540	54" x 1/2"	16.18
1618	A53/4L550	55" x 1/2"	16.48
1619	A54/4L560	56" x 1/2"	16.48
1621	A56/4L580	58" x 1/2"	16.89
1622	A57/4L590	59" x 1/2"	17.66

<b>B/5L V-Belts</b>			
Prod ID#	CSI#	Description	Price
59733	B-48/5L510 (94440)	51" x 21/32"	14.85
59735	B-49/5L520 (94441)	52" x 21/32"	14.85
59738	B-50/5L530 (94442)	53" x 21/32"	15.04
59739	B-51/5L540 (94443)	54" x 21/32"	15.04
59740	B-52/5L550 (94444)	55" x 21/32"	15.24
59741	B-53/5L560 (94445)	56" x 21/32"	15.44
59742	B-54/5L570 (94446)	57" x 21/32"	15.64
59743	B-55/5L580 (94447)	58" x 21/32"	15.84
59744	B-56/5L590 (94448)	59" x 21/32"	15.84



**Transformer - Foot Mount**

- 120/208/240VA
- Output 40VA
- Class II transformer
- 50/60 Hertz



Prod ID#	CSI#	Description	Price
70060	PF42440	20v 40va Foot Mt Transformer	24.82

**Carrier Combustion Motor C-Frame**

- 25 MHP, 115V, 3300RPM
- Shaded Pole
- Special Leads and Plug Incl.
- Single Speed
- Single Phase



Prod ID#	CSI#	Description	Price
59590	65569	Carrier Draft Inducer Motor 1sp	160.96
67851	A65569BW	Single Inlet Blower Wheel Galv CCW 4" Diameter -5/16" Bore	36.24



**Motors**

**Multiple Horsepower  
Condenser Fan Motors**

- 115V
- 1075 RPM



Prod ID#	CSI#	HP	Mfd Cap	Price
45579	10463	1/6 to 1/2	10	171.95

**Capacitors**

**Motor Run - 370VAC, Single Capacitance**

- Oval



Prod ID#	CSI#	Description	Price
21663	37040H	4 uf, 2.17"	7.07
2672	37050H	5 uf, 2.17"	6.77
2673	37075H	7.5uf, 2.17"	7.36
2675	37100H	10 uf, 2.56"	10.12

Motors

Motors

Motor Run - 370VAC, Single Capacitance (Continued)

Prod ID#	CSI#	Description	Price
60192	S1-CAP37125F	12.5 uf, 2.56"	14.65
2676	37150H	15 uf, 2.95"	12.36
71140	37200H	20 uf, 2.95"	14.29
2677	37250H	25 uf, 2.95"	18.77

Motor Run - 440VAC

- Oval



Prod ID#	CSI#	Description	Price
72257	S1-CAP44050F	5.0uf, 2.17"	6.65
39439	S1-CAP44075F	7.5uf, 2.17"	9.47
72256	S1-CAP44100F	10.0uf, 2.17"	8.18

Motor Run - 440VAC, Dual Capacitance

- Round
- Flat



Prod ID#	CSI#	Description	Price
53864	S1-CAP4405025DR	25+5uf, Rnd	19.59
78698	CD30+3X440R	30+3uf, Rnd	15.64
65628	S1-CAP4407530DR	30+7.5uf, Rnd	25.68
79013	CD30+7.5X440R	30+7.5uf, Rnd	17.53
74533	CD35+3X440R	35+3uf, Rnd	18.12
74534	CD35+4X440R	35+4uf, Rnd	17.58
74700	CD35+5X440R	35+5uf, Rnd	17.26
65629	S1-CAP4407535DR	35+7.5uf, Rnd	26.57
79014	CD40+3X440R	40+3uf, Rnd	18.11
65630	S1-CAP4407540DF	40+7.5uf, Flat	16.85
53865	S1-CAP4405045DR	45+5uf, Rnd	22.67
65631	S1-CAP4407545DR	45+7.5uf, Rnd	19.92
79015	CD55+7.5X440R	55+7.5uf, Rnd	23.66
65633	S1-CAP4407560DR	60+7.5uf, Rnd	39.38
79070	CD65+5X440R	65+5uf, Rnd	40.90
78705	CD70+5X440R	70+5uf, Rnd	27.23
78704	CD80+5X440R	80+5uf, Rnd	35.05

**Motors**

**Fan Motors**  
**Multi-Horsepower**



Prod ID#	CSI#	HP	Voltage	Rotation	RPM	Price
58108	WG840469	1/3 - 1/6	208/230-1-60	Reversible	825	172.59

**Fan Blades**  
**Propeller Fans**



Prod ID#	CSI#	Nom Dia	Rotation	# of Blades	Blade Pitch	Price
20219	S1-02634091000	18"	CW	2	24°	128.06
20220	S1-02634092000	18"	CW	3	31°	146.09
20221	S1-02634094000	22"	CW	3	34°	159.86
59189	S1-02635436000	24"	CW	2	18°	280.71

**Run Capacitors**

- Continuous duty for single phase AC motors
- Non PCB liquid filled
- Tin plated 1/4 x .032 male terminals
- Internally protected by pressure sensitive interrupter device
- Aluminum case with terne plate steel cover



**Dual Run Capacitors**

Prod ID#	CSI#	MFD Compr	MFD Fan	Voltage	Can Style	Dimensions	Price
20052	S1-CAP3705025DR	25.0	5.0	370	Round	2.00" x 2.88"	19.17
45155	S1-02423296700	30.0	4.0	370	Round	2.00" x 3.88"	60.07
41647	S1-CAP3705045DF	45.0	5.0	370	Round	2.00" x 3.88"	27.40
52575	S1-02425033700	60.0	5.0	370	Round	2.50" x 4.75"	60.01
50724	S1-02426037000	80.0	5.0	370	Round	2.50" x 4.75"	90.23
47802	S1-CAP4405030DR	30.0	5.0	440	Round	2.00" x 3.88"	19.52
20055	S1-CAP4405035DR	35.0	5.0	440	Round	2.00" x 4.75"	21.43
20057	S1-CAP4405040DR	40.0	5.0	440	Round	2.00" x 4.75"	20.45
65406	S1-CAP4405050DR	50.0	5.0	440	Round	2.00" x 4.75"	25.00
20058	S1-CAP4405055DR	55.0	5.0	440	Round	2.50" x 4.75"	30.15
68190	S1-CAP4405060DR	60.0	5.0	440	Round	2.00" x 4.75"	30.15
76641	S1-CAP4407550DR	50.0	7.5	440	Round	2.50" x 4.75"	21.56
76642	S1-CAP4407555DR	55.0	7.5	440	Round	2.50" x 4.75"	25.06

Motors

**Seven stand alone locations state wide to serve your needs!**

## Motors

### Multi-Capacity Run Capacitors

- 370v or 440v
- Perfect for Truck Stock Emergencies



Prod ID#	CSI#	Description	Price
68175	12100	TURBO 200 Mini 3-15.0 MFD	24.82
65005	12200	TURBO 200 2.5- 67.5 MFD Run Capacitor	131.55
72048	12300	TURBO 200X 5/6/7.5/10/20/50 MFD	176.58

### Contactors

#### Single Pole

Prod ID#	CSI#	Amps	Voltage	Description	Price
39067	S1-02427531000	30	24	1 Pole w/Shunt	50.33

#### 2-Pole

Prod ID#	CSI#	Amps	Voltage	Price
43735	S1-02432004000	30	24	66.17

### Blower Wheels

#### Direct Drive

- Universal replacement "DD" wheels
- For direct drive blowers
- Dynamically balanced & forward curved
- 1/2" Bore size



Prod ID#	CSI#	Dia	Width	Center Rot	Notes	Price
41363	S1-02619654707	10"	6"	CW		171.62
14587	S1-02624069700	10"	7"	CW		207.04
9040	S1-02619654703	10"	8"	CW		148.34
43716	S1-02619654011	10"	9"	CW		213.91
32925	S1-02619654709	11"	8"	CW		176.60
8872	S1-02636186000	10"	10"	CCW	Concave	219.00
14586	S1-02636292000	11"	9"	CW		302.92
31907	S1-02619654014	11"	10"	CW		182.98
43237	S1-02619654012	11"	10"	CW	Concave	260.05
45938	S1-02638510000	11"	11"	CW		209.13

#### Belt Drive

- 1" Bore size

Prod ID#	CSI#	Width	Dia	Notes	Price
38395	S1-02625529704	15"	15"	Reversible, Double Hub	367.83



**Piping**

**Flexible Gas Lines**



Prod ID#	CSI#	Size	Price
28347	38.2FGL	3/8" x 2' Flexible Gas Line	30.03
6619	38.4FGL	3/8" x 4' Flexible Gas Line	42.90
6621	38.6FGL	3/8" x 6' Flexible Gas Line	60.02
60970	12.30FGL	1/2" x 30" Flexible Gas Line Yellow	33.21
60971	12.36FGL	1/2" x 36" Flexible Gas Line Yellow	36.23

**Threaded Black Pipe**



Prod ID#	CSI#	Size	Price
2338	12.10BP	1/2" x 10' Black Pipe (Pc)	19.62
2339	34.10BP	3/4" x 10' Black Pipe (Pc)	26.06
2340	1.10BP	1" x 10' Black Pipe (Pc)	38.69
2337	1.21BP	1" x 21' Black Pipe (Pc)	74.88
26557	114.10BP	1-1/4" x 10' Black Pipe (Pc)	62.17

**Black Malleable Iron Fittings Threaded 150#**

**Threaded 150# Hex Bushings - Black MI**



Prod ID#	CSI#	Size	Price
2237	34.12BREDBU	3/4" x 1/2"	5.40
2239	1.34BREDBU	1" x 3/4"	5.14
34281	112.114BRDBU	1-1/2" x 1-1/4"	9.99

**Threaded 150# Caps - Black MI**



Prod ID#	CSI#	Size	Price
2221	12BCAP	1/2"	2.62
2222	34BCAP	3/4"	3.55
2223	1BCAP	1"	4.50

**Threaded 150# RH Couplings - Black MI**



Prod ID#	CSI#	Size	Price
2224	12BCPG	1/2"	2.99
2225	34BCPG	3/4"	4.19
2226	1BCPG	1"	7.41
26563	114BCPG	1-1/4"	9.52

**Threaded 150# 45° Elbows - Black MI**



Prod ID#	CSI#	Size	Price
2207	12B45	1/2"	4.29
2208	34B45	3/4"	5.24
2209	1B45	1"	7.79

**Threaded 150# 90° Elbows - Black MI**



Prod ID#	CSI#	Size	Price
2197	12B90	1/2"	2.59
2198	34B90	3/4"	3.18
2199	1B90	1"	5.86
26560	114B90	1-1/4"	10.57

**Threaded 150# Black Reducing 90°**



Prod ID#	CSI#	Size	Price
2204	34.12BRED90	3/4" x 1/2"	4.97
2205	1.12BRED90	1" x 1/2"	7.09
2206	1.34BRED90	1" x 3/4"	7.44

**Threaded 150# BlackStreet 90°**



Prod ID#	CSI#	Size	Price
2200	12BST90	1/2"	3.69
2202	34BST90	3/4"	5.23
2203	1BST90	1"	8.01

**Threaded Square Headed Black Plugs**



Prod ID#	CSI#	Size	Price
2231	12BPL	1/2"	2.40
2232	34BPL	3/4"	2.40
2233	1BPL	1"	3.41

Piping

**Piping**

Piping

**Threaded 150# Reducers - Black MI**



Prod ID#	CSI#	Size	Price
33369	12.38BREDCPG	1/2" x 3/8"	4.29
2227	34.12BREDCPG	3/4" x 1/2"	4.76
2228	1.12BREDCPG	1" x 1/2"	6.83
2229	1.34BREDCPG	1" x 3/4"	7.61
27478	114.1BREDCPG	1-1/4" x 1"	9.52
26812	2.112BREDCPG	2" x 1-1/2"	17.47

**Threaded 150# Tees - Black MI**



Prod ID#	CSI#	Size	Price
2210	12BT	1/2"	3.44
2211	34BT	3/4"	4.84
2212	1BT	1"	8.98
59078	114BT	1-1/4"	14.76
78724	2BT	2"	32.13

**Threaded 150# Reducing Run/Outlet Tees - Black MI**



Prod ID#	CSI#	Size	Price
2213	34.12.12BREDT	3/4" x 1/2" x 1/2"	8.13
2215	34.12.34BREDT	3/4" x 1/2" x 3/4"	9.71
2217	1.12.12BREDT	1" x 1/2" x 1/2"	12.68
22914	1.12.1BREDT	1" x 1/2" x 1"	12.68
2216	1.34.12BREDT	1" x 3/4" x 1/2"	12.57
23002	1.34.34BREDT	1" x 3/4" x 3/4"	11.68

**Threaded 150# Reducing Outlet Tees - Black MI**



Prod ID#	CSI#	Size	Price
2214	34.34.12BREDT	3/4" x 3/4" x 1/2"	7.46
2218	1.1.12BREDT	1" x 1" x 1/2"	11.13
2219	1.1.34BREDT	1" x 1" x 3/4"	11.13

**Black Malleable Iron Unions**

**Threaded 150# Seat Unions - Black MI**



Prod ID#	CSI#	Size	Price
2234	12BUN	1/2"	11.62
2235	34BUN	3/4"	13.76
2236	1BUN	1"	18.98
26561	114BUN	1-1/4"	28.04

**Black Nipples**



Prod ID#	CSI#	Size	Price
22921	38.3BN	3/8" x 8"	3.46
2241	12CBN	1/2" x Close	1.79
2242	12.112BN	1/2" x 1-1/2"	1.79
2243	12.2BN	1/2" x 2"	1.79
2244	12.212BN	1/2" x 2-1/2"	2.12
2245	12.3BN	1/2" x 3"	2.12
2246	12.312BN	1/2" x 3-1/2"	2.54
2247	12.4BN	1/2" x 4"	2.82
2248	12.412BN	1/2" x 4-1/2"	3.30
2249	12.5BN	1/2" x 5"	3.30
2250	12.512BN	1/2" x 5-1/2"	3.71
2251	12.6BN	1/2" x 6"	3.71
78996	12.7BN	1/2" x 7"	5.62
2252	12.8BN	1/2" x 8"	6.65
79005	12.9BN	1/2" x 9"	6.74
2253	12.10BN	1/2" x 10"	8.01
79006	12.11BN	1/2" x 11"	8.03
2254	12.12BN	1/2" x 12"	9.52
31177	12.14BN	1/2" x 14"	16.53
31178	12.16BN	1/2" x 16"	16.53
33724	12.18BN	1/2" x 18"	13.39
33725	12.24BN	1/2" x 24"	17.48
33726	12.30BN	1/2" x 30"	20.51
77775	12.48BN	1/2" x 48"	27.81
2240	12B66P	1/2", 66 Pack	123.94
2256	34CBN	3/4" x Close	2.31
2257	34.112BN	3/4" x 1-1/2"	2.49
2258	34.2BN	3/4" x 2"	2.23
2259	34.212BN	3/4" x 2-1/2"	2.79
2260	34.3BN	3/4" x 3"	2.44
2261	34.312BN	3/4" x 3-1/2"	3.44
2262	34.4BN	3/4" x 4"	3.44

**Piping**

**Black Nipples (Continued)**

Prod ID#	CSI#	Size	Price
2263	34.412BN	3/4" x 4-1/2"	4.39
2264	34.5BN	3/4" x 5"	4.39
2265	34.512BN	3/4" x 5-1/2"	4.92
2266	34.6BN	3/4" x 6"	4.92
79007	34.7BN	3/4" x 7"	6.53
25913	34.8BN	3/4" x 8"	7.95
79008	34.9BN	3/4" x 9"	7.58
25914	34.10BN	3/4" x 10"	9.55
79009	34.11BN	3/4" x 11"	7.65
2267	34.12BN	3/4" x 12"	10.28
79010	34.18BN	3/4" x 18"	15.30
2255	34B66P	3/4", 66 Pack	160.66
2268	1CBN	1" x Close	3.34
2269	1.2BN	1" x 2"	3.68
2270	1.212BN	1" x 2-1/2"	3.86
2271	1.3BN	1" x 3"	3.86
2272	1.312BN	1" x 3-1/2"	4.80
2273	1.4BN	1" x 4"	4.80
2274	1.412BN	1" x 4-1/2"	5.69
2275	1.5BN	1" x 5"	5.87
2276	1.512BN	1" x 5-1/2"	6.76
2277	1.6BN	1" x 6"	7.38
70266	1.8BN	1" x 8"	12.01
70267	1.10BN	1" x 10"	14.07
70268	1.12BN	1" x 12"	16.12
77317	1.18BN	1" x 18"	25.25
77318	1.24BN	1" x 24"	33.00
75357	1.30BN	1" x 30"	29.13
75358	1.36BN	1" x 36"	35.12
75359	1.48BN	1" x 48"	44.78
75360	1.60BN	1" x 60"	41.36
22831	1B66P	1", 66 Pack	206.56
64133	114CBN	1-1/4" x Close	4.21
64134	114.2BN	1-1/4" x 2"	4.80
64135	114.212BN	1-1/4" x 2-1/2"	5.10
64136	114.3BN	1-1/4" x 3"	5.10
64137	114.312BN	1-1/4" x 3-1/2"	6.05
64138	114.4BN	1-1/4" x 4"	6.05
64139	114.412BN	1-1/4" x 4-1/2"	7.22
64140	114.5BN	1-1/4" x 5"	7.22
64141	114.512BN	1-1/4" x 5-1/2"	8.58
26562	114.6BN	1-1/4" x 6"	8.58
66100	114.12BN	1-1/4" x 12"	16.79

**TracPipe**  
Flexible Gas Piping by Omega Flex

**Counterstrike® Flexible Gas Piping**

- For enhanced lightning protection
- Corrugated stainless steel with polymer jacket



Prod ID#	CSI#	Size	Length	Price
65787	FGP-CS-375-100	3/8"	100'	505.29
79332	FGP-CS-500-25	1/2"	25'	184.82
65935	FGP-CS-500-50	1/2"	50'	324.52
63283	FGP-CS-500-100	1/2"	100'	578.53
65936	FGP-CS-500-250	1/2"	250'	1446.33
79333	FGP-CS-750-25	3/4"	25'	250.14
66775	FGP-CS-750-50	3/4"	50'	422.74
64896	FGP-CS-750-100	3/4"	100'	752.18
65937	FGP-CS-750-250	3/4"	250'	1880.45
79334	FGP-CS-100-25	1"	25'	344.23
66774	FGP-CS-100-50	1"	50'	604.24
58470	FGP-CS-100-180	1"	180'	1932.81
69512	FGP-CS-1250	1 1/4"	100'	1313.92

**Sold Per Foot**

Prod ID#	CSI#	Size	Price
65911	12CSPF	1/2" Counterstrike	12.48
65912	34CSPF	3/4" Counterstrike	14.83
65938	1CSPF	1" Counterstrike	21.66

**AutoFlare® Fittings & Accessories**

**Auto Snap Flare Fittings**

- Fittings for TracPipe
- Auto Snap Flare



Prod ID#	CSI#	Size	Price
69683	FGP-SFST-500	1/2"	33.88
70051	FGP-SFST-750	3/4"	46.15
70022	FGP-SFST-1000	1"	71.32
70160	FGP-SFST-1250	1-1/4"	158.24

Piping

**Piping**

Piping

**Auto Flare Fittings**

- Fittings for TracPipe
- Auto Flare



Prod ID#	CSI#	Size	Price
65790	FGP-FST-375	3/8"	32.26
34719	FGP-FST-500	1/2"	39.64
34722	FGP-FST-750	3/4"	54.25
34725	FGP-FST-1000	1"	83.46

**Split Rings**

Prod ID#	CSI#	Size	Price
35402	12SR	1/2"	3.27
35404	1SR (FGP-RING-SIZE1)	1"	4.18

**Outlet Couplings**

- Brass coupling fitting AutoFlare insert



Prod ID#	CSI#	Size	Price
35405	12BC (FGPCPLG500)	1/2"	73.82

**Flange Mount Fittings**

- Brass fitting AutoFlare insert



Prod ID#	CSI#	Size	Price
67235	FGP-BFF-375	3/8"	59.84
34721	FGP-BFF-500	1/2"	50.70
34723	FGP-BFF-750	3/4"	70.57
34724	FGP-BFF-1000	1"	88.07

**TracPipe® Protection Devices**

**Striker Plates**

- Hardened carbon steel

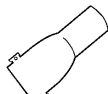
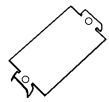

Quarter

Half

Full

Prod ID#	CSI#	Size	Description	Price
34726	QSP (FGP-SP-025)	3" x 2"	Quarter	3.42
34727	HSP (FGP-SP-050)	3" x 7"	Half	6.77
34728	FSP (FGP-SP-100)	3" x 12"	Full	14.02

**TracPipe® Accessories & Tools**

**Black Tape**

Prod ID#	CSI#	Size	Price
58804	FGP-9185-10H12BL	1" x 12 yds	73.31

**Metal Wallbox w/valve**

- 1/2" Valve



Prod ID#	CSI#	Size	Price
71162	FGP-WBTM-500	Metal Wallbox w/ valve	121.98

**Termination Mount**

- Fitting between TracPip Tubing and NPT thread.
- Fitting thread is male NPT
- Indoor, Outdoor or concealed



Prod ID#	CSI#	Size	Price
75564	FGP-TM-500	1/2" Termination Mount	57.16

**Order on-line when it's convenient  
for you-[www.CalverleySupply.com](http://www.CalverleySupply.com)**

**Piping**

**PVC Type 1120 Pressure Pipe  
PVC1120 SDR-21 Plain End**

- ASTM D-2241



Prod ID#	CSI#	Nom Pipe Size	Price
2744	12.10PVCP	1/2" x 10'	13.10
2745	34.10PVCP	3/4" x 10'	9.90

**PVC1120 Sch 40 Pressure Pipe (NSF-pw)**

- ASTM D1785

**PVC Sch 40 Plain End**

Prod ID#	CSI#	Nom Pipe Size	Price
46478	1.10PVCP	1" x 10' PVC Pipe	14.98

**PVC DWV Schedule 40 Pipe**

- Plain End



Prod ID#	CSI#	Size	Price
2746	2.10PVCP	2" x 10'	26.03
2747	212.10PVCP	2-1/2" x 10'	41.20
2748	3.10PVCP	3" x 10'	48.69

**All-Flash® No-Calk® Roof  
Flashings/Thermoplastic Base**

- Patented All-Flash® design allows use on multiple pipe sizes.
- Thermoplastic base.
- Rated 180°F continuous heat and approved for Type B installations.
- Plastic base for pitch from 0-45°.
- Self-sealing collar slides over pipe and requires no caulking.
- Do not use petroleum based products or paint on flashing collar or plastic base. Not for hot-mopped or built-up roofs.



Prod ID#	CSI#	Size	Price
72293	11919	1-1/2"-3" Thermoplastic NCF	11.17
72294	11920	3" - 4" Thermoplastic NCF	22.47

**No-Calk® Roof Flashing  
Galvanized Base**



- Slides over pipe - for pitch to 40°
- Rustproof, stamped galvanized
- Non-fading sealing collar
- Rated 180°F continuous heat
- Approved for Type B installations
- Not for hot-mopped or built-up roofs
- Do not use petroleum based products on collars

**Standard Base Flashing**

Prod ID#	CSI#	Size	Price
2351	11853	2" Galvanized	16.51
2353	11866	3" Galvanized	22.66

**PVC DWV Foam Core Non-Pressure Pipe -  
Sch 40**

- Cellular core
- Plain end



Prod ID#	CSI#	Size	Price
38494	2.10PVCFCP	2" x 10'	18.61
38495	3.10PVCFCP	3" x 10'	35.43

**PVC Sch 40 Fittings  
PVC Tees (SOC)**



Prod ID#	CSI#	Size	Price
3606	12PVCT (401-005)	1/2"	1.07
3619	34PVCT (401-007)	3/4"	0.84
7436	2PVCT (D400-020)	2"	8.91

**PVC Reducing Tees (SOC)**



Prod ID#	CSI#	Size	Price
64246	34.34.12FPVCT (402-101)	3/4" x 3/4" x 1/2"	1.55
35977	2.2.34FPTP (402-248)	2" x 2 x 3/4"	8.18
35978	3.3.34FPTP (402-334)	3" x 3 x 3/4"	23.32

**PVC Clean Out Tee W/Plug**



Prod ID#	CSI#	Description	Price
67299	H403-007	3/4" Cleanout Tee W/Plug	6.30

Piping

**Piping**

Piping

**PVC 90° Elbows (SOC)**



Prod ID#	CSI#	Size	Price
3602	12PVC90 (406-005)	1/2"	0.83
3616	34PVC90 (406-007)	3/4"	0.69
46479	1PVC90 (406-010)	1"	1.61
2749	2PVC90 (D300-020)	2"	5.33
2750	212PVC90 (406-025)	2-1/2"	11.24
2751	3PVC90 (D300-030)	3"	15.82

**PVC Long Sweep 90° Elbows (SOC)**



Prod ID#	CSI#	Size	Price
24445	2PVCLS90 (D304-020)	2"	8.81
39937	3PVCLS90 (D304-030)	3"	20.36

**PVC 90° Long Sweep Street Elbows (SPG x SOC)**



Prod ID#	CSI#	Size	Price
74077	2PVCLSST90 (D309-020)	2"	14.69

**PVC 90° Elbows (FIP x SOC)**



Prod ID#	CSI#	Size	Price
3612	34FPT.34SPVC90(407-007)	3/4"	1.20

**PVC Reducing 90° Elbows (FIP x SOC)**



Prod ID#	CSI#	Size	Price
3604	34FPT.12SPVC90(407-074)	3/4" x 1/2"	2.11

**PVC 90° Street Elbows (SPG x SOC)**



Prod ID#	CSI#	Size	Price
3608	12PVCST90 (409-005)	1/2"	2.17
3620	34PVCST90 (409-007)	3/4"	2.01
44529	1PVCST90 (409-010)	1"	4.09
2758	2PVCST90 (D302-020)	2"	6.79
2759	3PVCST90 (D302-030)	3"	18.95

**PVC 90° Elbows (MIP x SOC)**



Prod ID#	CSI#	Size	Price
15860	34MPT.34SPVC90 (410-007)	3/4"	1.53

**PVC 45° Elbows (SOC)**



Prod ID#	CSI#	Size	Price
3603	12PVC45 (417-005)	1/2"	1.34
3617	34PVC45 (417-007)	3/4"	1.49
2752	2PVC45 (D321-020)	2"	4.97
2753	212PVC45 (417-025)	2-1/2"	11.44
2754	3PVC45 (D321-030)	3"	14.22

**PVC 45° Street Elbows (SPG x SOC)**



Prod ID#	CSI#	Size	Price
2760	2PVCST45 (D323-020)	2"	5.11
3018	3PVCST45 (D323-030)	3"	13.43

**PVC Couplings (SOC)**



Prod ID#	CSI#	Size	Price
3621	12PVCCPG (429-005)	1/2"	0.59
3618	34PVCCPG (429-007)	3/4"	0.59
46482	1PVCCPG (429-010)	1"	1.32
2755	2PVCCPG (D100-020)	2"	2.22
2756	212PVCCPG (429-025)	2-1/2"	4.20
2757	3PVCCPG (D100-030)	3"	7.68

**PVC Deep Socket Couplings**



Prod ID#	CSI#	Size	Price
71629	2PVCDSCPG (428-020)	2"	5.80

**PVC Reducer Couplings (SOC)**



Prod ID#	CSI#	Size	Price
45435	34.12PVCREDCPG (429-101)	3/4" x 1/2"	1.43
3023	3.2PVCCPG (D102-338)	3" x 2"	11.16

**Piping**

**PVC Adapters (SOC x FIP)**



Prod ID#	CSI#	Size	Price
3609	34FPT.34SPVCA (435-007)	3/4"	0.85

**PVC Adapters (MIP x SOC)**



Prod ID#	CSI#	Size	Price
57138	12MPT.12PVCA (436-005)	1/2"	0.58
3610	34MPT.34SPVCA (436-007)	3/4"	0.63
44530	1MPTAPVC (436-010)	1"	1.52

**PVC Reducing Adapters (MIP x SOC)**



Prod ID#	CSI#	Size	Price
3623	34MPT.12SPVCA (436-101)	3/4" x 1/2"	1.15

**PVC Flush Style Reducer Bushings (SPG x SOC)**



Prod ID#	CSI#	Size	Price
3613	34.12SPVCBU (437-101)	3/4" x 1/2"	0.70
3020	212.2PVCBU (437-292)	2-1/2" x 2"	4.24
3021	3.2PVCBU (D107-338)	3" x 2"	8.00

**PVC Caps (SOC)**



Prod ID#	CSI#	Size	Price
23311	34PVCSCAP (447-007)	3/4"	0.68

**PVC Caps (FIP)**



Prod ID#	CSI#	Size	Price
24444	34PVCFPTCAP (448-007)	3/4"	1.33

**PVC Plugs (MIP)**



Prod ID#	CSI#	Size	Price
39163	34MPTPVCP (450-007)	3/4"	2.02

**PVC Schedule 40 Pressure Fittings Traps (Slip x Slip)**



Prod ID#	CSI#	Description	Price
3614	5-408	3/4" "P" Trap	4.00
27603	5-409	3/4" Running Trap	4.38
44527	5-411/BRA16082	1" Schedule 40 PVC P-Trap	6.78

**CPVC Pipe - Potable Water CPVC CTS Pipe**



Prod ID#	CSI#	Size	Price
3381	12.10CPVCP	1/2" x 10' Length	11.56
3382	34.10CPVCP	3/4" x 10' Length	28.25

**CPVC Fittings CPVC Couplings (Slip x Slip)**



Prod ID#	CSI#	Size	Price
3387	12CPVCCPG	1/2"	0.62
79373	1CPVCCPG	1"	3.90

**CPVC 90° Elbows (Slip x Slip)**



Prod ID#	CSI#	Size	Price
3383	12CPVC90	1/2"	0.71
3384	34CPVC90	3/4"	1.25
79371	1CPVC90	1"	3.94

**CPVC Tees (Slip x Slip x Slip)**



Prod ID#	CSI#	Size	Price
3389	12CPVCT	1/2"	0.73
3390	34CPVCT	3/4"	1.84
79375	1CPVCT	1"	7.88

Fittings

Piping

**SharkBite® Push-Fit Fittings**

- Easy to join any combination of copper, pex, CPVC, PE-RT, or SRD9 HDPE pipe together
- No soldering, clamps, unions or glue required
- Rated up to 200 PSI
- Rated up to 200° F
- Approvals: ASSE 1061, SDAB125.3 NSF/ANSI 372-2010, NSF/ANSI61



**SharkBite® Ball Valves**

- High quality forged brass

Prod ID#	CSI#	Size	Price
62132	22222-0000LF	1/2"	36.29
62133	22185-0000LF	3/4"	45.20

**SharkBite® Push-Fit Straight Couplings**



Prod ID#	CSI#	Size	Price
62026	U008LF	1/2" x 1/2"	16.93
62027	U016LF	3/4" x 3/4"	20.22

**SharkBite® Push-Fit Reducing Couplings**



Prod ID#	CSI#	Size	Price
62028	U058LF	3/4" x 1/2"	20.22

**SharkBite® Push-Fit Straight Connectors**



Prod ID#	CSI#	Size	Price
62029	U072LF	1/2" x 1/2" FNPT	13.63
62030	U088	3/4" x 3/4" FNPT	16.33
62031	U120LF	1/2" x 1/2" MNPT	13.63
62032	U134LF	3/4" x 3/4" MNPT	16.33

**SharkBite® Push-Fit Elbows**



Prod ID#	CSI#	Size	Price
62033	U248LF	1/2" x 1/2"	18.43
62034	U256LF	3/4" x 3/4"	23.22

**SharkBite® Slip Couplings**



Prod ID#	CSI#	Size	Price
62043	U3008LF	1/2"	27.32
62044	U3016LF	3/4"	31.50

**SharkBite® Push-Fit Tees**



Prod ID#	CSI#	Size	Price
62035	U362LF	1/2" x 1/2" x 1/2"	23.28
62036	U370LF	3/4" x 3/4" x 3/4"	29.48
62264	U412LF	3/4" x 3/4" x 1/2"	28.08

**SharkBite® Slip Tees**



Prod ID#	CSI#	Size	Price
62045	U3482LF	1/2" x 1/2" x 1/2" FNPT	40.99
62164	U3486LF	3/4" x 3/4" x 3/4" FNPT	48.18

**SharkBite® Push-Fit End Stops**

- Disconnecting clip sold separately



Prod ID#	CSI#	Size	Price
62037	U514LF	1/2"	15.43
62038	U518LF	3/4"	18.13

**SharkBite® Tee Stop**

- Allows the user to tap into existing supply lines to add fixtures and appliances with the speed and convenience of push-fit connections to the final phase of plumbing projects.
- Can be used on Copper, CPVC, PEX and PE-RT.



Prod ID#	CSI#	Size	Price
72266	24983	1/2"x1/2"x1/4" Comp Tee Stop	45.20
72267	24985	3/4"x3/4"x1/4" Comp Tee Stop	49.99

**SharkBite® Disconnect Clips**

- For fast disassembly of installed fittings



Prod ID#	CSI#	Size	Price
62039	U710	1/2"	3.60
62040	U712	3/4"	3.60



**Fittings**

**SharkBite® Push-Fit Water Hammer Arrestors**

- No soldering, clamps, unions or glue required
- Horizontal or Vertical Installation
- Water tight joint



Prod ID#	CSI#	Size	Price
64006	22630LF	1/2"	76.40

**SharkBite® Water Heater Kits**

- Features push-fit fittings
- Fittings certified to 200 psi & 200°F
- Fits copper tubing, CTS, CPVC & PEX
- Includes (2) adapters & (1) demount clip



Prod ID#	CSI#	Size	Price
62041	22604LF	1/2" x 3/4" FNPT	34.51
62042	22441LF	3/4" x 3/4" FNPT	32.87

**SharkBite® Flexible Water Heater Connectors**

- Stainless steel braided
- U3088FLEX18BVLF includes Ball Valve



Prod ID#	CSI#	Size	Price
62046	U3088FLEX18 LF	3/4" x 18"	37.66
64120	U3088FLEX18 BVLF	3/4" x 3/4" FIP x 18"	78.07

**Tank Booster™ Pro**

- Easy add-on water heater access.
- Increases usable hot water
- Reduces the risk of Legionella bacteria.



Prod ID#	CSI#	Size	Price
78533	24644	3/4" Water Htr Mixing Valve	287.62

**Aluminum Tubing Pilot Kit**



Prod ID#	CSI#	Size	Price
77303	S1-11-293	1/4" x 5' Alum Pilot Kit	41.45

**Type M Copper - Color Code Red**

**Type M Hard Red Straight Lengths**

**Type M Hard Red - 10' Lengths**



Prod ID#	CSI#	Size	Price
3583	58OD.10CT	5/8"OD x 10' Cop Pipe (1/2"Nom)	29.47
3584	78OD.10CT	7/8"OD x 10' Cop Pipe (3/4"Nom)	46.46

**Type M Copper - Red - 10' Lengths**



Prod ID#	CSI#	Size	Price
61323	11ID.10CP	1" ID x 10" Cop Pipe (7/8"Nom)	56.62
61322	114ID.10CP	1 1/4" ID x 10' Cop Pipe (1"Nom)	82.34

**A/C Refrigeration Copper Tubing - Blue**

**Refrigeration Tubing Blue Coils**

**Refrigeration ASTM B280 - 50' Coils**



Prod ID#	CSI#	Size	Price
3585	14OD.50CT	1/4"OD x 50' Refrig Tubing	71.48
3586	38OD.50CT	3/8"OD x 50' Refrig Tubing	105.43
3587	12OD.50CT	1/2"OD x 50' Refrig Tubing	150.10

**Copper Flare Nuts & Unions**

Prod ID#	CSI#	Size	Price
67682	ANS4C	1/4" Forged Flare Nut	3.18
67683	ANS4E	3/8" Forged Flare Nut	3.18
67686	ANS4F	1/2" Forged Flare Nut	4.33
67679	DU2-4	1/4" OD Flare Union	3.89
67680	A42E	3/8" OD Flare Union	4.17
67681	A42F	1/2" OD Flare Union	6.39

Piping

**Piping**

Piping

**ZurnPEX Non-Barrier Tubing & Accessories**

- Cross-Linked high density polyethylene
- ASTM F876/F877 & CSA B137.5
- Use for hot and cold water distribution



Prod ID#	CSI#	Size	Price
74823	Q0PC50	1/4"OD x 50' Pex Tubing	39.44
74824	QBF0	1/4" OD Pex Ferrule (100pk)	57.78



**Copper Wrot Pressure Fittings  
Wrot Adapters (C x MIP)**



Prod ID#	CSI#	Size	Price
3795	12CMIPA	1/2" (5/8" OD)	3.61
3796	34CMIPA	3/4" (7/8" OD)	5.49

**Wrot Flush Bushings (FTG x C)**



Prod ID#	CSI#	Size	Price
30525	78.34ODCREDBU	3/4" x 5/8" (7/8" x 3/4" OD)	7.68

**Wrot Flush Bushings (FTG x FIP)**

- Baseboard vent bushing



Prod ID#	CSI#	Size	Price
3568	12.18CBVBU	1/2" x 1/8"	12.58

**Wrot Reducing Couplings (C x C)**



Prod ID#	CSI#	Size	Price
3807	78.58ODCREDCPG	3/4" x 1/2" (7/8" x 5/8" OD)	4.87
3806	34.58ODCREDCPG	5/8" x 1/2" (3/4" x 5/8" OD)	4.22
3808	78.34ODCREDCPG	3/4" x 5/8" (7/8" x 3/4" OD)	5.07
41826	118.78ODCREDCPG	1" x 3/4" (1-1/8" x 7/8" OD)	8.27

**Wrot Couplings - w/o Stops (C x C)**



Prod ID#	CSI#	Size	Price
3799	14ODCCPG	1/8" (1/4" OD)	1.53
3801	38ODCCPG	1/4" (3/8" OD)	0.94
4577	12ODCCPG	3/8" (1/2" OD)	1.28
3802	58ODCCPG	1/2" (5/8" OD)	1.48
3803	34ODCCPG	5/8" (3/4" OD)	2.56
3804	78ODCCPG	3/4" (7/8" OD)	2.56
40605	118ODCCPG	1" (1-1/8" OD)	6.64

**Wrot 45° Elbows (C x C)**



Prod ID#	CSI#	Size	Price
3626	58ODC45	1/2" (5/8" OD)	5.12
4098	34ODC45	5/8" (3/4" OD)	4.94
3627	78ODC45	3/4" (7/8" OD)	5.35
51517	118ODC45	1-1/8" OD Copper 45	11.52

**Wrot 45° Street Elbows (FTG x C)**



Prod ID#	CSI#	Size	Price
3631	58ODCST45	1/2" (5/8" OD)	4.09
27126	34ODCST45	5/8" (3/4" OD)	5.12
3632	78ODCST45	3/4" (7/8" OD)	5.39
52815	118ODCST45	1-1/8" OD Cop St 45	13.09

**Wrot 90° Close Rough Elbows (C x C)**



Prod ID#	CSI#	Size	Price
6309	38ODCSR90	1/4" (3/8" OD)	3.10
3624	58ODCSR90	1/2" (5/8" OD)	1.67
4576	34ODCSR90	5/8" (3/4" OD)	4.87
3625	78ODCSR90	3/4" (7/8" OD)	5.12

**Piping**

**Wrot 90° Close Rough Street Elbows (FTG x C)**



Prod ID#	CSI#	Size	Price
3633	58ODCSRST90	1/2" (5/8" OD)	3.35
4099	34ODCSRST90	5/8" (3/4" OD)	7.19
3634	78ODCSRST90	3/4" (7/8" OD)	7.24

**Wrot 90° Long Radius Elbows (C x C)**



Prod ID#	CSI#	Size	Price
3811	38ODCLT90	1/4" (3/8" OD)	2.83
3813	58ODCLT90	1/2" (5/8" OD)	3.73
3814	34ODCLT90	5/8" (3/4" OD)	5.05
3815	78ODCLT90	3/4" (7/8" OD)	7.20
40603	118ODCLT90	1" (1-1/8" OD)	14.72

**Wrot 90° Long Radius Street Elb (FTG x C)**



Prod ID#	CSI#	Size	Price
22940	38ODCLTST90	1/4" (3/8" OD)	3.20
40598	58ODCLTST90	1/2" (5/8" OD)	4.39
3816	34ODCLTST90	5/8" (3/4" OD)	6.82
3817	78ODCLTST90	3/4" (7/8" OD)	9.35
50884	118ODCLTST90	1" (1-1/8" OD)	16.72

**Wrot Tees (C x C x C)**



Prod ID#	CSI#	Size	Price
3637	78.78.58ODCT	3/4" x 1/2" (7/8" x 5/8" OD)	6.92

**Wrot P-Traps**



Prod ID#	CSI#	Size	Price
76957	34ODCPT N-61008	5/8" (3/4" OD)	52.48
76048	78ODCPT N-61000	3/4" (7/8" OD)	39.16

**LEGEND VALVE**

**Wrot Copper Press Fittings  
Wrot Copper 90° Elbow (Press)**



Part #	Mfg #	Size	Price
78392	450-003P	1/2"	4.84
77976	450-084P	3/4"	8.28

**Wrot Copper 90° Street Elbow (P x Ftg)**



Part #	Mfg #	Size	Price
78389	450-043P	1/2"	5.05
78384	450-094P	3/4"	8.16

**Wrot Copper 45° Elbow (Press)**



Part #	Mfg #	Size	Price
78457	450-023P	1/2"	5.35
77977	450-024P	3/4"	6.57

**Wrot Copper 45° Street Elbow (P x Ftg)**



Part #	Mfg #	Size	Price
78458	450-063P	1/2"	4.14
78452	450-064P	3/4"	6.13

**Wrot Copper Adapter (P x MNPT)**



Part #	Mfg #	Size	Price
78459	450-753P	1/2"	5.41
77979	450-754P	3/4"	9.75

Piping

## Copper Press Fittings

Piping

### Wrot Copper Adapter (P x FNPT)



Part #	Mfg #	Size	Price
78388	450-703P	1/2"	6.52
77980	450-704P	3/4"	15.59

### Forged Brass Full Port Ball Valve

- 1/8" T-1001 No Lead
- Maintenance free dual O-ring stem seal
- Press Fit



Part #	Mfg #	Size	Price
78391	101-003NL	1/2"	22.67
77978	101-004NL	3/4"	31.23

### AGA L.H. Gas Ball Valves

- Heavy duty forged brass gas cock
- For use w/natural, manufactured, mixed liquified petroleum and LP-gas/air mixture
- Meets CSA, US AGA 3-88 CSA



Prod ID#	CSI#	Description	Price
3540	12BGC (300593)	1/2" IPS 2 Piece	8.40
3541	34BGC (300594)	3/4" IPS 2 Piece	11.79
3542	1BGC (102-905)	1" IPS 2 Piece	26.27

### Ball Valves

#### Forged Brass Ball Valves - No Lead

- FM approved
- CSA certified to 61-8 ANSI/NSF
- UL listed



Prod ID#	CSI#	Description	Price
51203	101-044NL	3/4" C x C No Lead	28.05
75505	101-024NL	3/4" FNPT X FNPT No Lead	25.30

### Specialty Products

#### Log Lighter Valves

- AFA, CGA certified
- Forged brass body
- Chrome plated brass body
- High BTU capacity
- Soft seals
- CSA certified to ANSI Z21.15



Prod ID#	CSI#	Description	Price
23587	T3200PB (102-804)	1/2" Straight Pattern	76.83
23588	T3201PB (102-814)	1/2" Angle Pattern	73.77
24485	(102-827)	10" Brass Key f/Log Lighter Valves	25.68

### Dielectric Fittings

#### T-575 Dielectric Nipples



Prod ID#	CSI#	Description	Price
55587	301-503	3/4" x 3" Dielectric Nipple	5.78

### Insulated Tubing

- Aerocel tubing insulation
- Outstanding ultraviolet & moisture resistance



Prod ID#	CSI#	Description	Price
3012	34.6IT	3/4" x 6'	23.11
3013	78.6IT	7/8" x 6'	23.97
64192	218.6IT	2-1/8" x 6'	19.26
3016	258.6IT	2-5/8" x 6'	60.86
64194	318.6IT	3-1/8" x 6'	29.96
64414	358.6IT	3-5/8" x 6'	82.18

### Brass Compression Fittings

#### Brass Compression Nuts



Prod ID#	CSI#	Size	Price
3558	14CN	1/4"	1.72

#### Brass Compression Sleeves



Prod ID#	CSI#	Size	Price
3559	14CS	1/4"	0.45

**Piping**

**Misc. Piping Fittings**

**Miscellaneous Items**

Prod ID#	CSI#	Size	Price
2106	38BC	3/8" Beam Clamps	3.06
23883	102-837	1/2" Drip Leg Hook-Up Kit	31.10
61350	107-143	1/2" Boiler Drain	9.42
3550	107-144	3/4" Boiler Drain	11.28
3785	14LN	1/4" Breakaway Nut	5.86
4121	301-104NL	3/4" Dielectric Union	15.25

**Valves**

Prod ID#	CSI#	Size	Price
304	AV135CA	1/4" Comp x 1/8" MIPS Water Valve	16.41
598	NCLX-5 (15836-0150)	3/4" x 6" T&P Valve	36.85

**Prices in this catalog are subject to change without notice. Please call us for a quote - Quantity pricing is available.**

**Proudly Serving You  
from 7 Convenient  
Michigan Locations**



**Almont**

**Grand Rapids**

**Lansing**

**Livonia**

**Saginaw**

**Sterling Heights**

**Waterford**

Piping

**Special Order**

Piping



**Fire Dampers, Radiation Dampers**



**FanTech Residential in-line fans, ceiling, duct mounted, roof mounted etc.**

**HEAT CONTROLLER, INC.**  
Heatcontroller.com

**Packaged Terminal Units(PTAC), Portable Coolers, Packaged  
Wall Mounted Units, Geothermal**



**Heat Transfer Products Boilers & Parts**



**Linesets Inc - Made to Order Any Length**



**Lloyd Smoke & Fire Dampers**



**Concentric Diffusers, curbs, mixing boxes, supports, etc.**



**Mortex - Hydronic Coils & Custom Commercial Coils**



**Make Up Aurs, Direct/Indirect Fired**



**Reznor Special Order Parts**



**Commercial ERV's, Economizers, & Concentric Diffusers**

*Curb Adaptors* – Made to fit exactly over existing curb.

*Custom Aluminum Commercial Registers and Diffusers* – White or Brushed Aluminum – Multi-shutter or Opposed Blade Dampers

*Custom made Galvanized Fittings and Boots* – Plenums, Return Air Drops, Insulated and Non- Insulated Duct etc.

*ERV's & HRV's* - Available from GeneralAire, Honeywell, Lifebreath, & Broan

*Spiral Galvanized Duct and Fittings* - ordered to the Job Specifications.

*Custom made Filters - Made to Size - 1", 2" or 4" - several different merv ratings available*

*Custom made Air Conditioner Covers for winter storage*

**Tapes, Sealants & Adhesives**

**Polyethylene-Coated Cloth (Duct) Tapes**

**223 Multi-Purpose Duct Tapes**

- Good tensile strength, adhesion & tack
- Conformable & will not twist or curl during application
- Complies with UL723



Prod ID#	CSI#	Size	Color	Price
3245	2232.60BDT (681183)	2" x 60 yd	Black	32.26
3244	2232.60SDT (682814)	2" x 60 yd	Silver	30.93

**229 Multi-Purpose Duct Tapes**

- Heavy-duty contractor grade
- Excellent on flex duct, seal duct work, general purpose pkg, hold down fiberglass insulation, condensation barrier in refrigeration
- Specially formulated pressure sensitive adhesive
- Excellent tensile strength, adhesion, & tack properties
- PE coated cloth, rubber adhesive



Prod ID#	CSI#	Size	Color	Price
3247	2292.60SDT (682749)	2" x 60 yd	Silver	30.51

**555 Premium Film Flex Tape - UL181B-FX**

- Printed for easy identification
- Ideal for heating, air conditioning, ventilating, and refrigeration applications
- Aggressive natural rubber adhesive
- Excellent adhesion & shear performance
- All-weather
- UL 181B-FX listed



Prod ID#	CSI#	Size	Color	Price
66625	5552.120ULFTB	2" x 120 yd	Black	38.31
75795	5552.120ULFTM	2" x 120 yd	Metal	31.83
66626	5553.120ULFTM	3" x 120 yd	Metal	62.73

**557 Premium Duct Tape - UL181B-FX**

- Printed for easy identification
- Ideal for heating, air conditioning, ventilating, and refrigeration applications
- Aggressive natural rubber adhesive
- Excellent adhesion & shear performance
- All-weather
- UL 181B-FX listed



Prod ID#	CSI#	Size	Color	Price
27990	5572.60FDT (557000A)	2" x 60 yd	Silver	45.13

**Foil Tapes**

**337 Premium Foil Tapes**

- 2 mil, dead-soft aluminum foil backing for pre-formed aluminum foil-faced duct systems
- High adhesion, quick stick
- Matches most foil laminated duct work
- Tested in accordance w/UL 723
- For use over a wide temperature range



Prod ID#	CSI#	Size	Color	Price
3250	337212.50AT (651412)	2-1/2" x 50 yd	Aluminum	31.95

**338 Foil/Scrim/Kraft Tapes**

- Seal & patch FSK ductboards & blankets
- Diamond pattern ductboard tape
- Tear resistant
- Provides excellent adhesion to substrate over wide temperature range
- Extra strength seal to maintain vapor barrier integrity
- Tested in accordance w/UL723



Prod ID#	CSI#	Size	Color	Price
3251	3383.50FSKT (651416)	3" x 50 yd	Aluminum	41.76

**339 Premium Foil Tapes**

- Heavy duty, SMACNA ductboard tape
- Printed 2 mil, dead-soft aluminum foil backing for fiberglass duct systems (printed)
- UL181B-FX & UL 181-AP listed
- High performance acrylic adhesive
- Vapor barrier
- Instant adhesion/superior quick stick



Prod ID#	CSI#	Size	Color	Price
3252	339212.60ULFT (651997)	2-1/2" x 60 yd	Aluminum	53.78
3253	3393.60ULFT (652230)	3" x 60 yd	Aluminum	63.33

**2C120 - 3M™ Aluminum Foil Tape**

- Hand Tearable, Cold weather adhesive
- UL723 Classified (5/10 Flame / Smoke rating)
- UL S102 Classification (10/0 FLame / Smoke Rating)



Prod ID#	CSI#	Size	Color	Price
77628	2C120 - 3"	3" x 50 yd	Aluminum	31.38

Tapes & Sealants

**Tapes, Sealants & Adhesives**

Tapes & Sealants

**1581A 3M™ Aluminum Foil Tape**

- High Strength aluminum foil backing is ideal for rigid duct board and flexible duct
- High Temperature
- Rugged, durable and easy to use
- 72mm x 55m - 2.0 mil



Prod ID#	CSI#	Size	Color	Price
78105	1581A-3" - 3M	3" x 60 yd	Aluminum	59.73

**Industrial PE Film Tapes**

**827 Multi-purpose PE Film Tapes**

- Tough Polyethylene backed tape w/chemical resistant rubber adhesive
- Resists degradation from UV exposure
- For electroplate masking, splicing polyethylene, sealing packages, holding labels



Prod ID#	CSI#	Size	Color	Price
3254	827PCDT (675842)	2" x 108'	White	42.87



**Tape**

**Cork Insulation Tape**

- Black
- Adheres firmly to all metals
- Use on hot or cold pipes to stop condensation



Prod ID#	CSI#	Description	Price
3258	6-330	1/8" x 2" x 30' Roll (Black)	26.94

**Foam Insulation Tape**

- Black self-adhesive foam tape use on hot or cold pipes
- Fits well around valves & Ftgs



Prod ID#	CSI#	Description	Price
3259	2.30IT (69718)	1/8" x 2" x 30' Roll (Black)	17.02

**Construction Sealants**

**Expanding Foam Sealant**

- Easy-to-use, multi-purpose urethane foam
- Expands three times its original volume
- Adheres to all building materials except teflon®, silicone & polyethylene
- Uses include insulating, sealing & filling gaps around pipes, plumbing fixtures, ductwork & foundations



Prod ID#	CSI#	Description	Price
3353	01714	12 oz Aerosol Can	20.81



**EMC Teflon Tape**

- Meets MIL-Spec #MIL-T-27730A



Prod ID#	CSI#	Description	Price
3255	T1/2X1296B	1/2" x 1296"	4.09

**Economy Electrical Tape**

- Flame Retardant
- Cold weather resistant
- 7 Mil Vinyl
- U.L. listed



Prod ID#	CSI#	Description	Price
3256	A7 (13229)	3/4" x 60'	2.79



**Construction Sealants**

**Construction Silicone Sealant**

- Suitable for general heating, ventilation and air conditioning sealing and adhesive applications
- Will adhere to clean metal, glass, many types of wood, silicone resins, vulcanized silicone rubber, ceramics, and plastic surfaces
- Seals cracks or gaps around windows, vents, ducts, fixtures, and lights
- Seals leaks in gutters, downspouts, ducts, and piping
- Waterproofs electrical connections and boxes
- Bonds gaskets in heating and refrigeration units



Prod ID#	CSI#	Description	Price
3959	CSC10.1OZ	10.1 oz Clear	12.84
3960	WSC10.1OZ	10.1 oz White	12.84
4079	ASC10.1OZ	10.1 oz Aluminum	12.84



**Tapes, Sealants & Adhesives**

**BOSS® #125 Building/Construction Sealant**

- -35deg - 140Deg F Application Range
- Formulated to offer outstanding primerless adhesion to most common building materials including vinyl, steel, concrete, wood and glass.
- Good UV resistance. Easy to use.



Prod ID#	CSI#	Description	Price
70511	12513	#125 Alum/Grey Cnst. Sealant	20.17
70512	12502	#125 Black Cnst. Sealant	20.17

**Draft/Smoke Sealants**

**BOSS® 812 Fire Block Foam**

- Used to seal around copper, PVC pipes, and conduits
- Prevents the spread of smoke and gasses
- Non-combustible, inorganic materials
- Passes ASTM E-814 (UL 1479)



Prod ID#	CSI#	Description	Price
56962	81212	12 oz Aerosol Can	28.55

**Firestop Sealants**

**BOSS® 814 Intumescent Latex Firestop Sealant**

- In the event of fire, expands to form insulating char that prevents the spread of fire
- Non-combustible, inorganic materials
- Passes ASTM E-814 (UL 1479)



Prod ID#	CSI#	Description	Price
44002	81410	10.1 fl oz Cartridge	28.84

**Fire Block Draft Stop Sealant**

- Prevents spread of fire, smoke and toxic gases
- Non-combustible, inorganic materials up to 1700°F
- Passes ASTM E-136, ASTM E-814(UL 1479)



Prod ID#	CSI#	Description	Price
45751	13605	Firestop/Draft Sealant	18.51

**Fireblock Foam & Gun**

- No Shrinkage once cured
- Seales out smoke and toxic gases
- Moisture resistant when cured
- Orange for easy inspection



Prod ID#	CSI#	Description	Price
65884	30181	24 oz Fire Block Foam	27.15
65885	61039	Intermediate Foam Gun	77.62

**Industrial Sealants and Adhesives**

**Hi-Temp Red Silicone Sealant**

- Provides protective coating where parts must perform up to 600°F
- Used in critical bonding, sealing, potting and encapsulating applications
- Paste grade acetoxo silicone



Prod ID#	CSI#	Description	Price
16131	RSC10.1OZ	10.1 oz Hi-Temp Red Silicone	19.44

**Caulking Guns**



Prod ID#	CSI#	Description	Price
3429	CD2	Caulking Gun, Blue	8.56

**Foam Gun Cleaner**

Prod ID#	CSI#	Description	Price
69988	10083	Foam Gun Cleaner	17.98



**Cements / Sealant**

**PVC Heavy Duty Cement**



Prod ID#	CSI#	Description	Price
66359	31008 OATEY	32 oz	37.30
70502	30876 OATEY	16 oz	25.32

Tapes & Sealants

**Tapes, Sealants & Adhesives**

Tapes & Sealants

**PVC Medium Clear Cement**

- Medium-bodied clear cement for use on PVC pipe & fittings up to 6" dia for Sch 40 & Sch 80 Recommended application temp 40°F to 110°F
- Recommended for all grades & types of PVC pipe & fittings, gas, conduit, drain, waste & vent pipe, pressure pipe & potable water
- Meets ASTM D-2564



Prod ID#	CSI#	Size	Price
3329	31017 OATEY	4 oz	10.28
3330	31018 OATEY	8 oz	14.42

**PVC All Weather Medium Clear Cement**

- Medium-bodied clear cement for use on PVC pipe & fittings up to 6" dia for Sch 40 & Sch 80 Recommended application temp -15°F to 110°F
- Recommended for all grades & types of PVC pipe & fittings, gas, conduit, drain, waste & vent pipe, pressure pipe & potable water
- Meets ASTM D-2564



Prod ID#	CSI#	Size	Price
73300	31132 OATEY	16oz.	22.39
72954	31133 OATEY	32oz.	34.65

**PVC Regular Clear Cement**

- Regular-bodied clear cement for use on PVC pipe & fittings up to 4" for DWV Sch 40 & up to 2" for Sch 80
- Recommended for all grades & types of PVC pipe & fittings, potable water, pressure pipe, gas, conduit & DWV
- Meets ASTM 0-2564



Prod ID#	CSI#	Size	Price
7341	31015 OATEY	32 oz	27.09

**PVC Heavy Duty Clear Cement - 16 oz.**

- Heavy Duty Clear cement for use on all schedules and classes PVC pipe and fitting up to 12" diameter with interference fit, up to 18" for non-pressure
- Thick formula fills gaps in large diameter pipe and loose fitting joints
- Recommended application temperature 40°F to 110°F / 4°C to 43°C



Prod ID#	CSI#	Size	Price
70502	30876 OATEY	16 oz	25.32

**Furnace Cement**

- Seals and repairs boilers, furnaces, flue pipes, stoves, ducts, kilns, chimneys & combustion chambers
- Can be used on oil, gas, coal, and wood-burning heating systems
- Adheres to most building materials
- Creates fireproof non-porous seal
- Contains no oils, asbestos, or crystalline silica
- Will not crack, shrink, or crumble



Prod ID#	CSI#	Size	Price
3357	35521/HT64	1/2 Gal	42.18
3358	35526/HT1	1 Gal	73.00

**Megaloc Thread Sealant**

- Made with DuPont Kevlar
- Wipes easily from hands and tools with dry rag
- No odor - no waiting - nonflammable
- High performing thread sealant
- Grit free high performing thread sealant
- -50° F to 400° F performance range



Prod ID#	CSI#	Size	Price
76155	15806	8 oz	29.85
75760	15808	16 oz	46.22

**Hercules MEGATAPE™**

- Contains PTFE for thick denser tape
- Use on threaded pipe containing oil, solvents, fluids, L.P. gas, Nat. gas, water etc
- Stainless Steel, PVC, CPVC, ABS, Cast Iron, Brass etc



Prod ID#	CSI#	Size	Price
71483	15100	1/2" x 1000' Megatape	7.97

***THANK YOU!***  
***We appreciate your business***

**Tapes, Sealants & Adhesives**

**Primers / Cleaners**

**Purple Primer - NSF Listed**

- Purple-tinted aggressive primer for use on PVC & CPVC pipe & fittings
- Removes surface dirt, grease & grime as well as softens pipe surface for fast, secure solvent weld
- For use when code calls for verification that a primer has been used
- Meets ASTM F-656



Prod ID#	CSI#	Size	Price
3332	30755	4 oz	10.97
3333	30756	8 oz	14.42
3334	30757	16 oz	21.76
7894	30758	32 oz	30.95

**Cleaner**

- Clear cleaner for ABS, PVC & CPVC pipe & fittings
- All schedules & all diameters
- Flows freely & evaporates quickly
- Fast removal of surface dirt, grease & grime



Prod ID#	CSI#	Size	Price
3335	30779	4 oz	9.44
3336	30782	8 oz	13.67
3337	30795	16 oz	23.48

**Pipe Compounds**

**Great White™ Pipe Joint Compound with Teflon®**

- Lubricates & seals all threaded joints
- White, non-hardening, non-separating, non-toxic paste
- Withstands up to 3,000 PSI on gases from -50 to +400°F & 10,000 PSI on liquids from -50 to +500°F
- For use with water, steam, or dilute acid lines of PVC, CPVC, ABS, cycolac, polypropylene, iron, steel or copper



Prod ID#	CSI#	Size	Price
3325	31230	4 oz	20.59
3326	31231	8 oz	27.93
3327	31232	16 oz	42.18



**Jomar Seal/Thread Sealant**

**Gimme the Green Stuff™**

- Non-toxic
- Will not dry out, stain, harden, or separate
- Wipes clean from hands
- Use on all metal, PVC, CPVC, nylon, & polypropylene threads
- Temp range: -50°F to 400°F
- Pressure range: gases to 3000 psi liquids to 6000 psi



Prod ID#	CSI#	Size	Price
49083	400-103	8 oz	26.71
49084	400-104	16 oz (1 pt)	41.75



**Wet-Stick Fibre Roof Coating**

**"Wet-Stick" - Wet/Dry Fibred Roof Coating**

- Designed for damp or wet surfaces
- Use on roofs such as metal, composition, concrete and canvas
- Remains pliable
- Non-Asbestos



Prod ID#	CSI#	Size	Price
3338	1GWFR(102-1)	1 Gal	31.59

**Pro Wet-Stick Flashing Cements**

**"Wet-Stick" - Wet/Dry Flashing Cement**

- Designed to be applied on damp or wet surfaces
- Use to repair most types of roof surfaces, such as metal or built-up
- Adheres to wood, felt, plastics, glass, concrete and all metals
- Non-Asbestos



Prod ID#	CSI#	Size	Price
3341	1GWPRC(252-1)	1 Gal	32.66
3342	5GWPRC (252-5)	5 Gal	106.02

Tapes & Sealants



**Tapes, Sealants & Adhesives**

**ProBrite 200 Aluminum Roof Coating**

- Fibred Aluminum Roof Coating
- 40-75 sq ft/gallon coverage
- High quality aluminum roof coating for industry, farms, mobile homes, etc
- Protects roofs from ultra-violet rays
- Non-asbestos fibered



Prod ID#	CSI#	Size	Price
3343	DEW3085	5 Gal	235.85

**High-Velocity Duct Sealer Sure Grip 404**

- Synthetic rubber duct sealant
- Non-Fiber
- Low viscosity, no-drip, no-string formulation allows fast application for labor savings and extended coverage for lower installed cost.
- Indoor/Outdoor UL 181-BM



Prod ID#	CSI#	Description	Price
71252	302009	1-Gal Sure Grip 404 Duct Seal	69.66
71253	302020	5-Gal Sure Grip 404 Duct Seal	396.41

**#99 Wet-Stick Roof Cement**

- Wet/Dry, Black Cement
- Durable, elastic and waterproof mastic
- Use on brick siding, sealing in roofs, gutters, glass, marble, stone, cement, metal roofs, stone coping, etc



Prod ID#	CSI#	Size	Price
3360	DEW99 (611-C)	10.5 oz Cartridge	6.92

**Duct Seal FlexGrip 550**

- All-Purpose industrial grade duct sealant
- Non-Fiber
- Use on Metal, Glass Fiber, Duct Board, Flex Duct
- Indoor/Outdoor UL 181-BM



Prod ID#	CSI#	Description	Price
67938	304132	1-Gal Flex Grip 550 Duct Seal	42.24

**Tools**

**Trowels**



Prod ID#	CSI#	Size	Price
3492	LTRWL	7-3/4"	13.21

**Zip Brushes**



Prod ID#	CSI#	Description	Price
3423	4601	Zip Brush	20.04

**Foil-Grip 1402 Tape**

- **Water Resistant**
- Works on sheet metal, Duct Board, Flex Duct, PVC coated duct and more



Prod ID#	CSI#	Description	Price
65595	304100	3"x100' 1402 Hardcast Tape	62.40

**40# Travel Tack**

- **Self contained portable spray system**
- Instant tacking
- "Web" spray pattern



Prod ID#	CSI#	Description	Price
67957	308602	40# Cylinder Travel Tack	542.49



**Duct Seal DS321-4**

- All-Purpose industrial grade duct sealant
- Fiber-reinforced
- Non-toxic
- Gray color
- Indoor/Outdoor UL 181-BM



Prod ID#	CSI#	Description	Price
46984	304156	1-Gal Duct Seal DS-321	42.24
65596	304159	11oz. Duct Seal DS-321	7.86

**Tapes, Sealants & Adhesives**

**Aerosol Adhesive**

- Adhesive for bonding insulation to metal
- Fast-tacking
- Non-flammable
- Amber color



Prod ID#	CSI#	Description	Price
19530	ASA-W (5015)	Convenient Spray-Can Adhesive	30.69

**SAS Water Based Duct Sealant**

- Siliconized acrylic
- For sealing joints in air handling systems
- Brush, trowel, putty knife or caulking gun method of application



Prod ID#	CSI#	Description	Color	Price
43010	SASUL1 #5027	1 gal	Grey	75.26

**Insulation Adhesives**

**WIT Water Based Insulation Adhesives**

- Resin emulsion
- Non Toxic / Solvent Free
- For bonding insulation to sheet metal
- Fast tack & water based adhesive
- Non-flammable wet or dry
- For spray equipment or roto bonder



Prod ID#	CSI#	Description	Color	Price
3349	WIT1 (5056)	1 gal	White	75.65
3350	WIT5 (5057)	5 gal	White	304.24

**RPG Water Based Insulation Adhesives**

- Synthetic elastomer rubber
- Spray, brush, or roller method of application
- Excellent tack & quick grab, for use with liner up to 3# density



Prod ID#	CSI#	Description	Color	Price
3346	RPG1 (5047)	1 gal Solvent	Red	85.27
3347	RPG5 (5048)	5 gal Solvent	Red	306.80

**Duct Sealers**

**SGD-1 Solvent Duct Sealer**

- Synthetic elastomer rubber
- Recommended for sealing joints in high pressure indoor air handling systems
- Brush, trowel, or power extrusion method of application



Prod ID#	CSI#	Description	Color	Price
3352	SGD1 #5044	1 gal	Grey	93.15
3351	SGDC #5046	Cartridge	Grey	16.69

**If you need a product not listed in this catalog, please check with us. We have not listed every product we can get for you.**

Tapes & Sealants

**Special Order**



**Fire Dampers, Radiation Dampers**



**FanTech Residential in-line fans, ceiling, duct mounted, roof mounted etc.**

**HEAT CONTROLLER, INC.**  
Heatcontroller.com

**Packaged Terminal Units(PTAC), Portable Coolers, Packaged  
Wall Mounted Units, Geothermal**



**Heat Transfer Products Boilers & Parts**



**Linesets Inc - Made to Order Any Length**



**Lloyd Smoke & Fire Dampers**



**Concentric Diffusers, curbs, mixing boxes, supports, etc.**



**Mortex - Hydronic Coils & Custom Commercial Coils**



**Make Up Airst, Direct/Indirect Fired**



**Reznor Special Order Parts**



**Commercial ERV's, Economizers, & Concentric Diffusers**

*Curb Adaptors – Made to fit exactly over existing curb.*

*Custom Aluminum Commercial Registers and Diffusers – White or Brushed Aluminum – Multi-shutter or Opposed Blade Dampers*

*Custom made Galvanized Fittings and Boots – Plenums, Return Air Drops, Insulated and Non- Insulated Duct etc.*

*ERV's & HRV's - Available from GeneralAire, Honeywell, Lifebreath, & Broan*

*Spiral Galvanized Duct and Fittings - ordered to the Job Specifications.*

*Custom made Filters - Made to Size - 1", 2" or 4" - several different merv ratings available*

*Custom made Air Conditioner Covers for winter storage*

**Fasteners**

**Fasteners**

**Rivets**

**Steel**

- 1/8" diameter



Prod ID#	CSI#	Body Length	Mandrel	Pack Size	Price
1349	SS42DT	.232	Plated	1,000	70.94
1350	SS44DT	.357	Plated	1,000	80.92

**Aluminum**

- 1/8" diameter



Prod ID#	CSI#	Body Length	Mandrel	Pack Size	Price
1347	AA42DT	.232	Aluminum	1,000	75.14
1348	AA44DT	.357	Aluminum	1,000	83.06

**Zip-In™ Screws**

- Burr-free
- Undercut - always seats flush
- One 1/4" hex driver head for all sizes



Prod ID#	CSI#	Size	Head Size	Pack	Price
1328	HW7X1/2Z15M	7 x 1/2"	1/4"	15,000	544.80
1327	HW7X1/2ZT(CC72)	7 x 1/2"	1/4"	1,000	48.69
38195	HW7X1/2Z100	7 x 1/2"	1/4"	100	9.42
1329	HW8X1/2Z1M(CC73)	8 x 1/2"	1/4"	1,000	54.12
1330	HW8X1/2Z12M	8 x 1/2"	1/4"	12,000	473.31
1331	HW8X3/4Z1M	8 x 3/4"	1/4"	1,000	70.35
1332	HW8X3/4Z10M	8 x 3/4"	1/4"	10,000	524.65
1334	HW8X1Z7M	8 x 1"	1/4"	7,000	517.21
1333	HW8X1ZT	8 x 1"	1/4"	500	44.34
1336	HW8X11/2Z4.5M	8 x 1-1/2"	1/4"	4,500	467.59
1335	HW8X11/2Z250	8 x 1-1/2"	1/4"	250	30.56
1338	HW8X2Z2.3M	8 x 2"	1/4"	2,300	308.17
1337	HW8X2Z250	8 x 2"	1/4"	250	40.98
49288	HW8X3ZWG(53081)	8 x 3"	1/4"	25	17.22
1339	HW10X34Z1M	10 x 3/4"	1/4"	1,000	87.28

**Zip-In™ Pails**

Prod ID#	CSI#	Size	Head Pack	Pack	Price
40694	HW7X1/2ZP	7-1/2"	1/4"	7,500	322.20
41236	HW8X1/2ZP	8 x 1/2"	1/4"	7,000	327.20
40695	HW8X3/4ZP	8 x 3/4"	1/4"	5,000	301.96
41237	HW8X1ZP	8 x 1"	1/4"	3,500	300.01

**Bit-Tip® Screw Selection**

- Drills it's own hole
- Taps a matching thread
- Fastens in steel up to .200 thick



**Hex Washer Head Type**

- #2 point, 1/4 driver

Prod ID#	CSI#	Size	Head Size	Pack	Price
1341	BT131T (51244)	8-18 x 1/2"	1/4"	1000	89.15
1343	BT133T	8-18 x 3/4"	1/4"	500	58.04

**Hex Washer Head Type**

- #3 point, 5/16 driver



Prod ID#	CSI#	Size	Head Pack	Pack	Price
1345	BT153T	10-24 x 3/4"	5/16"	500	81.49

**Nails**

**Panning Nails**



Prod ID#	CSI#	Size	Wt	Price
58439	114.3BPN	1-1/4"	3 lb	35.50
2115	114.50BPN	1-1/4"	50 lb Box	373.68



**Cable Ties**

**Standard Cable Ties**

- Temp Range 40°F - 185°F
- Easy insert Tip
- UL Approved, Nylon 6/6

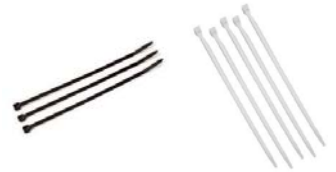

Prod ID#	CSI#	Size	Min Tensile Strength(lb)	Color	PK	Price
3822	8NT	8"	50	Natural	100pk	17.18
3823	8BNT	8"	50	Black	100pk	18.87
3825	1512NT	15-1/2"	50	Natural	100pk	30.37
3826	1512BNT	15-1/2"	50	Black	100pk	29.21

Fasteners

**Fasteners**

**Heavy Duty Lashing Ties**

- Temp range 40°F - 185°F
- Easy insert tip
- UL approved, Nylon 6/6



Prod ID#	CSI#	Size	Min Tensile Strength(lb)	Color	Price
3828	36NT	36"	175	Natural	1.02
3830	48NT	48"	175	Natural	2.70

**Screw Mount Cable Ties**

- For cable mounting
- 50 lb minimum tensile strength
- Harness can be positioned with a rivet, screw or bolt



Prod ID#	CSI#	Size	Mntg Screw	Color	PK	Price
3824	8NSMT	8-1/2"	#10	Natural	100pk	27.28

**T-Cable Clamps**

- Nylon 6/6
- T3 - 3/8" wide contact area
- T5 - 1/2" wide contact area



Prod ID#	CSI#	Size	Color	Pack	Price
3832	14NCC	1/4"	White	100/Pk - T3	10.63
3833	38NCC	3/8"	White	100/Pk - T3	10.63
3834	12NCC	1/2"	White	100/Pk - T3	12.66
3835	34NCC	3/4"	White	50/Pk - T5	12.66

**J.T. PRODUCTS, INC.**

**Zip-Ez™ Duct Wrap Fasteners**

- All purpose fasteners
- Permanent holding power



Prod ID#	CSI#	Description	Price
46910	ZIP-EZ	ZIP-EZ Duct Wrap Fastener (250/Pk)	85.39



**Basset Brackets - Galvanized**

**Self-Nailing**

- Pre-drilled pilot holes are 1/8" on 13/64" centers



Prod ID#	CSI#	Description	Price
3361	A150	Regular Bracket Self Nailing	2.31
75956	E125G	XL Bracket self Nailing	4.42

**"Tab"**

- Pre-drilled pilot holes are 1/8" on 13/64" centers

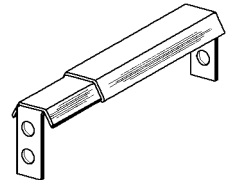

Prod ID#	CSI#	Description	Size	Price
28734	AT150	Galvanized	12" - 19"	2.68
29512	ET125G	Extra Long	19" - 26"	5.30

**Square Duct Hangers - Galvanized**

- 18 Gauge
- Galv. Steel



Prod ID#	CSI#	Size	Price
31258	BH8	8" Galv Steel	1.26
31257	BH9	9" Galv Steel	1.39
74577	BH10	10" Galv Steel	1.71
74578	BH11	11" Galv Steel	1.90

**Swivel Hangers - PVC**

- Rotates 360°
- White ABS plastic
- 50 nails in each bag of 25



Prod ID#	CSI#	Size	Price
3531	SH2	2"	4.51
3532	SH3	3"	4.80

Fasteners



**Fasteners**

**Basset Hooks  
Wire Pipe Hooks**



Prod ID#	CSI#	Size	Ga	Finish	Price
3362	34.6PWS	3/4" x 6"	11	Plain Steel	0.99
3365	1.6PWP	1" x 6"	9	Plastic Coat	2.10
3363	1.6PWS	1" x 6"	9	Plain Steel	1.01

**Water Heater Pans  
Aluminum**

- Round-shaped
- Pre-drilled for 1" PVC Drain



Prod ID#	CSI#	Size	Price
59044	AWHP-22-5	22"	58.39
73400	AWHP-26-5	26"	63.67
72667	AWHP-30-5	30"	81.60

**Basset Straps  
3/4" Perforated Duct Strap**

- 1/4" & 9/64" Holes



Prod ID#	CSI#	Size	Lgth	Ga	Finish	Price
3368	34.10GDS	3/4"	10'	24	Galv	5.23
3369	34.100GDS	3/4"	100'	24	Galv	43.87

**Basset FHA Plates**

- Used to reinforce floor or ceiling joist that have been cut to allow piping to pass through them

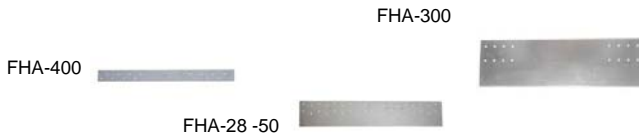

Prod ID#	CSI#	Size	Gauge	Price
44150	FHA4001816	1-1/2" x 18"	16	2.63
42282	FHA4002416	1-1/2" x 24"	16	5.18
44306	FHA30018168	3" x 18"	16	3.49
74038	FHA-28-50	5" x 28"	16	14.42

**BOCA Safety Nail Plate**

Prod ID#	CSI#	Size	Gauge	Price
72626	P58-16-R	5" x 18"	16	3.40

**We are continually adding new products. Call us with your inquiries.**



Fasteners

## Fasteners

### Channel, Combinations & Hole Patterns

- Cold formed
- Low carbon steel
- Continuous slot with inturned lips provide the ability to make attachments at any point
- A variety of pre-punched 9/16" diameter hole patterns are available

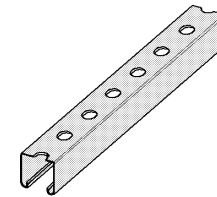

B24

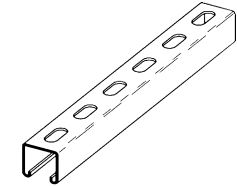

B54

#### B24 Channel

Prod ID#	CSI#	Size	Gauge	Material/Finish	Hole Pattern	Price
2132	B24SH120GRN	1-5/8" x 1-5/8" x 10'	14	Dura-Green	9/16" x 7/8" Slots on 2"	65.54

#### B54 Channel

Prod ID#	CSI#	Size	Gauge	Material/Finish	Hole Pattern	Price
2133	B54SH120GRN	1-3/16" x 1-5/8" x 10'	14	Dura-Green	9/16" x 7/8" Slots on 2"	52.31

### Strut Systems

#### Slotted Angle

- Transverse and longitudinal slots
- Roll formed

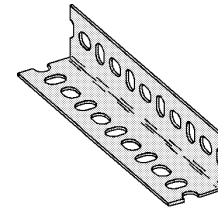

Prod ID#	CSI#	Size	Gauge	Material/Finish	Price
2134	SA158-120ZN	1-5/8" x 1-5/8" x 10'	14	Zinc	129.84

### Rooftop Support Systems

#### RTB-Series

- Compatible with most rooftop materials
- Extends roof life
- Black UV stabalized
- Rated up to 200 deg F
- Supports up to 450 lbs
- 5-Year Warranty



Prod ID#	CSI#	Size	Weight	Description	Price
65230	RTB-01	9" x 9" x 4.5"	1 lb	Black UV Polypropylene Copolymer	29.96

### Channel Nuts & Hardware

#### Channel Twirl-Nut®

- Zinc plated steel

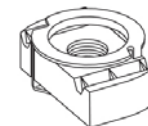

Prod ID#	CSI#	Thread Size	Fits Channel Sizes	Nut Thickness	Price
2135	TN228ZN	3/8" - 16	All Sizes Except B62 and 72	3/8"	7.48

**Fasteners**

**Pipe Clamps**

**Rigid Conduit or Pipe Clamps**

- Zinc plated steel

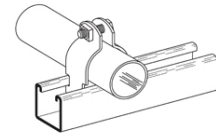

Prod ID#	CSI#	Size	Thickness	Finish	Price
2148	B2009	3/4"	14 Gauge	Electro-plated Zinc	5.82
2149	B2010	1"	14 Gauge	Electro-plated Zinc	6.63

**Pipe Hangers**

**B3170NF Adjustable Band Hangers**

- Material: Steel
- Designed for suspending insulated pipe (with shield) or non-insulated pipe allowing for vertical adjustment

B3170NF

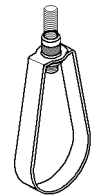

Prod ID#	CSI#	Nominal Pipe Size	Finish	Price
2142	B3170NF34	3/4"	Pre-Galvanized	4.41

**Strap Hangers**

- Material: Steel
- Standard finish: Zinc phosphate
- Parallel designed for suspending up to 1" straps parallel to beams
- Right angle designed for suspending up to 1" wide straps at right angle to beam
- For beam flanges 1/8" to 1/4"



BH-2-4



BH-2-4R

Prod ID#	CSI#	Description	Flange thickness	Per Box	Price
2108	BH-2-4 (78101118870)	Parallel	1/8" to 1/4"	100	319.63
2109	BH-2-4-R 78101118875	Right Angle	1/8" to 1/4"	100	320.66

Fasteners

**Thank You for Using this Catalog as Your Reference to Our Broad Line of Products.**

**Fasteners**

**DynaStick Self Adhesive Hangers**

**With Steel Washers**

- Pin - 12 gauge
- Base - 28 gauge

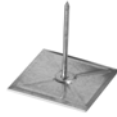

Prod ID#	CSI#	Size	Pack	Price
2462	SAH114	1-1/4" for 1" Insulation	100	61.46

**Standard Bangers™**

- Mechanical fastener



Prod ID#	CSI#	Description	Price
2451	BGT12	1/2" For 1/2" Insul - 1000/Pk	229.04

**FTC Econo-Points Pins**



Prod ID#	CSI#	Description	Price
2459	FTC12	1/2" f/1/2" Liner - 5000/Pk	501.07
2460	FTC34	3/4" f/1" Liner - 5000/Pk	490.95
2461	FTC100	1" f/1" High Density Liner - 5000/Pk	558.34

**Vinyl Duro Straps**

- Black vinyl-coated polyester fill



Prod ID#	CSI#	Description	Price
18335	VDS #10190	1-1/2" x 200' Vinyl Strap	76.72

**Cables**

**Dura Loop Cable Sling**

- Pre-looped cable ends



Prod ID#	CSI#	Size	Price
57742	LC15-332	3/32" x 15' 1-1/2"	10.80

**Wire Rope**

- Aviation Grade Galvanized



Prod ID#	CSI#	Size	Price
63124	WC3-CL12	3/32" x 500' Wire Spool #30202	237.33

**Cable Locks**

**CL-12 Cable Lock**

- For light duty hanging of ductwork & acc.
- With 1/16 wire rope the load range is 75 lbs
- With 3/32 wire rope the load range is 150 lbs



Prod ID#	CSI#	Size	Price
51258	CL12	1/16 & 3/32 #30351	5.92

**Bracket Assembly**

**KV12**

- Bracket Fastens the Cable Lock to the Duct with sheet metal screws.
- CL12 Cable Lock included
- Working load limit of up to 150lbs



Prod ID#	CSI#	Size	Price
67090	KV12	Bracket Assy w/CL12 Cable Lock	7.47



**Rod Couplings**

- Zinc Plated



Prod ID#	CSI#	Description	Price
2101	TR38.16CPG	3/8-16 Zinc Plated (Pc)	0.86

**Threaded Rod**

- A36 Low Carbon Steel



Prod ID#	CSI#	Description	Price
3958	TR3/8X6P	3/8" x 6' Plain (Pc)	6.58
3593	TR3/8X10Z	3/8" x 10' Zinc (Pc)	11.05

**Nuts**

- Zinc-plated



Prod ID#	CSI#	Description	Price
3597	EHN7-50	3/8-16 Hex Nut (Pc)	0.27
3598	EHN8	1/2-13 Hex Nut (Pc)	0.58

**Washers**

- Zinc plated



Prod ID#	CSI#	Description	Price
3599	E2014	3/8" x 1-1/2" Fender (Pc)	0.45

Fasteners

**Fasteners**

**Verticle Rod Hanger**

- Self drilling sciew style mechanical anchor for wood.
- Safe & user freindly way to hang rod overhead,



Prod ID#	CSI#	Description	Price
77607	7167-25	1/4"x3" Screw Hanger- 3/8" Rod	4.57

**Anchor Kits**



Prod ID#	CSI#	Description	Price
2111	ECA4	1/4" (100 Pk)	16.27
2112	EPA2	3/16" Thermostat (100 Pk)	23.56
2113	EPA4H	5/16" Hex Head Vinyl (100 Pk)	27.23

**Straps - One Hole**

- Zinc plated steel
- "Lock In" feature for easy installation



Prod ID#	CSI#	Description	Price
2116	E1012TE	1/2" Conduit Strap (Pc)	0.56
2117	E1034TE	3/4" Conduit Strap (Pc)	0.61
2118	E1100TE	1" Conduit Strap (Pc)	0.58
2119	E1114T	1-1/4" Conduit Strap (Pc)	1.24

**Straps - Two Hole**

- Galvanized Steel EMT
- "Lock In" feature for easy installation



Prod ID#	CSI#	Description	Price
73630	E2012T	1/2" 2 Hole Conduit Strap (Pc)	0.28
74653	E2034T	3/4" 2 Hole Conduit Strap (Pc)	0.39
73631	E2100T	1" 2 Hole Conduit Strap (Pc)	0.54
75622	E2114T	1-1/4" 2 Hole Cond Strap (Pc)	0.98

**Straps - Two Hole**

- Galvanized Steel Rigid
- "Lock In" feature for easy installation
- Ribbed for Extra Strength



Prod ID#	CSI#	Description	Price
77691	E2012R	1/2" 2 Hole Conduit Strap (Pc) For Galv Steel Rigid	0.46
77981	E2100R	1" 2 Hole Conduit Strap (Pc) For Galv Steel Rigid	1.51

**Nylon Ties**

- -40 degrees F to 180 degrees F



Prod ID#	CSI#	Description	Price
79067	EWT14	15-1/4" Nylon Tie (100Pk)	13.03

*Thank you for doing business with us. We appreciate your order.*

Fasteners

**Special Order**



**Fire Dampers, Radiation Dampers**



**FanTech Residential in-line fans, ceiling, duct mounted, roof mounted etc.**

HEAT CONTROLLER, INC.  
Heatcontroller.com

**Packaged Terminal Units(PTAC), Portable Coolers, Packaged Wall Mounted Units, Geothermal**



**Heat Transfer Products Boilers & Parts**



**Linesets Inc - Made to Order Any Length**



**Lloyd Smoke & Fire Dampers**



**Concentric Diffusers, curbs, mixing boxes, supports, etc.**



**Mortex - Hydronic Coils & Custom Commercial Coils**



**Make Up Airst, Direct/Indirect Fired**



**Reznor Special Order Parts**



**Commercial ERV's, Economizers, & Concentric Diffusers**

*Curb Adaptors – Made to fit exactly over existing curb.*

*Custom Aluminum Commercial Registers and Diffusers – White or Brushed Aluminum – Multi-shutter or Opposed Blade Dampers*

*Custom made Galvanized Fittings and Boots – Plenums, Return Air Drops, Insulated and Non- Insulated Duct etc.*

*ERV's & HRV's - Available from GeneralAire, Honeywell, Lifebreath, & Broan*

*Spiral Galvanized Duct and Fittings - ordered to the Job Specifications.*

*Custom made Filters - Made to Size - 1", 2" or 4" - several different merv ratings available*

*Custom made Air Conditioner Covers for winter storage*

**Electrical**

**Disconnect Boxes**



Prod ID#	CSI#	Description	Price
2405	30ADB	30 amp Fused	36.51
2406	60ADB	60 amp Fused	38.39
2407	60ANFDB	60 amp Non-Fused	34.45



**Diagnostic Tools**

**VZH04 Diagnostic Tool Adaptor for VZ-7**

- For Luxaire, Coleman, & York



Prod ID#	CSI#	Size	Price
55928	VZH04	VZ-7 Adaptor for Luxaire/Coleman/York	47.34

**Jumper Wires**

**Gator Clips**

- Used on control circuits
- Soldered leads
- Heavy carry-pouch and velcro hand strap
- 12/Pk



ZG002

Prod ID#	CSI#	Wires	Length	Amps	Price
55888	ZG003	8	24"	15	47.46



**Circuit Protection Products**

**ZBreaker Set - 3 Amp**

- Kit includes wire and pre-installed terminals



Prod ID#	CSI#	Description	Price
56578	ZK003	3 Amp Circuit Breaker	21.87

**ZBreaker Set - 5 Amp**

- Kit includes wire and pre-installed terminals



Prod ID#	CSI#	Description	Price
56577	ZK005	5 Amp Circuit Breaker	22.18

**Cables & Wires**

**Thermostat Wire**

- Bare copper insulated conductors with an overall jacket
- 18 AWG solid thermostat wire
- UL listed type CL2
- Brown reel



Prod ID#	CSI#	GA	Length	Cond.	Price
7622	182ULW	18	500'	2	115.43
24679	183ULW	18	500'	3	200.09
7623	184ULW	18	250'	4	118.61
24680	185ULW	18	250'	5	117.17
23916	186ULW	18	250'	6	168.53
21594	188ULW	18	250'	8	198.58
29641	1810ULW	18	250'	10	292.90

**SpeedBag Thermostat Wire**

- Bare copper insulated conductors with an overall jacket
- 18 AWG solid thermostat wire
- UL listed type CL2
- Saves time on Installation
- 250'



Prod ID#	CSI#	GA	Length	Cond.	Price
74628	185ULW 47130907 Speedbag	18	250'	5	116.36

Electrical

**Electrical**

**UL Plenum Wire**

- Copper Conductors
- Low Smoke PVC Jacket



Prod ID#	CSI#	GA	Length	Cond.	Price
27322	182ULPW	18	500'	2	185.38
27991	184ULPW	18	250'	4	155.36
27323	185ULPW	18	250'	5	170.99
49725	186ULPW	18	250'	6	208.33
27992	188ULPW	18	250'	8	278.95

**Fuses**

- 1/10 - 600 Amperes
- 250VAC - class RK5
- Dual element



Prod ID#	CSI#	Description	Price
3522	7-CRNR15	15 amp Fuse	6.29
3523	7-CRNR20	20 amp Fuse	6.29
3524	7-CRNR25	25 amp Fuse	6.29
3525	7-CRNR30	30 amp Fuse	6.29
3526	7-CRNR35	35 amp Fuse	10.82
3527	7-CRNR40	40 amp Fuse	10.82
3528	7-CRNR45	45 amp Fuse	10.82
3529	7-CRNR50	50 amp Fuse	10.82
3530	7-CRNR60	60 amp Fuse	11.39

**Romex Wire**

- Non-metallic sheathed cable
- PVC insulation & outer jacket w/ground
- Copper conductor material



Prod ID#	CSI#	Size	Price
2404	COPRX142	14/2 Romex Wire 250' Roll - 14AWG 2-Wire	197.81

**Aluminum Service Cable**

- PVC Jacket
- Glass reinforced tape shield
- Helical Bare Ground



Prod ID#	CSI#	Size	Price
18722	ALUSEU6	6ga, sold per foot	2.96

**Thinwall Conduit**

- Steel Material
- Hot Dip Galvanized Finish
- Easy to Cut and Bend



Prod ID#	CSI#	Size	Price
2397	EMT050	1/2" x 10' Thinwall Conduit	20.18
2398	EMT075	3/4" x 10' Thinwall Conduit	21.40

**Greenfield Flexible Steel Conduit**

- High Grade Hot Dipped Galvanized Low-Carbon Steel
- Continuous Interlocking Strip Design Enhances Flexibility



Prod ID#	CSI#	Size	Price
2400	FAC050	1/2" x 100' Greenfield	234.89

**12/2 MC Cable**

- UL Classified for Through Wall Penetrations
- Copper Conductor Material



Prod ID#	CSI#	Size	Price
71098	12/2x250MCCABLE	12/2 x 250' MC Cable Ft.	1.77

**Connectors**

- Miscellaneous Electrical Connectors And Bushings



Prod ID#	CSI#	Size	Price
2440	BRI642	1/2" Tomic Conn	3.21
2441	ARLBT75	3/4" Tomic Conn	5.54
2387	REG701	1/2" EMT Conn	0.83
2388	BRI231DC	3/4" EMT Conn	0.86
2394	BRI801DC2	3/8" 90° Box Conn	3.98
2395	BRI804DC2	1/2" 90° Box Conn	5.24
2396	BR806DC	3/4" 90° Box Conn	4.09
2391	BRI501DC2	3/8" Str Box Conn	1.93
2392	BRI407DC2	1/2" Str Box Conn	3.52
2393	408DC	3/4" Str Box Conn	3.75
2444	BRI650DC2	3/8" Cord Conn	1.25
2427	BRI430LT2	1/2" Str Liquid Tight Fitting	16.35
2389	EGS5050S	1/2" EMT Cpg	1.11
68227	BRI7WB51	1/2" Insulating Bushing	0.48
78984	C-750	3/4" 2 Screw Connector	5.77



**Electrical**

**Washers & Locknuts**



Prod ID#	CSI#	Size	Price
2428	ARLDLN1	1/2" Locknut	0.82
2429	ARLDN2	3/4" Locknut	1.12

**Misc. Electrical Supplies**

Prod ID#	CSI#	Size	Price
2435	12CN	1/2" Chase Nipple	1.90
2437	34CN	3/4" Chase Nipple	1.98
2431	REG662	3/4" Offset Nipple	13.32
2432	EGSS50	1/2" Knock Out Plug	1.71
20049	BRP6S1	Service Cable Clamps	0.98
2450	BRPSN100100	1-1/4" x 5/8" Cable Staples 100/Pk	13.42
3407	626-38632	60/30A Fuse Reducer(Pr)	17.99
25464	TL15	Buss TL15 125V Td Plug Fuse	11.24
76843	EGS4SSL120DR	2.125x4x2.125 GFI Elec Box	6.47
2414	EGS4SSPL	4" x 4" x 1-1/2" Electrical Box	5.32
2421	EGS8465	4" x 4" Blank Cover	2.54
3409	LEV14512	SPST Switch	4.45
3410	LEV5225	Comb Switch/Recepticle	24.53
3408	LEV5320CP	Duplex Receptacle	3.26
2420	MUL10002	2"x4" Duplex Plug Cover	3.75
2419	MUL10004	2"x4" Single Switch Cover	2.70
76844	MUL10013	2"x4" GFI Handy Box Metal	3.75
44374	MUL40452	1/2" Rubber Grommet	1.51
2445	MUL40453	5/8" Rubber Grommet	1.58
65304	T7299-PW	Comb Switch/Recep GFI	82.93
74129	74713	15 Amp GFCI White Recepta	38.48

**Liquid Tight Connectors**

- For Use with Jacketed Mini-Split Wire



Prod ID#	CSI#	Size	Price
79357	TECK5090	1/2" 90 Deg Liquid Tight Connector for MSW	38.47



**Electrical**

**Rough Service Light Bulbs**



Prod ID#	CSI#	Description	Price
3427	5232	100w	6.48

**Handy Boxes**

**Standard Steel Utility Covers**



Prod ID#	CSI#	Description	Price
2418	620-254	Flat Blank Cover 2 x 4	2.19

**Fuses**

**Box Cover Units**

- Max 15 Amps, Max 125VAC
- UL listed & CSA certified
- For use with type "T" plug fuses

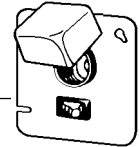

Prod ID#	CSI#	Description	Price
3406	620-608	Switch/Fuse Combo/ESSU	22.76

**LiquidTite Flex Conduit & Fittings**

**A/C Whips - Non-Metallic Connectors**

- Liquid-tight flexible conduit system



Prod ID#	CSI#	Size	Description	Price
2408	12.4ACW	1/2" x 4'	#10 THHN	25.59
2409	12.6ACW	1/2" x 6'	#10 THHN	33.47
6560	34.6ACW	3/4" x 6'	#8 THHN	39.49

**Wire Connectors**

**Wire Connectors - Screw On**

- DOT classified for recovery, recycling, service
- 100/Box



Prod ID#	CSI#	Description	Price
3412	GB1 623-001	Gray, 71B #22-#16 AWG 300V Max	15.66

Electrical

Electrical

Wire Connectors - Screw On (Continued)

Prod ID#	CSI#	Description	Price
3413	GB2 623-002	Blue, 72B #22-#16 AWG 300V Max	13.79
3415	GB3 623-003	Orange, 73B #22-#14 AWG 600V Max	16.65
3416	GB4 623-004	Yellow, 74B #18-#10 AWG 600V Max	19.81
3417	GB6 623-005	Red, 76B #18-#10 AWG 600V Max	32.72

Terminal Connectors

- 180 Terminals (10 of each)



Prod ID#	CSI#	Description	Price
59706	PA10	Terminal Connectors -180Pk	63.70

Batteries

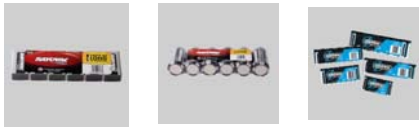

Prod ID#	CSI#	Description	Price
70030	7-ALAAA	AAA Alkaline Battery	2.14
3418	AA (7-ALAA)	AA Alkaline Battery	2.38
3421	D (7-ALD)	D Industrial Battery	4.52
3422	9V (7-AL9V)	9 Volt Alkaline Battery	7.67

Butt Connectors

- Insulated terminals crimp to the wires
- Relieves the need to solder



Prod ID#	CSI#	Description	Price
59708	B211	Butt Connectors 22-18 W (18 pk)	6.55
59709	B222	Butt Connectors 16-14 W	9.04
59710	B233	Butt Connectors 12-10 W (11 pk)	9.04
59711	BA22	Butt Connectors ASSORT (16 pk)	9.04



Solderless Terminals

- Insulated
- .250 tab width
- 100 Pack



Prod ID#	CSI#	Description	Price
76490	FS12100	Female Disconnect 12-10 (100Pk)	22.04
2446	FS14100	Female Disconnect 16-14 (100Pk)	18.38

Nylon Disc Type Solderless Terminal

- Insulated
- .250 tab width
- 100 Pack



Prod ID#	CSI#	Description	Price
76491	DF16100	Nylon Disc Terminal 22-16 (100Pk)	30.65



Fuses



Blade-Type Fuses

- Fast acting, 32V, UL listed

Prod ID#	CSI#	Description	Price
28077	626-AT0003	3 amp	2.47
28078	626-AT0005	5 amp	2.47



MARS Surge Protective Device

- HVAC/R
- 18" 10AWG Leads
- 1/2" x 20 Threaded Nipple
- 120/240 VAC
- 10,000 Amps
- \$2500 Warranty connected equipment



Prod ID#	CSI#	Description	Price
75242	83905	Mars Surge Protective Device	96.58

Electrical

---

---

**Information**

---

---

**DEFINITIONS OF TERMS**  
**Refrigeration and Air Conditioning**

**ABSOLUTE HUMIDITY:** The weight of water vapor in a given amount of air. Grains per cubic foot.

**ABSOLUTE PRESSURE:** Pressure measured with a base of zero.

**ABSOLUTE TEMPERATURE:** A temperature scale expressed in degrees, F or C, using absolute zero as a base. Referred to as the Rankin or Kelvin scale.

**ABSOLUTE ZERO:** The temperature at which molecular activity theoretically ceases (-459.69°F or -273.16°C)

**AFUE %:** AFUE stands for "annual fuel utilization efficiency". This rating is based on average usage, including on and off cycling, as set out in the standardized Department of Energy test procedures.

**AIR CONDITIONING:** The process of controlling the temperature, humidity, cleanliness and distribution of the air.

**AIR STANDARD CONDITIONS:** Conditioning at which BTU ratings for summer air conditioning equipment is rated. 95°F dry bulb, 75°F wet bulb at the condenser inlet and 80°F dry bulb, 67°F wet bulb at the evaporator inlet.

**AIR:** Atmospheric air is composed of approximately 78% Nitrogen, 21% Oxygen and 1% rare gases including Carbon Dioxide, Krypton, Neon, Argon, Ozone, Helium and Ammonia. Over the sea, traces of salt are present, and over the land, traces of sulfates. Dust and micro-organisms are also present.

**ATMOSPHERIC PRESSURE:** The weight of 1 square inch column of the earth's atmosphere. At sea level this pressure is 14.696 pounds per square inch.

**BIMETAL:** Two metals with different rates of expansion fastened together. When heated or cooled they will warp and can be made to open or close a switch or valve.

**BOILING POINT:** The temperature at which the addition of any heat will begin a change of state from a liquid to a vapor.

**BRITISH THERMAL UNIT (BTU):** The amount of heat necessary to raise the temperature of 1 pound of pure water (about 1 pint) by 1° Fahrenheit.

**CAPILLARY TUBE:** A refrigerant control consisting of a small diameter tube which controls flow by restriction. They are carefully sized by inside diameter and length for each particular application.

**CENTIGRADE:** A temperature scale with the freezing point of water 0° and the boiling point 100° at atmospheric pressure.

**COEFFICIENT OF PERFORMANCE (COP):** A ratio calculated by dividing the total heating capacity provided by the refrigeration system, including circulating fan heat but excluding supplementary resistance (BTUs per hour), by the total electric input (watts) x 3.412.

**COMPRESSION:** The reduction of volume of a vapor or gas by mechanical means.

**COMPRESSOR:** A mechanical device used to compress gases. Four main types are: Reciprocating; Centrifugal, Rotary and Scroll.

**CONDENSATION POINT:** The temperature at which removal of any heat will begin a change of state from a vapor to a liquid.

**CONDENSER:** A device in which the superheat and latent heat of condensation are removed to effect a change of state from a vapor to a liquid. Some sub-cooling is also usually accomplished.

**CONDENSING MEDIUM:** The substance, usually air or water, to which the heat in a condenser is transferred.

**CONDENSING UNIT:** The portion of a refrigeration system where the compression and condensation of refrigerant is accomplished. Sometimes referred to as the "high side".

**CONDUCTION:** The transfer of heat from molecule to molecule within a substance.

**CONTACTOR:** An electro-magnetic actuated relay. Usually used to refer to the relay which closes the circuit to a compressor.

**CONVECTION:** The transfer of heat by a moving fluid.

**COOLING ANTICIPATOR:** A resistance heater (usually not adjustable) in parallel with the cooling circuit. It is "on" when the circuit is "off" adding heating to shorten the off cycle.

**CYCLE:** The complete course of operation of a refrigerant back to a selected starting point in a system. Also used to describe alternating current through 360 space degrees.

**DENSITY:** Mass or weight per unit of volume, i.e.: Standard air .075 pounds per cubic foot.

**DISCHARGE LINE:** A tube used to convey the compressed refrigerant vapor from the compressor to the condenser inlet.

**DISCHARGE PRESSURE:** The pressure read at the compressor outlet. Also called head pressure or high pressure.

**DOE:** Department of Energy.

**DRY BULB TEMPERATURE:** Temperature read with an ordinary thermometer.

**ENERGY EFFICIENT RATIO (EER):** A ratio calculated by dividing the cooling capacity in BTUs per hour (BTUH) by the power input in watts or any given set of rating conditions, expressed in BTUH per watt (BTUH/watt).

**EVAPORATIVE COOLING:** The cooling effect of vaporization of a liquid in a moving air system.

**EVAPORATOR SUPERHEAT:** The actual temperature of the refrigerant vapor at the evaporator exit as compared to the saturated vapor temperature indicated by the suction pressure.

**EVAPORATOR:** A device in which a liquid refrigerant is vaporized. Some superheating usually takes place.

**FAHRENHEIT:** A temperature scale with freezing point of water 32° and the boiling point 212° at atmospheric pressure.

**FREEZING POINT:** The temperature at which the removal of any heat will begin a change of state from liquid to a solid.

**GAUGE PRESSURE:** Pressure measured with atmospheric pressure as a base.

## Information

**HEAT EXCHANGER:** A device for the transfer of heat energy from the source to the conveying medium.

**HEAT FLOW:** Heat flows from a warmer to a cooler substance. The rate depends upon the temperature difference, the area exposed and the type of material.

**HEAT OF COMPRESSION:** The heat added to a vapor by the work done on it during compression.

**HEAT OF THE LIQUID:** The increase in total heat (Enthalpy) per pound of saturated liquid as its temperature is increased above a chosen base temperature. (Usually -40°F for refrigerants). It is expressed in BTUs.

**HEAT TRANSFER:** The three methods of heat transfer are conduction, convection and radiation.

**HEAT:** A form of energy causing the agitation of molecules within a substance.

**HEATING SEASONAL PERFORMANCE FACTOR (HSPF):** The total heating output of a heat pump during its normal annual usage period for heating divided by the total electric power input in watt-hours during the same period.

**INCHES OF MERCURY:** Atmospheric pressure is equal to 29.92 inches of mercury.

**LATENT HEAT OF CONDENSATION:** The amount of heat energy, in BTUs, that must be removed to change the state of 1 pound of a vapor to 1 pound of liquid at the same temperature.

**LATENT HEAT OF FUSION:** The amount of heat energy, in BTUs, required to change the state of 1 pound of a liquid to 1 pound of solid at the same temperature.

**LATENT HEAT OF MELTING:** The amount of heat energy, in BTUs, that must be removed to change the state of 1 pound of a solid to 1 pound of liquid at the same temperature.

**LATENT HEAT OF VAPORIZATION:** The amount of heat energy, in BTUs, required to change the state of 1 pound of liquid to 1 pound of vapor at the same temperature.

**LATENT HEAT:** Heat that produces a change of state without a change in temperature. i.e.: Ice to water at 32°F; Water to steam at 212°.

**LIQUID LINE:** A tube used to convey the liquid refrigerant from the condenser outlet to the refrigerant control device of the evaporator.

**MANOMETER:** A tube filled with liquid used to measure pressure.

**MELTING POINT:** The temperature at which the addition of any heat will begin a change of state from a solid to a liquid.

**MERCURY MANOMETER:** Used to measure vacuum in inches of mercury.

**MICRON:** A unit used to measure high vacuums. One micron equals 1/25,400 of 1 inch mercury.

**PARTIAL PRESSURE:** The pressure exerted by an individual gas in a mixture.

**PRESSURE - TEMPERATURE RELATIONSHIP:** The change effected in temperature when pressure is changed or visa versa. Only used at saturated conditions. An increase in pressure results in a temperature increase. A decrease in temperature results in a pressure decrease.

**PRESSURE DROP:** The decrease in pressure due to friction of a fluid or vapor as it passes through a tube or duct.

**PSYCHROMETER:** A device having both a dry and a wet bulb thermometer. It is used to determine the relative humidity in a conditioned space. Most have an indexed scale to allow direct conversion from the temperature readings to the percentage of relative humidity.

**PSYCHROMETRIC CHART:** A chart on which can be found the properties of air under varying conditions of temperature, water vapor content, volume, etc.

**RADIATION:** The transfer of heat without an intervening medium. It is absorbed on contact with a solid surface.

**REFRIGERANT CONTROL:** A device used to meter the amount of refrigerant to an evaporator. It also serves as a dividing point between the high and low pressure sides of the system.

**REFRIGERANT:** A substance which produces a refrigerating effect while expanding or vaporizing.

**REFRIGERATION:** The transfer of heat from a place where it is not wanted to a place where its presence is not undesirable.

**RELATIVE HUMIDITY:** The percentage of water vapor present in a given quantity of air compared to the amount it can hold at its temperature.

**RELAY:** A device used to open and close an electrical circuit. The relay may be actuated by a bimetal electrically heated strip, a rod wrapped with a fine resistance wire causing expansion when energized, a bellows actuated by expansion of a fluid or gas or an electromagnetic coil.

**SATURATED VAPOR:** Vapor in contact with a liquid.

**SATURATION:** A condition of stable equilibrium of a vapor and a liquid.

**SEASONAL ENERGY EFFICIENCY RATIO (SEER):** The total cooling of a central unitary air conditioner or unitary heat pump in BTUs during its normal annual period for cooling divided by the total electric energy input in watt-hours during the same period.

**SENSIBLE HEAT:** Heat that can be measured or felt. Sensible heat always causes a temperature rise.

**SOUND RATING (SR):** A tone corrected A-weighted sound power level expressed in bels. The Sound Rating is based on tests performed at Standard Rating Conditions (cooling).

**SPECIFIC HEAT:** The amount of heat necessary to change the temperature of 1 pound of substance 1°F.

**SPECIFIC VOLUME:** The volume of a substance per unit of mass. i.e.: standard air 13.33 cubic feet per pound. The reciprocal of density.

**STANDARD AIR DENSITY:** .075 pounds per cubic foot. Equivalent to dry air at 70°F and at sea level pressure.

**STATE CONDITION:** Substances can exist in three states – Solid, Liquid or Vapor.

**SUB-COOLING:** Cooling of a liquid, at a constant pressure, below the point at which it was condensed.

**SUCTION LINE:** A tube used to convey the refrigerant vapor from the evaporator outlet to the suction inlet of a compressor.

**SUCTION PRESSURE:** The pressure read at the inlet side of a compressor. Also called back pressure or low side pressure.

**SUPERHEAT:** Heat added to a vapor after all liquid has been vaporized.

**TEMPERATURE:** A measure of heat intensity.

**THERMOSTAT:** A switch to close and open a circuit to indicate or terminate operation of a heating or air conditioning system.

**THERMOSTATIC EXPANSION VALVE:** Refrigerant control which monitors the flow rate according to the superheat at the evaporator outlet.

**TON OF REFRIGERATION:** The amount of heat necessary to completely melt 1 ton of 32°F ice in 24 hours. 200 BTUs per minute; 12,000 BTUs per hour; 288,000 BTUs in 24 hours. This is based on the latent heat fusion for ice which is 144 BTUs per pound.

**TOTAL HEAT:** (Enthalpy) The total heat energy in a substance. The sum of sensible and latent heat.

**TOTAL PRESSURE:** The sum of all partial pressures in a mixture of gases.

**VACUUM:** Any pressure below atmosphere pressure.

**WATER MANOMETER:** Used to measure pressure in inches of water.

**WET BULB TEMPERATURE:** Temperature read with a thermometer whose bulb is encased in a wetted wick.

## Information

### Conversion Factors

MULTIPLY	BY	OBTAIN
<b>Atmospheres (Std.)</b>		
760 MM of Mercury at 32°F	14.696	lbs./sq. in.
<b>Atmospheres</b>	76.0	cms mercury
atm	29.92	ins mercury
atm	33.90	ft. water
atm	1.0333	kgs/sq. cm.
atm	14.70	lbs./sq. in.
atm	1.058	tons/sq. ft.
<b>Barrels-Oil</b>	42	gals-oil
<b>BT Units</b>	0.2520	kgs-calories
BTUs	777.5	ft.-lbs.
BTUs	0.000393	hp-hrs
BTUs	107.5	kg-meters
BTUs	0.293	w-hrs
<b>BTU/Min.</b>	12.96	ft.-lbs./sec.
BTU/min	0.2356	hp
BTU/min	0.01757	kw
BTU/min	17.57	watts
<b>Calorie</b>	0.003968	BTU
<b>Centimeters</b>	0.3937	inches
cm	0.0328	feet
cm	0.01	meters
cm	10	mm
<b>Cms Mercury</b>	0.01316	atm
cms mercury	0.4461	ft. water
cms mercury	136.0	kgs/sq. meter
cms mercury	27.85	lbs./sq. ft.
cms mercury	0.1934	lbs./sq. in.
<b>Cms/Second</b>	1.969	ft./min.
cms/second	0.03281	ft. sec.
cms/second	0.036	km/hr.
cms/second	0.6	meters/min.
cms/second	0.02237	miles/hr.
cms/second	0.0003728	miles/min.
<b>Cms/Sec/Sec</b>	0.03281	ft./sec./sec.
<b>Cubic Cms</b>	0.00003531	cu. ft.
cu cms	0.06102	cu. in.
cu cms	0.000001	cu meters
cu cms	0.000001308	cu. yds.
cu cms	0.0002642	gals
cu cms	0.001	liters
cu cms	0.002113	pints (liq.)
cu cms	0.001057	quarts (liq.)
<b>Cubic Feet</b>	28320	cubic cms
cu. ft.	1728	cu. inches
cu. ft.	0.02832	cu. meters
cu. ft.	0.03704	cu. yds.
cu. ft.	7.48052	gals
cu. ft.	28.32	liters
cu. ft.	59.84	pints (liq.)
cu. ft.	29.92	quarts (liq.)
<b>Cubic Ft./Min.</b>	472.0	cu. cms/sec.
cu. ft./min.	0.1247	gals/sec.
cu. ft./min.	0.4720	liters/sec
cu. ft./min.	62.43	lbs. w/min.

MULTIPLY	BY	OBTAIN
<b>Cubic Ft./Sec.</b>	0.646317	million gals/day
cu. ft./sec.	448.831	gals./min.
<b>Cubic Ft. Water</b>	62.4	lbs. @ 60°F
<b>Cubic Inches</b>	16.39	cc
cu. ins.	0.0005787	cu. ft.
cu ins.	0.00001639	cu. meters
cu. ins.	0.00002143	cu. yds.
cu. ins.	0.004329	gals
cu. ins.	0.01639	liters
cu. ins.	0.03463	pints (liq.)
cu. ins.	0.01732	quarts (liq.)
<b>Cubic Meters</b>	100.000	cc
cu. meters	35.31	cu. ft.
cu. meters	61.023	cu. ins.
cu. meters	1.308	cu. yds.
cu. meters	264.2	gals
cu. meters	1000	liters
cu. meters	2113	pints (liq.)
cu. meters	1057	quarts (liq.)
<b>Cubic Yards</b>	764,600	cu. cms
cu. yds	27	cu. ft.
cu. yds	46,656	cu. ins.
cu. yds	0.7646	cu. meters
cu. yds	202.0	gals
cu. yds	764.6	liters
cu. yds	1616	pints (liq.)
cu. yds.	807.9	quarts (liq.)
<b>Decimeters</b>	0.1	meters
<b>Degrees (Angle)</b>	60	minutes
degs (angle)	0.01745	radians
degs (angle)	3600	secs
<b>Degrees/Sec.</b>	0.01745	radians/sec.
degs/sec.	0.1667	revs/min.
degs/sec.	0.002778	revs/sec.
<b>Fathoms</b>	6	ft.
<b>Feet</b>	30.48	cms
ft.	12	ins
ft.	0.3048	meters
ft.	1/3	yds
<b>Feet of Water</b>	0.02950	atms
ft. of w	0.8876	ins mercury
ft. of w	0.03048	kgs/sq. cm
ft. of w	62.43	lbs./sq. ft.
ft. of w	0.4335	lbs./sq. in.
<b>Feet/Min.</b>	0.5080	cms/sec
ft./min.	0.01667	ft./sec.
ft./min.	0.01829	kms/hrs
ft./min.	0.3040	meters/min.
ft./min.	0.01136	miles/hr.
<b>Ft./Sec./Sec.</b>	30.48	cms/sec./sec.
ft./sec./sec.	0.3048	ms/sec./sec.
<b>Foot-Pounds</b>	0.001286	BTUs
ft.-lbs.	0.00000505	hp-hrs
ft.-lbs.	0.0003241	kg-calories
ft.-lbs.	0.1383	kg-meters
ft.-lbs.	0.000003766	kw-hrs

Information

## Information

Information

MULTIPLY	BY	OBTAIN
<b>Ft.-Lbs./Min.</b>	0.001286	BTUs/min.
ft.-lbs./min.	0.01667	ft.-lbs./sec.
ft.-lbs./min.	0.0000303	hp
ft.-lbs./min.	0.0003241	kg-calories/min.
ft.-lbs./min.	0.0000226	kws
<b>Ft.-Lbs./Sec.</b>	0.007717	BTUs/min
ft.-lbs./sec.	0.001818	hp
ft.-lbs./sec.	0.01945	kg-calories/min.
ft.-lbs./sec.	0.001356	kws
<b>Gallons</b>	3785	ccs
gals	0.1337	cu. ft.
gals	231	cu. ins
gals	128	fl. ozs.
gals	0.003784	cu. meters
gals	3.785	liters
gals	8	pints (liq.)
gals	4	quarts (liq.)
<b>Gallons, Imp</b>	1.20095	US gals
<b>Gallons, US</b>	0.83267	Imp gals
<b>Gallons Water</b>	8.3453	lbs. water
<b>Gallons/Min.</b>	0.002228	cu. ft./sec.
gals/min.	0.06308	liter/sec.
gals/min.	8.0208	cu. ft./hr.
<b>Gals Water/Min.</b>	6.0086	tons water/24 hrs
<b>Grams</b>	15.432	grains
grams	.001	kgs
grams	1000	milligrams
grams	0.03527	ozs
grams	0.03215	ozs (troy)
grams	0.002205	lbs.
<b>Grams/Cm</b>	0.0056	lbs./in.
<b>Grams/Cu. Cm</b>	62.43	lbs./cu. ft.
grams/cu. cm	0.03613	lbs./cu. in.
<b>Grams/Liter</b>	58.417	grains/gal
grams/liter	8.345	lbs./1000 gals
grams/liter	0.062427	lbs./cu. ft.
grams/liter	1000	parts/million
<b>Horsepower</b>	42.44	BTUs/min.
hp	33.000	ft.-lbs./min.
hp	550	ft.-lbs./sec.
hp	1.014	hp (metric)
hp	10.70	kg-calories/min.
hp	0.7457	kws
hp	745.7	watts
<b>Horsepower (boiler)</b>	33,479	BTU/hr.
hp (boiler)	9,803	kws
<b>HP-Hours</b>	2547	BTUs
hp-hrs	1,980,000	ft.-lbs.
hp-hrs	641.7	kg-calories
hp-hrs	273,700	kg-meters
hp-hrs	0.7457	kw-hrs
<b>Inches</b>	2540	cms
ins	25.4	mm
ins	0.0254	M
ins	0.0833	ft.
<b>Inches of Mercury</b>	0.03342	atms

MULTIPLY	BY	OBTAIN
ins mercury	1.133	ft. water
ins mercury	13.57	in. water
ins mercury	0.03453	kgs/sq. cm
ins mercury	70.73	lbs./sq. ft.
ins mercury	0.4912	lbs./sq. in.
<b>Inches of Water</b>	0.002458	atms
ins of w	0.07355	ins mercury
ins of w	0.002540	kgs/sq. cm
ins of w	0.5781	ozs/sq. in.
ins of w	5.202	lbs./sq. ft.
ins of w	0.03613	lbs./sq. in.
<b>Kilograms</b>	980.665	dynes
kgs	2.205	lbs.
kgs	0.001102	tons (short)
kgs	1000	grams
<b>Kgs/Sq. Cm</b>	0.9678	atms
kgs/sq. cm	32.81	ft. water
kgs/sq. cm	28.96	ins mercury
kgs/sq. cm	20.48	lbs./sq. ft.
kgs/sq. cm	14.22	lbs./sq. ft.
<b>Kiloliters</b>	1000	liters
<b>Kilometers</b>	100.000	cms
kms	3281	ft.
kms	1000	meters
kms	0.6214	miles
<b>Kms/Hr.</b>	27.78	cms/sec.
kms/hr.	54.68	ft./min.
kms/hr.	0.9113	ft./sec.
kms/hr.	16.67	meters/min.
kms/hr.	0.6214	miles/hr.
<b>Kms/Hr. Sec.</b>	27.78	cms/sec./sec.
kms/hr. sec.	0.9113	ft./sec./sec.
kms/hr. sec.	0.2778	meters/sec./sec.
<b>Kilowatts</b>	56.92	BTUs/min
kws	44,250	ft.-lbs./min.
kws	737.6	ft.-lbs./sec.
kws	1.341	hp
kws	14.34	kg-calories/min.
kws	1000	watts
<b>Kilowatt-Hrs.</b>	3415	BTUs
kw-hrs.	2,665,500	ft.-lbs.
kw-hrs.	1.341	hp-hours
kw-hrs.	860.5	kg-calories
kw-hrs.	367,100	kg-meters
<b>Liters</b>	100	ccs
liters	0.03531	cu. ft.
liters	61.02	cu. ins
liters	0.01	cu. meters
liters	0.2642	gals
liters	2.113	pints (liq.)
liters	1.057	quarts (liq.)
<b>Liters/Min.</b>	0.004403	gals/sec.
<b>Meters</b>	100	cms
meters	3.281	ft.
meters	39.37	ins
meters	0.001	kms

## Information

MULTIPLY	BY	OBTAIN
meters	1000	mms
meters	1.094	yards
<b>Meters/Min.</b>	1.667	cms/sec.
meters/min.	3.281	ft./min.
meters/min.	0.05468	ft./sec.
meters/min.	0.06	kms/hr.
meters/min.	0.03728	miles/hr.
<b>Meters/Sec.</b>	196.8	ft./min.
meters/sec.	3.281	ft./sec.
meters/sec.	3.6	kms/hr.
meters/sec.	0.06	kms/min.
meters/sec.	2.237	miles/hr.
meters/sec.	0.03728	miles/min.
<b>Microns</b>	0.000001	meters
microns	25.400	in.
<b>Miles/Hr.</b>	44.70	cms/sec.
miles/hr.	88	ft./min.
miles/hr.	1.467	ft./sec.
miles/hr.	1.609	kms/hr.
miles/hr.	0.8684	knots
miles/hr.	26.82	meters/min.
<b>Millimeters</b>	0.1	cms
mms	0.03937	ins
<b>Mins (Angle)</b>	0.0002909	radians
<b>Ounces</b>	16	drams
ozs	437.5	grains
ozs	0.0625	lbs.
ozs	28.349527	grams
ozs	0.9115	ozs (troy)
ozs	0.0000279	tons (long)
ozs	0.00002835	tons (metric)
<b>Ounces (Fluid)</b>	1.805	cu. in.
ozs (fluid)	0.02957	liters
<b>Pints</b>	0.4732	liters
<b>Pounds</b>	16	ozs
lbs	256	drams
lbs	7000	grains
lbs	0.0005	tons (short)
lbs	453.5924	grams
lbs	1.21528	lbs. (troy)
lbs	14.5833	ozs (troy)
<b>Lbs. of Water</b>	0.01602	cu. ft.
lbs. of water	27.68	cu. in.
lbs. of water	0.1198	gals
<b>Lbs. of Water/Min.</b>	0.0002679	cu. ft./sec.
<b>Pounds/Cu. Ft.</b>	0.0005787	lbs./cu. in.
<b>Pounds/Cu. In.</b>	1728	lbs./cu. ft.
<b>Pounds/Sq. Ft.</b>	0.01602	ft. of water
<b>Pounds/Sq. Ft.</b>	0.006945	lbs./sq. in.
<b>Pounds/Sq. In.</b>	0.06804	atms
lbs./sq. in.	2.307	ft. water
lbs./sq. in.	2.036	in. mercury
lbs./sq. in.	27.68	in. water
lbs./sq. in.	0.07031	kgs/sq. cm
<b>Radians</b>	57.29578	degrees
<b>Temp. (°C) +273</b>	1	abs. temp. (°C)

MULTIPLY	BY	OBTAIN
<b>Temp. (°C) +17.78</b>	1.8	temp. (°F)
<b>Temp. (°F) +460</b>	1	abs. temp. (°F)
<b>Temp. (°F) -32</b>	5/9	temp. (°C)
<b>Therm</b>	100,000	BTUs
<b>Tons (Long)</b>	1016	kgs
tons (long)	2240	lbs
tons (long)	1.12000	tons (short)
<b>Tons, Refrigeration</b>	12,000	BTU/hr.
<b>Tons (Short)</b>	2000	lbs.
tons (short)	907.18486	kgs
tons (short)	2430.56	lbs. (troy)
tons (short)	0.89287	tons (long)
tons (short)	29,166.66	ozs (troy)
tons (short)	0.90718	tons (metric)
<b>Watts</b>	0.05692	BTUs/min.
watts	44.26	ft.-lbs./min.
watts	0.7376	ft.-lbs./sec.
watts	0.001341	hp
watts	0.01434	kg-calories/min.
watts	0.001	kws
<b>Watt-Hours</b>	3.415	BTU/hr.
watt-hrs.	2655	ft.-lbs.
watt-hrs.	0.001341	hp-hrs
watt-hrs.	0.8605	kg-calories
watt-hrs.	367.1	kg-meters
watt-hrs.	0.001	kw-hrs

### Five Basic Laws of Nature

**Law 1:** Heat exists in the air at all temperatures – below freezing as well as above – all the way down to absolute zero (-460° F).

**Law 2:** Heat flows from a higher temperature to a lower temperature regardless of how small the temperature difference might be.

**Law 3:** All gases become warmer when compressed.

**Law 4:** Most matter can be in a solid (ice), liquid (water) or gaseous (steam) state.

**Law 5:** The temperature at which a material changes from a liquid to a gas (evaporates or boils) or from a gas to a liquid (condenses or liquefies) depends on the pressure at which it is contained.

Information

Information

Information

**Drill Sizes**

Drill number or Letter*	Decimal Equiv.	Drill number or Letter*	Decimal Equiv.	Drill number or Letter*	Decimal Equiv.
80	0.0135	40	0.098	1	0.228
79	0.0415	39	0.0995	A	0.234
1/64	0.0156	38	0.1015	15/64	0.2344
78	0.016	37	0.104	B	0.238
77	0.018	36	0.1065	C	0.242
76	0.020	7/64	0.1094	C	0.242
75	0.021	35	0.110	D	0.246
74	0.0225	34	0.111	E & 1/4	0.250
73	0.024	33	0.113	F	0.257
72	0.025	32	0.116	G	0.261
71	0.026	31	0.120	17/64	0.2656
70	0.028	1/8	0.1250	H	0.266
69	0.0292	30	0.1285	I	0.272
68	0.031	29	0.136	J	0.277
1/32	0.0312	28	0.1405	K	0.281
67	0.032	9/64	0.1406	9/32	0.2812
66	0.033	27	0.144	L	0.290
65	0.035	26	0.147	M	0.295
64	0.036	25	0.1495	19/64	0.2969
63	0.037	24	0.152	N	0.302
62	0.038	23	0.154	5/16	0.3125
61	0.039	5/32	0.1562	O	0.316
60	0.040	22	0.157	P	0.323
59	0.041	21	0.159	21/64	0.3281
58	0.042	20	0.161	Q	0.332
57	0.043	19	0.166	R	0.339
56	0.0465	18	0.1695	11/32	0.3437
3/64	0.0468	11/64	0.1719	S	0.348
55	0.052	17	0.173	T	0.358
54	0.055	16	0.177	23/64	0.3594
53	0.0595	15	0.180	U	0.368
1/16	0.0625	14	0.182	3/8	0.375
52	0.0635	13	0.185	V	0.377
51	0.067	3/16	0.1875	W	0.386
50	0.070	12	0.189	25/64	0.3906
49	0.073	11	0.191	X	0.397
48	0.076	9	0.196	Y	0.404
5/64	0.0781	8	0.199	13/32	0.4062
47	0.0785	7	0.201	Z	0.413
46	0.081	13/64	0.2031	27/64	0.4219
45	0.082	6	0.204	7/16	0.4375
44	0.086	5	0.2055	29/64	0.4531
43	0.089	4	0.209	15/32	0.4687
42	0.0935	3	0.213	31/64	0.4844
3/32	0.0937	7/32	0.2187	1/2	0.5000
41	0.096	2	0.221		

NOTE: The shank of a numbered drill makes a good gauge to determine the inside diameter of capillary tubing or to measure gas burner orifices.

**Decimal and Metric Equivalents**

**Equivalents of Common Fractions of An Inch**

64ths	32nds	16ths	8ths	Decimal	Mm	---	64ths	32nds	16ths	8ths	Decimal	Mm
1/64				0.01562	0.397		33/64				0.51562	13.097
3/64	1/32			0.03125	0.794		35/64	17/32			0.53125	13.494
		1/16		0.04688	1.191				9/16		0.54688	13.891
				0.06250	1.588						0.56250	14.288
5/64	3/32			0.07812	1.984		37/64	19/32			0.57812	14.684
7/64				0.09375	2.381					5/8	0.53975	15.081
			1/8	0.10938	2.778		39/64				0.60938	15.478
				0.12500	3.175						0.62500	15.875
9/64	5/32			0.14062	3.572		41/64	21/32			0.64062	16.272
11/64				0.15625	3.969						0.65625	16.669
		3/16		0.17188	4.366		43/64		11/16		0.67188	17.066
				0.18750	4.763						0.68750	17.463
13/64	7/32			0.20312	5.159		45/64	23/32			0.70312	17.859
15/64				0.21875	5.556						0.71875	18.256
			1/4	0.23438	5.953		47/64			3/4	0.73438	18.653
				0.25000	6.350						0.75000	19.050
17/64	9/32			0.26562	6.747		49/64	25/32			0.76562	19.447
19/64				0.28125	7.144						0.78125	19.844
		5/16		0.29688	7.541		51/64		13/16		0.79688	20.241
				0.31250	7.938						0.81250	20.638
21/64	11/32			0.32812	8.334		53/64	27/32			0.82812	21.034
23/64				0.34375	8.731						0.83475	21.431
			3/8	0.35938	9.128		55/64			7/8	0.85938	21.828
				0.37500	9.525						0.87500	22.225
25/64	13/32			0.39062	9.922		57/64	29/32			0.89062	22.622
27/64				0.40625	10.319						0.90625	23.019
		7/16		0.42188	10.716		59/64		15/16		0.92188	23.416
				0.43750	11.113						0.93750	23.813
29/64	15/32			0.45312	11.509		61/64	31/32			0.95312	24.209
31/64				0.46875	11.906						0.96875	24.606
			1/2	0.48438	12.303		63/64				0.98438	25.033
				0.50000	12.700						1.00000	25.400



**Information**

**Formulas - Electrical**

$$\text{VOLTS} = \frac{\text{Watts}}{\text{Amps}} \quad \sqrt{\text{Watts} \times \text{Ohms}}$$

*Amps x Ohms*

$$\text{AMPS} = \frac{\text{Watts}}{\text{Volts}} \quad \sqrt{\frac{\text{Watts}}{\text{Ohms}}}$$

*Volts / Ohms*

$$\text{WATTS} = \text{Volts} \times \text{Amps} \quad \text{Amps}^2 \times \text{Ohms} \quad \frac{\text{Volts}^2}{\text{Ohms}}$$

$$\text{OHMS} = \frac{\text{Volts}}{\text{Amps}} \quad \frac{\text{Volts}^2}{\text{Watts}} \quad \frac{\text{Watts}}{\text{Amps}^2}$$

$$\text{Power Factor} = \frac{\text{KW}}{\text{KVA}} = \text{Cos } \theta$$

<b>Single Phase</b>	<b>Three Phase</b>
$\text{KW} = \frac{\sqrt{x} \times A \times \text{PF}}{1000}$	$\frac{\sqrt{3} \times V \times A \times \text{PF}}{1000}$

$\text{KVA} = \frac{V \times A}{1000}$	$\frac{\sqrt{3} \times V \times A}{1000}$
--	---

$\text{AMPS} = \frac{\text{KVA} \times 1000}{V}$	$\frac{\text{KVA} \times 1000}{\sqrt{3} \times V}$
--	--

$$\sqrt{3} = 1.73$$

*Approx. Motor KVA = Motor Horsepower (At Full Load)*

*Capacitors Connected In Parallel C<sub>1</sub> + C<sub>2</sub> + C<sub>3</sub> = C Total*

*Capacitors Connected In Series*

<b>For Two</b>	<b>More Than Two</b>
$\frac{C_1 \times C_2}{C_1 + C_2} = C \text{ Total}$	$\frac{1}{\frac{1}{C_1} + \frac{1}{C_2} + \frac{1}{C_3}} = C \text{ Total}$

**VOLTAGE UNBALANCE**

*% Voltage Unbalance =*

$$\frac{100 \times \text{Max. Voltage Deviation From Average Voltage}}{\text{Average Voltage}}$$

**BOOST TRANS.:**

*Rating Plate F.L.A. x Rating Plate VOLTS = KVA*

$$\frac{\text{Rating Plate VOLTS}}{\text{Rating Plate VOLTS} - \text{Norm. Line VOLTS}} = \text{FACTOR}$$

$$\frac{\text{KVA}}{\text{FACTOR}} = \text{Trans. KVA Rating}$$

$$\left(\frac{V_2}{V_1}\right)^2 \times \text{Heater Rating} = \text{Rating @ New Voltage}$$

*V<sub>1</sub> Rated Volts V<sub>2</sub> = Measured Volts*

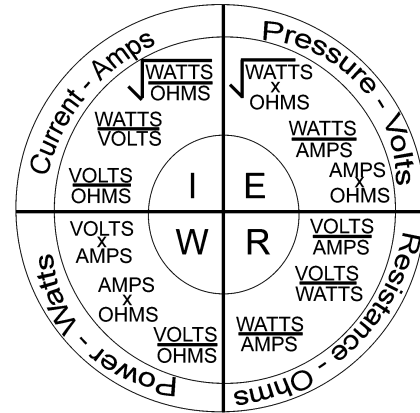

This chart shows four ways to figure each value: Amps (I), Volts (E), Ohms (R) or Watts (W).

**Example:** A 4800 Watt electric heat element is connected to a 240 Volt circuit. How many Amps does it draw?

**Solution:** Locate Amps section of chart:  $\frac{\text{Watts (W)}}{\text{Volts (E)}} = \text{Amps (I)}$

Thus  $4800 \div 240 = 20$  Amps. Carried further, what is the resistance?

$$\frac{\text{Volts}^2 E^2}{\text{Watts (W)}} = \text{Ohms (R)} \quad 240 \times 240 \div 4800 = 12 \text{ Ohms.}$$

Conversion Table For  
Watts - Amperes - Volts

Watts	Voltage ( C - Single Phase)			
	120	208	240	277
	Amperes			
500	4.2	2.4	2.1	1.8
1000	8.3	4.8	4.2	3.8
1500	12.5	7.2	6.3	5.4
2000	16.7	9.6	8.3	7.2
2500	20.9	12.0	10.4	9.0
3000	25.0	14.4	12.5	10.6
3500	29.2	16.8	14.5	12.6

Information

**Information**

Information

**Residential Duct Sizing Guide**

The following duct sizes are based on a friction drop of .10 inches per 100 feet of lineal duct. This "Equal-Friction" method of duct sizing should be adequate for normal residential furnace heating and air conditioning applications. Larger air volumes or higher static pressures should be dealt with on an individual job basis.

**Rectangular and Round Duct**

Air Volume CFM	Duct Height Inches					Equivalent Round Duct"	Air Volume CFM
	4"	6"	8"	10"	12"		
50	6 x 4					5	50
75	6 x 4					6	75
100	8 x 4	6 x 6				6	100
125	10 x 4	6 x 6				7	125
150	10 x 4	8 x 6				7	150
175	12 x 4	8 x 6				8	175
200	14 x 4	8 x 6				8	200
225	16 x 4	10 x 6				8	220
250	16 x 4	10 x 6				9	250
275		12 x 6	8 x 8			9	275
300		12 x 6	8 x 8			9	300
400		14 x 6	10 x 8			10	400
500		18 x 6	12 x 8	10 x 10		11	500
600		20 x 6	14 x 8	12 x 10		12	600
700		24 x 6	16 x 8	12 x 10		12	700
800		26 x 6	18 x 8	14 x 10	12 x 12	13	800
900		30 x 6	20 x 8	16 x 10	12 x 12	14	900
1000			22 x 8	16 x 10	14 x 12	14	1000
1100			24 x 8	18 x 10	16 x 12	15	1100
1200			26 x 8	20 x 10	16 x 12	15	1200
1300			28 x 8	20 x 10	18 x 12	16	1300
1400			30 x 8	22 x 10	18 x 12	16	1400
1500				24 x 10	20 x 12	16	1500
1600				24 x 10	20 x 12	17	1600
1700				26 x 10	22 x 12	17	1700
1800				28 x 10	22 x 12	18	1800
1900				30 x 10	22 x 12	18	1900
2000					24 x 12	18	2000

**Suggested Air Changes**

Type of Building	Minute Air Change
Assembly halls	3 - 10
Auditoriums	4 - 15
Bakeries	1 - 3
Banks	3 - 10
Bars	2 - 4
Beauty parlors	2 - 5
Boiler rooms	2 - 4
Bowling alleys	2 - 8
Churches	4 - 15
Corridors	6 - 20
Dry cleaners	1 - 5
Engine rooms	1 - 1.5
Factor (gen. vent.)	5 - 10
Factory (fumes)	1 - 5
Forge shops	1 - 2
Foundries	1 - 4
Garages (repairs)	2 - 10
Generating rooms	2 - 5
Glass plants	1 - 2
Gymnasiums	2 - 10
Heat treat rooms	0.5 - 1
Kitchens	1 - 3
Laundries	2 - 5
Locker rooms	2 - 5
Machine shops	3 - 5
Mills (paper)	2 - 3
Mills (textile)	5 - 15
Offices	2 - 8
Packing houses	2 - 5
Production rooms	1 - 2
Projection rooms	1 - 3
Recreation rooms	2 - 8
Residences	2 - 5
Restaurants	5 - 10
Retail stores	3 - 10
Sales rooms	3 - 10
Shops (gen. vent.)	3 - 10
Stores	5 - 10
Theaters	3 - 8
Toilets	2 - 5
Transformer rooms	1 - 5
Turbine room elec.	2 - 6
Waiting rooms	10
Warehouses	2 - 10

In selecting the size and capacity of a fan, find the total cubic feet of air space of the building and divide by the number of air changes necessary to give proper ventilation.

$$CFM = \frac{\text{Building volume in cubic feet}}{\text{Minute air change}}$$

**Example:**  
A building 100' long x 60' wide with a 20' ceiling:  
Multiply 100 x 60 x 20 = 120,000 cubic feet. Assuming a 6 minute air change is required: 120,000 cubic feet of air divided by 6 gives you 20,000 CFM required to change the air every 6 minutes.

**Information**

**Airflow Versus Temperature Rise**

HEAT OUTPUT		AIRFLOW – CUBIC FEET PER MINUTE																															
		400	500	600	700	800	900	1000	1100	1200	1300	1400	1500	1600	1700	1800	1900	2000	2100	2200	2300	2400	2500	2600	2700	2800	2900	3000	3100	3200	3300		
KW	BTU	TEMPERATURE RISE – DEGREES FAHRENHEIT																															
3	10242	24	19	16	14	12																											
4	13656	32	25	21	18	16	14	13																									
5	17070	39	32	26	23	20	18	16	14	13																							
6	20484	47	38	32	27	24	21	19	17	16	15	14																					
7	23898	55	44	37	32	28	25	22	20	18	17	16	15	14																			
8	27312	63	51	42	36	32	28	25	23	21	19	18	17	16	15	14																	
9	30726	71	57	47	41	36	32	28	26	24	22	20	19	18	17	16	15	14															
10	34140	79	63	53	45	39	35	32	29	26	24	22	21	20	19	18	17	16	15	14													
11	37554	87	69	58	50	43	39	35	32	29	27	25	23	22	20	19	18	17	16	15	14	13											
12	40968	95	76	63	54	47	42	38	34	32	29	27	25	24	22	21	20	19	18	17	16	15	14										
13	44382		82	68	58	51	46	41	37	34	32	29	27	26	24	23	22	21	20	19	18	17	16	15									
14	47796		89	74	63	55	49	44	40	37	34	32	30	28	26	25	23	22	21	20	19	18	17	16	15								
15	51210		95	79	68	59	53	47	43	39	36	34	32	30	28	26	25	24	23	22	21	20	19	18	17	16							
16	54624		84	72	64	56	50	46	42	38	36	34	32	30	28	27	25	24	23	22	21	20	19	18	17	16							
17	58038		89	77	67	60	54	49	45	41	38	36	34	32	30	28	27	26	24	23	22	21	20	19	18	17	16						
18	61452			95	82	72	64	56	52	48	44	40	38	36	34	32	30	28	27	26	25	24	23	22	20	19	18	17	16				
19	64866			86	75	67	60	55	50	46	42	40	38	36	34	32	30	29	27	26	25	24	23	22	21	20	19	18	17				
20	68280				90	79	70	63	57	53	49	45	42	40	37	35	33	32	30	29	27	26	25	24	23	22	21	20	20	19			
21	71694				95	83	74	66	60	55	51	47	44	41	39	37	35	33	32	30	29	28	27	26	25	24	23	22	21	21	20		
22	75108					99	87	77	69	63	58	53	50	46	43	41	39	37	35	33	32	30	29	28	27	26	25	24	23	22	21		
23	78522						91	81	73	66	61	56	52	48	45	43	40	38	36	35	33	32	30	29	28	27	26	25	24	23	23	22	
24	81936						95	84	76	69	63	58	54	51	47	45	42	40	38	36	34	33	32	30	29	28	27	26	25	24	24	23	
25	85350						99	88	79	72	66	61	56	53	49	46	44	42	40	38	36	34	33	32	30	29	28	27	26	25	25	24	
26	88764							91	82	75	68	63	59	55	51	48	46	43	41	39	37	36	34	33	32	30	29	28	27	26	26	25	
27	92178								95	85	78	71	66	61	57	53	50	47	45	43	41	39	37	36	34	33	32	30	29	28	27	26	
28	95592								98	88	80	74	68	63	59	55	52	49	47	44	42	40	38	37	35	34	33	32	31	30	29	28	27
29	99006									92	83	76	71	65	61	57	54	51	48	46	44	42	40	38	37	35	34	33	32	31	30	29	28
30	102420									95	86	79	73	68	63	59	56	53	50	47	45	43	41	40	38	36	35	34	33	32	31	30	29

Information

**Capacity of Gas Piping  
Cu. Ft. Per Hour**

(At pressure drop of 0.3 in. water. Specific gravity – 0.60.)

Pipe Lgth. Ft.	Iron Pipe Size (IPS) Inches								
	1/2	3/4	1	1-1/4	1-1/2	2	2-1/2	3	4
10	132	278	520	1050	1600	3050	4800	8500	17,500
20	92	190	350	730	1100	2100	3300	5900	12,000
30	73	152	285	590	890	1650	2700	4700	9700
40	63	130	245	500	760	1450	2300	4100	8300
50	56	115	215	440	670	1270	2000	3600	7400
60	50	105	195	400	610	1150	1850	3250	6800
70	46	96	180	370	560	1050	1700	3000	6200
80	43	90	170	350	530	990	1600	2800	5800
90	40	84	160	320	490	930	1500	2600	5400
100	38	79	150	305	460	870	1400	2500	5100
125	34	72	130	275	410	780	1250	2200	4500
150	31	64	120	250	380	710	1130	2000	4100
175	28	59	110	225	350	650	1050	1850	3800
200	26	55	100	210	320	610	980	1700	3500

**Gas Piping Information**

**TABLE 402.3(1)**  
**MAXIMUM CAPACITY OF PIPE IN CUBIC FEET OF GAS PER HOUR FOR GAS PRESSURES OF 0.5 PSI OR LESS AND A PRESSURE DROP OF 0.3-INCH WATER COLUMN**  
**Based on a 0.60 Specific Gravity Gas**

NOMINAL IRON PIPE SIZE (inches)	INTERNAL DIAMETER (inches)	LENGTH OF PIPE (feet)													
		10	20	30	40	50	60	70	80	90	100	125	150	175	200
1/4	.364	32	22	18	15	14	12	11	11	10	9	8	8	7	6
3/8	.493	72	49	40	34	30	27	25	23	22	21	18	17	15	14
1/2	.622	132	92	73	63	56	50	46	43	40	38	34	31	28	26
3/4	.824	278	190	152	130	115	105	96	90	84	79	72	64	59	55
1	1.049	520	350	285	245	215	195	180	170	160	150	130	120	110	100
1 1/4	1.380	1,050	730	590	500	440	400	370	350	320	305	275	250	225	210
1 1/2	1.610	1,600	1,100	890	760	670	610	560	530	490	460	410	380	350	320
2	2.067	3,050	2,100	1,650	1,450	1,270	1,150	1,050	990	930	870	780	710	650	610
2 1/2	2.469	4,800	3,300	2,700	2,300	2,000	1,850	1,700	1,600	1,500	1,400	1,250	1,130	1,050	980
3	3.068	8,500	5,900	4,700	4,100	3,600	3,250	3,000	2,800	2,600	2,500	2,200	2,000	1,850	1,700
4	4.026	17,500	12,000	9,700	8,300	7,400	6,800	6,200	5,800	5,400	5,100	4,500	4,100	3,800	3,500

For SI: 1 inch = 25.4 mm, 1 foot = 304.8 mm, 1 cubic foot per hour = 0.0283 m<sup>3</sup>/h, 1 pound per square inch = 6.895 kPa, 1-inch water column = 0.2488 kPa.

**TABLE 402.3(2)**  
**MAXIMUM CAPACITY OF PIPE IN CUBIC FEET OF GAS PER HOUR FOR GAS PRESSURES OF 0.5 PSI OR LESS AND A PRESSURE DROP OF 0.5-INCH WATER COLUMN**  
**Based on a 0.60 Specific Gravity Gas**

NOMINAL IRON PIPE SIZE (inches)	INTERNAL DIAMETER (inches)	LENGTH OF PIPE (feet)													
		10	20	30	40	50	60	70	80	90	100	125	150	175	200
1/4	.364	43	29	24	20	18	16	15	14	13	12	11	10	9	8
3/8	.493	95	65	52	45	40	36	33	31	29	27	24	22	20	19
1/2	.622	175	120	97	82	73	66	61	57	53	50	44	40	37	35
3/4	.824	360	250	200	170	151	138	125	118	110	103	93	84	77	72
1	1.049	680	465	375	320	285	260	240	220	205	195	175	160	145	135
1 1/4	1.380	1,400	950	770	660	580	530	490	460	430	400	360	325	300	280
1 1/2	1.610	2,100	1,460	1,180	990	900	810	750	690	650	620	550	500	460	430
2	2.067	3,950	2,750	2,200	1,900	1,680	1,520	1,400	1,300	1,220	1,150	1,020	950	850	800
2 1/2	2.469	6,300	4,350	3,520	3,000	2,650	2,400	2,250	2,050	1,950	1,850	1,650	1,500	1,370	1,280
3	3.068	11,000	7,700	6,250	5,300	4,750	4,300	3,900	3,700	3,450	3,250	2,950	2,650	2,450	2,280
4	4.026	23,000	15,800	12,800	10,900	9,700	8,800	8,100	7,500	7,200	6,700	6,000	5,500	5,000	4,600

For SI: 1 inch = 25.4 mm, 1 foot = 304.8 mm, 1 cubic foot per hour = 0.0283 m<sup>3</sup>/h, 1 pound per square inch = 6.895 kPa, 1-inch water column = 0.2488 kPa.

## Meter Clocking Method

Information

### Meter Clocking Method

**Caution:** Make certain there is no gas flow through the meter other than to the appliance being checked.  
Use Table to determine exact rate of gas flow to appliance.

#### METER FLOW RATE – CUBIC FEET PER HOUR (cfh).

To convert cfh to cubic meter per hour (M<sup>3</sup>/hr) multiply by .0283.

Sec for One Rev.	Meter Dial Used - Cu. Ft. per Rev.		Sec for One Rev.	Meter Dial Used - Cu. Ft. per Rev.			Sec for One Rev.	Meter Dial Used - Cu. Ft. per Rev.		
	1/2	1		1/2	1	2		1	2	5
10	180	360	35	52	103	206	60	60	120	300
11	164	327	36	50	100	200	62	58	116	290
12	150	300	37	49	97	195	64	56	112	281
13	139	277	38	48	95	189	66	55	109	273
14	129	257	39	46	92	185	68	53	106	265
15	120	240	40	45	90	180	70	52	103	257
16	113	225	41	44	88	176	72	50	100	250
17	106	212	42	43	86	172	74	49	97	243
18	100	200	43	42	84	167	76	48	95	237
19	95	189	44	41	82	164	78	46	92	231
20	90	180	45	40	80	160	80	45	90	225
21	86	171	46	39	78	157	84	43	86	214
22	82	164	47	38	77	153	88	41	82	205
23	78	157	48	38	75	150	92	39	78	196
24	75	150	49	37	74	147	96	38	75	188
25	72	144	50	36	72	144	100	36	72	180
26	69	138	51	35	71	141	105	34	69	172
27	67	133	52	35	69	138	110	33	66	164
28	64	129	53	34	68	136	120	30	60	150
29	62	124	54	33	67	133	130	28	55	138
30	60	120	55	33	66	131	140	26	52	129
31	58	116	56	32	64	129	150	24	48	120
32	56	113	57	32	63	126	160	23	45	113
33	55	109	58	31	62	124	170	21	43	106
34	53	106	59	31	61	122	180	20	40	100

To convert meter flow rate (cfh) to BTU per hour, multiply cfh (from table above) by the BTU heat content of the gas being used.

To convert input rating (BTU per hour as stamped on appliance nameplate) to meter flow rate (cfh).

Input rating in BTU per hour.

Input BTU/Hr. Per Spud	Natural Gas 1020 BTU - .65 SG 3-1/2" WC Manifold		Propane 2500 BTU - 1.5 SG 11" WC Manifold	
	Drill Size	Decimal Tolerance	Drill Size	Decimal Tolerance
12,000	51	.064 - .067	60	.038 - .040
15,000	48	.073 - .076	58	.040 - .042
20,000	43	.086 - .089	55	.050 - .052
25,000	41	.093 - .096	53	.056 - .059
27,500	39	.097 - .100	53	.060 - .063
40,000	32	.113 - .116	49	.070 - .073
50,000	30	.124 - .128	46	.078 - .081
60,000	27	.140 - .144	43	.086 - .089
70,000	22	.153 - .157	42	.090 - .093
80,000	20	.156 - .161	40	.095 - .098
90,000	17	.168 - .173	38	.098 - .101
100,000	13	.180 - .185	35	.107 - .110
105,000	11	.186 - .191	34	.108 - .111
110,000	10	.188 - .193	33	.109 - .113
125,000	5	.200 - .205	1/8	.121 - .125
135,000	3	.208 - .213	30	.124 - .128
140,000	7/32	.214 - .219	30	.124 - .128
150,000	1	.223 - .228	29	.132 - .136
160,000	A	.229 - .234	28	.136 - .140
175,000	C	.237 - .242	27	.140 - .144
190,000	E	.245 - .250	25	.145 - .149
200,000	F	.252 - .257	23	.150 - .154
210,000	H	.261 - .266	21	.154 - .159
220,000	I	.267 - .272	20	.156 - .161
240,000	K	.276 - .281	18	.164 - .169
260,000	M	.290 - .295	16	.172 - .177
280,000	5/16	.307 - .312	13	.180 - .185
300,000	O	.311 - .316	11	.186 - .191
310,000	P	.318 - .323	9	.191 - .196
320,000	21/64	.323 - .328	7	.196 - .201

Information

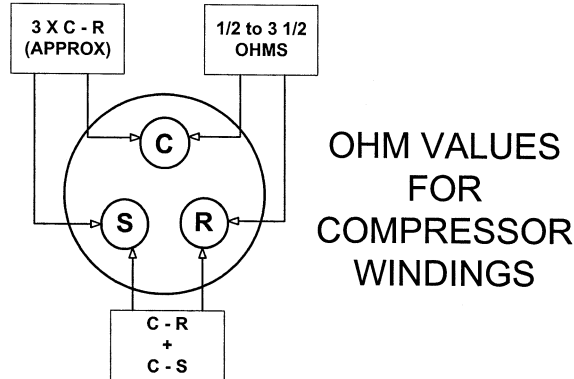

Remove compressor wires before taking the following readings:

**Reading 1:** Common to Run = 1/2 to 3-1/2 Ohms.

**Reading 2:** Common to Start = Common to Run value x 3

**Reading 3:** Start to Run = Reading 1 + Reading 2

**Procedure for Starting a Compressor  
the First Time**

Energize compressor for maximum of 2 seconds, then let it sit for 1/2 minute. Repeat process three times, adding 1 second to each successive run cycle, for a total of four operations. Now energize the compressor for 15 seconds and leave it off 1/2 minute.

**1st Cycle:** On 2 seconds, off 30 seconds

**2nd Cycle:** On 3 seconds, off 30 seconds

**3rd Cycle:** On 4 seconds, off 30 seconds

**4th Cycle:** On 5 seconds, off 30 seconds

**5th Cycle:** On 15 seconds, off 30 seconds

The short run time between cycles minimizes pressure change in compressor shell and greatly reduces oil foaming. The 1/2 minute off time allows oil to settle back into the sump. It is now safe to operate the compressor without loss of lubrication. This entire process takes less than five minutes.

If the compressor fails to start on the first bump, wait 10 minutes and try again. If it fails to start after the 3rd bump, temporarily install a Kickstart in parallel with the run capacitor. It should not be necessary to leave the Kickstart in place once the 5-cycle bump has been completed.

**Information**

Information

**Subcooling Method  
of Refrigerant Charging**

For TXV-Equipped Systems

- 1) Operate unit for minimum of 15 minutes before checking charge.
- 2) Measure liquid line temp. leaving condensing unit. Take pressure reading at liquid line service valve and convert pressure to saturated temperature.
- 3) The difference between the liquid line temp. and saturated gauge temp. is the subcooling value.
- 4) If the measured liquid line subcooling is more than required subcooling, remove refrigerant. If the measured liquid line subcooling is less than required subcooling, add refrigerant.

**Superheat Method  
of Refrigerant Charging**

For Orifice or Capillary Tube Systems

- 1) Operate unit for minimum of 15 minutes before checking charge.
- 2) Measure entering wet bulb temperature of evaporator, entering dry bulb temperature at condenser, suction line temperature and suction pressure, and convert the pressure to saturated temperature.
- 3) Using charging table, locate the entering condenser air temperature and the entering evaporator temperature to determine recommended superheat temperature.
- 4) Calculate the actual superheat by subtracting the saturated suction temperature from the actual suction line temperature at the outdoor unit.
- 5) If the actual superheat is greater than the recommended value, charge must be added. If the actual superheat is less than the recommended value, charge must be removed.

**HVAC Troubleshooting Data**

<p>* Suction Pressure <input type="text"/></p> <p>* Suction Line Temp <input type="text"/></p> <p>Suction Saturation <input type="text"/></p> <p>Suction Superheat <input type="text"/></p> <p>* Liquid Pressure <input type="text"/></p> <p>Liquid Saturation <input type="text"/></p> <p>* Liquid Line Temp <input type="text"/></p> <p>Subcooling <input type="text"/></p> <p>Discharge Pressure <input type="text"/></p> <p>* Discharge Line Temp <input type="text"/></p> <p>Discharge Saturation <input type="text"/></p> <p>Disch. Superheat <input type="text"/></p>	<p>* Outdoor DB <input type="text"/></p> <p>* Entering DB <input type="text"/></p> <p>* Leaving DB <input type="text"/></p> <p>Delta T DB <input type="text"/></p> <p style="text-align: center;">Enthalpy (THC)</p> <p>* Entering WB <input type="text"/></p> <p>* Leaving WB <input type="text"/></p> <p>Delta THC <input type="text"/></p> <p>* Volts <input type="text"/></p> <p>* Amps <input type="text"/></p>
---	---

	Model	Serial
Outdoor Unit	<input type="text"/>	<input type="text"/>
Coil	<input type="text"/>	<input type="text"/>
Indoor Unit	<input type="text"/>	<input type="text"/>

**NOTE:** Measure and record all data indicated with a \* before calling for assistance.

Information

**Basic System Analysis**

System Problem	Discharge Pressure	Suction Pressure	Superheat	Subcooling	Amps
Overcharge	↑	↑	↓	↑	↑
Undercharge	↓	↓	↑	↓	↓
Liquid Restriction (Drier)	↓	↓	↑	↑	↓
Low Evaporator Airflow	↓	↓	↓	↑	↓
Dirty Condenser	↑	↑	↓	↓	↑
Low Outside Ambient Temperature	↓	↓	↑	↑	↓
Inefficient Compressor	↓	↑	↑	↑	↓
TXV Feeler Bulb Charge Lost	↓	↓	↑	↑	↓
TXV Feeler Bulb Loose Mounted	↑	↑	↓	↓	↑
Poorly Insulated Feeler Bulb	↑	↑	↓	↓	↑



**Information**

Information

**Basic Refrigeration Cycle**

Mechanical refrigeration is accomplished by a continuously circulating, evaporating and condensing a fixed supply of refrigerant in a closed system. Evaporation occurs at a low temperature and low pressure while condensation occurs at a high temperature and high pressure. Thus, it is possible to transfer heat from an area of low temperature (i.e., refrigerator cabinet) to an area of high temperature (i.e., kitchen).

Beginning the cycle at the evaporator inlet (1) the low pressure liquid expands, absorbs heat and evaporates, changing to a low pressure gas at the evaporator outlet (2).

The compressor (4) pumps this gas from the evaporator through the accumulator (3), increases its pressure, and discharges the high pressure gas to the condenser (5). The accumulator is designed to protect the compressor by preventing slugs of liquid refrigerant from passing directly into the compressor. An accumulator should be included on all systems subjected to varying load conditions or frequent compressor cycling. In the condenser, heat is removed from the gas, which then condenses and becomes a high pressure liquid. In some systems, this high pressure liquid drains from the condenser into a liquid storage or receiver tank (6). On other systems, both the receiver and the liquid line valve (7) are omitted.

A heat exchanger (8) between the liquid line and the suction line is also an optional item, which may or may not be included in a given system design.

Between the condenser and the evaporator an expansion device (10) is located. Immediately preceding this device is a liquid line strainer/drier (9), which prevents plugging of the valve or tube by retaining scale, dirt and moisture. The flow of refrigerant into the evaporator is controlled by the pressure differential across the expansion device or, in the case of a thermal expansion valve, by the degree of superheat of the suction gas. Thus, the thermal expansion valve shown requires a sensor bulb located at the evaporator outlet. In any case, the flow of refrigerant into the evaporator normally increases as the evaporator load increases.

As the high pressure liquid refrigerant enters the evaporator, it is subjected to a much lower pressure due to the suction of the compressor and the pressure drop across the expansion device. Thus, the refrigerant tends to expand and evaporate. In order to evaporate, the liquid must absorb heat from the air passing over the evaporator.

Eventually, the desired air temperature is reached and the thermostat or cold control (11) will break the electrical circuit to the compressor motor and stop the compressor.

As the temperature of the air through the evaporator rises, the thermostat or cold control remakes the electrical circuit. The compressor starts, and the cycle continues.

In addition to the accumulator, a compressor crankcase heater (12) is included on many systems. This heater prevents accumulation of refrigerant in the compressor crankcase during the nonoperating periods and prevents liquid slugging or oil pump-out on startup.

Additional protection to the compressor and system is afforded by a high and low pressure cutout (13). This control is set to stop the compressor in the event that the system pressures rise above or fall below the design operating range.

Other controls not indicated on the basic cycle which may be part of a system include: evaporator pressure regulators, hot gas by-pass regulators, electric solenoid valves, suction pressure regulators, condenser pressure regulators, low side or high side float refrigerant controllers, oil separators, etc.

It is extremely important to analyze completely every system and understand the intended function of each component before attempting to determine the cause of a malfunction or failure.

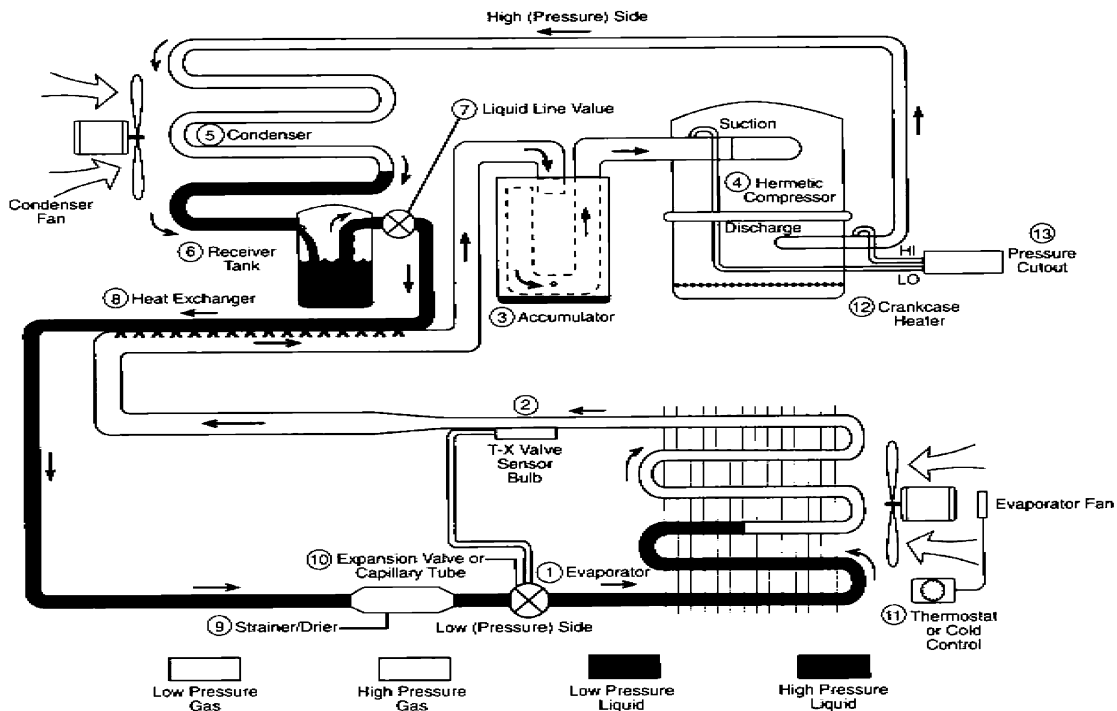

**Information**

Information

PROBLEM	POSSIBLE CAUSES	POSSIBLE CORRECTIVE STEPS
Compressor will not run	<ol style="list-style-type: none"> <li>1. Main switch open.</li> <li>2. Fuse blown.</li> <li>3. Thermal overloads tripped.</li> <li>4. Defective contactor or coil.</li> <li>5. System shut down by safety devices.</li> <li>6. No cooling required.</li> <li>7. Liquid line solenoid will not open.</li> <li>8. Motor electrical trouble.</li> <li>9. Loose wiring.</li> <li>10. Phase loss monitor inoperative.</li> </ol>	<ol style="list-style-type: none"> <li>1. Close switch.</li> <li>2. Check electrical circuits and motor winding for shorts or grounds. Investigate for possible overloading. Replace fuse after fault is corrected.</li> <li>3. Overloads are automatically reset. Check unit closely when unit comes back on line.</li> <li>4. Repair or replace.</li> <li>5. Determine type and cause of shutdown and correct it before resetting safety switch.</li> <li>6. None. Wait until calls for cooling.</li> <li>7. Repair or replace coil.</li> <li>8. Check motor for open windings, short circuit or burn out.</li> <li>9. Check all wire junctions. Tighten all terminal screws.</li> <li>10. Refer to page 18.</li> </ol>
Compressor noisy or vibrating	<ol style="list-style-type: none"> <li>1. Flooding of refrigerant into crankcase.</li> <li>2. Improper piping support on suction or liquid line.</li> <li>3. Worn compressor.</li> <li>4. Scroll compressor rotation reversed.</li> </ol>	<ol style="list-style-type: none"> <li>1. Check setting of expansion valves.</li> <li>2. Relocate, add or remove hangers.</li> <li>3. Replace.</li> <li>4. Rewire for phase change.</li> </ol>
High discharge pressure	<ol style="list-style-type: none"> <li>1. Non-condensables in system.</li> <li>2. System overcharges with refrigerant.</li> <li>3. Discharge shutoff valve partially closed.</li> <li>4. Fan not running.</li> <li>5. Head pressure control setting.</li> <li>6. Dirty condenser coil.</li> </ol>	<ol style="list-style-type: none"> <li>1. Remove the non-condensables.</li> <li>2. Remove excess.</li> <li>3. Open valve.</li> <li>4. Check electrical circuit.</li> <li>5. Adjust.</li> <li>6. Clean.</li> </ol>
Low discharge pressure	<ol style="list-style-type: none"> <li>1. Faulty condenser temperature regulation.</li> <li>2. Suction shutoff valve partially closed.</li> <li>3. Insufficient refrigerant in system.</li> <li>4. Low suction pressure.</li> <li>5. Variable head pressure valve.</li> </ol>	<ol style="list-style-type: none"> <li>1. Check condenser control operation.</li> <li>2. Open valve.</li> <li>3. Check for leaks. Repair and add charge.</li> <li>4. See corrective steps for low suction pressure.</li> <li>5. Check valve setting.</li> </ol>
High suction pressure	<ol style="list-style-type: none"> <li>1. Excessive load.</li> <li>2. Expansion valve overfeeding.</li> </ol>	<ol style="list-style-type: none"> <li>1. Reduce load or add additional equipment.</li> <li>2. Check remote bulb. Regulate superheat.</li> </ol>
Low suction pressure	<ol style="list-style-type: none"> <li>1. Lack of refrigerant.</li> <li>2. Evaporator dirty or iced.</li> <li>3. Clogged liquid line filter drier.</li> <li>4. Clogged suction line or compressor suction gas strainers.</li> <li>5. Expansion valve malfunctioning.</li> <li>6. Condensing temperature too low.</li> <li>7. Improper TXV.</li> </ol>	<ol style="list-style-type: none"> <li>1. Check for leaks. Repair and add charge.</li> <li>2. Clean.</li> <li>3. Replace cartridge(s).</li> <li>4. Clean strainers.</li> <li>5. Check and reset for proper superheat.</li> <li>6. Check means for regulating condensing temperature.</li> <li>7. Check for proper sizing.</li> </ol>
Little or no oil pressure	<ol style="list-style-type: none"> <li>1. Clogged suction oil strainer.</li> <li>2. Excessive liquid in crankcase.</li> <li>3. Low oil pressure safety switch defective.</li> <li>4. Worn oil pump.</li> <li>5. Oil pump reversing gear stuck in wrong position.</li> <li>6. Worn bearings.</li> <li>7. Low oil level.</li> <li>8. Loose fitting on oil lines.</li> <li>9. Pump housing gasket leaks.</li> </ol>	<ol style="list-style-type: none"> <li>1. Clean.</li> <li>2. Check crankcase heater. Reset expansion valve for higher superheat. Check liquid line solenoid valve operation.</li> <li>3. Replace.</li> <li>4. Replace.</li> <li>5. Reverse direction of compressor rotation.</li> <li>6. Replace compressor.</li> <li>7. Add oil and/or through defrost.</li> <li>8. Check and tighten system.</li> <li>9. Replace gasket.</li> </ol>
Compressor loses oil	<ol style="list-style-type: none"> <li>1. Lack of refrigerant.</li> <li>2. Excessive compression ring blowby.</li> <li>3. Refrigerant flood back.</li> <li>4. Improper piping or traps.</li> </ol>	<ol style="list-style-type: none"> <li>1. Check for leaks and repair. Add refrigerant.</li> <li>2. Replace compressor.</li> <li>3. Maintain proper superheat at compressor.</li> <li>4. Correct piping.</li> </ol>
Compressor thermal protector switch open.	<ol style="list-style-type: none"> <li>1. Operating beyond design conditions.</li> <li>2. Discharge valve partially shut.</li> <li>3. Blown valve plate gasket.</li> <li>4. Dirty condenser coil.</li> <li>5. Overcharged system.</li> </ol>	<ol style="list-style-type: none"> <li>1. Add facilities so that conditions are within allowable limits.</li> <li>2. Open valve.</li> <li>3. Replace gasket.</li> <li>4. Clean coil.</li> <li>5. Reduce charge.</li> </ol>

**Older Furnace IFC Fault Codes**

	<b>Single Stage</b> 031-01266-000 (W/R 50A50-241) 031-01267-001 (TI 6IF-3) 031-01993-000 (UT 1012-965)	<b>2-Stage Deluxe</b> 031-01290-000 (W/R 50A51-242) w/PSC Motor	<b>2-Stage Ultra</b> 031-01909-000 (W/R 50A51-243) w/ECM Motor	
<b>Fault Code Flashes</b>	<b>Fault Condition</b>			<b>Possible Causes - Check</b>
<b>Steady Off</b>	No power to the board			24 VAC, Fuse
<b>Continuous Flash</b>	Flame sensed when it should not be present.			Gas Valve, Wiring
<b>2-Flash</b>	Pressure switch stuck closed.			Pressure Switch, Wiring
<b>3-Flash</b>	Pressure switch stuck open.			Pressure Switch, Ventor Motor
<b>4-Flash</b>	Limit switch open.	Limit switch or rollout open.		Main Limit, Blower, Filter
<b>5-Flash</b>	Rollout switch open.	N/A		Rollout Switch, Overfired
<b>6-Flash</b>	<b>W/R</b>	Pressure switch opened 5 times during a call for heat.		Same As Code 3
	<b>TI /UT</b>	Reversed line voltage polarity		L1 & Neutral, XFMR Ground, Connections
<b>7-Flash</b>	<b>W/R</b>	No flame sensed at start of cycle.		Same as Code 8 & 9
	<b>TI /UT</b>	One hour pressure switch lockout. Pressure switch cycled 4 times during a single call for heat.		Same As Code 3
<b>8-Flash</b>	<b>W/R</b>	Flame sensed but lost 5 times during a single cycle.		Gas- Flow, Pressure, Valve; Flame Sensor
	<b>TI /UT</b>	One hour ignition lockout. Burner failed to light in 3 tries.		
<b>9-Flash</b>	<b>TI/UT Only</b>	One hour ignition lockout. 5 recycles during a single call for heat.		
<b>Continuous Light</b>	Internal control fault.			Reset Power- Replace Control
<p>Most faults will reset themselves or will be reset by the 1-hour "Watch-Dog" circuit. Auxiliary limits and rollouts are manual reset. Continuous Flash and Continuous Light are "Hard Lock-Outs". To reset any condition, turn power off for 30 seconds, then turn back on.</p> <p>The 031-01290-000 board can <b>only</b> be used with the 2-stage multi-speed furnaces. <b>DO NOT</b> use this board with the variable speed furnace.</p>				

Information

Information

**33" Modulating Furnace Fault Codes**

Information

Code	Description	Response Comments	Probable Cause	Solutions
1 Red Flash	Improper Flame Sensed	Flame is sensed when gas valve is not energized.	A. Flame remains lit in "Off" cycle.	1. Gas valve leaks - check wiring to remove continuous 24V to gas valve. 2. Gas valve is stuck open – replace gas valve.
2 Red Flashes	Pressure switch contacts are closed when they should be open	The control validates combustion air comparing the pressure switch and pressure transducer values. If they do not agree, the unit locks out.	A. Faulty wiring or connections.	1. Check pressure switch wiring. 2. Check inducer wiring. 3. Check for broken or disconnected air tube hoses. 4. Check air inlet and outlet for blockage. 5. Check inlet stack length.
			B. Faulty pressure switch.	1. Replace pressure switch.
			C. Faulty pressure transducer	1. Replace transducer.
3 Red Flashes	Pressure switch contacts are open when they should be closed	The control validates combustion air comparing the pressure switch and pressure sensor values. If they do not agree, the unit locks out.	A. Faulty wiring or connections.	1. Check pressure switch wiring. 2. Check inducer wiring. 3. Check for broken or disconnected pressure switch tubing. 4. Check venting for restriction. 5. Check venting length and size.
			B. Faulty pressure switch.	1. Replace pressure switch.
			C. Faulty Pressure Transducer	1. Replace transducer.
4 Red Flashes	Over temperature in heat exchanger	This is caused by open primary limit string or temperature sensor located in plenum heat exchanger.	A. Improper inlet airflow.	1. Check filter / replace if dirty. 2. Check for improperly sized duct system. 3. Check for faulty blower motor. 4. Check for faulty wiring. 5. Check for temperature sensor connection, reconnect or replace temperature sensor. 6. Check for any open primary limit string switch. 7. Check primary wiring on pins 1 & 2 the four pin plug connector.
	Open onboard fuse	Indicates open onboard fuse	B. Fuse is blown	1. Check and replace fuse on the board.
			C. Temperature Sensor probe not connected.	1. Check Temperature Sensor Probe connection.

Information

**33" Modulating Furnace Fault Codes**

5 Red Flashes	Roll out switch open or blocked drain pressure switch contacts open	This indicates flame roll out into the combustion vestibule has been detected.  <i>Be sure to reset the rollout switch after correcting the failure condition, if it is open.</i>	A. Improper combustion air.	1. Check for proper combustion air. 2. Check for proper inducer operation. 3. Check for primary heat exchanger failure. 4. Check for burner problem. 5. Check for faulty wiring.
			B. Defective roll out switch.	1. Check if rollout switch has failed open. 2. Replace roll out switch.
			C. Blocked drain pressure switch open.	1. Check pressure at blocked drain pressure switch. Replace switch if pressure is correct and switch does not close.
6 Red Flashes	Modulation failure	Indicates an improper ratio of gas and air has been detected.	A. Faulty gas valve.	1. Check for faulty gas valve wiring. 2. Replace modulating gas valve.
			B. Improper combustion airflow	1. Check for proper combustion airflow 2. Check air inlet pipes. 3. Check measurement hoses. 4. Check pressure switch.
			C. Faulty pressure transducer	1. Check pressure sensor and reconnect hoses. 2. Replace Pressure transducer if pressure transducer is broken.
7 Red Flashes	Flame could not be established	This fault code indicates that the flame could not be established during the time provided. This no-light condition occurs after 4 attempts (3 retries) during an initial call for heat. Then the furnace is locked out for one hour and will automatically reset.	A. Insufficient gas line pressure.	1. Ensure gas supply is connected to furnace and check for proper line pressure.
			B. Gas valve control turned "OFF".	1. Turn gas valve to the "ON" position.
			C. No ignition from hot surface igniter.	1. Check igniter voltage and wiring. 2. Replace hot surface igniter.
			D. Faulty gas valve.	1. Check for faulty gas valve wiring. 2. Replace modulating gas valve.
			E. Insufficient manifold pressure, gas valve "ON" at 100% fire.	1. Check 24 VAC to gas valve. 2. Check for 170 – 190 mADC to gas valve. 3. Check inlet gas pressure. 4. Adjust valve for proper manifold pressure at 100% rate. 5. If gas valve will not adjust, replace gas valve.
			F. Burners do not light.	1. Check for proper mounting and placement of hot surface ignitor. 2. Check for proper mounting of the burner assembly.
			G. Burners light and remain lit for about 5 seconds.	1. Check flame rod wiring and connections. 2. Check for proper alignment of flame rod.

Information

**33" Modulating Furnace Fault Codes**

Information

8 Red Flashes	Lost flame signal after flame is established with call for heating	This indicates that the flame sensor signal has been lost after flame is established during a call for heating.	A. Flame sensor coated.	1. Clean flame rod sensor.
			B. Flame sensor improperly mounted or grounded.	1. Check flame sensor wiring and connections. 2. Re-install / replace flame sensor.
			C. Unstable flame pattern.	1. Check that all burner assembly components are properly installed. 2. Check that all seals between the vestibule area and the heat exchanger area are tight. 3. Insure that the combustion door gasket is in place and the door is properly installed.
			D. Low gas pressure.	1. Check for low inlet gas pressure. 2. Replace modulating gas valve.
			E. Flame sensor too hot, shorts to ground.	1. Replace flame sensor.
9 Red Flashes	Reverse line voltage polarity or grounding problem	Furnace ignores call for heating or cooling.	A. Polarity is reversed or faulty.	1. Line voltage polarity at furnace or branch circuit serving the furnace is reversed. 2. Check furnace grounding.
10 Red Flashes	Gas valve circuit shorted to 24 VAC or ground	The control allows the gas on only with call for heating or when in Run 2 modulation in the heating stage. Run 2 is indicated by three AMBER flashes.	A. Faulty gas valve wiring.	1. Check gas valve wiring. 2. Re-install / replace gas valve.
			B. Control Board	1. Check wiring and connections into the gas valve connector on the control board. 2. Replace board.
11 Red Flashes	Main blower failure	This indicates that there is an over temperature condition in the heat exchanger that is not cleared after 5 minutes.	A. Failed blower motor. After 5 minutes in this condition, the control puts the furnace in a continuous lockout.	1. Check wiring to blower. 2. Check blower wheel/re-install. 3. Replace blower motor.
12 Red Flashes	Identity Plug	Furnace does not operate.	A. Furnace Identity Plug is loose or not connected.	1. Check that ID Plug wires are all connected to the proper pin. 2. Connect furnace ID plug to board. 3. Obtain the proper ID Plug from manufacturer.
Steady Red On	Firmware has detected an error	The control has detected a system failure. This means that a component is on , or off, when it should not be.	A. Transformer	1. Check 24-volt transformer for correct output. 2. Check connections and wiring to control board and other components connected to the 24 volt source. 3. Replace if necessary.
			B. Control Board	1. Retry ignition sequence and see if the system responds. 2. Replace control board.

**Sterling Hts, MI - Livonia, MI - Lansing, MI - Grand Rapids, MI - Waterford, MI - Almont, MI - Saginaw, MI**

Information

## 33" Modulating Furnace Fault Codes

Rapid Amber Flash	Flame rod is below 1.5 microampere	Measure flame rod terminals at the control board test points. 1 Volt DC corresponds to 1 microampere at the test point.	A. Loose or incorrect flame rod connections or positioning.	1. Check flame rod wiring and connections. 2. Re-install / replace flame rod.
			B. Flame rod dirty or corroded.	1. Clean and re-install. 2. Replace flame rod. 3. Correct condition causing corrosion.
No Light / LED off	No light indication on LED	This indicates a problem with power to the control board.	A. Check the 120V path to the control board.	1. Check the 120V path to the board including external circuit breakers, disconnects, wires, connections, and furnace door safety switch. 2. Replace control board.

### LOCKOUT STATES WITH AUTOMATIC RESET AFTER LOCKOUT.

The control will automatically reset itself under these conditions:

- a. If the airflow problem is detected after pre-purge and is cleared within 30 seconds with no other pending failures, the system will attempt to re-start
- b. When an overheating condition in the heat exchanger is cleared, no failures are detected for duration of at least 10 seconds, and there are no requests for cooling and heating, the system will attempt to restart.
- c. After a 1-hour reset, if all active failure conditions are cleared during the reset period. To clear the 1-hour reset period immediately, turn the power off and then back on.

### HARD LOCKOUT STATES REQUIRING MANUAL RESET AFTER LOCKOUT.

Detection of a main blower failure puts the furnace into a continuous lockout state. This lockout requires that the furnace power to be turned off and then back on to reset the control and allow an attempt to re-start.







**Special Order**

Information



**Fire Dampers, Radiation Dampers**



**FanTech Residential in-line fans, ceiling, duct mounted, roof mounted etc.**

**HEAT CONTROLLER, INC.**  
Heatcontroller.com

**Packaged Terminal Units(PTAC), Portable Coolers, Packaged  
Wall Mounted Units, Geothermal**



**Heat Transfer Products Boilers & Parts**



**Linesets Inc - Made to Order Any Length**



**Lloyd Smoke & Fire Dampers**



**Concentric Diffusers, curbs, mixing boxes, supports, etc.**



**Mortex - Hydronic Coils & Custom Commercial Coils**



**Make Up Airst, Direct/Indirect Fired**



**Reznor Special Order Parts**



**Commercial ERV's, Economizers, & Concentric Diffusers**

*Curb Adaptors – Made to fit exactly over existing curb.*

*Custom Aluminum Commercial Registers and Diffusers – White or Brushed Aluminum – Multi-shutter or Opposed Blade Dampers*

*Custom made Galvanized Fittings and Boots – Plenums, Return Air Drops, Insulated and Non- Insulated Duct etc.*

*ERV's & HRV's - Available from GeneralAire, Honeywell, Lifebreath, & Broan*

*Spiral Galvanized Duct and Fittings - ordered to the Job Specifications.*

*Custom made Filters - Made to Size - 1", 2" or 4" - several different merv ratings available*

*Custom made Air Conditioner Covers for winter storage*

<b>4</b>	
40# Travel Tack.....	250
<b>5</b>	
<b>5-2-1</b>	
Compressor Saver.....	138
<b>A</b>	
<b>A-Collars</b>	
Galvanized.....	176
A/C Drain Sucker Kit.....	148
A/C Mounting Bracket.....	137
A/C Shine Aerosol Cleaner.....	146
<b>A/C Whips</b>	
Diversitech.....	263
AAB Meter.....	222
<b>Abrasive Cloth</b>	
Diversitech.....	215
<b>Access Doors</b>	
Galvanized.....	178
Access Panel.....	149
Accessories.....	85, 139
<b>Accessory Heads</b>	
Fieldpiece.....	219
<b>Acetylene</b>	
Refill Kits.....	133
Tanks.....	133
Turbotorch Torches.....	132
<b>Adapters</b>	
Galvanized Duct.....	177
<b>Adhesive Hangers</b>	
Durodyne.....	258
<b>Adhesives</b>	
Boss.....	247
Durodyne Insulation.....	251
Insulation.....	251
<b>Adjustable Roof Jacks</b>	
Red-T.....	84
<b>Aerosol Adhesives</b>	
Durodyne.....	251
<b>Air Blocks</b>	
Therm-O-Mfg.....	179

<b>A (Continued)</b>	
<b>Air Boosters</b>	
Field Controls.....	189
<b>Air Cleaner Accessories</b>	
Honeywell.....	96
<b>Air Cleaner Parts &amp; Accessories</b>	
Trion.....	97
<b>Air Cleaners</b>	
Aprilaire.....	95
General Filters.....	87
Luxaire.....	19, 87-88
Nu-Calgon.....	93
Spaceguard.....	95
Trion.....	97
<b>Air Conditioners</b>	
Commercial Luxaire.....	24
Guardian.....	12
Luxaire.....	4-5
<b>Air Conditioning Flush</b>	
Nu-Calgon.....	145
<b>Air Conditioning Systems</b>	
Fujitsu.....	38-47
Spacepak.....	62-66
<b>Air Eliminators</b>	
Honeywell.....	160
<b>Air Filters</b>	
Disposable.....	98-99
Honeywell.....	99
Pleated.....	98
Skuttle.....	99
Trion.....	97, 99
<b>Air Handlers</b>	
Luxaire.....	11
<b>Air Line Tubing</b>	
Arzel.....	103
<b>Air Products</b>	
Smoke Detectors.....	37
<b>Air Purgers</b>	
Honeywell.....	160
<b>Air Purification</b>	
General Filters.....	88
<b>Air Purifiers</b>	
Nu-Calgon.....	93
<b>Air Velocity Testers</b>	
Fieldpiece Meter Accessory Heads.....	219
<b>Air Vents.....</b>	
	160

INDEX

## A (Continued)

<b>Air Vents</b>	
Honeywell.....	160
Hot Water.....	163
<b>Airmate</b>	
Dampers.....	200
Diffusers.....	200
<b>Airtite Saddle Tap.....</b>	177
<b>Airtite Takeoff.....</b>	176-177
<b>Aluminum Pipe</b>	
Builder's Best.....	194
<b>Aluminum Tubing</b>	
Refrigeration.....	135, 239
<b>Anchor Kits</b>	
EMC.....	259
<b>Angle Drive Accessory</b>	
Malco.....	208
<b>Angles</b>	
A-Collars Galvanized.....	176
B-Collars Galvanized.....	176
Galvanized.....	177
Galvanized Horizontal/Broadway.....	172
Galvanized Horizontal/Broadway Oval.....	174
Galvanized Vertical/Shortway.....	172
Galvanized Vertical/Shortway Oval.....	174
<b>Anti-Freeze</b>	
Hydronic Supplies.....	159
Noble Company.....	159
<b>Anti-Vibration Pads</b>	
Diversitech.....	216
<b>Aprilaire</b>	
Air Cleaners.....	95
<b>Aquaguard</b>	
Drain Pans.....	137
Float Switches.....	137
<b>Aquastats®</b>	
Honeywell.....	161
<b>Arzel</b>	
Dampers.....	103
Parts & Accessories.....	104
Pump/Pressure Vacuum Assembly.....	104
Staples.....	104
Tools.....	104
Zone Panels.....	102
<b>Aspen</b>	
Cased Coils.....	21, 23
Evaporator Coils.....	21, 23

## A (Continued)

Uncased Coils.....	21
<b>Atco</b>	
Flex Duct.....	203-204
Pipe Insulation.....	204
Pipe Sleeves.....	204
<b>Autoflo</b>	
Humidifier Replacement Parts.....	96
<b>Automatic Fill.....</b>	165
<b>Aviation Snips</b>	
Malco.....	206
Midwest Snips.....	205
<b>Awls</b>	
Malco.....	206

## B

<b>B-Collars</b>	
Galvanized.....	176
<b>B-Line</b>	
Channel.....	256
Clamps.....	257
Fasteners.....	256-257
Nuts.....	256
Pipe Hangers.....	257
Rooftop Support Systems.....	256
Strut Systems.....	256
<b>B-Vent</b>	
Selkirk Gas Vent.....	183-188
<b>Backdraft Damper.....</b>	193
<b>Backflow Preventer Accessories</b>	
Wilkins.....	165
<b>Backflow Preventers</b>	
Honeywell.....	161
Wilkins.....	165
<b>Bags</b>	
Vacuum.....	218
<b>Ball Drains</b>	
Webstone.....	163
<b>Ball Valve Adapter 3-Pk Set.....</b>	143
<b>Ball Valves</b>	
Legend Valve.....	162, 242
<b>Bangers</b>	
Durodyne.....	258
<b>Barbed Fittings</b>	
MA-Line Nylon.....	140

**B (Continued)**

**Barometric Dampers**  
Field Controls..... 189

**Baseboard Radiation**  
Slant/Fin..... 151-152

**Bath Box**  
Galvanized..... 168

**Bath Fans**  
Broan Deluxe..... 190  
Broan Premium..... 190

**Bath Ventilation Fans**  
Broan..... 190  
Delta Breez..... 192

**Batteries..... 264**

**Beacon-Morris**  
Floor Heaters..... 156  
Heaters..... 156

**Bearings**  
Durodyne..... 182

**Beckett**  
Condensate Pumps..... 139

**Belly Band Mounting..... 226**

**Benchmark**  
Drain Pans..... 22  
TXV..... 22

**Bits**  
Malco Drill..... 210  
Malco Power Drill..... 209-210

**Black Iron Fittings..... 231-232**

**Black Iron Unions..... 232**

**Black Nipples..... 232-233**

**Black Pipe..... 231**

**Black Steel Pipe..... 231**

**Blades**  
Source 1 Fan..... 229

**Blower Wheels**  
Source 1..... 230

**Boiler Fill Valves**  
Honeywell..... 161-162

**Boiler Valves**  
Safety Relief..... 160

**Boilers**  
Gas..... 154  
Slant/Fin Condensing..... 153  
Steam..... 155

**Booster**

**B (Continued)**

Duct..... 195  
Hard Start Kit..... 139

**Boosters**  
Field Controls Duct..... 189

**Boot Covers..... 217**

**Boot Frames**  
Paramount..... 200

**Boots**  
90° Galvanized..... 168  
Cold Air..... 170  
Cold Air Packages..... 170  
Galvanized..... 174  
Galvanized 90°..... 168  
Galvanized Center End..... 168  
Galvanized Elbow..... 168  
Galvanized Oval..... 174-175  
Galvanized Reverse Oval..... 175  
Galvanized Round to Oval..... 175  
Galvanized Round to Oval 90°..... 175  
Galvanized Round to Oval Center End..... 175  
Galvanized Round-to-Oval Universal..... 175  
Galvanized Universal Oval..... 175  
Galvanized Universal Straight..... 168

**Boss**  
Adhesives..... 247  
Caulking Guns..... 247  
Construction Sealants..... 246-247  
Draft Sealants..... 247  
Firestop..... 247  
Industrial Sealants..... 247  
Sealants..... 246-247  
Smoke Sealants..... 247

**Bracket Assembly**  
Durodyne..... 258

**Brackets**  
C&S Mfg..... 254  
Therm-O-Mfg. Mounting..... 136

**Bramec**  
Sealants..... 141

**Brass Fittings**  
Compression..... 242  
HICO Gas Cocks..... 242

**Brass Gas Cocks**  
Legend Valve..... 242

**Brass Manifold Accessories**  
Legend..... 158

## B (Continued)

<b>Brass Manifolds</b>	
Legend.....	158
<b>Brazing Alloys</b>	
Harris Products Group.....	131
<b>Bridging</b>	
Paxton Joist.....	178
<b>Broan</b>	
Bath Ventilation Fans.....	190
Make-Up-Air.....	191
Ventilators.....	190-191
<b>Brushes</b>	
Cleaning.....	218
<b>Bubble Wrap</b>	
Therm-O-Mfg.....	204
<b>Builder's Best</b>	
Aluminum Pipe.....	194
Dryer Box.....	195
Dryer Outlet Box.....	195
Dryer Vent Hoods.....	195
Flexible Pipe.....	194
Metal Pipe Fittings.....	194
<b>Butt Connectors</b> .....	264
<b>Bypass Kits</b>	
Arzel Modulating.....	102

## C

<b>C&amp;S Mfg.</b>	
Brackets.....	254
Duct Hangers.....	254
Duct Straps.....	255
Fasteners.....	254-255
FHA Plates.....	255
Pipe Hooks.....	255
Water Heater Pans.....	82, 255
<b>C-Collar</b>	
Galvanized Flex.....	176
<b>Cable</b>	
Fujitsu.....	58
<b>Cable Locks</b>	
Durodyne.....	258
<b>Cable Ties</b> .....	253-254
<b>Cables</b>	
Aluminum.....	262
Durodyne.....	258

## C (Continued)

<b>Canvas Connectors</b>	
Durodyne.....	182
Galvanized.....	177
<b>Cap Reducers</b>	
Galvanized.....	169
<b>Capacitors</b>	
Diversitech.....	227-228
Source 1.....	229-230
<b>Caps</b>	
Diversitech Flue.....	195
Galvanized End.....	171
Galvanized Rain.....	177
Galvanized Tee.....	169-170
Galvanized Vent Make Up Air.....	178
<b>Carbon Monoxide Detectors</b>	
Fieldpiece.....	221
<b>Case</b>	
Fieldpiece.....	222
<b>Cased Coils</b>	
Aspen.....	21, 23
<b>Cash Acme</b>	
Safety Relief Valves.....	160
SharkBite® Pipe Fittings.....	238-239
<b>Caulking Guns</b>	
Boss.....	247
Cleaner.....	247
<b>Cements</b>	
DeWitts.....	249
Furnace.....	248
Oatey PVC.....	247-248
<b>Center End Boots</b>	
Galvanized.....	168
Galvanized Round to Oval.....	175
<b>Channel</b>	
B-Line.....	256
<b>Channellock™</b>	
Pliers.....	216-217
Tools.....	216-217
<b>Charging Jacket</b> .....	221
<b>Chemicals</b>	
Boss.....	246
Hydronic Anti-Freeze.....	159
Nu-Calgon.....	144-148
<b>Chimney Liner Accessories</b> .....	188
<b>Chimney Liner Kits</b>	
National Chimney.....	188

## C (Continued)

<b>Chimney Systems</b>	
DuraVent Direct Vent GS.....	73
<b>Chimney Vent</b>	
Selkirk All Fuel.....	187
<b>Chisels</b>	
EMC.....	218
<b>Chucks (Drill)</b>	
Malco.....	209-210
<b>Circuit Protection</b>	
Zebra.....	261
<b>Circular Saw Blades</b>	
Diablo.....	210
<b>Circulator Pumps</b>	
Grundfos.....	156-157
<b>CL Ward &amp; Family</b>	
Commercial Flanges.....	181
Duct Connectors.....	181-182
Galvanized Cleats.....	182
Gasket Tape.....	182
Vane & Rail.....	182
<b>Clamp Meters</b>	
Fieldpiece.....	219-220
<b>Clamps</b>	
Conduit.....	259
Malco Duct & Pipe.....	208
Therm-O-Mfg. Linesets.....	136
Tyton.....	254
<b>Cleaner</b>	
Flame Sensor.....	128
Foam Gun.....	247
<b>Cleaners</b>	
Candles Smoke.....	224
Nu-Calgon Equipment.....	145-146
PVC.....	249
<b>Cleats</b>	
CL Ward & Family Galvanized.....	182
Drive Cleats.....	176
S-Cleats.....	176
Standing "S"/L-Bar.....	176
<b>ClenAir Odor Neutralizer</b> .....	148
<b>Cliplight</b>	
Dye.....	224
LED Lights.....	217
<b>CO2</b>	
Refill Kits.....	133
Tanks.....	133

## C (Continued)

<b>Coil Cleaners</b>	
Nu-Calgon.....	145-146
<b>Coils</b>	
Aspen Cased.....	21, 23
Aspen Evaporator.....	21, 23
Aspen Uncased.....	21
Luxaire.....	14-15
Red-T Manufactured Housing.....	83-85
<b>Cold Air Boots</b>	
Galvanized.....	170
<b>Cold Air Grounds/Frames</b>	
Galvanized.....	177
<b>Cold Air Packages</b>	
Galvanized.....	170
<b>Coleman Cable</b>	
Electrical Wire.....	261-262
<b>Collars</b>	
Galvanized "A".....	176
Galvanized "B".....	176
Galvanized Ductboard.....	173
Galvanized Flex "C".....	176
Galvanized Offset Starting.....	173
Galvanized Storm.....	177
<b>Combustion Motor</b> .....	227
<b>Commercial Flanges</b>	
CL Ward & Family.....	181
<b>Components &amp; Accessories Required Per System</b> .....	62
<b>Compression Fittings</b>	
Brass.....	242
<b>Compressor Saver</b>	
5-2-1.....	138
<b>Condensate Drain Pans</b>	
Diversitech.....	137
<b>Condensate Pumps</b>	
Beckett.....	139
Diversitech.....	139
Little Giant.....	138-139
<b>Condensate Removal Pumps</b>	
Diversitech.....	50-51
Sauermann.....	50
<b>Condensate Traps</b> .....	237
<b>Condensing Boilers</b>	
Slant/Fin.....	153
<b>Condensor Pads</b>	
Diversitech.....	136-137

## C (Continued)

Conduit.....	262
Conduit Clamps.....	259
<b>Conduit Fittings</b>	
PVC Sch 40 Elbows.....	160
<b>Connectors</b>	
Electrical.....	262
Galvanized Canvas.....	177
Gas Vent Selkirk.....	186
Liquid Tight Electrical.....	263
<b>Construction Sealants.....</b>	<b>246</b>
<b>Construction Sealants</b>	
Boss.....	246-247
<b>Contactors</b>	
Souce 1.....	230
<b>Contactors/Relays</b>	
White-Rodgers.....	115-117
<b>Continental</b>	
Diffusers.....	200
Egg Crate T-Bar Grille.....	200
<b>Continental Industries</b>	
Dampers.....	199
Diffusers.....	199
Grilles.....	197-198
Registers.....	197
<b>Controls</b>	
Fujitsu Remote.....	59-60
Honeywell.....	120-123
Honeywell Gas.....	119-120
Honeywell Hydronic.....	123, 161
Honeywell Zoning.....	100
Tekmar.....	157
White-Rodgers.....	114
White-Rodgers Gas Burner.....	113
White-Rodgers Hydronic.....	114
White-Rodgers Ignition.....	110-112
White-Rodgers Snap Disc.....	115
<b>Converters</b>	
Fujitsu Network.....	59
<b>Copper Fitting Brush.....</b>	<b>218</b>
<b>Copper Fittings</b>	
Wrot.....	165-166, 240-241
<b>Copper Flare Nuts &amp; Unions.....</b>	<b>136, 239</b>
<b>Copper Tube Extensions.....</b>	<b>144</b>
<b>Copper Tubing</b>	
Refrigeration.....	136, 239

## C (Continued)

Type M.....	135-136, 165, 239
<b>Copper Wrot Fittings.....</b>	<b>165-166, 240-241</b>
<b>Cork Tape.....</b>	<b>141, 246</b>
<b>Couplers.....</b>	<b>142</b>
<b>Covers</b>	
Electrical Outlet.....	263
<b>CPVC Pipe</b>	
CTS.....	237
<b>CPVC/CTS Fittings.....</b>	<b>237</b>
<b>Crankcase Heater Kits.....</b>	<b>20</b>
<b>Crimper</b>	
Midwest Snips.....	205
<b>Crimpers</b>	
Malco.....	206
<b>Crowns</b>	
Red-T Manufactured Housing.....	84
<b>Curb Dimensions.....</b>	<b>31-36</b>
<b>Cutters</b>	
Malco Hole.....	207

## D

<b>D &amp; W Inc.</b>	
Grilles.....	194
<b>Damper Motors</b>	
Durodyne.....	101
<b>Dampers</b>	
Airmate.....	200
Arzel.....	103
Arzel EzyFit.....	102
Arzel RegiDamper.....	102-103
Arzel Static Barometric Pressure.....	103
Continental Industries.....	199
Durodyne.....	101
Durodyne Zoning.....	101, 182
Galvanized.....	178
Paxton Warm Air.....	178
<b>Deflect-O</b>	
Exhaust & Intake Hoods.....	193-194
Vent Hoods.....	193-194
<b>Delta Breez</b>	
Bath Ventilation Fans.....	192
<b>Descaler</b>	



**D (Continued)**

Nu-Calgon.....	147
<b>Desolv™ Cleaning Kit - Mini-Splits.....</b>	<b>149</b>
<b>DeWitts</b>	
Cements.....	249
Roof Cements.....	250
Roof Coatings.....	249-250
Tools.....	250
<b>Diablo</b>	
Circular Saw Blades.....	210
Hole Saws.....	212-213
Parts & Accessories.....	214
Reciprocating Saw Blades.....	211-212
<b>Diagnostic Tools</b>	
Zebra Instruments.....	261
<b>Dielectric Fittings</b>	
Legend Valve.....	163, 242
<b>Diffusers</b>	
Airmate.....	200
Continental.....	200
Continental Industries.....	199
Easy Air Products Ceiling & Wall.....	201
Reliable Products.....	201
<b>Digital Manifold - 3 Ports.....</b>	<b>221</b>
<b>Direct Vent GS</b>	
DuraVent.....	73
<b>Disconnect Box.....</b>	<b>261</b>
<b>Diversitech</b>	
A/C Whips.....	263
Abrasive Cloth.....	215
Blank Cover.....	263
Capacitors.....	227-228
Condensate Drain Pans.....	137
Condensate Pumps.....	139
Condenser Pads.....	136-137
Condensor Pads.....	136
Cork Tape.....	141, 246
Drain Pans.....	137
Duct Booster.....	195
Electrical Accessories.....	263
Filter Driers.....	137-138
Fin Tools.....	215
Flex Fittings.....	263
Flex Inject.....	138
Flood Detectors.....	139
Floor Supports.....	51
Foam Tape.....	141, 246

**D (Continued)**

Furnace Mounting Blocks.....	216
Fuses.....	263
Handy Box.....	263
Hard Start Kits.....	139
Igniter.....	124
Leak Detectors.....	150
LIneset Hide.....	51
Mirrors.....	215
Motors.....	227
Nitrogen Purge Tool.....	138
Oilers.....	216
Paints.....	216
Piercing Valves.....	140
Polyethylene Tubing.....	140
Pressure Gauges.....	224
Pumps.....	50-51
PVC Fittings.....	237
Rust Breakers.....	216
Stack Caps.....	195
Super Change.....	138
Tapes.....	141, 246
Thermostat Guards.....	130
Time Delays.....	140
Traps.....	237
Valve Core Storer.....	140
Ventilation Products.....	195
Vinyl Tubing.....	140
Wire Connectors.....	263-264
<b>Dividers</b>	
Malco.....	207
<b>Draft Controls</b>	
Field Controls.....	189
<b>Draft Sealants</b>	
Boss.....	247
<b>Drain Pans</b>	
Aquaguard.....	137
Benchmark.....	22
<b>Drawbands</b>	
Galvanized Round.....	168
<b>Driers</b>	
Filter Diversitech.....	137-138
<b>Drill Bits</b>	
Lenox.....	215
Malco.....	209-210
<b>Drill Chucks</b>	
Malco.....	209-210

## D (Continued)

<b>Drip Tees</b>	
Galvanized Round.....	169
<b>Drive Cleats</b>	
Galvanized.....	176
<b>Drum Assemblies</b>	
Skuttle.....	97
<b>Dryer Box</b>	
Builder's Best.....	195
Builder's Best Dryer.....	195
<b>Dryer Outlet Box</b>	
Builder's Best.....	195
<b>Dryer Vent Hoods</b>	
Builder's Best.....	195
<b>Dryer Vent Piping</b>	
Builder's Best.....	194
<b>Duct</b>	
Galvanized Rectangular.....	171
<b>Duct Adapters</b>	
Galvanized.....	177
<b>Duct Board</b>	
Owens Corning.....	203
<b>Duct Clamps</b>	
Malco.....	208
<b>Duct Connectors</b>	
CL Ward & Family.....	181-182
Durodyne.....	182
<b>Duct Fittings</b>	
Galvanized.....	169-170
Galvanized 45° Oval Boots.....	175
Galvanized 90° Oval Boots.....	174
Galvanized A-Collars.....	176
Galvanized Access Doors.....	178
Galvanized Airtite Takeoff.....	176-177
Galvanized Angles.....	177
Galvanized B-Collars.....	176
Galvanized Basement Heat Box.....	168
Galvanized Canvas Connectors.....	177
Galvanized Cap Reducers.....	169
Galvanized Center End Boots.....	168
Galvanized Cold Air Boots.....	170
Galvanized Cold Air Grounds.....	177
Galvanized Dampers.....	178
Galvanized Drawbands.....	168
Galvanized Drip Tees.....	169
Galvanized Drive Cleats.....	176
Galvanized Duct Adapters.....	177

## D (Continued)

Galvanized Ductboard Collars.....	173
Galvanized Elbows.....	167
Galvanized End Caps.....	171
Galvanized Filter Rack.....	178
Galvanized Filter Racks.....	174
Galvanized Flex Collars.....	176
Galvanized Floor Sleeves.....	174
Galvanized Hanging Straps.....	177
Galvanized Horizontal/Broadway Angles....	172
Galvanized Horizontal/Broadway Oval Angles.....	174
Galvanized Horizontal/Broadway Oval Elbows.....	174
Galvanized L-Bar.....	176
Galvanized Literature Rack.....	178
Galvanized Make Up Air Units.....	178
Galvanized Make Up Air Vent Caps.....	178
Galvanized Offset Starting Collars.....	173
Galvanized Oval Firestops.....	175
Galvanized Oval Pipe.....	174
Galvanized Oval Reverse Boots.....	175
Galvanized Oval Toe Kick Boots.....	175
Galvanized Oval Universal Boots.....	175
Galvanized Panning.....	177
Galvanized Plaster Frames.....	177
Galvanized Plenum.....	170
Galvanized Rectangular Angles.....	172
Galvanized Rectangular Duct.....	171
Galvanized Reducing Plenum Starter.....	173
Galvanized Return Air.....	170
Galvanized Rnd-to-Oval Boots.....	175
Galvanized S-Cleats.....	176
Galvanized Stack Heads.....	174-175
Galvanized Storm Collars.....	177
Galvanized Straight Take-Offs.....	173
Galvanized Tapered Reducers.....	169, 173
Galvanized Tee Caps.....	169-170
Galvanized Tees.....	169
Galvanized Universal Boots.....	168
Galvanized Vertical/Shortway Angles.....	172
Galvanized Vertical/Shortway Oval Angles.	174
Galvanized Vertical/Shortway Oval Elbows.	174
Galvanized Wall Stack.....	174
Galvanized Wyes.....	170
Saddle Tap.....	177
Take-Offs.....	167

## Duct Flex

## D (Continued)

Atco.....	203-204
<b>Duct Hanging Wire.....</b>	<b>217</b>
<b>Duct Insulation</b>	
Bubble Wrap.....	204
Foil.....	204
<b>Duct Liner</b>	
Owens Corning.....	203
<b>Duct Sealant.....</b>	<b>250</b>
<b>Duct Sealant Accessories.....</b>	<b>250</b>
<b>Duct Sealers</b>	
Durodyne.....	251
<b>Duct Slitter</b>	
Midwest Snips.....	205
<b>Duct Strap.....</b>	<b>217</b>
<b>Duct Straps</b>	
C&S Mfg.....	255
Durodyne.....	258
<b>Duct Stretchers</b>	
Malco.....	207
<b>Duct Tape.....</b>	<b>245</b>
<b>Duct Tools</b>	
Malco.....	207-208
<b>Duct Wrap</b>	
Owens Corning.....	203
<b>Ductboard Collar.....</b>	<b>173</b>
<b>Ductless Mini-Split Systems</b>	
Fujitsu VRF.....	52-58
<b>Ductless Split Systems</b>	
Fujitsu.....	38-47
<b>Durodyne</b>	
Adhesives.....	251
Aerosol Adhesives.....	251
Bearings.....	182
Bracket Assembly.....	258
Cable Locks.....	258
Cables.....	258
Damper Motors.....	101
Damper Quadrant Sets.....	182
Dampers Zoning.....	101
Duct Connectors.....	182
Duct Sealers.....	251
Durozone Systems.....	101
Fasteners.....	258
Insulation Adhesives.....	251
Pins.....	258
Regulators.....	182

## D (Continued)

Staplers.....	210
Vane & Rail.....	182
Vinyl Straps.....	258
<b>Durozone Systems</b>	
Durodyne.....	101
<b>Dust Masks</b>	
Diversitech.....	216
<b>Dye</b>	
Cliplight.....	224
<b>Dye Injection Kits</b>	
Spectroline Products.....	223

## E

<b>Easy Air Products</b>	
Diffusers.....	201
<b>Ecobee WiFi Thermostat.....</b>	<b>118</b>
<b>Egg Crate T-Bar Grille</b>	
Continental.....	200
<b>Elbows</b>	
Galvanized Horizontal/Broadway.....	172
Galvanized Horizontal/Broadway Oval.....	174
Galvanized Oval.....	174
Galvanized Round.....	167
Galvanized Vertical/Shortway.....	172
Galvanized Vertical/Shortway Oval.....	174
PVC Sch 40 Conduit.....	160
<b>Electrical</b>	
Liquid Tight Connectors.....	263
<b>Electrical Boxes</b>	
Diversitech Handy Box.....	263
<b>Electrical Connectors.....</b>	<b>262</b>
<b>Electrical Covers</b>	
Outlet.....	263
<b>Electrical Tape</b>	
Economy.....	141
EMC.....	246
<b>Electrical Wire</b>	
Coleman Cable.....	261-262
<b>Electronic Air Cleaners</b>	
Luxaire.....	19
<b>Electronic Handles.....</b>	<b>222</b>
<b>EMC</b>	
Anchor Kits.....	259
Chisels.....	218

## E (Continued)

Fasteners.....	258-259
Gloves.....	217
Hanger.....	259
Nipple Trays.....	217-218
Rod Couplings.....	258
Rod Hanger.....	259
Rods.....	258
Straps.....	259
Teflon Tape.....	246
Terminals.....	264
Ties.....	259
Washers.....	258
<b>Empire</b>	
Direct Vent Fireplaces.....	72-73
<b>Empire Comfort Systems</b>	
Parts.....	73
Residential Furnaces.....	72
<b>End Caps</b>	
Duct Galvanized.....	171
Galvanized.....	171
<b>Equipment Cleaners</b>	
Nu-Calgon.....	145-146
<b>ESP-D Series Fan Coil Units (Cooling Only)..</b>	62
<b>Evaporator Coils</b>	
Aspen.....	21, 23
Luxaire.....	14
<b>Evaporator Pads</b>	
Autoflo.....	96
General Filters.....	90
<b>Evaporator Plates.....</b>	91
<b>Expansion Tanks</b>	
Flexcon.....	156
State.....	82
<b>Expansion Valves</b>	
Source 1.....	18
<b>Extended Warranties</b>	
Luxaire.....	16-17
State.....	82
<b>EZT-113 &amp; EZT-113B - EZ Trap Kit.....</b>	148
<b>EZT-225 - Inline Universal overflow switch....</b>	148
<b>EzyFit</b>	
Arzel.....	102

## F

<b>FAMCO</b>	
Roof Caps.....	193
<b>Fan &amp; Limit</b>	
Honeywell.....	119
<b>Fan Blades</b>	
Source 1.....	229
<b>Fan Limit Controls</b>	
Supco.....	128
<b>Fan Motors</b>	
Source 1.....	229
<b>Fan Relays</b>	
White-Rodgers.....	115-117
<b>Fans</b>	
Booster.....	195
Broan Bath Ventilation.....	190
Delta Breez Bath Ventilation.....	192
Source 1 Propeller.....	229
<b>Fasteners.....</b>	253-254
<b>Fasteners</b>	
B-Line.....	256-257
Blue Panning Nails.....	253
C&S Mfg.....	254-255
Durodyne.....	258
EMC.....	258-259
J.T. Products.....	254
Malco.....	253
Tyton.....	254
<b>Fastners</b>	
Malco.....	253
<b>Fiberglass Board</b>	
Owens Corning.....	203
<b>Fiberglass Flex Duct Tools.....</b>	208
<b>Field Controls</b>	
Air Boosters.....	189
Draft Controls.....	189
Lamps.....	94-95
UV Lights.....	94-95
<b>Fieldpiece</b>	
Accessory Heads.....	219
Carbon Monoxide Detectors.....	221
Stick Meters.....	219
Test Leads.....	220
Thermocouples.....	220
<b>Fieldpiece Tester.....</b>	221
<b>Filter Cleaners</b>	

## F (Continued)

Nu-Calgon Equipment.....	145-146
<b>Filter Driers</b>	
Diversitech.....	137-138
<b>Filter Rack</b> .....	178
<b>Filter Racks</b>	
Galvanized.....	174
<b>Filters</b>	
Disposable.....	98
Honeywell.....	96
Pleated.....	98
<b>Fin Tools</b>	
Diversitech.....	215
<b>Fireblock Foam &amp; Gun</b> .....	247
<b>Fireplaces</b>	
Empire Direct Vent.....	72-73
<b>Firestop</b>	
Boss.....	247
<b>Firestops</b>	
Galvanized Oval.....	175
<b>Fittings</b>	
All Fuel Chimney Systems Selkirk.....	187
All Fuel Selkirk Chimney Systems.....	187
Arzel.....	104
B-Vent Selkirk.....	183-185, 187-188
Black Iron.....	231-232
Black Iron Unions.....	232
Copper.....	241-242
CPVC/CTS.....	237
Dielectric.....	163
Diversitech PVC.....	237
Flexible Double Wall Selkirk.....	186
Galvanized.....	167-178
Legend.....	158
Legend Valve Dielectric.....	242
MA-Line Barbed Nylon.....	140
OmegaFlex TracPipe®.....	234
PVC Sch 40.....	160, 235-237
SharkBite® Push-Fit Pipe Fittings.....	238-239
Wrot Copper Pressure.....	165-166
<b>Flame Sensor Cleaner</b> .....	128
<b>Flange</b>	
Commercial CL Ward & Family.....	181
<b>Flange Mount Fittings</b>	
OmegaFlex Fittings.....	234
<b>Flange Sets</b>	

## F (Continued)

Grundfos.....	157
<b>Flare Nut Linesets</b> .....	49-50, 134-135
<b>Flaretite Refrigeration Seals</b> .....	50
<b>Flaring Tools</b> .....	215
<b>Flaring Tools</b>	
Ritchie Engineering.....	143-144
<b>Flashing</b>	
Oatey No Caulk.....	235
<b>Flat Stock</b>	
Steel.....	179
<b>Flex Collar "C"</b>	
Galvanized.....	176
<b>Flex Connector/Canvas</b> .....	177
<b>Flex Duct</b> .....	203-204
<b>Flex Duct</b>	
Uninsulated.....	204
<b>Flex Fittings</b>	
Diversitech.....	263
<b>Flex Gas Pipes</b>	
OmegaFlex.....	233
OmegaFlex Fittings.....	234
<b>Flex Guard</b>	
Lineset.....	135
<b>Flex Inject</b> .....	138
<b>Flex Pipe</b>	
Builder's Best Aluminum.....	194
<b>Flexcon</b>	
Expansion Tanks.....	156
<b>Flexi-Sleeves</b>	
National Chimney.....	188
<b>Flexible Conduit</b>	
Greenfield.....	262
<b>Flexible Double Wall Gas Vent Selkirk</b> .....	186
<b>Flexible Gas Lines</b> .....	231
<b>Flexible Gas Pipe</b>	
OmegaFlex Fittings.....	233-234
<b>Flexible Pipe</b>	
Builder's Best.....	194
<b>Float Switches</b>	
Aquaguard.....	137
Aquaguard Pan.....	137
<b>Flood Detectors</b>	
Diversitech.....	139
<b>Floor Heaters</b>	

## F (Continued)

Beacon-Morris.....	156
<b>Floor Sleeves</b>	
Galvanized.....	174
<b>Floor Supports</b>	
Diversitech.....	51
<b>Flue Caps</b>	
Diversitech.....	195
<b>Flush</b>	
Nu-Calgon.....	145
<b>Fluxes</b>	
Harris Products Group.....	131
<b>Foam Gun Cleaner.....</b>	<b>247</b>
<b>Foam Insulation</b>	
Tape.....	141, 246
<b>Foam Sealant</b>	
Expanding.....	246
<b>Foil Tapes.....</b>	<b>245-246</b>
<b>Foil Wrap</b>	
Owens Corning.....	203
Therm-O-Mfg.....	204
<b>Foil-Grip 1402 Tape.....</b>	<b>250</b>
<b>Folding Tools</b>	
Malco.....	207
<b>Foremost Duct</b>	
PCD Underground Duct.....	180-181
<b>Frames</b>	
Paramount Register.....	200
Therm-O-Mfg.....	179
<b>Freeze Sensors</b>	
Durodyne.....	101
<b>Freon</b>	
Refrigerant.....	133
<b>Freon Recovery Machine.....</b>	<b>141</b>
<b>Fresh Air Intakes</b>	
Fujitsu.....	58
<b>FSK Wrap</b>	
Owens Corning.....	203
<b>Fujitsu</b>	
Airstage Parts & Accessories.....	58-61
Ductless Split Systems.....	38-47
VRF Ductless Mini-Split Systems.....	52-58
<b>Furnace Cement.....</b>	<b>248</b>
<b>Furnaces</b>	
Empire Comfort Systems Residential.....	72
Guardian.....	13

## F (Continued)

Luxaire.....	7-10
Luxaire Gas.....	83
Red-T.....	83-85
<b>Fuses.....</b>	<b>262, 264</b>
<b>Fuses</b>	
Blade-Type.....	264
Disconnects.....	262
Diversitech.....	263
<b>Fusible Links.....</b>	<b>178</b>

## G

### Galvanized

90° Boots Oval.....	174
90° Boots Round to Oval.....	175
90° Boots.....	168
A-Collars.....	176
Access Doors.....	178
Airtite Saddle Tap.....	177
Airtite Takeoff.....	176-177
Angles.....	177
Angles Horizontal/Broadway Oval.....	174
B-Collars.....	176
Basement Heat Box.....	168
Bath Box.....	168
Boots.....	175
Boots Center End.....	168
Boots Galvanized.....	168, 175
Boots Oval.....	174
Boots Oval 45°.....	175
Boots Oval Reverse.....	175
Boots Round to Oval Center End.....	175
Boots Toe Kick Oval.....	175
Boots Universal Oval.....	175
"C" Collar/Flex.....	176
Canvas Connectors.....	177
Cap Reducers.....	169
Center End Boots.....	168
Cold Air Boots.....	170
Cold Air Grounds/Frames.....	177
Cold Air Packages.....	170
Connectors/Canvas.....	177
Dampers.....	178
Drawbands.....	168
Drive Cleats.....	176
Duct.....	171-173

## G (Continued)

Duct Adapters.....	177
Duct Fittings.....	172
Ductboard Collar.....	173
Elbows Duct Horizontal/Vertical.....	172
Elbows Galvanized.....	167
Elbows Horizontal/Broadway Oval.....	174
Elbows Oval.....	174
Elbows Vertical/Shortway Oval.....	174
End Cap Duct.....	171
Filter Racks.....	174
Firestops Oval.....	175
Flex Collar/ "C".....	176
Floor Sleeves.....	174
Hanging Strap.....	177
Horizontal/Broadway Duct Fittings.....	172
L-Bar/Standing "S".....	176
Make Up Air Units.....	178
Offset Starting Collars.....	173
Oval Pipe.....	174
Oval Stack Heads.....	175
Panning/Sheeting.....	177
Pipe & Fittings.....	167-178
Pipe Oval.....	174
Pipe Round.....	167
Plaster Frames.....	177
Plenum Packages.....	170
Rain Caps.....	177
Rectangular Duct.....	171
Reducing Plenum Starters.....	173
Round to Oval Boots.....	175
S-Cleats.....	176
Saddle Tap.....	177
Sheeting/Panning.....	177
Stack Fittings.....	174
Stack Heads.....	174
Stack Heads Oval.....	175
Storm Collars.....	177
Straight Take-Offs.....	173
Take-Offs Round to Round.....	167
Takeoff.....	176-177
Tapered Duct Reducers.....	173
Tapered Reducers.....	169
Tees.....	169-170
Vent Caps.....	178
Vertical/Shortway Angles Oval.....	174
Vertical/Shortway Duct Fittings.....	172
Wall Stack.....	174

## G (Continued)

Wall Stack Fittings.....	174
Wyes.....	170
<b>Galvanized Boots.....</b>	<b>168</b>
<b>Galvanized Fittings.....</b>	<b>168</b>
<b>Galvanized Sheets.....</b>	<b>179</b>
<b>Gas</b>	
Refill Kits.....	133
Tanks.....	133
<b>Gas Ball Valves</b>	
HICO Brass.....	242
Legend Valve Brass.....	242
<b>Gas Boilers</b>	
Slant/Fin.....	154-155
<b>Gas Burner Controls</b>	
White-Rodgers.....	113
<b>Gas Controls</b>	
Honeywell.....	119-123
White-Rodgers.....	113
<b>Gas Furnaces</b>	
Luxaire.....	83
<b>Gas Heaters</b>	
Modine.....	67-69
<b>Gas Leak Detectors</b>	
Nu-Calgon.....	146-147
<b>Gas Lines</b>	
Flexible.....	231
<b>Gas Pipe Fittings.....</b>	<b>231-232</b>
<b>Gas Pipe Fittings</b>	
OmegaFlex.....	233
<b>Gas Pipe Nipples.....</b>	<b>232-233</b>
<b>Gas Pipes</b>	
OmegaFlex TracPipe® Protection Devices.....	234
<b>Gas Piping</b>	
OmegaFlex.....	233
<b>Gas Vent</b>	
Selkirk.....	183-188
<b>Gas Vent Flexible Connectors</b>	
Selkirk/Metalbestos.....	186
<b>Gas Vent Hangers</b>	
Selkirk.....	185
<b>Gas Vent Oval Pipe</b>	
Selkirk.....	186
<b>Gases</b>	
Propane & MAPP.....	218
<b>Gasket Tapes</b>	

## G (Continued)

CL Ward & Family.....	182
<b>Gaskets</b>	
Ritchie Engineering.....	143
<b>Gator Clips</b>	
Zebra Instruments.....	261
<b>Gauges</b>	
Leak Test.....	224
Thermometers with Well.....	160
Tridicators.....	160
<b>General Filters</b>	
Air Purification.....	88
Evaporator Pads.....	90
Humidifiers.....	88-91
Humidistats.....	91-92
Media Air Cleaners.....	87
Oil Replacement Cartridges.....	93
Parts & Accessories.....	92
<b>GeneralAire</b>	
HRV.....	93
<b>Gloves</b>	
EMC.....	217
<b>Glues</b>	
PVC Cement.....	247-248
<b>Great White™</b>	
Pipe Joint Compound with Teflon®.....	249
<b>Greenfield.....</b>	262
<b>Grilles</b>	
Continental Industries.....	197-198
D & W Inc.....	194
Fujitsu.....	58
<b>Grilles Aluminum</b>	
Reliable Products.....	201
<b>Grundfos</b>	
Flange Sets.....	157
Pumps.....	156-157
<b>Guardian</b>	
Air Conditioners.....	12
Furnaces.....	13

## H

## H (Continued)

<b>Hand Saws</b>	
Lenox.....	214
<b>Hand Tools</b>	
Malco.....	206-210
<b>Handy Box</b>	
Diversitech Utility.....	263
<b>Hanger.....</b>	259
<b>Hanger Strap</b>	
Manifold Gauge.....	128
<b>Hangers</b>	
B-Line Pipe.....	257
<b>Hanging Brackets for Unit Heaters.....</b>	67
<b>Hanging Strap</b>	
Galvanized.....	177
<b>Hanging Wire.....</b>	217
<b>Hard Start Kits</b>	
Diversitech.....	139
<b>Hardstart</b>	
5-2-1.....	138
<b>Harris Products Group</b>	
Brazing Alloys.....	131
Fluxes.....	131
Solder.....	131
Torch Kits.....	131
<b>Header Plates</b>	
C&S Mfg.....	255
<b>Headers</b>	
Fujitsu.....	58
<b>Headers/Blockers</b>	
Therm-O-Mfg. ThermoPan.....	179
<b>Heat Box</b>	
Galvanized.....	168
<b>Heat Pastes</b>	
Nu-Calgon.....	147
<b>Heat Pump Systems</b>	
Fujitsu.....	38-47
<b>Heat Pumps</b>	
Luxaire.....	6
<b>Heat Recovery Ventilator.....</b>	93
<b>Heat Transfer Fluids</b>	
Noble Company.....	159
<b>Heat Transfer Plates.....</b>	158
<b>Heat Transfer Products</b>	
Superstor Water Heaters.....	155
<b>Heater Kits.....</b>	20

## Hacksaw Frames

Lenox..... 214

## Hammers

Malco..... 209



**H (Continued)**

**Heaters**  
 Beacon-Morris..... 156  
 Beacon-Morris Floor..... 156  
 Modine Unit..... 67-69  
**Heating Specialties. Legend Valve..... 163**  
**Heating Valves**  
 Legend Valve..... 163  
**Hex Drivers**  
 Malco..... 209  
**Hex Keys**  
 Malco..... 209  
**Hi Capacity Roof Cap..... 191**  
**HICO**  
 Gas Ball Valves..... 242  
**High Velocity Air Conditioners**  
 Spacepak..... 62-66  
**Hole Cutters**  
 Malco..... 207  
**Hole Saws**  
 Diablo..... 212-213  
**Honeywell**  
 Air Cleaner Accessories..... 96  
 Air Eliminators..... 160  
 Air Purgers..... 160  
 Air Vents..... 160  
 Aquastats®..... 161  
 Backflow Preventers..... 161  
 Boiler Fill Valve..... 161-162  
 Controls..... 100  
 Fan & Limit..... 119  
 Gas Controls..... 119-123  
 Hydronic Controls..... 123, 161  
 Prefilters..... 96  
 Switches..... 123  
 Thermometer with Well..... 160  
 Thermostatic Valve Actuators..... 162  
 Thermostats..... 118-119  
 Tridicators..... 160  
 Winter Watchman..... 123  
 Zone Dampers..... 100  
 Zoning Panels..... 100  
**Hooded Wall Vent..... 193**  
**Hoods**  
 Make Up Air..... 178  
 Vent Deflecto..... 193-194  
 Vent FAMCO..... 193

**H (Continued)**

Vent Lambro..... 194  
**Horizontal 90°**  
 Galvanized..... 172  
**Horizontal Angles**  
 Galvanized..... 172  
**Hoses**  
 Vacuum & Charging..... 142-143  
**Hot Surface Igniters**  
 Starlite..... 125  
**Hot Water Air Vents..... 163**  
**Hot Water Relief Valves..... 160**  
**HRV..... 93**  
**Humidifier Floats**  
 Skuttle..... 97  
**Humidifier Parts**  
 General Filters..... 92  
 Lobb..... 96  
**Humidifier Replacement Media**  
 Skuttle..... 97  
**Humidifier Replacement Parts**  
 Autoflo..... 96  
**Humidifiers**  
 General Filters..... 88-92  
 Luxaire..... 18-19  
 Steam..... 90  
**Humidistats**  
 General Filters..... 91-92  
**HVAC Strap - Manifold Gauge Hanger..... 128**  
**HVAC Supplies**  
 Diversitech..... 141, 246  
**Hydronic Controls**  
 Honeywell..... 123, 161  
 Honeywell Aquastats®..... 161  
 White-Rodgers..... 114  
**Hydronic Supplies**  
 Anti-Freeze & Leak Stop..... 159

**I**

---

**ICM Corp.**  
 Module..... 129  
 Probes..... 128  
**Igniter Cross Reference..... 126-127**  
**Igniters**  
 Diversitech..... 124

## I (Continued)

Packard.....	124
Starlite Hot Surface.....	125
<b>Ignition Controls</b>	
Honeywell.....	120-123
White-Rodgers.....	110-112
<b>Inducer Motor.....</b>	<b>227</b>
<b>Industrial Sealants</b>	
Boss.....	247
<b>Infrared Heaters</b>	
Modine.....	68-69
<b>Inserts</b>	
Malco.....	209
<b>Insulated Flex.....</b>	<b>203-204</b>
<b>Insulated Pipe</b>	
Selkirk.....	187
<b>Insulation</b>	
Duct Bubble.....	204
<b>Insulation Products</b>	
Nu-Calgon.....	148
<b>Insulation Tape.....</b>	<b>141, 246</b>
<b>Intakes</b>	
Fujitsu Fresh Air.....	58
<b>Interface Relays</b>	
Skuttle.....	97
<b>IO Systems</b>	
Temp Stats.....	129
<b>Iron Fittings</b>	
Black.....	231-232

## J

<b>J-Hooks.....</b>	<b>150</b>
<b>J.T. Products</b>	
Fasteners.....	254
<b>J/B Industries</b>	
Tools & Replacement Parts.....	144
Tubing Tools.....	144
<b>Jackson Systems</b>	
Thermostats.....	129
<b>Joist Bridging</b>	
C&S Mfg.....	254
Paxton.....	178
<b>Jomar</b>	
Pipe Thread Sealants.....	249

## J (Continued)

<b>Jumper Wires</b>	
Zebra Instruments.....	261
<b>Junction Boxes</b>	
Diversitech.....	263

## K

<b>Knives</b>	
Malco.....	208
Utility Malco.....	208

## L

<b>L-Bar/Standing "S"</b>	
Galvanized.....	176
<b>Laird Plastics</b>	
Louvers.....	200
<b>Lambro</b>	
Vent Hoods.....	194
<b>Lamps</b>	
Field Controls.....	94-95
<b>Leads</b>	
Fieldpiece Test.....	220
<b>Leak Detectors</b>	
Diversitech Radiant.....	150
Nu-Calgon Gas.....	146-147
Oatey MegaBubble.....	149, 235
<b>Leak Sealant</b>	
Nu-Calgon Refrigeration.....	144
<b>Leak Stop</b>	
Hydronic Supplies.....	159
<b>LED Lights</b>	
Cliplight.....	217
<b>Legend</b>	
Brass Manifold Accessories.....	158
Brass Manifolds.....	158
Copper Fittings.....	241-242
PEX Installation Tools.....	159
<b>Legend Fittings.....</b>	<b>158</b>
<b>Legend Fittings.....</b>	<b>158</b>
<b>Legend Fittings.....</b>	<b>158</b>
<b>Legend Fittings.....</b>	<b>158</b>
<b>Legend Pipe.....</b>	<b>158</b>
<b>Legend Valve</b>	

**L (Continued)**

Ball Valves.....	162
Dielectric Fittings.....	242
Heating Valves.....	163
Low Pressure Valves.....	162
Radiator Valves.....	163
Y-Strainers.....	162
<b>Legend Valves</b>	
Dielectric Fittings.....	163
<b>Lenox</b>	
Drill Bits.....	215
Hacksaw Frames.....	214
Hand Saws.....	214
Screwdrivers.....	215
Tools.....	214-215
Tubing Cutters.....	214
<b>Levels</b>	
Malco.....	208
<b>Lights</b>	
Service.....	217
<b>Line Driers</b>	
Source 1 Suction.....	137
<b>Liner</b>	
Owens Corning.....	203
<b>Liner Kits.....</b>	188
<b>Lineset Hide</b>	
Diversitech.....	51
<b>Linesets.....</b>	49, 134-135
<b>Linesets</b>	
Flex Guard.....	135
Mini-Split.....	49-50
White.....	134
<b>Liquid Tight Electrical Connectors.....</b>	263
<b>Little Giant</b>	
Condensate Pumps.....	138-139
<b>Lobb</b>	
Humidifier Parts.....	96
<b>Lock Boxes</b>	
Diversitech.....	130
<b>Lock Nuts.....</b>	263
<b>Log Lighter Valves</b>	
Legend Valve.....	242
<b>Louvers</b>	
Laird Plastics.....	200
<b>Low Ambient Kit</b>	
ICM Corp.....	128
<b>Low Water Cutoffs</b>	

**L (Continued)**

Taco.....	164
<b>Luxaire</b>	
Air Conditioners.....	4-5
Air Handlers.....	11
Coils.....	14-15
Commercial Accessories & Parts.....	24, 26-28, 30
Commercial Air Conditioners.....	24
Extended Warranties.....	16-17
Furnaces.....	7-10, 83
Gas Furnaces.....	83
Heat Pumps.....	6
Humidifiers.....	18-19
Media Air Cleaners.....	19, 87-88
Package Units.....	24-29

**M**

<b>MA-Line</b>	
Fuses.....	264
Smoke Cartridges.....	224
<b>Make Up Air.....</b>	94
<b>Make Up Air Units</b>	
Galvanized.....	178
<b>Make-Up Air Units</b>	
Galvanized.....	178
<b>Make-Up-Air</b>	
Broan.....	191
Skuttle.....	97
<b>Malco</b>	
Awls.....	206
Blades.....	208
Fasteners.....	253
Hammers.....	209
Hex Drivers.....	209
Hex Keys.....	209
Inserts.....	209
Levels.....	208
Measuring Tapes.....	208
Pliers.....	209
Rivets.....	253
Screws.....	253
Snips.....	206
Tools.....	206-209, 253
Utility Knives.....	208
Vent Saw.....	209

## M (Continued)

Wrenches.....	209
<b>Manifolds</b>	
Brass.....	158
Ritchie Engineering.....	142
<b>Manufactured Housing</b>	
Red-T Accessories.....	84
Red-T Coils.....	83-85
Red-T Crowns.....	84
Red-T Furnaces.....	83-85
Red-T TXV.....	85
<b>Manufactured Housing Coils &amp; TXV's.....</b>	<b>85</b>
<b>MAPP</b>	
TurboTorch Torches.....	132
<b>MAPP Gas.....</b>	<b>218</b>
<b>Mars</b>	
Motors.....	225-226
<b>MARS</b>	
Surge Protective Device.....	264
<b>MC Cable.....</b>	<b>262</b>
<b>McDonnel &amp; Miller</b>	
Automatic Fill.....	165
<b>Measuring Tapes</b>	
Malco.....	208
<b>Media</b>	
Spaceguard.....	95
<b>Media Air Cleaners.....</b>	<b>94</b>
<b>Media Air Cleaners</b>	
General Filters.....	87
Luxaire.....	19, 87-88
Trion Air Bear.....	97
<b>Media Pads</b>	
Lobb.....	96
Skuttle.....	97
<b>Metal Pipe Fittings</b>	
Builder's Best.....	194
<b>Metalbestos</b>	
Gas Vent Oval Pipe Selkirk.....	186
Selkirk Chimney Systems.....	187
Selkirk Firestop.....	185
Selkirk Vent Pipe & Fittings.....	183-188
<b>Metering Orifice Piston Kits R410A &amp; R22....</b>	<b>22</b>
<b>Meters.....</b>	<b>222</b>
<b>Meters</b>	
Fieldpiece.....	219-222
<b>Midwest Snips</b>	
Aviation Snips.....	205

## M (Continued)

Crimper.....	205
Duct Slitter.....	205
Tinner Snips.....	205
<b>Mini Split Stands</b>	
Quick Sling.....	48
<b>Mini-Split Linesets.....</b>	<b>49-50</b>
<b>Mini-Split Non-Insulated Hose.....</b>	<b>149</b>
<b>Mini-Split Systems</b>	
Fujitsu VRF Ductless.....	52-58
<b>Mini-Split Wire.....</b>	<b>48</b>
<b>Mini-Splits</b>	
Fujitsu Ductless.....	38-47
<b>Mirrors</b>	
Diversitech Telescoping.....	215
<b>Misc Pipe Fittings.....</b>	<b>243</b>
<b>Modine</b>	
Parts.....	69
Tube Kits.....	69
Unit Heater Brackets.....	67
Unit Heater Parts.....	67
Unit Heaters.....	67-69
<b>Modulating Bypass Kits</b>	
Arzel.....	102
<b>Modulating Furnace Fault Codes.....</b>	<b>282-285</b>
<b>Module</b>	
ICM Corp.....	129
<b>Mono-Flow Tees (C x C).....</b>	<b>166</b>
<b>Motors</b>	
Diversitech.....	227
Mars.....	225-226
Source 1 Fan.....	229
<b>Mounting Blocks</b>	
Diversitech Furnace.....	216
<b>Mounting Brackets</b>	
Therm-O-Mfg.....	136

## N

<b>Nails.....</b>	<b>253</b>
<b>Nails</b>	
Panning.....	253
<b>National Chimney</b>	
Chimney Liner Kits.....	188
Flexi-Sleeves.....	188
<b>Network Converters</b>	

**N (Continued)**

Fujitsu.....	59
<b>Nipple Trays</b>	
EMC.....	217-218
<b>Nitrogen</b>	
Refill Kits.....	133
Tanks.....	133
TurboTorch Purge Kits.....	132
<b>Nitrogen Purge Tool.....</b>	<b>138</b>
<b>Nitrogen Regulator</b>	
TurboTorch.....	133
<b>Noburst AL.....</b>	<b>159</b>
<b>Non-Insulated Flex Duct</b>	
Atco.....	204
<b>Novent Locking Refrigerant Caps.....</b>	<b>149</b>
<b>Nu-Calgon</b>	
Air Cleaners.....	93
Chemicals.....	144-148
Descaler.....	147
Filter Cleaners.....	145-146
Flush.....	145
Gas Leak Detectors.....	146-147
Heat Pastes.....	147
Insulation Products.....	148
Refrigeration Sealant.....	144
Sprayers.....	149
Vacuum Pump Oil.....	148
Water Proofing Spray.....	147
<b>Nu-Calgon Air Purifiers.....</b>	<b>93</b>
<b>NuCalgon</b>	
Specialty Products.....	147-148
<b>Nuts</b>	
B-Line Twirl.....	256
Diversitech Wire Connectors.....	263-264
EMC.....	258
<b>Nylon Ties</b>	
EMC.....	259

**O**

<b>Oatey</b>	
Access Panel.....	149
Cements.....	247-248
J-Hooks.....	150
Leak Detectors.....	149, 235
Pipe Compounds.....	249

**O (Continued)**

Primers/Cleaners.....	249
Roof Flashing.....	235
<b>Odor Neutralizer</b>	
ClenAir.....	148
<b>Offset Starting Collars</b>	
Galvanized.....	173
<b>Oil</b>	
Nu-Calgon Vacuum Pump.....	148
<b>Oil Injector Tool.....</b>	<b>144</b>
<b>Oil Replacement Cartridges</b>	
General Filters.....	93
<b>Oilers</b>	
Diversitech.....	216
<b>OmegaFlex</b>	
Gas Pipe Fittings.....	233
Gas Piping.....	233
<b>Outlet Box</b>	
Builder's Best Dryer.....	195
<b>Outlet Covers</b>	
Electrical.....	263
<b>Oval 45° Boots</b>	
Galvanized.....	175
<b>Oval Boots</b>	
Galvanized.....	175
<b>Oval Firestops</b>	
Galvanized.....	175
<b>Oval Fittings</b>	
Galvanized.....	174-175
<b>Oval Pipe</b>	
Galvanized.....	174
<b>Owens Corning</b>	
Duct Board.....	203
Duct Liner.....	203
Duct Wrap.....	203
<b>Oxygen</b>	
Refill Kits.....	133
Tanks.....	133

**P**

<b>P-Traps</b>	
Elkhart.....	241
<b>Package Units</b>	
Luxaire.....	24-29

## P (Continued)

<b>Packard</b>	
Igniter.....	124
<b>Pads</b>	
Anti-Vibration Diversitech.....	216
Condenser.....	136-137
Evaporator General Filters.....	90
<b>Paints</b>	
Diversitech.....	216
<b>Panning</b>	
Nails.....	253
Therm-O-Mfg.....	178
<b>Panning Nails.....</b>	<b>253</b>
<b>Panning/Sheeting</b>	
Galvanized.....	177
<b>Pans</b>	
C&S Mfg. Water Heater.....	82, 255
Drain Diversitech.....	137
Water Heater.....	82
<b>Paramount Systems</b>	
Register Installation Frames.....	200
<b>Paxton</b>	
Joist Bridging.....	178
Warm Air Dampers.....	178
<b>PCD Underground Duct</b>	
Foremost Duct.....	180-181
<b>PEX Installation Tools</b>	
Legend.....	159
<b>PEX Tubing.....</b>	<b>158</b>
<b>Piercing Valves</b>	
Diversitech.....	140
<b>Pilot Relite Controls</b>	
White-Rodgers.....	114
<b>Pipe</b>	
All Fuel Chimney Systems Selkirk.....	187
All Fuel Selkirk Chimney Systems.....	187
B-Vent Selkirk.....	183-185, 187-188
Black Steel.....	231
Builder's Best Aluminum.....	194
Copper.....	135-136, 239
CPVC CTS.....	237
Flexible Double Wall Selkirk.....	186
Galvanized Oval.....	174
Galvanized Round.....	167
Legend.....	158
Oval Gas Vent Selkirk.....	186

## P (Continued)

PVC.....	235
<b>Pipe Clamps</b>	
Malco.....	208
<b>Pipe Compounds</b>	
Oatey.....	249
<b>Pipe Fittings</b>	
CPVC/CTS.....	237
Misc.....	243
PVC Sch 40.....	235-237
SharkBite® Push-Fit.....	238-239
<b>Pipe Hangers</b>	
B-Line.....	257
<b>Pipe Hooks</b>	
C&S Mfg.....	255
<b>Pipe Insulation</b>	
Atco.....	204
<b>Pipe Thread Sealants</b>	
Jomar.....	249
<b>Pipe Thread Tape.....</b>	<b>248</b>
<b>Pipes</b>	
OmegaFlex Gas Flex.....	233
<b>Plaster Frames</b>	
Galvanized.....	177
<b>Plastic Condenser Pads.....</b>	<b>136-137</b>
<b>Plates</b>	
Electrical Outlet Covers.....	263
<b>Pleated Filters.....</b>	<b>98</b>
<b>Plenum</b>	
Galvanized Reducing Starter.....	173
<b>Plenum Packages</b>	
Galvanized.....	170
<b>Plenum Tubing</b>	
Arzel.....	103
<b>Pliers</b>	
Channellock™.....	216-217
Malco.....	209
<b>Plugs</b>	
PVC Sch 40.....	237
<b>Pocket Digital Psychrometer.....</b>	<b>220</b>
<b>Polyethylene Tubing</b>	
Diversitech.....	140
<b>Polyken (Tyco) Tape.....</b>	<b>245-246</b>
<b>Prefilters</b>	
Honeywell.....	96

## P (Continued)

<b>Premier Power Direct Vent Hi-Efficiency Gas Water Heater</b> .....	79
<b>Premier Power Vent Hi-Efficiency Gas Water Heater</b> .....	80
<b>Pressure Gauges</b>	
Diversitech.....	224
Ritchie Engineering.....	143
<b>Pressure Relief Valves</b> .....	160
<b>Primers/Cleaners</b>	
Oatey PVC.....	249
<b>Primesource</b>	
Nails.....	253
<b>Probes</b>	
ICM Corp.....	128
<b>Programmable</b>	
Honeywell Thermostats.....	118-119
<b>Propane</b>	
TurboTorch Torches.....	132
<b>Propane Gas</b> .....	218
<b>Propeller Fans</b>	
Source 1.....	229
<b>Protection Devices</b>	
OmegaFlex TracPipe®.....	234
<b>Pump Oil</b>	
Vacuum.....	148
<b>Pump/Pressure Vacuum Assembly</b>	
Arzel.....	104
<b>Pumps</b>	
Circulator.....	156-157
Diversitech.....	50-51
Diversitech Condensate.....	139
Little Giant Condensate.....	138-139
Sauermann.....	50
<b>Purgers</b>	
Honeywell.....	160
<b>Push-Fit Pipe Fittings</b>	
SharkBite®.....	238-239
<b>PVC DWV Pipe</b> .....	235
<b>PVC Fittings</b>	
Diversitech.....	237
Sch 40.....	235-237
<b>PVC J-Hooks</b> .....	150
<b>PVC Pipe</b> .....	235
<b>PVC Pressure Pipe</b> .....	235
<b>PVC Sch 40 Fittings</b>	
Conduit Elbows.....	160

## P (Continued)

<b>PVC Tubing</b>	
Sauermann.....	51
<b>Q</b>	
<hr/>	
<b>Quick Sling</b>	
Mini-Split Stands.....	48
<b>R</b>	
<hr/>	
<b>Radiator Valves</b>	
Legend Valve.....	163
<b>Rain Caps</b>	
Galvanized.....	177
<b>Receptacle Covers</b>	
Steel.....	263
<b>Reciprocating Saw Blades</b>	
Diablo.....	211-212
<b>Recovery Machine</b> .....	141
<b>Rectangular Appliance Wall Vent</b> .....	193
<b>Rectangular Duct</b>	
Galvanized.....	171
<b>Red-T</b>	
Adjustable Roof Jacks.....	84
Furnaces.....	83-85
Manufactured Housing Crowns.....	84
<b>Reducers</b>	
Duct Tapered.....	173
Galvanized Cap.....	169
Galvanized Tapered.....	169
Galvanized Tapered Duct.....	173
Tapered Duct.....	173
<b>Reducing Plenum Starters</b>	
Galvanized.....	173
<b>Refrigerant</b>	
Freon.....	133
<b>Refrigerant Copper Fittings</b> .....	165-166, 240-241
<b>Refrigerant Recovery Machine</b> .....	141
<b>Refrigerant Test Kits</b>	
Leak Gauges.....	224
<b>Refrigerant Tools &amp; Accessories</b>	
J/B Industries.....	144
Yellow Jacket.....	141

## R (Continued)

Refrigeration Sealants.....	50
<b>Refrigeration Tubing</b>	
Aluminum.....	135, 239
Copper.....	136, 239
<b>RegiDampner</b>	
Arzel.....	102-103
<b>Register Boots</b>	
Galvanized.....	168
<b>Registers</b>	
Continental Industries.....	197
Reliable Products.....	201
<b>Regulators</b>	
Durodyne.....	182
<b>Relays</b>	
Current Sensing Skuttle.....	97
Diversitech Time Delay.....	140
Fan White-Rodgers.....	115-117
White-Rodgers.....	115-117
<b>Reliable Products</b>	
Aluminum Grilles.....	201
Diffusers.....	201
Registers.....	201
<b>Relief Valve.....</b>	82
<b>Relief Valves</b>	
Cash Acme.....	160
<b>Remote Controls</b>	
Fujitsu.....	59-60
<b>Replacement Media</b>	
Skuttle.....	97
<b>Replacement Media Filters.....</b>	94
<b>Replacement Parts.....</b>	161
<b>Residential Furnaces</b>	
Empire Comfort Systems.....	72
<b>Residential Refrigerant Scale.....</b>	221
<b>Residential Water Heaters</b>	
State.....	75-79
<b>Return Air Drop Packages.....</b>	170
<b>Return Air Drops</b>	
Galvanized.....	170
<b>Reverse Boots</b>	
Galvanized Oval.....	175
<b>Reznor Make-Up-Air Quote Request Form.....</b>	70
<b>Reznor Replacement Make-Up-Air Quote Request Form.....</b>	71
<b>Ritchie Engineering</b>	
Flaring Tools.....	143-144

## R (Continued)

Gaskets.....	143
Manifolds.....	142
Pressure Gauges.....	143
Tools.....	143
Vacuum Hoses.....	142-143
Vacuum Pump Oil.....	141
Vacuum Pumps.....	141
Yellow Jacket® Tools.....	143-144
<b>Rivets</b>	
Malco.....	253
<b>Robinaire</b>	
Refrigerant Recovery Machine.....	141
<b>Rod Couplings</b>	
EMC.....	258
<b>Rod Hanger.....</b>	259
<b>Rods</b>	
Brazing.....	131
EMC.....	258
<b>Romex Wire.....</b>	262
<b>Roof Caps</b>	
FAMCO.....	193
<b>Roof Cements</b>	
DeWitts.....	250
<b>Roof Coatings</b>	
DeWitts.....	249-250
<b>Roof Flashing</b>	
Oatey.....	235
<b>Roof Jack Selection Chart.....</b>	86
<b>Rooftop Support Systems</b>	
B-Line.....	256
<b>Rooftop Units</b>	
Luxaire.....	24-29
<b>Roto-Vents</b>	
D & W Inc.....	194
<b>Round Pipe</b>	
Galvanized.....	167
<b>Round Soffit.....</b>	193
<b>Round to Oval Fittings</b>	
Galvanized.....	175
<b>Run Capacitors</b>	
Source 1.....	229-230
<b>Rust Breaker</b>	
Diversitech.....	216



**S**

---

**S-Cleats**  
Galvanized..... 176

**Saddle Tap**  
Galvanized..... 177

**Safe Boiler Stop Leak**..... 159

**Safety Relief Valves**  
Cash Acme..... 160

**Sauermann**  
Pumps..... 50  
PVC Tubing..... 51

**Saw**  
Malco..... 209

**Saw Blades**  
Diablo Circular..... 210  
Diablo Reciprocating..... 211-212

**Saws**  
Diablo Hole..... 212-213

**Sch 40 Fittings**  
PVC Conduit Elbows..... 160

**Screwdrivers**  
Lenox..... 215

**Screws**  
Malco..... 253  
Zip-In® Malco..... 253

**Scribers**  
Malco..... 207

**Sealant**  
Boss Construction..... 246-247

**Sealants**  
Boss..... 246-247  
Bramec..... 141  
Duct..... 251  
Expanding Foam..... 246  
Jomar Pipe Thread..... 249

**Seamers**  
Malco Hand..... 207

**Selkirk**  
Chimney Vent..... 187  
Gas Vent Connectors..... 186  
Gas Vent Oval Pipe..... 186  
Insulated Pipe..... 187  
Type "B" Gas Vent Pipe..... 183-185,  
187-188  
Vent Pipe & Fittings..... 183-188

**Sensi Touch**..... 105

**S (Continued)**

**Sensors**  
Durodyne Freeze..... 101  
Fujitsu..... 60

**Separation Tubes**  
Fujitsu..... 60

**Separators**  
Honeywell Air..... 160

**Service Cable**..... 262

**Service Lights**..... 217

**Setpoint Controls**  
Tekmar..... 157

**SharkBite®**  
Push-Fit Pipe Fittings..... 238-239

**Sheet Metal Tools**  
Malco..... 206-210

**Sheeting/Panning**  
Galvanized..... 177

**Skuttle**  
Drum Assemblies..... 97  
Humidifier Floats..... 97  
Humidifier Replacement Media..... 97  
Interface Relays..... 97  
Make-Up Aire..... 97  
Solenoid Valves..... 97  
Water Pans..... 97

**Skuttle Accessories**..... 97

**Slant/Fin**  
Baseboard Radiation..... 151-152  
Condensing Boilers..... 153  
Sentinel Gas Boilers..... 154  
Sentry Gas Boilers..... 154-155

**Sleeves**  
Pipe..... 204

**Smoke Cartridges**  
MA-Line..... 224

**Smoke Detectors**  
Air Products..... 37

**Smoke Sealants**  
Boss..... 247

**Snap Disc Controls**  
White-Rodgers..... 115

**Snips**  
Malco..... 206  
Midwest..... 205

**Soffit Hoods**

## S (Continued)

D & W Inc.....	194
<b>Software</b>	
Fujitsu.....	61
<b>Solder</b>	
Harris Products Group.....	131
<b>Solder Supplies</b>	
TurboTorch.....	132
<b>Solenoid Valves</b>	
Skuttle.....	97
<b>Source 1</b>	
Blower Wheels.....	230
Contactors.....	230
Fan Blades.....	229
Fan Motors.....	229
Line Driers.....	137
Propeller Fans.....	229
Run Capacitors.....	229-230
TXV.....	18
<b>Spaceguard</b>	
Air Cleaners.....	95
<b>Spacepak</b>	
High Velocity Air Conditioners.....	62-66
<b>Spectroline Products</b>	
EZ-Ject™ Dye Injection Kits.....	223
<b>SpeediChannel.....</b>	<b>51</b>
<b>Spin Tools.....</b>	<b>215</b>
<b>Spiral Galvanized Connectors.....</b>	<b>180</b>
<b>Spiral Galvanized Elbows 90Deg.....</b>	<b>180</b>
<b>Spiral Galvanized End Caps.....</b>	<b>180</b>
<b>Spiral Galvanized Product.....</b>	<b>180</b>
<b>Spiral Galvanized Shoe Taps.....</b>	<b>180</b>
<b>Spiral Galvanized Tapered Reducers.....</b>	<b>180</b>
<b>Spray-n-Bond®.....</b>	<b>147</b>
<b>Sprayers</b>	
Nu-Calgon.....	149
<b>Stack</b>	
Fittings.....	174
Heads.....	174
Heads Galvanized.....	174
Oval Head.....	175
Oval Pipe.....	174
Wall Stack.....	174
<b>Stack Caps</b>	
Diversitech.....	195
<b>Stack Heads</b>	
Galvanized.....	174

## S (Continued)

Galvanized Oval.....	175
<b>Standing "S" or L-Bar</b>	
Galvanized.....	176
<b>Staplers</b>	
Durodyne.....	210
<b>Staples</b>	
Arzel.....	104
<b>Starlite</b>	
Hot Surface Igniters.....	125
<b>Stat Guards</b>	
Diversitech.....	130
<b>Stat Wire.....</b>	<b>261-262</b>
<b>State</b>	
Expansion Tanks.....	82
Extended Warranties.....	82
Water Heaters.....	75-79, 82
Water Heaters Residential.....	74-79, 82
<b>Static Barometric Pressure</b>	
Arzel Dampers.....	103
<b>Steam Boilers</b>	
Slant/Fin.....	155
<b>Steam Humidifiers.....</b>	<b>90</b>
<b>Steel</b>	
Flat Stock.....	179
<b>Stick Meters</b>	
Fieldpiece.....	219
<b>Storm Collars</b>	
Galvanized.....	177
<b>Straight Boots</b>	
Galvanized.....	168
<b>Straight Take-Offs</b>	
Galvanized.....	173
<b>Strap</b>	
Galvanized Hanging.....	177
Manifold Guage Hanger.....	128
Wove Duct.....	217
<b>Straps</b>	
C&S Mfg. Duct.....	255
Conduit.....	259
EMC.....	259
Nylon.....	253-254
Vinyl Durodyne.....	258
<b>Strut Systems</b>	
B-Line.....	256
<b>Suction Line Driers</b>	

**S (Continued)**

Source 1.....	137
<b>Supco</b>	
Fan & Limit Controls.....	128
Flame Sensor Cleaner.....	128
Time Delay Relay.....	128
<b>Super Change.....</b>	138
<b>Superstor Water Heaters</b>	
Heat Transfer Products.....	155
<b>Supervent™</b>	
Honeywell Air Eliminators.....	160
<b>Surge Protective Device</b>	
MARS.....	264
<b>Swaging Tools.....</b>	215
<b>Switch</b>	
Wet Flood Detector.....	139
<b>Switches</b>	
Honeywell.....	123

**T**

<b>Taco Inc</b>	
Low Water Cutoffs.....	164
Zone Pump Relays.....	164
<b>Take-Offs</b>	
Galvanized Duct-to-Plenum.....	173
Galvanized Round.....	167
Galvanized Straight.....	173
<b>Takeoff</b>	
Galvanized.....	176-177
<b>Tank Valves</b>	
Webstone.....	163
<b>Tankless Plumbing Kit.....</b>	74
<b>Tankless Water Heaters</b>	
State.....	74
<b>Tanks</b>	
Flexcon Expansion.....	156
Gas.....	133
<b>Tape</b>	
Economy Electrical.....	141
EMC Electrical.....	246
EMD Teflon.....	246
Insulation.....	141, 246
Pipe Thread.....	248
<b>Tape Measurers</b>	
Malco.....	208

**T (Continued)**

<b>Tapered Reducers</b>	
Duct Reducers.....	173
Galvanized.....	169
<b>Tapes.....</b>	245-246
<b>Tapes</b>	
CL Ward & Family Gasket.....	182
Cloth Duct.....	245
Diversitech.....	141, 246
PE Film.....	246
Tyco.....	246
<b>Tees</b>	
Black Malleable Iron.....	232
CPVC.....	237
Elkhart.....	241
Galvanized.....	169
Galvanized Caps.....	169-170
Galvanized Round.....	169
PVC.....	235
<b>Teflon Tape</b>	
EMC.....	246
<b>Tekmar</b>	
Sepoint Controls.....	157
Thermostats.....	157
<b>Temp Stats.....</b>	129
<b>Terminal Connectors.....</b>	264
<b>Terminals</b>	
EMC.....	264
<b>Test Equipment</b>	
Fieldpiece Meters.....	219-222
Yellow Jacket.....	142
<b>Test Leads</b>	
Fieldpiece.....	220
UEI.....	222
<b>Tester.....</b>	221
<b>Testers</b>	
Fieldpiece.....	219-222
<b>Testers &amp; Meters.....</b>	141, 222
<b>Therm-O-Mfg.</b>	
Air Blocks.....	179
Mounting Brackets.....	136
Panning.....	178
Wall Frames.....	179
<b>Thermal Expansion Valves</b>	
Source 1.....	18
<b>Thermocouples</b>	
Fieldpiece.....	220

## T (Continued)

<b>Thermometer with Well</b>	
Honeywell.....	160
<b>Thermometers</b>	
Diversitech Pocket.....	224
UEI.....	222
<b>Thermostat Guards</b>	
Diversitech.....	130
<b>Thermostat Wire.....</b>	261
<b>Thermostatic Mixing Valves</b>	
Honeywell.....	162
<b>Thermostatic Valve Actuators</b>	
Honeywell.....	162
<b>Thermostatic Valves</b>	
Honeywell.....	162
<b>Thermostats</b>	
Honeywell.....	118-119
Jackson Systems.....	129
Tekmar.....	157
White-Rodgers.....	105-110
<b>Thin Wall Conduit.....</b>	262
<b>Thum Gum.....</b>	141
<b>Ties</b>	
EMC.....	259
Nylon.....	253-254
<b>Time Delay Relay</b>	
Supco.....	128
<b>Time Delays</b>	
Diversitech.....	140
<b>Timers</b>	
White-Rodgers.....	114
<b>Tinner Snips</b>	
Midwest Snips.....	205
<b>Toe Hot Registers.....</b>	197
<b>Toe Kick Boots</b>	
Galvanized Oval.....	175
<b>Tool</b>	
Nitrogen Purge.....	138
<b>Tools</b>	
Arzel.....	104
Channellock™.....	216-217
DeWitts.....	250
EMC.....	218
Fiberglass Flex Duct.....	208
Fieldpiece Testers.....	220
Lenox.....	214-215
Malco.....	206-210, 253

## T (Continued)

Midwest Snips.....	205
Misc.....	218
OmegaFlex TracPipe®.....	234
Refrigerant.....	144
Ritchie Engineering.....	143-144
Ritchie Engineering Yellow Jacket®.....	143-144
Siding.....	206
<b>Tools &amp; Replacement Parts</b>	
J/B Industries.....	144
<b>Torch Kits.....</b>	131
<b>Torch Kits</b>	
Harris Products Group.....	131
<b>Torches</b>	
TurboTorch.....	132
<b>Tote Trays.....</b>	218
<b>Transformer.....</b>	227
<b>Transformers</b>	
White-Rodgers.....	117
<b>Transition</b>	
Duct Reducers.....	173
<b>Traps</b>	
PVC.....	237
<b>Trays</b>	
EMC Nipple.....	217
<b>Tridicators</b>	
Honeywell.....	160
<b>Trion</b>	
Air Cleaner Parts & Accessories.....	97
Air Cleaners.....	97
Air Filters.....	97
<b>Trunk Fittings</b>	
Galvanized Horizontal/Broadway Angles....	172
Galvanized Vertical/Shortway Angles.....	172
<b>Trunk Line</b>	
Duct Rectangular Galvanized.....	171
<b>Tubes</b>	
Fujitsu Separation.....	60
<b>Tubing</b>	
Aluminum Refrigeration.....	135, 239
Arzel Plenum.....	103
Copper.....	136, 165, 239
Copper Linesets.....	49-50, 134-135
Copper Refrigeration.....	136, 239
Diversitech Polyethylene.....	140
Diversitech Vinyl.....	140

**T (Continued)**

Insulated.....	242
Legend.....	158
Type M Copper.....	135-136, 239
<b>Tubing Cutters</b>	
Lenox.....	214
<b>Tubing Tools</b>	
J/B Industries.....	144
<b>Turbo Torch Accessories.....</b>	132
<b>TurboTorch</b>	
Solder Supplies.....	132-133
<b>Twin-Flo III Heaters</b>	
Beacon-Morris.....	156
<b>TXV</b>	
Benchmark.....	22
Red-T Manufactured Housing.....	85
Source 1.....	18
<b>Tyco</b>	
Tapes.....	245-246
<b>Type "B" Gas Vent Pipe</b>	
Selkirk.....	183-185, 187-188
<b>Tyton</b>	
Clamps.....	254
Fasteners.....	254

**U**

<b>UEI</b>	
Test Leads.....	222
Thermometers.....	222
<b>Uncased Coils</b>	
Aspen.....	21
<b>Underground Duct PCD.....</b>	180-181
<b>Uninsulated Flex</b>	
Atco.....	204
<b>Unions</b>	
Black Iron.....	232
<b>Unit Heater Brackets</b>	
Modine.....	67
<b>Unit Heater Parts</b>	
Modine.....	67
<b>Unit Heaters</b>	
Modine.....	67-69
<b>Universal Boots</b>	
Galvanized.....	168

**U (Continued)**

Galvanized Oval.....	175
Galvanized Round-Oval.....	175
<b>Universal Electric Fan Timer Control w/LED Diagnostics.....</b>	121
<b>Utility Boxes</b>	
Diversitech Handy Box.....	263
<b>Utility Knives</b>	
Malco.....	208
<b>UV Light.....</b>	88
<b>UV Lights.....</b>	94-95
<b>UV Lights</b>	
General Filters.....	88

**V**

<b>V-Belts.....</b>	226-227
<b>Vacuum Bags.....</b>	218
<b>Vacuum Hoses</b>	
Ritchie Engineering.....	142-143
<b>Vacuum Pump Oil</b>	
Nu-Calgon.....	148
Ritchie Engineering.....	141
<b>Vacuum Pumps</b>	
Ritchie Engineering.....	141
<b>Valve Core Storer</b>	
Diversitech.....	140
J/B Industries.....	144
<b>Valves</b>	
Ball.....	162
Boiler Drains.....	162
Brass Ball.....	162
Gate.....	243
Heating.....	163
HICO Ball.....	242
Legend Valve Ball.....	242
Legend Valve Low Pressure.....	162
Piercing Diversitech.....	140
Radiator.....	163
Safety Relief.....	160
T&P.....	243
Thermal Expansion.....	18
Water.....	243
Webstone.....	163
Y-Strainers.....	162
<b>Vane &amp; Rail</b>	

## V (Continued)

CL Ward & Family.....	182
Durodyne.....	182
<b>Vent Caps</b>	
Galvanized Make Up Air.....	178
Lambro.....	194
<b>Vent Hangers</b>	
Gas.....	185
<b>Vent Hoods</b>	
Builder's Best Dryer.....	195
Deflect-O.....	193-194
FAMCO.....	193
Lambro.....	194
Wall.....	194
<b>Vent Pipe &amp; Fittings Selkirk.....</b>	<b>183-185, 187-188</b>
<b>Vent Saw</b>	
Malco.....	209
<b>Ventilation Products</b>	
Diversitech.....	195
<b>Ventilators</b>	
Broan.....	190-191
Broan LoSone Select.....	190
<b>Vertical 90°</b>	
Galvanized.....	172
<b>Vertical Angles</b>	
Galvanized.....	172
<b>Vinyl Straps</b>	
Durodyne.....	258
<b>Vinyl Tubing</b>	
Diversitech.....	140
<b>Voltage Testers</b>	
Fieldpiece.....	220
<b>VRF Ductless Mini-Split Systems</b>	
Fujitsu.....	52-58

## W

<b>Wall Frames</b>	
Therm-O-Mfg.....	179
<b>Wall Furnaces</b>	
Empire Comfort Systems.....	72
<b>Wall Stack</b>	
Galvanized.....	174
<b>Wall Stack Fittings</b>	
Galvanized.....	174

## W (Continued)

<b>Wall Vent.....</b>	<b>193</b>
<b>Warm Air Controls</b>	
White-Rodgers.....	114
<b>Washers.....</b>	<b>263</b>
<b>Washers</b>	
EMC.....	258
<b>Water Air Vents.....</b>	<b>163</b>
<b>Water Heater Pans.....</b>	<b>82</b>
<b>Water Heater Pans</b>	
C&S Mfg.....	82, 255
<b>Water Heater Storage Tanks</b>	
Heat Transfer.....	155
<b>Water Heaters</b>	
State Residential.....	74-79
State Tankless.....	74
Superstor.....	155
<b>Water Pans</b>	
Skuttle.....	97
<b>Water Proofing Spray</b>	
Nu-Calgon.....	147
<b>Water Pumps.....</b>	<b>138-139</b>
<b>Webstone</b>	
Ball Drains.....	163
Valves.....	163
<b>Wedge Duct Adapters.....</b>	<b>177</b>
<b>Weld Pins</b>	
Durodyne.....	258
<b>Welding Supplies</b>	
TurboTorch.....	132
<b>Wet Stick</b>	
DeWitts.....	249
<b>Wet Switch Flood Detector.....</b>	<b>139</b>
<b>Whips</b>	
Diversitech A/C.....	263
<b>White Rodgers</b>	
Hydronic Controls.....	114
Snap Disc Controls.....	115
Warm Air Controls.....	114
<b>White Rodgers Sensi Touch.....</b>	<b>105</b>
<b>White-Rodgers.....</b>	<b>108</b>
<b>White-Rodgers</b>	
Accessories.....	108
Contactors/Relays.....	115-117
Gas Burner Controls.....	113
Ignition Controls.....	110-112
Thermostats.....	105-110

**W (Continued)**

Timers.....	114
Transformers.....	117
<b>WiFi Thermostat.....</b>	<b>105, 118</b>
<b>Wilkins</b>	
Backflow Preventer Accessories.....	165
Backflow Preventers.....	165
<b>Winter Watchman</b>	
Honeywell.....	123
<b>Wire</b>	
Fujitsu.....	61
Mini-Split.....	48
Romex.....	262
Thermostat.....	261
<b>Wire Connectors</b>	
Diversitech.....	263-264
<b>Wireless Digital Manifold - 4 Valves.....</b>	<b>221</b>
<b>Wireless Dual In-Duct Psychrometer.....</b>	<b>220</b>
<b>Wireless Refrigerant Scale.....</b>	<b>221</b>
<b>Wires</b>	
Thermostat.....	261-262
<b>Wrap</b>	
Duct Owens Corning.....	203
<b>Wrenches</b>	
Malco.....	209
Ritchie Engineering.....	143
<b>Wrot Fittings</b>	
Copper.....	165-166, 240-241
<b>Wye-Strainers</b>	
Legend Valve.....	162
<b>Wyes</b>	
Galvanized Round.....	170

**Y**

<b>Y-Strainers</b>	
Legend Valve.....	162
<b>Yellow Jacket.....</b>	<b>141</b>
<b>Yellow Jacket</b>	
Test Equipment.....	142

**Z**

**Z (Continued)**

Circuit Protection.....	261
<b>Zebra Instruments</b>	
Diagnostic Tools.....	261
Gator Clips.....	261
Jumper Wires.....	261
<b>Zip Ties.....</b>	<b>253-254</b>
<b>Zone Dampers</b>	
Arzel.....	102-103
Honeywell.....	100
<b>Zone Panels</b>	
Arzel.....	102
<b>Zone Pump Relays</b>	
Taco.....	164
<b>Zone Valves</b>	
Honeywell.....	161
<b>Zoning Dampers &amp; Controls</b>	
Durodyne.....	101
<b>Zoning Panels</b>	
Honeywell.....	100

