

2018 - 2019 Product Catalog



**EASTMAN**<sup>®</sup>



**EZ-FLO** **EASTMAN**<sup>®</sup>  
**MADE RIGHT. MADE TO LAST.**

**2018-2019 FULL LINE  
PRODUCT CATALOG**



# EASTMAN®

# MADE RIGHT. MADE TO LAST.

For more than 50 years, EZ-FLO & Eastman has been synonymous with premium quality appliance and plumbing connectors trusted by generations of professional installers, plumbers and consumers. Over the years, EZ-FLO & Eastman has expanded the product line to include pans, outlet boxes, expansion tanks, and more. Today, every product manufactured by EZ-FLO & Eastman carries a long history of quality and innovation. When you stock EZ-FLO & Eastman products, you can be confident you are getting the most reliable installation parts that are made right and made to last.

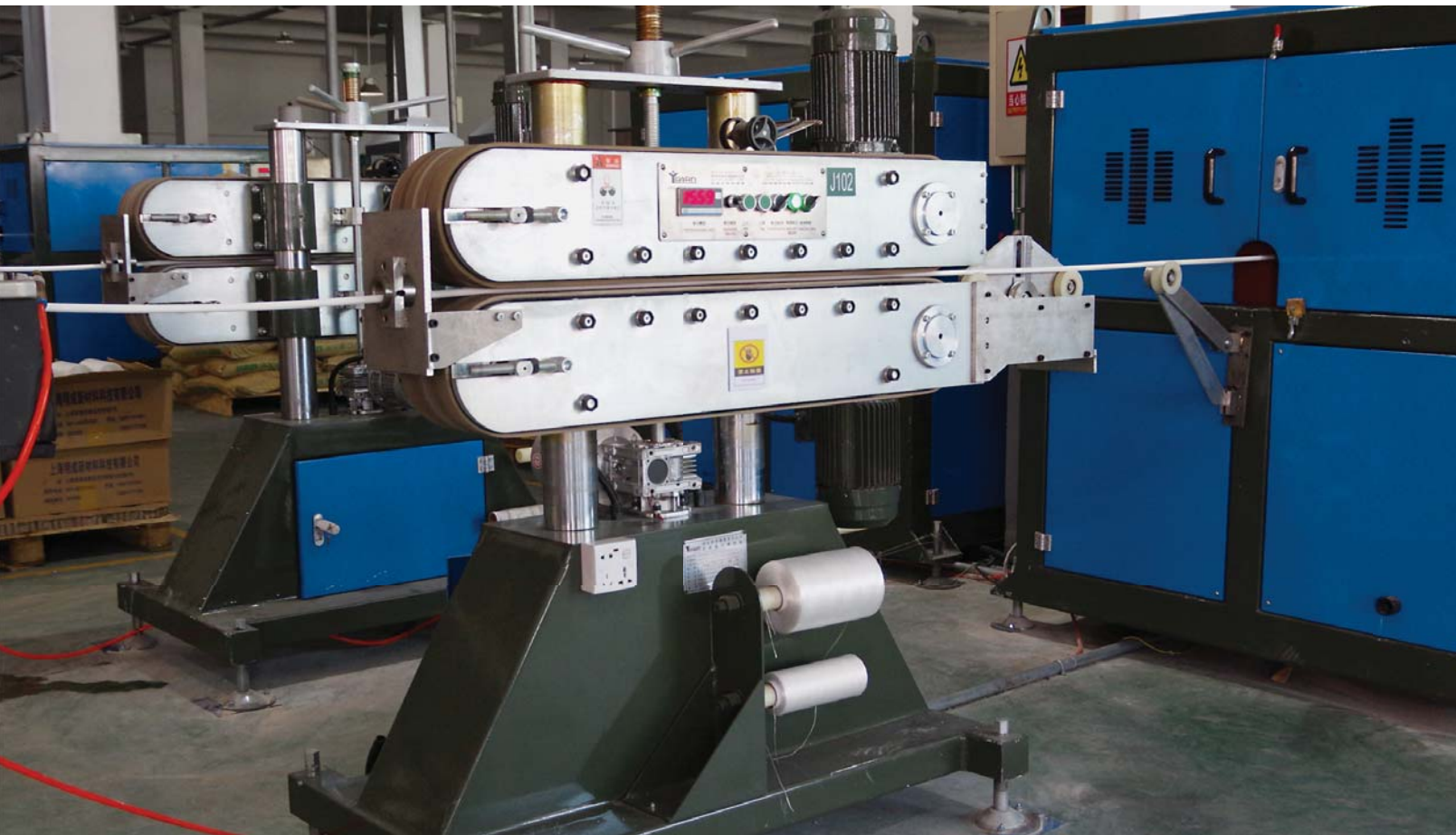



# EASTMAN®



# WORLD CLASS MANUFACTURING

Eastman owns a state-of-the-art manufacturing facility where every aspect of production is managed from start to finish. By operating our own facility, we are able to assure that the highest quality standards are met for each product. Eastman has more than 50 years of experience in designing, engineering, and manufacturing quality plumbing and appliance installation products. We are committed to maintaining or exceeding the highest level of quality standards of manufacturing for decades to come.



# EASTMAN®

## RELIABLE INVENTORY. ALWAYS IN STOCK.

Our focus is on you, the wholesaler and retailer, and our commitment is to bring the best value to help you grow your business. We carry deep inventories in our five distribution locations, which allow our customers to buy just in time, right when you need it, resulting in lower inventories, increased turns, and higher profitability.

### How to Order



#### Online: ez-flo.net

- 24/7 access to our full line product catalog
- View past orders and create easy order templates customized to your business
- Place orders anytime from anywhere



#### Fax: 866.827.3012

- Fax orders accepted 24 hours a day
- Orders will be processed during regular customer service hours



#### Phone: 800.486.5256

- Knowledgeable Customer Service reps available to assist with your orders
- **Pacific Time:** 5 AM – 3 PM
- **Mountain Time:** 6 AM – 4 PM
- **Central Time:** 7 AM – 5 PM
- **Eastern Time:** 8 AM – 6 PM



#### EDI

- Please contact Customer Service for more information on EDI orders and inquiries

## SAME DAY SHIPPING IF ORDERED BY 2 P.M.

Eastman operates five fully-stocked distribution centers totaling over 500,000 square feet of space. We are strategically located in California, Texas, North Carolina, Florida, and New Jersey so we can get you just what you need, right when you need it.

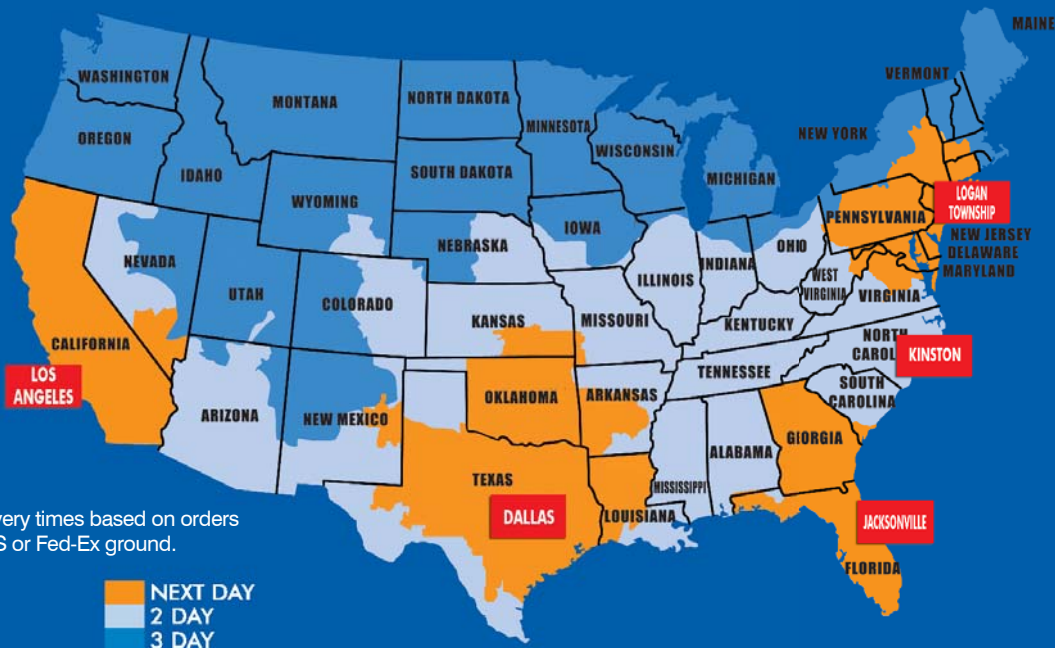

\*Above delivery times based on orders shipped UPS or Fed-Ex ground.

NEXT DAY  
 2 DAY  
 3 DAY

### NATIONAL DISTRIBUTION

# SUPERIOR PERFORMANCE & RELIABILITY

## MULTI-TURN FEATURES & BENEFITS:

- Sure-Grip Oval Handle
- DZR Brass Body
- Celcon or Brass Stems Available
- Machined Brass Components

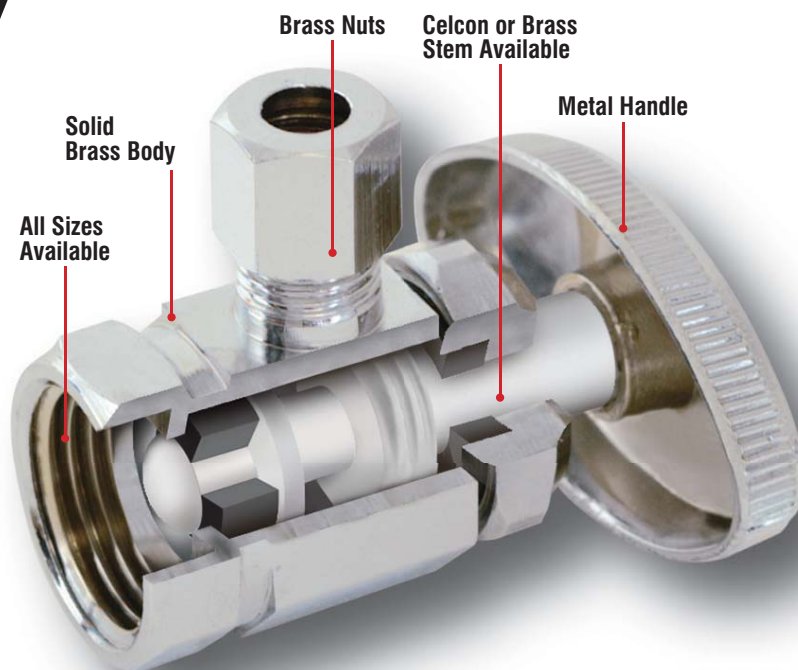

### QUALITY CERTIFICATIONS



## 1/4-TURN STOP VALVES

1/4-Turn stops feature a brass ball mechanism for easy operation and superior performance. With a one-piece shutoff component that provides smooth, positive 1/4-turn shut off. Full range of options include push-fit connections



## MULTI-TURN TURN VALVES

Solid, one-piece brass body provides strength and durability. Available in a variety of configurations.



See pages... **13-28**

FOR FULL PRODUCT LINE

# QUALITY INSTALLATION.

TRUSTED BY PROFESSIONALS FOR OVER 50 YEARS.



See pages... **267-284**

**FOR FULL PRODUCT LINE**



Steam Dryer



Dishwasher



Icemaker



Washing Machine

Eastman manufactures a full line of premium appliance installation products, such as our Steel-Flex™ water connectors, drain hoses, brass fittings, valves, and installation kits for all major appliances. All Eastman products feature superior performance for a reliable installation every time.

## OUTLET BOXES

For washing machines, dryers and icemakers

- Easy Valve Access
- One-Piece Construction
- Can Be Inverted For Top-Mount & Center Drain Option

### CONNECTION TYPES



## ACCESS PANELS

**NEW**

See pages... **143-144**



Spring Style



Metal with Frame

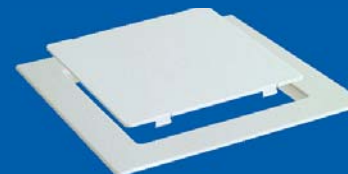

Plastic with Frame

## TANKLESS WATER HEATER SERVICE VALVE KIT

- Fast, Easy Service
- Heavy Duty Brass Construction

**NEW**



See pages... **35-36**

## WATER HEATER TANK BOOSTER

Significantly increases the amount of usable hot water from your tank!

- Increase Available Hot Water Supply
- Guards Against Scalding
- Blocks Bacteria Growth



**THERMABOOST**





Connectors



Expansion Tanks



Aluminum Pans



Plastic Pans



Stands



Vacuum Relief Valves

# TRUST THE ORIGINAL

Eastman also manufactures a full line of water heater installation & repair products

See pages... **29-38**

**FOR FULL PRODUCT LINE**

Trusted by Professionals for Over 50 Years



# EASTMAN®



**NO**  
COSTLY  
ELBOW  
NEEDED

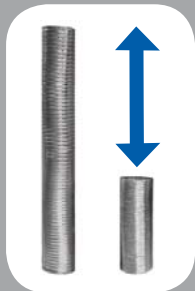

SPACE  
SAVING

**FLEXIBLE  
AND EASY  
TO INSTALL**

## ArmorFlex™ SUPER DRYER DUCT

**NEW**

PATENTED

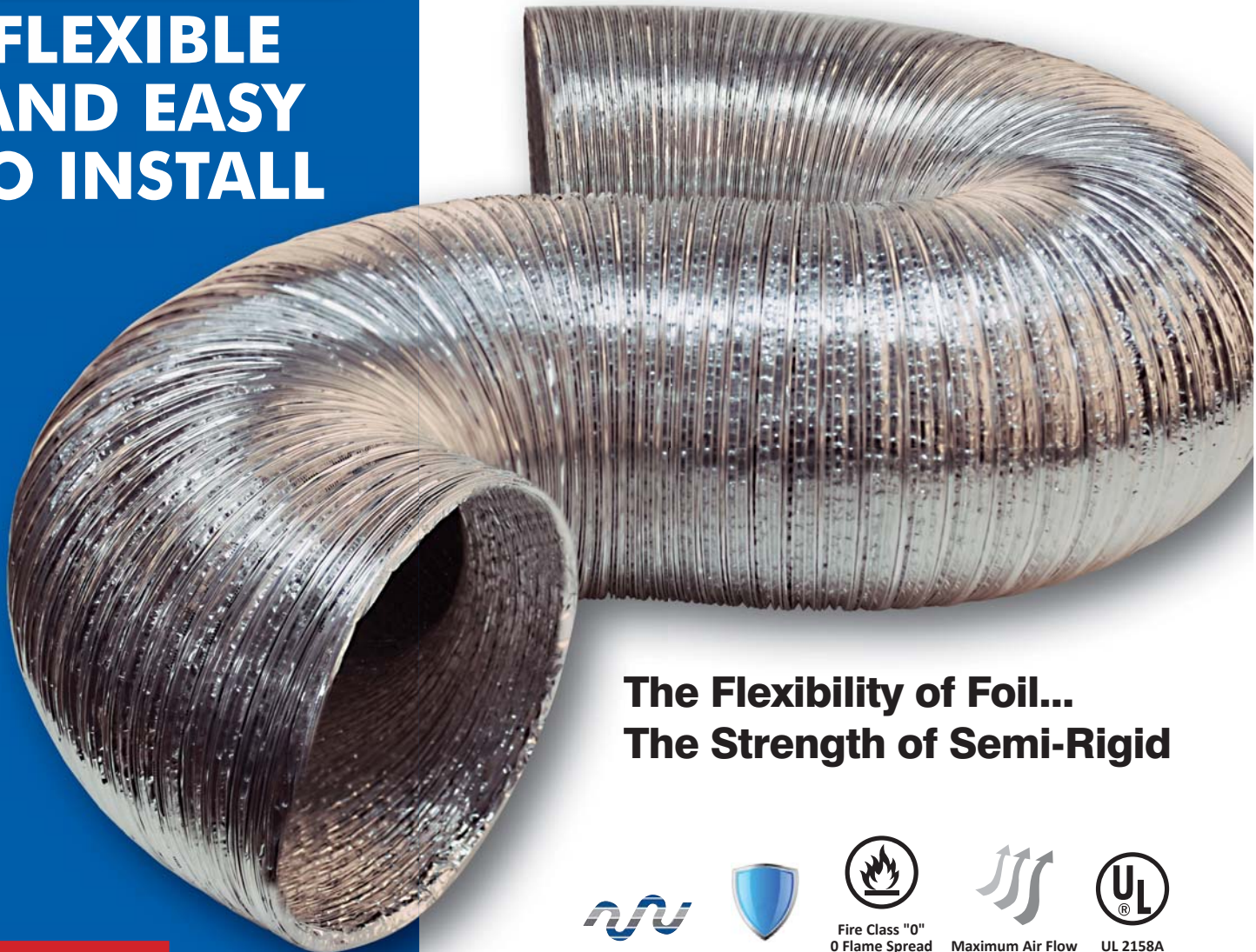

**The Flexibility of Foil...  
The Strength of Semi-Rigid**



Superior Flexibility



Crush Resistant



Fire Class "0"  
0 Flame Spread  
and 0 Smoke



Maximum Air Flow  
No Lint Buildup



UL 2158A  
Listed

See page... **285**

## POLY F1960 EXPANSION PEX FITTINGS

**NEW**

PEX is now installed more often in new home construction than copper and CPVC combined because it is cost-effective and highly durable. PEX is also flexible, resistant to scale and chlorine, and is faster to install than metal or plastic because there are fewer connections and fittings. **Eastman now offers an expanded line of PEX products.**



## BRASS F1960 EXPANSION PEX FITTINGS



See pages... **178-185**

FOR FULL PRODUCT LINE

# NEW FAUCETS!

See pages... **56-62**



**METRO COLLECTION**



**STERLING COLLECTION**



**TUSCANY COLLECTION**



# IDENTIFYING SYMBOLS



## Truck-Line Only

Items can only ship common carrier and are not available UPS/FED-EX. Orders containing these items are subject to additional freight charges.



HAZARDOUS

## Hazardous Material

Items are subject to additional charges and UPS/FED-EX customers must order case quantities.



LEAD-FREE

## Lead Free

Indicates low-lead products containing less than .25% weighted average lead contents on wetted surfaces in applications involving dispensing water for human consumption, meeting national and local legislation.



## ADA

Americans with Disabilities Act (ADA) compliant.



## CSA

Indicates that products are certified by Canadian Standard Association for safety, performance and health effects to ensure that they comply with applicable standards.



## ASA

EZ-FLO/Eastman is a proud member of the American Supply Association which supports the advancement of wholesalers and distributors in the plumbing-heating-cooling-piping industry.



## NEW

Indicates new product introductions.



## Uniform Plumbing Code

Indicates product was tested and certified by the International Association of Plumbing & Mechanical Officials. Product is in compliance with applicable American and Canadian codes and standards.



## NSF

Product is certified by NSF International, Inc. and complies with the relevant NSF consensus standard and/or protocol.



## WaterSense

Indicates products are WaterSense certified by IAPMO R&T and meet the U.S. Environmental Protection Agency's (EPA) criteria for water efficiency standards, lavatory faucet output 1.5GPM @ 60PSI max.



## Water Quality Association

The Gold Seal Trademark distinguishes products that are certified to meet industry standards set by the Water Quality Association.



## Underwriters Laboratory

Product was tested and certified under UL standards for safety.



## ASSE International

Product is certified by ASSE International and is in compliance with applicable standards.



## Gas Appliance Manufacturers Association

Product is certified by ASSE International and is in compliance with applicable standards.

**SUPPLY CONNECTORS..... Pgs. 2-12**

**STOP VALVES ..... Pgs. 13-28**

**WATER HEATER..... Pgs. 29-38**

**GAS CONNECTORS ..... Pgs. 39-46**

**WATER FILTRATION..... Pgs. 47-53**

**SINKS / FAUCETS..... Pgs. 54-80**

**TUBULAR / DRAINAGE ..... Pgs. 81-110**

**FAUCET REPAIR ..... Pgs. 111-136**

**BATH ACCESSORIES ..... Pgs. 137-150**

**PIPE FITTINGS / REPAIR..... Pgs. 151-214**

**VALVES ..... Pgs. 215-224**

**CEMENTS / SEALANTS..... Pgs. 225-238**

**TOOLS / SAFETY..... Pgs. 239-246**

**TOILET REPAIR..... Pgs. 247-266**

**APPLIANCE / HVAC..... Pgs. 267-298**

**HARDWARE..... Pgs. 299-308**

**ELECTRICAL..... Pgs. 309-316**

**INDEX ..... Pgs. 317-346**

# SUPPLY LINE DISPLAYS

## Flexible Supply Line Starter Display

Part# Disp-2005

**STAINLESS STEEL FLEXIBLE - #DISP-2005**

- Free display rack
- List \$190.46



Stainless Steel Flexible

PART #	LENGTH	OUTLET x INLET	ORDER QTY.
48003	12" Sink	FIP x Comp	10
48004	16" Sink	FIP x Comp	10
48005N	20" Sink	FIP x Comp	10
48087	9" Toilet	B/C x Comp	10
48089	16" Toilet	B/C x Comp	10

## Flexible Supply Line Starter Display

Part# Disp-2006

**PVC FLEXIBLE VINYL - #DISP-2006**

- Free display rack
- List \$149.49



PVC Flexible

PART #	LENGTH	OUTLET x INLET	ORDER QTY.
48130	12" Sink	FIP x Comp	10
48131	16" Sink	FIP x Comp	10
48132	20" Sink	FIP x Comp	10
48145	9" Toilet	B/C x Comp	10
48170	12" Toilet	B/C x Comp	10
48175	16" Toilet	B/C x Comp	10

## Water Heater Connector Display

Part# Disp-2007

**COPPER WATER HEATER - #DISP-2007**

- Free display rack
- List \$361.16



Copper Water Heater

PART #	LENGTH	OUTLET x INLET	ORDER QTY.
0437712	12"	3/4" FIP x 3/4" FIP	8
0437718	18"	3/4" FIP x 3/4" FIP	8
0437724	24"	3/4" FIP x 3/4" FIP	8
0436912	12"	3/4" FIP x Female Sweat	8
0436918	18"	3/4" FIP x Female Sweat	8
0436924	24"	3/4" FIP x Female Sweat	8

## Water Heater Connector Display

Part# Disp-2008

**STAINLESS STEEL BRAIDED WATER HEATER - #DISP-2008**

- Free display rack
- List \$662.97



Stainless Steel Braided Water Heater

PART #	LENGTH	OUTLET x INLET	ORDER QTY.
48250	12"	3/4" FIP x 3/4" FIP	10
48251	18"	3/4" FIP x 3/4" FIP	10
48252	24"	3/4" FIP x 3/4" FIP	10
48257	18"	3/4" FIP x 3/4" Comp	10
48258	24"	3/4" FIP x 3/4" Comp	10
48254	18"	3/4" MIP x 3/4" FIP	10

## Supply Line Display Racks

Part# Disp-2003

**SUPPLY LINE DISPLAY RACK DISP-2003**

- Holds 6 sizes
- Total 60 hoses
- List \$71.28



Supply Line Display

Part# Disp-2004

**WATER HEATER CONNECTOR DISPLAY RACK DISP-2004**

- Holds 6 sizes
- Total 48 hoses
- List \$66.38



Water Heater Connector Display

**VISIT US  
ONLINE!  
www.EZ-FLO.net**

# SUPPLY CONNECTORS

## EASTMAN<sup>®</sup> STEEL-FLEX<sup>®</sup>

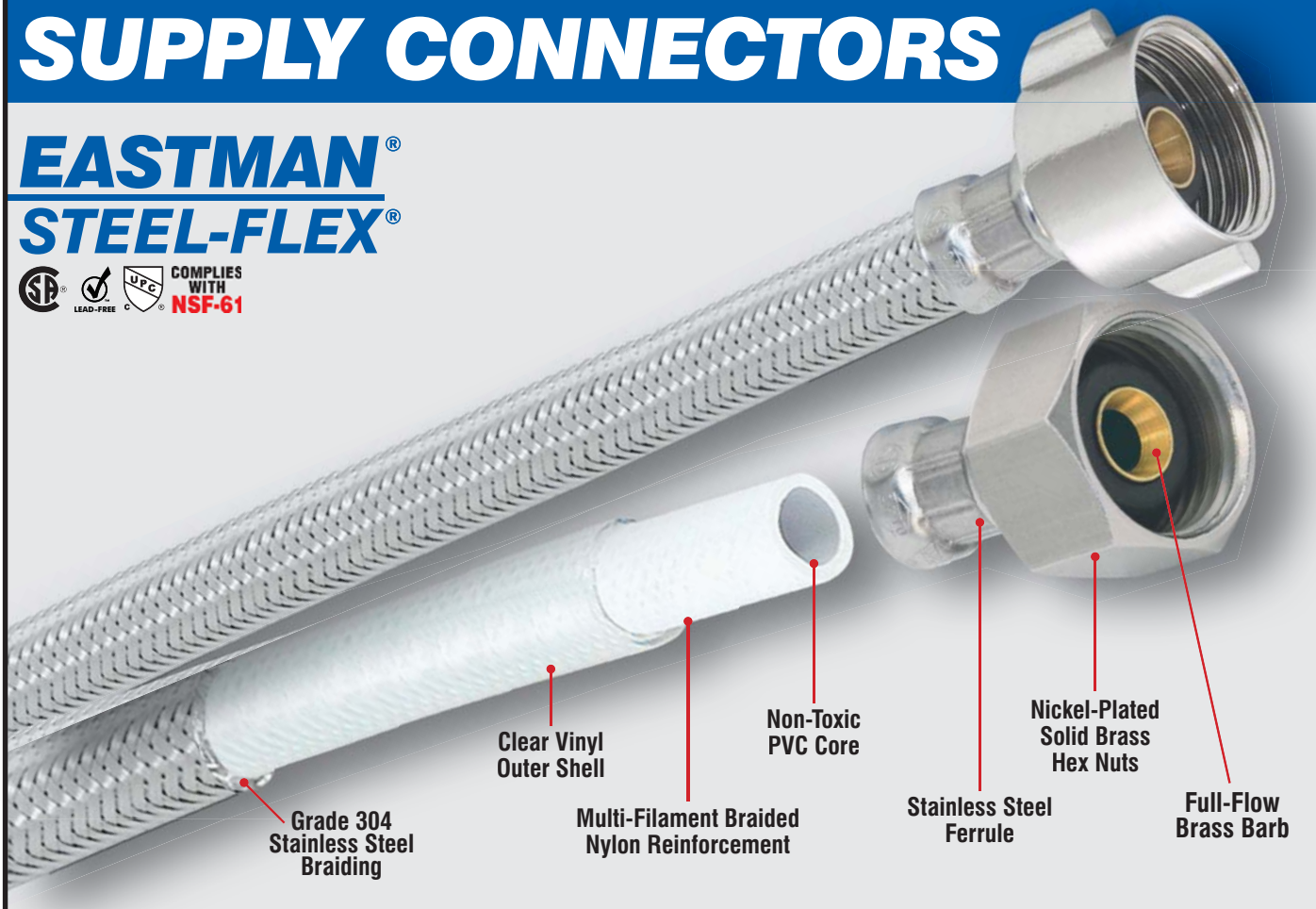

Grade 304  
Stainless Steel  
Braiding

Clear Vinyl  
Outer Shell

Multi-Filament Braided  
Nylon Reinforcement

Non-Toxic  
PVC Core

Stainless Steel  
Ferrule

Nickel-Plated  
Solid Brass  
Hex Nuts

Full-Flow  
Brass Barb

## Lavatory / Sink Connectors

### COMPRESSION INLET

- Brass bars
- Nickel-plated brass nuts



PART #	OUTLET x INLET	LENGTH	UNIT ORDER	INNER/ MASTER	PACK	LIST
48030	1/2" FIP x 3/8" Comp	9"	1	25/100	BULK	4.42
48003	1/2" FIP x 3/8" Comp	12"	25	25/100	BULK	4.02
48004	1/2" FIP x 3/8" Comp	16"	25	25/100	BULK	4.12
48005N	1/2" FIP x 3/8" Comp	20"	25	25/100	BULK	4.38
48006	1/2" FIP x 3/8" Comp	24"	1	25/100	BULK	5.36
48007	1/2" FIP x 3/8" Comp	30"	1	25/100	BULK	6.36
48008	1/2" FIP x 3/8" Comp	36"	1	25/100	BULK	7.56
48301	1/2" FIP x 3/8" Comp	48"	1	25/50	BULK	10.12
48302	1/2" FIP x 3/8" Comp	60"	1	25/50	BULK	10.06
48303	1/2" FIP x 3/8" Comp	72"	1	-/50	BULK	11.12



PART #	OUTLET x INLET	LENGTH	UNIT ORDER	INNER/ MASTER	PACK	LIST
48025	1/2" FIP x 1/2" Comp	12"	1	25/100	BULK	4.70
48026	1/2" FIP x 1/2" Comp	16"	1	25/100	BULK	5.33
48027	1/2" FIP x 1/2" Comp	20"	1	25/100	BULK	5.13
48051	1/2" FIP x 1/2" Comp	30"	1	25/100	BULK	5.30
48028	1/2" FIP x 1/2" Comp - <b>NEW!</b>	36"	1	25/100	BULK	5.99
48029	1/2" FIP x 1/2" Comp - <b>NEW!</b>	48"	1	-/50	BULK	8.10



Supply  
Connectors

Stop  
Valves

Water  
Heater

Gas  
Connectors

Water  
Filtration

Sinks/  
Faucets

Tubular/  
Drainage

Faucet  
Repair

Bath  
Accessories

Pipe Fittings/  
Repair

Valves

Cements/  
Sealants

Tools/  
Safety

Toilet  
Repair

Appliance/  
HVAC

Hardware

Electrical

Index

# STEEL-FLEX® STAINLESS STEEL SUPPLY LINES

## Lavatory / Sink Connectors

### COMPRESSION INLET

- Brass barb
- Nickel-plated brass nuts

**NEW**



PART #	OUTLET x INLET	LENGTH	UNIT ORDER	INNER/MASTER	PACK	LIST
48742	1/2" FIP x 7/16" Comp	12"	1	25/100	BULK	3.88
48744	1/2" FIP x 7/16" Comp	20"	1	25/100	BULK	4.82



PART #	OUTLET x INLET	LENGTH	UNIT ORDER	INNER/MASTER	PACK	LIST
48073	3/8" Comp x 3/8" Comp	12"	1	25/100	BULK	4.42
48074	3/8" Comp x 3/8" Comp	16"	1	25/100	BULK	3.27
48075	3/8" Comp x 3/8" Comp	20"	1	25/100	BULK	4.85
48076	3/8" Comp x 3/8" Comp	24"	1	25/100	BULK	5.96
48032	3/8" Comp x 3/8" Comp	30"	1	25/100	BULK	5.33
48078	3/8" Comp x 3/8" Comp	36"	1	25/100	BULK	7.58
48033	3/8" Comp x 3/8" Comp	48"	1	25/50	BULK	10.04
48080	3/8" Comp x 3/8" Comp	60"	1	25/50	BULK	9.32
48034	3/8" Comp x 3/8" Comp	72"	1	-/25	BULK	11.06
48082	3/8" Comp x 3/8" Comp	96"	1	-/25	BULK	8.01

### FIP INLET

- Brass barb
- Nickel-plated brass nut



PART #	OUTLET x INLET	LENGTH	UNIT ORDER	INNER/MASTER	PACK	LIST
48013	1/2" FIP x 1/2" FIP - <b>NEW!</b>	6"	25	25/100	BULK	3.39
48014	1/2" FIP x 1/2" FIP - <b>NEW!</b>	9"	25	25/100	BULK	3.91
48015	1/2" FIP x 1/2" FIP	12"	25	25/100	BULK	4.70
48016	1/2" FIP x 1/2" FIP	16"	25	25/100	BULK	5.05
48017	1/2" FIP x 1/2" FIP	20"	25	25/100	BULK	5.33
48018	1/2" FIP x 1/2" FIP	24"	1	25/100	BULK	6.22
48019	1/2" FIP x 1/2" FIP	30"	1	25/100	BULK	6.70
48020	1/2" FIP x 1/2" FIP - <b>NEW!</b>	36"	1	25/100	BULK	6.70
48021	1/2" FIP x 1/2" FIP - <b>NEW!</b>	48"	1	10/100	BULK	9.32
48022	1/2" FIP x 1/2" FIP - <b>NEW!</b>	60"	1	-/50	BULK	10.21

### MIP INLET

- Brass barb
- Nickel-plated brass nut

**NEW**



PART #	OUTLET x INLET	LENGTH	UNIT ORDER	INNER/MASTER	PACK	LIST
48041	1/2" FIP x 1/2" MIP	20"	1	25/100	BULK	5.59

### DELTA® STYLE

- Brass barb
- Nickel-plated brass nut
- Male 3/8" OD copper compression outlet



PART #	OUTLET x INLET	LENGTH	UNIT ORDER	INNER/MASTER	PACK	LIST
48035	3/8" OD Male Comp x 3/8" Comp	12"	1	25/100	BULK	5.10
48036	3/8" OD Male Comp x 3/8" Comp - <b>NEW!</b>	16"	1	25/100	BULK	4.28
48037	3/8" OD Male Comp x 3/8" Comp	20"	1	25/100	BULK	6.70



## Lavatory / Sink Connectors

### FLARE INLET

- Brass barbs
- Nickel-plated brass nuts



PART #	OUTLET x INLET	LENGTH	UNIT ORDER	INNER/MASTER	PACK	LIST
48045	1/2" FIP x 3/8" Flare	12"	1	25/100	BULK	5.82
48047	1/2" FIP x 3/8" Flare	20"	1	25/100	BULK	6.81



PART #	OUTLET x INLET	LENGTH	UNIT ORDER	INNER/MASTER	PACK	LIST
48064	1/2" FIP x 1/2" Flare	20"	1	25/100	BULK	5.39



### WIDESPREAD FAUCET

- Brass barbs
- Nickel-plated brass nuts



PART #	OUTLET x INLET	LENGTH	UNIT ORDER	INNER/MASTER	PACK	LIST
48141	3/8" Comp x 3/8" Comp	6"	1	25/100	BULK	3.93

## Toilet Connectors - Brass Nut

### COMPRESSION INLET

- Brass barbs
- Nickel-plated brass compression nut
- Nickel-plated brass ballcock nut



PART #	OUTLET x INLET	LENGTH	UNIT ORDER	INNER/MASTER	PACK	LIST
48087	7/8" B/C x 3/8" Comp	9"	25	25/100	BULK	4.25
48088	7/8" B/C x 3/8" Comp	12"	25	25/100	BULK	3.60
48089	7/8" B/C x 3/8" Comp	16"	25	25/100	BULK	4.62
48090	7/8" B/C x 3/8" Comp	20"	25	25/100	BULK	4.92



PART #	OUTLET x INLET	LENGTH	UNIT ORDER	INNER/MASTER	PACK	LIST
48092	7/8" B/C x 1/2" Comp - NEW!	9"	1	25/100	BULK	3.91
48114	7/8" B/C x 1/2" Comp	12"	1	25/100	BULK	4.85
48094	7/8" B/C x 1/2" Comp	16"	1	25/100	BULK	5.53



PART #	OUTLET x INLET	LENGTH	UNIT ORDER	INNER/MASTER	PACK	LIST
48739	7/8" B/C x 7/16" Comp - NEW!	12"	1	25/100	BULK	5.45
48741	7/8" B/C x 7/16" Comp - NEW!	20"	1	25/100	BULK	4.28



Supply Connectors

Stop Valves

Water Heater

Gas Connectors

Water Filtration

Sinks/ Faucets

Tubular/ Drainage

Faucet Repair

Bath Accessories

Pipe Fittings/ Repair

Valves

Cements/ Sealants

Tools/ Safety

Toilet Repair

Appliance/ HVAC

Hardware

Electrical

Index

# STEEL-FLEX® STAINLESS STEEL SUPPLY LINES

## Toilet Connectors - Brass Nut

### FIP INLET

- Brass barbs
- Nickel-plated brass compression nut
- Nickel-plated brass ballcock nut



PART #	OUTLET x INLET	LENGTH	UNIT ORDER	INNER/ MASTER	PACK	LIST
48083	7/8" B/C x 1/2" FIP - <b>NEW!</b>	9"	25	25/100	BULK	<b>4.13</b>
48084	7/8" B/C x 1/2" FIP	12"	25	25/100	BULK	<b>4.90</b>
48085	7/8" B/C x 1/2" FIP	16"	25	25/100	BULK	<b>5.33</b>
48086	7/8" B/C x 1/2" FIP - <b>NEW!</b>	20"	25	25/100	BULK	<b>5.45</b>

### FLARE INLET

- Brass barbs
- Nickel-plated brass compression nut
- Nickel-plated brass ballcock nut



PART #	OUTLET x INLET	LENGTH	UNIT ORDER	INNER/ MASTER	PACK	LIST
48097	7/8" B/C x 3/8" Flare	12"	1	25/100	BULK	<b>5.33</b>
48118	7/8" B/C x 3/8" Flare - <b>NEW!</b>	20"	1	25/100	BULK	<b>6.56</b>



PART #	OUTLET x INLET	LENGTH	UNIT ORDER	INNER/ MASTER	PACK	LIST
48125	7/8" B/C x 1/2" Flare	12"	1	25/100	BULK	<b>5.67</b>
48119	7/8" B/C x 1/2" Flare	20"	1	25/100	BULK	<b>7.70</b>

## Lavatory / Sink Connectors

### COMPRESSION INLET

- Brass barbs
- Nickel-plated brass nuts



PART #	OUTLET x INLET	LENGTH	UNIT ORDER	INNER/MASTER	PACK	LIST
48121	3/8" Comp x 3/8" Comp	12"	25	25/100	BULK	3.76
48122	3/8" Comp x 3/8" Comp	16"	25	25/100	BULK	3.96
48123	3/8" Comp x 3/8" Comp	20"	25	25/100	BULK	4.08
48731	3/8" Comp x 3/8" Comp	24"	1	25/100	BULK	4.62
48732	3/8" Comp x 3/8" Comp	36"	1	25/100	BULK	5.39
48733	3/8" Comp x 3/8" Comp	48"	25	25/50	BULK	7.19



PART #	OUTLET x INLET	LENGTH	UNIT ORDER	INNER/MASTER	PACK	LIST
48130	1/2" FIP x 3/8" Comp	12"	25	25/100	BULK	3.74
48131	1/2" FIP x 3/8" Comp	16"	25	25/100	BULK	3.85
48132	1/2" FIP x 3/8" Comp	20"	25	25/100	BULK	4.02
48127	1/2" FIP x 3/8" Comp	24"	1	25/100	BULK	4.48
48128	1/2" FIP x 3/8" Comp	30"	1	25/100	BULK	5.08
48129	1/2" FIP x 3/8" Comp	36"	1	25/100	BULK	5.53



PART #	OUTLET x INLET	LENGTH	UNIT ORDER	INNER/MASTER	PACK	LIST
48138	1/2" FIP x 1/2" Comp	12"	1	25/100	BULK	4.02
48139	1/2" FIP x 1/2" Comp	16"	1	25/100	BULK	4.11
48152	1/2" FIP x 1/2" Comp	20"	1	25/100	BULK	3.63
48155	1/2" FIP x 1/2" Comp	24"	1	25/100	BULK	5.22
48143	1/2" FIP x 1/2" Comp	36"	1	25/100	BULK	4.54

### COMPRESSION INLET

- Celcon barbs
- Nickel-plated brass nuts



PART #	OUTLET x INLET	LENGTH	UNIT ORDER	INNER/MASTER	PACK	LIST
48909	1/2" FIP x 3/8" Comp	12"	25	25/100	BULK	3.22
48910	1/2" FIP x 3/8" Comp	16"	25	25/100	BULK	3.42
48911	1/2" FIP x 3/8" Comp	20"	25	25/100	BULK	3.68
48912	1/2" FIP x 3/8" Comp	24"	25	25/100	BULK	4.05
48913	1/2" FIP x 3/8" Comp	30"	25	25/100	BULK	4.68
48914	1/2" FIP x 3/8" Comp	36"	25	25/100	BULK	4.70

Supply Connectors

Stop Valves

Water Heater

Gas Connectors

Water Filtration

Sinks/ Faucets

Tubular/ Drainage

Faucet Repair

Bath Accessories

Pipe Fittings/ Repair

Valves

Cements/ Sealants

Tools/ Safety

Toilet Repair

Appliance/ HVAC

Hardware

Electrical

Index

# SPEED-FLEX® FLEXIBLE REINFORCED PVC SUPPLY LINES

## Lavatory / Sink Connectors

### FIP INLET

- Brass barbs
- Nickel-plated brass nuts



PART #	OUTLET x INLET	LENGTH	UNIT ORDER	INNER/ MASTER	PACK	LIST
48149	1/2" FIP x 1/2" FIP	12"	25	25/100	BULK	4.02
48133	1/2" FIP x 1/2" FIP	16"	25	25/100	BULK	4.13
48134	1/2" FIP x 1/2" FIP	20"	25	25/100	BULK	4.39
48135	1/2" FIP x 1/2" FIP	24"	1	25/100	BULK	4.99
48136	1/2" FIP x 1/2" FIP	30"	1	25/100	BULK	5.27
48137	1/2" FIP x 1/2" FIP	36"	1	25/100	BULK	5.65



### FIP INLET

- Celcon barbs
- Nickel-plated brass nuts



PART #	OUTLET x INLET	LENGTH	UNIT ORDER	INNER/ MASTER	PACK	LIST
48901	1/2" FIP x 1/2" FIP	16"	25	25/100	BULK	3.42
48902	1/2" FIP x 1/2" FIP	20"	25	25/100	BULK	3.68
48903	1/2" FIP x 1/2" FIP	24"	25	25/100	BULK	4.05
48904	1/2" FIP x 1/2" FIP	30"	25	25/100	BULK	4.70
48905	1/2" FIP x 1/2" FIP	36"	25	25/100	BULK	4.70



### FLARE INLET

- Brass barbs
- Nickel-plated brass nuts



PART #	OUTLET x INLET	LENGTH	UNIT ORDER	INNER/ MASTER	PACK	LIST
48723	1/2" FIP x 3/8" Flare	12"	25	25/100	BULK	4.28
48166	1/2" FIP x 3/8" Flare	16"	25	25/100	BULK	3.85
48724	1/2" FIP x 3/8" Flare	20"	25	25/100	BULK	4.85



### DELTA® STYLE

- Brass barbs
- Nickel-plated brass nut
- Male 3/8" OD copper compression outlet



PART #	OUTLET x INLET	LENGTH	UNIT ORDER	INNER/ MASTER	PACK	LIST
48150	3/8" OD Male Comp x 3/8" Comp	12"	25	25/100	BULK	4.79
48151	3/8" OD Male Comp x 3/8" Comp	20"	25	25/100	BULK	5.08



## Toilet Connectors - Brass Nut

### COMPRESSION INLET

- Nickel-plated brass compression nut
- Nickel-plated brass ballcock nut
- Brass barbs



PART #	OUTLET x INLET	LENGTH	UNIT ORDER	INNER/MASTER	PACK	LIST
48978	7/8" B/C x 3/8" Comp	9"	1	25/100	BULK	3.56
48145	7/8" B/C x 3/8" Comp	12"	1	25/100	BULK	3.65
48170	7/8" B/C x 3/8" Comp	16"	1	25/100	BULK	3.85
48175	7/8" B/C x 3/8" Comp	20"	1	25/100	BULK	3.99



PART #	OUTLET x INLET	LENGTH	UNIT ORDER	INNER/MASTER	PACK	LIST
48179	7/8" B/C x 1/2" Comp	12"	1	25/100	BULK	4.11

### FIP INLET

- Nickel-plated brass compression nut
- Nickel-plated brass ballcock nut
- Brass barbs



PART #	OUTLET x INLET	LENGTH	UNIT ORDER	INNER/MASTER	PACK	LIST
48169	7/8" B/C x 1/2" FIP	9"	1	25/100	BULK	2.72
48958	7/8" B/C x 1/2" FIP	12"	1	25/100	BULK	3.76
48959	7/8" B/C x 1/2" FIP	16"	1	25/100	BULK	3.91
48960	7/8" B/C x 1/2" FIP	20"	1	25/100	BULK	4.11

### FLARE INLET

- Nickel-plated brass compression nut
- Nickel-plated brass ballcock nut
- Brass barbs



PART #	OUTLET x INLET	LENGTH	UNIT ORDER	INNER/MASTER	PACK	LIST
48183	7/8" B/C x 3/8" Flare	12"	1	25/100	BULK	4.13
48722	7/8" B/C x 3/8" Flare	20"	1	25/100	BULK	3.76



PART #	OUTLET x INLET	LENGTH	UNIT ORDER	INNER/MASTER	PACK	LIST
48973	7/8" B/C x 1/2" Flare	12"	1	25/100	BULK	4.13
48972	7/8" B/C x 1/2" Flare	20"	1	25/100	BULK	4.68



Supply Connectors

Stop Valves

Water Heater

Gas Connectors

Water Filtration

Sinks/Faucets

Tubular/Drainage

Faucet Repair

Bath Accessories

Pipe Fittings/Repair

Valves

Cements/Sealants

Tools/Safety

Toilet Repair

Appliance/HVAC

Hardware

Electrical

Index

# SUPPLY LINE RISERS / INSTALLATION KITS

## Faucet Risers

### PEX RISERS WITH DELRIN COMPRESSION RING

- 3/8" - 7/16" or 1/2"
- For faucet installation



PART #	DESCRIPTION	LENGTH	UNIT ORDER	INNER/ MASTER	PACK	LIST
25340	3/8" OD PEX Tube	12"	25	25/200	BULK	1.20
25342	3/8" OD PEX Tube	20"	10	10/200	BULK	1.60
25344	3/8" OD PEX Tube	30"	25	25/200	BULK	2.08
25346	3/8" OD PEX Tube	36"	25	25/200	BULK	2.17



### SEMI-RIGID COPPER RISERS - 3/8" INSTALLATION

- Chrome-plated copper tube
- For faucet installation



PART #	DESCRIPTION	FINISH	LENGTH	UNIT ORDER	INNER/ MASTER	PACK	LIST
25695	3/8" OD	Chrome	12"	25	25/300	BULK	4.38
25696	3/8" OD	Chrome	15"	25	25/300	BULK	6.03
25697	3/8" OD	Chrome	20"	25	25/200	BULK	6.46
25699	3/8" OD	Chrome	30"	25	25/100	BULK	10.31



## Toilet Risers

### PEX RISERS WITH DELRIN COMPRESSION RING

- 3/8" - 7/16" or 1/2"
- For toilet installation



PART #	DESCRIPTION	LENGTH	UNIT ORDER	INNER/ MASTER	PACK	LIST
25348	3/8" OD PEX Tube	12"	10	10/200	BULK	1.20
25350	3/8" OD PEX Tube	20"	10	10/200	BULK	1.60



### SEMI-RIGID COPPER RISERS - 3/8" INSTALLATION

- Chrome-plated copper tube
- For toilet installation



PART #	DESCRIPTION	FINISH	LENGTH	UNIT ORDER	INNER/ MASTER	PACK	LIST
25698	3/8" OD	Chrome	12"	25	25/300	BULK	4.62
25680	3/8" OD	Chrome	20"	25	25/200	BULK	7.50



## Faucet Installation Kits

### FAUCET INSTALLATION KIT

- (2) 5/8" OD x 3/8" OD multi-turn angle stop valves
- (2) 1/2" FIP x 3/8" comp x 16" length stainless steel flexible supply lines
- (2) 5/8" OD sure-grip flanges



PART #	DESCRIPTION	UNIT ORDER	INNER/ MASTER	PACK	LIST
48307LF	Faucet Install Kit	1	-/10	BAG	24.66



## Faucet Installation Kits

### FAUCET INSTALLATION KIT

- (2) 5/8" OD x 3/8" OD multi-turn angle stop valves
- (2) 1/2" FIP x 3/8" comp x 20" length stainless steel flexible supply lines
- (2) 5/8" OD sure-grip flanges

**NEW**



PART #	DESCRIPTION	UNIT ORDER	INNER/ MASTER	PACK	LIST
48221	Faucet Install Kit	1	-/10	BAG	22.81



### FAUCET INSTALLATION KIT

- (2) 5/8" OD x 3/8" OD 1/4-turn angle stop valves
- (2) 3/8" OD x 12" length semi-rigid, chrome-plated copper risers
- Copper riser is formed from a single piece of copper tube and can be cut to length for easy installation
- (2) 5/8" OD sure-grip flanges

**NEW**



PART #	DESCRIPTION	UNIT ORDER	INNER/ MASTER	PACK	LIST
10791	Faucet Install Kit	1	-/12	BAG	36.27



## Toilet Installation Kits

### TOILET INSTALLATION KIT

- Multi-turn
- 1- 5/8" OD x 3/8" OD low-lead angle stop
- 1- 3/8" Comp x 7/8" ballcock nut x 12" stainless steel supply line
- 1- 5/8" OD sure-grip flange



PART #	DESCRIPTION	UNIT ORDER	INNER/ MASTER	PACK	LIST
48311	Toilet Install Kit	1	-/12	BAG	13.63



### TOILET INSTALLATION KIT

- 1/4-Turn
- 5/8" OD x 3/8" OD 1/4-turn angle stop
- 3/8" Comp x 7/8" ballcock nut x 12" stainless steel supply line
- 5/8" OD sure-grip flange



PART #	DESCRIPTION	UNIT ORDER	INNER/ MASTER	PACK	LIST
48208	Toilet Install Kit	1	-/50	BAG	10.06



Supply Connectors

Stop Valves

Water Heater

Gas Connectors

Water Filtration

Sinks/ Faucets

Tubular/ Drainage

Faucet Repair

Bath Accessories

Pipe Fittings/ Repair

Valves

Cements/ Sealants

Tools/ Safety

Toilet Repair

Appliance/ HVAC

Hardware

Electrical

Index

# INSTALLATION KITS

## Toilet Installation Kits

### TOILET INSTALLATION KIT

- 5/8" OD x 3/8" OD multi-turn angle stop valve
- 3/8" OD x 12" length semi-rigid, chrome-plated copper riser
- Copper riser has a formed nosepiece with gasket and can be cut to length for easy installation
- 5/8" OD sure-grip flange



PART #	DESCRIPTION	UNIT ORDER	INNER/MASTER	PACK	LIST
48342	Toilet Install Kit	1	-/75	BAG	14.17

### TOILET INSTALLATION KIT

**NEW**

- 5/8" OD x 3/8" OD 1/4-turn angle stop valve
- 3/8" OD x 12" length semi-rigid, chrome-plated copper riser
- 5/8" OD sure-grip flange



PART #	DESCRIPTION	UNIT ORDER	INNER/MASTER	PACK	LIST
10790	Toilet Install Kit	1	-/12	BAG	17.11

## SEE FULL LINE OF TOILET REPAIR PRODUCTS

**NEW**

See pages... **247-266**



**NEW Elastomer Gaskets!**

**EASTMAN**®

Visit us online at...  
[www.ez-flo.net](http://www.ez-flo.net)



# STOP VALVES

**EASTMAN**<sup>®</sup>  
**SPEED-FLEX**<sup>®</sup>

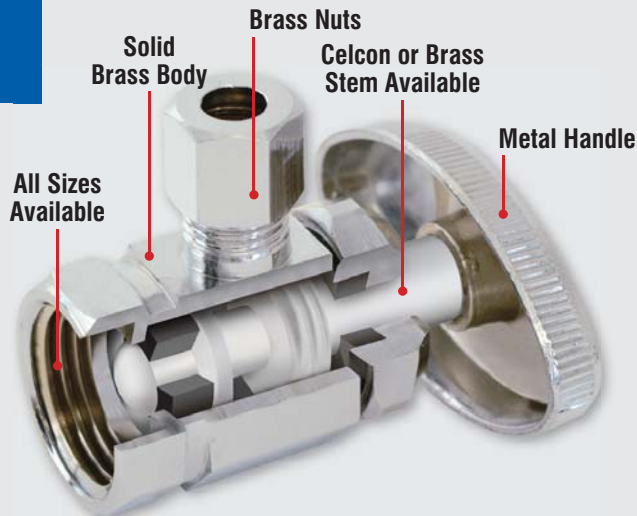

## MULTI-TURN STOP VALVES

### IRON PIPE INLET - ANGLE

- Angle stop
- Individually boxed with barcode
- High-performance celcon stem



PART #	OUTLET x INLET	FINISH	UNIT ORDER	INNER/MASTER	PACK	LIST
04129LF	1/4" OD x 1/2" FIP	Chrome Plate	24	24/96	BOX	8.27
04319LF	3/8" OD x 3/8" FIP	Chrome Plate	24	24/96	BOX	6.17
04322LF	3/8" OD x 1/2" FIP	Chrome Plate	24	24/96	BOX	6.58
04336LF	1/2" OD x 3/8" FIP	Chrome Plate	24	24/96	BOX	8.44
04338LF	1/2" OD x 1/2" FIP	Chrome Plate	24	24/96	BOX	8.44



### IRON PIPE INLET - ANGLE

- Angle stop
- Individually boxed with barcode
- Solid brass stem



PART #	OUTLET x INLET	FINISH	UNIT ORDER	INNER/MASTER	PACK	LIST
10809LF	3/8" OD x 1/2" FIP	Chrome Plate	24	24/96	BOX	9.24



### IRON PIPE INLET - STRAIGHT

- Straight stop
- Individually boxed with barcode
- High-performance celcon stem



PART #	OUTLET x INLET	FINISH	UNIT ORDER	INNER/MASTER	PACK	LIST
04318LF	3/8" OD x 3/8" FIP	Chrome Plate	24	24/96	BOX	10.24
04321LF	3/8" OD x 1/2" FIP	Chrome Plate	24	24/96	BOX	8.98



### COMPRESSION INLET - ANGLE

- Angle stop
- Individually boxed with barcode
- High-performance celcon stem



PART #	OUTLET x INLET	FINISH	UNIT ORDER	INNER/MASTER	PACK	LIST
04344LF	1/4" OD x 5/8" OD (1/2" Nom.)	Chrome Plate	24	24/96	BOX	8.13
04348LF	3/8" OD x 5/8" OD (1/2" Nom.)	Chrome Plate	24	24/96	BOX	6.69
04358LF	1/2" OD x 5/8" OD (1/2" Nom.)	Chrome Plate	24	24/96	BOX	8.01



PART #	OUTLET x INLET	FINISH	UNIT ORDER	INNER/MASTER	PACK	LIST
48286LF	1/4" OD x 5/8" OD (1/2" Nom.)	Rough Brass	24	24/96	BOX	7.98
48284LF	3/8" OD x 5/8" OD (1/2" Nom.)	Rough Brass	24	24/96	BOX	6.99



Supply Connectors

Stop Valves

Water Heater

Gas Connectors

Water Filtration

Sinks/Faucets

Tubular/Drainage

Faucet Repair

Bath Accessories

Pipe Fittings/Repair

Valves

Cements/Sealants

Tools/Safety

Toilet Repair

Appliance/HVAC

Hardware

Electrical

Index

# STOP VALVES

## Multi-Turn Stop Valves

### COMPRESSION INLET - ANGLE

- Angle stop less nut and sleeve
- Individually boxed with barcode
- High-performance celcon stem



PART #	OUTLET x INLET	FINISH	UNIT ORDER	INNER/ MASTER	PACK	LIST
48290LF	3/8" OD x 5/8" OD (1/2" Nom.)	Chrome Plate	24	24/96	BOX	6.69



### COMPRESSION INLET - STRAIGHT

- Straight stop
- Individually boxed with barcode
- High-performance celcon stem



PART #	OUTLET x INLET	FINISH	UNIT ORDER	INNER/ MASTER	PACK	LIST
04354LF	3/8" OD x 1/2" OD (3/8" Nom.)	Chrome Plate	24	24/96	BOX	9.55
04347LF	3/8" OD x 5/8" OD (1/2" Nom.)	Chrome Plate	24	24/96	BOX	8.04
04357LF	1/2" OD x 5/8" OD (1/2" Nom.)	Chrome Plate	24	24/96	BOX	9.30



PART #	OUTLET x INLET	FINISH	UNIT ORDER	INNER/ MASTER	PACK	LIST
48287LF	3/8" OD x 5/8" OD (1/2" Nom.)	Rough Brass	24	24/96	BOX	8.13



### SWEAT INLET - ANGLE

- Angle stop
- Individually boxed with barcode
- Solid brass stem



PART #	OUTLET x INLET	FINISH	UNIT ORDER	INNER/ MASTER	PACK	LIST
04384LF	1/4" OD x 1/2" Nom. Sweat	Chrome Plate	24	24/96	BOX	8.13
04387LF	3/8" OD x 1/2" Nom. Sweat	Chrome Plate	24	24/96	BOX	7.56



PART #	OUTLET x INLET	FINISH	UNIT ORDER	INNER/ MASTER	PACK	LIST
48291LF	3/8" OD x 1/2" Nom. Sweat	Rough Brass	24	24/96	BOX	7.33



### SWEAT INLET - STRAIGHT

- Straight stop
- Individually boxed with barcode
- Solid brass stem



PART #	OUTLET x INLET	FINISH	UNIT ORDER	INNER/ MASTER	PACK	LIST
04385LF	3/8" OD x 1/2" Nom. Sweat	Chrome Plate	24	24/96	BOX	7.72



PART #	OUTLET x INLET	FINISH	UNIT ORDER	INNER/ MASTER	PACK	LIST
48292LF	3/8" OD x 1/2" Nom. Sweat	Rough Brass	24	24/96	BOX	7.87



### CPVC INLET - ANGLE

- CPVC angle stop
- Individually boxed with barcode
- High-performance celcon stem



PART #	OUTLET x INLET	FINISH	UNIT ORDER	INNER/ MASTER	PACK	LIST
04345LF	3/8" OD x 1/2" Nom. CPVC	Chrome Plate	24	24/96	BOX	8.94



## Multi-Turn Stop Valves

### CPVC INLET - STRAIGHT

- CPVC straight stop
- Individually boxed with barcode
- High-performance celcon stem



PART #	OUTLET x INLET	FINISH	UNIT ORDER	INNER/MASTER	PACK	LIST
04346LF	3/8" OD x 1/2" Nom. CPVC	Chrome Plate	24	24/96	BOX	9.81



### F1807 PEX INLET - ANGLE

- Angle stop
- Individually boxed with barcode
- For use with PEX Tubing - Crimp F1807
- High-performance celcon stem



PART #	OUTLET x INLET	FINISH	UNIT ORDER	INNER/MASTER	PACK	LIST
04341LF	3/8" OD x 1/2" PEX	Chrome Plate	24	24/96	BOX	7.04



### F1807 PEX INLET - STRAIGHT

- Straight stop
- Individually boxed with barcode
- For use with PEX Tubing - Crimp F1807
- High-performance celcon stem



PART #	OUTLET x INLET	FINISH	UNIT ORDER	INNER/MASTER	PACK	LIST
04342LF	3/8" OD x 1/2" PEX	Chrome Plate	24	24/96	BOX	8.27



### F1807 PEX INLET - STRAIGHT

- Straight stop
- Individually boxed with barcode
- For use with PEX Tubing - Crimp F1807
- High-performance celcon stem



PART #	OUTLET x INLET	FINISH	UNIT ORDER	INNER/MASTER	PACK	LIST
04492LF	1/2" PEX x 1/2" PEX	Chrome Plate	24	24/96	BOX	8.70



### SWEAT INLET WITH 5" EXTENSION TUBE ATTACHED

- Angle stop
- Furnished with deep bell flange
- Individually boxed with barcode
- Solid brass stem



PART #	OUTLET x INLET	FINISH	UNIT ORDER	INNER/MASTER	PACK	LIST
04182LF	3/8" OD x 1/2" Nom. Sweat	Chrome Plate	24	24/96	BOX	13.87



### SWEAT INLET WITH 5" EXTENSION TUBE ATTACHED

- Straight stop
- Furnished with deep bell flange
- Individually boxed with barcode
- Solid brass stem



PART #	OUTLET x INLET	FINISH	UNIT ORDER	INNER/MASTER	PACK	LIST
04183LF	3/8" OD x 1/2" Nom. Sweat	Chrome Plate	24	24/96	BOX	14.67



Supply Connectors

Stop Valves

Water Heater

Gas Connectors

Water Filtration

Sinks/Faucets

Tubular/Drainage

Faucet Repair

Bath Accessories

Pipe Fittings/Repair

Valves

Cements/Sealants

Tools/Safety

Toilet Repair

Appliance/HVAC

Hardware

Electrical

Index

# STOP VALVES

## Multi-Turn Slip-Joint Stop Valves

### IRON PIPE INLET - ANGLE

- Angle stop
- Individually boxed with barcode
- High-performance celcon stem



PART #	OUTLET x INLET	FINISH	UNIT ORDER	INNER/ MASTER	PACK	LIST
04328LF	7/16" or 1/2" S/J x 1/2" FIP	Chrome Plate	24	24/96	BOX	8.41

### IRON PIPE INLET - STRAIGHT

- Straight stop
- Individually boxed with barcode
- High-performance celcon stem



PART #	OUTLET x INLET	FINISH	UNIT ORDER	INNER/ MASTER	PACK	LIST
04327LF	7/16" or 1/2" S/J x 1/2" FIP	Chrome Plate	24	24/96	BOX	10.41

### COMPRESSION INLET

- Angle stop
- Individually boxed with barcode
- High-performance celcon stem



PART #	OUTLET x INLET	FINISH	UNIT ORDER	INNER/ MASTER	PACK	LIST
04356LF	7/16" or 1/2" S/J x 5/8" OD (1/2" Nom.)	Chrome Plate	24	24/96	BOX	9.75

## Multi-Turn Dual-Outlet (Three-Way) Stop Valves

### IRON PIPE INLET

- Individually boxed with barcode
- High-performance celcon stem



PART #	OUTLET x OUTLET x INLET	FINISH	UNIT ORDER	INNER/ MASTER	PACK	LIST
04320LF	3/8" OD x 1/4" OD x 1/2" FIP	Chrome Plate	24	24/96	BOX	12.46
04326LF	3/8" OD x 3/8" OD x 1/2" FIP	Chrome Plate	24	24/96	BOX	12.74

### COMPRESSION INLET

- Individually boxed with barcode
- High-performance celcon stem



PART #	OUTLET x OUTLET x INLET	FINISH	UNIT ORDER	INNER/ MASTER	PACK	LIST
04351LF	3/8" OD x 1/4" OD x 5/8" OD (1/2" Nom.)	Chrome Plate	24	24/96	BOX	12.40
04353LF	3/8" OD x 3/8" OD x 5/8" OD (1/2" Nom.)	Chrome Plate	24	24/96	BOX	12.40



PART #	OUTLET x OUTLET x INLET	FINISH	UNIT ORDER	INNER/ MASTER	PACK	LIST
48285LF	3/8" OD x 3/8" OD x 5/8" OD (1/2" Nom.)	Rough Brass	24	24/96	BOX	12.40

### CPVC INLET

- Individually boxed with barcode
- High-performance celcon stem



PART #	OUTLET x OUTLET x INLET	FINISH	UNIT ORDER	INNER/ MASTER	PACK	LIST
04349LF	1/2" Nom. CPVC x 3/8" OD x 3/8" OD	Chrome Plate	24	24/96	BOX	19.76

## Multi-Turn Dual-Outlet (Three-Way) Stop Valves

### F1807 PEX INLET

- Individually boxed with barcode
- For use with PEX Tubing - Crimp F1807
- High-performance celcon stem



PART #	OUTLET x OUTLET x INLET	FINISH	UNIT ORDER	INNER/ MASTER	PACK	LIST
04343LF	3/8" OD x 3/8" OD x 1/2" PEX	Chrome Plate	24	24/96	BOX	13.63

## Multi-Turn Dual-Handle Stop Valves

### COMPRESSION INLET

- Individually boxed with barcode
- High-performance celcon stem



PART #	OUTLET x OUTLET x INLET	FINISH	UNIT ORDER	INNER/ MASTER	PACK	LIST
04350LF	3/8" OD x 1/4" OD x 5/8" OD (1/2" Nom.)	Chrome Plate	24	24/96	BOX	25.23
04352LF	3/8" OD x 3/8" OD x 5/8" OD (1/2" Nom.)	Chrome Plate	24	24/96	BOX	21.83

### IRON PIPE INLET

- Individually boxed with barcode
- High-performance celcon stem



PART #	OUTLET x OUTLET x INLET	FINISH	UNIT ORDER	INNER/ MASTER	PACK	LIST
04423LF	3/8" OD x 1/4" OD x 1/2" FIP	Chrome Plate	24	24/96	BOX	25.35
04325LF	3/8" OD x 3/8" OD x 1/2" FIP	Chrome Plate	24	24/96	BOX	26.92

### F1807 PEX INLET

- Individually boxed with barcode
- For use with PEX Tubing - Crimp F1807
- High-performance celcon stem



PART #	OUTLET x OUTLET x INLET	FINISH	UNIT ORDER	INNER/ MASTER	PACK	LIST
48673LF	3/8" OD x 3/8" OD x 1/2" PEX	Chrome Plate	24	24/96	BOX	24.38

## Multi-Turn Loose Key Stop Valves

### COMPRESSION INLET

- Angle stop
- With loose key handle
- High-performance celcon stem



PART #	OUTLET x INLET	FINISH	UNIT ORDER	INNER/ MASTER	PACK	LIST
04456LF	3/8" OD x 5/8" OD (1/2" Nom.)	Chrome Plate	24	24/96	BOX	11.83

Supply Connectors

Stop Valves

Water Heater

Gas Connectors

Water Filtration

Sinks/ Faucets

Tubular/ Drainage

Faucet Repair

Bath Accessories

Pipe Fittings/ Repair

Valves

Cements/ Sealants

Tools/ Safety

Toilet Repair

Appliance/ HVAC

Hardware

Electrical

Index

# 1/4-TURN BALL STOP VALVES

## EASTMAN<sup>®</sup> SPEED-FLEX<sup>®</sup>

- Brass ball mechanism for easy operation
- Teflon™ seats resist corrosion and provide a watertight seal
- Forged brass body



### 1/4-Turn Stop Valves

#### IRON PIPE INLET - 1/4-TURN

- Angle stop



PART #	OUTLET x INLET	FINISH	UNIT ORDER	INNER/MASTER	PACK	LIST
10732LF	1/4" OD x 1/2" FIP	Chrome Plate	24	24/96	BOX	9.55
10731LF	3/8" OD x 3/8" FIP	Chrome Plate	24	24/96	BOX	8.21
10733LF	3/8" OD x 1/2" FIP	Chrome Plate	24	24/96	BOX	7.72



#### IRON PIPE INLET - 1/4-TURN

- Straight stop



PART #	OUTLET x INLET	FINISH	UNIT ORDER	INNER/MASTER	PACK	LIST
10754LF	3/8" OD x 3/8" FIP	Chrome Plate	24	24/96	BOX	8.98
10755LF	3/8" OD x 1/2" FIP	Chrome Plate	24	24/96	BOX	9.41



#### COMPRESSION INLET - 1/4-TURN

- Angle stop



PART #	OUTLET x INLET	FINISH	UNIT ORDER	INNER/MASTER	PACK	LIST
10737LF	1/4" OD x 5/8" OD (1/2" Nom.)	Chrome Plate	24	24/96	BOX	9.92
10738LF	3/8" OD x 5/8" OD (1/2" Nom.)	Chrome Plate	24	24/96	BOX	7.72
10739LF	1/2" OD x 5/8" OD (1/2" Nom.)	Chrome Plate	24	24/96	BOX	9.11



#### COMPRESSION INLET - 1/4-TURN

- Angle stop less nut and sleeve



PART #	OUTLET x INLET	FINISH	UNIT ORDER	INNER/MASTER	PACK	LIST
10720LF	3/8" OD x 5/8" OD (1/2" Nom.)	Chrome Plate	24	24/96	BOX	8.18



#### COMPRESSION INLET - 1/4-TURN

- Straight stop



PART #	OUTLET x INLET	FINISH	UNIT ORDER	INNER/MASTER	PACK	LIST
10753LF	1/4" OD x 5/8" OD (1/2" Nom.)	Chrome Plate	24	24/96	BOX	10.18
10756LF	3/8" OD x 5/8" OD (1/2" Nom.)	Chrome Plate	24	24/96	BOX	9.64



## 1/4-Turn Stop Valves

### PUSH-FIT INLET - 1/4-TURN

- Angle stop



PART #	OUTLET x INLET	FINISH	UNIT ORDER	INNER/ MASTER	PACK	LIST
10773	1/4" OD x 1/2" Nom. Push-Fit	Chrome Plate	24	24/96	BOX	8.42
10774	3/8" OD x 1/2" Nom. Push-Fit	Chrome Plate	24	24/96	BOX	8.68

### PUSH-FIT INLET - 1/4-TURN

- Straight stop



PART #	OUTLET x INLET	FINISH	UNIT ORDER	INNER/ MASTER	PACK	LIST
10775	1/4" OD x 1/2" Nom. Push-Fit	Chrome Plate	24	24/96	BOX	8.42
10776	3/8" OD x 1/2" Nom. Push-Fit	Chrome Plate	24	24/96	BOX	8.68

### SWEAT INLET - 1/4-TURN

- Angle stop



PART #	OUTLET x INLET	FINISH	UNIT ORDER	INNER/ MASTER	PACK	LIST
10736LF	3/8" OD x 1/2" Nom. Sweat	Chrome Plate	24	24/96	BOX	8.98

### SWEAT INLET - 1/4-TURN

- Straight stop



PART #	OUTLET x INLET	FINISH	UNIT ORDER	INNER/ MASTER	PACK	LIST
10757LF	3/8" OD x 1/2" Nom. Sweat	Chrome Plate	24	24/96	BOX	9.27

### SWEAT INLET WITH 5" EXTENSION TUBE ATTACHED - 1/4-TURN

- Angle stop
- Furnished with deep bell flange



PART #	OUTLET x INLET	FINISH	UNIT ORDER	INNER/ MASTER	PACK	LIST
10742LF	3/8" OD x 1/2" Nom. Sweat	Chrome Plate	24	24/96	BOX	18.11

### SWEAT INLET WITH 5" EXTENSION TUBE ATTACHED - 1/4-TURN

- Straight stop
- Furnished with deep bell flange



PART #	OUTLET x INLET	FINISH	UNIT ORDER	INNER/ MASTER	PACK	LIST
10746LF	3/8" OD x 1/2" Nom. Sweat	Chrome Plate	24	24/96	BOX	18.42

### F1807 PEX INLET - 1/4-TURN

- Angle stop
- For use with PEX Tubing - Crimp F1807



PART #	OUTLET x INLET	FINISH	UNIT ORDER	INNER/ MASTER	PACK	LIST
10727LF	3/8" OD x 1/2" PEX	Chrome Plate	24	24/96	BOX	6.87

### F1807 PEX INLET - 1/4-TURN

- Straight stop
- For use with PEX Tubing - Crimp F1807



PART #	OUTLET x INLET	FINISH	UNIT ORDER	INNER/ MASTER	PACK	LIST
10728LF	3/8" OD x 1/2" PEX	Chrome Plate	24	24/96	BOX	6.87



Supply Connectors

Stop Valves

Water Heater

Gas Connectors

Water Filtration

Sinks/ Faucets

Tubular/ Drainage

Faucet Repair

Bath Accessories

Pipe Fittings/ Repair

Valves

Cements/ Sealants

Tools/ Safety

Toilet Repair

Appliance/ HVAC

Hardware

Electrical

Index

# STOP VALVES

## 1/4-Turn Stop Valves

### F1807 PEX INLET - 1/4-TURN

- Straight stop
- For use with PEX Tubing - Crimp F1807



PART #	OUTLET x INLET	FINISH	UNIT ORDER	INNER/ MASTER	PACK	LIST
10725LF	1/2" PEX x 1/2" PEX	Chrome Plate	24	24/96	BOX	8.75

### F1960 PEX INLET - 1/4-TURN

- Angle stop
- For use with PEX Tubing - Expansion F1960



PART #	OUTLET x INLET	FINISH	UNIT ORDER	INNER/ MASTER	PACK	LIST
10724LF	3/8" OD x 1/2" PEX	Chrome Plate	24	24/96	BOX	8.75

### F1960 PEX INLET - 1/4-TURN

- Angle stop
- For use with PEX Tubing - Expansion F1960



PART #	OUTLET x INLET	FINISH	UNIT ORDER	INNER/ MASTER	PACK	LIST
10719LF	1/2" PEX x 1/2" PEX	Chrome Plate	24	24/96	BOX	9.07

### F1960 PEX INLET - 1/4-TURN

- Straight stop
- For use with PEX Tubing - Expansion F1960



PART #	OUTLET x INLET	FINISH	UNIT ORDER	INNER/ MASTER	PACK	LIST
10723LF	3/8" OD x 1/2" PEX	Chrome Plate	24	24/96	BOX	8.75

### F1960 PEX INLET - 1/4-TURN

- Straight stop
- For use with PEX Tubing - Expansion F1960



PART #	OUTLET x INLET	FINISH	UNIT ORDER	INNER/ MASTER	PACK	LIST
10718LF	1/2" PEX x 1/2" PEX	Chrome Plate	24	24/96	BOX	9.07

### CPVC INLET - 1/4-TURN

- Angle stop



PART #	OUTLET x INLET	FINISH	UNIT ORDER	INNER/ MASTER	PACK	LIST
10729LF	3/8" OD x 1/2" Nom. CPVC	Chrome Plate	24	24/96	BOX	10.06

### CPVC INLET - 1/4-TURN

- Straight stop



PART #	OUTLET x INLET	FINISH	UNIT ORDER	INNER/ MASTER	PACK	LIST
10730LF	3/8" OD x 1/2" Nom. CPVC	Chrome Plate	24	24/96	BOX	11.35





## 1/4-Turn Slip-Joint Stop Valves

### IRON PIPE INLET - 1/4-TURN

- Angle stop



PART #	OUTLET x INLET	FINISH	UNIT ORDER	INNER/ MASTER	PACK	LIST
10735LF	1/2" or 7/16" S/J x 1/2" FIP	Chrome Plate	24	24/96	BOX	10.78

### COMPRESSION INLET - 1/4-TURN

- Straight stop



PART #	OUTLET x INLET	FINISH	UNIT ORDER	INNER/ MASTER	PACK	LIST
10740LF	1/2" or 7/16" S/J x 5/8" OD (1/2" Nom.)	Chrome Plate	24	24/96	BOX	10.06



## 1/4-Turn Dual-Outlet (Three-way) Stop Valves

### COMPRESSION INLET - 1/4-TURN

- Dual-outlet



PART #	OUTLET x OUTLET x INLET	FINISH	UNIT ORDER	INNER/ MASTER	PACK	LIST
48654LF	3/8" OD x 1/4" OD x 5/8" OD (1/2" Nom.)	Chrome Plate	24	24/96	BOX	20.67
48652LF	3/8" OD x 3/8" OD x 5/8" OD (1/2" Nom.)	Chrome Plate	24	24/96	BOX	20.67

### IRON PIPE INLET - 1/4-TURN

- Dual-outlet



PART #	OUTLET x OUTLET x INLET	FINISH	UNIT ORDER	INNER/ MASTER	PACK	LIST
48655LF	3/8" OD x 1/4" OD x 1/2" FIP	Chrome Plate	24	24/96	BOX	14.03
48651LF	3/8" OD x 3/8" OD x 1/2" FIP	Chrome Plate	24	24/96	BOX	14.26

### PUSH-FIT INLET - 1/4-TURN

- Dual-outlet tee



PART #	OUTLET x OUTLET x INLET	FINISH	UNIT ORDER	INNER/ MASTER	PACK	LIST
10777LF	1/2" Push-Fit x 1/2" Push-Fit x 1/4" OD	Chrome Plate	24	24/96	BOX	18.22
10778LF	1/2" Push-Fit x 1/2" Push-Fit x 3/8" OD	Chrome Plate	24	24/96	BOX	18.22

### PUSH-FIT INLET - 1/4-TURN

- Dual-outlet tee



PART #	OUTLET x OUTLET x INLET	FINISH	UNIT ORDER	INNER/ MASTER	PACK	LIST
10779LF	1/2" Push-Fit x 1/2" Push-Fit x 1/4" Push-Fit	Chrome Plate	24	24/96	BOX	18.22

### F1807 PEX INLET - 1/4-TURN

- Dual-outlet tee
- For use with PEX Tubing - Crimp F1807



PART #	OUTLET x OUTLET x INLET	FINISH	UNIT ORDER	INNER/ MASTER	PACK	LIST
10780LF	1/2" PEX x 1/2" PEX x 1/4" OD	Chrome Plate	24	24/96	BOX	10.06



Supply Connectors

Stop Valves

Water Heater

Gas Connectors

Water Filtration

Sinks/ Faucets

Tubular/ Drainage

Faucet Repair

Bath Accessories

Pipe Fittings/ Repair

Valves

Cements/ Sealants

Tools/ Safety

Toilet Repair

Appliance/ HVAC

Hardware

Electrical

Index

# STOP VALVES

## 1/4-Turn Loose Key Stop Valves

### COMPRESSION INLET - 1/4-TURN

- Angle stop
- With loose key handle

**NEW**



PART #	OUTLET x INLET	FINISH	UNIT ORDER	INNER/ MASTER	PACK	LIST
10722LF	3/8" OD x 5/8" OD (1/2" Nom.)	Chrome Plate	24	24/96	BOX	14.03

## Replacement Parts

### ADD-AN-OUTLET ADAPTER

- Screws on existing straight or angle supply stop and converts it to a dual-outlet
- Brass construction



PART #	INLET x OUTLET x OUTLET	UNIT ORDER	INNER/ MASTER	PACK	LIST
25881LF	3/8" OD x 3/8" OD x 1/4" OD	12	12/48	CLAM	8.95
25882LF	3/8" OD x 3/8" OD x 3/8" OD	12	12/48	CLAM	8.95

### VALVE HANDLE

- Replacement handle - EASTMAN® SPEEDFLEX® logo
- Chrome



PART #	DESCRIPTION	FINISH	UNIT ORDER	INNER/ MASTER	PACK	LIST
04493	Oval	Chrome Plate	20	20/500	BAG	1.60

### LOOSE KEY HANDLE

- 1/4" Hex-square
- Chrome



PART #	DESCRIPTION	FINISH	UNIT ORDER	INNER/ MASTER	PACK	LIST
04494	Loose Key Replacement	Chrome Plate	1	20/200	BAG	1.97

### HANDLE SCREW

- Chrome
- For stop valve handles



PART #	DESCRIPTION	FINISH	UNIT ORDER	INNER/ MASTER	PACK	LIST
*48011	Handle Screw	Chrome Plate	20	20/5000	BULK	0.29

\*While Supplies Last

## Fittings

### COMPRESSION CAP

- Chrome



PART #	DESCRIPTION	UNIT ORDER	INN/MAS	PACK	LIST
25849LF	3/8" OD	5	5/50	BULK	1.00

### COMPRESSION NUT

- Chrome



PART #	DESCRIPTION	UNIT ORDER	INN/MAS	PACK	LIST
25831LF	3/8" OD	5	5/50	BULK	1.20

### MALE PIPE ADAPTER

- Chrome



PART #	DESCRIPTION	UNIT ORDER	INN/MAS	PACK	LIST
25842LF	1/2" MIP x 3/8" OD	5	5/50	BULK	3.85

### FEMALE PIPE ADAPTER

- Chrome



PART #	DESCRIPTION	UNIT ORDER	INN/MAS	PACK	LIST
25840LF	1/2" FIP x 3/8" OD	5	5/50	BULK	1.97

### COMPRESSION ADAPTER

- Chrome



PART #	DESCRIPTION	UNIT ORDER	INN/MAS	PACK	LIST
95063LF	1/2" Female OD x 3/8" OD	10	10/100	BULK	1.85

### NIPPLE - 1/2" IPS

- 1/2" IPS
- For exposed applications
- Chrome-plated brass



PART #	DESCRIPTION	UNIT ORDER	INN/MAS	PACK	LIST
25863	1-1/2"	10	10/100	BULK	2.54
25864	2"	10	10/100	BULK	3.11
25865	2-1/2"	10	10/100	BULK	4.05
25866	3"	10	10/100	BULK	4.68
25867	3-1/2"	10	10/100	BULK	5.25
25868	4"	10	10/100	BULK	6.02
25870	5"	10	10/100	BULK	8.24
25872	6"	10	10/100	BULK	8.75

## Sure-Grip Flanges

### STEEL PIPE SIZES

- Chrome



PART #	DESCRIPTION	UNIT ORDER	INN/MAS	PACK	LIST
25701	3/8" IPS	25	500/2000	BULK	0.29
25703	1/2" IPS	25	500/2000	BULK	0.26
25705	3/4" IPS	25	500/2000	BULK	0.26
25719	1" IPS - <b>NEW!</b>	25	500/1000	BULK	0.43
25721	1-1/4" IPS - <b>NEW!</b>	25	500/1000	BULK	0.71
25707	1-1/2" IPS	25	500/1000	BULK	0.48
25720	1-1/2" IPS x 3-1/2" OD (Oversized) - <b>NEW!</b>	25	500/1000	BULK	0.74
25709	2" IPS	25	500/1000	BULK	0.71

### COPPER TUBING SIZES

- Chrome



PART #	DESCRIPTION	UNIT ORDER	INN/MAS	PACK	LIST
25711	5/8" OD (1/2" Nom.)	25	500/2000	BULK	0.29
25713	7/8" OD (3/4" Nom.)	25	500/2000	BULK	0.29
25726	1-1/8" OD (1" Nom.)	25	500/1000	BULK	0.40
25715	1-1/4" OD (1-1/8" Nom.)	25	500/1000	BULK	0.41
25727	1-3/8" OD (1-1/4" Nom.)	25	500/1000	BULK	0.43
25717	1-1/2" OD (1-3/8" Nom.)	25	500/1000	BULK	0.48

### STEEL PIPE SIZES

- ABS plastic
- White



PART #	DESCRIPTION	UNIT ORDER	INN/MAS	PACK	LIST
25722	1/2" IPS	25	25/1500	BULK	0.23
25724	3/4" IPS	25	25/1500	BULK	0.26
25708	1-1/2" IPS	25	25/500	BULK	0.48
25710	2" IPS	25	25/500	BULK	0.48

### COPPER TUBING SIZES

- ABS plastic
- White



PART #	DESCRIPTION	UNIT ORDER	INN/MAS	PACK	LIST
25712	5/8" OD (1/2" Nom.)	25	25/1000	BULK	0.23
25714	7/8" OD (3/4" Nom.)	25	25/1000	BULK	0.23

Supply Connectors

Stop Valves

Water Heater

Gas Connectors

Water Filtration

Sinks/ Faucets

Tubular/ Drainage

Faucet Repair

Bath Accessories

Pipe Fittings/ Repair

Valves

Cements/ Sealants

Tools/ Safety

Toilet Repair

Appliance/ HVAC

Hardware

Electrical

Index

# STOP VALVES

## Split Sure-Grip Flanges

### STEEL PIPE SIZES

- Chrome-plated



**NEW**

**EASTMAN®**

PART #	DESCRIPTION	UNIT ORDER	INN/MAS	PACK	LIST
25746	3/8" IPS	12	12/1500	BULK	1.28
25748	1/2" IPS	12	12/1500	BULK	1.25
25750	3/4" IPS	12	12/1440	BULK	1.37
25752	1" IPS	12	12/1440	BULK	1.48
25754	1-1/4" IPS	12	12/1200	BULK	1.94
25756	1-1/2" IPS	12	12/1200	BULK	2.02
25758	2" IPS	12	12/720	BULK	2.28
25759	3" IPS	12	12/480	BULK	3.25

### COPPER TUBING SIZES

- Chrome-plated



**NEW**

**EASTMAN®**

PART #	DESCRIPTION	UNIT ORDER	INN/MAS	PACK	LIST
25768	5/8" OD (1/2" Nom.)	12	12/1500	BULK	1.17
25769	7/8" OD (3/4" Nom.)	12	12/1500	BULK	1.28
25770	1-1/8" OD (1" Nom.)	12	12/1440	BULK	1.37

### STEEL PIPE SIZES

- White



**NEW**

**EASTMAN®**

PART #	DESCRIPTION	UNIT ORDER	INN/MAS	PACK	LIST
25760	3/8" IPS	12	12/1500	BULK	0.46
25762	1/2" IPS	12	12/1500	BULK	0.40
25764	1-1/2" IPS	12	12/1200	BULK	0.63
25765	2" IPS	12	12/720	BULK	0.97
25767	3" IPS	12	12/1440	BULK	1.23

### COPPER TUBING SIZES

- White



**NEW**

**EASTMAN®**

PART #	DESCRIPTION	UNIT ORDER	INN/MAS	PACK	LIST
25771	5/8" OD (1/2" Nom.)	12	12/1500	BULK	0.46

## Deep Bell Flanges

### STEEL PIPE SIZES

- Chrome-plated



**EASTMAN®**

PART #	DESCRIPTION	UNIT ORDER	INN/MAS	PACK	LIST
25761	3/8" IPS	25	25/500	BULK	0.80
25763	1/2" IPS	25	25/500	BULK	0.80

### COPPER TUBING SIZES

- Chrome-plated



**EASTMAN®**

PART #	DESCRIPTION	UNIT ORDER	INN/MAS	PACK	LIST
25777	5/8" OD (1/2" Nom.)	25	25/500	BULK	0.80

## Steel Box Flanges

### BOX FLANGE

- Chrome-plated



**EASTMAN®**

PART #	DESCRIPTION	UNIT ORDER	INN/MAS	PACK	LIST
25728	1-1/4" IPS	5	100/200	BULK	1.45
25811	1-1/2" IPS	5	100/200	BULK	1.45
25813	1-1/4" OD (1-1/8" Nom.)	5	100/200	BULK	1.45
25815	1-1/2" OD (1-3/8" Nom.)	5	100/200	BULK	1.45

## Floor & Ceiling Plates

### STEEL PIPE SIZES

- Chrome-plated



**EASTMAN.**

PART #	DESCRIPTION	UNIT ORDER	INN/MAS	PACK	LIST
25741	3/8" IPS	12	10/500	BULK	<b>0.75</b>
25743	1/2" IPS	12	12/720	BULK	<b>0.86</b>
25745	3/4" IPS	12	12/720	BULK	<b>0.86</b>
25747	1" IPS	12	12/500	BULK	<b>1.00</b>
25749	1-1/4" IPS	12	12/500	BULK	<b>1.00</b>
25751	1-1/2" IPS	12	12/576	BULK	<b>1.05</b>
25753	2" IPS	12	12/576	BULK	<b>1.31</b>

### HEAVY-DUTY COPPER TUBING SIZES

**NEW**

- Chrome-plated steel



**EASTMAN.**

PART #	DESCRIPTION	UNIT ORDER	INN/MAS	PACK	LIST
25738	5/8" OD (1/2" Nom.)	12	12/480	BULK	<b>3.05</b>
25739	7/8" OD (3/4" Nom.)	12	12/480	BULK	<b>3.05</b>
25740	1-1/8" OD (1" Nom.)	12	12/240	BULK	<b>3.11</b>
25742	1-5/8" OD (1-1/2" Nom.)	12	12/240	BULK	<b>3.34</b>
25744	2-1/8" OD (2" Nom.)	12	12/240	BULK	<b>3.51</b>

### COPPER TUBING SIZES

- Chrome-plated



**EASTMAN.**

PART #	DESCRIPTION	UNIT ORDER	INN/MAS	PACK	LIST
25755	5/8" OD (1/2" Nom.)	12	12/720	BULK	<b>0.86</b>
25757	7/8" OD (3/4" Nom.)	12	12/720	BULK	<b>0.88</b>

### HEAVY-DUTY STEEL PIPE SIZES

**NEW**

- Chrome-plated steel



**EASTMAN.**

PART #	DESCRIPTION	UNIT ORDER	INN/MAS	PACK	LIST
25732	1/2" IPS	12	12/360	BULK	<b>3.02</b>
25733	3/4" IPS	12	12/360	BULK	<b>3.08</b>
25734	1" IPS	12	12/480	BULK	<b>3.16</b>
25735	1-1/4" IPS	12	12/240	BULK	<b>3.28</b>
25736	1-1/2" IPS	12	12/240	BULK	<b>3.39</b>
25737	2" IPS	12	12/240	BULK	<b>3.56</b>

# VISIT US ONLINE!

[www.EZ-FLO.net](http://www.EZ-FLO.net)

Supply  
Connectors

Stop  
Valves

Water  
Heater

Gas  
Connectors

Water  
Filtration

Sinks/  
Faucets

Tubular/  
Drainage

Faucet  
Repair

Bath  
Accessories

Pipe Fittings/  
Repair

Valves

Cements/  
Sealants

Tools/  
Safety

Toilet  
Repair

Appliance/  
HVAC

Hardware

Electrical

Index

# OUTLET BOXES

FOR WASHING MACHINES, DRYERS AND ICEMAKERS

- One-piece design for easy install
- 1/4-Turn ball valves
- Hammer arresters included on some items



## VALVE CONNECTION TYPES



## Icemaker Outlet Boxes

### ICEMAKER OUTLET BOX

- 1/4-Turn ball valve installed
- 1/4" OD compression outlet



PART #	DESCRIPTION	UNIT ORDER	INN/MAS	PACK	LIST
60232	1/2" Sweat Connection	1	-/10	BOX	25.86
60234	1/2" CPVC Connection	1	-/10	BOX	26.89
60233	1/2" Crimp PEX (F1807) Connection	1	-/10	BOX	27.13
60262	1/2" Expansion PEX (F1960) Connection	1	-/10	BOX	28.33
60266	1/2" Push-Fit Connection - <b>NEW!</b>	1	-/10	BOX	38.78

### ICEMAKER OUTLET BOX WITH HAMMER ARRESTERS

- 1/4-Turn ball valve with hammer arrester installed
- 1/4" OD compression outlet



PART #	DESCRIPTION	UNIT ORDER	INN/MAS	PACK	LIST
60241	1/2" Sweat Connection	1	-/10	BULK	45.94
60240	1/2" CPVC Connection	1	-/10	BULK	44.09
60242	1/2" Crimp PEX (F1807) Connection - <b>NEW!</b>	1	-/10	BULK	45.94
60258	1/2" Expansion PEX (F1960) Connection - <b>NEW!</b>	1	-/10	BULK	52.45

## ROUND MINI ICEMAKER OUTLET BOX

- Preloaded nails provide strong rigid mount
- No support bracket needed
- Nails are reversible and box can be mounted to left or right stud bay
- Trim ring accommodates up to 1" sheet rock
- 1/4" OD compression outlet



PART #	DESCRIPTION	UNIT ORDER	INN/MAS	PACK	LIST
60237	1/2" Sweat Connection	1	-/10	BULK	25.17
60239	1/2" CPVC Connection	1	-/10	BULK	25.99
60238	1/2" Crimp PEX (F1807) Connection	1	-/10	BULK	26.35
60263	1/2" Expansion PEX (F1960) Connection	1	-/10	BULK	26.13

## Washing Machine Outlet Boxes

### WASHING MACHINE OUTLET BOX

- Heavy-duty plastic
- 2" Drain coupling with knock-out test cap molded
- Less valve



PART #	DESCRIPTION	UNIT ORDER	INN/MAS	PACK	LIST
60256	Center Drain	1	-/10	BULK	9.85

## Washing Machine Outlet Boxes

### DUAL-DRAIN WASHING MACHINE OUTLET BOX WITH SINGLE-LEVER VALVE

- 1/4-Turn ball valve installed
- 3/4" MHT outlet
- Dual drain

**NEW**



**EASTMAN**

PART #	DESCRIPTION	UNIT ORDER	INN/MAS	PACK	LIST
60267	1/2" Sweat Connection	1	-/10	BOX	55.60

### DUAL-DRAIN WASHING MACHINE OUTLET BOX

- 1/4-Turn ball valves installed
- 3/4" MHT outlet
- Right or left side drain



**EASTMAN**

PART #	DESCRIPTION	UNIT ORDER	INN/MAS	PACK	LIST
60243	1/2" Sweat Connection	1	-/10	BOX	36.71
60244	1/2" CPVC Connection	1	-/10	BOX	37.42
60245	1/2" Crimp PEX (F1807) Connection	1	-/10	BOX	39.06
60261	1/2" Expansion PEX (F1960) Connection	1	-/10	BOX	39.84
60265	1/2" Push-Fit Connection - <b>NEW!</b>	1	-/10	BOX	50.21

### CENTER DRAIN WASHING MACHINE OUTLET BOX

- 1/4-Turn ball valves installed
- 3/4" MHT outlet
- Center drain



**EASTMAN**

PART #	DESCRIPTION	UNIT ORDER	INN/MAS	PACK	LIST
60248	1/2" Sweat Connection	1	-/10	BOX	32.60
60249	1/2" CPVC Connection	1	-/10	BOX	32.60
60250	1/2" Crimp PEX (F1807) Connection	1	-/10	BOX	35.00
60260	1/2" Expansion PEX (F1960) Connection	1	-/10	BOX	35.95
60264	1/2" Push-Fit Connection - <b>NEW!</b>	1	-/10	BOX	53.26

### CENTER DRAIN WASHER OUTLET BOX WITH HAMMER ARRESTERS

- 1/4-Turn ball valves with hammer arresters installed
- 3/4" MHT outlet



**EASTMAN**

PART #	DESCRIPTION	UNIT ORDER	INN/MAS	PACK	LIST
60253	1/2" Sweat Connection	1	-/10	BULK	73.29
60246	1/2" CPVC Connection	1	-/10	BULK	72.26
60247	1/2" Crimp PEX (F1807) Connection	1	-/10	BULK	74.95
60254	1/2" Expansion PEX (F1960) Connection	1	-/10	BULK	75.80

### WASHING MACHINE OUTLET BOX WITH HAMMER ARRESTERS

- 1/4-Turn ball valves with hammer arresters installed
- 3/4" MHT outlet
- Dual drain



**EASTMAN**

PART #	DESCRIPTION	UNIT ORDER	INN/MAS	PACK	LIST
60252	1/2" Sweat Connection	1	-/10	BULK	74.71
60227	1/2" CPVC Connection - <b>NEW!</b>	1	-/10	BULK	74.03
60230	1/2" Crimp PEX (F1807) Connection - <b>NEW!</b>	1	-/10	BULK	75.55
60231	1/2" Expansion PEX (F1960) Connection - <b>NEW!</b>	1	-/10	BULK	77.13

## Dryer Outlet Boxes

### STEAM DRYER OUTLET BOX

**NEW**

- 1/4-Turn ball valve installed
- 3/4" FHT outlet



**EASTMAN**

PART #	DESCRIPTION	UNIT ORDER	INN/MAS	PACK	LIST
60270	1/2" Sweat Connection	1	-/10	BOX	23.46

## Trim Plates

### OUTLET BOX TRIM PLATE

**NEW**

- Fits Eastman® square icemaker and washing machine outlet boxes



**EASTMAN**

PART #	DESCRIPTION	UNIT ORDER	INN/MAS	PACK	LIST
60220	Washing Machine	1	-/28	BULK	4.49
60222	Icemaker	1	-/36	BULK	3.95

Supply Connectors

Stop Valves

Water Heater

Gas Connectors

Water Filtration

Sinks/Faucets

Tubular/Drainage

Faucet Repair

Bath Accessories

Pipe Fittings/Repair

Valves

Cements/Sealants

Tools/Safety

Toilet Repair

Appliance/HVAC

Hardware

Electrical

Index

# STOP VALVES

## Hose Thread Outlet Washing Machine Stops

### MALE IRON PIPE OR SWEAT INLET - 1/4-TURN

- Brass ball mechanism
- Teflon seats
- Forged brass body
- 3/4" MHT x 1/2" MIP or sweat



PART #	DESCRIPTION	UNIT ORDER	INN/MAS	PACK	LIST
10758	Hot (Red Handle)	24	24/96	BOX	16.31
10759	Cold (Blue Handle)	24	24/96	BOX	16.31

## Hammer Arresters

### WATER HAMMER ARRESTER 1/2" MIP

- AA mini size
- Can be installed any direction on both hot and cold lines
- Working temperature range: 33° F to 180° F
- Max working pressure: 250 PSI
- Burst pressure: 2900 PSI



PART #	DESCRIPTION	UNIT ORDER	INN/MAS	PACK	LIST
60840	1/2" MIP	12	12/72	BOX	15.65

### WATER HAMMER ARRESTER 1/2" CPVC

- AA mini size
- Can be installed any direction on both hot and cold lines
- Working temperature range: 33° F to 180° F
- Max working pressure: 250 PSI
- Burst pressure: 2900 PSI



PART #	DESCRIPTION	UNIT ORDER	INN/MAS	PACK	LIST
60842	1/2" CPVC	12	12/72	BOX	15.65

### WATER HAMMER ARRESTER 1/2" MALE SWEAT

- AA mini size
- Can be installed any direction on both hot and cold lines
- Working temperature range: 33° F to 180° F
- Max working pressure: 250 PSI
- Burst pressure: 2900 PSI



PART #	DESCRIPTION	UNIT ORDER	INN/MAS	PACK	LIST
60844	1/2" Male Sweat	12	12/72	BOX	14.59

### WATER HAMMER ARRESTER 1/2" PEX

- AA mini size
- Can be installed any direction on both hot and cold lines
- Working temperature range: 33° F to 180° F
- Max working pressure: 250 PSI
- Burst pressure: 2900 PSI



PART #	DESCRIPTION	UNIT ORDER	INN/MAS	PACK	LIST
60846	1/2" Crimp PEX (F1807)	12	12/72	BOX	15.65
60848	1/2" Expansion PEX (F1960)	12	12/72	BOX	17.36

### WATER HAMMER ARRESTER 1/2" PEX TEE

- AA mini size
- Can be installed any direction on both hot and cold lines
- Working temperature range: 33° F to 180° F
- Max working pressure: 250 PSI
- Burst pressure: 2900 PSI



PART #	DESCRIPTION	UNIT ORDER	INN/MAS	PACK	LIST
60850	1/2" Crimp PEX (F1807)	12	12/72	BOX	19.31
60852	1/2" Expansion PEX (F1960)	12	12/72	BOX	20.64

### WATER HAMMER ARRESTER 3/4" MHT x 3/4" FEMALE SWIVEL TEE

- AA mini size
- Can be installed any direction on both hot and cold lines
- Working temperature range: 33° F to 180° F
- Max working pressure: 250 PSI
- Burst pressure: 2900 PSI



PART #	DESCRIPTION	UNIT ORDER	INN/MAS	PACK	LIST
60858	3/4" MHT x 3/4" Female Swivel	12	12/48	BOX	20.68



# CORRUGATED COPPER WATER HEATER CONNECTOR

**EASTMAN**<sup>®</sup>  
**WATER-FLEX**<sup>®</sup>



Supply  
Connectors

Stop  
Valves

Water  
Heater

Gas  
Connectors

Water  
Filtration

Sinks/  
Faucets

Tubular/  
Drainage

Faucet  
Repair

Bath  
Accessories

Pipe Fittings/  
Repair

Valves

Cements/  
Sealants

Tools/  
Safety

Toilet  
Repair

Appliance/  
HVAC

Hardware

Electrical

Index

## WATER-FLEX<sup>®</sup> Corrugated Copper

### NUT X NUT

- Brass nuts
- External dielectric sleeve
- Nitrile rubber sealing washer



PART #	OUTLET x INLET x LENGTH	UNIT ORDER	INN/MAS	PACK	LIST
0437712	3/4" FIP x 3/4" FIP x 12"	25	-/25	BULK	<b>11.95</b>
0437715	3/4" FIP x 3/4" FIP x 15"	25	-/25	BULK	<b>13.91</b>
0437718	3/4" FIP x 3/4" FIP x 18"	25	-/25	BULK	<b>14.97</b>
0437724	3/4" FIP x 3/4" FIP x 24"	25	-/25	BULK	<b>18.48</b>
0437730	3/4" FIP x 3/4" FIP x 30"	25	-/25	BULK	<b>23.44</b>
0437736	3/4" FIP x 3/4" FIP x 36"	25	-/25	BULK	<b>26.77</b>

### NUT X MALE SWEAT END

- Brass nut
- External dielectric sleeve
- Nitrile rubber sealing washer



PART #	OUTLET x INLET x LENGTH	UNIT ORDER	INN/MAS	PACK	LIST
0438118	3/4" FIP x 3/4" M Sweat x 18"	25	-/25	BULK	<b>15.31</b>
0438124	3/4" FIP x 3/4" M Sweat x 24"	25	-/25	BULK	<b>17.51</b>

### NUT X FEMALE SWEAT END

- Brass nut
- External dielectric sleeve
- Nitrile rubber sealing washer



PART #	OUTLET x INLET x LENGTH	UNIT ORDER	INN/MAS	PACK	LIST
0436912	3/4" FIP x 3/4" F Sweat x 12"	25	-/25	BULK	<b>11.69</b>
0436915	3/4" FIP x 3/4" F Sweat x 15"	25	-/25	BULK	<b>12.40</b>
0436918	3/4" FIP x 3/4" F Sweat x 18"	25	-/25	BULK	<b>14.17</b>
0436924	3/4" FIP x 3/4" F Sweat x 24"	25	-/25	BULK	<b>17.05</b>

### NUT X SWIVEL MALE

- Brass nuts
- External dielectric sleeve
- Nitrile rubber sealing washer



PART #	OUTLET x INLET x LENGTH	UNIT ORDER	INN/MAS	PACK	LIST
0449715	3/4" FIP x 3/4" MIP x 15"	25	-/25	BULK	<b>17.34</b>
0449718	3/4" FIP x 3/4" MIP x 18"	25	-/25	BULK	<b>18.45</b>
0449724	3/4" FIP x 3/4" MIP x 24"	25	-/25	BULK	<b>21.70</b>

# WATER HEATER CONNECTORS

## WATER-FLEX® Corrugated Copper

### NUT X PEX

- For SDR9 PEX tubing
- Brass nut
- External dielectric sleeve
- Nitrile rubber sealing washer



PART #	OUTLET x INLET x LENGTH	UNIT ORDER	INN/MAS	PACK	LIST
0436312	3/4" FIP x 3/4" PEX x 12"	25	-/25	BULK	12.60
0436315	3/4" FIP x 3/4" PEX x 15"	25	-/25	BULK	14.66
0436318	3/4" FIP x 3/4" PEX x 18"	25	-/25	BULK	15.62
0436324	3/4" FIP x 3/4" PEX x 24"	25	-/25	BULK	19.22

### MIP X PEX

- For SDR9 PEX tubing
- Brass nut
- External dielectric sleeve
- Nitrile rubber sealing washer



PART #	OUTLET x INLET x LENGTH	UNIT ORDER	INN/MAS	PACK	LIST
0436118	3/4" MIP x 3/4" PEX x 18"	25	-/25	BULK	18.53
0436124	3/4" MIP x 3/4" PEX x 24"	25	-/25	BULK	22.35

## WATER-FLEX® Corrugated Stainless Steel

### TANKLESS GAS WATER HEATER INSTALLATION KIT

**NEW**

- Includes 3/4" FNPT union x 3/4" FIP tankless water heater isolation/service valves
- Includes one 150 PSI pressure relief valve
- Includes two 3/4" FIP x 3/4" FIP x 18" length stainless steel corrugated water heater connectors
- Includes one 1" OD 3/4" MIP x 3/4" FIP x 24" length epoxy-coated stainless steel gas connector
- Includes one 3/4" FIP brass water ball valve



PART #	DESCRIPTION	UNIT ORDER	INN/MAS	PACK	LIST
60210	Tankless Gas Water Heater Installation Kit - FIP	1	-/2	BOX	206.57

### TANKLESS GAS WATER HEATER INSTALLATION KIT

**NEW**

- Includes 3/4" FNPT union x 3/4" sweat tankless water heater isolation/service valves
- Includes one 150 PSI pressure relief valve
- Includes two 3/4" FIP x 3/4" sweat 18" length stainless steel corrugated water heater connectors
- Includes one 1" OD 3/4" MIP x 3/4" FIP x 24" length epoxy-coated stainless steel gas connector
- Includes one 3/4" FIP brass water ball valve



PART #	DESCRIPTION	UNIT ORDER	INN/MAS	PACK	LIST
60212	Tankless Gas Water Heater Installation Kit - Sweat	1	-/2	BOX	206.57

### GAS WATER HEATER INSTALLATION KIT

- Includes (2) flexible water supply connectors, (2) compression adapters, (1) roll of sealing tape
- 18" Water connectors are durable corrugated stainless steel
- 24" Gas supply is long-lasting, corrosive-resistant, flexible corrugated stainless steel
- Included lead-free brass adapters allow solder-free connection to copper pipe
- Kit includes everything to connect gas and water supplies to a new or existing gas water heater



PART #	DESCRIPTION	UNIT ORDER	INN/MAS	PACK	LIST
48280	Gas Water Heater Installation Kit	1	-/6	CLAM	51.17

### ELECTRIC WATER HEATER INSTALLATION KIT

- Includes (2) 18" flexible water supply connectors, (2) compression adapters, (1) roll of sealing tape
- 18" Water connectors are durable corrugated stainless steel
- Included lead-free brass adapters allow solder-free connection to copper pipe
- Kit includes everything to connect water supply to a new or existing electric water heater



PART #	DESCRIPTION	UNIT ORDER	INN/MAS	PACK	LIST
48281	Electric Water Heater Installation Kit	1	-/6	CLAM	35.72

# WATER HEATER CONNECTORS

## WATER-FLEX® Corrugated Stainless Steel

### STAINLESS STEEL CORRUGATED WATER HEATER CONNECTORS - 3/4" FIP X 3/4" FIP

- Corrugated stainless steel
- Nickel-plated brass nuts
- Nitrile rubber sealing washer



PART #	DESCRIPTION	UNIT ORDER	INN/MAS	PACK	LIST
0437012	12"	1	-/25	BULK	8.70
0437015	15"	1	-/25	BULK	6.61
0437018	18"	1	-/25	BULK	8.74
0437024	24"	1	-/25	BULK	10.24

### STAINLESS STEEL CORRUGATED WATER HEATER CONNECTORS - 3/4" FIP X 3/4" F1807 PEX

**NEW**

- Corrugated stainless steel
- Nickel-plated brass nut
- Nitrile rubber sealing washer



PART #	DESCRIPTION	UNIT ORDER	INN/MAS	PACK	LIST
0438612	12"	1	-/25	BULK	9.84
0438618	18"	1	-/25	BULK	10.46
0438624	24"	1	-/25	BULK	12.66

### STAINLESS STEEL CORRUGATED WATER HEATER CONNECTORS - 3/4" FIP X 3/4" F1960 PEX

- Corrugated stainless steel
- Nickel-plated brass nut
- Nitrile rubber sealing washer



PART #	DESCRIPTION	UNIT ORDER	INN/MAS	PACK	LIST
0438318	18"	1	-/25	BULK	10.98
0438324	24"	1	-/25	BULK	13.17

### STAINLESS STEEL CORRUGATED WATER HEATER CONNECTORS - 3/4" FIP X 3/4" PUSH-FIT

- Corrugated stainless steel
- Nickel-plated brass nut
- 3/4" Push-fit designed for use with copper, CPVC, or PEX pipe - no soldering required



PART #	DESCRIPTION	UNIT ORDER	INN/MAS	PACK	LIST
0437218	18"	1	-/25	BULK	18.53
0437224	24"	1	-/25	BULK	20.39

### STAINLESS STEEL CORRUGATED WATER HEATER CONNECTORS - 3/4" FIP X 3/4" FEMALE SWEAT

- Corrugated stainless steel
- Nickel-plated brass nut
- High-quality EPDM gasket



PART #	DESCRIPTION	UNIT ORDER	INN/MAS	PACK	LIST
0437412	12"	1	-/25	BULK	10.95
0437415	15"	1	-/25	BULK	11.63
0437418	18"	1	-/25	BULK	12.23
0437424	24"	1	-/25	BULK	14.11

### STAINLESS STEEL CORRUGATED WATER HEATER CONNECTORS - 3/4" FIP X 1" FIP

- Corrugated stainless steel
- Nickel-plated brass nuts
- High-quality EPDM gasket



PART #	DESCRIPTION	UNIT ORDER	INN/MAS	PACK	LIST
0437512	12"	1	-/25	BULK	10.98
0437515	15"	1	-/25	BULK	11.98
0437518	18"	1	-/25	BULK	12.52
0437524	24"	1	-/25	BULK	15.25

Supply Connectors

Stop Valves

Water Heater

Gas Connectors

Water Filtration

Sinks/Faucets

Tubular/Drainage

Faucet Repair

Bath Accessories

Pipe Fittings/Repair

Valves

Cements/Sealants

Tools/Safety

Toilet Repair

Appliance/HVAC

Hardware

Electrical

Index

# WATER HEATER CONNECTORS

## WATER-FLEX® Corrugated Stainless Steel

### STAINLESS STEEL CORRUGATED WATER HEATER CONNECTORS - 1" FIP X 1" FIP

- Corrugated stainless steel
- Nickel-plated brass nuts
- High-quality EPDM gasket



PART #	DESCRIPTION	UNIT ORDER	INN/MAS	PACK	LIST
0447512	12"	1	-/25	BULK	12.06
0447515	15"	1	-/25	BULK	13.17
0447518	18"	1	-/25	BULK	13.83
0447524	24"	1	-/25	BULK	16.77

**NEW**

### STAINLESS STEEL CORRUGATED WATER HEATER CONNECTORS - 2" FIP X 2" FIP

- Corrugated stainless steel
- Nickel-plated brass nuts
- High-quality EPDM gasket



PART #	DESCRIPTION	UNIT ORDER	INN/MAS	PACK	LIST
0432318	18"	1	-/6	BULK	35.50
0432324	24"	1	-/6	BULK	37.75

### STAINLESS STEEL CORRUGATED WATER HEATER CONNECTORS - 1-1/4" FIP X 1-1/4" FIP

- Corrugated stainless steel
- Nickel-plated brass nuts
- High-quality EPDM gasket



PART #	DESCRIPTION	UNIT ORDER	INN/MAS	PACK	LIST
0432118	18"	1	-/12	BULK	18.45
0432124	24"	1	-/12	BULK	19.64

**NEW**

### STAINLESS STEEL CORRUGATED WATER HEATER CONNECTORS - 3/4" FIP X 3/4" FIP - 1 PAIR

- Corrugated stainless steel with epoxy coating
- 1 Blue and 1 red connector for easy installation
- Nickel-plated brass nuts
- Priced per pair



PART #	DESCRIPTION	UNIT ORDER	INN/MAS	PACK	LIST
0437118	18" - Pair Red & Blue	1	-/12	BAG	25.23
0437124	24" - Pair Red & Blue	1	-/12	BAG	30.94

### STAINLESS STEEL CORRUGATED WATER HEATER CONNECTORS - 1-1/2" FIP X 1-1/2" FIP

- Corrugated stainless steel
- Nickel-plated brass nuts
- High-quality EPDM gasket



PART #	DESCRIPTION	UNIT ORDER	INN/MAS	PACK	LIST
0432218	18"	1	-/8	BULK	23.07
0432224	24"	1	-/8	BULK	24.55

**NEW**

### STAINLESS STEEL CORRUGATED WATER HEATER CONNECTORS

- Corrugated stainless steel
- Nickel-plated brass nut
- 3/4" FIP x 3/4" push-fit designed for use with copper, CPVC, or PEX pipe - no soldering required
- 1 Blue and 1 red connector for easy installation
- Priced per pair



PART #	DESCRIPTION	UNIT ORDER	INN/MAS	PACK	LIST
0437318	18" - Pair Red & Blue	1	-/12	BAG	41.34
0437324	24" - Pair Red & Blue	1	-/12	BAG	45.19

# WATER HEATER CONNECTORS

## STEEL-FLEX® Flexible Stainless Steel

### FLEXIBLE WATER HEATER CONNECTOR 3/4" FIP X 1/2" PUSH-FIT BALL VALVE

- Stainless steel braided rubber
- Nickel-plated brass nut
- 1/2" Push-fit ball valve designed for use and PEX pipe - no soldering, with copper, CPVC glue or clamps required



PART #	DESCRIPTION	UNIT ORDER	INN/MAS	PACK	LIST
48234	18"	1	12/48	BULK	26.37

### FLEXIBLE WATER HEATER CONNECTOR 3/4" FIP X 3/4" PUSH-FIT BALL VALVE

- Stainless steel braided rubber
- Nickel-plated brass nut
- 3/4" Push-fit ball valve designed for use with copper, CPVC and PEX pipe - no soldering, glue or clamps required



PART #	DESCRIPTION	UNIT ORDER	INN/MAS	PACK	LIST
48232	18"	1	12/48	BULK	36.35
48233	24"	1	12/48	BULK	38.49

### 3/4" FIP SWIVEL X 3/4" FIP SWIVEL

- Nickel-plated brass nuts
- Stainless steel ferrules



PART #	DESCRIPTION	UNIT ORDER	INN/MAS	PACK	LIST
48250	12"	10	10/50	BULK	11.09
48262	15"	10	10/50	BULK	12.15
48251	18"	10	10/50	BULK	13.12
48252	24"	10	10/50	BULK	13.80

### 3/4" FIP SWIVEL X 3/4" MIP RIGID

- Nickel-plated brass nuts
- Stainless steel ferrules



PART #	DESCRIPTION	UNIT ORDER	INN/MAS	PACK	LIST
48573	12"	10	10/50	BULK	12.37
48254	18"	10	10/50	BULK	12.60
48255	24"	10	10/50	BULK	15.94

### 3/4" COMPRESSION X 3/4" FIP SWIVEL

- Nickel-plated brass nuts
- Stainless steel ferrules



PART #	DESCRIPTION	UNIT ORDER	INN/MAS	PACK	LIST
48264	15"	10	10/50	BULK	13.69
48257	18"	10	10/50	BULK	13.97
48258	24"	10	10/50	BULK	15.23

### 3/4" COMPRESSION X 3/4" MIP RIGID

- Nickel-plated brass nuts
- Stainless steel ferrules



PART #	DESCRIPTION	UNIT ORDER	INN/MAS	PACK	LIST
48259	12"	10	10/50	BULK	12.86
48260	18"	10	10/50	BULK	14.20
48261	24"	10	10/50	BULK	15.54

### 3/4" FIP X 3/4" PUSH-FIT

- Nickel-plated brass nut
- Stainless steel ferrules



PART #	DESCRIPTION	UNIT ORDER	INN/MAS	PACK	LIST
48230	18"	10	10/50	BULK	18.53
48231	24"	10	10/50	BULK	20.67

Supply Connectors

Stop Valves

Water Heater

Gas Connectors

Water Filtration

Sinks/Faucets

Tubular/Drainage

Faucet Repair

Bath Accessories

Pipe Fittings/Repair

Valves

Cements/Sealants

Tools/Safety

Toilet Repair

Appliance/HVAC

Hardware

Electrical

Index

# WATER HEATER PARTS

## Water Heater Parts

### ELECTRICAL CONTINUITY TESTER

- Designed for use on electric water heaters
- Tests for continuity in non-energized circuits
- Requires 2 AA batteries (included)



**EASTMAN®**

PART #	DESCRIPTION	UNIT ORDER	INN/MAS	PACK	LIST
60039	Electrical Tester for Electric Water Heaters	1	24/144	CARD	4.25

### WATER HEATER ELEMENT - HIGH-WATT DENSITY

- Copper sheath-finned
- Screw mount with gasket

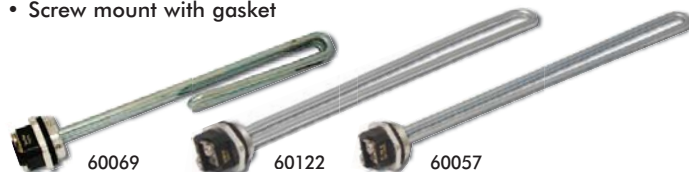

**EASTMAN®**

PART #	DESCRIPTION	UNIT ORDER	INN/MAS	PACK	LIST
60047	120V x 1440W Straight	1	6/48	BAG	8.81
60061	120V x 1500W Straight	1	6/48	BAG	11.55
60124N	120V x 2000W Straight	1	6/48	BAG	9.01
60054	240V x 1500W Straight	1	6/48	BAG	12.15
60125N	240V x 2500W Straight	1	6/48	BAG	11.12
60056	240V x 3000W Straight	1	6/48	BAG	10.06
60122N	240V x 3500W Straight	1	6/48	BAG	10.75
60052	240V x 3800W Straight	1	6/48	BAG	10.98
60057N	240V x 4500W Straight	1	6/48	BAG	11.95
60068	240V x 5500W Straight	1	6/48	BAG	12.89
60069	240V x 5500W Fold Back	1	6/48	BAG	13.34

### WATER HEATER ELEMENT - HIGH-WATT DENSITY WITH UNIVERSAL FLANGE

- Copper sheath-finned
- Universal flange mount with gasket



**EASTMAN®**

PART #	DESCRIPTION	UNIT ORDER	INN/MAS	PACK	LIST
60060	120V x 1500W Straight	1	-/10	BAG	10.12
60053	240V x 3000W Straight	1	-/10	BAG	10.95
60058	240V x 4500W Straight	1	-/10	BAG	12.37
60059	240V x 5500W Fold Back	1	-/10	BAG	13.77

### WATER HEATER ELEMENT - LOW-WATT DENSITY

- Copper sheath-finned
- Screw mount with gasket



**EASTMAN®**

PART #	DESCRIPTION	UNIT ORDER	INN/MAS	PACK	LIST
60048	120V x 1650W Fold Back	1	-/10	BAG	12.20
60065	240V x 4500W Fold Back	1	-/10	BAG	12.57

### WATER HEATER ELEMENT - ULTRA LOW-WATT DENSITY

- Incoloy nickel based sheath
- Screw mount with gasket



**EASTMAN®**

PART #	DESCRIPTION	UNIT ORDER	INN/MAS	PACK	LIST
60128	240V x 4500W Fold Back	1	-/10	BAG	22.65
60126	240V x 5500W Fold Back	1	-/10	BAG	24.15

### WATER HEATER ELEMENT ADAPTER KIT

- Adapts flat, universal or round flange element with a standard screw-in element
- Includes (1) screw-in element gasket, (1) four-hole element gasket, (4) 5/16"-18 x 5/8" long hex-flange-head bolts, (1) 2-1/2" four-bolt adapt-a-flange and (1) thermostat bracket



**EASTMAN®**

PART #	DESCRIPTION	UNIT ORDER	INN/MAS	PACK	LIST
60049	Water Heater Element Adapter Kit	1	12/48	BLISTER	8.98

### UNIVERSAL WATER HEATER ELEMENT GASKET KIT

- Includes (1) flange element gasket, (1) four-hole element gasket and (1) screw-in element gasket



**EASTMAN®**

PART #	DESCRIPTION	UNIT ORDER	INN/MAS	PACK	LIST
60050	Water Heater Element Gasket Kit	1	12/48	BLISTER	3.85

### REPLACEMENT WATER HEATER CONNECTOR WASHER

- Use with 3/4" FIP connection only



**EASTMAN®**

PART #	DESCRIPTION	UNIT ORDER	INN/MAS	PACK	LIST
60228	Black Rubber Washer - 4 Pack	1	10/100	BAG	1.25
60229N	Black Rubber Washer - 50 Pack	1	10/100	BAG	14.88

## Water Heater Parts

### APCOM THERMOSTAT

- With high-limit control
- Built-in safety switch to help prevent water heater from overheating
- Includes terminal protector
- Adjustable temperature range: 110° F to 160° F



60075                      60071                      60073                     

PART #	DESCRIPTION	UNIT ORDER	INN/MAS	PACK	LIST
60071	Single-Element Water Heater Thermostat	1	1/40	BULK	<b>29.65</b>
60073	Single-Throw 120V/240V Lower Thermostat	1	1/40	BULK	<b>13.97</b>
60075	Double-Throw 120V/240V Upper Thermostat	1	1/40	BULK	<b>25.32</b>

### THERM-O-DISC THERMOSTAT

- With high-limit control
- Built-in safety switch to help prevent water heater from overheating
- Fits most brands of water heaters
- Adjustable temperature range: 90° F to 150° F



60174                      60170                      60172                     

PART #	DESCRIPTION	UNIT ORDER	INN/MAS	PACK	LIST
60174	Lower Thermostat for Single-Element Water Heaters	1	10/30	BULK	<b>28.37</b>
60170	Lower Thermostat for Dual-Element Water Heaters	1	10/30	BULK	<b>14.26</b>
60172	Upper Thermostat for Dual-Element Water Heaters	1	10/30	BULK	<b>26.63</b>

### THERMAL EXPANSION TANK

- Factory charged at 40 PSI
- 304 Stainless steel system connection
- Butyl rubber diaphragm
- Max operating temp. 210° F
- Max working pressure 150 PSI
- 3/4" MIP connection
- 5-Year warranty



PART #	DESCRIPTION	UNIT ORDER	INN/MAS	PACK	LIST
60022	2 Gallon	1	-/1	BOX	<b>52.75</b>
60023	4.5 Gallon	1	-/1	BOX	<b>84.99</b>

### WATER HEATER TANK BOOSTER

**NEW**

- Thermostatic mixing valve that mixes hot and cold water together to double the amount of usable water
- Prevents scalding and Legionella bacteria growth
- Includes temperature adjustment knob
- Simple and easy installation
- Works with all water heater tanks



PART #	DESCRIPTION	UNIT ORDER	INN/MAS	PACK	LIST
48275	3/4" FIP Connection	1	-/6	CLAM	<b>171.73</b>

### VACUUM RELIEF VALVE

- For automatic venting of closed systems to atmosphere when a vacuum is created
- All brass body
- Protective cap



PART #	DESCRIPTION	UNIT ORDER	INN/MAS	PACK	LIST
60156	1/2" MIP	1	-/10	BOX	<b>21.95</b>
60158	3/4" MIP	1	-/10	BOX	<b>21.95</b>

### TEMPERATURE & PRESSURE RELIEF VALVE

- CSA rating: 15,000 BTU/Hr
- Designed with extension thermostat and automatic lever resetting
- Use with most water heaters
- Rated 150 PSI - 210° F



PART #	DESCRIPTION	UNIT ORDER	INN/MAS	PACK	LIST
60140	1/2" NPT Standard Shank	1	-/10	BOX	<b>26.35</b>

### TEMPERATURE & PRESSURE RELIEF VALVE

- AGA: 100,000 BTU/Hr
- ASME: 400,000 BTU/Hr
- Designed with extension thermostat & automatic lever resetting
- Use with most water heaters
- Rated 150 PSI - 210° F



60088                      60085                     

PART #	DESCRIPTION	UNIT ORDER	INN/MAS	PACK	LIST
60085	3/4" NPT Standard Shank	1	1/50	BOX	<b>18.59</b>
60088	3/4" NPT Extended Shank	1	1/50	BOX	<b>24.26</b>

# WATER HEATER PARTS

## Water Heater Parts

### TANKLESS PRESSURE RELIEF VALVE

- Offers protection against problematic and over-pressure conditions
- Designed to meet the needs of a wide variety of water systems
- Every valve is tested for performance prior to shipping
- Thermal expansion protection, static pressure, very low-capacity pump relief and other uses where tight shutoff is required



PART #	DESCRIPTION	UNIT ORDER	INN/MAS	PACK	LIST
60045	3/4" MIP x 3/4" FIP	1	1/50	BOX	26.49

### PRESSURE RELIEF VALVE

- 75 PSI
- Brass



PART #	DESCRIPTION	UNIT ORDER	INN/MAS	PACK	LIST
20491LF	1/2" MIP x 1/2" FIP	10	10/100	BULK	14.97
20493LF	3/4" MIP x 3/4" FIP	10	10/100	BULK	13.83

### RUNOFF TUBE

- Attaches to temperature and pressure relief valve on side of water heater
- Thermoplastic polypropylene
- Can be cut to length
- 3/4" MIP



PART #	DESCRIPTION	UNIT ORDER	INN/MAS	PACK	LIST
60062	60" Side-Mount Runoff Tube	1	12/120	BULK	5.22

### ANODE ROD

- Helps prolong the life of your water heater by protecting against corrosion
- 5/8" Aluminum constructed rod
- 3/4" NPT fitting - hex-head
- Fits most brands of water heaters

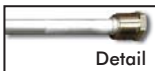

PART #	DESCRIPTION	UNIT ORDER	INN/MAS	PACK	LIST
60066	42" Hex-Head	1	10/100	BULK	23.64

## TANKLESS WATER HEATER SERVICE VALVE KIT

**NEW**

- Heavy-duty bronze and forged lead-free brass construction
- Versatile union tank connections
- 150 PSI pressure relief valve included
- 600 PSI WOG rating
- Tethered capped drain valves allow for quick water heater servicing



PART #	DESCRIPTION	UNIT ORDER	INN/MAS	PACK	LIST
60204	3/4" FNPT Union x 3/4" FIP Service Valves	1	-/2	BOX	135.95
60205	3/4" FNPT Union x 3/4" Sweat Service Valves	1	-/2	BOX	135.95

### FLEXIBLE ANODE ROD

**NEW**

- Helps prolong the life of your water heater by protecting against corrosion
- Flexible (4 sections) with stainless steel links
- Fits most brands of water heaters



PART #	DESCRIPTION	UNIT ORDER	INN/MAS	PACK	LIST
60145	45" Hex-Head	1	-/10	BLISTER	38.49

### WATER HEATER DIP TUBE

- Gasket included
- Fits most brands of water heaters



PART #	DESCRIPTION	UNIT ORDER	INN/MAS	PACK	LIST
60067	52" Polypropylene Flared Dip Tube	1	-/12	BULK	3.56



## Water Heater Parts

### DRAIN VALVE

- Brass
- 2-1/4" Long shank



PART #	DESCRIPTION	UNIT ORDER	INN/MAS	PACK	LIST
60092LF	3/4" MIP x 3/4" MHT	10	10/100	BAG	10.92

### DRAIN VALVE

- Nylon
- 2-1/2" Long shank



PART #	DESCRIPTION	UNIT ORDER	INN/MAS	PACK	LIST
60093	3/4" MIP x 3/4" MHT	1	-/150	BAG	4.62

### THERMOCOUPLES

- Stainless steel head and weld at tip to provide reliable performance
- Designed to simplify installation on automatic controls and burners
- For use with gas water heaters



PART #	DESCRIPTION	UNIT ORDER	INN/MAS	PACK	LIST
60035	18"	1	10/100	CLAM	7.24
60036	24"	1	10/100	CLAM	7.47
60037	30"	1	10/100	CLAM	8.13
60038	36"	1	10/100	CLAM	9.52

### DIELECTRIC UNION

- Bagged with barcode



PART #	DESCRIPTION	UNIT ORDER	INN/MAS	PACK	LIST
20501	1-1/2" FIP x 1/2" Solder	12	12/72	BAG	4.41
20513	3/4" FIP x 1/2" Solder	12	12/72	BAG	4.75
20503	3/4" FIP x 3/4" Solder	12	12/72	BAG	5.39
20515	3/4" MIP x 3/4" Solder	12	12/72	BAG	6.51
20505	1" FIP x 1" Solder	12	12/72	BAG	8.50
20507	1-1/4" FIP x 1-1/4" Solder	6	6/24	BAG	13.46
20509	1-1/2" FIP x 1-1/2" Solder	6	6/24	BAG	19.30
20511	2" FIP x 2" Solder	6	6/24	BAG	32.25

### DIELECTRIC NIPPLE

- Teflon lined
- Galvanized
- Bagged with barcode



PART #	DESCRIPTION	UNIT ORDER	INN/MAS	PACK	LIST
60095	3/4" MIP x 3" Length	10	10/100	BAG	5.25

### HEAT TRAP NIPPLE

- 1 Pair hot & cold
- Galvanized
- Bagged with barcode



PART #	DESCRIPTION	UNIT ORDER	INN/MAS	PACK	LIST
60098	3/4" MIP x 3" Length - 1 Pair	10	10/50	BAG	10.26

### WATER HEATER SAFETY STRAPS

**NEW**

- Meets state and city design guidelines for bracing water heaters
- Adjustable for water heaters up to 80 gallons
- Galvanized steel and corrosion-resistant
- Easy installation - instructions included



86298 - Wrap-Around Mount



86299 - Front Mount



PART #	DESCRIPTION	UNIT ORDER	INN/MAS	PACK	LIST
86298	Wrap-Around Mount	1	1/10	BOX	21.73
86299	Front Mount	1	1/10	BOX	18.42

Supply Connectors

Stop Valves

Water Heater

Gas Connectors

Water Filtration

Sinks/Faucets

Tubular/Drainage

Faucet Repair

Bath Accessories

Pipe Fittings/Repair

Valves

Cements/Sealants

Tools/Safety

Toilet Repair

Appliance/HVAC

Hardware

Electrical

Index

# WATER HEATER PARTS

## Water Heater Parts

### EARTHQUAKE STRAP

- Double body strap
- Fully adjustable from the front of the water heater
- Supports water heaters up to 80 gallons
- City of Los Angeles and State of California approved



**HOLDRITE®**

PART #	DESCRIPTION	UNIT ORDER	INN/MAS	PACK	LIST
86280	Earthquake Strap	1	1/15	BOX	26.60

### WATER HEATER PAN FITTING

- Fits Eastman® water heater pans



PART #	DESCRIPTION	UNIT ORDER	INN/MAS	PACK	LIST
88350	1" Hub x 1" MIP	5	5/100	BULK	6.84
88351	1" Hub x 1" MIP	5	5/50	BULK	2.85

### WATER HEATER PAN

- Black plastic
- Includes drain fittings
- Use with electric water heaters



**WITH PVC FITTINGS**

PART #	DESCRIPTION	UNIT ORDER	INN/MAS	PACK	LIST
60076	20" ID x 22" OD	10	-/10	BULK	8.81
60091	22" ID x 24" OD	10	-/10	BULK	10.12
60082	24" ID x 26" OD	10	-/10	BULK	10.41
60083	26" ID x 28" OD	10	-/10	BULK	13.63
60078	28" ID x 30" OD	10	-/10	BULK	15.50
60077	30" ID x 32" OD	10	-/10	BULK	19.84

**WITH CPVC FITTINGS**

PART #	DESCRIPTION	UNIT ORDER	INN/MAS	PACK	LIST
60076CPVC	20" ID x 22" OD	10	-/10	BULK	9.32
60091CPVC	22" ID x 24" OD	10	-/10	BULK	9.67
60082CPVC	24" ID x 26" OD	10	-/10	BULK	10.98
60083CPVC	26" ID x 28" OD	10	-/10	BULK	14.28
60078CPVC	28" ID x 30" OD	10	-/10	BULK	17.59
60077CPVC	30" ID x 32" OD	10	-/10	BULK	20.44

**EASTMAN®**

### WATER HEATER STAND

- #86278 650 lb. load rate
- #86279 1200 lb. load rate
- Safety clips for screwing to wall or floor included



**EASTMAN®**

PART #	DESCRIPTION	UNIT ORDER	INN/MAS	PACK	LIST
86278	21" D x 21" W x 18" H (30-60 Gal)	1	1/1	BOX	47.05
86279	24" D x 24" W x 18" H (75-100 Gal)	1	1/1	BOX	85.11

### WATER HEATER PAN

- Aluminum
- Includes drain fittings
- Use with gas water heaters



**WITH PVC FITTINGS**

PART #	DESCRIPTION	UNIT ORDER	INN/MAS	PACK	LIST
60080	20" ID x 22" OD	10	-/10	BULK	17.50
60086	22" ID x 24" OD	10	-/10	BULK	18.55
60079	24" ID x 26" OD	10	-/10	BULK	18.55
60089	26" ID x 28" OD	10	-/10	BULK	23.91
60087	28" ID x 30" OD	10	-/10	BULK	29.86
60094	30" ID x 32" OD	10	-/10	BULK	42.06

**WITH CPVC FITTINGS**

PART #	DESCRIPTION	UNIT ORDER	INN/MAS	PACK	LIST
60080CPVC	20" ID x 22" OD	10	-/10	BULK	23.07
60086CPVC	22" ID x 24" OD	10	-/10	BULK	23.64
60079CPVC	24" ID x 26" OD	10	-/10	BULK	23.64
60089CPVC	26" ID x 28" OD	10	-/10	BULK	30.25
60087CPVC	28" ID x 30" OD	10	-/10	BULK	40.15
60094CPVC	30" ID x 32" OD	10	-/10	BULK	42.06

**EASTMAN®**

# GAS CONNECTORS

## EPOXY-COATED & STEEL-FLEX STAINLESS STEEL



Corrugated  
Stainless Steel

Epoxy-Coated  
Stainless Steel

### BTU Capacities Chart

Capacities of Gas Connectors of Various Lengths in BTU/Hr for Natural Gas  
(Multiply by 1.6 for LP Gas)

Length	CONNECTOR SIZE		
	3/8" OD (1/4" ID)	1/2" OD (3/8" ID)	5/8" OD (1/2" ID)
12"	up to 48,000	up to 102,000	up to 180,000
18"	up to 44,000	up to 93,000	up to 164,000
24"	up to 40,000	up to 85,000	up to 150,000
30"	up to 36,000	up to 77,000	up to 137,000
36"	up to 33,000	up to 71,000	up to 125,000
48"	up to 28,000	up to 61,000	up to 106,000
60"	up to 25,000	up to 53,000	up to 93,000
72"	up to 23,000	up to 49,000	up to 86,000



## 1" Epoxy-Coated Gas Connectors

### EZ-40 SERIES CONNECTORS

- Yellow epoxy-coated 304 series stainless steel (ASTM 240)
- Provides extra protection from corrosion, household chemicals, and plumbing repair products
- Zinc-plated steel S45C fittings



PART #	OUTLET x INLET	LENGTH	UNIT ORDER	INNER/MASTER	PACK	LIST
0425118	3/4" FIP x 3/4" MIP	18"	25	-/25	BULK	24.83
0425124	3/4" FIP x 3/4" MIP	24"	25	-/25	BULK	26.77
0425130	3/4" FIP x 3/4" MIP	30"	25	-/25	BULK	29.80
0425136	3/4" FIP x 3/4" MIP	36"	25	-/25	BULK	32.39
0425148	3/4" FIP x 3/4" MIP	48"	25	-/25	BULK	36.30
0425160	3/4" FIP x 3/4" MIP	60"	12	-/12	BULK	40.20
0425172	3/4" FIP x 3/4" MIP	72"	12	-/12	BULK	46.99



1" OD

## 5/8" Epoxy-Coated Gas Connectors

### EZ-30 SERIES CONNECTORS

- Yellow epoxy-coated 304 series stainless steel (ASTM 240)
- Provides extra protection from corrosion, household chemicals, and plumbing repair products
- Zinc-plated steel S45C fittings



PART #	OUTLET x INLET	LENGTH	UNIT ORDER	INNER/MASTER	PACK	LIST
0424718	1/2" FIP x 1/2" FIP	18"	25	-/25	BULK	15.07
0424724	1/2" FIP x 1/2" FIP	24"	25	-/25	BULK	17.45



5/8" OD

Supply  
Connectors

Stop  
Valves

Water  
Heater

Gas  
Connectors

Water  
Filtration

Sinks/  
Faucets

Tubular/  
Drainage

Faucet  
Repair

Bath  
Accessories

Pipe Fittings/  
Repair

Valves

Cements/  
Sealants

Tools/  
Safety

Toilet  
Repair

Appliance/  
HVAC

Hardware

Electrical

Index

# GAS CONNECTORS

## 5/8" Epoxy-Coated Gas Connectors

### EZ-30 SERIES CONNECTORS

- Yellow epoxy-coated 304 series stainless steel (ASTM 240)
- Provides extra protection from corrosion, household chemicals, and plumbing repair products
- Zinc-plated steel S45C fittings



5/8" OD

PART #	OUTLET x INLET	LENGTH	UNIT ORDER	INNER/MASTER	PACK	LIST
0421536	3/4" FIP x 3/4" FIP	36"	25	-/25	BULK	21.65
0421548	3/4" FIP x 3/4" FIP	48"	25	-/25	BULK	28.88

### EZ-30 SERIES CONNECTORS

- Yellow epoxy-coated 304 series stainless steel (ASTM 240)
- Provides extra protection from corrosion, household chemicals, and plumbing repair products
- Zinc-plated steel S45C fittings



5/8" OD

PART #	OUTLET x INLET	LENGTH	UNIT ORDER	INNER/MASTER	PACK	LIST
0416119	1/2" MIP x 1/2" MIP	18"	25	-/25	BULK	14.32
0416120	1/2" MIP x 1/2" MIP	24"	25	-/25	BULK	15.65
0416121	1/2" MIP x 1/2" MIP	36"	25	-/25	BULK	21.17
0416122	1/2" MIP x 1/2" MIP	48"	25	-/25	BULK	25.33

### EZ-30 SERIES CONNECTORS

- Yellow epoxy-coated 304 series stainless steel (ASTM 240)
- Provides extra protection from corrosion, household chemicals, and plumbing repair products
- Zinc-plated steel S45C fittings



5/8" OD

PART #	OUTLET x INLET	LENGTH	UNIT ORDER	INNER/MASTER	PACK	LIST
0422024	3/4" MIP x 3/4" MIP	24"	25	-/25	BULK	20.56
0422036	3/4" MIP x 3/4" MIP	36"	25	-/25	BULK	23.35

### EZ-30 SERIES CONNECTORS

- Yellow epoxy-coated 304 series stainless steel (ASTM 240)
- Provides extra protection from corrosion, household chemicals, and plumbing repair products
- Zinc-plated steel S45C fittings



5/8" OD

PART #	OUTLET x INLET	LENGTH	UNIT ORDER	INNER/MASTER	PACK	LIST
0425512	1/2" FIP x 1/2" MIP	12"	25	-/25	BULK	12.34
0425518	1/2" FIP x 1/2" MIP	18"	25	-/25	BULK	15.07
0425524	1/2" FIP x 1/2" MIP	24"	25	-/25	BULK	14.83
0425536	1/2" FIP x 1/2" MIP	36"	25	-/25	BULK	18.10
0425548	1/2" FIP x 1/2" MIP	48"	25	-/25	BULK	23.02
0425560	1/2" FIP x 1/2" MIP	60"	12	-/12	BULK	29.39
0425572	1/2" FIP x 1/2" MIP	72"	12	-/12	BULK	33.64

## 1/2" Epoxy-Coated Gas Connectors

### EZ-20 SERIES CONNECTORS

- Yellow epoxy-coated 304 series stainless steel (ASTM 240)
- Provides extra protection from corrosion, household chemicals, and plumbing repair products
- Zinc-plated steel S45C fittings



1/2" OD

PART #	OUTLET x INLET	LENGTH	UNIT ORDER	INNER/MASTER	PACK	LIST
0414336	1/2" FIP x 1/2" FIP	36"	25	-/25	BULK	17.96
0414348	1/2" FIP x 1/2" FIP	48"	25	-/25	BULK	21.81

## 1/2" Epoxy-Coated Gas Connectors

### EZ-20 SERIES CONNECTORS

- Yellow epoxy-coated 304 series stainless steel (ASTM 240)
- Provides extra protection from corrosion, household chemicals, and plumbing repair products
- Zinc-plated steel S45C fittings



PART #	OUTLET x INLET	LENGTH	UNIT ORDER	INNER/ MASTER	PACK	LIST
0416112	1/2" MIP x 1/2" MIP	12"	25	-/25	BULK	<b>11.60</b>
0416118	1/2" MIP x 1/2" MIP	18"	25	-/25	BULK	<b>14.03</b>
0416124	1/2" MIP x 1/2" MIP	24"	25	-/25	BULK	<b>15.43</b>
0416136	1/2" MIP x 1/2" MIP	36"	25	-/25	BULK	<b>18.08</b>
0416148	1/2" MIP x 1/2" MIP	48"	25	-/25	BULK	<b>21.81</b>



1/2" OD

### EZ-20 SERIES CONNECTORS

- Yellow epoxy-coated 304 series stainless steel (ASTM 240)
- Provides extra protection from corrosion, household chemicals, and plumbing repair products
- Zinc-plated steel S45C fittings



PART #	OUTLET x INLET	LENGTH	UNIT ORDER	INNER/ MASTER	PACK	LIST
0415112	1/2" FIP x 1/2" MIP	12"	25	-/25	BULK	<b>11.60</b>
0415118	1/2" FIP x 1/2" MIP	18"	25	-/25	BULK	<b>14.03</b>
0415124	1/2" FIP x 1/2" MIP	24"	25	-/25	BULK	<b>15.34</b>
0415136	1/2" FIP x 1/2" MIP	36"	25	-/25	BULK	<b>17.96</b>
0415148	1/2" FIP x 1/2" MIP	48"	25	-/25	BULK	<b>21.81</b>
0415160	1/2" FIP x 1/2" MIP	60"	12	-/12	BULK	<b>28.14</b>



1/2" OD

## 3/8" Epoxy-Coated Gas Connectors

### EZ-10 SERIES CONNECTORS

- Yellow epoxy-coated 304 series stainless steel (ASTM 240)
- Provides extra protection from corrosion, household chemicals, and plumbing repair products
- Zinc-plated steel S45C fittings



PART #	OUTLET x INLET	LENGTH	UNIT ORDER	INNER/ MASTER	PACK	LIST
0414448	1/2" FIP x 1/2" FIP	48"	25	-/25	BULK	<b>17.71</b>



3/8" OD

### EZ-10 SERIES CONNECTORS

- Yellow epoxy-coated 304 series stainless steel (ASTM 240)
- Provides extra protection from corrosion, household chemicals, and plumbing repair products
- Zinc-plated steel S45C fittings



PART #	OUTLET x INLET	LENGTH	UNIT ORDER	INNER/ MASTER	PACK	LIST
0405018	3/8" FIP x 3/8" FIP	18"	25	-/25	BULK	<b>9.96</b>
0405024	3/8" FIP x 3/8" FIP	24"	25	-/25	BULK	<b>12.86</b>
0405030	3/8" FIP x 3/8" FIP	30"	25	-/25	BULK	<b>14.74</b>
0405048	3/8" FIP x 3/8" FIP	48"	25	-/25	BULK	<b>17.71</b>
0405060	3/8" FIP x 3/8" FIP	60"	12	-/12	BULK	<b>20.90</b>
0405072	3/8" FIP x 3/8" FIP	72"	12	-/12	BULK	<b>23.93</b>



3/8" OD

### EZ-10 SERIES CONNECTORS

- Yellow epoxy-coated 304 series stainless steel (ASTM 240)
- Provides extra protection from corrosion, household chemicals, and plumbing repair products
- Zinc-plated steel S45C fittings



PART #	OUTLET x INLET	LENGTH	UNIT ORDER	INNER/ MASTER	PACK	LIST
0416712	1/2" FIP x 1/2" MIP	12"	25	-/25	BULK	<b>10.92</b>
0416718	1/2" FIP x 1/2" MIP	18"	25	-/25	BULK	<b>12.17</b>
0416724	1/2" FIP x 1/2" MIP	24"	25	-/25	BULK	<b>12.86</b>
0416736	1/2" FIP x 1/2" MIP	36"	25	-/25	BULK	<b>15.65</b>
0416748	1/2" FIP x 1/2" MIP	48"	25	-/25	BULK	<b>21.64</b>



3/8" OD

Supply Connectors

Stop Valves

Water Heater

Gas Connectors

Water Filtration

Sinks/ Faucets

Tubular/ Drainage

Faucet Repair

Bath Accessories

Pipe Fittings/ Repair

Valves

Cements/ Sealants

Tools/ Safety

Toilet Repair

Appliance/ HVAC

Hardware

Electrical

Index

# GAS CONNECTORS

## 5/8" Stainless Steel Gas Connectors

### STEEL-FLEX® EZ-30 SERIES CONNECTORS

- Uncoated 304 series stainless steel (ASTM 240)
- Zinc-plated steel S45C fittings



PART #	OUTLET x INLET	LENGTH	UNIT ORDER	INNER/ MASTER	PACK	LIST
0424624	1/2" FIP x 1/2" FIP	24"	25	-/25	BULK	15.12
0424648	1/2" FIP x 1/2" FIP	48"	25	-/25	BULK	22.77
0424660	1/2" FIP x 1/2" FIP	60"	12	-/12	BULK	27.18



5/8" OD

### STEEL-FLEX® EZ-30 SERIES CONNECTORS

- Uncoated 304 series stainless steel (ASTM 240)
- Zinc-plated steel S45C fittings



PART #	OUTLET x INLET	LENGTH	UNIT ORDER	INNER/ MASTER	PACK	LIST
0421448	3/4" FIP x 3/4" FIP	48"	25	-/25	BULK	22.19



5/8" OD

### STEEL-FLEX® EZ-30 SERIES CONNECTORS

- Uncoated 304 series stainless steel (ASTM 240)
- Zinc-plated steel S45C fittings



PART #	OUTLET x INLET	LENGTH	UNIT ORDER	INNER/ MASTER	PACK	LIST
0427818	1/2" MIP x 1/2" MIP	18"	25	-/25	BULK	13.44
0427824	1/2" MIP x 1/2" MIP	24"	25	-/25	BULK	14.65
0427830	1/2" MIP x 1/2" MIP	30"	25	-/25	BULK	16.87
0427836	1/2" MIP x 1/2" MIP	36"	25	-/25	BULK	16.77
0427848	1/2" MIP x 1/2" MIP	48"	25	-/25	BULK	21.51
0427860	1/2" MIP x 1/2" MIP	60"	12	-/12	BULK	23.85



5/8" OD

### STEEL-FLEX® EZ-30 SERIES CONNECTORS

- Uncoated 304 series stainless steel (ASTM 240)
- Zinc-plated steel S45C fittings



PART #	OUTLET x INLET	LENGTH	UNIT ORDER	INNER/ MASTER	PACK	LIST
0428724	3/4" MIP x 1/2" MIP	24"	25	-/25	BULK	16.59
0428730	3/4" MIP x 1/2" MIP	30"	25	-/25	BULK	18.20
0428736	3/4" MIP x 1/2" MIP	36"	25	-/25	BULK	18.57
0428748	3/4" MIP x 1/2" MIP	48"	25	-/25	BULK	21.09
0428760	3/4" MIP x 1/2" MIP	60"	12	-/12	BULK	27.83
0428772	3/4" MIP x 1/2" MIP	72"	12	-/12	BULK	32.25



5/8" OD

### STEEL-FLEX® EZ-30 SERIES CONNECTORS

- Uncoated 304 series stainless steel (ASTM 240)
- Zinc-plated steel S45C fittings



PART #	OUTLET x INLET	LENGTH	UNIT ORDER	INNER/ MASTER	PACK	LIST
*0427048	1/2" MIP x 3/4" FIP Angle Ball Valve	48"	25	-/25	BULK	36.97



5/8" OD

### STEEL-FLEX® EZ-30 SERIES CONNECTORS

- Uncoated 304 series stainless steel (ASTM 240)
- Zinc-plated steel S45C fittings



PART #	OUTLET x INLET	LENGTH	UNIT ORDER	INNER/ MASTER	PACK	LIST
*0419836	1/2" MIP x 3/4" FIP Straight Ball Valve	36"	25	-/25	BULK	28.20



5/8" OD

\*While Supplies Last

\*While Supplies Last

## 5/8" Stainless Steel Gas Connectors

### STEEL-FLEX® EZ-30 SERIES CONNECTORS

- Uncoated 304 series stainless steel (ASTM 240)
- Zinc-plated steel S45C fittings



PART #	OUTLET x INLET	LENGTH	UNIT ORDER	INNER/MASTER	PACK	LIST
*0419018	3/4" FIP x 3/4" FIP Straight Ball Valve	18"	25	-/25	BULK	<b>24.13</b>

*\*While Supplies Last*



5/8" OD

### STEEL-FLEX® EZ-30 SERIES CONNECTORS

- Uncoated 304 series stainless steel (ASTM 240)
- Zinc-plated steel S45C fittings



PART #	OUTLET x INLET	LENGTH	UNIT ORDER	INNER/MASTER	PACK	LIST
*0418418	1/2" MIP x 1/2" FIP Straight Ball Valve	18"	25	-/25	BULK	<b>21.67</b>

*\*While Supplies Last*



5/8" OD

### STEEL-FLEX® EZ-30 SERIES CONNECTORS

- Uncoated 304 series stainless steel (ASTM 240)
- Zinc-plated steel S45C fittings



PART #	OUTLET x INLET	LENGTH	UNIT ORDER	INNER/MASTER	PACK	LIST
0431036	3/4" MIP x 3/4" MIP	36"	25	-/25	BULK	<b>19.20</b>
0431048	3/4" MIP x 3/4" MIP	48"	25	-/25	BULK	<b>26.40</b>



5/8" OD

### STEEL-FLEX® EZ-30 SERIES CONNECTORS

- Uncoated 304 series stainless steel (ASTM 240)
- Zinc-plated steel S45C fittings



PART #	OUTLET x INLET	LENGTH	UNIT ORDER	INNER/MASTER	PACK	LIST
0425412	1/2" FIP x 1/2" MIP	12"	25	-/25	BULK	<b>12.34</b>
0425418	1/2" FIP x 1/2" MIP	18"	25	-/25	BULK	<b>13.76</b>
0425424	1/2" FIP x 1/2" MIP	24"	25	-/25	BULK	<b>16.00</b>
0425430	1/2" FIP x 1/2" MIP	30"	25	-/25	BULK	<b>16.94</b>
0425436	1/2" FIP x 1/2" MIP	36"	25	-/25	BULK	<b>18.03</b>
0425448	1/2" FIP x 1/2" MIP	48"	25	-/25	BULK	<b>20.51</b>
0425460	1/2" FIP x 1/2" MIP	60"	12	-/12	BULK	<b>24.59</b>
0425472	1/2" FIP x 1/2" MIP	72"	12	-/12	BULK	<b>30.21</b>



5/8" OD

### STEEL-FLEX® EZ-30 SERIES CONNECTORS

- Uncoated 304 series stainless steel (ASTM 240)
- Zinc-plated steel S45C fittings



PART #	OUTLET x INLET	LENGTH	UNIT ORDER	INNER/MASTER	PACK	LIST
0423836	3/4" FIP x 1/2" MIP	36"	25	-/25	BULK	<b>22.04</b>
0423848	3/4" FIP x 1/2" MIP	48"	25	-/25	BULK	<b>21.74</b>
0423860	3/4" FIP x 1/2" MIP	60"	25	-/25	BULK	<b>28.34</b>



5/8" OD

### STEEL-FLEX® EZ-30 SERIES CONNECTORS

- Uncoated 304 series stainless steel (ASTM 240)
- Zinc-plated steel S45C fittings



PART #	OUTLET x INLET	LENGTH	UNIT ORDER	INNER/MASTER	PACK	LIST
0422218	3/4" FIP x 3/4" MIP	18"	25	-/25	BULK	<b>16.48</b>
0422224	3/4" FIP x 3/4" MIP	24"	25	-/25	BULK	<b>16.31</b>
0422236	3/4" FIP x 3/4" MIP	36"	25	-/25	BULK	<b>18.94</b>
0422248	3/4" FIP x 3/4" MIP	48"	25	-/25	BULK	<b>26.23</b>
0422260	3/4" FIP x 3/4" MIP	60"	12	-/12	BULK	<b>26.92</b>



5/8" OD

Supply Connectors

Stop Valves

Water Heater

Gas Connectors

Water Filtration

Sinks/Faucets

Tubular/Drainage

Faucet Repair

Bath Accessories

Pipe Fittings/Repair

Valves

Cements/Sealants

Tools/Safety

Toilet Repair

Appliance/HVAC

Hardware

Electrical

Index

# GAS CONNECTORS

## 1/2" Stainless Steel Gas Connectors

### STEEL-FLEX® EZ-20 SERIES CONNECTORS

- Uncoated 304 series stainless steel (ASTM 240)
- Zinc-plated steel S45C fittings



1/2" OD



PART #	OUTLET x INLET	LENGTH	UNIT ORDER	INNER/ MASTER	PACK	LIST
0415812	1/2" MIP x 1/2" MIP	12"	25	-/25	BULK	<b>11.38</b>
0415818	1/2" MIP x 1/2" MIP	18"	25	-/25	BULK	<b>13.74</b>
0415824	1/2" MIP x 1/2" MIP	24"	25	-/25	BULK	<b>12.27</b>
0415830	1/2" MIP x 1/2" MIP	30"	25	-/25	BULK	<b>16.85</b>
0415836	1/2" MIP x 1/2" MIP	36"	25	-/25	BULK	<b>17.65</b>
0415848	1/2" MIP x 1/2" MIP	48"	25	-/25	BULK	<b>21.41</b>
0415860	1/2" MIP x 1/2" MIP	60"	12	-/12	BULK	<b>22.56</b>

### STEEL-FLEX® EZ-20 SERIES CONNECTORS

- Uncoated 304 series stainless steel (ASTM 240)
- Zinc-plated steel S45C fittings



1/2" OD



PART #	OUTLET x INLET	LENGTH	UNIT ORDER	INNER/ MASTER	PACK	LIST
0415012	1/2" FIP x 1/2" MIP	12"	25	-/25	BULK	<b>11.38</b>
0415018	1/2" FIP x 1/2" MIP	18"	25	-/25	BULK	<b>13.74</b>
0415024	1/2" FIP x 1/2" MIP	24"	25	-/25	BULK	<b>15.00</b>
0415030	1/2" FIP x 1/2" MIP	30"	25	-/25	BULK	<b>16.85</b>
0415036	1/2" FIP x 1/2" MIP	36"	25	-/25	BULK	<b>17.65</b>
0415048	1/2" FIP x 1/2" MIP	48"	25	-/25	BULK	<b>17.52</b>
0415060	1/2" FIP x 1/2" MIP	60"	12	-/12	BULK	<b>22.56</b>
0415072	1/2" FIP x 1/2" MIP	72"	12	-/12	BULK	<b>25.68</b>

### STEEL-FLEX® EZ-20 SERIES CONNECTORS

- Uncoated 304 series stainless steel (ASTM 240)
- Zinc-plated steel S45C fittings



1/2" OD



PART #	OUTLET x INLET	LENGTH	UNIT ORDER	INNER/ MASTER	PACK	LIST
*0417412	1/2" MIP x 1/2" FIP Straight Ball Valve	12"	25	-/25	BULK	<b>16.65</b>
0417418	1/2" MIP x 1/2" FIP Straight Ball Valve	18"	25	-/25	BULK	<b>18.84</b>
0417424	1/2" MIP x 1/2" FIP Straight Ball Valve	24"	25	-/25	BULK	<b>19.97</b>
*0417430	1/2" MIP x 1/2" FIP Straight Ball Valve	30"	25	-/25	BULK	<b>22.32</b>
0417436	1/2" MIP x 1/2" FIP Straight Ball Valve	36"	25	-/25	BULK	<b>23.40</b>
0417448	1/2" MIP x 1/2" FIP Straight Ball Valve	48"	25	-/25	BULK	<b>27.12</b>
*0417472	1/2" MIP x 1/2" FIP Straight Ball Valve	72"	12	-/12	BULK	<b>34.04</b>

\*While Supplies Last



## 3/8" Stainless Steel Gas Connectors

### STEEL-FLEX® EZ-10 SERIES CONNECTORS

- Uncoated 304 series stainless steel (ASTM 240)
- Zinc-plated steel S45C fittings



PART #	OUTLET x INLET	LENGTH	UNIT ORDER	INNER/MASTER	PACK	LIST
0405612	1/2" MIP x 1/2" MIP	12"	25	-/25	BULK	<b>10.26</b>
0405618	1/2" MIP x 1/2" MIP	18"	25	-/25	BULK	<b>11.43</b>
0405624	1/2" MIP x 1/2" MIP	24"	25	-/25	BULK	<b>12.09</b>
0405630	1/2" MIP x 1/2" MIP	30"	25	-/25	BULK	<b>13.83</b>
0405636	1/2" MIP x 1/2" MIP	36"	25	-/25	BULK	<b>14.68</b>
0405648	1/2" MIP x 1/2" MIP	48"	25	-/25	BULK	<b>16.63</b>



3/8" OD

### STEEL-FLEX® EZ-10 SERIES CONNECTORS

- Uncoated 304 series stainless steel (ASTM 240)
- Zinc-plated steel S45C fittings



PART #	OUTLET x INLET	LENGTH	UNIT ORDER	INNER/MASTER	PACK	LIST
0404112	1/2" FIP x 1/2" MIP	12"	25	-/25	BULK	<b>10.26</b>
0404118	1/2" FIP x 1/2" MIP	18"	25	-/25	BULK	<b>11.43</b>
0404124	1/2" FIP x 1/2" MIP	24"	25	-/25	BULK	<b>12.09</b>
0404130	1/2" FIP x 1/2" MIP	30"	25	-/25	BULK	<b>13.83</b>
0404136	1/2" FIP x 1/2" MIP	36"	25	-/25	BULK	<b>14.68</b>
0404148	1/2" FIP x 1/2" MIP	48"	25	-/25	BULK	<b>16.63</b>
0404160	1/2" FIP x 1/2" MIP	60"	12	-/12	BULK	<b>19.62</b>
0404172	1/2" FIP x 1/2" MIP	72"	12	-/12	BULK	<b>22.49</b>



3/8" OD

### STEEL-FLEX® EZ-10 SERIES CONNECTORS

- Uncoated 304 series stainless steel (ASTM 240)
- Zinc-plated steel S45C fittings



PART #	OUTLET x INLET	LENGTH	UNIT ORDER	INNER/MASTER	PACK	LIST
* 0400918	3/8" FIP x 1/2" FIP Straight Ball Valve	18"	25	-/25	BULK	<b>15.69</b>
* 0400936	3/8" FIP x 1/2" FIP Straight Ball Valve	36"	25	-/25	BULK	<b>20.25</b>



3/8" OD

\*v Supplies Last

Supply  
Connectors

Stop  
Valves

Water  
Heater

Gas  
Connectors

Water  
Filtration

Sinks/  
Faucets

Tubular/  
Drainage

Faucet  
Repair

Bath  
Accessories

Pipe Fittings/  
Repair

Valves

Cements/  
Sealants

Tools/  
Safety

Toilet  
Repair

Appliance/  
HVAC

Hardware

Electrical

Index

# GAS CONNECTORS

## Gas Connector Valves

### BRASS LEVER HANDLE STRAIGHT GAS VALVE FEMALE X FEMALE

- Lever handle
- For use with liquefied petroleum, natural gas and air mixtures up to 175 PSI
- Brass body



PART #	DESCRIPTION	UNIT ORDER	INN/MAS	PACK	LIST
60009	1/2" FIP	12	12/144	BULK	6.42
60011	3/4" FIP	12	12/120	BULK	9.89
60013	1" FIP	6	12/36	BULK	21.33

### BRASS LEVER HANDLE STRAIGHT GAS VALVE FLARE X FLARE

**NEW**

- Lever handle
- For use with liquefied petroleum, natural gas and air mixtures up to 175 PSI
- Brass body



PART #	DESCRIPTION	UNIT ORDER	INN/MAS	PACK	LIST
60004	3/8" OD Flare x 3/8" OD Flare	10	10/120	BULK	6.67
60006	1/2" OD Flare x 1/2" OD Flare	10	10/120	BULK	7.53

### BRASS FLARE STRAIGHT GAS VALVES FLARE X FEMALE

- Lever handle
- For use with liquefied petroleum, natural gas and air mixtures up to 175 PSI
- Brass body



PART #	DESCRIPTION	UNIT ORDER	INN/MAS	PACK	LIST
60001	1/2" FIP x 3/8" OD Flare	10	10/120	BULK	8.33
60003	1/2" FIP x 1/2" OD Flare	10	10/120	BULK	8.27
60031	1/2" FIP x 5/8" OD Flare	10	10/100	BULK	11.80
60030	3/4" FIP x 1/2" OD Flare	10	10/80	BULK	13.54
60005	3/4" FIP x 5/8" OD Flare	10	10/80	BULK	12.80

### BRASS FLARE ANGLE GAS VALVES FLARE X FEMALE

- Lever handle
- For use with liquefied petroleum, natural gas and air mixtures up to 175 PSI
- Brass body



PART #	DESCRIPTION	UNIT ORDER	INN/MAS	PACK	LIST
60032	1/2" FIP x 3/8" OD Flare	8	8/80	BULK	10.52
60034	1/2" FIP x 1/2" OD Flare	8	8/80	BULK	10.95
60029	1/2" FIP x 5/8" OD Flare	4	4/80	BULK	14.60

## Gas Outlet Box

### GAS OUTLET BOX

- Provides a recessed valve installation allowing appliances to be closer to wall
- Preloaded nails provide a strong, rigid mount
- Nails are reversible and box can be mounted to the left or right hand stud bay
- Test plug provided for testing valve assembly



PART #	DESCRIPTION	UNIT ORDER	INN/MAS	PACK	LIST
60573	1/2" MIP Connection	10	-/10	BULK	43.52

## Gas Connector Fittings

### BRASS FLARE GAS FITTINGS FLARE X MALE

- Tapped female



PART #	DESCRIPTION	UNIT ORDER	INN/MAS	PACK	LIST
62744	3/8" OD Flare x 3/8" MIP (Tapped 1/8" FIP)	5	5/100	BULK	2.71
62745	3/8" OD Flare x 1/2" MIP (Tapped 3/8" FIP)	5	5/100	BULK	2.71
65726	1/2" OD Flare x 1/2" MIP (Tapped 3/8" FIP)	5	5/100	BULK	3.02
62740	1/2" OD Flare x 3/4" MIP (Tapped 1/2" FIP)	5	5/100	BULK	2.54
62730	5/8" OD Flare x 1/2" MIP (Tapped 3/8" FIP)	5	5/100	BULK	3.28
62731	5/8" OD Flare x 3/4" MIP (Tapped 1/2" FIP)	5	5/100	BULK	5.02
65720	1" OD Flare x 3/4" MIP (Tapped 1/2" FIP)	5	5/100	BULK	4.33

### BRASS FLARE GAS FITTINGS FLARE X MALE



PART #	DESCRIPTION	UNIT ORDER	INN/MAS	PACK	LIST
65704	1/2" OD Flare x 1/2" MIP	5	-/25	BULK	3.56
65703	5/8" OD Flare x 1/2" MIP	5	-/25	BULK	3.96
*65705	5/8" OD Flare x 3/4" MIP	5	5/200	BULK	2.25

\*While Supplies Last

### BRASS FLARE GAS FITTINGS FLARE X FEMALE



PART #	DESCRIPTION	UNIT ORDER	INN/MAS	PACK	LIST
62747	3/8" OD Flare x 3/8" FIP	5	-/100	BULK	2.42
65728	1/2" OD Flare x 1/2" FIP	5	-/100	BULK	3.02
65722	1" OD Flare x 3/4" FIP	5	-/100	BULK	4.33



*HIGH-EFFICIENCY*

# REVERSE OSMOSIS WATER FILTRATION SYSTEM

Bottled water quality straight from the tap!



22010

22011

22010

- Improves taste and clarity of drinking water
- Reduces 97% of total dissolved solids
- Produces up to 13 gallons of filtered water per day
- 2.8 Gallon water storage holding tank
- Easy to install, convenient to use
- Fast auto shutoff
- 22000 Includes: Tank, (2) carbon 1 filters, (1) reverse osmosis membrane, chrome faucet and mounting hardware

**REDUCES:**



Dissolved Solids



Heavy Metals

**Twist-n-Lock Filters**  
No-Spill Replacement

1. Align filter

2. Insert into head

3. Turn counterclockwise to lock in place

Do not force

Tested and Certified by the Water Quality Association against NSF/ANSI Standard 58 for the reduction of Cysts, Lead, Pentavalent Arsenic, Nitrites/Nitrates, Chromium III, Chromium VI, Selenium, Cadmium and Total Dissolved Solids (TDS) and against NSF/ANSI Standard 42 for the aesthetic reduction of Particulates and Chlorine Taste & Odor.



PART #	DESCRIPTION	UNIT ORDER	INN/MAS	PACK	LIST
22000	Reverse Osmosis System	1	-/1	BOX	<b>370.06</b>
22010	Replacement Carbon 1 Filter	1	-/25	BULK	<b>37.01</b>
22011	Replacement RO Membrane	1	-/25	BULK	<b>124.57</b>

Supply Connectors

Stop Valves

Water Heater

Gas Connectors

Water Filtration

Sinks/Faucets

Tubular/Drainage

Faucet Repair

Bath Accessories

Pipe Fittings/Repair

Valves

Cements/Sealants

Tools/Safety

Toilet Repair

Appliance/HVAC

Hardware

Electrical

Index



# FILTER HOUSINGS & COMPATIBLE QUALITY FILTERS

"Water filtration solutions to fit all your customers' needs"

## Under Sink Point-of-Use Solution

### FILTER HOUSING

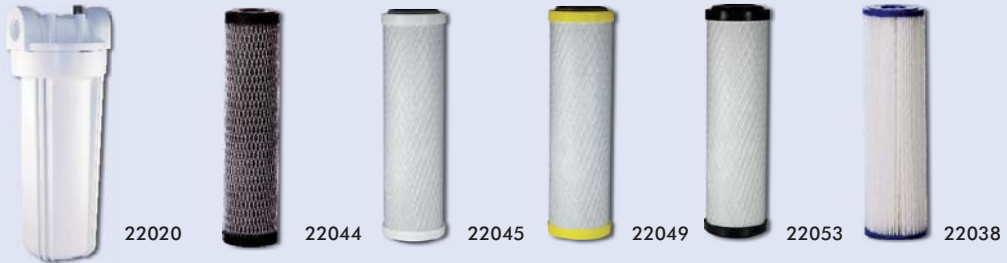

PART #	DESCRIPTION	UNIT ORDER	INN/MAS	PACK	LIST
22020	2-1/2" x 10" White - 3/8" NPT Connection Housing	1	-/6	BULK	22.78

### COMPATIBLE FILTERS

PART #	DESCRIPTION	SIZE	MICRON RATING	FLOW RATE	UNIT ORDER	INN/MAS	PACK	LIST
22044	Chlorine Carbon Block - Carbon Wrapped	2-1/2" x 10"	5 Micron	2 GPM	1	-/50	BULK	7.95
22045	Chlorine Taste & Odor Carbon Block	2-1/2" x 10"	5 Micron	1 GPM	1	-/20	BULK	17.08
22049	Chloramine Carbon Block	2-1/2" x 10"	1 Micron	1 GPM	1	-/20	BULK	36.44
22053	Advanced Carbon Block	2-1/2" x 10"	1 Micron	1 GPM	1	-/20	BULK	25.80
22038	Pleated Sediment Filter	2-1/2" x 10"	30 Micron	8 GPM	1	-/50	BULK	12.09



## Household Point-of-Entry Solution

### FILTER HOUSING

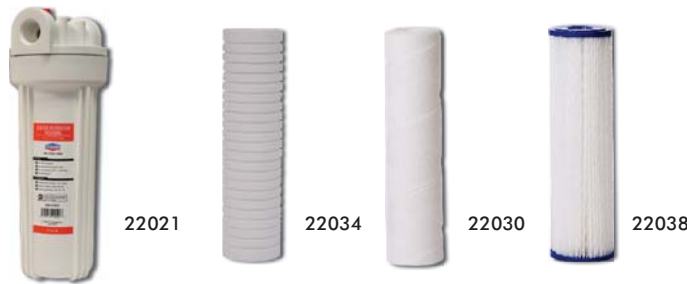

PART #	DESCRIPTION	UNIT ORDER	INN/MAS	PACK	LIST
22021	2-1/2" x 10" White - 3/4" NPT Connection Housing	1	-/6	BULK	24.21

### COMPATIBLE FILTERS

PART #	DESCRIPTION	SIZE	MICRON RATING	FLOW RATE	UNIT ORDER	INN/MAS	PACK	LIST
22034	Grooved Melt-Blown Sediment Filter	2-1/2" x 10"	5 Micron	8 GPM	1	-/25	BULK	3.85
22030	String Wound Sediment Filter	2-1/2" x 10"	5 Micron	10 GPM	1	-/25	BULK	5.10
22038	Pleated Sediment Filter	2-1/2" x 10"	30 Micron	8 GPM	1	-/50	BULK	12.09



### FILTER HOUSING

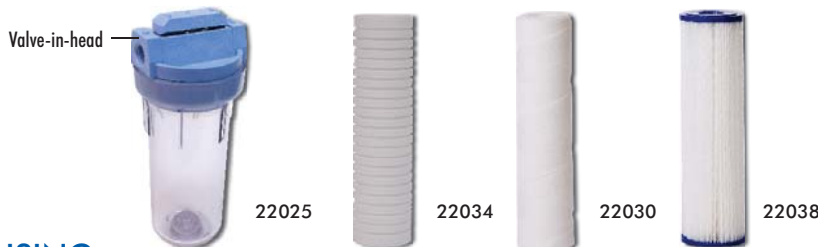

PART #	DESCRIPTION	UNIT ORDER	INN/MAS	PACK	LIST
22025	2-1/2" x 10" Clear - 3/4" NPT Connection Housing - <b>NEW!</b>	1	-/6	BULK	61.42

### COMPATIBLE FILTERS

PART #	DESCRIPTION	SIZE	MICRON RATING	FLOW RATE	UNIT ORDER	INN/MAS	PACK	LIST
22034	Grooved Melt-Blown Sediment Filter	2-1/2" x 10"	5 Micron	8 GPM	1	-/25	BULK	3.85
22030	String Wound Sediment Filter	2-1/2" x 10"	5 Micron	10 GPM	1	-/25	BULK	5.10
22038	Pleated Sediment Filter	2-1/2" x 10"	30 Micron	8 GPM	1	-/50	BULK	12.09





# FILTER HOUSINGS & COMPATIBLE QUALITY FILTERS

"Water filtration solutions to fit all your customers' needs"

## Household Point-of-Entry Solution



### FILTER HOUSING

PART #	DESCRIPTION	UNIT ORDER	INN/MAS	PACK	LIST
22022	4-1/2" x 10" Blue - 1" NPT Connection Housing	1	-/4	BULK	73.13

### COMPATIBLE FILTERS

PART #	DESCRIPTION	SIZE	MICRON RATING	FLOW RATE	UNIT ORDER	INN/MAS	PACK	LIST
22039	Pleated Sediment Filter	4-1/2" x 10"	30 Micron	8 GPM	1	-/18	BULK	21.36
22042	Chlorine Carbon Block - Radial Flow	4-1/2" x 10"	20 Micron	10 GPM	1	-/9	BULK	41.51
22047	Chlorine Taste & Odor Carbon Block	4-1/2" x 10"	5 Micron	10 GPM	1	-/9	BULK	50.01
22051	Chloramine Carbon Block	4-1/2" x 10"	5 Micron	10 GPM	1	-/9	BULK	127.96



COMPLIES WITH NSF-61



### FILTER HOUSING

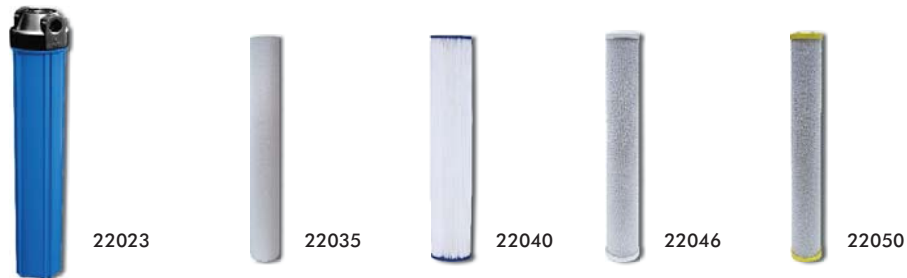

PART #	DESCRIPTION	UNIT ORDER	INN/MAS	PACK	LIST
22023	2-1/2" x 20" Blue - 3/4" NPT Connection Housing	1	-/8	BULK	78.95

### COMPATIBLE FILTERS

PART #	DESCRIPTION	SIZE	MICRON RATING	FLOW RATE	UNIT ORDER	INN/MAS	PACK	LIST
22035	Melt-Blown Sediment Filter	2-1/2" x 20"	30 Micron	8 GPM	1	-/25	BULK	8.53
22040	Pleated Sediment Filter	2-1/2" x 20"	20 Micron	8 GPM	1	-/25	BULK	13.09
22046	Chlorine Taste & Odor Carbon Block	2-1/2" x 20"	5 Micron	10 GPM	1	-/20	BULK	34.56
22050	Chloramine Carbon Block	2-1/2" x 20"	1 Micron	8 GPM	1	-/20	BULK	84.60



COMPLIES WITH NSF-61



### FILTER HOUSING



PART #	DESCRIPTION	UNIT ORDER	INN/MAS	PACK	LIST
22024	4-1/2" x 20" Blue - 1" NPT Connection Housing	1	-/4	BULK	115.62

### COMPATIBLE FILTERS

PART #	DESCRIPTION	SIZE	MICRON RATING	FLOW RATE	UNIT ORDER	INN/MAS	PACK	LIST
22041	Pleated Sediment Filter - <b>NEW!</b>	4-1/2" x 20"	30 Micron	8 GPM	1	-/9	BULK	19.16
22048	Chlorine Taste & Odor Carbon Block	4-1/2" x 20"	10 Micron	10 GPM	1	-/9	BULK	85.17
22052	Chloramine Carbon Block	4-1/2" x 20"	5 Micron	10 GPM	1	-/9	BULK	255.73



COMPLIES WITH NSF-61



Supply Connectors

Stop Valves

Water Heater

Gas Connectors

Water Filtration

Sinks/ Faucets

Tubular/ Drainage

Faucet Repair

Bath Accessories

Pipe Fittings/ Repair

Valves

Cements/ Sealants

Tools/ Safety

Toilet Repair

Appliance/ HVAC

Hardware

Electrical

Index



# QUALITY UNIVERSAL REPLACEMENT FILTERS

To fit most standard filter housings

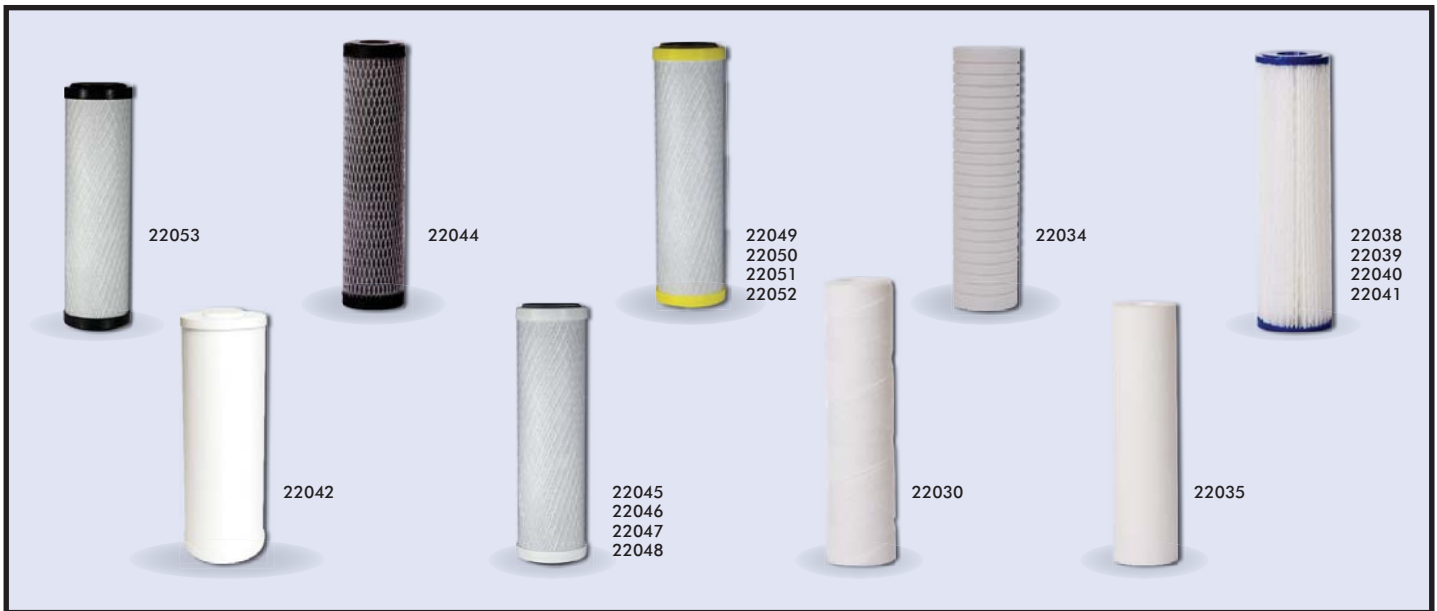

FILTERS FOR	PART #	DESCRIPTION	APPLICATION	SIZE	MICRON RATING	FLOW RATE	UNIT ORDER	INN/MAS	PACK	CERTIFICATIONS	LIST
Chlorine taste and odor, lead, VOC, cysts, lindane, MTBE, asbestos, and mercury	22053	Advanced Carbon Block	Under Sink	2-1/2" x 10"	1 Micron	1 GPM	1	-/20	BULK		25.80
	22042	Radial Flow	Household	4-1/2" x 10"	20 Micron	10 GPM	1	-/9	BULK		41.51
Chlorine taste and odor, sediment	22044	Carbon Wrap	Under Sink	2-1/2" x 10"	5 Micron	2 GPM	1	-/50	BULK		7.95
	22045	Classic Carbon Block	Under Sink	2-1/2" x 10"	5 Micron	1 GPM	1	-/20	BULK		17.08
	22046	Classic Carbon Block	Household	2-1/2" x 20"	5 Micron	10 GPM	1	-/20	BULK		34.56
	22047	Classic Carbon Block	Household	4-1/2" x 10"	5 Micron	10 GPM	1	-/9	BULK		50.01
	22048	Classic Carbon Block	Household	4-1/2" x 20"	10 Micron	10 GPM	1	-/9	BULK		85.17
Chloramine, chlorine taste and odor, sediment	22049	Chloramine Carbon Block	Under Sink	2-1/2" x 10"	1 Micron	1 GPM	1	-/20	BULK		36.44
	22050	Chloramine Carbon Block	Household	2-1/2" x 20"	1 Micron	8 GPM	1	-/20	BULK		84.60
	22051	Chloramine Carbon Block	Household	4-1/2" x 10"	5 Micron	10 GPM	1	-/9	BULK		127.96
	22052	Chloramine Carbon Block	Household	4-1/2" x 20"	5 Micron	10 GPM	1	-/9	BULK		255.73
Sediment, rust, dirt, sand and suspended particles	22030	String Wound	Household	2-1/2" x 10"	5 Micron	10 GPM	1	-/25	BULK		5.10
	22034	Grooved Melt-Blown	Household	2-1/2" x 10"	5 Micron	8 GPM	1	-/25	BULK		3.85
	22035	Melt-Blown	Household	2-1/2" x 20"	30 Micron	8 GPM	1	-/25	BULK		8.53
	22038	Pleated	Household/ Under Sink	2-1/2" x 10"	30 Micron	8 GPM	1	-/50	BULK		12.09
	22039	Pleated	Household	4-1/2" x 10"	30 Micron	8 GPM	1	-/18	BULK		21.36
	22040	Pleated	Household	2-1/2" x 20"	30 Micron	8 GPM	1	-/25	BULK		13.09
	22041 - <b>NEW!</b>	Pleated	Household	4-1/2" x 20"	30 Micron	8 GPM	1	-/9	BULK		19.16



# FILTER HOUSING INSTALLATION HARDWARE AND ACCESSORIES



PART #	DESCRIPTION	UNIT ORDER	INN/MAS	PACK	LIST
22068	Housing Bracket - Fits 22021 and 22023 Housings	1	-/20	BULK	<b>7.95</b>
22069	Housing Bracket - Fits 22025 Housing	1	-/20	BULK	<b>13.37</b>
22070	Housing Bracket - Fits 22022 and 22024 Housings	1	-/20	BULK	<b>28.20</b>
22071	Wrench - Fits 22020 and 22021 Housings	1	-/20	BULK	<b>6.93</b>
22072	Wrench - Fits 22025 Housing	1	-/20	BULK	<b>6.93</b>
22073	Wrench - Fits 22022 and 22024 Housings	1	-/20	BULK	<b>6.93</b>
22074	Replacement O-Rings for Filter Housings: (1) 4-1/2" and (2) 2-1/2" Rings	1	-/20	BAG	<b>6.24</b>

## REVERSE OSMOSIS DRINKING WATER FAUCET

**NEW**

- Stainless steel gooseneck spout with 360° swivel
- Includes 1/4" and 3/8" quick-connect fittings
- 9" Spout height
- 4-1/2" Spout reach
- 1 GPM flow rate
- ABS body, stainless steel spout, zinc handle, with air gap
- 1-1/2" Base



PART #	DESCRIPTION	UNIT ORDER	INN/MAS	PACK	LIST
22100	Chrome	1	-/6	BOX	<b>30.79</b>
22101	Brushed Nickel	1	-/6	BOX	<b>39.35</b>

## MODERN-STYLE DRINKING WATER FAUCET

**NEW**

- Stainless steel gooseneck spout with 360° swivel
- Includes 1/4" and 3/8" quick-connect fittings
- 9-1/2" Spout height
- 5" Spout reach
- 1 GPM flow rate
- Zinc body, stainless steel spout, zinc handle, without air gap
- 1-3/4" Base



PART #	DESCRIPTION	UNIT ORDER	INN/MAS	PACK	LIST
22108	Chrome	1	-/6	BOX	<b>41.71</b>
22109	Brushed Nickel	1	-/6	BOX	<b>53.60</b>

## CONTEMPORARY-STYLE DRINKING WATER FAUCET

**NEW**

- Stainless steel gooseneck spout with 360° swivel
- Includes 1/4" and 3/8" quick-connect fittings
- 10-1/2" Spout height
- 5" Spout reach
- 1 GPM flow rate
- ABS body, stainless steel spout, zinc handle, without air gap
- 1-1/2" Base



PART #	DESCRIPTION	UNIT ORDER	INN/MAS	PACK	LIST
22104	Chrome	1	-/6	BOX	<b>30.65</b>
22105	Brushed Nickel	1	-/6	BOX	<b>39.20</b>

Supply Connectors

Stop Valves

Water Heater

Gas Connectors

Water Filtration

Sinks/ Faucets

Tubular/ Drainage

Faucet Repair

Bath Accessories

Pipe Fittings/ Repair

Valves

Cements/ Sealants

Tools/ Safety

Toilet Repair

Appliance/ HVAC

Hardware

Electrical

Index

# WATER FILTRATION

## Push-Fit Fittings

### MALE ADAPTER

- No lead non-toxic
- Works with copper, CPVC and PEX
- No tools required
- Removable and reusable without damage to plumbing or fittings
- No risk of flame or fire form a blowtorch



PART #	DESCRIPTION	UNIT ORDER	INN/MAS	PACK	LIST
84058	1/4" OD x 1/8" MIP	10	400/800	BULK	1.88
84059	1/4" OD x 1/4" MIP	10	400/800	BULK	1.91
84060	1/4" OD x 3/8" MIP	10	300/600	BULK	1.94
84089	3/8" OD x 1/4" MIP	10	200/400	BULK	2.97
84090	3/8" OD x 3/8" MIP	10	200/400	BULK	3.11
84091	3/8" OD x 1/2" MIP	10	150/300	BULK	3.34

### COUPLING

- No lead non-toxic
- Works with copper, CPVC and PEX
- No tools required
- Removable and reusable without damage to plumbing or fittings
- No risk of flame or fire form a blowtorch



PART #	DESCRIPTION	UNIT ORDER	INN/MAS	PACK	LIST
84042	1/4" OD	10	350/700	BULK	2.20
84049	3/8" OD x 1/4" OD	10	150/300	BULK	2.97
84050	3/8" OD	10	150/300	BULK	3.31

### TEE

- No lead non-toxic
- Works with copper, CPVC and PEX
- No tools required
- Removable and reusable without damage to plumbing or fittings
- No risk of flame or fire form a blowtorch



PART #	DESCRIPTION	UNIT ORDER	INN/MAS	PACK	LIST
84052	1/4" OD	10	200/400	BULK	3.19
84053	3/8" OD	10	100/200	BULK	4.02

### STRAIGHT VALVE

- No lead non-toxic
- Works with copper, CPVC and PEX
- No tools required
- Removable and reusable without damage to plumbing or fittings
- No risk of flame or fire from a blowtorch



PART #	DESCRIPTION	UNIT ORDER	INN/MAS	PACK	LIST
84038	1/4" OD x 1/4" MIP	10	80/160	BULK	9.98
84039	3/8" OD x 3/8" MIP	10	50/100	BULK	10.75

### STRAIGHT VALVE

- No lead non-toxic
- Works with copper, CPVC and PEX
- No tools required
- Removable and reusable without damage to plumbing or fittings
- No risk of flame or fire form a blowtorch



PART #	DESCRIPTION	UNIT ORDER	INN/MAS	PACK	LIST
84040	1/4" OD x 1/4" OD	10	100/200	BULK	9.89
84041	3/8" OD x 3/8" OD	10	50/100	BULK	10.49

### STRAIGHT VALVE

- No lead non-toxic
- Works with copper, CPVC and PEX
- No tools required
- Removable and reusable without damage to plumbing or fittings
- No risk of flame or fire form a blowtorch



PART #	DESCRIPTION	UNIT ORDER	INN/MAS	PACK	LIST
84008	3/8" OD x 1/2" FIP	5	80/100	BULK	15.65

### FEMALE ADAPTER

- Works with copper, CPVC and PEX
- Removable and reusable without damage to plumbing or fittings
- No risk of flame or fire from a blowtorch
- No tools required
- No lead, non-toxic



PART #	DESCRIPTION	UNIT ORDER	INN/MAS	PACK	LIST
84043	1/4" OD x 1/4" Female Comp	10	600/2400	BAG	2.22
84044	3/8" OD x 1/4" Female Comp	10	500/2000	BAG	3.56



## Push-Fit Fittings

### MALE ELBOW

- No lead non-toxic
- Works with copper, CPVC and PEX
- No tools required
- Removable and reusable without damage to plumbing or fittings
- No risk of flame or fire from a blowtorch



PART #	DESCRIPTION	UNIT ORDER	INN/MAS	PACK	LIST
84094	1/4" OD x 1/8" MIP	10	400/800	BULK	1.94
84095	1/4" OD x 1/4" MIP	10	300/600	BULK	2.02
84096	1/4" OD x 3/8" MIP	10	180/360	BULK	2.00
84097	3/8" OD x 1/4" MIP	10	200/400	BULK	2.85
84098	3/8" OD x 3/8" MIP	10	150/300	BULK	4.33

### ELBOW

- No lead non-toxic
- Works with copper, CPVC and PEX
- No tools required
- Removable and reusable without damage to plumbing or fittings
- No risk of flame or fire from a blowtorch



PART #	DESCRIPTION	UNIT ORDER	INN/MAS	PACK	LIST
84055	1/4" OD	10	350/700	BULK	2.20
84056	3/8" OD	10	150/300	BULK	3.65

### ADD-AN-OUTLET VALVE

- Screws onto existing stop valve
- Provides outlet for icemaker or dishwasher
- No tools required
- No lead, non-toxic
- 3/8" OD female compression thread inlet
- 3/8" OD comp male thread outlet
- 3/8" OD or 1/4" OD push-fit outlet

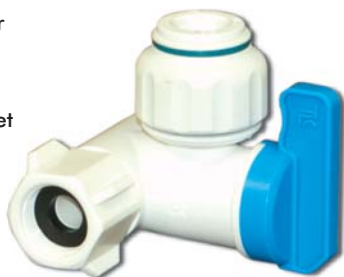

PART #	DESCRIPTION	UNIT ORDER	INN/MAS	PACK	LIST
84048	3/8" x 3/8" x 1/4" OD	5	400/800	BAG	13.54
84045	3/8" x 3/8" x 3/8" OD	5	300/600	BAG	14.11

### ADD-AN-OUTLET VALVE

- Works with copper, CPVC and PEX
- Removable and reusable without damage to plumbing or fittings
- No risk of flame or fire from a blowtorch
- No tools required
- No lead, non-toxic



PART #	DESCRIPTION	UNIT ORDER	INN/MAS	PACK	LIST
84046	1/2" FIP x 1/2" MIP x 1/4" OD	5	200/400	BAG	14.97
84047	1/2" FIP x 1/2" MIP x 3/8" OD	1	200/400	BAG	15.82

### PUSH-FIT STOP VALVE TEE ADAPTER

- Connection system for CPVC or PEX pipe
- No soldering required
- Converts existing straight or angle supply stops into dual-outlet stops
- Push-fit connections make it easy to run supply lines to icemakers, dishwashers, faucets, toilets and other small diameter appliances
- Chrome-plated brass



PART #	DESCRIPTION	UNIT ORDER	INN/MAS	PACK	LIST
75022	1/4" Push-Fit x 1/4" Push-Fit x 3/8" Comp	1	12/48	BAG	11.40

### PEX TUBING

- Gray

**NEW**



PART #	DESCRIPTION	UNIT ORDER	INN/MAS	PACK	LIST
86089	1/8" ID (1/4" OD) x 15' Length	1	-/25	BULK	10.75
86090	1/8" ID (1/4" OD) x 25' Length	1	-/25	BULK	13.39

Supply Connectors

Stop Valves

Water Heater

Gas Connectors

Water Filtration

Sinks/Faucets

Tubular/Drainage

Faucet Repair

Bath Accessories

Pipe Fittings/Repair

Valves

Cements/Sealants

Tools/Safety

Toilet Repair

Appliance/HVAC

Hardware

Electrical

Index

# SINKS

## Vitreous China Sinks

### VITREOUS CHINA DROP-IN SINK

- White



17" x 20"



PART #	DESCRIPTION	UNIT ORDER	INN/MAS	PACK	LIST
34006	Oval	1	-/1	BOX	48.13

### VITREOUS CHINA DROP-IN SINK

- White



PART #	DESCRIPTION	UNIT ORDER	INN/MAS	PACK	LIST
34007	19" Round	1	-/1	BOX	48.13

### UNDERMOUNT LAVATORY 17" X 14" OVAL WHITE

- White



17" x 14"



PART #	DESCRIPTION	UNIT ORDER	INN/MAS	PACK	LIST
34008	Oval	1	-/1	BOX	68.09

## Stainless Steel Sinks

### DOUBLE-BOWL STAINLESS STEEL KITCHEN SINK

- 23 Gauge
- Extra deep ledges
- Ultra Quiet™ sound deadening pads
- Reinforced Safe-T Rim - rolled edges for safety and durability
- One piece drawing - no welding & no center seam
- Satin finish
- 10-Year warranty



33" x 22" x 6" Deep



PART #	DESCRIPTION	UNIT ORDER	INN/MAS	PACK	LIST
86100	4-Hole	1	-/1	BOX	105.52
86110	3-Hole	1	-/1	BOX	125.03

### DOUBLE-BOWL STAINLESS STEEL KITCHEN SINK

- 22 Gauge
- Extra deep ledges
- Ultra Quiet™ sound deadening pads
- Reinforced Safe-T Rim - rolled edges for safety and durability
- One piece drawing - no welding & no center seam
- 10-Year warranty
- Satin finish



33" x 22" x 6-1/2" Deep



PART #	DESCRIPTION	UNIT ORDER	INN/MAS	PACK	LIST
86102	4-Hole	1	-/1	BOX	169.65
86111	3-Hole	1	-/1	BOX	167.57

## Stainless Steel Sinks

### DOUBLE-BOWL STAINLESS STEEL KITCHEN SINK

- 20 Gauge
- Extra deep ledges
- Ultra Quiet™ sound deadening pads
- Reinforced Safe-T Rim - rolled edges for safety and durability
- One piece drawing - no welding & no center seam
- Satin finish
- 15-Year warranty



33" x 22" x 8" Deep



PART #	DESCRIPTION	UNIT ORDER	INN/MAS	PACK	LIST
86103	4-Hole	1	-/1	BOX	228.10

### DOUBLE-BOWL STAINLESS STEEL KITCHEN SINK

- 20 Gauge
- Extra deep ledges
- Ultra Quiet™ sound deadening pads
- Reinforced Safe-T Rim - rolled edges for safety and durability
- One piece drawing - no welding & no center seam
- Gloss finish
- 15-Year warranty



33" x 22" x 8" Deep



PART #	DESCRIPTION	UNIT ORDER	INN/MAS	PACK	LIST
86104	4-Hole	1	-/1	BOX	278.93

### SINGLE-BOWL STAINLESS STEEL BAR SINK

- 23 Gauge
- Extra deep ledges
- Ultra Quiet™ sound deadening pads
- Reinforced Safe-T Rim - rolled edges for safety and durability
- One piece drawing - no welding & no center seam
- 15-Year warranty
- Satin finish



15" x 15" x 6" Deep



PART #	DESCRIPTION	UNIT ORDER	INN/MAS	PACK	LIST
86105	2-Hole	1	-/1	BOX	110.23

### SINGLE-BOWL STAINLESS STEEL KITCHEN SINK

- 22 Gauge
- Extra deep ledges
- Ultra Quiet™ sound deadening pads
- Reinforced Safe-T Rim - rolled edges for safety and durability
- One piece drawing - no welding & no center seam
- 10-Year warranty
- Satin finish



25" x 22" x 6" Deep



PART #	DESCRIPTION	UNIT ORDER	INN/MAS	PACK	LIST
86101	4-Hole	1	-/1	BOX	104.90

Supply Connectors

Stop Valves

Water Heater

Gas Connectors

Water Filtration

Sinks/ Faucets

Tubular/ Drainage

Faucet Repair

Bath Accessories

Pipe Fittings/ Repair

Valves

Cements/ Sealants

Tools/ Safety

Toilet Repair

Appliance/ HVAC

Hardware

Electrical

Index

# METRO COLLECTION

- Limited Lifetime Warranty
- Ceramic Disc

**NEW**



**4" Lavatory Faucet**  
50/50 Pop-up



PART #	DESCRIPTION	UNIT ORDER	INN/MAS	PACK	APPROVALS	LIST
10679	Chrome	1	-/6	BOX		<b>111.12</b>
10681	Brushed Nickel	1	-/6	BOX		<b>123.51</b>



**Kitchen Faucet Pull-Down Spray**

Single-hole or 3-hole mount - cover plate included

PART #	DESCRIPTION	UNIT ORDER	INN/MAS	PACK	APPROVALS	LIST
10683	Chrome	1	-/6	BOX		<b>155.57</b>
10685	Brushed Nickel	1	-/6	BOX		<b>171.02</b>



**Lavatory Faucet**

Single-hole or 3-hole mount - cover plate included - 50/50 pop-up



PART #	DESCRIPTION	UNIT ORDER	INN/MAS	PACK	APPROVALS	LIST
10667	Chrome	1	-/6	BOX		<b>114.64</b>
10669	Brushed Nickel	1	-/6	BOX		<b>129.29</b>



**Pre-Rinse Kitchen Faucet**

Lead-free brass waterway - single-hole or 3-hole mount - optional deck plate

PART #	DESCRIPTION	UNIT ORDER	INN/MAS	PACK	APPROVALS	LIST
10687	Chrome	1	-/6	BOX		<b>230.25</b>



**Lavatory Faucet**

6"-12" Widespread - 50/50 pop-up



PART #	DESCRIPTION	UNIT ORDER	INN/MAS	PACK	APPROVALS	LIST
10671	Chrome	1	-/6	BOX		<b>144.06</b>
10673	Brushed Nickel	1	-/6	BOX		<b>161.38</b>



**Kitchen Faucet Pull-Down Spray**

Single-hole or 3-hole mount - includes cover plate

PART #	DESCRIPTION	UNIT ORDER	INN/MAS	PACK	APPROVALS	LIST
10663	Chrome	1	-/6	BOX		<b>162.16</b>
10665	Brushed Nickel	1	-/6	BOX		<b>178.28</b>



• Fits valve 10572

**Single-Handle Tub & Shower Trim Kit**

1 Setting 6" shower head - slip-on diverter



PART #	DESCRIPTION	UNIT ORDER	INN/MAS	PACK	APPROVALS	LIST
10675	Chrome	1	-/6	BOX		<b>94.32</b>
10677	Brushed Nickel	1	-/6	BOX		<b>114.00</b>

LEAD-FREE Items Comply With Low-Lead Plumbing Law

# METRO COLLECTION

- Limited Lifetime Warranty
- Ceramic Disc
- Brass Bodies



### Kitchen Faucet Pull-Down Spray

Single-hole or 3-hole mount - Includes cover plate

PART #	DESCRIPTION	UNIT ORDER	INN/MAS	PACK	APPROVALS	LIST
*10300	Chrome	1	-/6	BOX		<b>215.04</b>
*10301	Brushed Nickel	1	-/6	BOX		<b>241.36</b>

*\*While Supplies Last*



### Lavatory Faucet

6"-12" Widespread mount



PART #	DESCRIPTION	UNIT ORDER	INN/MAS	PACK	APPROVALS	LIST
*10305	Chrome - With Brass Pop-Up	1	-/6	BOX		<b>266.50</b>

*\*While Supplies Last*

EZ-FLO FAUCETS



### Lavatory Vessel Faucet

Single-hole mount - 12" height - 6-3/4" spout height



PART #	DESCRIPTION	UNIT ORDER	INN/MAS	PACK	APPROVALS	LIST
*10304	Chrome - With Brass Grid Strainer	1	-/6	BOX		<b>240.22</b>

*\*While Supplies Last*



### Lavatory Faucet

Single-hole or 3-hole mount - 7-1/4" height cover plate included



PART #	DESCRIPTION	UNIT ORDER	INN/MAS	PACK	APPROVALS	LIST
*10303	Chrome - With Brass Pop-Up	1	-/6	BOX		<b>209.71</b>

*\*While Supplies Last*



**Includes:**  
Shower head, shower arm and slip-on tub spout

### Tub & Shower Set with Pressure Balance Valve

PART #	DESCRIPTION	UNIT ORDER	INN/MAS	PACK	APPROVALS	LIST
*10306	Chrome	1	-/6	BOX		<b>185.68</b>

*\*While Supplies Last*

Items Comply With Low-Lead Plumbing Law



# TUSCANY COLLECTION

- Limited Lifetime Warranty
- Ceramic Disc
- Hybrid Faucets



**NEW**



10691 - Brushed Nickel

**4" Lavatory**

Ceramic disc - 50/50 pop-up



PART #	DESCRIPTION	UNIT ORDER	INN/MAS	PACK	APPROVALS	LIST
10689	Chrome	1	-/6	BOX		<b>95.59</b>
10691	Brushed Nickel	1	-/6	BOX		<b>108.52</b>



**Two-Handle Kitchen with Matching Side Spray**

Ceramic disc cartridge

PART #	DESCRIPTION	UNIT ORDER	INN/MAS	PACK	APPROVALS	LIST
10697	Chrome	1	-/6	BOX		<b>96.99</b>
10699	Brushed Nickel	1	-/6	BOX		<b>108.55</b>



**Two-Handle Widespread Lavatory**

6"-12" Spread - ceramic disc - 50/50 pop-up



PART #	DESCRIPTION	UNIT ORDER	INN/MAS	PACK	APPROVALS	LIST
10693	Chrome	1	-/6	BOX		<b>138.62</b>
10695	Brushed Nickel	1	-/6	BOX		<b>152.87</b>



**Single-Handle Kitchen with Pull-Down Spray**

Single-hole or 3-hole mount - cover plate included - ceramic disc

PART #	DESCRIPTION	UNIT ORDER	INN/MAS	PACK	APPROVALS	LIST
10701	Chrome	1	-/6	BOX		<b>188.93</b>
10703	Brushed Nickel	1	-/6	BOX		<b>211.97</b>



- Fits valve 10572

**Single-Handle Tub & Shower Trim Kit**

Metal lever handle - slip-on diverter spout



PART #	DESCRIPTION	UNIT ORDER	INN/MAS	PACK	APPROVALS	LIST
10705	Chrome	1	-/6	BOX		<b>103.62</b>
10707	Brushed Nickel	1	-/6	BOX		<b>120.73</b>

LEAD-FREE Items Comply With Low-Lead Plumbing Law

EZ-FLO FAUCETS

# TUSCANY COLLECTION

- Limited Lifetime Warranty
- Ceramic Disc
- Hybrid Faucets



LEAD-FREE



**Single-Handle Kitchen Faucet**  
Ceramic Disc - Single-hole or 3-hole mount - Includes cover plate

PART #	DESCRIPTION	UNIT ORDER	INN/MAS	PACK	APPROVALS	LIST
*10378	Chrome - Less Spray	1	-/12	BOX		<b>84.39</b>
*10380	Chrome - With Spray	1	-/12	BOX		<b>97.39</b>
*10379	Brushed Nickel - Less Spray	1	-/12	BOX		<b>97.39</b>
*10381	Brushed Nickel - With Spray	1	-/12	BOX		<b>113.33</b>

*\*While Supplies Last*

**Pull-Out Spray Kitchen Faucet**  
Ceramic Disc - Single-hole or 3-hole mount - Includes cover plate

PART #	DESCRIPTION	UNIT ORDER	INN/MAS	PACK	APPROVALS	LIST
*10382	Chrome	1	-/12	BOX		<b>141.02</b>
*10383	Brushed Nickel	1	-/12	BOX		<b>159.67</b>

*\*While Supplies Last*



**Single-Handle Lavatory Faucet**  
Ceramic Disc - With 50/50 Pop-Up



PART #	DESCRIPTION	UNIT ORDER	INN/MAS	PACK	APPROVALS	LIST
*10372	Chrome	1	-/12	BOX		<b>84.53</b>
*10373	Brushed Nickel	1	-/12	BOX		<b>96.91</b>

*\*While Supplies Last*

**Two-Handle Lavatory Faucet**  
Ceramic Disc - With 50/50 Pop-Up



PART #	DESCRIPTION	UNIT ORDER	INN/MAS	PACK	APPROVALS	LIST
*10376	Chrome	1	-/12	BOX		<b>74.24</b>
*10377	Brushed Nickel	1	-/12	BOX		<b>96.86</b>

*\*While Supplies Last*



Supply Connectors

Stop Valves

Water Heater

Gas Connectors

Water Filtration

Sinks/ Faucets

Tubular/ Drainage

Faucet Repair

Bath Accessories

Pipe Fittings/ Repair

Valves

Cements/ Sealants

Tools/ Safety

Toilet Repair

Appliance/ HVAC

Hardware

Electrical

Index

# STERLING COLLECTION

- Limited Lifetime Warranty
- Ceramic Disc
- Hybrid Faucets



COMPLIES WITH NSF-61

**NEW**



**4" Lavatory**

Ceramic disc - 50/50 pop-up



PART #	DESCRIPTION	UNIT ORDER	INN/MAS	PACK	APPROVALS	LIST
10709	Chrome	1	-/6	BOX		<b>93.62</b>
10711	Brushed Nickel	1	-/6	BOX		<b>108.52</b>



**Two-Handle Kitchen with Matching Side Spray**

High-rise spout - ceramic disc

PART #	DESCRIPTION	UNIT ORDER	INN/MAS	PACK	APPROVALS	LIST
10717	Chrome	1	-/6	BOX		<b>101.03</b>
10719	Brushed Nickel	1	-/6	BOX		<b>111.97</b>



**Two-Handle Widespread Lavatory**

6"-12" Spread - ceramic disc - 50/50 pop-up



PART #	DESCRIPTION	UNIT ORDER	INN/MAS	PACK	APPROVALS	LIST
10713	Chrome	1	-/6	BOX		<b>139.08</b>
10715	Brushed Nickel	1	-/6	BOX		<b>158.16</b>



**Single-Handle Kitchen Pull-Down Spray**

Single-hole or 3-hole mount - cover plate included - ceramic disc

PART #	DESCRIPTION	UNIT ORDER	INN/MAS	PACK	APPROVALS	LIST
10721	Chrome	1	-/6	BOX		<b>162.10</b>
10723	Brushed Nickel	1	-/6	BOX		<b>181.41</b>



• Fits valve 10572

**Single-Handle Tub & Shower Trim Kit**

Metal lever handle - slip-on diverter spout



PART #	DESCRIPTION	UNIT ORDER	INN/MAS	PACK	APPROVALS	LIST
10725	Chrome	1	-/6	BOX		<b>89.06</b>
10726	Brushed Nickel	1	-/6	BOX		<b>106.22</b>

LEAD-FREE Items Comply With Low-Lead Plumbing Law

EZ-FLO FAUCETS



# STERLING COLLECTION

- Limited Lifetime Warranty
- Ceramic Disc
- Hybrid Faucets



COMPLIES WITH NSF-61



**Pull-Down Spray Kitchen Faucet Ceramic Disc**  
Single-hole or 3-hole mount. Cover plate included

PART #	DESCRIPTION	UNIT ORDER	INN/MAS	PACK	APPROVALS	LIST
10388	Chrome	1	-/6	BOX	NSF-61	<b>138.21</b>



**Pull-Down Spray Kitchen Faucet Ceramic Disc**  
Single-hole or 3-hole mount. Cover plate included

PART #	DESCRIPTION	UNIT ORDER	INN/MAS	PACK	APPROVALS	LIST
10389	Brushed Nickel	1	-/6	BOX	NSF-61	<b>183.96</b>



**Chrome Two-Handle Lavatory Faucet Ceramic Disc**  
4" Centers



PART #	DESCRIPTION	UNIT ORDER	INN/MAS	PACK	APPROVALS	LIST
*10392	Less Pop-Up	1	-/6	BOX	NSF-61	<b>104.21</b>
*10393	With 50/50 Pop-Up	1	-/6	BOX	NSF-61	<b>119.98</b>

*\*While Supplies Last*



**Brushed Nickel Two-Handle Lavatory Faucet Ceramic Disc** -  
4" Centers



PART #	DESCRIPTION	UNIT ORDER	INN/MAS	PACK	APPROVALS	LIST
*10394	Less Pop-Up	1	-/6	BOX	NSF-61	<b>112.88</b>
*10395	With 50/50 Pop-Up	1	-/6	BOX	NSF-61	<b>130.33</b>

*\*While Supplies Last*



**Chrome Two-Handle Widespread Lavatory Faucet Ceramic Disc** - 8" Widespread



PART #	DESCRIPTION	UNIT ORDER	INN/MAS	PACK	APPROVALS	LIST
*10396	Less Pop-Up	1	-/6	BOX	NSF-61	<b>122.57</b>
*10397	With 50/50 Pop-Up	1	-/6	BOX	NSF-61	<b>138.60</b>

*\*While Supplies Last*

EZ-FLO FAUCETS



**Brushed Nickel Two-Handle Widespread Lavatory Faucet Ceramic Disc** - 8" Widespread



PART #	DESCRIPTION	UNIT ORDER	INN/MAS	PACK	APPROVALS	LIST
*10398	Less Pop-Up	1	-/6	BOX	NSF-61	<b>147.98</b>
*10399	With 50/50 Pop-Up	1	-/6	BOX	NSF-61	<b>153.94</b>

*\*While Supplies Last*

Items Comply With Low-Lead Plumbing Law

Supply Connectors

Stop Valves

Water Heater

Gas Connectors

Water Filtration

Sinks/ Faucets

Tubular/ Drainage

Faucet Repair

Bath Accessories

Pipe Fittings/ Repair

Valves

Cements/ Sealants

Tools/ Safety

Toilet Repair

Appliance/ HVAC

Hardware

Electrical

Index

# IMPRESSIONS COLLECTION

**NEW**



- Fits valve 10572

**Single-Handle Tub and Shower Trim Kit**  
Metal lever handle - slip-on diverter spout

PART #	DESCRIPTION	UNIT ORDER	INN/MAS	PACK	APPROVALS	LIST
10575	Chrome	1	-/6	BOX		<b>64.52</b>
10573	Brushed Nickel	1	-/6	BOX		<b>74.05</b>

- Ceramic disc
- High-performance anti-scald pressure balance valve
- Washerless cartridge
- Integral stops
- **Works with all trim kits**

**VersiTech Valve**

PART #	DESCRIPTION	UNIT ORDER	INN/MAS	PACK	APPROVALS	LIST
10572	1/2" MIP or Sweat	1	-/6	BOX		<b>80.48</b>



- Slip-on diverter spout
- Brass shower arm
- Fits 10207 valve

**Tub & Shower Trim Kit**  
Fits 10207 valve

PART #	DESCRIPTION	UNIT ORDER	INN/MAS	PACK	APPROVALS	LIST
*10205	Chrome	1	-/6	BOX		<b>60.42</b>
*10206	Brushed Nickel	1	-/6	BOX		<b>78.55</b>

*\*While Supplies Last*

- Brass body
- Integral stops
- 1/2" FIP inlets

**Pressure Balance Shower Valve**  
Integral Stops - Fits 10205 & 10206 trim

PART #	DESCRIPTION	UNIT ORDER	INN/MAS	PACK	APPROVALS	LIST
*10207	1/2" FIP	1	-/6	BOX		<b>97.45</b>

*\*While Supplies Last*

# IMPRESSIONS COLLECTION

- Limited Lifetime Warranty
- Ceramic Disc



### Kitchen Faucet Pull-Out Spray

Single-hole or 3-hole mount - cover plate included

PART #	DESCRIPTION	UNIT ORDER	INN/MAS	PACK	APPROVALS	LIST
10203	Chrome	1	-/6	BOX		<b>158.10</b>
10204	Brushed Nickel	1	-/6	BOX		<b>170.08</b>



### Two-Handle Kitchen Faucet

High-rise spout

PART #	DESCRIPTION	UNIT ORDER	INN/MAS	PACK	APPROVALS	LIST
10189	Chrome - Less Spray	1	-/6	BOX		<b>74.64</b>
10201	Chrome - With Spray	1	-/6	BOX		<b>85.39</b>
10199	Brushed Nickel - Less Spray	1	-/6	BOX		<b>81.89</b>
10202	Brushed Nickel - With Spray	1	-/6	BOX		<b>94.80</b>



### Two-Handle Lavatory Faucet

50/50 Pop-up

PART #	DESCRIPTION	UNIT ORDER	INN/MAS	PACK	APPROVALS	LIST
10190	Chrome	1	-/6	BOX		<b>88.05</b>
10191	Brushed Nickel	1	-/6	BOX		<b>99.36</b>



### Two-Handle Kitchen Faucet

With spray

PART #	DESCRIPTION	UNIT ORDER	INN/MAS	PACK	APPROVALS	LIST
*10198	Chrome	1	-/6	BOX		<b>89.81</b>
*10200	Brushed Nickel	1	-/6	BOX		<b>101.65</b>

\*While Supplies Last

EZ-FLO FAUCETS



### Two-Handle Widespread Lavatory

6"- 12" Widespread mount - 50/50 pop-up

PART #	DESCRIPTION	UNIT ORDER	INN/MAS	PACK	APPROVALS	LIST
10192	Chrome	1	-/6	BOX		<b>186.90</b>
10193	Brushed Nickel	1	-/6	BOX		<b>199.11</b>



Items Comply With Low-Lead Plumbing Law LEAD-FREE

Supply Connectors

Stop Valves

Water Heater

Gas Connectors

Water Filtration

Sinks/ Faucets

Tubular/ Drainage

Faucet Repair

Bath Accessories

Pipe Fittings/ Repair

Valves

Cements/ Sealants

Tools/ Safety

Toilet Repair

Appliance/ HVAC

Hardware

Electrical

Index

Genuine **EZ-FLO** Faucets

# PRESTIGE

## COLLECTION

Our most popular collection, these faucets feature lead-free compliant models and quality workmanship. Designed with round edges, these faucets offer a modern look at an affordable price. Featuring ceramic disc and washerless functionality with popular repair parts, these faucets are a perfect upgrade to any room.



# PRESTIGE COLLECTION

• Limited Lifetime Warranty



Pull-Out Spray

**Pull-Out Spray Kitchen Faucet Ceramic Disc** - Single-hole or 3-hole mount - Cover plate included

*PART #	DESCRIPTION	UNIT ORDER	INN/MAS	PACK	APPROVALS	LIST
10036LF	Brushed Nickel Loop Handle	1	-/6	BOX		<b>170.73</b>

*\*While Supplies Last*



Pull-Out Spray

**Pull-Out Spray Kitchen Faucet Ceramic Disc** - Single-hole or 3-hole mount - Cover plate included

PART #	DESCRIPTION	UNIT ORDER	INN/MAS	PACK	APPROVALS	LIST
10077LF	Chrome Loop Handle	1	-/6	BOX		<b>163.95</b>

*\*While Supplies Last*



**Single-Handle Kitchen Faucet Washerless**

PART #	DESCRIPTION	UNIT ORDER	INN/MAS	PACK	APPROVALS	LIST
10072LF	Chrome - Solid Handle - Less Spray	1	-/6	BOX		<b>70.91</b>
10074LF	Chrome - Solid Handle - With Black Spray	1	-/6	BOX		<b>88.05</b>
10029LF	Brushed Nickel - Solid Handle - Less Spray	1	-/6	BOX		<b>76.68</b>
10030LF	Brushed Nickel - Solid Handle - With Black Spray	1	-/6	BOX		<b>102.22</b>



Pull-Out Spray

**Kitchen Faucet Pull-Out Spray Ceramic Disc** - Single-hole or 3-hole mount - Cover plate included

PART #	DESCRIPTION	UNIT ORDER	INN/MAS	PACK	APPROVALS	LIST
10307	Chrome Solid Handle	1	-/6	BOX		<b>158.50</b>
10308	Brushed Nickel Solid Handle	1	-/6	BOX		<b>175.35</b>



**Single-Handle Kitchen Faucet Washerless**

PART #	DESCRIPTION	UNIT ORDER	INN/MAS	PACK	APPROVALS	LIST
10076LF	Chrome - Loop Handle - Less Spray	1	-/6	BOX		<b>73.42</b>
10075LF	Chrome - Loop Handle - With Spray	1	-/12	BOX		<b>84.82</b>



**Two-Handle Kitchen Faucet Washerless** - Acrylic handles

PART #	DESCRIPTION	UNIT ORDER	INN/MAS	PACK	APPROVALS	LIST
10118LF	Chrome - Less Spray	1	-/6	BOX		<b>58.45</b>
10117LF	Chrome - With Spray	1	-/6	BOX		<b>69.43</b>

# PRESTIGE COLLECTION

• Limited Lifetime Warranty



**Two-Handle Lavatory Faucet Washerless -**  
Acrylic handles



PART #	DESCRIPTION	UNIT ORDER	INN/MAS	PACK	APPROVALS	LIST
10120LF	Chrome - Less Pop-Up	1	-/6	BOX		<b>49.75</b>
10119LF	Chrome - With 50/50 Pop-Up	1	-/6	BOX		<b>68.09</b>



**Single-Handle Lavatory Faucet Washerless -**  
Acrylic handle



PART #	DESCRIPTION	UNIT ORDER	INN/MAS	PACK	APPROVALS	LIST
10115LF	Chrome - Less Pop-Up	1	-/6	BOX		<b>56.74</b>
10116LF	Chrome - With 50/50 Pop-Up	1	-/6	BOX		<b>76.64</b>



**Single-Handle Lavatory Faucet Washerless**



PART #	DESCRIPTION	UNIT ORDER	INN/MAS	PACK	APPROVALS	LIST
10093LF	Chrome - Solid Handle - Less Pop-Up	1	-/12	BOX		<b>73.13</b>
10094LF	Chrome - Solid Handle - With 50/50 Pop-Up	1	-/12	BOX		<b>85.19</b>



**Single-Handle Lavatory Faucet Washerless**



PART #	DESCRIPTION	UNIT ORDER	INN/MAS	PACK	APPROVALS	LIST
10025LF	Brushed Nickel - Solid Handle - Less Pop-Up	1	-/6	BOX		<b>64.90</b>
10026LF	Brushed Nickel - Solid Handle - With 50/50 Pop-Up	1	-/6	BOX		<b>82.44</b>



**Single-Handle Lavatory Faucet Washerless**



PART #	DESCRIPTION	UNIT ORDER	INN/MAS	PACK	APPROVALS	LIST
10088LF	Chrome - Loop Handle - Less Pop-Up	1	-/12	BOX		<b>67.97</b>
*10089LF	Chrome - Loop Handle - With ABS Pop-Up	1	-/6	BOX		<b>76.64</b>
10090LF	Chrome - Loop Handle - With Brass Pop-Up	1	-/12	BOX		<b>85.25</b>

*\*While Supplies Last*

# PRESTIGE COLLECTION

• Limited Lifetime Warranty



**Decorative-Handle Lavatory Faucet Washerless**



PART #	DESCRIPTION	UNIT ORDER	INN/MAS	PACK	APPROVALS	LIST
*10287LF	Chrome - With Brass Pop-Up	1	-/1	BOX		<b>84.11</b>

*\*While Supplies Last*

**Decorative-Handle Lavatory Faucet Washerless -**  
White porcelain handles

PART #	DESCRIPTION	UNIT ORDER	INN/MAS	PACK	APPROVALS	LIST
10295LF	Chrome - With Brass Pop-Up	1	-/1	BOX		<b>96.14</b>



**Pressure Balance Valve Tub & Shower Set  
Ceramic Disc Cartridge**

- Brass valve
- 1/2" FIP inlet with sweat adapters
- Integral stops
- Slip-on tub spout, arm and flange
- Deluxe shower head

PART #	DESCRIPTION	UNIT ORDER	INN/MAS	PACK	APPROVALS	LIST
10066	Chrome	1	-/12	BOX		<b>180.57</b>

Supply Connectors

Stop Valves

Water Heater

Gas Connectors

Water Filtration

Sinks/ Faucets

Tubular/ Drainage

Faucet Repair

Bath Accessories

Pipe Fittings/ Repair

Valves

Cements/ Sealants

Tools/ Safety

Toilet Repair

Appliance/ HVAC

Hardware

Electrical

Index

# Traditional

## COLLECTION

Time-tested designs and functionality at an entry-level price point. Featuring washerless functionality with popular repair parts, these faucets offer easy installation and maintenance. Perfect for multifamily and new construction applications.





# TRADITIONAL COLLECTION

- Limited Lifetime Warranty
- Washerless & Ceramic Disc



### Two-Handle Kitchen Faucet Washerless -

Acrylic handles

PART #	DESCRIPTION	UNIT ORDER	INN/MAS	PACK	APPROVALS	LIST
10163LF	Chrome - Less Spray	1	-/12	BOX		<b>56.31</b>
10161LF	Chrome - With Black Spray	1	-/6	BOX		<b>68.09</b>



### Single-Handle Kitchen Faucet Washerless

PART #	DESCRIPTION	UNIT ORDER	INN/MAS	PACK	APPROVALS	LIST
10071LF	Chrome - Less Spray	1	-/12	BOX		<b>79.43</b>
10073LF	Chrome - With Spray	1	-/12	BOX		<b>85.31</b>



### Two-Handle Kitchen Faucet Washerless

PART #	DESCRIPTION	UNIT ORDER	INN/MAS	PACK	APPROVALS	LIST
10164LF	Chrome - Less Spray	1	-/6	BOX		<b>55.16</b>



### Decorative High-Rise Kitchen Faucet Washerless -

3 Handle inserts - chrome, white, oak

PART #	DESCRIPTION	UNIT ORDER	INN/MAS	PACK	APPROVALS	LIST
*10175LF	Chrome - Less Spray	1	-/12	BOX		<b>78.55</b>

\*While Supplies Last



### High-Rise Kitchen Faucet Washerless -

Acrylic handles

PART #	DESCRIPTION	UNIT ORDER	INN/MAS	PACK	APPROVALS	LIST
10178LF	Chrome - Less Spray	1	-/6	BOX		<b>72.36</b>
10177LF	Chrome - With Spray	1	-/6	BOX		<b>81.69</b>

Supply Connectors

Stop Valves

Water Heater

Gas Connectors

Water Filtration

Sinks/ Faucets

Tubular/ Drainage

Faucet Repair

Bath Accessories

Pipe Fittings/ Repair

Valves

Cements/ Sealants

Tools/ Safety

Toilet Repair

Appliance/ HVAC

Hardware

Electrical

Index

# TRADITIONAL COLLECTION

- Limited Lifetime Warranty
- Washerless & Ceramic Disc



**Single-Handle Lavatory Faucet Washerless**

PART #	DESCRIPTION	UNIT ORDER	INN/MAS	PACK	APPROVALS	LIST
10087LF	Chrome - Less Pop-Up	1	-/12	BOX		<b>61.90</b>
10086LF	Chrome - With 50/50 Pop-Up	1	-/12	BOX		<b>80.75</b>



**Two-Handle Lavatory Faucet Washerless - Acrylic handles**



PART #	DESCRIPTION	UNIT ORDER	INN/MAS	PACK	APPROVALS	LIST
10277LF	Chrome - Less Pop-Up	1	-/12	BOX		<b>52.75</b>
10273LF	Chrome - With 50/50 Pop-Up	1	-/6	BOX		<b>59.27</b>



**Two-Handle Lavatory Faucet Washerless**

PART #	DESCRIPTION	UNIT ORDER	INN/MAS	PACK	APPROVALS	LIST
10281LF	Chrome - Less Pop-Up	1	-/12	BOX		<b>50.98</b>
10282LF	Chrome - With 50/50 Pop-Up	1	-/12	BOX		<b>68.00</b>

# TRADITIONAL COLLECTION

- Limited Lifetime Warranty
- Washerless & Ceramic Disc



**Two-Handle Lavatory Faucet Washerless -**  
3 Handle inserts - chrome, white, oak

PART #	DESCRIPTION	UNIT ORDER	INN/MAS	PACK	APPROVALS	LIST
*10291LF	Chrome - Less Pop-Up	1	-/12	BOX		<b>64.15</b>

*\*While Supplies Last*



10046

10048

**Tub & Shower Set Washerless**

Includes washerless valve  
- 1/2" FIP with CxC adapters

PART #	DESCRIPTION	UNIT ORDER	INN/MAS	PACK	APPROVALS	LIST
10046	Chrome - Loop Handle	1	-/12	BOX		<b>95.18</b>
10048	Chrome - Acrylic Handle	1	-/12	BOX		<b>89.01</b>

Supply Connectors

Stop Valves

Water Heater

Gas Connectors

Water Filtration

Sinks/ Faucets

Tubular/ Drainage

Faucet Repair

Bath Accessories

Pipe Fittings/ Repair

Valves

Cements/ Sealants

Tools/ Safety

Toilet Repair

Appliance/ HVAC

Hardware

Electrical

Index



Genuine  Faucets

# Basic-N-Brass

## COLLECTION

A series of faucets offering the reliability of hybrid craftsmanship and the durability of a metal-deck faucet. Each faucet is designed for everyday basic use and offers an economic value.



# BASIC-N-BRASS COLLECTION

- Limited Lifetime Warranty
- Brass Stems & Seats



**Two-Handle Kitchen Faucet Washerless -**  
Metal handles

PART #	DESCRIPTION	UNIT ORDER	INN/MAS	PACK	APPROVALS	LIST
10181LF	Chrome - Less Spray	1	-/12	BOX		<b>58.76</b>

*\*While Supplies Last*



**High-Rise Kitchen Faucet Washerless -**  
Metal handles

PART #	DESCRIPTION	UNIT ORDER	INN/MAS	PACK	APPROVALS	LIST
10179LF	Chrome - Less Spray	1	-/12	BOX		<b>77.24</b>



**Two-Handle Laundry Faucet Washerless -**  
4" Centers - hose thread on spout

PART #	DESCRIPTION	UNIT ORDER	INN/MAS	PACK	APPROVALS	LIST
10891LF	Chrome	1	-/12	BOX		<b>48.90</b>



**Two-Handle Bar Faucet Washerless -**  
Metal handles

PART #	DESCRIPTION	UNIT ORDER	INN/MAS	PACK	APPROVALS	LIST
10328LF	Chrome - 6" Spout	1	-/12	BOX		<b>73.50</b>



**Glass Filler**  
1/4" OD compression inlet - brass body - self-closing - 1.5 GPM

PART #	DESCRIPTION	UNIT ORDER	INN/MAS	PACK	APPROVALS	LIST
10896LF	Chrome - Brass Construction	1	10/50	BOX		<b>33.04</b>

Supply Connectors

Stop Valves

Water Heater

Gas Connectors

Water Filtration

Sinks/ Faucets

Tubular/ Drainage

Faucet Repair

Bath Accessories

Pipe Fittings/ Repair

Valves

Cements/ Sealants

Tools/ Safety

Toilet Repair

Appliance/ HVAC

Hardware

Electrical

Index



# BASIC-N-BRASS COLLECTION

- Limited Lifetime Warranty
- Brass Stems & Seats



**Tub & Shower Set Compression -**  
Sayco style handles & parts

**Tub & Shower Set Compression -**  
Acrylic handles

PART #	DESCRIPTION	UNIT ORDER	INN/MAS	PACK	APPROVALS	LIST
10494N	Chrome - 3-Handle Tub & Shower	1	-/6	BOX		<b>148.92</b>
10491N	Chrome - 2-Handle Tub & Shower	1	-/6	BOX		<b>107.88</b>
10490N	Chrome - 2-Handle Shower Only	1	-/6	BOX		<b>98.44</b>
10497N	Compression 1-Handle Valve	1	-/24	BOX		<b>32.50</b>

PART #	DESCRIPTION	UNIT ORDER	INN/MAS	PACK	APPROVALS	LIST
*10772	Chrome - 3-Handle Tub & Shower	1	-/6	BOX		<b>138.72</b>
*10662	Chrome - 2-Handle Tub & Shower	1	-/6	BOX		<b>112.08</b>
*10562	Chrome - 2-Handle Shower Only	1	-/6	BOX		<b>103.47</b>

*\*While Supplies Last*



**Tub & Shower Set Compression -**  
Metal handles

PART #	DESCRIPTION	UNIT ORDER	INN/MAS	PACK	APPROVALS	LIST
10771	Chrome - 3-Handle Tub & Shower	1	-/6	BOX		<b>143.42</b>
10661	Chrome - 2-Handle Tub & Shower	1	-/6	BOX		<b>116.90</b>
10561	Chrome - 2-Handle Shower Only	1	-/6	BOX		<b>109.33</b>

# Nonmetallic

## COLLECTION



Nonmetallic Two-Handle Kitchen Faucet Washerless

PART #	DESCRIPTION	UNIT ORDER	INN/MAS	PACK	APPROVALS	LIST
10122	Less Spray	1	-/12	BAG		<b>22.61</b>
10123	With Spray	1	-/12	BAG		<b>30.96</b>



Nonmetallic Single-Handle Kitchen Faucet Washerless - 8" Spout

PART #	DESCRIPTION	UNIT ORDER	INN/MAS	PACK	APPROVALS	LIST
*10134	Chrome	1	-/24	BAG		<b>30.68</b>

*\*While Supplies Last*



Nonmetallic Two-Handle Kitchen Faucet Washerless

PART #	DESCRIPTION	UNIT ORDER	INN/MAS	PACK	APPROVALS	LIST
10125	With Spray	1	-/6	BAG		<b>39.06</b>
10130	Less Spray	1	-/24	BAG		<b>30.65</b>



Nonmetallic Two-Handle Kitchen Faucet Washerless - 8" Spout

PART #	DESCRIPTION	UNIT ORDER	INN/MAS	PACK	APPROVALS	LIST
10135	Chrome	1	-/24	BAG		<b>38.06</b>



Nonmetallic Pull-Out Spray Kitchen Faucet Ceramic Disc

PART #	DESCRIPTION	UNIT ORDER	INN/MAS	PACK	APPROVALS	LIST
10384	Chrome	1	-/12	BAG		<b>94.75</b>
10385	Brushed Nickel	1	-/12	BAG		<b>105.38</b>



Nonmetallic Two-Handle High-Rise Kitchen Faucet

PART #	DESCRIPTION	UNIT ORDER	INN/MAS	PACK	APPROVALS	LIST
10136	Less Spray	1	-/24	BAG		<b>41.51</b>
10137	With Spray	1	-/24	BAG		<b>52.46</b>

Supply Connectors

Stop Valves

Water Heater

Gas Connectors

Water Filtration

Sinks/ Faucets

Tubular/ Drainage

Faucet Repair

Bath Accessories

Pipe Fittings/ Repair

Valves

Cements/ Sealants

Tools/ Safety

Toilet Repair

Appliance/ HVAC

Hardware

Electrical

Index



# Nonmetallic

## COLLECTION



**Nonmetallic Two-Handle Lavatory Faucet Washerless**

PART #	DESCRIPTION	UNIT ORDER	INN/MAS	PACK	APPROVALS	LIST
10252	Less Pop-Up	1	-/12	BAG		17.91
10256N	With ABS Pop-Up	1	-/12	BAG		25.43



**Nonmetallic Two-Handle Lavatory Faucet Washerless**

PART #	DESCRIPTION	UNIT ORDER	INN/MAS	PACK	APPROVALS	LIST
10258	Less Pop-Up	1	-/12	BAG		30.71
10257	With ABS Pop-Up	1	-/12	BAG		38.46



**Nonmetallic Two-Handle Lavatory Faucet**

PART #	DESCRIPTION	UNIT ORDER	INN/MAS	PACK	APPROVALS	LIST
10259	Less Pop-Up	1	-/24	BAG		28.40
10260	With Pop-Up	1	-/24	BAG		34.70



## Wall-Mount Faucets

### WALL-MOUNT FAUCET - COMPRESSION

- Solid brass valve body and waterways
- Replaceable brass seats and stems
- Adjustable centers 6½" to 9½"
- Chrome



PART #	DESCRIPTION	ORDER QTY	INN/MAS	PACK	LIST
10142LF	6" Spout	1	-/24	BOX	93.96
10149LF	8" Spout	1	-/24	BOX	117.38

### WALL-MOUNT FAUCET

- Solid brass construction



PART#	DESCRIPTION	ORDER QTY.	INN/MAS	PACK	LIST
10997	1/2" MIP x 1/2" MHT	1	10/100	BOX	8.89

### WALL-MOUNT SERVICE FAUCET - COMPRESSION

- For commercial & food service applications
- Replaceable brass seats and stems
- Hose threads on spout
- Solid brass valve body and waterways
- Includes mounting hardware
- Chrome

\* NOT For Drinking Water



PART #	DESCRIPTION	ORDER QTY	INN/MAS	PACK	LIST
10361	Chrome	1	-/8	BOX	253.96

### SINGLE-BASIN FAUCET

- Solid brass construction
- Chrome finish
- 1/2" IPS inlet



PART#	DESCRIPTION	ORDER QTY.	INN/MAS	PACK	LIST
10796LF	5 GPM - With Hot and Cold Index Buttons	1	10/80	BOX	25.53
10895LF	Cold - Self-Closing	1	6/30	BOX	69.67

Supply Connectors

Stop Valves

Water Heater

Gas Connectors

Water Filtration

Sinks/ Faucets

Tubular/ Drainage

Faucet Repair

Bath Accessories

Pipe Fittings/ Repair

Valves

Cements/ Sealants

Tools/ Safety

Toilet Repair

Appliance/ HVAC

Hardware

Electrical

Index

# FAUCETS

## Specialty Faucets

### BUBBLER FAUCET WITH REPLACEABLE CARTRIDGE

- Replaces Hawes® & Central Brass®
- 3/8" IPS inlet
- Chrome-plated brass



10345LF



PART#	DESCRIPTION	ORDER QTY.	INN/MAS	PACK	LIST
10344LF	Heavy Brass Pattern	1	-/1	BOX	85.19
10343LF	Economy Pattern	1	-/30	BOX	54.11
10345LF	Bubbler Cartridge Universal	1	25/100	BOX	27.97

### DRINKING FOUNTAIN FAUCET

- Solid brass construction
- Chrome
- Self-closing bubbler faucet
- Adjustable water flow
- 1/2" IPS inlet



PART#	DESCRIPTION	ORDER QTY.	INN/MAS	PACK	LIST
10341LF	Drinking Fountain	1	-/24	BOX	67.66

### SELF-CLOSING PULL-CHAIN SHOWER VALVE

- Brass construction
- 1/2" FIP connections
- Chrome



PART#	DESCRIPTION	ORDER QTY.	INN/MAS	PACK	LIST
10789	Shower Valve	1	-/40	BOX	51.35

### SHOWER STALL VALVE

- Brass construction
- Fits on 3-3/8" centers
- Replaceable brass seats and stems
- 1/2" IPS inlet
- Metal handles
- Chrome



PART#	DESCRIPTION	ORDER QTY.	INN/MAS	PACK	LIST
10551	Shower Stall Valve	1	1/24	BOX	40.55

### SELF-CLOSING STOP VALVE

- Brass construction
- Can be used for urinals
- 1/2" IPS inlet & outlet
- Chrome



PART#	DESCRIPTION	ORDER QTY.	INN/MAS	PACK	LIST
10187LF	Stop Valve	1	1/40	BOX	56.83

## Soap/Lotion Dispensers

### LIQUID SOAP/LOTION DISPENSER

- All-brass pump mechanism
- 14 oz plastic reservoir bottle
- Chrome



PART #	DESCRIPTION	ORDER QTY	INN/MAS	PACK	LIST
10911	Dispenser	1	-/50	BOX	24.04

### LIQUID SOAP DISPENSER

**NEW**

- ABS head with deluxe PVD finish
- Easy to assemble
- 16 oz capacity



PART #	DESCRIPTION	ORDER QTY	INN/MAS	PACK	LIST
10914	Chrome	1	-/50	BOX	10.78
10915	Brushed Nickel	1	-/50	BOX	13.63

# VISIT US ONLINE!

[www.EZ-FLO.net](http://www.EZ-FLO.net)

Supply  
Connectors

Stop  
Valves

Water  
Heater

Gas  
Connectors

Water  
Filtration

Sinks/  
Faucets

Tubular/  
Drainage

Faucet  
Repair

Bath  
Accessories

Pipe Fittings/  
Repair

Valves

Cements/  
Sealants

Tools/  
Safety

Toilet  
Repair

Appliance/  
HVAC

Hardware

Electrical

Index

DISPLAY & PACKAGING

## SPINNER RACK DISPLAY

- Three-panel display rack stands 48" high
- Each display panel measures approximately 24" x 48"



## ACRYLIC MOUNTING DISPLAY BRACKETS

- Individual acrylic faucet display brackets

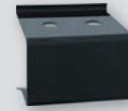

LAVATORY



KITCHEN



TUB & SHOWER

**\*Special stocking offer!**

**\*\$900.00  
VALUE...FREE!**

PART#	DESCRIPTION	ORDER QTY.	INN/MAS	PACK
Disp - 0160	3-Panel Faucet Display	1	-/1	BOX

PART#	DESCRIPTION	ORDER QTY.	INN/MAS	PACK
Disp - 0156	4" Lavatory Bracket	1	-/24	BOX
Disp - 0157	8" Kitchen Bracket	1	-/24	BOX
Disp - 0186	1-Hole T&S Bracket	1	-/24	BOX
Disp - 0187	2-Hole T&S Bracket	1	-/24	BOX
Disp - 0188	3-Hole T&S Bracket	1	-/24	BOX
Disp - 0151	8" Kitchen - With Spray	1	-/24	BOX

\* Purchase a \$5000.00 stock order (net) and receive a three-panel spinner display rack and 18 mounting brackets for free.

\* Purchase \$1000.00 stock order of EZ-FLO faucets and receive 6 free display brackets.

## FAUCET PACKAGING



*Washerless  
Collection*



*Ceramic Disc  
Collection*

## Garbage Disposals

### MOEN® GX PRO® GARBAGE DISPOSAL

**NEW**

- Universal Xpress Mount™ fits Moen and most existing three-bolt mounting assemblies, including InSinkErator® brand
- High-speed VORTEX™ permanent magnet motor designed to reduce jamming
- Power cord pre-installed
- Continuous feed



PART #	DESCRIPTION	UNIT ORDER	INN/MAS	PACK	LIST
86720	1/3 HP Disposal	1	-/1	BOX	142.56
86721	1/2 HP Disposal	1	-/1	BOX	176.78

### APARTMENT GARBAGE DISPOSAL

- Adapter allows mounting to any sink flange
- New splash guard included
- Stainless steel, anti-jam swivel impellers
- Corrosion-proof grind chamber and drain housing
- Fast & easy mount system



PART #	DESCRIPTION	UNIT ORDER	INN/MAS	PACK	LIST
86708	1/3 HP with Pigtail Cord	1	-/1	BOX	119.04
86709	1/2 HP with Pigtail Cord	1	-/1	BOX	141.16

### STANDARD GARBAGE DISPOSAL

- Corrosion-resistant grinding components
- 2-Year warranty
- VORTEX™ powered



PART #	DESCRIPTION	UNIT ORDER	INN/MAS	PACK	LIST
86700	1/3 HP Disposal	1	-/1	BOX	121.18
86701	1/2 HP Disposal	1	-/1	BOX	141.85
86702	1/3 HP Disposal with Pigtail Cord	1	-/1	BOX	130.07
86703	1/2 HP Disposal with Pigtail Cord	1	-/1	BOX	150.52

### WASTE KING® LEGEND SERIES 2600 AND 3200 GARBAGE DISPOSAL

- High-speed 2600 RPM or 2700 RPM permanent magnet motor produces more power per pound
- Stainless steel grinding components
- 5-Year warranty



PART #	DESCRIPTION	UNIT ORDER	INN/MAS	PACK	LIST
86706	1/2 HP Disposal	1	-/1	BOX	181.94
86707	3/4 HP Disposal	1	-/1	BOX	218.95

Supply Connectors

Stop Valves

Water Heater

Gas Connectors

Water Filtration

Sinks/ Faucets

Tubular/ Drainage

Faucet Repair

Bath Accessories

Pipe Fittings/ Repair

Valves

Cements/ Sealants

Tools/ Safety

Toilet Repair

Appliance/ HVAC

Hardware

Electrical

Index

# TUBULAR AND DRAINAGE

## Garbage Disposal Accessories

### GARBAGE DISPOSAL HUSH CUSHION

- Rubber



PART #	DESCRIPTION	UNIT ORDER	INN/MAS	PACK	LIST
30125	Fits In-Sink-Erator® & Universal Sizes	10	10/100	BULK	0.77
* 30126	Fits Waste King®	10	10/100	BULK	0.83

\*While Supplies Last

### GARBAGE DISPOSAL SPLASH GUARD

- Fits In-Sink-Erator®



PART #	DESCRIPTION	UNIT ORDER	INN/MAS	PACK	LIST
30102	Splash Guard	10	10/200	BULK	1.71

### DISPOSAL STOPPER & SPLASH GUARD

- For Whirlaway® garbage disposals



PART #	DESCRIPTION	UNIT ORDER	INN/MAS	PACK	LIST
30124	Stopper & Guard Set	1	-/100	BAG	3.50

### GARBAGE DISPOSAL SPLASH GUARD

- Rubber
- Universal



PART #	DESCRIPTION	UNIT ORDER	INN/MAS	PACK	LIST
30103	Universal Splash Guard	10	10/200	BULK	1.04

### GARBAGE DISPOSAL STOPPER

- Fits In-Sink-Erator®
- Black plastic
- 3-3/8"



PART #	DESCRIPTION	UNIT ORDER	INN/MAS	PACK	LIST
30098	Stopper	10	10/100	BULK	1.88

### GARBAGE DISPOSAL STRAINER

- White PVC
- 3-1/8"

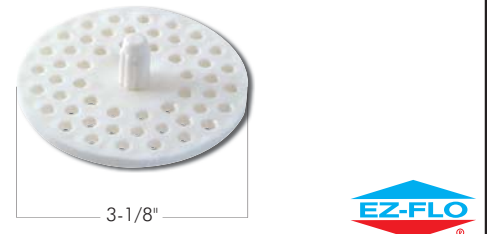

PART #	DESCRIPTION	UNIT ORDER	INN/MAS	PACK	LIST
30093	Strainer	10	10/100	BAG	1.20

### GARBAGE DISPOSAL STOPPER

- Fits Whirlaway®
- Black plastic
- 2-7/8"



PART #	DESCRIPTION	UNIT ORDER	INN/MAS	PACK	LIST
30097	Stopper	10	10/100	BULK	1.57

### GARBAGE DISPOSAL STOPPER

- Ivory rubber
- 4-1/8"

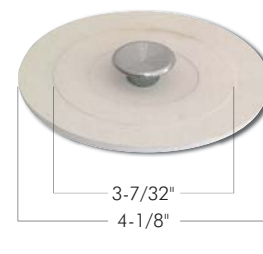

PART #	DESCRIPTION	UNIT ORDER	INN/MAS	PACK	LIST
30099	Stopper	5	5/200	BULK	1.88

## Garbage Disposal Accessories

### GARBAGE DISPOSAL STOPPER

- White rubber
- 4-1/8"

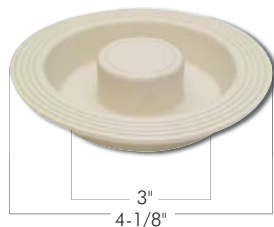

PART #	DESCRIPTION	UNIT ORDER	INN/MAS	PACK	LIST
30101	Stopper	10	10/100	BULK	1.48

### DISHWASHER HOT WATER DRAIN HOSE

- Reinforced EPDM rubber hose
- Sold and priced per coil only



PART #	DESCRIPTION	UNIT ORDER	INN/MAS	PACK	LIST
60363	5/8" ID x 50'	1	-/1	BOX	74.93
60365	7/8" ID x 50'	1	-/1	BOX	100.51

### RUBBER GARBAGE DISPOSAL CONNECTOR

- Rubber boot



60424



60423

PART #	DESCRIPTION	UNIT ORDER	INN/MAS	PACK	LIST
60424	With 2 Screw Clamps	10	10/200	BULK	2.34
60423	With 4 Screw Clamps	10	10/200	BULK	2.20

### STRAIGHT 16/3 PIGTAIL CORD

- 16/3 Wire
- Rated 13 Amp/125 Volt
- UL listed for garbage disposals, motors, tools and appliances



PART #	DESCRIPTION	UNIT ORDER	INN/MAS	PACK	LIST
60651	3' Length	10	10/200	BULK	3.85
60655	6' Length	10	10/100	BULK	6.42

### STRAIGHT 14/3 PIGTAIL CORD

**NEW**

- 14/3 Wire
- Rated 15 Amp/125 Volt
- UL listed for garbage disposals, motors, tools and appliances



PART #	DESCRIPTION	UNIT ORDER	INN/MAS	PACK	LIST
69022	3' Length	10	10/100	BULK	5.84
69024	6' Length	10	10/100	BULK	9.27

### ANGLED 16/3 PIGTAIL CORD

- 16/3 Wire
- Rated 13 Amp/125 Volt
- UL listed for garbage disposals, motors, tools and appliances



PART #	DESCRIPTION	UNIT ORDER	INN/MAS	PACK	LIST
60657	3' Length	10	10/200	BULK	4.22
60663	6' Length	10	10/100	BULK	6.76

### ANGLED 14/3 PIGTAIL CORD

**NEW**

- 14/3 Wire
- Rated 15 Amp/125 Volt
- UL listed for garbage disposals, motors, tools and appliances



PART #	DESCRIPTION	UNIT ORDER	INN/MAS	PACK	LIST
69018	3' Length	10	10/100	BULK	5.84
69020	6' Length	10	10/100	BULK	9.27
69021	8' Length	10	10/100	BULK	10.95

Supply Connectors

Stop Valves

Water Heater

Gas Connectors

Water Filtration

Sinks/Faucets

Tubular/Drainage

Faucet Repair

Bath Accessories

Pipe Fittings/Repair

Valves

Cements/Sealants

Tools/Safety

Toilet Repair

Appliance/HVAC

Hardware

Electrical

Index

# TUBULAR AND DRAINAGE

## Air Gaps

### HEAVY-PATTERN AIR GAPS

- For dishwasher & disposal installation

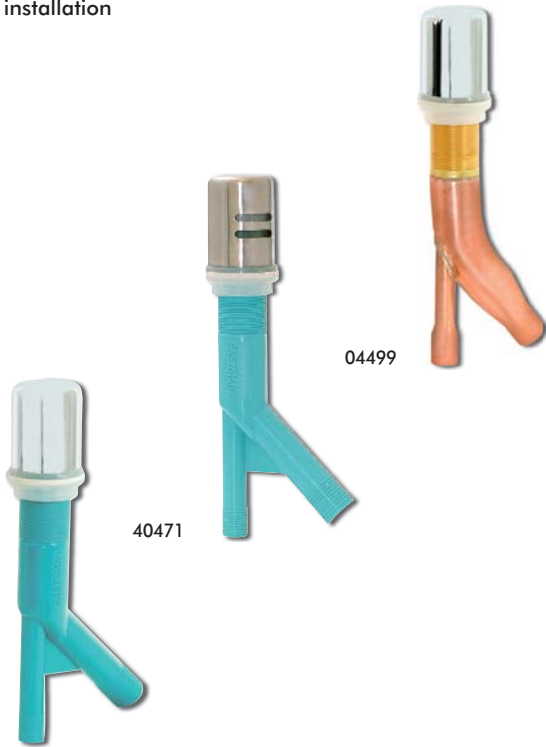

PART #	DESCRIPTION	UNIT ORDER	INN/MAS	PACK	LIST
04470	Blue Body with Chrome Cap	1	24/96	BOX	<b>8.36</b>
40471	Blue Body with Brushed Nickel Cap	1	24/96	BOX	<b>9.77</b>
04499	Copper Body with Chrome Cap	1	24/48	BOX	<b>42.77</b>

### ECONOMY AIR GAPS

- For dishwasher & disposal installation
- Plastic body & cap



PART #	DESCRIPTION	UNIT ORDER	INN/MAS	PACK	LIST
60421	Plastic Air Gap with Chrome Cap	2	2/100	BOX	<b>2.91</b>

## AIR GAP REPLACEMENT CAP

- High-impact ABS plastic



PART #	DESCRIPTION	UNIT ORDER	INN/MAS	PACK	LIST
60419	Chrome	1	-/200	BOX	<b>1.85</b>
90429	Brushed Nickel	1	50/200	BULK	<b>2.83</b>

## Sink Strainers

### SINK STRAINER - STAINLESS STEEL BASKET - ABS BODY

- Stick post
- Stainless steel basket
- Fits sink with 3-1/2" - 4" opening
- 4-1/2" Flange
- Chrome-plated ABS



PART #	DESCRIPTION	UNIT ORDER	INN/MAS	PACK	LIST
30005	ABS Body	1	-/50	CARD	<b>3.54</b>

### SINK STRAINER - STAINLESS STEEL

- 304 Stainless steel body
- Stainless steel fixed-post basket
- Fits sink with 3-1/2" - 4" opening
- 4-1/2" Flange



PART #	DESCRIPTION	UNIT ORDER	INN/MAS	PACK	LIST
30001	With Die-Cast Slip-Joint Nut	1	-/50	BOX	<b>6.24</b>
30003	With Brass Slip-Joint Nut	1	10/50	BOX	<b>9.27</b>
30008	With 1-1/2" x 4" Brass Tailpiece	1	10/50	BOX	<b>8.81</b>



## Sink Strainers

### SINK STRAINER - HEAVY-PATTERN BRASS BODY

- Heavy-pattern
- Chrome-plated brass body
- Stainless steel fixed-post basket
- Fits sink with 3-1/2" - 4" opening



**EASTMAN**

PART #	DESCRIPTION	UNIT ORDER	INN/MAS	PACK	LIST
30002	Brass Slip-Joint Nut	1	10/50	BOX	24.09

### SINK STRAINER - DOUBLE CUP

- 304 Stainless steel body
- Stainless steel fixed-post basket
- Fits sink with 3-1/2" - 4" opening
- 4-1/2" Flange
- 1-1/2" Slip-joint nut



**EZ-FLO**

PART #	DESCRIPTION	UNIT ORDER	INN/MAS	PACK	LIST
30017	Standard Shank (Shank Length 1-1/4")	1	-/50	BOX	9.27
30019	Extended Shank (Shank Length 1-7/8")	1	-/50	BOX	13.74

### SINK STRAINER - ECONOMY - ABS BODY

- Stick post
- White ABS body
- Fits sink with 3-1/2" - 4" opening
- 4-1/2" Flange



**EZ-FLO**

PART #	DESCRIPTION	UNIT ORDER	INN/MAS	PACK	LIST
30006	White ABS Basket	1	10/50	CARD	4.68

### SINK STRAINER - SPIN & SEAL

- 304 Stainless steel body
- Stainless steel threaded-post basket
- Fits sink with 3-1/2" - 4" opening
- 4-1/2" Flange



**EZ-FLO**

PART #	DESCRIPTION	UNIT ORDER	INN/MAS	PACK	LIST
30009	With Die-Cast Slip-Joint Nut	1	-/50	BOX	13.69
30011	With Brass Slip-Joint Nut	1	-/50	BOX	16.34

### SINK STRAINER - HEAVY-PATTERN

- Cast-brass body
- Stainless steel drop-post basket
- Fits sink with 3-1/2" - 4" opening
- 4-1/2" Flange



**EASTMAN**

PART #	DESCRIPTION	UNIT ORDER	INN/MAS	PACK	LIST
30023	Chrome-Plated Solid Brass Body	1	-/25	BOX	27.80

### SINK STRAINER - SPIN & SEAL HEAVY-PATTERN

- Cast-brass body
- Stainless steel threaded-post basket
- Fits sink with 3-1/2" - 4" opening
- 4-1/2" Flange



**EASTMAN**

PART #	DESCRIPTION	UNIT ORDER	INN/MAS	PACK	LIST
30021	Chrome-Plated Solid Brass Body	1	-/25	BOX	31.79

Supply Connectors

Stop Valves

Water Heater

Gas Connectors

Water Filtration

Sinks/Faucets

Tubular/Drainage

Faucet Repair

Bath Accessories

Pipe Fittings/Repair

Valves

Cements/Sealants

Tools/Safety

Toilet Repair

Appliance/HVAC

Hardware

Electrical

Index

# TUBULAR AND DRAINAGE

## Sink Strainers

### SINK STRAINER - QUICK-CONNECT

- 304 Stainless steel body
- Stainless steel fixed-post basket
- Fits sink with 3-1/2" - 4" opening
- 4-1/2" Flange
- 3-Bolt flange installation



PART #	DESCRIPTION	UNIT ORDER	INN/MAS	PACK	LIST
30013	With Die-Cast Slip-Joint Nut	1	10/50	BOX	9.84
30015	With Brass Slip-Joint Nut	1	10/50	BOX	10.41

### SINK STRAINER - QUICK-CONNECT



- Stainless steel body and basket
- Extended shank
- Fits 3-1/2" - 4" opening
- Extra thick rubber washer
- 3-Bolt flange installation
- Spring-style snap-in basket



PART #	DESCRIPTION	UNIT ORDER	INN/MAS	PACK	LIST
30020	With Brass Slip-Joint Nut	1	10/50	BOX	14.26

### SINK STRAINER - JUNIOR DUO

- Stainless steel body and basket
- Fits sink with 1-7/8" - 2-1/4" opening
- 1-1/2" Basket - 2-1/2" standard shank



PART #	DESCRIPTION	UNIT ORDER	INN/MAS	PACK	LIST
30035	Die-Cast Nut	1	-/100	BOX	5.30
30036	Brass Nut	1	10/100	BOX	7.98

### SINK STRAINER - EXTENDED SHANK JUNIOR DUO

- Chrome-plated brass body
- Stainless steel basket
- Fits sink with 1-7/8" - 2-1/4" opening



PART #	DESCRIPTION	UNIT ORDER	INN/MAS	PACK	LIST
30037	3" Long Extended Shank	1	-/100	BOX	18.96

### FLAT-TOP STRAINER - STAINLESS STEEL

- 304 Stainless steel body
- Fits sink with 3-1/2" - 4" opening
- 4-1/2" Flange



PART #	DESCRIPTION	UNIT ORDER	INN/MAS	PACK	LIST
30031	Die-Cast Nut	1	-/50	BOX	7.84

### DUPLEX FLAT-TOP STRAINER - STAINLESS STEEL

- 304 Stainless steel body
- Fits sink with 1-7/8" - 2-1/4" opening
- 2-7/8" Flange



PART #	DESCRIPTION	UNIT ORDER	INN/MAS	PACK	LIST
30043	Die-Cast Nut	1	-/100	BOX	5.25

### LAUNDRY TRAY PLUG

- Fits sink with 1-7/8" - 2-1/4" opening
- 2-7/8" Flange
- Rubber stopper



PART #	DESCRIPTION	UNIT ORDER	INN/MAS	PACK	LIST
30041	Stainless Steel Body	1	-/100	BOX	4.42
30042	ABS Body with Stainless Steel Flange	1	-/100	BOX	3.28

## Sink Strainer Parts

### BASIN LOCKNUT

- Die-cast



PART #	DESCRIPTION	UNIT ORDER	INN/MAS	PACK	LIST
35019	1/2"	10	250/500	BULK	0.71
35023	1-1/2"	1	10/100	BULK	1.05
35027	4" (For Basket Strainer)	1	-/175	BULK	2.14

### RUBBER GASKET

- Fits 4-1/2" kitchen sink strainer



PART #	DESCRIPTION	UNIT ORDER	INN/MAS	PACK	LIST
36331	4-3/8" OD x 3-1/2" ID x 3/32"	10	10/100	BULK	0.40

## Sink Strainer Parts

### REPLACEMENT BASKET - WHITE ABS

- 3-1/2" Diameter



PART #	DESCRIPTION	UNIT ORDER	INN/MAS	PACK	LIST
30059	Rubber Bottom	1	10/100	BAG	1.28

### REPLACEMENT BASKET - STAINLESS STEEL

- 3-1/2" Diameter



PART #	DESCRIPTION	UNIT ORDER	INN/MAS	PACK	LIST
30051	Rubber Flat Bottom	5	5/200	BAG	2.05
30053	Stick Post	5	5/200	BAG	1.94
30054	Spring Clip	20	20/200	BAG	2.57
30047	Threaded-Post Spin & Seal	8	8/160	BAG	6.70
30057	Rubber Pronged Bottom Fits Sterling®	25	25/100	BAG	3.19

### REPLACEMENT BASKET - JUNIOR DUO

- Stainless steel



PART #	DESCRIPTION	UNIT ORDER	INN/MAS	PACK	LIST
30055	1-1/2"	25	25/200	BAG	1.40

### REPLACEMENT STRAINER

- Stainless steel



PART #	DESCRIPTION	UNIT ORDER	INN/MAS	PACK	LIST
30061	1" Basin - Crumb Cup	10	10/100	BAG	0.80
30067	1-1/4" Tub Strainer	10	10/100	BAG	1.00
30063	1-1/2" Sink - Crumb Cup	10	10/100	BAG	1.11
30065	1-1/2" Sink - Crumb Cup with Post	10	10/100	BAG	1.60

### 3-PRONG DRAIN STRAINER

- Steel
- Snap-in



PART #	DESCRIPTION	UNIT ORDER	INN/MAS	PACK	LIST
30071	1-5/8"	10	10/100	BULK	0.40
30073	1-7/8"	10	10/100	BULK	0.48

## Sink Stoppers

### FIT-ALL STOPPER - 1" TO 1-3/8"

- White rubber



PART #	DESCRIPTION	UNIT ORDER	INN/MAS	PACK	LIST
30107	1" - 1-3/8"	20	20/500	BAG	0.54

### FIT-ALL STOPPER - 1-1/2" TO 2"

- White rubber



PART #	DESCRIPTION	UNIT ORDER	INN/MAS	PACK	LIST
30109	1-1/2" - 2"	10	10/100	BAG	0.80
30110	1-1/2" - 2" with 15" Bead Chain	10	10/100	BAG	2.00

### DRAIN STOPPER

- White rubber



PART #	DESCRIPTION	UNIT ORDER	INN/MAS	PACK	LIST
30105	5" Flat	10	10/100	BAG	0.80

### HAIR SNARE

- White rubber



PART #	DESCRIPTION	UNIT ORDER	INN/MAS	PACK	LIST
30091	Hair Catcher	10	10/200	BAG	1.28

Supply Connectors

Stop Valves

Water Heater

Gas Connectors

Water Filtration

Sinks/Faucets

Tubular/Drainage

Faucet Repair

Bath Accessories

Pipe Fittings/Repair

Valves

Cements/Sealants

Tools/Safety

Toilet Repair

Appliance/HVAC

Hardware

Electrical

Index

# TUBULAR AND DRAINAGE

## Brass Tubular

### P-TRAP WITH FLANGE

- Chrome finish
- 1-1/2" Has 8-1/4" wall extension
- 1-1/4" Has 7-1/2" wall extension
- Slip-joint connection



PART #	DESCRIPTION	UNIT ORDER	INN/MAS	PACK	LIST
35099	1-1/4" 17-Gauge	1	-/50	BOX	24.86
35095	1-1/2" 17-Gauge	1	-/25	BOX	28.88
35002	1-1/4" 22-Gauge	1	-/25	BOX	16.19
35001	1-1/2" 22-Gauge	1	-/25	BOX	19.59

### P-TRAP WITH FLANGE & CLEANOUT

- Chrome finish
- Slip-joint connection



PART #	DESCRIPTION	UNIT ORDER	INN/MAS	PACK	LIST
35020	1-1/4" 17-Gauge	1	-/25	BOX	28.11
35022	1-1/2" 17-Gauge	1	-/25	BOX	32.79

### J-BEND

- Chrome finish
- Slip-joint connection



PART #	DESCRIPTION	UNIT ORDER	INN/MAS	PACK	LIST
35125	1-1/4" 17-Gauge	1	-/25	BOX	13.46
35131	1-1/2" 17-Gauge	1	-/25	BOX	15.82
35127	1-1/4" 22-Gauge	1	-/25	BOX	14.48
35123	1-1/2" 22-Gauge	1	-/25	BOX	16.05

### SINK TRAP J-BEND

- 1-1/2"
- Chrome finish
- Captive



PART #	DESCRIPTION	UNIT ORDER	INN/MAS	PACK	LIST
35112	17-Gauge	1	-/25	BOX	16.14
35093	22-Gauge	1	-/30	BOX	12.40

### CENTER OUTLET

- 1-1/2" x 16"
- Chrome finish
- 22-Gauge



PART #	DESCRIPTION	UNIT ORDER	INN/MAS	PACK	LIST
35013	S/J Connect 22-Gauge	1	-/25	BOX	39.69
35014	Direct Connect 22-Gauge	1	-/25	BOX	35.41

### END OUTLET

- 1-1/2" x 16"
- Chrome finish



PART #	DESCRIPTION	UNIT ORDER	INN/MAS	PACK	LIST
35007	S/J Connect 22-Gauge	1	-/25	BOX	35.95
35009	Direct Connect 22-Gauge	1	-/25	BOX	33.79

### S-TRAP WITH FLANGE

- Chrome finish
- Slip-joint connect



PART #	DESCRIPTION	UNIT ORDER	INN/MAS	PACK	LIST
35003	1-1/4" 22-Gauge	1	-/25	BOX	25.80
35008	1-1/2" 22-Gauge	1	-/25	BOX	33.79

### WALL BEND TUBE

- Chrome finish
- Direct connection



PART #	DESCRIPTION	UNIT ORDER	INN/MAS	PACK	LIST
35129	1-1/4" x 7" 17-Gauge	1	-/25	BAG	10.75
35098	1-1/4" x 15" 17-Gauge	1	30/60	BAG	20.24
35096	1-1/2" x 15" 17-Gauge	1	-/30	BAG	23.72
35016	1-1/4" x 6" 22-Gauge	1	-/25	BAG	5.93
35018	1-1/2" x 6" 22-Gauge	1	-/25	BAG	8.75

## Brass Tubular

### WASTE ARM

- Chrome finish



35010

35133



PART #	DESCRIPTION	UNIT ORDER	INN/MAS	PACK	LIST
35010	1-1/2" x 7" - S/J Connect 22-Gauge	1	-/25	BAG	<b>9.89</b>
35133	1-1/2" x 7" - Direct Connect 22-Gauge	1	-/25	BAG	<b>8.04</b>
35092	1-1/2" x 12" - S/J Connect 22-Gauge	1	-/25	BAG	<b>14.34</b>
35011	1-1/2" x 15" - S/J Connect 22-Gauge	1	-/25	BAG	<b>16.34</b>
35017	1-1/2" x 15" - Direct Connect 22-Gauge	1	30/60	BAG	<b>15.00</b>

### EXTENSION TUBE

- Chrome finish
- Slip-joint connection



PART #	DESCRIPTION	UNIT ORDER	INN/MAS	PACK	LIST
35094	1-1/4" x 6" - 17-Gauge	1	-/25	BAG	<b>8.70</b>
35117	1-1/2" x 6" - 17-Gauge	1	-/25	BAG	<b>10.55</b>
35118	1-1/2" x 8" - 17-Gauge	1	-/25	BAG	<b>13.06</b>
35119	1-1/2" x 12" - 17-Gauge	1	-/25	BAG	<b>18.36</b>
35104	1-1/4" x 6" - 22-Gauge	1	-/25	BAG	<b>5.65</b>
35106	1-1/4" x 12" - 22-Gauge	1	-/25	BAG	<b>9.55</b>
35101	1-1/2" x 6" - 22-Gauge	1	-/25	BAG	<b>6.87</b>
35103	1-1/2" x 8" - 22-Gauge	1	-/25	BAG	<b>8.24</b>
35105	1-1/2" x 12" - 22-Gauge	1	-/25	BAG	<b>11.21</b>

### FLANGED SINK TAILPIECE

- Chrome finish
- Direct connection



PART #	DESCRIPTION	UNIT ORDER	INN/MAS	PACK	LIST
35114	1-1/2" x 6" 17-Gauge	1	-/25	BAG	<b>8.47</b>
35115	1-1/2" x 8" 17-Gauge	1	-/25	BAG	<b>10.98</b>
35116	1-1/2" x 12" 17-Gauge	1	-/25	BAG	<b>16.51</b>
35134	1-1/4" x 8" 22-Gauge	1	-/25	BAG	<b>5.90</b>
35081	1-1/2" x 4" 22-Gauge	1	-/25	BAG	<b>3.54</b>
35082	1-1/2" x 6" 22-Gauge	1	-/25	BAG	<b>4.88</b>
35083	1-1/2" x 8" 22-Gauge	1	-/25	BAG	<b>6.24</b>
35085	1-1/2" x 12" 22-Gauge	1	-/25	BAG	<b>9.35</b>

### DISHWASHER TAILPIECE

- 1-1/2" x 8" Direct connect
- Chrome finish



PART #	DESCRIPTION	UNIT ORDER	INN/MAS	PACK	LIST
35088	5/8" OD Branch 22-Gauge	1	-/25	BAG	<b>9.58</b>
35128	7/8" OD Branch 22-Gauge	1	-/25	BAG	<b>9.78</b>

### DISHWASHER LONG BRANCH TAILPIECE

- 1-1/2" x 6" Direct connect
- Chrome finish
- 22-Gauge



PART #	DESCRIPTION	UNIT ORDER	INN/MAS	PACK	LIST
35090	5/8" OD Branch 22-Gauge	1	-/25	BAG	<b>9.07</b>

### THREADED TUBE

- Threaded both ends
- Chrome finish



PART #	DESCRIPTION	UNIT ORDER	INN/MAS	PACK	LIST
35100	1-1/4" x 12" 17-Gauge	1	-/25	BAG	<b>14.14</b>
35113	1-1/2" x 12" 17-Gauge	1	-/25	BAG	<b>16.77</b>
35120	1-1/4" x 6" 20-Gauge	1	-/25	BAG	<b>6.30</b>
35122	1-1/4" x 12" 20-Gauge	1	-/25	BAG	<b>11.80</b>
35124	1-1/2" x 6" 20-Gauge	1	-/25	BAG	<b>7.47</b>
35126	1-1/2" x 12" 20-Gauge	1	-/25	BAG	<b>13.94</b>

### DOUBLE-END EXTENSION

- Chrome finish
- Slip-joint connection



PART #	DESCRIPTION	UNIT ORDER	INN/MAS	PACK	LIST
35149	1-1/2" x 16" 22-Gauge	1	-/25	BAG	<b>15.65</b>

Supply Connectors

Stop Valves

Water Heater

Gas Connectors

Water Filtration

Sinks/Faucets

Tubular/Drainage

Faucet Repair

Bath Accessories

Pipe Fittings/Repair

Valves

Cements/Sealants

Tools/Safety

Toilet Repair

Appliance/HVAC

Hardware

Electrical

Index

# TUBULAR AND DRAINAGE

## Brass Tubular

### DOUBLE-END FLANGED TAILPIECE

- Chrome finish
- Direct connection



PART #	DESCRIPTION	UNIT ORDER	INN/MAS	PACK	LIST
35148	1-1/2" x 16" 22-Gauge	1	-/25	BAG	12.74

### 90° ELBOW

- Chrome finish
- Slip-joint connection



PART #	DESCRIPTION	UNIT ORDER	INN/MAS	PACK	LIST
35135	1-1/4" 22-Gauge	1	-/25	BAG	7.56
35136	1-1/2" 22-Gauge	1	-/25	BAG	9.27

### DOUBLE OFFSET

- Chrome finish
- Slip-joint connection



PART #	DESCRIPTION	UNIT ORDER	INN/MAS	PACK	LIST
35150	1-1/4" x 1-1/4" 22-Gauge	1	-/25	BAG	12.20
35151	1-1/2" x 1-1/2" 22-Gauge	1	-/25	BAG	15.34

### COUPLING

- Chrome finish
- Slip-joint connection



PART #	DESCRIPTION	UNIT ORDER	INN/MAS	PACK	LIST
35137	1-1/4" 22-Gauge	1	-/25	BAG	7.27
35138	1-1/2" 22-Gauge	1	-/25	BAG	7.56

### END OUTLET TEE

- Chrome finish
- Cast brass
- Slip-joint connection



PART #	DESCRIPTION	UNIT ORDER	INN/MAS	PACK	LIST
35015	1-1/2" Tee 22-Gauge	1	-/25	BAG	19.07
35132	1-1/2" Tee with Baffle 22-Gauge	1	-/25	BAG	19.33

## Fittings

### TRAP ADAPTER FEMALE

- Brass with slip-joint nut & compression ring
- Rough brass finish



PART #	DESCRIPTION	UNIT ORDER	INN/MAS	PACK	LIST
35405	1-1/2" FIP x 1-1/4" OD	10	10/100	BULK	9.27
35401	1-1/2" FIP x 1-1/2" OD	10	10/100	BULK	8.68

### 3-WAY TEE

- Chrome finish
- Slip-joint connection



PART #	DESCRIPTION	UNIT ORDER	INN/MAS	PACK	LIST
35139	1-1/2" 22-Gauge	1	-/25	BAG	14.74

### TRAP ADAPTER MALE

- Brass with slip-joint nut & compression ring
- Rough brass finish



PART #	DESCRIPTION	UNIT ORDER	INN/MAS	PACK	LIST
35407	1-1/2" MIP x 1-1/4" OD	10	10/100	BULK	9.27
35403	1-1/2" MIP x 1-1/2" OD	10	10/100	BULK	9.27

# TUBULAR AND DRAINAGE

## Fittings

### SLIP-JOINT NUT WITH WASHER - BRASS

- Chrome-plated brass nut with washer



**EASTMAN.**

PART #	DESCRIPTION	UNIT ORDER	INN/MAS	PACK	LIST
35053	1-1/2" x 1-1/4"	10	10/250	BAG	2.54
35051	1-1/2"	10	10/250	BAG	2.37

### SLIP-JOINT NUT WITH WASHER - BRASS

- Rough brass nut with washer



**EASTMAN.**

PART #	DESCRIPTION	UNIT ORDER	INN/MAS	PACK	LIST
35061	1-1/2"	10	10/250	BAG	2.14

### SLIP-JOINT NUT - DIE-CAST

- Chrome-plated die-cast



**EASTMAN.**

PART #	DESCRIPTION	UNIT ORDER	INN/MAS	PACK	LIST
35069	1-1/4"	10	10/100	BULK	1.08
35067	1-1/2" x 1-1/4"	10	10/100	BULK	1.08
35065	1-1/2"	10	10/100	BULK	1.00

### SLIP-JOINT NUT - PVC

- Plastic



**EASTMAN.**

PART #	DESCRIPTION	UNIT ORDER	INN/MAS	PACK	LIST
35068	1-1/4" White	10	10/100	BULK	0.26
35089	1-1/4" White - 10 Pack	1	10/100	BAG	3.16
35064	1-1/2" White	10	10/100	BULK	0.29
35086	1-1/2" White - 10 Pack	1	10/100	BAG	3.16

### SLIP-JOINT NUT - PVC

- Plastic



**EASTMAN.**

PART #	DESCRIPTION	UNIT ORDER	INN/MAS	PACK	LIST
35326	1-1/2" Black - 10 Pack	1	25/100	BAG	3.16

### SLIP-JOINT WASHER

- Rubber washer
- Sold and priced 100 per bag



**EASTMAN.**

PART #	DESCRIPTION	UNIT ORDER	INN/MAS	PACK	LIST
36201	1-1/4"	1	-/20	BAG	14.97
36203	1-1/2"	1	-/20	BAG	14.97

### SLIP-JOINT WASHER

- Polyethylene washer
- Sold and priced 100 per bag



**EASTMAN.**

PART #	DESCRIPTION	UNIT ORDER	INN/MAS	PACK	LIST
36214	1-1/4"	1	25/100	BAG	5.96
36217	1-1/2" x 1-1/4"	1	25/100	BAG	5.96
36215	1-1/2"	1	25/100	BAG	5.96
36219	1-1/2" Tailpiece	1	25/100	BAG	5.96

## Plastic PP Tubular

### LAVATORY TRAP-VENT® P-TRAP

- Replaces conventional P-trap and maintains 2" trap seal
- One-way valve allows air into drainage system
- Gravity sealed valve prevents gas and odors from being released
- Cannot be installed on sinks that receive discharge from appliances
- Do not use where pumps or pressurized flushing devices are used



PART #	DESCRIPTION	UNIT ORDER	INN/MAS	PACK	LIST
35372	1-1/4"	5	5/50	BAG	76.98

Supply Connectors

Stop Valves

Water Heater

Gas Connectors

Water Filtration

Sinks/Faucets

Tubular/Drainage

Faucet Repair

Bath Accessories

Pipe Fittings/Repair

Valves

Cements/Sealants

Tools/Safety

Toilet Repair

Appliance/HVAC

Hardware

Electrical

Index

# TUBULAR AND DRAINAGE

## Plastic PP Tubular

### KITCHEN TRAP-VENT® P-TRAP

- Replaces conventional P-trap and maintains 2" trap seal
- One-way valve allows air into drainage system
- Gravity sealed valve prevents gas and odors from being released
- Cannot be installed on sinks that receive discharge from appliances
- Do not use where pumps or pressurized flushing devices are used



PART #	DESCRIPTION	UNIT ORDER	INN/MAS	PACK	LIST
35373	1-1/2"	5	5/50	BAG	76.98

### P-TRAP

- Less trap adapter
- Polypropylene



PART #	DESCRIPTION	UNIT ORDER	INN/MAS	PACK	LIST
35374	1-1/4" - White	25	25/100	BAG	2.62
35375	With 1-1/2" & 1-1/2" to 1-1/4" Reducing Washer - White	25	25/50	BAG	2.22
35377	1-1/4" - Black	25	25/100	BAG	2.62
35314	1-1/2" - Black	25	25/50	BAG	2.54

### P-TRAP WITH ADAPTER

- Includes trap adapter and 1-1/2" x 1-1/4" and 1-1/2" washers
- Polypropylene



PART #	DESCRIPTION	UNIT ORDER	INN/MAS	PACK	LIST
35376	1-1/2" - White	25	25/50	BAG	2.54
35313	1-1/2" - Black	25	25/50	BAG	2.44

### P-TRAP WITH CLEANOUT

- Less trap adapter
- White polypropylene



PART #	DESCRIPTION	UNIT ORDER	INN/MAS	PACK	LIST
35378	1-1/2" and 1-1/2" to 1-1/4" Reducing Washer	25	25/50	BAG	2.82

### 1-1/2" KITCHEN SINK TRAP

- Captive nut on J-bend
- White polypropylene
- With 1-1/2" & 1-1/2" to 1-1/4" reducing washer



PART #	DESCRIPTION	UNIT ORDER	INN/MAS	PACK	LIST
35379	1-1/2"	25	25/100	BAG	3.34

### 1-1/2" REPAIR TRAP

- Captive nut on J-bend
- White polypropylene
- With 1-1/2" & 1-1/2" to 1-1/4" reducing washer



PART #	DESCRIPTION	UNIT ORDER	INN/MAS	PACK	LIST
35380	1-1/2"	25	25/100	BAG	3.56

### 1-1/2" J-BEND

- White polypropylene
- With 1-1/2" & 1-1/2" to 1-1/4" reducing washer



PART #	DESCRIPTION	UNIT ORDER	INN/MAS	PACK	LIST
35371	1-1/2"	25	25/100	BAG	1.77

### 1-1/2" J-BEND WITH CAPTIVE NUT

- J-bend for 1-1/2" trap
- Captive nut on end
- Includes 1-1/2" x 1-1/4" reducing washer
- Polypropylene



PART #	DESCRIPTION	UNIT ORDER	INN/MAS	PACK	LIST
35305	1-1/2"	25	25/100	BAG	1.97

### 1-1/2" END OUTLET

- Kitchen sink end waste outlet with baffle in tee
- Polypropylene
- 1-1/2" x 1/2"



PART #	DESCRIPTION	UNIT ORDER	INN/MAS	PACK	LIST
35386	S/J Connection - White	25	25/50	BAG	4.62
35385	Direct Connection - White	25	25/50	BAG	5.02
35316	S/J Connection - Black	25	25/50	BAG	4.42
35318	Direct Connection - Black	25	25/50	BAG	4.42



## Plastic PP Tubular

### S-TRAP

- Polypropylene



PART #	DESCRIPTION	UNIT ORDER	INN/MAS	PACK	LIST
35304	1-1/4"	25	25/50	BAG	5.16
35302	1-1/2"	25	25/50	BAG	5.84
35400	1-1/2" With Trap Adapter	25	25/50	BAG	7.56

### 1-1/2" END OUTLET WITH DISHWASHER CONNECTION

- Kitchen sink end waste outlet with 7/8" OD branch tailpiece
- Adjustable from 11" to 16"
- 1-1/2" Slip-joint connections
- Polypropylene



PART #	DESCRIPTION	UNIT ORDER	INN/MAS	PACK	LIST
35384	1-1/2"	25	25/50	BAG	5.62

### 1-1/2" CENTER OUTLET

- Kitchen sink center waste outlet with baffle in tee
- Polypropylene
- 1-1/2" x 16"



PART #	DESCRIPTION	UNIT ORDER	INN/MAS	PACK	LIST
35393	S/J Connection - White	25	25/50	BAG	5.02
35394	Direct Connection - White	25	25/50	BAG	5.02
35319	S/J Connection - Black	25	25/50	BAG	5.53
35320	Direct Connection - Black	25	25/50	BAG	5.53

### 1-1/2" BRANCH TAILPIECE

- 5/8" OD barb outlet
- Branch tailpiece for dishwasher installation
- White polypropylene
- 1-1/2" x 8"



PART #	DESCRIPTION	UNIT ORDER	INN/MAS	PACK	LIST
35311	S/J Connection	25	25/100	BAG	1.97
35310	Direct Connection	25	25/100	BAG	2.08

### 1-1/2" BRANCH TAILPIECE

- 7/8" OD barb outlet
- Branch tailpiece for dishwasher installation
- With captive nut
- Polypropylene
- 1-1/2" x 8"



PART #	DESCRIPTION	UNIT ORDER	INN/MAS	PACK	LIST
35312	S/J Connection - White	25	25/100	BAG	1.97
35358	Direct Connection - White	25	25/100	BAG	2.28
35329	S/J Connection - Black	25	25/100	BAG	3.65
35328	Direct Connection - Black	25	25/100	BAG	3.65

### 1-1/2" END OUTLET TEE

- For end outlet waste with baffle
- White polypropylene



PART #	DESCRIPTION	UNIT ORDER	INN/MAS	PACK	LIST
35387	1-1/2"	25	25/100	BAG	2.51

### 1-1/2" CENTER OUTLET TEE

- For center outlet waste with baffle
- White polypropylene



PART #	DESCRIPTION	UNIT ORDER	INN/MAS	PACK	LIST
35395	1-1/2"	25	25/100	BAG	2.05

### 1-1/2" DISPOSAL KIT

- End outlet with baffle
- Includes disposal hush cushion and 6" tailpiece
- Polypropylene
- 1-1/2" x 16"



PART #	DESCRIPTION	UNIT ORDER	INN/MAS	PACK	LIST
35398	White	25	25/100	BAG	5.13
35322	Black	25	25/100	BAG	5.59

Supply Connectors

Stop Valves

Water Heater

Gas Connectors

Water Filtration

Sinks/Faucets

Tubular/Drainage

Faucet Repair

Bath Accessories

Pipe Fittings/Repair

Valves

Cements/Sealants

Tools/Safety

Toilet Repair

Appliance/HVAC

Hardware

Electrical

Index

# TUBULAR AND DRAINAGE

## Plastic PP Tubular

### 1-1/2" DISPOSAL DRAIN ADAPTER

- Includes:
  - 1-1/2" Flexible tailpiece
  - Hush cushion
  - Slip nut
  - Washer & set of instructions
- White polypropylene



PART #	DESCRIPTION	UNIT ORDER	INN/MAS	PACK	LIST
60425	Universal Replacement	25	-/50	BAG	7.13

### DISPOSAL ELBOW

- Fits In-Sink-Erator®
- White polypropylene



PART #	DESCRIPTION	UNIT ORDER	INN/MAS	PACK	LIST
35397	Flanged, 4-3/4" Length	25	25/100	BAG	1.60

### 1-1/2" FLANGED TAILPIECE

- Polypropylene



PART #	DESCRIPTION	UNIT ORDER	INN/MAS	PACK	LIST
35349	1-1/2" x 4" - White	25	25/200	BAG	0.97
35350	1-1/2" x 6" - White	25	25/200	BAG	1.05
35351	1-1/2" x 8" - White	25	25/200	BAG	1.00
35352	1-1/2" x 12" - White	25	25/200	BAG	1.34
35327	1-1/2" x 8" - Black	25	25/200	BAG	1.00

### 1-1/2" DOUBLE FLANGED TAILPIECE

- Polypropylene
- 1-1/2" x 16"



PART #	DESCRIPTION	UNIT ORDER	INN/MAS	PACK	LIST
35354	White	25	25/100	BAG	2.17
35324	Black	25	25/100	BAG	2.17

### DOUBLE-END EXTENSION TUBE

- Polypropylene
- Slip-joint connection



PART #	DESCRIPTION	UNIT ORDER	INN/MAS	PACK	LIST
35332	1-1/4" x 16" - White	25	25/100	BAG	3.28
35330	1-1/2" x 16" - White	25	25/100	BAG	2.74
35325	1-1/2" x 16" - Black	25	25/100	BAG	2.74

### EXTENSION TUBE WITH NUT

- White polypropylene
- Slip-joint connection



PART #	DESCRIPTION	UNIT ORDER	INN/MAS	PACK	LIST
35360	1-1/4" x 6"	25	25/100	BAG	1.63
35369	1-1/4" x 12"	25	25/100	BAG	2.48
35361	1-1/2" x 8"	25	25/100	BAG	1.91
35362	1-1/2" x 12"	25	25/100	BAG	2.28

### EXTENSION TUBE - SOLVENT WELD

- PVC solvent weld end



PART #	DESCRIPTION	UNIT ORDER	INN/MAS	PACK	LIST
35368	1-1/4" x 8"	25	25/100	BAG	1.77
35366	1-1/2" x 6"	25	25/100	BAG	1.40
35367	1-1/2" x 12"	25	25/100	BAG	2.05

### 1-1/2" EXTENSION TUBE

- Solvent connect



PART #	DESCRIPTION	UNIT ORDER	INN/MAS	PACK	LIST
35363	1-1/2" x 8"	25	25/100	BAG	1.37

### WALL BEND

- White polypropylene
- Direct connection



PART #	DESCRIPTION	UNIT ORDER	INN/MAS	PACK	LIST
35308	1-1/2" x 8"	25	25/100	BAG	1.05

### 1-1/2" WASTE ARM

- Polypropylene
- 1-1/2" x 15"



PART #	DESCRIPTION	UNIT ORDER	INN/MAS	PACK	LIST
35389	S/J Connection - White	25	25/100	BAG	2.99
35390	Direct Connection - White	25	25/100	BAG	2.17
35323	S/J Connection - Black	25	25/100	BAG	2.99

# TUBULAR AND DRAINAGE

## Plastic PP Tubular

### 1-1/2" COUPLING

- White polypropylene
- With 1-1/2" & 1-1/2" to 1-1/4" reducing washer
- Slip-joint connection



PART #	DESCRIPTION	UNIT ORDER	INN/MAS	PACK	LIST
35331	1-1/2"	25	25/200	BAG	2.08

### 1-1/2" 45° ELBOW

- White polypropylene
- With 1-1/2" washer
- Slip-joint connection



PART #	DESCRIPTION	UNIT ORDER	INN/MAS	PACK	LIST
35333	1-1/2"	25	25/200	BAG	1.97

### 1-1/2" 90° ELBOW

- White polypropylene
- With 1-1/2" washer
- Slip-joint connection



PART #	DESCRIPTION	UNIT ORDER	INN/MAS	PACK	LIST
35335	1-1/2"	25	25/200	BAG	1.91

### 1-1/2" TEE

- White polypropylene
- With 1-1/2" washer
- Slip-joint connection



PART #	DESCRIPTION	UNIT ORDER	INN/MAS	PACK	LIST
35337	1-1/2"	25	25/200	BAG	1.94

### TRAP ADAPTER

- Sch. 40
- Includes nut & washer
- Marvel connector



PART #	DESCRIPTION	UNIT ORDER	INN/MAS	PACK	LIST
35388	1-1/2"	25	25/200	BAG	1.57

### FLANGE ADAPTER

- Sch. 40
- Solvent connection



PART #	DESCRIPTION	UNIT ORDER	INN/MAS	PACK	LIST
35383	1-1/2" Solvent x MIP	25	25/200	BAG	0.93

## Plastic Flexible Tubular

### 1-1/2" FLEXIBLE J-BEND

- J-bend
- White polypropylene
- With 1-1/2" & 1-1/2" to 1-1/4" reducing washer



PART #	DESCRIPTION	UNIT ORDER	INN/MAS	PACK	LIST
35301	1-1/2"	25	25/200	BAG	4.33

### 1-1/2" FLEXIBLE COUPLING

- Can also be used as an elbow
- White polypropylene
- With 1-1/2" & 1-1/2" to 1-1/4" reducing washer



PART #	DESCRIPTION	UNIT ORDER	INN/MAS	PACK	LIST
35309	1-1/2"	25	25/200	BAG	2.42

### 1-1/2" FLEXIBLE FLANGED TAILPIECE

- Flanged tailpiece with captive nut
- White polypropylene



PART #	DESCRIPTION	UNIT ORDER	INN/MAS	PACK	LIST
35315	1-1/2" x 12"	25	25/200	BAG	3.05

### 1-1/2" FLEXIBLE EXTENSION TUBE

- Extension tube with slip-joint nut & washer
- White polypropylene



PART #	DESCRIPTION	UNIT ORDER	INN/MAS	PACK	LIST
35321	1-1/4" x 8"	25	25/200	BAG	3.08
35317	1-1/2" x 12"	25	25/200	BAG	2.71

Supply Connectors

Stop Valves

Water Heater

Gas Connectors

Water Filtration

Sinks/ Faucets

Tubular/ Drainage

Faucet Repair

Bath Accessories

Pipe Fittings/ Repair

Valves

Cements/ Sealants

Tools/ Safety

Toilet Repair

Appliance/ HVAC

Hardware

Electrical

Index

# TUBULAR AND DRAINAGE

## Lavatory Drains

### TWO-PIECE P.O. PLUG

- Two-piece chrome-plated brass
- With rubber stopper & chain
- 20-Gauge
- 1-1/4" x 8"



PART #	DESCRIPTION	UNIT ORDER	INN/MAS	PACK	LIST
35071	Brass Locknut	10	10/50	BOX	14.90

### ONE-PIECE P.O. PLUG

- One-piece ABS with stainless steel flange
- Rubber stopper with beaded chain
- 1-1/4" x 5"



PART #	DESCRIPTION	UNIT ORDER	INN/MAS	PACK	LIST
35073	Plastic Locknut	1	-/48	BOX	3.11
*35077	Zinc Locknut	1	-/48	BOX	3.79

\*While Supplies Last

### ONE-PIECE P.O. PLUG

- Chrome-plated brass
- 22-Gauge
- Rubber stopper with beaded chain
- 1-1/4" x 5"



PART #	DESCRIPTION	UNIT ORDER	INN/MAS	PACK	LIST
35074	Brass Locknut	10	10/50	BOX	9.24

### POP-UP ASSEMBLY

- Brass body
- Easily installed with most faucets



PART #	DESCRIPTION	UNIT ORDER	INN/MAS	PACK	LIST
10901	Chrome - 22-Gauge	1	-/24	BOX	18.01
10903	Brushed Nickel - 20-Gauge	1	-/24	BOX	24.46

### POP-UP ASSEMBLY - HEAVY-PATTERN

- 17-Gauge tailpiece
- Chrome-plated body & trim
- Solid brass nuts
- Heavy-gauge linkage



PART #	DESCRIPTION	UNIT ORDER	INN/MAS	PACK	LIST
10902	17-Gauge	1	-/24	BOX	27.51

### POP-UP ASSEMBLY

- ABS body with stainless steel flange



PART #	DESCRIPTION	UNIT ORDER	INN/MAS	PACK	LIST
10907	Chrome Body/Chrome Trim	1	-/50	BOX	7.13
10908	Gray Body/Chrome Trim	1	-/50	BOX	4.90

### PULL-OUT DRAIN ASSEMBLY

- Lift & turn with O-ring seal
- Cast-brass plug & shoe
- 17-Gauge tailpiece
- Used as lavatory pop-up
- Chrome-plated brass



PART #	DESCRIPTION	UNIT ORDER	INN/MAS	PACK	LIST
35075	1-1/4" x 7"	1	10/50	BOX	28.08

### PUSH-BUTTON DRAIN ASSEMBLY

**NEW**

- Zinc body with stainless steel tube
- 8-Gauge
- Chrome-plated



PART #	DESCRIPTION	UNIT ORDER	INN/MAS	PACK	LIST
90115	2-5/8" x 8"	1	-/50	BOX	19.79

## Lavatory Drains

### GRID STRAINER

- Two-piece chrome-plated brass with grid strainer
- 20-Gauge



PART #	DESCRIPTION	UNIT ORDER	INN/MAS	PACK	LIST
35072	1-1/4" x 8"	10	10/50	BOX	18.30

### OFFSET LAVATORY DRAIN

- Offset for wheelchair access
- Chrome
- 17-Gauge

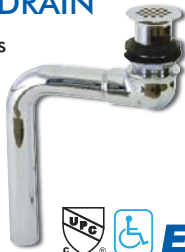

PART #	DESCRIPTION	UNIT ORDER	INN/MAS	PACK	LIST
35078	1-1/4"	1	-/25	BOX	39.23

## Tub and Diverter Spouts

### TUB SPOUT

- 5-1/8" Spout length
- Zinc body
- Chrome



PART #	DESCRIPTION	UNIT ORDER	INN/MAS	PACK	LIST
15077	1/2" IPS Inlet	1	-/50	BOX	6.51

### 7" TUB SPOUT

- Chrome
- Zinc body
- 7" Extended length



PART #	DESCRIPTION	UNIT ORDER	INN/MAS	PACK	LIST
15079	1/2" IPS Inlet	1	-/30	BOX	16.37

### ADJUSTABLE TUB SPOUT

- 5-1/8" Spout length
- Zinc body
- Adjusts up to 1"
- With 3/4" to 1/2" IPS reducing face bushing
- Chrome



PART #	DESCRIPTION	UNIT ORDER	INN/MAS	PACK	LIST
15074	1/2" or 3/4" IPS Inlet	1	-/50	BOX	10.33

### FIT-ALL TUB SPOUT

- Fits 1/2" copper, 1/2" IPS or 3/4" IPS
- 5-1/8" Spout length
- Die-cast zinc



**NEW**

PART #	DESCRIPTION	UNIT ORDER	INN/MAS	PACK	LIST
15065	Chrome	1	-/25	BOX	10.12
15066	Brushed Nickel	1	-/25	BOX	15.51

### FIT-ALL TUB SPOUT

- Fits 1/2" copper, 1/2" IPS or 3/4" IPS
- 6" Spout length
- Die-cast zinc



**NEW**

PART #	DESCRIPTION	UNIT ORDER	INN/MAS	PACK	LIST
15061	Chrome	1	-/25	BOX	20.79

### SLIDE-ON TUB SPOUT

- 5-1/8" Spout length
- Zinc body
- For use with 1/2" copper pipe
- Chrome
- Includes hex wrench



PART #	DESCRIPTION	UNIT ORDER	INN/MAS	PACK	LIST
15075	Slide-On with Set Screw	1	-/50	BOX	10.04

### SLIDE-ON 7" TUB SPOUT

- Chrome-plated zinc body
- 7" Extended length
- Slide-on with set screw
- For use with 1/2" copper pipe



PART #	DESCRIPTION	UNIT ORDER	INN/MAS	PACK	LIST
15076	Slide-On with Set Screw	1	-/30	BOX	20.18

### SLIP-ON® TUB SPOUT

- Fits Mixet®
- Die-cast zinc body
- 1/2" Slip-on quick-connect
- 5-1/8" Spout length
- Chrome



PART #	DESCRIPTION	UNIT ORDER	INN/MAS	PACK	LIST
15125	Slip-On with Set Screw	1	-/10	BOX	12.23

# TUBULAR AND DRAINAGE

## Tub and Diverter Spouts

### TUB SPOUT WITH FACE BUSHING

- Brass construction
- With 3/4" to 1/2" IPS reducing face bushing
- Chrome
- 4-7/8" Spout length



PART #	DESCRIPTION	UNIT ORDER	INN/MAS	PACK	LIST
15071	1/2" or 3/4" IPS Inlet	1	-/30	BOX	41.30

### DIVERTER SPOUT

- Diverter on nose
- 1/2" IPS inlet
- 5-3/8" Spout length



PART #	DESCRIPTION	UNIT ORDER	INN/MAS	PACK	LIST
15083	Zinc Body - Chrome	1	-/50	BOX	9.16
15080	Zinc Body - Brushed Nickel	1	-/50	BOX	13.19
15082	Brass Body - Chrome	1	-/30	BOX	42.32

### 7" DIVERTER SPOUT

- Diverter on nose
- 7" Extended length
- Zinc body
- Chrome



PART #	DESCRIPTION	UNIT ORDER	INN/MAS	PACK	LIST
15072	1/2" IPS Inlet	1	-/30	BOX	21.84

### ADJUSTABLE DIVERTER SPOUT

- 5-3/8" Spout length
- Zinc body
- With 3/4" to 1/2" IPS reducing face bushing
- Adjusts up to 1"
- Diverter on nose
- Chrome



PART #	DESCRIPTION	UNIT ORDER	INN/MAS	PACK	LIST
15084	1-1/2" or 3/4" IPS Inlet	1	-/50	BOX	14.82

### FIT-ALL DIVERTER SPOUT

- Fits 1/2" copper, 1/2" IPS or 3/4" IPS
- 5-1/8" Spout length
- Die-cast zinc



PART #	DESCRIPTION	UNIT ORDER	INN/MAS	PACK	LIST
15067	Chrome	1	-/25	BOX	12.00
15068	Brushed Nickel	1	-/25	BOX	18.13

### SLIDE-ON DIVERTER SPOUT

- For use with 1/2" copper pipe
- 5-3/8" Spout length
- Diverter on nose
- Slide-on spout with set screw
- Includes hex wrench



PART #	DESCRIPTION	UNIT ORDER	INN/MAS	PACK	LIST
15089	Zinc Body - Chrome	1	-/50	BOX	11.88
15088	Zinc Body - Brushed Nickel	1	-/50	BOX	17.41
*15090	Brass Body - Chrome	1	-/30	BOX	31.33

\*While Supplies Last

### 7" SLIDE-ON DIVERTER SPOUT

- For use with 1/2" copper pipe
- 7" Extended spout length
- Zinc body
- Slide-on spout with set screw
- Diverter on nose
- Chrome
- Includes hex wrench



PART #	DESCRIPTION	UNIT ORDER	INN/MAS	PACK	LIST
15069	Slide-On with Set Screw	1	-/30	BOX	24.59

### SLIP-ON DIVERTER SPOUT

- Fits Mixet®
- Die-cast zinc
- 1/2" Slip-on quick-connect with set screw
- With diverter on nose
- 5-1/8" Spout length

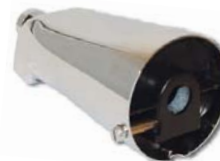

PART #	DESCRIPTION	UNIT ORDER	INN/MAS	PACK	LIST
15126	Chrome	1	-/25	BOX	16.04
15129	Brushed Nickel	1	-/25	BOX	24.61

### SLIP-ON EXTENDED DIVERTER SPOUT



- Fits Mixet®
- 1/2" Slip-on quick-connect with set screw
- 6-1/2" Spout length
- Die-cast zinc body
- Diverter on nose
- Chrome

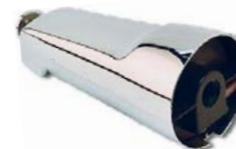

PART #	DESCRIPTION	UNIT ORDER	INN/MAS	PACK	LIST
15127	Slip-On with Set Screw	1	-/50	BOX	22.47

### DIVERTER SPOUT WITH BOTTOM OUTLET

- Zinc body
- Diverter on body
- With 3/4" to 1/2" IPS reducing face bushing
- 1/2" IPS outlet for hand held shower
- 5-1/4" Spout length



PART #	DESCRIPTION	UNIT ORDER	INN/MAS	PACK	LIST
15086	Chrome	1	-/50	BOX	12.76

## Tab and Diverter Spouts

### DIVERTER SPOUT WITH SIDE OUTLET

- Zinc body
- Diverter on body
- With 3/4" to 1/2" IPS reducing face bushing
- 1/2" IPS outlet for hand held shower
- 5-1/4" Spout length



PART #	DESCRIPTION	UNIT ORDER	INN/MAS	PACK	LIST
15087	Chrome	1	-/50	BOX	20.56

### DIVERTER SPOUT WITH NOSE OUTLET

- Fits Mixet®
- 1/2" IPS connection on nose
- 5-1/8" Spout length
- Die-cast zinc



PART #	DESCRIPTION	UNIT ORDER	INN/MAS	PACK	LIST
15130	Chrome	1	-/25	BOX	8.50
15132	Brushed Nickel	1	-/25	BOX	14.31

### DIVERTER SPOUT WITH FACE BUSHING

- Diverter on body
- 3/4" IPS inlet
- With 3/4" to 1/2" IPS reducing face bushing
- 5-1/4" Spout length



PART #	DESCRIPTION	UNIT ORDER	INN/MAS	PACK	LIST
15085	Zinc Body - Chrome	1	-/50	BOX	10.04
15081	Brass Body - Chrome	1	-/30	BOX	41.68

### DIVERTER SPOUT WITH FACE BUSHING

- Fits Mixet®
- Fits 1/2" copper and 1/2" or 3/4" IPS inlet
- 5-1/2" Spout length
- Die-cast zinc body
- Diverter on nose
- With 3/4" to 1/2" IPS reducing face bushing
- Includes hex wrench



PART #	DESCRIPTION	UNIT ORDER	INN/MAS	PACK	LIST
15128	Chrome	1	-/50	BOX	16.57

## BRASS REDUCING BUSHING

- Flush bushing



PART #	DESCRIPTION	UNIT ORDER	INN/MAS	PACK	LIST
15115	1/2" MIP x 3/8" FIP	1	-/100	BOX	2.65
15117	3/4" MIP x 1/2" FIP	1	-/100	BOX	3.62

## Shower Drains

### NO-CAULK SHOWER DRAIN WITH WRENCH

- Includes locking wrench
- Installs to pipe from above shower drain
- 2"



PART #	DESCRIPTION	UNIT ORDER	INN/MAS	PACK	LIST
15308	PVC - Stainless Steel	1	-/40	BOX	9.78
15312	ABS - Stainless Steel	1	-/40	BOX	12.94

### NO-CAULK SHOWER DRAIN

- Sch. 40 PVC DWV
- Snap-in strainer
- Push-on, no-caulk gasket
- Locknut tightens from underside
- 2"



PART #	DESCRIPTION	UNIT ORDER	INN/MAS	PACK	LIST
15305	Stainless Grid	1	-/40	BOX	9.29
15303	Plastic Grid	1	-/40	BOX	7.19

### DROP-IN SHOWER DRAIN

- 2" Solvent weld
- Drain body drops through shower base
- Stainless steel snap-in grid
- Locknut tightens from underside



PART #	DESCRIPTION	UNIT ORDER	INN/MAS	PACK	LIST
15314	PVC	1	-/40	BOX	9.95
15316	ABS	1	-/40	BOX	9.95

# TUBULAR AND DRAINAGE

## Shower Drains

### 45° SHOWER DRAIN

- Provides a drain for water from a shower when the installation depth is restricted or obstructed
- Designed with a 45° discharge
- Hub connection
- No screws required to secure cover



PART #	DESCRIPTION	UNIT ORDER	INN/MAS	PACK	LIST
73019	1-1/2" - 2"	1	-/8	BULK	23.46

### NO-CAULK BRASS SHOWER DRAIN

- 2"
- Stainless steel grid
- Includes locking wrench
- Installs to pipe from above shower drain



PART #	DESCRIPTION	UNIT ORDER	INN/MAS	PACK	LIST
15306	IPS	1	-/40	BOX	21.52

### SOLVENT WELD SHOWER DRAIN

- Sch. 40 PVC DWV
- Solvent weld
- 2" PVC
- Locknut tightens from underside



PART #	DESCRIPTION	UNIT ORDER	INN/MAS	PACK	LIST
15309	Stainless Grid	1	-/40	BOX	7.27

### IPS SHOWER DRAIN

- Zinc body
- IPS connection
- Stainless steel grid



PART #	DESCRIPTION	UNIT ORDER	INN/MAS	PACK	LIST
15315	1-1/2" IPS	10	10/200	BOX	3.34
15317	2" IPS	10	10/200	BOX	3.34

## LOW-PROFILE FLOOR & SHOWER DRAIN

- With membrane clamping ring and tailpiece
- Fits over 2" sch. 40 or inside 3" sch. 40 DWV pipe
- Stainless steel grid - screw-on
- For use in clamping waterproof membrane or composition pan liner
- 4" Strainer drain



PART #	DESCRIPTION	UNIT ORDER	INN/MAS	PACK	LIST
15301	2" x 3" PVC	1	-/20	BOX	16.34
15342	2" x 3" ABS	1	-/20	BOX	19.02

## LOW-PROFILE SHOWER DRAIN

- 4" Square grate
- For tiled shower basins



PART #	DESCRIPTION	UNIT ORDER	INN/MAS	PACK	LIST
73018	2"	1	-/10	BULK	26.05

## SHOWER PAN DRAIN WITH TEST PLUG

- Double-duty seals for DWV pressure test and shower pan water test
- No blow-up balls, glue-in wafers or mechanical plugs
- Easy install and removal
- Stainless steel



PART #	DESCRIPTION	UNIT ORDER	INN/MAS	PACK	LIST
73016	ABS Screw-On Strainer	1	-/10	BULK	19.39
73017	PVC Screw-On Strainer	1	-/10	BULK	19.39

## General-Purpose Drains

### 2" X 3" GENERAL-PURPOSE DRAIN

- Stainless steel strainer
- Solvent weld



PART #	DESCRIPTION	UNIT ORDER	INN/MAS	PACK	LIST
15319	2" x 3" PVC	1	-/20	BOX	7.04



## General-Purpose Drains

### 3" X 4" GENERAL-PURPOSE DRAIN

- Stainless steel strainer
- Solvent weld



PART #	DESCRIPTION	UNIT ORDER	INN/MAS	PACK	LIST
15322	3" x 4" PVC	1	-/10	BOX	11.83
15324	3" x 4" ABS	1	-/10	BOX	10.72

## IN-LINE STRAINER

- Flexible horizontal or vertical installation, the outlet can be set anywhere in 360° range
- Internal filter screen
- Filter screen has 10 times the open area of the inlet and outlet connections providing easy, non-contact removal of captured debris



canplas<sup>®</sup>  
PLUMBING

PART #	DESCRIPTION	UNIT ORDER	INN/MAS	PACK	LIST
73024	ABS	1	-/4	BULK	61.90
73025	PVC	1	-/4	BULK	62.04

## Drain Strainers

### SNAP-IN STRAINER

- 4-1/2" Diameter



PART #	DESCRIPTION	UNIT ORDER	INN/MAS	PACK	LIST
15310	Stainless Steel	20	20/200	BULK	3.02

## Drain Fittings

### BRASS CLEANOUT PLUG

- Raised head
- Cast-brass



PART #	DESCRIPTION	UNIT ORDER	INN/MAS	PACK	LIST
42041	3"	1	-/120	BOX	9.46
42043	4"	1	-/90	BOX	13.61

### SCREW-IN STRAINER

- Stainless steel
- Includes screws
- Fits brass floor shower drains (15315 & 15317)

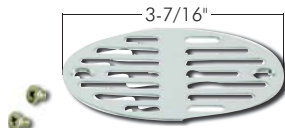

PART #	DESCRIPTION	UNIT ORDER	INN/MAS	PACK	LIST
15321	Stainless Steel with Screws	10	10/40	BAG	1.20

### BRASS CLEANOUT PLUG

- Countersunk head
- Cast-brass

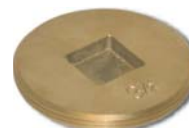

PART #	DESCRIPTION	UNIT ORDER	INN/MAS	PACK	LIST
42033	3"	1	-/120	BOX	9.02
42035	4"	1	-/90	BOX	13.69

### FLOOR DRAIN COVER

- Stainless steel cover
- Satin finish



PART #	DESCRIPTION	UNIT ORDER	INN/MAS	PACK	LIST
43470	For 2" Pipe - 3" OD	10	10/200	BOX	4.22
43471	For 3" Pipe - 4" OD	10	10/200	BOX	6.13
43472	For 4" Pipe - 5" OD	10	10/200	BOX	7.13

### SNAP-IN CLEANOUT

- Fits over 3" pipe



canplas<sup>®</sup>  
PLUMBING

PART #	DESCRIPTION	UNIT ORDER	INN/MAS	PACK	LIST
73020	3" x 3"	1	-/30	BULK	6.47

### PIPE-END DRAIN GATE

- Fits inside ABS or PVC DWV pipe
- Will not bend, rust or corrode
- Has knock-outs for drainage hoses from high-efficiency gas appliance, air conditioner, dehumidifiers, etc.



canplas<sup>®</sup>  
PLUMBING

PART #	DESCRIPTION	UNIT ORDER	INN/MAS	PACK	LIST
73013	3"	1	-/50	BULK	2.20
73014	4"	1	-/25	BULK	4.05

### CLEANOUT WITH PLUG

- Fits over 2" sch. 40 DWV or inside 3" sch. 40 DWV
- Built-in stop



PART #	DESCRIPTION	UNIT ORDER	INN/MAS	PACK	LIST
15327	2" x 3" PVC - 2" IPS (Plug Size)	1	-/80	BOX	6.13
15328	2" x 3" ABS - 2" IPS (Plug Size)	1	-/80	BOX	6.13
15329	3" x 4" PVC - 3" IPS (Plug Size)	1	-/80	BOX	9.27

Supply Connectors

Stop Valves

Water Heater

Gas Connectors

Water Filtration

Sinks/ Faucets

Tubular/ Drainage

Faucet Repair

Bath Accessories

Pipe Fittings/ Repair

Valves

Cements/ Sealants

Tools/ Safety

Toilet Repair

Appliance/ HVAC

Hardware

Electrical

Index

# TUBULAR AND DRAINAGE

## Drain Fittings

### CLEANOUT WITH BRASS PLUG

- Fits over 3" sch. 40 PVC DWV or inside 4" sch. 40 PVC DWV
- 3" IPS brass plug
- Built-in stop



PART #	DESCRIPTION	UNIT ORDER	INN/MAS	PACK	LIST
15336	3" x 4" PVC	1	-/80	BOX	20.35

### WATERLESS TRAP SEAL

- Insert proper sized Green Drain into existing floor drain, no tools or caulk required
- Water flows down - bugs, odors, and sewer gases stay out
- Easy to install and remove - no pliers needed
- Saves time, water, costs, and energy
- Better on the environment than a traditional trap primer



PART #	DESCRIPTION	UNIT ORDER	INN/MAS	PACK	LIST
15353	2"	1	-/24	BOX	79.83
15354	3"	1	-/24	BOX	87.45
15355	3-1/2"	1	-/24	BOX	87.51
15356	4"	1	-/24	BOX	95.03

### 2" SOLVENT WELD OUTLET

- One-piece construction
- Can use below grade
- 3-1/4" Sump bowl
- 2" Full-flow
- 2" Concealed cleanout



PART #	DESCRIPTION	UNIT ORDER	INN/MAS	PACK	LIST
15338	2" PVC	2	-/2	BOX	38.49

### BACKWATER VALVE

- Protects low-level areas from the backflow of sanitary sewer, storm sewer or septic system
- Positive seal created by neoprene O-ring
- Designed to allow easy inspection of valve
- Can be sleeved with 5" SDR 35 (sleeve not included)



PART #	DESCRIPTION	UNIT ORDER	INN/MAS	PACK	LIST
73008	3" PVC	1	-/10	BOX	28.20
73006	3" ABS	1	-/10	BOX	26.72
73009	4" PVC	1	-/4	BOX	38.72
73007	4" ABS	1	-/4	BOX	46.36

## Bath Waste Kits

### TRIP-LEVER BATH WASTE

- Polypropylene tube
- Adjusts to fit most bath tubs
- 1-1/2" Drain
- 2-Hole overflow plate
- Chrome-plated trim



PART #	DESCRIPTION	UNIT ORDER	INN/MAS	PACK	LIST
35207	Plastic Strainer	5	5/10	BOX	16.77
35213	Stainless Steel Strainer	5	5/10	BOX	23.15

### LIFT & LOCK BATH WASTE

- Polypropylene tube
- Adjusts to fit most bath tubs
- 1-1/2" Drain
- 2-Hole overflow plate
- Chrome-plated trim



PART #	DESCRIPTION	UNIT ORDER	INN/MAS	PACK	LIST
35215	Lift-N-Lock	5	5/10	BOX	24.95

### TIP-TOE BATH WASTE

- Polypropylene tube
- Adjusts to fit most bath tubs
- 1-1/2" Drain
- 2-Hole overflow plate
- Chrome-plated trim



PART #	DESCRIPTION	UNIT ORDER	INN/MAS	PACK	LIST
35217	Tip-Toe	5	5/10	BOX	24.46

## Bath Waste Kits

### TRIP-LEVER BRASS BATH WASTE

- 20-Gauge brass tubular
- 1-1/2" Drain
- 2-Hole overflow plate
- Chrome-plated trim



PART #	DESCRIPTION	UNIT ORDER	INN/MAS	PACK	LIST
35201	Brass Strainer	6	6/12	BOX	73.50

### LIFT & LOCK BRASS BATH WASTE

- 20-Gauge brass tubular
- 1-1/2" Drain
- 2-Hole overflow plate
- Chrome-plated trim



PART #	DESCRIPTION	UNIT ORDER	INN/MAS	PACK	LIST
35203	Lift-N-Lock	6	6/12	BOX	75.21

### TIP-TOE BRASS BATH WASTE

- 20-Gauge brass tubular
- 1-1/2" Drain
- 2-Hole overflow plate
- Chrome-plated trim



PART #	DESCRIPTION	UNIT ORDER	INN/MAS	PACK	LIST
35205	Tip-Toe	6	6/12	BOX	75.21

### SCH. 40 PVC ONE-HOLE BATH WASTE

- 1-1/2" Sch. 40 PVC
- Complete sch. 40 kit with pipe and tee
- One-hole face plate
- All drains 3/8" thread
- Lift-n-lock stopper
- Chrome-plated trim



PART #	DESCRIPTION	UNIT ORDER	INN/MAS	PACK	LIST
35287	Zinc Drain	1	-/12	BOX	29.80

### SCH. 40 ABS ONE-HOLE BATH WASTE

- 1-1/2" Sch. 40 ABS
- Complete sch. 40 kit with pipe and tee
- One-hole face plate
- All drains 3/8" thread
- Lift-n-lock stopper
- Chrome-plated trim



PART #	DESCRIPTION	UNIT ORDER	INN/MAS	PACK	LIST
35291	Zinc Drain	1	-/12	BOX	33.70

### SCH. 40 PVC TWO-HOLE BATH WASTE

- 1-1/2" Sch. 40 PVC
- Complete sch. 40 kit with pipe and tee
- Two-hole face plate
- All drains 3/8" thread
- Lift-n-lock stopper
- Chrome-plated trim



PART #	DESCRIPTION	UNIT ORDER	INN/MAS	PACK	LIST
35293	Brass Drain	1	-/12	BOX	40.17

Supply Connectors

Stop Valves

Water Heater

Gas Connectors

Water Filtration

Sinks/Faucets

Tubular/Drainage

Faucet Repair

Bath Accessories

Pipe Fittings/Repair

Valves

Cements/Sealants

Tools/Safety

Toilet Repair

Appliance/HVAC

Hardware

Electrical

Index

# TUBULAR AND DRAINAGE

## Bath Waste Kits

### SCH. 40 ABS TWO-HOLE BATH WASTE

- 1-1/2" Sch. 40 ABS
- Complete sch. 40 kit with pipe and tee
- Two-hole face plate
- All drains 3/8" thread
- Lift-n-lock stopper
- Chrome-plated trim



PART #	DESCRIPTION	UNIT ORDER	INN/MAS	PACK	LIST
35298	Zinc Drain	1	-/12	BOX	30.57

### SCH. 40 PVC TWO-HOLE DECORATIVE BATH WASTE

- 1-1/2" Sch. 40 PVC
- Complete sch. 40 kit with pipe and tee
- Two-hole face plate
- All drains 3/8" thread
- Lift-n-lock stopper
- PVD lifetime finish



PART #	DESCRIPTION	UNIT ORDER	INN/MAS	PACK	LIST
35296	PVD Brushed Nickel Trim	1	-/12	BOX	54.89

## Half Bath Waste Kits

### SCH. 40 ONE-HOLE BATH WASTE WITH TEST KIT

- Lift-n-lock stopper
- With one-hole test kit
- 3/8" Thread
- Die-cast drain body



PART #	DESCRIPTION	UNIT ORDER	INN/MAS	PACK	LIST
35232	1-1/2" Sch. 40 PVC	1	-/20	BOX	23.27
35222	1-1/2" Sch. 40 ABS	1	-/20	BOX	23.27

### SCH. 40 ONE-HOLE BATH WASTE WITH TEST KIT

- Tip-toe stopper
- With one-hole test kit
- 3/8" Thread
- Die-cast drain body



PART #	DESCRIPTION	UNIT ORDER	INN/MAS	PACK	LIST
35228	1-1/2" Sch. 40 PVC	1	-/20	BOX	23.21
35226	1-1/2" Sch. 40 ABS	1	-/20	BOX	23.27

### SCH. 40 LIFT-N-LOCK BATH WASTE WITH TEST KIT

- Lift-n-lock stopper
- With test kit & cross bar
- Two-hole elbow
- Furnished with one-hole face plate
- Die-cast drain body
- 3/8" Threaded drain
- Half kit



PART #	DESCRIPTION	UNIT ORDER	INN/MAS	PACK	LIST
35273	1-1/2" Sch. 40 PVC	1	-/20	BOX	19.83
35264	1-1/2" Sch. 40 ABS	1	-/20	BOX	23.21

### SCH. 40 TIP-TOE STOPPER BATH WASTE WITH TEST KIT

- Tip-toe stopper
- With test kit & cross bar
- Two-hole elbow
- Furnished with one-hole face plate
- Die-cast drain body
- 3/8" Threaded drain
- Half kit



PART #	DESCRIPTION	UNIT ORDER	INN/MAS	PACK	LIST
35272	1-1/2" Sch. 40 PVC	1	-/20	BOX	23.12
35270	1-1/2" Sch. 40 ABS	1	-/20	BOX	24.43

## Half Bath Waste Kits

### SCH. 40 ONE-HOLE BATH WASTE

- Lift-n-lock stopper
- Includes all trim
- Brass drain body
- Half kit
- Includes test kit



PART #	DESCRIPTION	UNIT ORDER	INN/MAS	PACK	LIST
35220	1-1/2" Sch. 40 PVC	1	-/20	BOX	20.96

### SCH. 40 TWO-HOLE BATH WASTE

- Tip-toe stopper
- 3/8" Thread
- Includes all trim
- Die-cast drain body
- Half kit
- Includes test kit



PART #	DESCRIPTION	UNIT ORDER	INN/MAS	PACK	LIST
35277	1-1/2" Sch. 40 PVC	1	-/20	BOX	22.90
35284	1-1/2" Sch. 40 ABS	1	-/20	BOX	21.81

### SCH. 40 PVC ONE-HOLE DECORATIVE BATH WASTE

- Lift-n-lock stopper
- Includes all trim
- 1-1/2" Sch. 40 PVC
- PVD lifetime finish
- Half kit
- Includes test kit



PART #	DESCRIPTION	UNIT ORDER	INN/MAS	PACK	LIST
35210	PVD Brushed Nickel Trim	1	-/20	BOX	30.51

### SCH. 40 ABS ONE-HOLE DECORATIVE BATH WASTE

- Lift-n-lock stopper
- Includes all trim
- 1-1/2" Sch. 40 ABS
- PVD lifetime finish
- Half kit
- Includes test kit



PART #	DESCRIPTION	UNIT ORDER	INN/MAS	PACK	LIST
35211	PVD Brushed Nickel Trim	1	-/20	BOX	30.51

## Bath Waste Parts

### REPLACEMENT CROSS BAR

- Secures overflow elbow to tub
- Converts two-hole to one-hole face plate
- Includes screws



PART #	DESCRIPTION	UNIT ORDER	INN/MAS	PACK	LIST
35283	Aluminum Cross Bar	10	10/200	BAG	3.16

### SCH. 40 PVC WASTE SHOE

- Coarse thread
- 1-1/2" Dia. x 11.5 threads
- Solvent weld



PART #	DESCRIPTION	UNIT ORDER	INN/MAS	PACK	LIST
35275	1-1/2" PVC	10	10/100	BAG	2.45

### BRASS WASTE & OVERFLOW SHOE

- 1-1/2" Overflow shoe
- 1-3/8" x 16 Fine threads
- Chrome strainer body



PART #	DESCRIPTION	UNIT ORDER	INN/MAS	PACK	LIST
35224	Brass Shoe	5	5/30	BOX	23.58

### BRASS & PVC WASTE & OVERFLOW SHOE

- 1-1/2" Tubular outlet
- Coarse thread 1-1/2" dia. x 11.5 threads
- Fine thread 1-3/8" x 16 threads



PART #	DESCRIPTION	UNIT ORDER	INN/MAS	PACK	LIST
35237	Brass - Coarse Thread	5	5/50	BOX	19.87
35238	Brass - Fine Thread	5	5/50	BOX	16.68
35239	PVC - Coarse Thread	5	5/100	BOX	3.22

### TUB SHOE GASKET

- 2-5/8" OD x 1-3/4" ID x 3/32"



PART #	DESCRIPTION	UNIT ORDER	INN/MAS	PACK	LIST
36301	Black Rubber	15	-/15	BULK	0.60

Supply Connectors

Stop Valves

Water Heater

Gas Connectors

Water Filtration

Sinks/Faucets

Tubular/Drainage

Faucet Repair

Bath Accessories

Pipe Fittings/Repair

Valves

Cements/Sealants

Tools/Safety

Toilet Repair

Appliance/HVAC

Hardware

Electrical

Index

# TUBULAR AND DRAINAGE

## Bath Drains

### TRIP-LEVER BATH DRAIN ASSEMBLY

- Brass body with stainless steel grid
- Tapped 10/24
- Includes drain washer
- Chrome

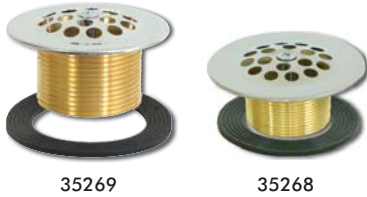

PART #	DESCRIPTION	UNIT ORDER	INN/MAS	PACK	LIST
35268	1-3/8" x 16 Fine Thread	10	10/100	BOX	10.12
35269	1-1/2" x 11.5 Coarse Thread	10	10/100	BOX	10.98

### LIFT & TURN BATH DRAIN ASSEMBLY

- Zinc body
- 2-7/8" OD flange
- Tapped 5/16
- Includes drain washer
- Chrome



PART #	DESCRIPTION	UNIT ORDER	INN/MAS	PACK	LIST
35231	1-3/8" x 16 Fine Thread	10	10/100	BAG	8.70
35233	1-1/2" x 11.5 Coarse Thread	10	10/100	BAG	8.70

### TIP-TOE BATH DRAIN ASSEMBLY

- 1-1/2" x 11.5 Coarse thread
- Zinc body
- 2-7/8" OD flange
- Includes drain washer
- 5/16" Tapped



PART #	DESCRIPTION	UNIT ORDER	INN/MAS	PACK	LIST
35235	Chrome-Plated	10	10/100	BAG	8.70

### TIP-TOE BATH DRAIN ASSEMBLY

- 1-3/8" x 16 Fine thread
- Zinc body
- 2-7/8" OD flange
- Includes drain washer
- 3/8" Tapped



PART #	DESCRIPTION	UNIT ORDER	INN/MAS	PACK	LIST
35234	Chrome-Plated	10	10/100	BAG	9.64

### LIFT & TURN BATH DRAIN ASSEMBLY

- Brass body
- Tapped 10/24
- 1-3/8" x 16 Fine thread
- Chrome-plated



PART #	DESCRIPTION	UNIT ORDER	INN/MAS	PACK	LIST
35266	Fits Price Pfister®	10	10/200	BOX	15.68

### LIFT & TURN BATH DRAIN ASSEMBLY

- Brass body
- O-ring sealed
- 1-5/8" x 14 TPI
- Chrome-plated



PART #	DESCRIPTION	UNIT ORDER	INN/MAS	PACK	LIST
35250	Fits Sayco®	10	10/100	BOX	19.82

### TIP-TOE BATH DRAIN ASSEMBLY

- Chrome-plated ABS cartridge
- Brass strainer body
- Includes 2 plastic adapters to adapt from 1-3/8" x 16 fine thread to 1-1/2" x 11.5 coarse thread or 2-1/8" x 16 Kohler® fine thread



PART #	DESCRIPTION	UNIT ORDER	INN/MAS	PACK	LIST
35236	Tip-Toe Drain	10	10/100	BAG	16.39

## Bath Drain Parts

### BATH STRAINER BODY

- 1-1/2" x 11-1/2 Coarse thread
- Chrome-plated
- Zinc body



PART #	DESCRIPTION	UNIT ORDER	INN/MAS	PACK	LIST
35257	5/16" Tapped	10	10/100	BOX	9.07
35256	3/8" Tapped	10	10/100	BOX	7.47

## Bath Drain Parts

### BATH STRAINER BODY

- 1-3/8" x 16 Fine thread
- Chrome-plated
- Zinc body



PART #	DESCRIPTION	UNIT ORDER	INN/MAS	PACK	LIST
35262	5/16" Tapped	10	10/100	BOX	2.48
35263	3/8" Tapped	10	10/100	BOX	6.36

\*While Supplies Last

### BATH STRAINER BODY

- 1-3/8" x 16 Fine thread
- Fits Gerber®
- Chrome-plated
- Zinc body



PART #	DESCRIPTION	UNIT ORDER	INN/MAS	PACK	LIST
35258	Tapped 10/24	10	10/100	BAG	7.64

### BATH STRAINER BODY

- 1-3/8" x 16 Fine thread
- Fits lift-n-turn (35231)
- Chrome-plated
- Zinc body



PART #	DESCRIPTION	UNIT ORDER	INN/MAS	PACK	LIST
35259	Tapped 1/4-20	10	10/100	BOX	7.64

### FINE-THREAD ADAPTERS

- 1-3/8" x 16 TPI fine thread adapter
- Plastic adapters



PART #	DESCRIPTION	UNIT ORDER	INN/MAS	PACK	LIST
35279	1-1/2" x 11.5 Coarse Thread	10	10/250	BULK	3.51
35280	2-1/8" x 16 Fine Thread (Kohler®)	10	10/250	BULK	3.82

### ROUND-TO-SQUARE STRAINER KIT

- (1) Round-to-square adapter
- (1) Square stainless steel strainer
- (2) Sets of screws
- Includes illustrated instruction sheet for easy installation



PART #	DESCRIPTION	UNIT ORDER	INN/MAS	PACK	LIST
73015	Stainless Steel	1	-/5	CLAM	8.78

### BATH DRAIN STRAINER



PART #	DESCRIPTION	UNIT ORDER	INN/MAS	PACK	LIST
35261	2" Snap-In - Stainless Steel Domed	10	10/1000	BAG	0.86
35271	2-7/8" - 10/24 x 1-3/4" Screw - Fits Gerber®	10	10/500	BAG	1.32
35252	Strainer and Screw Brushed Nickel Finish	10	10/250	BAG	5.45

### Bath Drain Stoppers

#### TIP-TOE DRAIN STOPPER

- ABS body
- Chrome-plated finish
- Tip-toe style with rubber seal



PART #	DESCRIPTION	UNIT ORDER	INN/MAS	PACK	LIST
35227	5/16" Thread	10	10/200	BAG	4.68
35229	3/8" Thread	10	10/200	BAG	5.25
36291	Gasket Only	10	10/1000	BAG	0.54

Supply Connectors

Stop Valves

Water Heater

Gas Connectors

Water Filtration

Sinks/ Faucets

Tubular/ Drainage

Faucet Repair

Bath Accessories

Pipe Fittings/ Repair

Valves

Cements/ Sealants

Tools/ Safety

Toilet Repair

Appliance/ HVAC

Hardware

Electrical

Index

# TUBULAR AND DRAINAGE

## Bath Drain Stoppers

### SNAP & PRESS STOPPER

- Fits Casper®
- ABS construction
- Chrome-plated finish
- Snap & press style with rubber seal



PART #	DESCRIPTION	UNIT ORDER	INN/MAS	PACK	LIST
*35242	5/16" Thread	10	10/200	BAG	5.84
35240	3/8" Thread	10	10/200	BAG	5.62

\*While Supplies Last

### SNAP & PRESS STOPPER

- Fits Rapid Fit®
- ABS construction
- Chrome-plated finish
- Snap & press style with rubber seal



PART #	DESCRIPTION	UNIT ORDER	INN/MAS	PACK	LIST
35251	5/16" Thread	10	10/100	BAG	3.74
35253	3/8" Thread	10	10/100	BAG	4.68

### LIFT & TURN DRAIN STOPPER

- Brass body
- 3/8" Brass stem with extra 5/16" brass stem



PART #	DESCRIPTION	UNIT ORDER	INN/MAS	PACK	LIST
35255	Chrome-Plated	25	25/100	BAG	19.79

### LIFT & TURN STOPPER

- Stopper only
- Fits #35266 drain assembly
- Fits Price Pfister®



PART #	DESCRIPTION	UNIT ORDER	INN/MAS	PACK	LIST
35260	Stopper Only	1	100/500	BAG	8.64

### FLIP-IT® STOPPER

- Unique ball-shift toggle system which opens and closes the drain with a simple push of the toe or finger
- Chrome-plated finish
- Includes 10 different O-rings to fit all brands
- Fits most strainer bodies



flip-it®

PART #	DESCRIPTION	UNIT ORDER	INN/MAS	PACK	LIST
35249	Flip-It® Stopper	1	50/100	BAG	11.03

### POP-UP AND CAM LINKAGE STOPPER

- 1-7/8" Diameter



PART #	DESCRIPTION	UNIT ORDER	INN/MAS	PACK	LIST
*35212	1-7/8" Diameter	1	-/200	BAG	2.85

\*While Supplies Last

### POP-UP AND CAM LINKAGE STOPPER

- 1-7/8" Diameter
- O-ring sealed
- Fits Gerber®



PART #	DESCRIPTION	UNIT ORDER	INN/MAS	PACK	LIST
*35206	1-7/8" Diameter	1	-/200	BAG	2.85

\*While Supplies Last

### BRASS LINKAGE ASSEMBLY

- Replacement for trip-lever

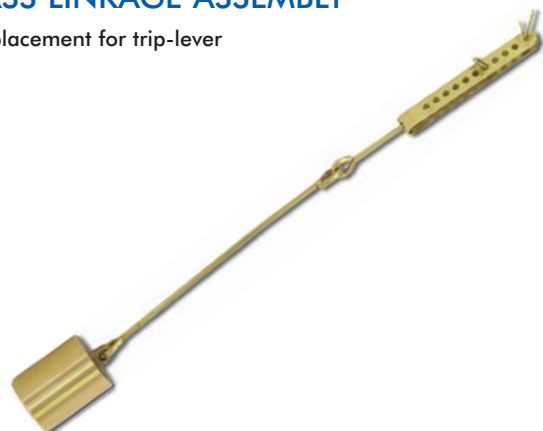

PART #	DESCRIPTION	UNIT ORDER	INN/MAS	PACK	LIST
35225	Universal Fit-All	20	20/200	BULK	9.12



## Overflow Face Plates

### TRIP-LEVER OVERFLOW FACE PLATE

- Handle & clip
- Zinc
- Includes brass screws



PART #	DESCRIPTION	UNIT ORDER	INN/MAS	PACK	LIST
35243	Chrome	20	20/400	BAG	4.38

### OVERFLOW FACE PLATE

- Two-hole
- Decorative finish
- Includes brass screws
- PVD lifetime finish



PART #	DESCRIPTION	UNIT ORDER	INN/MAS	PACK	LIST
35214	PVD Polished Brass	1	-/20	BAG	11.83

### OVERFLOW FACE PLATE

- One-hole
- Decorative finish
- Includes brass screws
- PVD lifetime finish



PART #	DESCRIPTION	UNIT ORDER	INN/MAS	PACK	LIST
35202	PVD Brushed Nickel	1	-/20	BAG	9.27

### OVERFLOW FACE PLATE

- Chrome
- Zinc-plated



35247



35245



35246



35244

PART #	DESCRIPTION	UNIT ORDER	INN/MAS	PACK	LIST
35247	One-Hole Round with Brass Screw	20	20/400	BAG	2.59
35245	Two-Hole Round with Brass Screws	20	20/400	BAG	3.15
35246	One-Hole Round without Screw	20	20/200	BAG	2.30
35244	Two-Hole Round without Screws	20	20/200	BAG	2.30

Supply  
Connectors

Stop  
Valves

Water  
Heater

Gas  
Connectors

Water  
Filtration

Sinks/  
Faucets

Tubular/  
Drainage

Faucet  
Repair

Bath  
Accessories

Pipe Fittings/  
Repair

Valves

Cements/  
Sealants

Tools/  
Safety

Toilet  
Repair

Appliance/  
HVAC

Hardware

Electrical

Index

# TUBULAR AND DRAINAGE

## Overflow Parts

### BRASS SCREWS - FACE PLATE

- Chrome-plated brass
- Slot-head
- Sold & priced per bag of 100



PART #	DESCRIPTION	UNIT ORDER	INN/MAS	PACK	LIST
35267	1/4-20 Thread x 1-1/2"	1	-/20	BAG	61.04

### OVERFLOW GASKET

- 2-1/8" ID x 3-5/16" OD beveled
- Channel groove to fit Price Pfister® & Sayco®



PART #	DESCRIPTION	UNIT ORDER	INN/MAS	PACK	LIST
36307	Molded Rubber	1	-/500	BULK	1.80

### OVERFLOW GASKET

- 2-1/8" ID x 3-5/16" OD beveled from 3/16" to 9/16"



PART #	DESCRIPTION	UNIT ORDER	INN/MAS	PACK	LIST
36305	Sponge Rubber	1	-/500	BULK	1.45

## SEE COMPLETE COLLECTION OF BATH ACCESSORIES!!

Including **NEW** Showerheads and Handheld Showers

See pages... **147-148**



Visit us online at...

[www.ez-flo.net](http://www.ez-flo.net)

## Pop-Up Replacement Parts

### POP-UP REPLACEMENT PARTS

- Universal fit



30383



30386

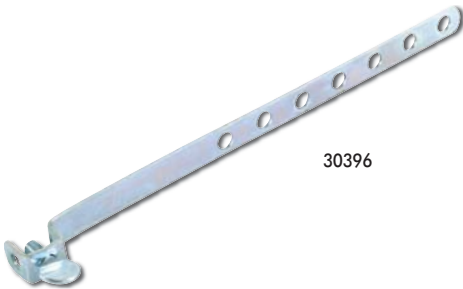

30396



30397



36223

PART #	DESCRIPTION	UNIT ORDER	INN/MAS	PACK	LIST
30383	ABS Plug with Stainless Steel Trim 3-5/8" x 1-1/4" Diameter	10	50/250	BULK	2.14
30386	Ball Crank & Nut	10	50/250	BULK	2.37
30396	Nickel-Plated Rod Strap	10	10/200	BULK	0.94
30397	Chrome-Plated Lift Rod with Knob	10	10/200	BULK	1.80
36221	Rubber 1-1/4" Mack Gasket	10	-/100	BULK	0.63
36223	Rubber 1-1/2" Mack Gasket	25	500/1000	BULK	0.63
30381	Chrome 3-Piece Set Includes #30386, #30396, and #30397	10	25/200	BULK	4.39

## Pop-Up Stoppers

### UNIVERSAL STOPPER

- ABS with stainless steel trim
- Universal fit



PART #	DESCRIPTION	UNIT ORDER	INN/MAS	PACK	LIST
30401	4-1/2" x 1-3/8" Diameter	10	10/200	BULK	1.68

### POP-UP STOPPER

- Fits Delta® & Peerless®
- ABS with stainless steel trim



PART #	DESCRIPTION	UNIT ORDER	INN/MAS	PACK	LIST
32191	5" x 1-3/8" Diameter	10	10/100	BULK	2.28

### POP-UP STOPPER - ABS

- Fits Delta® & Peerless®
- ABS with polished brass trim



PART #	DESCRIPTION	UNIT ORDER	INN/MAS	PACK	LIST
*90107	5" x 1-3/8" Diameter	10	10/200	BULK	2.14

\*While Supplies Last

### POP-UP STOPPER - ABS

- Fits Gerber® & Sayco®
- ABS with stainless steel trim



PART #	DESCRIPTION	UNIT ORDER	INN/MAS	PACK	LIST
30431	4-1/8" x 1-1/4" Diameter	10	10/100	BULK	2.68

Supply Connectors

Stop Valves

Water Heater

Gas Connectors

Water Filtration

Sinks/ Faucets

Tubular/ Drainage

Faucet Repair

Bath Accessories

Pipe Fittings/ Repair

Valves

Cements/ Sealants

Tools/ Safety

Toilet Repair

Appliance/ HVAC

Hardware

Electrical

Index

# FAUCET REPAIR

## Pop-Up Stoppers

### POP-UP STOPPER - ABS

- Fits Moen®
- ABS with stainless steel trim



PART #	DESCRIPTION	UNIT ORDER	INN/MAS	PACK	LIST
32351	4" x 1-5/16" Diameter	10	10/100	BULK	2.28

### POP-UP STOPPER - ABS

- Fits Price Pfister®
- ABS with stainless steel trim



PART #	DESCRIPTION	UNIT ORDER	INN/MAS	PACK	LIST
30383	3-5/8" x 1-1/4" Diameter	10	50/250	BULK	2.14

### POP-UP STOPPER - ABS

- Fits Sayco®
- ABS with stainless steel trim



PART #	DESCRIPTION	UNIT ORDER	INN/MAS	PACK	LIST
30435	4-1/8" x 1-1/4" Diameter	10	10/100	BULK	2.28

## Faucet Installation Parts

### FAUCET INSTALLATION KITS

- 30195 12-Piece set includes 2 each: 1/2" brass slip-joint nut, 1/2" cone washer, 1/2" friction ring, 1/2" locknut, faucet rosette & rubber washer
- 30196 6-Piece set includes 2 each: 1/2" PVC locknut, faucet rosette & rubber washer



30195

30196

PART #	DESCRIPTION	UNIT ORDER	INN/MAS	PACK	LIST
30195	12-Piece Set - 1/2" IPS Connections	10	10/200	BAG	3.74
30196	6-Piece Set - 1/2" IPS Connections	10	10/200	BAG	1.28

### FAUCET LOCKNUT

- 1/2" FIP



PART #	DESCRIPTION	UNIT ORDER	INN/MAS	PACK	LIST
35019	1/2" Die-Cast	10	250/500	BULK	0.71

### FAUCET LOCKNUT AND BASIN ROSETTE

- Sold and priced per bag of 20



PART #	DESCRIPTION	UNIT ORDER	INN/MAS	PACK	LIST
30197	1/2" Plastic Locknut - Bag of 20	1	1/10	BAG	4.28
30199	1/2" Basin Rosette - Bag of 20	1	1/10	BAG	10.64

### SUPPLY LINE NUTS

- Brass slip-joint nut for washer supply lines
- Sold & priced by the pair
- Chrome-plated finish



PART #	DESCRIPTION	UNIT ORDER	INN/MAS	PACK	LIST
30190	1/2" x 1/2" IPS - 1 Pair	10	10/500	BULK	2.88

### FAUCET MOUNTING KIT

- For single-handle lavatory faucets
- (2) Each - bolts and nuts
- Sold and priced by the pair



PART #	DESCRIPTION	UNIT ORDER	INN/MAS	PACK	LIST
30194	Faucet Mounting Kit	10	10/100	BAG	1.97

## Faucet Aerators

### FAUCET AERATOR - DUAL-THREADS

- Dual-thread aerator with male or female threads
- 15/16" - 27-Thread male x 55/64" - 27-thread female
- 10 per tube - priced each



PART #	DESCRIPTION	UNIT ORDER	INN/MAS	PACK	LIST
30151LF	Chrome - 2.0 GPM	10	10/500	BULK	1.66

### FAUCET AERATOR - FEMALE THREADS

- For use on spouts with male threads
- 55/64" - 27-Thread female
- 10 per tube - priced each



PART #	DESCRIPTION	UNIT ORDER	INN/MAS	PACK	LIST
30155LF	Chrome - 2.0 GPM	10	10/500	BULK	1.74

### LOW-FLOW AERATOR

- Dual-thread aerator with male or female threads
- 15/16" - 27-Thread male x 55/64" - 27-thread female
- 10 per tube - priced each



PART #	DESCRIPTION	UNIT ORDER	INN/MAS	PACK	LIST
30292LF	Chrome - .5 GPM	10	10/500	BULK	2.00
30293LF	Chrome - 1.5 GPM	10	10/500	BULK	2.00

### FAUCET AERATOR - MALE THREADS

- For use on spouts with female threads
- 13/16" - 27-Thread male
- 10 per tube - priced each



PART #	DESCRIPTION	UNIT ORDER	INN/MAS	PACK	LIST
30159LF	Chrome - 2.0 GPM	10	10/500	BULK	2.05

### HONEYCOMB LOW-FLOW AERATOR

- Dual-thread aerator with male or female threads
- 15/16" - 27-Thread male x 55/64" - 27-thread female
- 10 per tube - priced each



PART #	DESCRIPTION	UNIT ORDER	INN/MAS	PACK	LIST
30294LF	Chrome - 1 GPM	10	10/500	BULK	2.16
30295LF	Chrome - 1.5 GPM	10	10/1000	BULK	2.28

### GARDEN HOSE ADAPTER

- Adapts to 3/4" hose thread
- Dual-thread



PART #	DESCRIPTION	UNIT ORDER	INN/MAS	PACK	LIST
30164LF	15/16" Male x 55/64" Female	10	10/200	BULK	3.56

### DUAL-THREAD SNAP FITTING WITH AERATOR

- Chrome



PART #	DESCRIPTION	UNIT ORDER	INN/MAS	PACK	LIST
30168LF	Large Standard	10	10/200	BULK	4.80

Supply Connectors

Stop Valves

Water Heater

Gas Connectors

Water Filtration

Sinks/Faucets

Tubular/Drainage

Faucet Repair

Bath Accessories

Pipe Fittings/Repair

Valves

Cements/Sealants

Tools/Safety

Toilet Repair

Appliance/HVAC

Hardware

Electrical

Index

# FAUCET REPAIR

## Faucet Accessories

### PULL-DOWN SPRAY HEAD

- Fits EZ-FLO® 10388 and 10389



PART #	DESCRIPTION	UNIT ORDER	INN/MAS	PACK	LIST
32376	Chrome	1	-/30	BULK	14.11
32377	Brushed Nickel	1	-/30	BULK	17.99

### KITCHEN PULL-OUT SPRAY HEAD

- Fits EZ-FLO® 10382 and 10383



PART #	DESCRIPTION	UNIT ORDER	INN/MAS	PACK	LIST
32382	Chrome	1	-/20	BULK	19.44
32383	Brushed Nickel	1	-/20	BULK	24.47

### PULL-OUT KITCHEN SPRAY HEAD

- Fits EZ-FLO® Impressions Collection 10203 and 10204

**NEW**



PART #	DESCRIPTION	UNIT ORDER	INN/MAS	PACK	LIST
30236	Chrome	1	-/10	BULK	17.29
30246	Brushed Nickel	1	-/10	BULK	18.34

### PULL-OUT SPRAY HEAD

- Fits EZ-FLO® pull-out spray faucets



PART #	DESCRIPTION	UNIT ORDER	INN/MAS	PACK	LIST
30234	Chrome-Plated Metal	1	-/50	BULK	24.95
30238	Brushed Nickel	1	-/50	BULK	28.20

### KITCHEN FAUCET PULL-DOWN HOSE

- Fits EZ-FLO® 10388 and 10389



PART #	DESCRIPTION	UNIT ORDER	INN/MAS	PACK	LIST
32380	Hose	1	-/20	BULK	9.32

### KITCHEN FAUCET PULL-OUT HOSE

- Fits EZ-FLO® 10382 and 10383



PART #	DESCRIPTION	UNIT ORDER	INN/MAS	PACK	LIST
32381	Hose	1	-/20	BULK	8.78

## Faucet Accessories

### KITCHEN FAUCET PULL-OUT HOSE

- Fits EZ-FLO® Impressions Collection 10203 and 10204



PART #	DESCRIPTION	UNIT ORDER	INN/MAS	PACK	LIST
32390	Chrome Nut	1	-/10	BULK	15.26
32391	Brushed Nickel Nut	1	-/10	BULK	18.31

### KITCHEN FAUCET HOSE AND SPRAY



30171



30173



30175



30179



PART #	DESCRIPTION	UNIT ORDER	INN/MAS	PACK	LIST
30171	Black Spray Head with Hose & Guide	10	10/100	BULK	10.64
30173	Black Spray Head Only	10	10/250	BULK	5.25
30175	White Spray Head Only	10	10/250	BULK	5.50
30179	Chrome-Plated Trim Guide Only	10	10/100	BULK	1.97

### SIDE SPRAYER WITH HOSE

- Fits EZ-FLO® Impressions Collection faucets



PART #	DESCRIPTION	UNIT ORDER	INN/MAS	PACK	LIST
30174	Chrome	1	-/10	BULK	12.94
30184	Brushed Nickel	1	-/10	BULK	15.26

### FAUCET HOLE COVER

- Chrome-plated

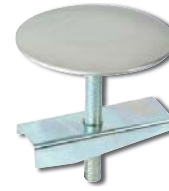

PART #	DESCRIPTION	UNIT ORDER	INN/MAS	PACK	LIST
30131	1-3/4" Toggle Bolt	10	125/500	BULK	1.01

### FAUCET HOLE COVER

- Chrome-plated



PART #	DESCRIPTION	UNIT ORDER	INN/MAS	PACK	LIST
30133	2" Toggle Bolt with Putty Cup	10	125/500	BULK	1.28

### FAUCET HOLE COVER

- Chrome-plated



PART #	DESCRIPTION	UNIT ORDER	INN/MAS	PACK	LIST
30137	1-3/8" Snap-In Type	10	50/500	BULK	0.96
30139	1-1/2" Snap-In Type	10	5/500	BULK	1.00

## Replacement Parts

### BRASS HANDLE AND BIBB SCREW

- Bibb screw - Phillips-head brass
- 100 per bag



PART #	DESCRIPTION	UNIT ORDER	INN/MAS	PACK	LIST
32951	8-32 x 3/8"	1	1/100	BAG	12.60
32955	10-24 x 3/8"	1	1/100	BAG	16.82
*32956	10-24 x 1/2"	1	1/100	BAG	5.67

\*While Supplies Last

Supply Connectors

Stop Valves

Water Heater

Gas Connectors

Water Filtration

Sinks/Faucets

Tubular/Drainage

Faucet Repair

Bath Accessories

Pipe Fittings/Repair

Valves

Cements/Sealants

Tools/Safety

Toilet Repair

Appliance/HVAC

Hardware

Electrical

Index

# FAUCET REPAIR

## Replacement Parts

### FAUCET BIBB WASHER - FLAT

- Tough, long wearing washers that will withstand hot water and hard use
- Made from Buna-N rubber compounds
- Sold & priced 100 per bag



PART #	DESCRIPTION	UNIT ORDER	INN/MAS	PACK	LIST
36002	Size 00 - 1/2" Dia.	1	1/500	BAG	17.34
36003	Size 0 - 17/32" Dia.	1	1/340	BAG	11.55
36004	Size 1/4" - 9/16" Dia.	1	1/340	BAG	18.50
36005	Size 1/4"M - 37/64" Dia.	1	1/200	BAG	18.50
36007	Size 3/8" - 5/8" Dia.	1	1/240	BAG	18.50
36008	Size 3/8"M - 31/32" Dia.	1	1/230	BAG	17.83
36009	Size 3/8"L - 11/16" Dia.	1	1/220	BAG	18.50

### FAUCET BIBB WASHER - BEVELED

- Tough, long wearing washers that will withstand hot water and hard use
- Made from Buna-N rubber compounds
- Sold & priced 100 per bag



PART #	DESCRIPTION	UNIT ORDER	INN/MAS	PACK	LIST
36022	Size 00 - 1/2" Dia.	1	1/290	BAG	18.50
36023	Size 0 - 17/32" Dia.	1	1/290	BAG	18.50
36024	Size 1/4" - 9/16" Dia.	1	1/280	BAG	18.50
36025	Size 1/4"L - 19/64" Dia.	1	1/220	BAG	18.50
36026	Size 3/8" - 5/8" Dia.	1	1/230	BAG	18.50
36027	Size 3/8"M - 31/32" Dia.	1	1/200	BAG	18.50
36029	Size 1/2" - 3/4" Dia.	1	1/110	BAG	18.50

### O-RING KIT

- 200 Pieces
- Includes 12 sizes:
  - 1/4" ID x 3/8" OD x 1/16" Wall
  - 5/16" ID x 7/16" OD x 1/16" Wall
  - 3/8" ID x 1/2" OD x 1/16" Wall
  - 3/8" ID x 9/16" OD x 3/32" Wall
  - 7/16" ID x 5/8" OD x 3/32" Wall
  - 1/2" ID x 11/16" OD x 3/32" Wall
  - 9/16" ID x 3/4" OD x 3/32" Wall
  - 5/8" ID x 13/16" OD x 3/32" Wall
  - 11/16" ID x 7/8" OD x 3/32" Wall
  - 3/4" ID x 15/16" OD x 3/32" Wall
  - 13/16" ID x 1-1/16" OD x 1/8" Wall
  - 7/8" ID x 1-1/8" OD x 1/18" Wall



PART #	DESCRIPTION	UNIT ORDER	INN/MAS	PACK	LIST
36131	12 Sizes in Compartment Box	1	4/36	BOX	18.39

### FAUCET BIBB WASHER KIT

- Includes 0, 00, 1/4", 1/4"M, 3/8", 3/8"M, 3/8"L, & 1/2"
- 200 Pieces



PART #	DESCRIPTION	UNIT ORDER	INN/MAS	PACK	LIST
60533	12 Sizes in Compartment Box	1	4/36	BOX	15.60

### REPLACEMENT CAM

- Fits Delta® & EZ-FLO® faucets



32166

32167



PART #	DESCRIPTION	UNIT ORDER	INN/MAS	PACK	LIST
32166	Heart Shaped Cam with Washer	10	10/1000	BULK	1.77
32167	Slotted Cam with Washer	10	10/1000	BULK	1.91

### SINGLE-HANDLE FAUCET REPAIR KIT

- Fits Delta® & EZ-FLO® faucets



PART #	DESCRIPTION	UNIT ORDER	INN/MAS	PACK	LIST
32115	16-Piece Repair Kit Includes 1 Cam - Heart Shape	1	-/25	BAG	4.53
32121	17-Piece Repair Kit Includes 2 Cams - Heart & Slotted	1	-/25	BAG	4.70

### SPRING & SEAL KIT

- Fits Delta® & EZ-FLO® faucets



32117

32119



PART #	DESCRIPTION	UNIT ORDER	INN/MAS	PACK	LIST
32117	Short (New) Style 4 Pieces	1	-/200	BAG	1.80
32119	Long (Old) Style 4 Pieces	1	-/500	BAG	1.80

### SPRING & SEAL KIT - LONG AND SHORT

- Fits Delta® & EZ-FLO® faucets
- Contains (2) short and (2) long seats and springs



PART #	DESCRIPTION	UNIT ORDER	INN/MAS	PACK	LIST
32120	Long (Old) & Short (New) Style 8 Pieces	1	-/50	BAG	1.97

### CAP ASSEMBLY/SPOUT REPAIR KIT

- Fits Delta® & EZ-FLO® faucets



PART #	DESCRIPTION	UNIT ORDER	INN/MAS	PACK	LIST
32164	Chrome Zinc Cap Assembly with Plastic Ring	20	20/400	BAG	3.85



## Replacement Parts

### DIVERTER WASHER

- Fits Price Pfister® Part #950-040



PART #	DESCRIPTION	UNIT ORDER	INN/MAS	PACK	LIST
31036	Diverter Washer	10	-/150	BAG	0.74

### TEMPROL® REPAIR KIT

- Fits Symmons®
- Repair kit for Temprol®
- OEM# TA-9



PART #	DESCRIPTION	UNIT ORDER	INN/MAS	PACK	LIST
32107	Repair Kit	1	-/10	BAG	8.92

### TEFLON® VALVE STEM PACKING



PART #	DESCRIPTION	UNIT ORDER	INN/MAS	PACK	LIST
50037	3/32" x 20'	1	100/600	BULK	9.46

### BONNET & STEM PACKING

- For tub & shower stems
- Fits Price Pfister®



PART #	DESCRIPTION	UNIT ORDER	INN/MAS	PACK	LIST
30247	1 1/16" OD x 3/8" ID x 1/4"	10	-/10	BULK	0.48

### FAUCET COVER

- Fits Sayco® kitchen deck
- Chrome



PART #	DESCRIPTION	UNIT ORDER	INN/MAS	PACK	LIST
32628	Old Style	10	10/30	BAG	20.13

### FAUCET COVER

- Fits Sayco® lavatory deck
- Chrome



PART #	DESCRIPTION	UNIT ORDER	INN/MAS	PACK	LIST
32630	Old Style	10	10/30	BAG	21.44

## TUB & SHOWER REBUILD KIT

- 2 Chrome-plated canopy handles (12-Point broach with screw & button)
- 1 Chrome-plated canopy diverter handle (12-Point broach with screw & button)
- 2 Brass tub/shower stems (12-Point broach)
- 1 Brass diverter stem (12-Point broach)
- 3 Escutcheon nipples
- 3 Brass seats
- 3 Chrome-plated escutcheon flanges



PART #	DESCRIPTION	UNIT ORDER	INN/MAS	PACK	LIST
60268	Fits Price Pfister®	1	3/12	CLAM	65.81

## TUB & SHOWER REBUILD KIT

- 2 Chrome-plated canopy handles (12-Point broach with screw & button)
- 2 Brass tub/shower stems (12-Point broach)
- 2 Escutcheon nipples
- 2 Brass seats
- 2 Chrome-plated escutcheon flanges



PART #	DESCRIPTION	UNIT ORDER	INN/MAS	PACK	LIST
60269	Fits Price Pfister®	1	3/12	CLAM	49.20

## TUB & SHOWER REBUILD KIT

- 2 Chrome-plated socket handles (16-Point broach with screw)
- 1 Chrome-plated metal diverter handle (16-Point broach with screw)
- 2 Brass tub/shower stems (16-Point broach)
- 1 Brass diverter stem (16-Point broach)
- 3 Escutcheon flanges & sleeves
- 3 Brass seats



PART #	DESCRIPTION	UNIT ORDER	INN/MAS	PACK	LIST
60273	Fits Sterling®	1	3/12	CLAM	78.41

## TUB & SHOWER REBUILD KIT

- 3 Chrome-plated socket handles (16-Point broach with screw)
- 2 Brass tub/shower stems (16-Point broach)
- 1 Brass diverter stem (16-Point broach)
- 3 Escutcheon flanges & sleeves
- 3 Brass seats



PART #	DESCRIPTION	UNIT ORDER	INN/MAS	PACK	LIST
60274	Fits Gerber®	1	3/12	CLAM	77.48

Supply Connectors

Stop Valves

Water Heater

Gas Connectors

Water Filtration

Sinks/Faucets

Tubular/Drainage

Faucet Repair

Bath Accessories

Pipe Fittings/Repair

Valves

Cements/Sealants

Tools/Safety

Toilet Repair

Appliance/HVAC

Hardware

Electrical

Index



# FAUCET REPAIR

## Replacement Parts

### TUB & SHOWER REBUILD KIT

- 3 Chrome-plated socket handles (16-Point broach with screw)
- 2 Brass tub/shower stems (16-Point broach)
- 1 Brass diverter stem (16-Point broach)
- 3 Escutcheon flanges & sleeves
- 3 Brass seats



PART #	DESCRIPTION	UNIT ORDER	INN/MAS	PACK	LIST
60272	Fits Sayco®	1	3/12	CLAM	<b>78.38</b>

### TUB & SHOWER TRIM KIT

- 1 Brass escutcheon - 4-1/2"
- 1 Acrylic handle tub & shower temperature control
- 1 Acrylic handle tub & shower volume control
- 2 Brass screws



PART #	DESCRIPTION	UNIT ORDER	INN/MAS	PACK	LIST
32603	Fits Mixer®	1	1/36	BLISTER	<b>13.89</b>

### TUB & SHOWER TRIM KIT

- 1 Brass escutcheon
- 1 Posi-temp single acrylic handle for tub & shower
- 1 Brass escutcheon tube
- 2 Brass screws



PART #	DESCRIPTION	UNIT ORDER	INN/MAS	PACK	LIST
32608	Fits Moen®	1	4/24	BLISTER	<b>28.88</b>

### TUB & SHOWER TRIM KIT

- 1 Brass escutcheon
- 1 Shallow broach single acrylic handle for tub & shower
- 1 Brass escutcheon tube
- 2 Brass screws



PART #	DESCRIPTION	UNIT ORDER	INN/MAS	PACK	LIST
32607	Fits Moen®	1	4/24	BLISTER	<b>28.88</b>

### TUB & SHOWER TRIM KIT

- 1 Brass escutcheon - 5-1/2"
- 1 Chrome-plated ABS tub & shower temperature control lever handle
- 1 Acrylic handle tub & shower volume control
- 2 Brass screws



PART #	DESCRIPTION	UNIT ORDER	INN/MAS	PACK	LIST
32604	Fits Mixer®	1	6/36	BLISTER	<b>18.96</b>

### TUB & SHOWER TRIM KIT

- 1 Brass escutcheon
- 1 Clear acrylic Delta®-style handle for tub & shower
- 1 Brass escutcheon tube
- 2 Brass screws



PART #	DESCRIPTION	UNIT ORDER	INN/MAS	PACK	LIST
32609	Fits Delta®	1	4/24	BLISTER	<b>33.47</b>

## Replacement Handles

### ACRYLIC TUB & SHOWER HANDLE

- Includes:
  - (1) Handle & screw
  - (3) Buttons
  - (1) Adapter
  - (1) Allen wrench
- Acrylic universal-fit handle



PART #	DESCRIPTION	UNIT ORDER	INN/MAS	PACK	LIST
30229	Hot, Cold, or Diverter	1	100/200	BAG	<b>7.50</b>

### ACRYLIC KITCHEN & LAVATORY HANDLE

- Includes:
  - (2) Handles with screws
  - (2) Buttons
  - (2) Adapters
  - (1) Allen wrench
- Acrylic universal-fit handle



PART #	DESCRIPTION	UNIT ORDER	INN/MAS	PACK	LIST
30230	Hot & Cold	1	75/150	BAG	<b>7.02</b>

### SEVEN-POINT HANDLE

- Fits American Standard®
- 22-Point broach
- Includes:
  - (1) Handle
  - (2) Buttons
  - (1) Screw
- Chrome



PART #	DESCRIPTION	UNIT ORDER	INN/MAS	PACK	LIST
32731	Tub & Shower - Hot or Cold	1	10/100	BAG	<b>11.29</b>

### SINGLE-LEVER

- Fits Delta® and Peerless® faucets
- 12-Point broach
- Chrome
- Also fits EZ-FLO® lavatory faucets



PART #	DESCRIPTION	UNIT ORDER	INN/MAS	PACK	LIST
32139	Delta® and Peerless® Kitchen® 4-1/2"	1	10/100	BULK	<b>9.29</b>
*32142	Delta® and EZ-FLO® Lavatory 3-1/4"	1	10/100	BULK	<b>8.07</b>

\*While Supplies Last

## Replacement Handles

### ACRYLIC HANDLE - LAVATORY

- Fits Delta® & EZ-FLO® faucets
- 12-Point broach



PART #	DESCRIPTION	UNIT ORDER	INN/MAS	PACK	LIST
32131	Handle, Button, Screw	10	10/200	BAG	3.95
32135	Index Button Only	10	50/500	BAG	0.80

### ACRYLIC HANDLE WITH DIAMOND SOCKET

- Fits Delta®



PART #	DESCRIPTION	UNIT ORDER	INN/MAS	PACK	LIST
32137	Diamond Shaped Socket	10	10/200	BULK	11.09

### ACRYLIC HANDLE WITH OFFSET DIAMOND SOCKET

- Fits Delta®
- Includes:  
(1) Handle and screw  
(1) Button



PART #	DESCRIPTION	UNIT ORDER	INN/MAS	PACK	LIST
32138	Offset Diamond Socket	10	10/250	BAG	14.00

### ACRYLIC HANDLE - TWO-HANDLE FAUCET

- Fits Delta® & EZ-FLO®
- "D" broach



PART #	DESCRIPTION	UNIT ORDER	INN/MAS	PACK	LIST
32145	Handle with 2 Buttons & 1 Screw	10	10/200	BAG	2.79
*32147	"C" Index Button Only	10	10/500	BULK	0.29

\*While Supplies Last

### EURO-STYLE LEVER HANDLE

- Fits Delta® & EZ-FLO® Euro faucet
- For 8" single-lever kitchen faucets
- Chrome



PART #	DESCRIPTION	UNIT ORDER	INN/MAS	PACK	LIST
*30242	Loop-Style Handle	10	10/100	BULK	4.04
*30244	Solid-Lever Handle	10	10/100	BULK	6.77

\*While Supplies Last

### EURO-STYLE SOLID-LEVER HANDLE

- Fits EZ-FLO®
- For 8" single-lever kitchen faucets
- Chrome



PART #	DESCRIPTION	UNIT ORDER	INN/MAS	PACK	LIST
*30254	Solid-Lever Handle	1	-/100	BULK	7.13

\*While Supplies Last

### KITCHEN FAUCET HANDLE

- Fits EZ-FLO® 10388 and 10389



PART #	DESCRIPTION	UNIT ORDER	INN/MAS	PACK	LIST
32378	Chrome	1	-/30	BULK	10.44
32379	Brushed Nickel	1	-/30	BULK	15.28

### EURO-STYLE LEVER HANDLE

- Fits Delta® & EZ-FLO® Euro faucet
- For single-lever lavatory and tub & shower
- Chrome



PART #	DESCRIPTION	UNIT ORDER	INN/MAS	PACK	LIST
30265	Loop-Style Handle	1	1/50	BULK	16.48
*30266	Solid-Lever Handle	1	1/100	BULK	5.67

\*While Supplies Last

### EURO-STYLE LEVER HANDLE

- Fits EZ-FLO® pressure balance tub & shower valve with ceramic cartridge
- Chrome



PART #	DESCRIPTION	UNIT ORDER	INN/MAS	PACK	LIST
32342	Solid-Lever Handle	10	10/100	BULK	17.25

Supply Connectors

Stop Valves

Water Heater

Gas Connectors

Water Filtration

Sinks/Faucets

Tubular/Drainage

Faucet Repair

Bath Accessories

Pipe Fittings/Repair

Valves

Cements/Sealants

Tools/Safety

Toilet Repair

Appliance/HVAC

Hardware

Electrical

Index

# FAUCET REPAIR

## Replacement Handles

### KITCHEN FAUCET HANDLE

- 32384 Fits EZ-FLO® Tuscany Collection 10378, 10380 and 10382
- 32385 Fits EZ-FLO® Tuscany Collection 10379, 10381 and 10383



PART #	DESCRIPTION	UNIT ORDER	INN/MAS	PACK	LIST
32384	Chrome	1	-/30	BULK	17.81
32385	Brushed Nickel	1	-/30	BULK	23.02

### METAL KITCHEN/LAVATORY HANDLE

- Fits EZ-FLO® & Sayco®
- 16-Point broach
- Includes color coded button and screw
- Fits compression 2-handle faucets
- Chrome



PART #	DESCRIPTION	UNIT ORDER	INN/MAS	PACK	LIST
30221	Hot	10	10/100	BAG	5.71
30222	Cold	10	10/100	BAG	5.71

### KITCHEN SOLID-LEVER HANDLE

- Fits EZ-FLO® Impressions Collection 10203 and 10204



PART #	DESCRIPTION	UNIT ORDER	INN/MAS	PACK	LIST
32388	Chrome	1	-/10	BULK	12.37
32389	Brushed Nickel	1	-/10	BULK	15.26

### METAL TUB & SHOWER HANDLE

- Fits EZ-FLO® & Sayco®
- 16-Point broach
- Includes color coded button and screw
- Fits compression tub & shower faucets
- Chrome



PART #	DESCRIPTION	UNIT ORDER	INN/MAS	PACK	LIST
30225	Hot	10	10/100	BAG	7.13
30226	Cold	10	10/100	BAG	7.13
30227	Diverter	10	10/100	BAG	7.13

### KITCHEN & LAVATORY METAL HANDLE

- Fits EZ-FLO® Impressions Collection faucets



PART #	DESCRIPTION	UNIT ORDER	INN/MAS	PACK	LIST
32394	Chrome - Hot	1	-/10	BULK	4.77
32395	Chrome - Cold	1	-/10	BULK	4.77
32396	Brushed Nickel - Hot	1	-/10	BULK	6.55
32397	Brushed Nickel - Cold	1	-/10	BULK	6.55

### CHROME HANDLE

- Fits Gerber®
- Short socket
- 16-Point broach
- With screw & acrylic button



PART #	DESCRIPTION	UNIT ORDER	INN/MAS	PACK	LIST
32531	Hot	10	10/100	BULK	4.79
32533	Cold	10	10/100	BULK	4.79
32535	Diverter	10	10/100	BULK	4.79

### CHROME-PLATED HANDLE - LONG SOCKET

- Fits Gerber®
- 16-Point broach
- With screw & acrylic button



PART #	DESCRIPTION	UNIT ORDER	INN/MAS	PACK	LIST
32541	Hot	10	10/100	BULK	4.70
32543	Cold	10	10/100	BULK	4.70

### ACRYLIC LAVATORY HANDLE

- Fits EZ-FLO®
- Fits single-handle lavatory faucets



PART #	DESCRIPTION	UNIT ORDER	INN/MAS	PACK	LIST
32155	Handle, Button, Screw	10	20/100	BAG	3.29
32154	Index Button Only	10	10/1000	BULK	0.57

## Replacement Handles

### FOUR-BLADE HANDLE - KITCHEN & LAVATORY

- Fits Kohler®
- 16-Point broach
- Includes:
  - 1 or 2 Handles with screws
  - 2 or 4 Buttons
- Chrome



PART #	DESCRIPTION	UNIT ORDER	INN/MAS	PACK	LIST
32830	Hot or Cold - Each	10	10/100	BAG	8.33
96830N	Hot or Cold - Pair	10	10/100	BAG	10.71

### FOUR-BLADE HANDLE - TUB & SHOWER

- Fits Kohler®
- 16-Point broach
- Includes:
  - (1) Handle with screw
  - (2) Buttons
- Chrome

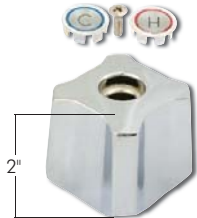

PART #	DESCRIPTION	UNIT ORDER	INN/MAS	PACK	LIST
32833	Hot or Cold	10	10/50	BAG	11.80

### METAL FOUR-BLADE HANDLE

- Fits EZ-FLO® Traditional and Basic-N-Brass Collection faucets
- D broach
- Chrome

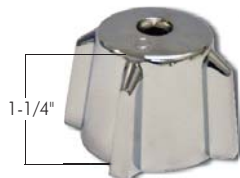

PART #	DESCRIPTION	UNIT ORDER	INN/MAS	PACK	LIST
32392	Hot	10	-/10	BULK	4.77
32393	Cold	10	-/10	BULK	4.77

### VOLUME CONTROL LEVER

- Fits Mixet®
- Chrome
- Plastic body



PART #	DESCRIPTION	UNIT ORDER	INN/MAS	PACK	LIST
32807	Mixet® Lever Handle	10	10/200	BAG	6.73

### TEMPERATURE CONTROL LEVER

- Fits Mixet® single-control shower valve
- Includes insert & screw



PART #	DESCRIPTION	UNIT ORDER	INN/MAS	PACK	LIST
32805	Smoke Plastic	10	10/200	BULK	3.14
32806	Clear Plastic	10	10/200	BULK	3.14

### SINGLE-CONTROL HANDLE

- Fits Moen®
- Includes screw



PART #	DESCRIPTION	UNIT ORDER	INN/MAS	PACK	LIST
32323	Long Socket Tub & Shower	10	10/200	BAG	6.56

### SINGLE-CONTROL HANDLE

- Fits Moen®
- Includes screw & index button



PART #	DESCRIPTION	UNIT ORDER	INN/MAS	PACK	LIST
32325	Short Socket Kitchen & Lavatory	10	10/200	BAG	6.99
32327	Long Socket Tub and Shower	10	10/200	BAG	6.99

### ACRYLIC VOLUME CONTROL KNOB

- Fits Mixet®



PART #	DESCRIPTION	UNIT ORDER	INN/MAS	PACK	LIST
32808	Smoke	10	10/200	BULK	3.93
32809	Clear	10	10/200	BULK	3.93

### ACRYLIC HANDLE

- Fits Moen®
- Includes: (1) Handle, (2) buttons, (1) short screw (kitchen and lavatory), (1) long screw (tub and shower)



PART #	DESCRIPTION	UNIT ORDER	INN/MAS	PACK	LIST
32317	Handle with Button and Screws	10	10/100	BAG	7.50

Supply Connectors

Stop Valves

Water Heater

Gas Connectors

Water Filtration

Sinks/Faucets

Tubular/Drainage

Faucet Repair

Bath Accessories

Pipe Fittings/Repair

Valves

Cements/Sealants

Tools/Safety

Toilet Repair

Appliance/HVAC

Hardware

Electrical

Index

# FAUCET REPAIR

## Replacement Handles

### SINGLE-LEVER HANDLE

- Fits Moen® Chateau®
- Old style



PART #	DESCRIPTION	UNIT ORDER	INN/MAS	PACK	LIST
*32315	Short Socket & Cap	10	10/50	BAG	2.02
*32314	Handle Only	10	10/50	BAG	2.82

\*While Supplies Last

### SINGLE-LEVER HANDLE

- Fits Moen® Chateau®
- New style

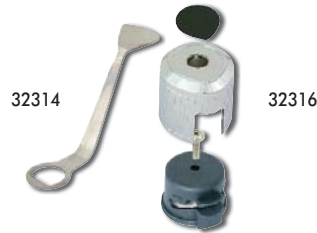

PART #	DESCRIPTION	UNIT ORDER	INN/MAS	PACK	LIST
32316	Long Socket & Cap	10	10/100	BAG	4.42
*32314	Handle Only	10	10/50	BAG	2.82

\*While Supplies Last

### ACRYLIC KITCHEN/LAVATORY HANDLE

- Fits Nibco®
- 17-Point broach
- Includes: (1) Handle and screw (2) Buttons
- Also fits Lifetime® & Streamway® nonmetallic faucets



PART #	DESCRIPTION	UNIT ORDER	INN/MAS	PACK	LIST
32852	Hot or Cold	10	10/100	BAG	5.62

### HANDLE WITH CAP ASSEMBLY

- Fits Price Pfister®



PART #	DESCRIPTION	UNIT ORDER	INN/MAS	PACK	LIST
31031	Fits Avante®	1	-/10	BAG	10.21
31032	Fits Pforever®	1	-/10	BAG	11.01
31033	Fits Widespread®	1	-/10	BAG	20.98

### FOUR-GRIP STYLE SMALL

- Fits Price Pfister® & EZ-FLO®
- 12-Point broach
- Fits kitchen & lavatory faucets
- Includes 1 or 2 handles and screw(s)
- Chrome



PART #	DESCRIPTION	UNIT ORDER	INN/MAS	PACK	LIST
30273	Hot	10	50/400	BAG	2.28
30275	Cold	10	10/100	BAG	2.28
98307N	Hot and Cold - Pair	1	-/20	BAG	4.67

### FOUR-GRIP STYLE TUB AND SHOWER HANDLE

- Fits Price Pfister®
- Fits EZ-FLO® compression tub & shower valves
- 12-Point broach
- Includes 1 or 2 handles and screw(s)
- Chrome

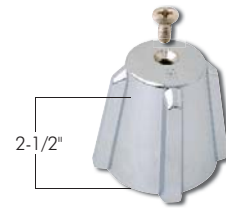

PART #	DESCRIPTION	UNIT ORDER	INN/MAS	PACK	LIST
30282	Hot	10	50/200	BULK	3.82
30283	Cold	10	50/500	BULK	3.71
98355N	Hot & Cold - Pair	1	-/100	BULK	11.92
30278	Diverter	10	10/100	BULK	4.00

### ACRYLIC KITCHEN & LAVATORY HANDLE

- Fits Price Pfister®
- 12-Point broach
- Fits kitchen & lavatory faucets
- Includes: (1) Handle with screw, 1 button



PART #	DESCRIPTION	UNIT ORDER	INN/MAS	PACK	LIST
30290	Hot	10	30/150	BULK	2.83
30291	Cold	10	30/150	BULK	2.83

### ACRYLIC TUB & SHOWER HANDLE

- Fits Price Pfister®
- 12-Point broach
- Fits compression tub & shower valves
- Includes: 1 Handle with screw, 1 or 3 buttons



PART #	DESCRIPTION	UNIT ORDER	INN/MAS	PACK	LIST
30287	Hot	10	20/100	BULK	4.22
30288	Cold	10	20/100	BULK	4.22
30289	1 Handle, 3 Buttons	10	20/100	BULK	5.16

### CHROME KITCHEN & LAVATORY HANDLES

- Fits Price Pfister® Verve® kitchen and lavatory
- 12-Point broach
- (1) Hot and (1) cold handle with screws, (2) inserts, (2) caps



PART #	DESCRIPTION	UNIT ORDER	INN/MAS	PACK	LIST
30216	Hot and Cold - Pair	1	-/10	CLAM	16.11

## Replacement Handles

### TUB & SHOWER LEVER HANDLE - LEO®-STYLE

- Fits Sayco®
- Includes:
  - (1) Handle with screw
  - (2) Buttons
- 16-Point broach



PART #	DESCRIPTION	UNIT ORDER	INN/MAS	PACK	LIST
32636	Hot or Cold	10	10/100	BAG	8.61

### CHROME KITCHEN AND LAVATORY HANDLE

- Fits Sayco® & EZ-FLO®
- Includes:
  - (1) Handle with screw
  - (1) Button
- 16-Point broach



PART #	DESCRIPTION	UNIT ORDER	INN/MAS	PACK	LIST
32631	Hot	10	10/100	BULK	5.53
32633	Cold	10	10/100	BULK	5.53

### CHROME TUB & SHOWER HANDLE

- Fits Sayco® & EZ-FLO®
- Includes:
  - (1) Handle with screw
  - (1) Button
- 16-Point broach



PART #	DESCRIPTION	UNIT ORDER	INN/MAS	PACK	LIST
32641	Hot	10	10/100	BULK	7.50
32643	Cold	10	10/100	BULK	7.50
32644	Diverter	10	10/100	BULK	6.14

### THREE-POINT STYLE KITCHEN & LAVATORY HANDLE

- Fits Sayco®
- Includes:
  - (1) Handle with screw
  - (2) Buttons
- 16-Point broach
- Chrome



PART #	DESCRIPTION	UNIT ORDER	INN/MAS	PACK	LIST
32632	Hot or Cold	10	10/100	BAG	6.79

### TUB & SHOWER HANDLE

- Fits Sterling®
- Chrome-plated
- OEM #ESC 20



PART #	DESCRIPTION	UNIT ORDER	INN/MAS	PACK	LIST
31025	Tub & Shower Handle	1	-/10	BAG	15.88

### CHROME-PLATED HANDLE - KITCHEN AND LAVATORY

- Fits Sterling®
- 16-Point broach
- Includes screw



PART #	DESCRIPTION	UNIT ORDER	INN/MAS	PACK	LIST
*32401	Hot	10	200/400	BULK	1.23
*32403	Cold	10	200/400	BULK	1.23
98306N	Pair - Hot and Cold	1	1/100	BOX	4.15

\*While Supplies Last

### CHROME-PLATED HANDLE - TUB & SHOWER

- Fits Sterling®
- 16-Point broach
- Includes screw



PART #	DESCRIPTION	UNIT ORDER	INN/MAS	PACK	LIST
32405	Hot	10	10/100	BULK	4.08
32407	Cold	10	10/100	BULK	4.08
32404	Diverter	10	10/100	BULK	4.28

### ACRYLIC HANDLE - TUB & SHOWER

- Fits Sterling®
- 16-Point broach
- Includes:
  - (1) Handle with screw
  - (2) Buttons



PART #	DESCRIPTION	UNIT ORDER	INN/MAS	PACK	LIST
32408	Hot or Cold	10	10/200	BAG	6.27

### LEVER HANDLE

- Fits T&S®
- 20-Point broach
- Chrome-plated metal



PART #	DESCRIPTION	UNIT ORDER	INN/MAS	PACK	LIST
32945	Hot	10	150/200	BAG	5.25
32946	Cold	10	150/200	BAG	5.25

# FAUCET REPAIR

## Replacement Handles

### TRI-GRIP TUB & SHOWER HANDLE

- Fits Union Brass®
- 18-Point broach with screw
- Chrome-plated metal



PART #	DESCRIPTION	UNIT ORDER	INN/MAS	PACK	LIST
32915	Hot	10	125/250	BAG	5.26
32916	Cold	10	125/250	BAG	5.26

### CRYSTAL HANDLE

- Fits Valley®
- Old style



PART #	DESCRIPTION	UNIT ORDER	INN/MAS	PACK	LIST
31022	Fits Valley® OEM #FHC-5	1	-/10	BAG	14.37
31023	Fits Valley® OEM #V6904	1	-/10	BAG	14.37

### LEVER HANDLE

- Fits Valley®
- OEM #V1165



PART #	DESCRIPTION	UNIT ORDER	INN/MAS	PACK	LIST
32843	Chrome	10	10/100	BULK	11.55

### ACRYLIC SINGLE-CONTROL HANDLE

- Fits Valley®
- Old style lavatory, tub and shower
- OEM #V6679



PART #	DESCRIPTION	UNIT ORDER	INN/MAS	PACK	LIST
32801	Single-Control Handle	10	10/200	BULK	12.37

### ACRYLIC HANDLE - KITCHEN & LAVATORY

- Fits Valley®
- Includes:
  - (1) Handle with screw
  - (2) Buttons



PART #	DESCRIPTION	UNIT ORDER	INN/MAS	PACK	LIST
32844	Hot or Cold Handle	10	10/100	BAG	4.70
*32845	Hot Button Only	10	10/5000	BULK	0.23
*32846	Cold Button Only	10	20/5000	BULK	0.23

\*While Supplies Last

## Replacement Buttons

### STANDARD CRYSTAL OFFSET HANDLE INDEX BUTTON

- Fits Delta® models after 1991
- 1 Pair



PART #	DESCRIPTION	UNIT ORDER	INN/MAS	PACK	LIST
31053	Replacement Index Button	10	-/10	BAG	2.59

### CRYSTAL SCALD-GUARD HANDLE INDEX BUTTON

- Fits Delta® models after 1991



PART #	DESCRIPTION	UNIT ORDER	INN/MAS	PACK	LIST
31056	Replacement Index Button	10	-/10	BAG	2.59

### ACRYLIC INDEX BUTTON

- Fits Delta® and EZ-FLO®

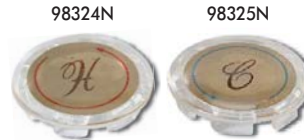

PART #	DESCRIPTION	UNIT ORDER	INN/MAS	PACK	LIST
98324N	"H" Button Only	10	10/200	BAG	4.54
98325N	"C" Button Only	10	10/200	BAG	4.54

### ACRYLIC INDEX BUTTON

- Fits Kohler®
- Fits EZ-FLO® #32830 and #32833



PART #	DESCRIPTION	UNIT ORDER	INN/MAS	PACK	LIST
32831	"H" Button Only	10	20/3000	BULK	1.11
32832	"C" Button Only	10	10/3000	BULK	1.11

### ACRYLIC INDEX BUTTON

- Fits Price Pfister®
- Chrome



PART #	DESCRIPTION	UNIT ORDER	INN/MAS	PACK	LIST
*30302	Hot	10	50/1000	BULK	0.31

\*While Supplies Last



## Replacement Buttons

### ACRYLIC INDEX BUTTON

- Fits Price Pfister®
- 15/16" Diameter



PART #	DESCRIPTION	UNIT ORDER	INN/MAS	PACK	LIST
30307	Hot	10	10/300	BAG	1.48
30309	Cold	10	10/300	BAG	1.48
30311	Diverter	10	10/300	BAG	2.97

### ACRYLIC INDEX BUTTON

- Fits Sayco® & EZ-FLO®



PART #	DESCRIPTION	UNIT ORDER	INN/MAS	PACK	LIST
32651	Hot	10	10/500	BULK	0.57
32653	Cold	10	10/500	BULK	0.57
32655	Diverter	10	10/500	BULK	0.57

## Replacement Stems and Cartridges

### REPLACEMENT CARTRIDGE

- Fits American Standard®
- 22-Point broach
- Replaces Aquaseal® stem

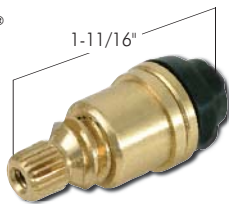

PART #	DESCRIPTION	UNIT ORDER	INN/MAS	PACK	LIST
32716LF	Hot	1	50/100	BAG	7.10
32717LF	Cold	1	40/200	BAG	7.10

### REPLACEMENT BALL CONTROL

- Fits Delta®, Delex® & Peerless®
- Also fits EZ-FLO® faucets

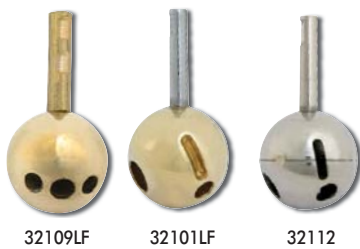

PART #	DESCRIPTION	UNIT ORDER	INN/MAS	PACK	LIST
32109LF	Brass – Fits Acrylic Handle Faucets	10	10/200	BULK	6.35
32101LF	Brass – Fits Single-Lever Faucets	10	10/100	BULK	6.09
32112	Stainless Steel – Fits Single-Lever Faucets	10	10/20	BULK	2.79

### WASHERLESS CARTRIDGE

- Fits EZ-FLO® washerless acrylic 2-handle faucets
- Also fits Delta® "D" broach washerless faucets
- Brass stem, stainless steel seat



PART #	DESCRIPTION	UNIT ORDER	INN/MAS	PACK	LIST
30237LF	Hot or Cold	10	10/500	BULK	2.46

### WASHERLESS CARTRIDGE

- Fits Delta®, Delex® & Peerless®
- Stainless steel seat
- "D" broach
- Plastic cartridge
- Old style



PART #	DESCRIPTION	UNIT ORDER	INN/MAS	PACK	LIST
32125	Hot or Cold	1	10/50	BULK	2.95

### WASHERLESS CARTRIDGE

- Fits Delta®, Delex® & Peerless®
- Stainless steel seat
- "D" broach
- Plastic cartridge
- New style



PART #	DESCRIPTION	UNIT ORDER	INN/MAS	PACK	LIST
32126	Hot or Cold	10	10/100	BULK	1.85

### ANTI-SCALD CARTRIDGE

- Fits Delta® pressure-balance tub & shower valves
- "D" broach
- Plastic cartridge

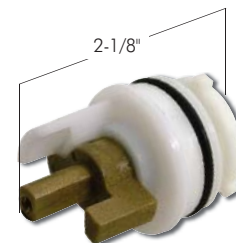

PART #	DESCRIPTION	UNIT ORDER	INN/MAS	PACK	LIST
32161	Fits Short Style	1	-/10	BULK	28.43

Supply Connectors

Stop Valves

Water Heater

Gas Connectors

Water Filtration

Sinks/ Faucets

Tubular/ Drainage

Faucet Repair

Bath Accessories

Pipe Fittings/ Repair

Valves

Cements/ Sealants

Tools/ Safety

Toilet Repair

Appliance/ HVAC

Hardware

Electrical

Index



Items Comply With Low-Lead Plumbing Law

Quality products manufactured by and for EZ-FLO Int. Inc., are not O.E.M. manufactured or licensed unless otherwise specified. Any and all references to trade names and/or registered trademarks in this catalog, shall not be construed as an endorsement by such manufacturer. Please refer to our terms and conditions of sale for additional clarification.

# FAUCET REPAIR

## Replacement Stems and Cartridges

### PRESSURE-BALANCE CARTRIDGE

- Fits Delta® Monitor® pressure-balance tub & shower valves
- Complete assembly



PART #	DESCRIPTION	UNIT ORDER	INN/MAS	PACK	LIST
61064	Replacement Cartridge	1	-/10	BAG	42.34

### ANTI-SCALD CARTRIDGE

**NEW**

- Fits Delta® OEM #RP1991MBS
- Brass stem
- Tub and shower



PART #	DESCRIPTION	UNIT ORDER	INN/MAS	PACK	LIST
31060	Ceramic Disc Cartridge	1	-/10	BULK	17.29

### BRASS REPLACEMENT STEM

- Fits Delta®
- Push-button diverter assembly
- OEM #RP5649



PART #	DESCRIPTION	UNIT ORDER	INN/MAS	PACK	LIST
32124	Diverter	1	-/10	BAG	13.49

### CERAMIC DISC CARTRIDGE

- Fits EZ-FLO® pressure-balance tub and shower valves
- Fits 10306, 10066, and 10205



PART #	DESCRIPTION	UNIT ORDER	INN/MAS	PACK	LIST
90030	Ceramic Disc Cartridge	10	50/100	BULK	39.38

### WASHERLESS CARTRIDGE

- Fits EZ-FLO®
- "D" broach
- Stainless steel seat
- Fits acrylic and metal 2-handle faucets with washerless cartridge
- Brass shank with internal stop



PART #	DESCRIPTION	UNIT ORDER	INN/MAS	PACK	LIST
30239LF	Hot	10	10/50	BULK	4.48
30240LF	Cold	10	10/50	BULK	4.48

### CERAMIC DISC CARTRIDGE

- Fits EZ-FLO® Sterling Collection lavatory faucets



PART #	DESCRIPTION	UNIT ORDER	INN/MAS	PACK	LIST
32372	Hot Ceramic Disc Cartridge	1	-/50	BULK	4.62
32373	Cold Ceramic Disc Cartridge	1	-/50	BULK	4.62

### WASHERLESS CARTRIDGE

- Fits EZ-FLO®
- "D" broach
- Plastic with stainless steel bottom
- Fits acrylic 2-handle faucets with washerless cartridge



PART #	DESCRIPTION	UNIT ORDER	INN/MAS	PACK	LIST
32129LF	Hot or Cold	10	10/100	BULK	2.22

### CERAMIC DISC CARTRIDGE

- Fits EZ-FLO® 10372 and 10373



PART #	DESCRIPTION	UNIT ORDER	INN/MAS	PACK	LIST
32374	Ceramic Disc Cartridge	1	-/50	BULK	7.19

## Replacement Stems and Cartridges

### CERAMIC DISC CARTRIDGE

- Fits EZ-FLO® Prestige Collection 10077LF and Impressions Collection 10203 and 10204



**NEW**



PART #	DESCRIPTION	UNIT ORDER	INN/MAS	PACK	LIST
32339	Ceramic Disc Cartridge	1	-/20	BULK	<b>7.03</b>

### CERAMIC DISC CARTRIDGE

- Fits EZ-FLO® 2-handle kitchen and lavatory
- Brass stem and broach



PART #	DESCRIPTION	UNIT ORDER	INN/MAS	PACK	LIST
32354	Hot	10	10/20	BULK	<b>7.04</b>
32347	Cold	10	10/20	BULK	<b>7.04</b>

### CERAMIC DISC CARTRIDGE

- Fits EZ-FLO® Tuscany Collection 10382 and 10383, and Nonmetallic Collection 10384 and 10385



PART #	DESCRIPTION	UNIT ORDER	INN/MAS	PACK	LIST
32386	Ceramic Disc Cartridge	1	-/50	BULK	<b>7.19</b>

### DIVERTER ASSEMBLY

- Fits EZ-FLO® Tuscany and Sterling Collections



PART #	DESCRIPTION	UNIT ORDER	INN/MAS	PACK	LIST
32387	Diverter Assembly	1	-/50	BULK	<b>6.64</b>

### CERAMIC DISC CARTRIDGE

- Fits EZ-FLO® Sterling Collection 10388 and 10389, and Tuscany Collection 10378, 10379, 10380, and 10381



PART #	DESCRIPTION	UNIT ORDER	INN/MAS	PACK	LIST
32371	Ceramic Disc Cartridge	1	-/50	BULK	<b>7.93</b>

### TUB & SHOWER CARTRIDGE

- Fits Kohler® part #77886



PART #	DESCRIPTION	UNIT ORDER	INN/MAS	PACK	LIST
31046	Replacement Cartridge	1	-/10	BAG	<b>85.76</b>

### CERAMIC DISC CARTRIDGE

- Fits EZ-FLO® single-handle kitchen and lavatory faucets



PART #	DESCRIPTION	UNIT ORDER	INN/MAS	PACK	LIST
32346	Ceramic Disc Cartridge	10	10/100	BULK	<b>18.53</b>

### TUB & SHOWER CARTRIDGE

- Fits Kohler® part #77759



PART #	DESCRIPTION	UNIT ORDER	INN/MAS	PACK	LIST
31047	Replacement Cartridge	1	-/10	BAG	<b>166.97</b>

### CERAMIC DISC CARTRIDGE

- Fits EZ-FLO® Prestige Collection 10066
- Tub and shower



**NEW**



PART #	DESCRIPTION	UNIT ORDER	INN/MAS	PACK	LIST
90066	Ceramic Disc Cartridge	1	10/100	BULK	<b>39.38</b>

### TUB & SHOWER CARTRIDGE

- Fits Kohler® part #09895042



PART #	DESCRIPTION	UNIT ORDER	INN/MAS	PACK	LIST
31049	Replacement Cartridge	1	-/10	BAG	<b>39.75</b>

Supply Connectors

Stop Valves

Water Heater

Gas Connectors

Water Filtration

Sinks/ Faucets

Tubular/ Drainage

Faucet Repair

Bath Accessories

Pipe Fittings/ Repair

Valves

Cements/ Sealants

Tools/ Safety

Toilet Repair

Appliance/ HVAC

Hardware

Electrical

Index



# FAUCET REPAIR

## Replacement Stems and Cartridges

### BALANCING SPOOL FOR PRESSURE-BALANCE VALVE

- Fits Kohler®



PART #	DESCRIPTION	UNIT ORDER	INN/MAS	PACK	LIST
31048	Balancing Spool	1	-/10	BAG	86.88

### CARTRIDGE STEM & BONNET

- Cartridge, stem & bonnet
- Fits Mixet®, models from 1968 and up made in Japan
- Chrome bonnet



PART #	DESCRIPTION	UNIT ORDER	INN/MAS	PACK	LIST
32813	Brass Base	10	10/50	BULK	24.49

### REPLACEMENT STEM

- Fits Kohler® Trend®



PART #	DESCRIPTION	UNIT ORDER	INN/MAS	PACK	LIST
32817LF	Hot	1	50/100	BAG	11.86
32818LF	Cold	1	50/100	BAG	11.86

### SINGLE-CONTROL CARTRIDGE

- Fits Moen®
- Fits single-handle faucets
- Brass



PART #	DESCRIPTION	UNIT ORDER	INN/MAS	PACK	LIST
32301LF	Brass	1	50/100	BAG	28.28

### SINGLE-CONTROL CARTRIDGE

- Fits Moen®
- Fits single-handle faucets
- Plastic body



PART #	DESCRIPTION	UNIT ORDER	INN/MAS	PACK	LIST
32308LF	Plastic	1	50/100	BAG	18.99

### WASHERLESS CARTRIDGE

- Fits Moen®
- Fits 2-handle faucets



PART #	DESCRIPTION	UNIT ORDER	INN/MAS	PACK	LIST
32309	Plastic	10	10/200	BULK	6.81

### TUB & SHOWER BRASS CARTRIDGE WITH REMOVAL TOOL

- OEM #1200
- Fits Moen®



PART #	DESCRIPTION	UNIT ORDER	INN/MAS	PACK	LIST
31038	Cartridge with Removal Tool	1	-/10	BULK	37.58

### POSI-TEMP® CARTRIDGE NEW STYLE

- OEM #1222
- Fits Moen®



PART #	DESCRIPTION	UNIT ORDER	INN/MAS	PACK	LIST
31039	Posi-Temp® Cartridge	1	1/25	BAG	37.01

### REPLACEMENT CARTRIDGE

- For nonmetallic faucets
- Fits Nibco®
- 17-Point broach



PART #	DESCRIPTION	UNIT ORDER	INN/MAS	PACK	LIST
32853	Hot or Cold	10	10/100	BULK	4.53

## Replacement Stems and Cartridges

### BRASS REPLACEMENT STEM

- Fits Gerber®
- 16-Point broach
- Fits kitchen & lavatory faucets
- Old style



PART #	DESCRIPTION	UNIT ORDER	INN/MAS	PACK	LIST
32511LF	Hot	10	10/100	BULK	6.30
32513LF	Cold	10	10/100	BULK	6.30

### BRASS REPLACEMENT STEM

- Fits Gerber®
- 16-Point broach
- Fits 3-valve with diverter

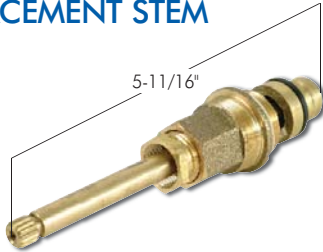

PART #	DESCRIPTION	UNIT ORDER	INN/MAS	PACK	LIST
32515	Diverter	10	10/100	BULK	15.17

### BRASS REPLACEMENT STEM

- Fits Gerber®
- 16-Point broach
- Fits tub & shower valves

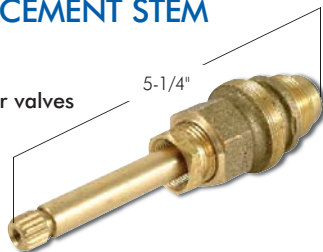

PART #	DESCRIPTION	UNIT ORDER	INN/MAS	PACK	LIST
32517	Hot or Cold	10	10/100	BULK	11.18

### BRASS REPLACEMENT STEM

- Fits Kohler® and Valve®
- 19-Point broach



PART #	DESCRIPTION	UNIT ORDER	INN/MAS	PACK	LIST
32824LF	Hot	1	40/200	BAG	12.32
32825LF	Cold	1	50/100	BAG	12.32

### BRASS REPLACEMENT STEM

- Fits Price Pfister®
- 12-Point broach
- OEM #910-900
- New style

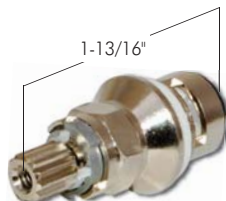

PART #	DESCRIPTION	UNIT ORDER	INN/MAS	PACK	LIST
32103	Hot or Cold	1	-/20	BAG	20.87

### BRASS REPLACEMENT STEM

- Fits Price Pfister®
- 12-Point broach
- Uses 36009 washer
- OEM# 910-013



PART #	DESCRIPTION	UNIT ORDER	INN/MAS	PACK	LIST
32104	Hot or Cold	10	-/10	BAG	18.02

### BRASS REPLACEMENT STEM

- Fits Price Pfister® & EZ-FLO®
- 12-Point broach
- Includes nylon washer
- Fits compression 2-handle faucets

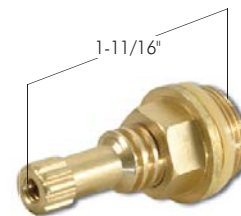

PART #	DESCRIPTION	UNIT ORDER	INN/MAS	PACK	LIST
30251LF	Hot or Cold	10	50/100	BAG	4.64

### BRASS REPLACEMENT STEM

- Fits Price Pfister® & EZ-FLO®
- Includes rubber cord packing
- Includes nylon washer
- Fits compression tub & shower valves
- 12-Point broach

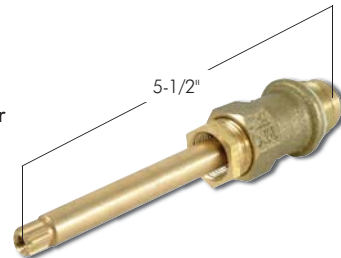

PART #	DESCRIPTION	UNIT ORDER	INN/MAS	PACK	LIST
30253	Hot or Cold	10	50/100	BULK	10.52

### BRASS REPLACEMENT STEM

- Fits Price Pfister® & EZ-FLO®
- Includes rubber cord packing
- Includes nylon washer
- Fits compression tub & shower valves
- 12-Point broach

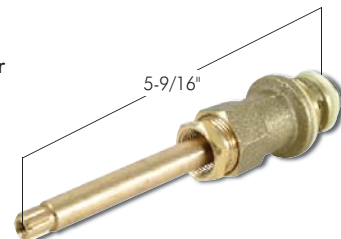

PART #	DESCRIPTION	UNIT ORDER	INN/MAS	PACK	LIST
30255	Brass - Diverter 12-Point Broach	10	50/100	BULK	11.92

Supply Connectors

Stop Valves

Water Heater

Gas Connectors

Water Filtration

Sinks/ Faucets

Tubular/ Drainage

Faucet Repair

Bath Accessories

Pipe Fittings/ Repair

Valves

Cements/ Sealants

Tools/ Safety

Toilet Repair

Appliance/ HVAC

Hardware

Electrical

Index



# FAUCET REPAIR

## Replacement Stems and Cartridges

### BRASS REPLACEMENT STEM

- Fits Price Pfister®
- 12-Point broach
- Uses 36009 washer
- OEM #910-022

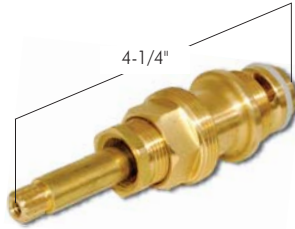

PART #	DESCRIPTION	UNIT ORDER	INN/MAS	PACK	LIST
32057	Diverter	1	-/10	BAG	<b>23.36</b>

### BRASS REPLACEMENT STEM

- Fits Sayco® & EZ-FLO®
- 16-Point broach
- With rubber cord packing
- Fits compression tub & shower valves

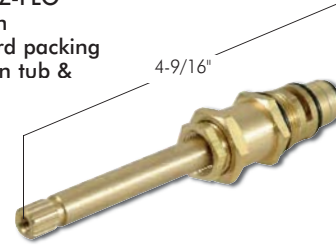

PART #	DESCRIPTION	UNIT ORDER	INN/MAS	PACK	LIST
32620	Diverter	10	10/100	BULK	<b>10.81</b>

### REPLACEMENT CARTRIDGE

- Fits Price Pfister® part #974-292
- Fits Avante® & Bedford®



PART #	DESCRIPTION	UNIT ORDER	INN/MAS	PACK	LIST
31035	Cartridge	1	-/15	BAG	<b>21.73</b>

### BRASS REPLACEMENT STEM

- Fits Sterling®
- 16-Point broach
- Fits tub & shower valves

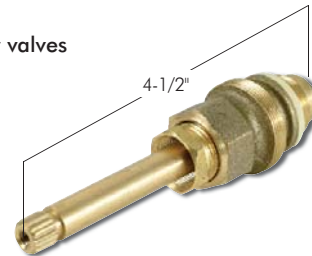

PART #	DESCRIPTION	UNIT ORDER	INN/MAS	PACK	LIST
32421	Hot or Cold	10	10/100	BULK	<b>10.64</b>

### BRASS REPLACEMENT STEM

- Fits Sayco® & EZ-FLO®
- 16-Point broach



PART #	DESCRIPTION	UNIT ORDER	INN/MAS	PACK	LIST
32611LF	Hot	10	10/100	BULK	<b>4.87</b>
32613LF	Cold	10	10/100	BULK	<b>4.87</b>

### REPLACEMENT STEM

- Fits Price Pfister®

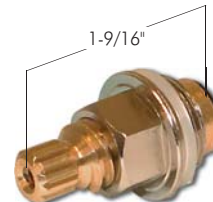

PART #	DESCRIPTION	UNIT ORDER	INN/MAS	PACK	LIST
30258LF	Hot	1	50/100	BAG	<b>5.93</b>
30259LF	Cold	1	50/100	BAG	<b>5.93</b>

### BRASS REPLACEMENT STEM

- Fits Sayco® & EZ-FLO®
- 16-Point broach
- With rubber cord packing
- Fits compression tub & shower valves

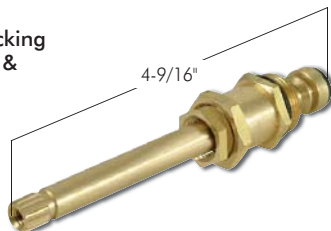

PART #	DESCRIPTION	UNIT ORDER	INN/MAS	PACK	LIST
32617	Hot	10	10/100	BULK	<b>7.56</b>
32619	Cold	10	10/100	BULK	<b>7.56</b>

### REPLACEMENT STEM

- Fits Price Pfister® hot/cold stem



PART #	DESCRIPTION	UNIT ORDER	INN/MAS	PACK	LIST
30260LF	Hot or Cold	1	50/100	BAG	<b>6.89</b>

## Replacement Stems and Cartridges

### BRASS REPLACEMENT STEM

- Fits Sterling®
- 16-Point broach
- Fits tub & shower valves

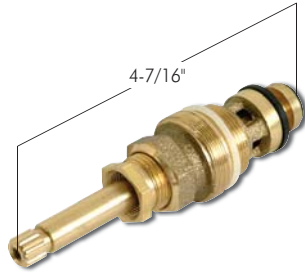

PART #	DESCRIPTION	UNIT ORDER	INN/MAS	PACK	LIST
32423	Diverter	10	10/100	BULK	11.78

### CARTRIDGE WITH STAINLESS STEEL DIVERTER

- OEM #00A5013
- Fits Sterling®



PART #	DESCRIPTION	UNIT ORDER	INN/MAS	PACK	LIST
31027	With Stainless Steel Diverter	1	-/10	BAG	22.98

### CARTRIDGE WITH DIVERTER

- OEM #00A5023
- Fits Sterling®



PART #	DESCRIPTION	UNIT ORDER	INN/MAS	PACK	LIST
31028	With Diverter	1	-/10	BAG	29.48

### TUB & SHOWER CARTRIDGE

- OEM #5300
- Fits Sterling®



PART #	DESCRIPTION	UNIT ORDER	INN/MAS	PACK	LIST
31029	Tub & Shower Cartridge	1	-/10	BAG	57.88

### BRASS REPLACEMENT SPINDLE

- Fits Symmons®
- Temptrol® valves
- 12-Point broach



PART #	DESCRIPTION	UNIT ORDER	INN/MAS	PACK	LIST
32106	Spindle	1	-/10	BAG	81.54

### REPLACEMENT CARTRIDGE

- Fits Valley®
- 2-handle faucets
- OEM #V6804
- Plastic cartridge



PART #	DESCRIPTION	UNIT ORDER	INN/MAS	PACK	LIST
32841	Plastic - Fits Valley® 2-Handle Faucets	10	10/100	BULK	2.79

### REPLACEMENT CARTRIDGE

- Fits Valley®
- single-lever faucets
- OEM #V1112

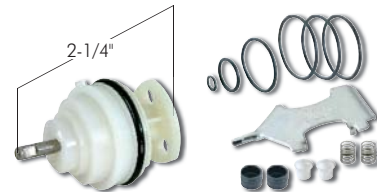

PART #	DESCRIPTION	UNIT ORDER	INN/MAS	PACK	LIST
32842	Plastic Cartridge	10	10/100	BULK	7.33
32848	Repair Kit	10	10/100	BULK	5.62

### WASHERLESS CARTRIDGE

- Fits single-handle Valley®
- kitchen & lavatory faucets
- washerless cartridge
- OEM #VP1964 and #VP1965



PART #	DESCRIPTION	UNIT ORDER	INN/MAS	PACK	LIST
32837LF	Less Spray Diverter	1	50/100	BAG	23.75
32838LF	With Spray Diverter	1	50/100	BAG	18.19

### WASHERLESS CARTRIDGE

- Fits Valley® roman tub, 2-handle tub and shower and widespread lavatory faucets
- OEM #V6860



PART #	DESCRIPTION	UNIT ORDER	INN/MAS	PACK	LIST
32839	Washerless Cartridge	10	10/100	BULK	6.67

### PRESSURE-BALANCE CARTRIDGE

- Fits Valley®
- pressure-balance valves
- OEM #V4268

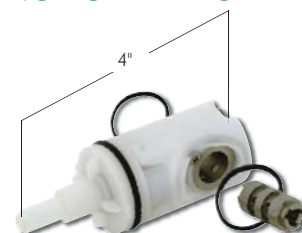

PART #	DESCRIPTION	UNIT ORDER	INN/MAS	PACK	LIST
32854	Pressure-Balance Cartridge	10	10/100	BULK	67.29

Supply Connectors

Stop Valves

Water Heater

Gas Connectors

Water Filtration

Sinks/ Faucets

Tubular/ Drainage

Faucet Repair

Bath Accessories

Pipe Fittings/ Repair

Valves

Cements/ Sealants

Tools/ Safety

Toilet Repair

Appliance/ HVAC

Hardware

Electrical

Index



# FAUCET REPAIR

## Replacement Stems and Cartridges

### BRASS REPLACEMENT STEM

- Fits Kohler® Shoreham® and Kohler® Trend®
- Includes sleeve



PART #	DESCRIPTION	UNIT ORDER	INN/MAS	PACK	LIST
31077	Diverter	5	-/100	BAG	<b>62.39</b>

### BRASS REPLACEMENT STEM

- Fits Kohler®, Shoreham® and Kohler® Trend®
- Includes sleeve
- 19-Point broach

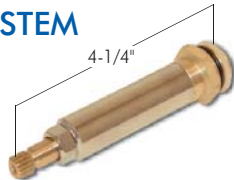

PART #	DESCRIPTION	UNIT ORDER	INN/MAS	PACK	LIST
31075	Hot	1	-/100	BAG	<b>23.44</b>
31076	Cold	1	-/100	BAG	<b>23.44</b>

## Replacement Seats

### BRASS SEAT

- Fits EZ-FLO® faucets and tub & shower valves
- Also fits Sayco®

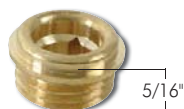

PART #	DESCRIPTION	UNIT ORDER	INN/MAS	PACK	LIST
98364LF	1/2" - 20-Thread - 10 Pack	10	10/100	BAG	<b>4.80</b>

### BRASS SEAT

- Fits Gerber®



PART #	DESCRIPTION	UNIT ORDER	INN/MAS	PACK	LIST
32501LF	5/8" - 20-Thread	10	10/1000	BULK	<b>0.78</b>

### BRASS SEAT

- Fits Price Pfister® lavatory
- OEM #970-510



PART #	DESCRIPTION	UNIT ORDER	INN/MAS	PACK	LIST
32102	1/2" - 20-Thread - 10 Pack	10	-/10	BAG	<b>14.68</b>

### LARGE BRASS SEAT

- Fits Price Pfister® tub & shower valve



PART #	DESCRIPTION	UNIT ORDER	INN/MAS	PACK	LIST
98366N	21/32" - 18-Thread - 10 Pack	1	10/100	BAG	<b>7.64</b>

### BRASS SEAT

- Fits Price Pfister® tub & shower
- OEM #970-500



PART #	DESCRIPTION	UNIT ORDER	INN/MAS	PACK	LIST
32130	21/32" - 18-Thread - 10 Pack	1	-/10	BAG	<b>9.90</b>

## Replacement Escutcheons

### ESCUTCHEON PLATE

- Fits Delta®
- 6-3/4" Diameter



PART #	DESCRIPTION	UNIT ORDER	INN/MAS	PACK	LIST
31057	Replacement Escutcheon	1	-/10	BAG	<b>48.41</b>

### ESCUTCHEON PLATE

- Fits Delta®



PART #	DESCRIPTION	UNIT ORDER	INN/MAS	PACK	LIST
31058	Replacement Escutcheon	1	-/10	BAG	<b>61.90</b>

## TUB/SHOWER ESCUTCHEON

- Fits Mixet®
- 5-1/2" Diameter
- Chrome finish



PART #	DESCRIPTION	UNIT ORDER	INN/MAS	PACK	LIST
32621	Replacement Escutcheon	1	-/1	BAG	<b>14.13</b>

## SINGLE-CONTROL FACE PLATE

- Fits Moen® old style recessed
- 7" Diameter
- Chrome

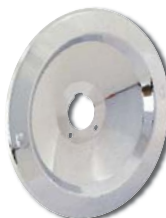

PART #	DESCRIPTION	UNIT ORDER	INN/MAS	PACK	LIST
32358	Replacement Escutcheon	1	-/100	BAG	<b>19.76</b>

## SHOWER ESCUTCHEON

- OEM #13106
- Fits Moen® old style
- Without push button
- 7" Diameter
- Chrome



PART #	DESCRIPTION	UNIT ORDER	INN/MAS	PACK	LIST
31043	Replacement Escutcheon	1	-/10	BAG	<b>45.05</b>



## Replacement Escutcheons

### SHOWER ESCUTCHEON

- OEM #12246
- Fits Moen® new style
- With push button
- 7" Diameter
- Chrome



PART #	DESCRIPTION	UNIT ORDER	INN/MAS	PACK	LIST
31041	Replacement Escutcheon	1	-/10	BAG	63.95

### SHOWER ESCUTCHEON

- Fits Moen®
- OEM #97491
- 7" Diameter
- Chrome



PART #	DESCRIPTION	UNIT ORDER	INN/MAS	PACK	LIST
31042	Replacement Escutcheon	1	-/10	BAG	73.93

### ESCUTCHEON PLATE

- OEM #97582
- Fits Moen® old style
- 7" Diameter
- Chrome



PART #	DESCRIPTION	UNIT ORDER	INN/MAS	PACK	LIST
31040	Replacement Escutcheon	1	-/10	BAG	45.05

### HEX ESCUTCHEON

- OEM #960-370
- Fits Price Pfister®



PART #	DESCRIPTION	UNIT ORDER	INN/MAS	PACK	LIST
31030	Replacement Escutcheon	1	-/10	BAG	44.22

### TUB & SHOWER ESCUTCHEON

- OEM #99A0979
- Fits Sterling®



PART #	DESCRIPTION	UNIT ORDER	INN/MAS	PACK	LIST
31024	Replacement Escutcheon	1	-/10	BAG	47.93

## Replacement Flanges

### TUB & SHOWER FLANGE

- Fits Central Brass®
- Chrome-plated metal



PART #	DESCRIPTION	UNIT ORDER	INN/MAS	PACK	LIST
32797	9/16" - 20-Thread	10	10/50	BAG	5.08

### OVAL TUB & SHOWER FLANGE

- Fits Price Pfister® & EZ-FLO®
- Chrome

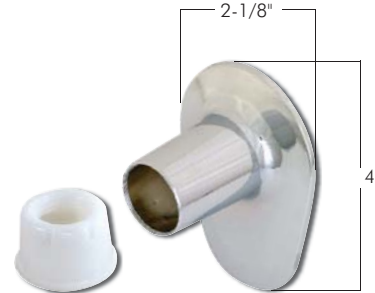

PART #	DESCRIPTION	UNIT ORDER	INN/MAS	PACK	LIST
30325	Oval Flange Only - 1 Pack	10	10/200	BULK	5.08
98356N	Oval Flange Only - 3 Pack	1	1/100	BULK	11.95
*30346	Plastic Flange Nut Only - 21/32" - 18-Thread - 1 Pack	10	10/500	BULK	0.57
98345N	Plastic Flange Nut Only - 21/32" - 18-Thread - 10 Pack	1	1/10	BULK	4.85

\*While Supplies Last

### NEW STYLE TUB & SHOWER FLANGE

- Fits Price Pfister®
- Chrome-plated plastic nut
- 2-Piece reversible flange
- Chrome

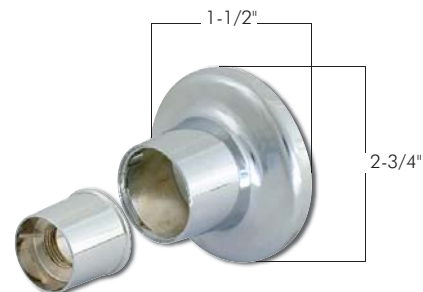

PART #	DESCRIPTION	UNIT ORDER	INN/MAS	PACK	LIST
30335	2-3/4" OD x 1-5/16" ID	10	10/100	BULK	5.39

Supply Connectors

Stop Valves

Water Heater

Gas Connectors

Water Filtration

Sinks/ Faucets

Tubular/ Drainage

Faucet Repair

Bath Accessories

Pipe Fittings/ Repair

Valves

Cements/ Sealants

Tools/ Safety

Toilet Repair

Appliance/ HVAC

Hardware

Electrical

Index

# FAUCET REPAIR

## Replacement Flanges

### TUB & SHOWER FLANGE

- Fits Sayco®
- Plastic sleeve
- Chrome



PART #	DESCRIPTION	UNIT ORDER	INN/MAS	PACK	LIST
32680	2-3/4" Diameter x 1-1/4" ID	10	10/400	BULK	3.76

### OVAL TUB AND SHOWER FLANGE

- Fits Sayco®
- Plastic sleeve
- Chrome flange



PART #	DESCRIPTION	UNIT ORDER	INN/MAS	PACK	LIST
32681	1-1/4" ID	10	10/200	BULK	4.75

### WIDESPREAD FAUCET FLANGE

- Fits Price Pfister®
- Chrome

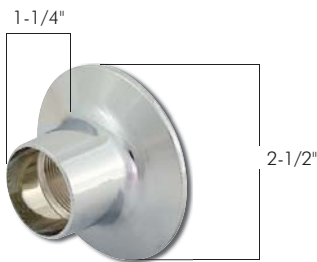

PART #	DESCRIPTION	UNIT ORDER	INN/MAS	PACK	LIST
30323	2-1/2" OD x 1-3/16" ID	25	25/250	BULK	2.97

## Replacement Escutcheon Sleeves

### ESCUTCHEON SLEEVE

- Fits Sterling®
- Chrome

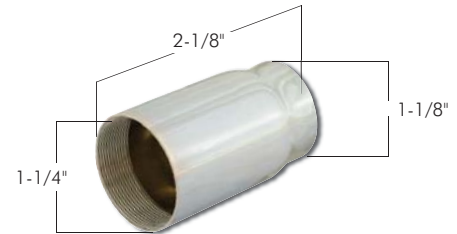

PART #	DESCRIPTION	UNIT ORDER	INN/MAS	PACK	LIST
32441	2-1/8" x 1-1/4" OD x 1-1/8" OD	10	50/200	BAG	4.95
32442	2-1/2" x 1-1/4" OD x 1-1/8" OD	10	50/400	BAG	9.12

### TUB & SHOWER FLANGE

- Fits Price Pfister®
- Metal construction
- Chrome



PART #	DESCRIPTION	UNIT ORDER	INN/MAS	PACK	LIST
30321	21/32" - 18-Thread - 1 Pack	20	20/200	BULK	2.70
98361N	21/32" - 18-Thread - 3 Pack	1	1/100	BULK	6.46

### ESCUTCHEON SLEEVE

- Fits Sayco®
- Chrome

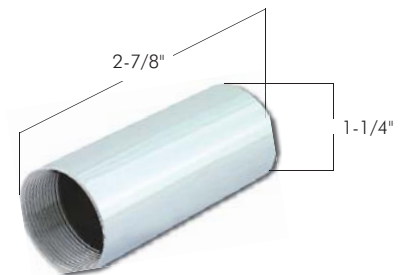

PART #	DESCRIPTION	UNIT ORDER	INN/MAS	PACK	LIST
32685	2-7/8" x 1-1/4" OD	10	10/200	BAG	4.41

### OLD STYLE TUB & SHOWER FLANGE

- Fits Price Pfister®
- Chrome

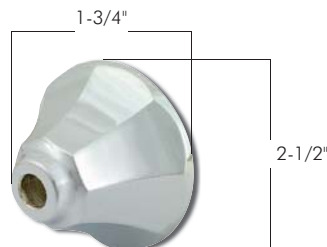

PART #	DESCRIPTION	UNIT ORDER	INN/MAS	PACK	LIST
30333	21/32" - 18-Thread	10	10/100	BULK	4.28

### ESCUTCHEON SLEEVE

- Fits American Standard®
- 5/8" - 24-Thread inside one end
- Chrome

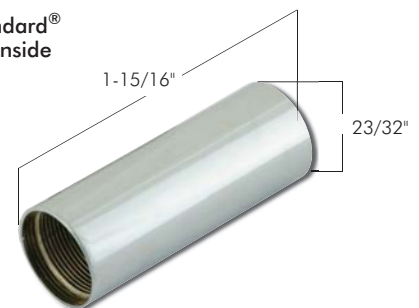

PART #	DESCRIPTION	UNIT ORDER	INN/MAS	PACK	LIST
32725	1-15/16" x 23/32" OD	10	10/200	BAG	4.05

## Replacement Escutcheon Sleeves

### ESCUTCHEON SLEEVE

- Fits EZ-FLO® and Sayco®
- Chrome



PART #	DESCRIPTION	UNIT ORDER	INN/MAS	PACK	LIST
32683	2-15/16" x 1-1/8" OD x 1-1/4" OD	10	10/200	BAG	4.54

### ESCUTCHEON SLEEVE

- Fits Gerber®
- Chrome

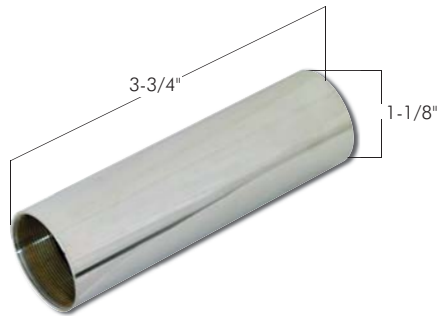

PART #	DESCRIPTION	UNIT ORDER	INN/MAS	PACK	LIST
32505	3-3/4" x 1-1/8" OD	10	10/100	BAG	4.87

### ESCUTCHEON SLEEVE

- Fits Moen®
- Chrome

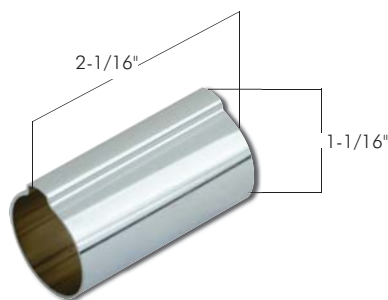

PART #	DESCRIPTION	UNIT ORDER	INN/MAS	PACK	LIST
32359	2-1/16" x 1-1/16" Diameter	1	-/100	BULK	3.88

### ESCUTCHEON SLEEVE

- Fits Union Brass®
- Chrome

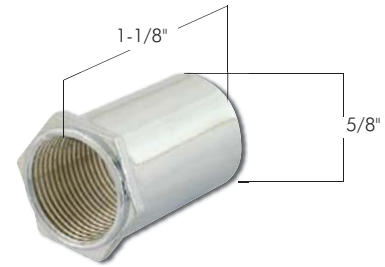

PART #	DESCRIPTION	UNIT ORDER	INN/MAS	PACK	LIST
32914	1-1/8" x 5/8" Diameter	10	10/1000	BAG	1.68

## Replacement Escutcheon and Flange Nipples

### FLANGE NIPPLE - BRASS

- Fits Union Brass®
- Rough brass

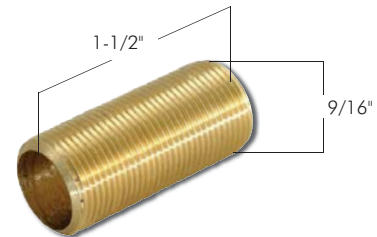

PART #	DESCRIPTION	UNIT ORDER	INN/MAS	PACK	LIST
32919	1-1/2" x 9/16" OD	10	10/100	BULK	2.40

### ESCUTCHEON NIPPLE

- Fits Price Pfister® and others
- Nylon

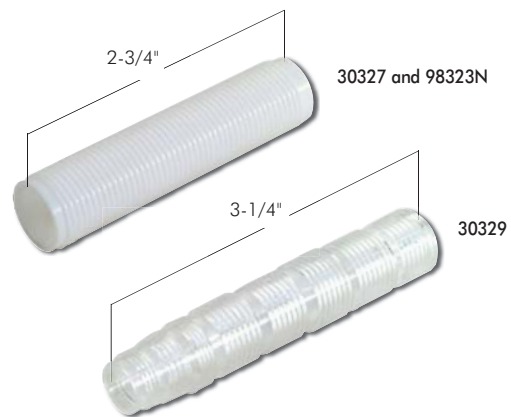

PART #	DESCRIPTION	UNIT ORDER	INN/MAS	PACK	LIST
30327	21/32" - 18-Thread x 2-3/4" Length - 1 Pack	10	10/1000	BULK	0.37
*98323N	21/32" - 18-Thread x 2-3/4" Length - 10 Pack	1	1/100	BAG	4.62
30329	5/8" - 18-Thread x 3-1/4" Length - Fit-All Type	1	-/250	BULK	1.08

\*While Supplies Last

Supply Connectors

Stop Valves

Water Heater

Gas Connectors

Water Filtration

Sinks/ Faucets

Tubular/ Drainage

Faucet Repair

Bath Accessories

Pipe Fittings/ Repair

Valves

Cements/ Sealants

Tools/ Safety

Toilet Repair

Appliance/ HVAC

Hardware

Electrical

Index

# FAUCET REPAIR

## Replacement Spouts

### 8" CAST BRASS SPOUT

- Fits Price Pfister®
- 8" Chrome spout



PART #	DESCRIPTION	UNIT ORDER	INN/MAS	PACK	LIST
30203LF	For 8" Kitchen Deck Faucet	5	5/40	BAG	31.64

## Commercial Faucet Parts

### PRE-RINSE HOSE ASSEMBLY

- Fits EZ-FLO®
- Stainless steel flexible hose
- Food service grade
- Interchangeable with T&S® and Dormont®



PART #	DESCRIPTION	UNIT ORDER	INN/MAS	PACK	LIST
32216LF	44"	1	1/12	BULK	98.51

### 8" TUBULAR BRASS SPOUT

- Fits Price Pfister®
- Chrome finish



PART #	DESCRIPTION	UNIT ORDER	INN/MAS	PACK	LIST
30205LF	For 8" Kitchen Deck Faucet	10	10/100	BAG	16.93

### PRE-RINSE SPRAY VALVE ASSEMBLY

- Fits EZ-FLO®
- Heavy-duty
- Includes locking ring
- Chrome
- Interchangeable with T&S® and Dormont®



PART #	DESCRIPTION	UNIT ORDER	INN/MAS	PACK	LIST
32221LF	Spray Valve Assembly	1	1/20	BAG	110.77

# NEW FAUCETS AND SHOWER KITS!

Kitchen, lavatory, shower, tub and more!



See pages... **56-80**



Visit us online at...

[www.ez-flo.net](http://www.ez-flo.net)



## Add-On Shower Units and Parts

### BATHCOCK-TYPE ADD-ON SHOWER UNIT WITH FRAME

- Chrome-plated brass diverter bathcock
- Chrome-plated brass riser 3/8" x 61-1/4"
- 27" x 42" Aluminium shower rod frame
- Wall and ceiling support bracket included
- Chrome-plated ABS shower head included



PART #	DESCRIPTION	UNIT ORDER	INN/MAS	PACK	LIST
11123	Add-On Shower Unit	1	-/5	BOX	207.40

### BATHCOCK-TYPE ADD-ON SHOWER UNIT

- Chrome-plated brass bathcock
- Chrome-plated brass riser 3/8" x 61-1/4"
- Includes wall bracket
- Chrome-plated ABS shower head



PART #	DESCRIPTION	UNIT ORDER	INN/MAS	PACK	LIST
11127	Add-On Shower Unit	1	-/10	BOX	136.20

### BATHCOCK-TYPE ADD-ON SHOWER REPLACEMENT RISER

- Aluminum riser 3/8" x 61-1/4"
- Fits add-on unit 11123
- Riser will also work with unit 11127



PART #	DESCRIPTION	UNIT ORDER	INN/MAS	PACK	LIST
11126	Riser	1	-/20	BOX	61.81

### ADD-ON SHOWER DIVERTER BATHCOCK

- Polished chrome finish
- Lever handles
- 3-3/8" Centers
- 3/4" MIP centers
- 3/8" Riser connection



PART #	DESCRIPTION	UNIT ORDER	INN/MAS	PACK	LIST
11129	Diverter Bathcock	1	-/10	BOX	67.26

### GROUND-JOINT COUPLINGS

- For bathcocks
- Sold per pair
- Chrome
- \* NOT For Drinking Water



PART #	DESCRIPTION	UNIT ORDER	INN/MAS	PACK	LIST
30202	Couplings	1	10/100	BOX	12.00

Supply Connectors

Stop Valves

Water Heater

Gas Connectors

Water Filtration

Sinks/ Faucets

Tubular/ Drainage

Faucet Repair

Bath Accessories

Pipe Fittings/ Repair

Valves

Cements/ Sealants

Tools/ Safety

Toilet Repair

Appliance/ HVAC

Hardware

Electrical

Index

# BATHROOM ACCESSORIES

## Add-On Shower Units and Parts

### SPOUT-TYPE ADD-ON SHOWER DIVERTER

- Chrome-plated zinc spout
- Diverter spout comes with face bushing and 3/8" riser connection



PART #	DESCRIPTION	UNIT ORDER	INN/MAS	PACK	LIST
11122	Diverter	1	-/50	BOX	17.82

### SPOUT-TYPE ADD-ON SHOWER UNIT

- Chrome-plated zinc spout
- Chrome-plated brass 3/8" x 49-1/2" riser
- Wall bracket
- Chrome-plated ABS shower head



PART #	DESCRIPTION	UNIT ORDER	INN/MAS	PACK	LIST
11120	Add-On Shower Unit	1	-/10	BOX	81.12

### SPOUT-TYPE ADD-ON SHOWER REPLACEMENT RISER

- Chrome-plated brass 3/8" x 49-1/2" riser with coupling nut
- Fits add-on unit 11120



PART #	DESCRIPTION	UNIT ORDER	INN/MAS	PACK	LIST
11121	Riser	1	-/20	BOX	48.89

### SHOWER ROD FRAMES

- 1" OD polished aluminum
- 60" Long x 28" wide



PART #	DESCRIPTION	UNIT ORDER	INN/MAS	PACK	LIST
11135	L-Type	1	-/10	BOX	50.65
11136	U-Type	1	-/10	BOX	44.61
11137	D-Type	1	-/10	BOX	61.56

## Shower Accessories

### ADJUSTABLE SHOWER ROD FLANGE

- Sold and priced by the pair



PART #	DESCRIPTION	UNIT ORDER	INN/MAS	PACK	LIST
15095	Chrome - ABS	25 Pair	25/100 Pair	BAG	1.58
15093	Chrome - Die-Cast	25 Pair	25/100 Pair	BAG	4.41

### SHOWER ROD FLANGE

- FHA type with screws
- Chrome-plated steel
- Sold and priced by the pair



15092

15097



PART #	DESCRIPTION	UNIT ORDER	INN/MAS	PACK	LIST
15092	Exposed Screw	25 Pair	25/200 Pair	BAG	1.19
15097	Concealed Screw	10 Pair	10/200 Pair	BAG	1.48

### SHOWER ROD

- Sold in case quantities only



PART #	DESCRIPTION	UNIT ORDER	INN/MAS	PACK	LIST
15101	1" x 5' Length - .025 Gauge Polished Aluminum	50 Rods	-/50	BULK	5.13
15120	1" x 5' Length - .025 Gauge Polished Aluminum	10 Rods	-/10	BULK	5.99
15103	1" x 6' Length - .025 Gauge Polished Aluminum	50 Rods	-/50	BULK	6.10
15121	1" x 6' Length - .025 Gauge Polished Aluminum	10 Rods	-/10	BULK	6.38
15099	1" x 5' Length - .012 Gauge Polished Stainless Steel	10 Rods	-/10	BULK	13.74

### ADJUSTABLE TENSION SHOWER ROD

- Spring tension bar adjusts up to 72"
- Rubber end caps prevent scratching of wallpaper or paint
- Sold in case quantities only



PART #	DESCRIPTION	UNIT ORDER	INN/MAS	PACK	LIST
15123	Polished Chrome	20	-/20	BOX	16.02
15124	White	20	-/20	BOX	10.86

### CURVED SHOWER ROD

- 1" x 5' Length
- 22-Gauge
- Adds up to 9" more room



PART #	DESCRIPTION	UNIT ORDER	INN/MAS	PACK	LIST
15118	Chrome	12	-/12	BULK	53.46
15119	Brushed Nickel	12	-/12	BULK	56.68

### SHOWER CURTAIN RING

- Sold & priced per bag of 24 rings



PART #	DESCRIPTION	UNIT ORDER	INN/MAS	PACK	LIST
15105	Nickel-Plated Steel	10 Bags	10/100 Bags	BAG	3.68

### SHOWER SPLASH GUARD

- Complete with adhesive mounting tape on both edges
- 7" Wide x 9" high



PART #	DESCRIPTION	UNIT ORDER	INN/MAS	PACK	LIST
15261	White	10 Pair	10/100 Pair	BAG	4.39

### SHOWER SPLASH GUARD

- Complete with adhesive mounting tape on both edges
- 4-1/2" Wide x 4' high



PART #	DESCRIPTION	UNIT ORDER	INN/MAS	PACK	LIST
15263	White	12 Pair	-/12 Pair	BAG	75.98

Supply Connectors

Stop Valves

Water Heater

Gas Connectors

Water Filtration

Sinks/ Faucets

Tubular/ Drainage

Faucet Repair

Bath Accessories

Pipe Fittings/ Repair

Valves

Cements/ Sealants

Tools/ Safety

Toilet Repair

Appliance/ HVAC

Hardware

Electrical

Index

# BATHROOM ACCESSORIES

## Mirror Pulls and Clips

### PLASTIC MIRROR PULL

- Plastic with adhesive back
- Textured finish
- 2-1/4" Long x 3/4" wide



PART #	DESCRIPTION	UNIT ORDER	INN/MAS	PACK	LIST
15245	Black	1 Pair	-/1000 Pair	BAG	1.34

### PLASTIC CABINET MIRROR PULL

- Plastic with adhesive back
- 3-1/4" Long x 1" wide



PART #	DESCRIPTION	UNIT ORDER	INN/MAS	PACK	LIST
15247	Clear - 4 Pack	1	-/250	BAG	4.13

### PLASTIC MIRROR CLIP

- Clear
- Holds up to 1/4" thick glass or mirror
- Sold and priced per bag of 25



PART #	DESCRIPTION	UNIT ORDER	INN/MAS	PACK	LIST
56451	5/8" x 3/4" With Screws	1 Bag	10/120	BAG	3.85

## Towel Holders and Robe Hooks

### TOWEL BAR BRACKETS

- Sold and priced per pair



15151



15152



PART #	DESCRIPTION	UNIT ORDER	INN/MAS	PACK	LIST
15151	5/8" Exposed Screw - Chrome	25 Pair	25/100 Pair	BAG	4.51
15153	3/4" Exposed Screw - Chrome	25 Pair	25/100 Pair	BAG	4.22
15152	5/8" Concealed Screw - Chrome	25 Pair	25/100 Pair	BAG	6.01
15155	3/4" Concealed Screw - Chrome	25 Pair	25/100 Pair	BAG	5.84
16155	3/4" Exposed Screw - Brushed Nickel	25 Pair	25/100 Pair	BAG	4.99

## MIRROR-FINISH TOWEL BAR

- Square bar
- 5/8" or 3/4" size
- Sold in case quantities only



PART #	DESCRIPTION	UNIT ORDER	INN/MAS	PACK	LIST
15161	5/8" x 18" - *Aluminum	50	-/50	BULK	2.02
15163	5/8" x 24" - *Aluminum	50	-/50	BULK	2.72
15165	5/8" x 36" - *Aluminum	50	-/50	BULK	4.42
15171	3/4" x 18" - *Aluminum	50	-/50	BULK	2.25
16173	3/4" x 18" - Brushed Nickel	50	-/50	BULK	8.89
15173	3/4" x 24" - *Aluminum	50	-/50	BULK	2.97
*16240	3/4" x 24" - Brushed Nickel	25	-/25	BULK	4.42
15175	3/4" x 36" - *Aluminum	50	-/50	BULK	4.76
15183	5/8" x 24" - Stainless Steel	50	-/50	BULK	4.13
15191	3/4" x 24" - Stainless Steel	50	-/50	BULK	5.05

\*While Supplies Last

## SQUARE TOWEL BAR AND BRACKETS

- 3/4" x 24" Aluminum bar with brackets



PART #	DESCRIPTION	UNIT ORDER	INN/MAS	PACK	LIST
16177	Exposed Screw - Brushed Nickel	25	-/100	BAG	15.51
16178	Concealed Screw - Brushed Nickel	25	-/100	BAG	17.62

## ADJUSTABLE PLASTIC TOWEL BAR

- Fits 5/8" or 3/4" towel bar brackets
- Easily cut-to-fit
- Spring-loaded adjustable end caps



PART #	DESCRIPTION	UNIT ORDER	INN/MAS	PACK	LIST
15196	24" - Clear Plastic	10	10/100	BULK	4.13
15198	24" - White Plastic	10	10/100	BULK	4.13
15194	36" - White Plastic	10	10/100	BULK	5.25



## Towel Holders and Robe Hooks

### ADJUSTABLE TOWEL BAR END CAPS

- Spring-loaded end caps
- Fits 5/8" or 3/4" towel bar brackets
- Sold & priced 10 pair per bag



PART #	DESCRIPTION	UNIT ORDER	INN/MAS	PACK	LIST
15199	Plastic with Steel Spring	1 Bag	-/100 Bags	BAG	7.24

### TOWEL RING

- Surface mount
- Clear lucite ring



15231

15232



PART #	DESCRIPTION	UNIT ORDER	INN/MAS	PACK	LIST
15231	Exposed Screw - Chrome	25	25/100	BAG	5.27
15232	Concealed Screw - Chrome	25	25/100	BAG	5.29
16232	Exposed Screw - Brushed Nickel	25	25/100	BAG	7.33

### TOWEL RING

- Concealed screw
- Surface mount
- Satin nickel finish



PART #	DESCRIPTION	UNIT ORDER	INN/MAS	PACK	LIST
16233	Concealed Screw - Satin Nickel	25	-/100	BAG	8.13

### ROBE HOOK

- Double-hook
- Surface mount
- Concealed screw



PART #	DESCRIPTION	UNIT ORDER	INN/MAS	PACK	LIST
15241	Chrome	1	25/100	BAG	3.65
16241	Brushed Nickel	1	25/100	BAG	3.42

## Soap and Toothbrush Holders

### SOAP DISH

- Surface mount



15201



15202



PART #	DESCRIPTION	UNIT ORDER	INN/MAS	PACK	LIST
15201	Exposed Screw - Chrome	25	25/100	BAG	4.28
15202	Concealed Screw - Chrome	25	25/100	BAG	5.84
16202	Exposed Screw - Brushed Nickel	25	25/100	BAG	5.65
16203	Concealed Screw - Brushed Nickel	25	25/100	BAG	7.61

### TOOTHBRUSH AND CUP HOLDER

- Surface mount



PART #	DESCRIPTION	UNIT ORDER	INN/MAS	PACK	LIST
15206	Exposed Screw - Chrome	25	25/100	BAG	4.16
15207	Concealed Screw - Chrome	25	25/100	BAG	4.54
16207	Exposed Screw - Brushed Nickel	25	25/100	BAG	5.65
16208	Concealed Screw - Brushed Nickel	25	25/100	BAG	7.61

Supply Connectors

Stop Valves

Water Heater

Gas Connectors

Water Filtration

Sinks/Faucets

Tubular/Drainage

Faucet Repair

Bath Accessories

Pipe Fittings/Repair

Valves

Cements/Sealants

Tools/Safety

Toilet Repair

Appliance/HVAC

Hardware

Electrical

Index

# BATHROOM ACCESSORIES

## Soap and Toothbrush Holders

### RECESSED SOAP HOLDER AND GRAB BAR

- 4-1/2" x 5-1/4"
- Rough-in
- Chrome



PART #	DESCRIPTION	UNIT ORDER	INN/MAS	PACK	LIST
15215	Recessed Holder	1	15/30	BOX	<b>22.38</b>
15204	Replacement Plastic Soap Dish	25	25/100	BOX	<b>2.03</b>

### TOILET PAPER ROLLER

- Spring-action



15137



15135



15133



15131



PART #	DESCRIPTION	UNIT ORDER	INN/MAS	PACK	LIST
15135	Chrome 3/8" Stepped Ends	25	25/500	BAG	<b>1.20</b>
15133	White 3/8" Stepped Ends	25	25/500	BAG	<b>0.57</b>
15137	Chrome 5/8" Round Ends	25	25/500	BAG	<b>1.20</b>
15131	White 5/8" Round Ends	25	25/500	BAG	<b>0.57</b>

## Toilet Paper Holders

### TOILET PAPER HOLDER

- Surface mount
- Includes white toilet paper roller



PART #	DESCRIPTION	UNIT ORDER	INN/MAS	PACK	LIST
15235	Exposed Screw - Chrome	25	25/100	BAG	<b>3.95</b>
15225	Concealed Screw - Chrome	25	25/100	BAG	<b>7.34</b>
16225	Exposed Screw - Brushed Nickel	25	25/100	BAG	<b>9.81</b>
16226	Concealed Screw - Brushed Nickel	25	25/100	BAG	<b>10.64</b>
*14263	Concealed Screw - Polished Brass	25	25/100	BAG	<b>0.71</b>

\*While Supplies Last

## Bathroom Sets

### FOUR-PIECE BATHROOM SET

- Includes: 5/8" x 24" polished aluminum towel bar set, metal soap dish, metal toothbrush and cup holder, metal toilet paper holder
- Chrome



PART #	DESCRIPTION	UNIT ORDER	INN/MAS	PACK	LIST
12966	Exposed Screw	1	-/30	CLAM	<b>19.65</b>

### RECESSED TOILET PAPER HOLDER

- 5-1/4" x 5-1/4" Rough-in
- Includes white toilet paper roller



PART #	DESCRIPTION	UNIT ORDER	INN/MAS	PACK	LIST
15209	Chrome	1	15/30	BOX	<b>18.96</b>

### DECORATIVE TOWEL BAR

- Designed to match Elegance™ series faucets
- Concealed screws
- 24" Long



PART #	DESCRIPTION	UNIT ORDER	INN/MAS	PACK	LIST
16242	Chrome	1	6/24	BLISTER	<b>31.77</b>
16243	Brushed Nickel	1	6/24	BLISTER	<b>35.64</b>
16244	Oil-Rubbed Bronze	1	6/24	BLISTER	<b>43.22</b>

## Bathroom Sets

### DECORATIVE ROBE HOOK

- Designed to match Elegance™ series faucets
- Concealed screws



PART #	DESCRIPTION	UNIT ORDER	INN/MAS	PACK	LIST
16248	Chrome	1	6/96	BLISTER	12.17
16249	Brushed Nickel	1	6/96	BLISTER	15.81
16250	Oil-Rubbed Bronze	1	6/96	BLISTER	15.81

### DECORATIVE TOWEL RING

- Designed to match Elegance™ series faucets
- Concealed screws



PART #	DESCRIPTION	UNIT ORDER	INN/MAS	PACK	LIST
16254	Chrome	1	6/48	BLISTER	16.53
16255	Brushed Nickel	1	6/48	BLISTER	18.77
16256	Oil-Rubbed Bronze	1	6/48	BLISTER	19.36

### DECORATIVE TOILET PAPER HOLDER

- Designed to match Elegance™ series faucets
- Concealed screws



PART #	DESCRIPTION	UNIT ORDER	INN/MAS	PACK	LIST
16251	Chrome	1	6/48	BLISTER	20.96
16252	Brushed Nickel	1	6/48	BLISTER	27.37
16253	Oil-Rubbed Bronze	1	6/48	BLISTER	31.72

## Sink and Tub Accessories

### LAVATORY LEGS

- For wall mount basins
- Chrome
- Sold & priced by the pair



PART #	DESCRIPTION	UNIT ORDER	INN/MAS	PACK	LIST
34031	28" Adjustable Height	1 Pair	-/20 Pair	BULK	39.20

### V-TYPE LAVATORY SINK HANGER

- For wall mount basins



PART #	DESCRIPTION	UNIT ORDER	INN/MAS	PACK	LIST
34013	Steel	50	50/200	BULK	0.94

## CLEANOUT COVER PLATE - STAINLESS STEEL

- Chrome-plated stainless steel
- Countersink hole for either a 1/4" or 5/16" screw
- Includes 1/4" x 2-1/4" screw



PART #	DESCRIPTION	UNIT ORDER	INN/MAS	PACK	LIST
43488	3" Diameter	1	25/100	BAG	1.60
43489	4" Diameter	1	25/100	BAG	1.82
43490	5" Diameter	1	25/100	BAG	2.59
43491	6" Diameter	1	25/100	BAG	4.70

## MIRROR-FINISH FAUCET HOLE COVERS

- 1/8" Mirror-finish acrylic
- Eases conversion of behind-the-wall faucets



34041



34043



34045

PART #	DESCRIPTION	UNIT ORDER	INN/MAS	PACK	LIST
34041	For Single-Handle Faucets	12	12/36	BULK	17.76
34043	For 3-Handle Shower	12	12/36	BULK	15.54
34045	For Tub Spouts	12	12/36	BULK	5.82

## Access Panels

### SPRING-STYLE ACCESS PANEL



- Quick installation - frameless
- Simply clicks into and out of place
- White plastic, can be painted or wallpapered



PART #	DESCRIPTION	UNIT ORDER	INN/MAS	PACK	LIST
34026	9-1/4" x 9-1/4" - Service Opening 8" x 8"	1	-/20	BAG	11.02
34027	15-1/4" x 15-1/4" - Service Opening 14" x 14"	1	-/10	BAG	18.53

### ACCESS PANEL WITH FRAME

- Provides access to plumbing lines behind walls or ceilings
- White plastic



PART #	DESCRIPTION	UNIT ORDER	INN/MAS	PACK	LIST
34021	8" x 11" x 3/4" Service Opening - 6" x 9"	6	6/24	BULK	14.68
34020	11" x 11" x 3/4" Service Opening - 8" x 8"	6	6/24	BULK	19.33
34022	17" x 17" x 3/4" Service Opening - 14" x 14"	6	6/24	BULK	23.52

Supply Connectors

Stop Valves

Water Heater

Gas Connectors

Water Filtration

Sinks/Faucets

Tubular/Drainage

Faucet Repair

Bath Accessories

Pipe Fittings/Repair

Valves

Cements/Sealants

Tools/Safety

Toilet Repair

Appliance/HVAC

Hardware

Electrical

Index

# BATHROOM ACCESSORIES

## Access Panels

### ACCESS PANEL WITH FRAME

- Doors are prime coated, suitable for painting or wallpapering
- Fabricated from durable 16-gauge galvanized steel
- Door is flush to frame with rounded safety corners



**NEW**

**EASTMAN**

PART #	DESCRIPTION	UNIT ORDER	INN/MAS	PACK	LIST
34060	7-5/8" x 7-5/8" x 1-3/16" - Service Opening 6" x 6"	1	-/10	BULK	19.90
34062	9-5/8" x 9-5/8" x 1-3/16" - Service Opening 8" x 8"	1	-/10	BULK	23.02
34064	13-5/8" x 13-5/8" x 1-3/16" - Service Opening 12" x 12"	1	-/5	BULK	31.46
34066	15-5/8" x 15-5/8" x 1-3/16" - Service Opening 14" x 14"	1	-/5	BULK	40.88

## Commercial Bathroom Accessories

### COMMERCIAL-GRADE GRAB BAR

- Heavy-duty 18-gauge 304 stainless steel
- With concealed screw mounting
- Stainless steel finish



PART #	DESCRIPTION	UNIT ORDER	INN/MAS	PACK	LIST
15186	1-1/2" OD x 18" Length	4	-/12	BAG	28.43
15188	1-1/2" OD x 24" Length	4	-/12	BAG	33.07
15286	1-1/2" OD x 36" Length	5	-/12	BAG	42.28
15287	1-1/2" OD x 42" Length	5	-/12	BAG	46.76

### P-TRAP & RISER INSULATION KIT

- Protects against scalding-hot water lines and P-trap
- EZ Tear-To-Fit feature makes trimming super fast
- EZ Grip built-in fasteners are quick, strong and reusable
- Molded vinyl
- Virtually indestructible



80102

80101



PART #	DESCRIPTION	UNIT ORDER	INN/MAS	PACK	LIST
80101	P-Trap and 2 Angle Valve Covers	1	-/15	BOX	89.36
80102	Offset Drain Cover for Handicap Drains	1	-/15	BOX	25.78

### LIQUID SOAP DISPENSER

- 16 oz white translucent poly globe
- Surface mount bracket & valve
- Liquid dispenser with push-up valve



PART #	DESCRIPTION	UNIT ORDER	INN/MAS	PACK	LIST
15270	Chrome	1	5/30	BOX	13.75

### PAPER TOWEL DISPENSER

- Holds multifold paper towels
- 11-1/4" Wide x 15-3/8" high x 4-1/16" deep
- Comes with key lock



PART #	DESCRIPTION	UNIT ORDER	INN/MAS	PACK	LIST
15284	White	1	-/6	BOX	72.05
15285	Chrome	1	-/6	BOX	86.73

### COMMERCIAL TOILET PAPER HOLDER

- Push-button arm release
- 5-1/2" Wide x 2-3/8" high x 4-1/4" deep



PART #	DESCRIPTION	UNIT ORDER	INN/MAS	PACK	LIST
15281	Chrome	1	-/24	BOX	26.46

## Shower Heads

### SHOWER HEAD - 2.0 GPM

- ABS construction
- 1-3/4" Adjustable white face
- 1/2" FIP
- Chrome



PART #	DESCRIPTION	UNIT ORDER	INN/MAS	PACK	LIST
15001	Plastic Ball Joint	10	50/200	BOX	2.45
15035	Metal Ball Joint	10	10/100	BOX	5.67

### SHOWER HEAD - 2.0 GPM

- ABS construction
- 2" Adjustable black face
- 1/2" FIP
- Chrome



PART #	DESCRIPTION	UNIT ORDER	INN/MAS	PACK	LIST
15190	Plastic Ball Joint	10	10/100	BOX	3.02
15011	Metal Ball Joint	10	10/100	BOX	5.05

## Shower Heads

### SHOWER HEAD - 2.0 GPM

- ABS construction
- 2" Adjustable white face
- 1/2" FIP
- Chrome



PART #	DESCRIPTION	UNIT ORDER	INN/MAS	PACK	LIST
15014	Metal Ball Joint	10	10/100	BOX	5.05

### SHOWER HEAD - 2.0 GPM

- ABS construction
- 3" Adjustable white face
- 1/2" FIP
- Clear acrylic body sleeve
- Chrome



PART #	DESCRIPTION	UNIT ORDER	INN/MAS	PACK	LIST
15025	Metal Ball Joint	10	10/50	BOX	6.17

### SHOWER HEAD - 2.5 GPM

- ABS construction
- 1/2" FIP
- 2" Adjustable black face



PART #	DESCRIPTION	UNIT ORDER	INN/MAS	PACK	LIST
15009	Chrome Plastic Ball Joint	10	10/100	BOX	3.65
15010	Chrome Metal Ball Joint	10	10/100	BOX	6.64
*14291	Polished Brass Metal Ball Joint	10	10/100	BOX	2.85

\*While Supplies Last

### SHOWER HEAD - 2.5 GPM

- ABS construction
- 2" Adjustable white face
- 1/2" FIP
- Chrome



PART #	DESCRIPTION	UNIT ORDER	INN/MAS	PACK	LIST
15004	Metal Ball Joint	10	10/100	BOX	5.70

### SHOWER HEAD - 2.5 GPM

- ABS construction
- 3" Adjustable white face
- 1/2" FIP
- Clear acrylic body sleeve
- Chrome



PART #	DESCRIPTION	UNIT ORDER	INN/MAS	PACK	LIST
15038	Metal Ball Joint	10	10/50	BOX	9.07

### SHOWER HEAD - 2.5 GPM

- ABS construction
- 2" Adjustable black face
- 1/2" FIP
- Chrome



PART #	DESCRIPTION	UNIT ORDER	INN/MAS	PACK	LIST
15036	Brass Ball Joint	10	10/100	BOX	9.89

### DELUXE SHOWER HEAD - 2.0 GPM

- Metal construction – metal ball joint
- 1/2" FIP
- Side handle adjustment
- 2" Face



PART #	DESCRIPTION	UNIT ORDER	INN/MAS	PACK	LIST
15017	Chrome	10	10/50	BOX	16.71

### DELUXE BRASS SHOWER HEAD - 2.0 GPM

- Brass construction
- 1/2" FIP
- Adjustable side handle
- Chrome finish



PART #	DESCRIPTION	UNIT ORDER	INN/MAS	PACK	LIST
15013	1-3/4" Face	10	10/60	BOX	20.56
15015	2-1/4" Face	10	10/40	BOX	30.17

### DELUXE BRASS SHOWER HEAD - 2.0 GPM

- Brushed nickel finish
- Brass construction
- 1/2" FIP
- Adjustable side handle



PART #	DESCRIPTION	UNIT ORDER	INN/MAS	PACK	LIST
15002	1-3/4" Face	10	10/60	BOX	29.25
15018	2-1/4" Face	10	10/40	BOX	44.45

### DELUXE BRASS SHOWER HEAD - 2.5 GPM

- Brass construction
- 1/2" FIP
- 3" Face
- Chrome-plated finish



PART #	DESCRIPTION	UNIT ORDER	INN/MAS	PACK	LIST
*15091	Brass Ball Joint	1	-/50	BOX	18.99

\*While Supplies Last

Supply Connectors

Stop Valves

Water Heater

Gas Connectors

Water Filtration

Sinks/Faucets

Tubular/Drainage

Faucet Repair

Bath Accessories

Pipe Fittings/Repair

Valves

Cements/Sealants

Tools/Safety

Toilet Repair

Appliance/HVAC

Hardware

Electrical

Index

# BATHROOM ACCESSORIES

## Shower Heads

### DELUXE BRASS BELL SHOWER HEAD - 2.5 GPM

- Brass construction
- 1/2" FIP
- 4" Face



PART #	DESCRIPTION	UNIT ORDER	INN/MAS	PACK	LIST
*15094	Chrome-Plated	1	-/50	BOX	25.01

\*While Supplies Last

### WATER-SAVING SHOWER HEAD - 1.8 GPM

- Brass construction
- 1.8 GPM flow rate
- 1/2" FIP
- Priced each & shipped 2 per bag
- Chrome



PART #	DESCRIPTION	UNIT ORDER	INN/MAS	PACK	LIST
15024	Brass Ball Joint	12 Pair	12/252	BOX	8.84

### WATER-SAVING SHOWER HEAD - 2.0 GPM

- Brass construction
- 1/2" FIP
- Chrome



PART #	DESCRIPTION	UNIT ORDER	INN/MAS	PACK	LIST
15021	With Shutoff	10	1/100	BOX	11.09
15023	Less Shutoff	10	1/100	BOX	7.13

### BRASS RAIN SHOWER HEAD - 2.5 GPM

- Brass construction
- Attaches directly to shower arm
- 1/2" FIP
- Self-cleaning spray tips
- Chrome



PART #	DESCRIPTION	UNIT ORDER	INN/MAS	PACK	LIST
15111	5-1/2" Face	1	-/30	BOX	53.26

### BRASS RAIN SHOWER HEAD - 2.5 GPM

- Brass construction
- 1/2" FIP
- Self-cleaning spray tips
- Chrome



PART #	DESCRIPTION	UNIT ORDER	INN/MAS	PACK	LIST
15113	4" Face	1	-/50	BOX	29.31

### OCTAGONAL SHOWER HEAD - 2.0 GPM

- Octagonal face
- Metal construction
- 1/2" FIP
- Chrome



PART #	DESCRIPTION	UNIT ORDER	INN/MAS	PACK	LIST
15031	Metal Ball Joint	10	-/50	BOX	10.95

### ADJUSTABLE MASSAGE SHOWER HEAD - 2.0 GPM

- Chrome-plated ABS body
- Adjustable massage spray
- 1/2" FIP



PART #	DESCRIPTION	UNIT ORDER	INN/MAS	PACK	LIST
15000	Metal Ball Joint	10	-/100	BOX	16.00

### ADJUSTABLE MASSAGE SHOWER HEAD - 2.5 GPM

- ABS construction
- Massage or shower spray adjustment
- 1/2" FIP
- White and gray



PART #	DESCRIPTION	UNIT ORDER	INN/MAS	PACK	LIST
15042	Brass Ball Joint	5	5/100	BOX	18.45

### PULSATING MASSAGE SHOWER HEAD - 2.0 GPM

- Pulsating, three-way adjustment
- 3" Adjustable white face
- 1/2" FIP
- Chrome
- ABS construction



PART #	DESCRIPTION	UNIT ORDER	INN/MAS	PACK	LIST
15022	Metal Ball Joint	1	12/48	BOX	12.57

### PULSATING MASSAGE SHOWER HEAD - 2.5 GPM

- Pulsating three-way adjustment
- 3" Adjustable white face
- 1/2" FIP
- ABS construction
- Chrome



PART #	DESCRIPTION	UNIT ORDER	INN/MAS	PACK	LIST
15027	Metal Ball Joint	6	12/48	BOX	13.57

## Shower Heads

### PULSATING MASSAGE SHOWER HEAD - 2.5 GPM

- Pulsating five-way adjustment
- 3" Adjustable white face
- ABS construction
- 1/2" FIP
- Chrome



PART #	DESCRIPTION	UNIT ORDER	INN/MAS	PACK	LIST
15028	Brass Ball Joint	6	6/36	BOX	21.41

### DELUXE MASSAGE SHOWER HEAD - 2.0 GPM

- Five settings
- Self-cleaning rubber spray jets
- 1/2" FIP
- ABS construction
- Chrome finish



PART #	DESCRIPTION	UNIT ORDER	INN/MAS	PACK	LIST
15112	Brass Ball Joint	6	-/60	BOX	25.29

### DELUXE MASSAGE SHOWER HEAD - 2.5 GPM

- Five settings
- Self-cleaning rubber spray jets
- 1/2" FIP
- ABS construction
- Chrome finish



PART #	DESCRIPTION	UNIT ORDER	INN/MAS	PACK	LIST
*15012	Brass Ball Joint	6	-/60	BOX	23.15

\*While Supplies Last

### MASSAGE SHOWER HEAD - 2.0 GPM

- Four settings
- 4" Face
- Self-cleaning rubber spray jets
- 1/2" FIP
- ABS construction
- Chrome finish



PART #	DESCRIPTION	UNIT ORDER	INN/MAS	PACK	LIST
15146	4-Function Spray Pattern	1	-/12	BOX	17.31

### MASSAGE SHOWER HEAD - 2.0 GPM

- Five settings
- 4" Face
- Self-cleaning rubber spray jets
- 1/2" FIP
- ABS construction
- Chrome finish



PART #	DESCRIPTION	UNIT ORDER	INN/MAS	PACK	LIST
15148	5-Function Spray Pattern	1	-/12	BOX	16.80

### MASSAGE SHOWER HEAD - 2.0 GPM

**NEW**

- Six settings
- 4" Face
- Self-cleaning rubber spray jets
- 1/2" FIP
- ABS construction
- Chrome finish



PART #	DESCRIPTION	UNIT ORDER	INN/MAS	PACK	LIST
15147	6-Function Spray Pattern	1	-/12	BOX	17.31

## Handheld Shower Sets and Parts

### HANDHELD SHOWER SET - 2.0 GPM

**NEW**

- Three settings
- 4" Face
- Self-cleaning rubber spray jets
- 59" Stainless steel hose
- ABS construction
- Chrome finish



PART #	DESCRIPTION	UNIT ORDER	INN/MAS	PACK	LIST
15142	3-Function Set	1	-/12	BOX	29.13
15178	59" Stainless Steel Hose Only	1	-/10	BOX	8.68

### HANDHELD SHOWER SET - 2.0 GPM

**NEW**

- Five settings
- 4" Face
- Self-cleaning rubber spray jets
- 59" Stainless steel hose
- ABS construction
- Chrome finish



PART #	DESCRIPTION	UNIT ORDER	INN/MAS	PACK	LIST
15143	5-Function Set	1	-/12	BOX	28.49
15178	59" Stainless Steel Hose Only	1	-/10	BOX	8.68

Supply Connectors

Stop Valves

Water Heater

Gas Connectors

Water Filtration

Sinks/Faucets

Tubular/Drainage

Faucet Repair

Bath Accessories

Pipe Fittings/Repair

Valves

Cements/Sealants

Tools/Safety

Toilet Repair

Appliance/HVAC

Hardware

Electrical

Index

# BATHROOM ACCESSORIES

## Handheld Shower Sets and Parts

### HANDHELD SHOWER SET - 2.0 GPM

**NEW**

- Six settings
- 4" Face
- Self-cleaning rubber spray jets
- 59" Stainless steel hose
- ABS construction
- Chrome finish



PART #	DESCRIPTION	UNIT ORDER	INN/MAS	PACK	LIST
15144	6-Function Set	1	-/12	BOX	30.17
15178	59" Stainless Steel Hose Only	1	-/10	BOX	8.68

### HANDHELD AND FIXED SHOWER SET - 2.0 GPM

**NEW**

- Fixed shower head with diverter for handheld use
- Six settings
- 4" Face on handheld and fixed shower head
- Self-cleaning rubber spray jets
- 59" Stainless steel hose
- ABS construction
- Chrome finish



PART #	DESCRIPTION	UNIT ORDER	INN/MAS	PACK	LIST
15145	6-Function Set	1	-/12	BOX	51.09
15178	59" Stainless Steel Hose Only	1	-/10	BOX	8.68

### PULSATING MASSAGE HANDHELD SHOWER - 1.8 GPM

- Pulsating three-way adjustment
- Nonmetallic
- Includes 59" flex hose and bracket
- 1.8 GPM flow rate
- Chrome

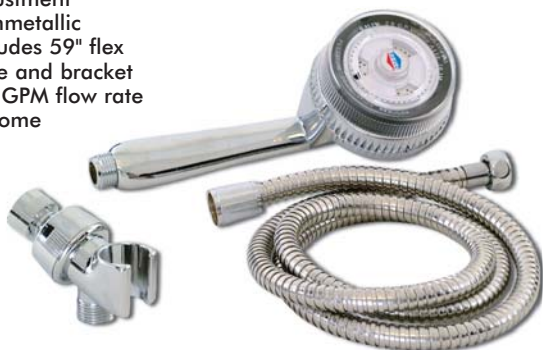

PART #	DESCRIPTION	UNIT ORDER	INN/MAS	PACK	LIST
15070	Handheld Shower Unit	1	-/12	CLAM	30.59
15078	59" Flex Hose Only	5	-/50	BAG	10.49

## HANDHELD SHOWER REPLACEMENT BRACKET

- Easily connects to standard 1/2" size shower arms



PART #	DESCRIPTION	UNIT ORDER	INN/MAS	PACK	LIST
16074	Chrome	10	-/200	BAG	5.08

## Shower Arms and Parts

### ABS SHOWER ARM WITH FLANGE

- 1/2" MIP both ends
- Includes steel flange
- Chrome



PART #	DESCRIPTION	UNIT ORDER	INN/MAS	PACK	LIST
15059	7-1/4"	10	10/200	BAG	2.40

### BRASS SHOWER ARM

- Brass construction
- 1/2" MIP both ends
- Chrome



PART #	DESCRIPTION	UNIT ORDER	INN/MAS	PACK	LIST
15051	6"	1	10/100	BAG	5.53
15055	8"	1	10/100	BAG	7.13

### BRASS SHOWER ARM

- Brass construction
- 1/2" MIP both ends
- Brushed nickel



PART #	DESCRIPTION	UNIT ORDER	INN/MAS	PACK	LIST
15050	6"	1	10/100	BAG	9.64



## Shower Arms and Parts

### BRASS SHOWER ARM WITH FLANGE

- Includes steel flange
- 1/2" MIP both ends



PART #	DESCRIPTION	UNIT ORDER	INN/MAS	PACK	LIST
15053	Chrome 6"	10	10/100	BAG	7.04
*14138	Polished Brass 6"	1	10/100	BAG	2.11

\*While Supplies Last

### SHOWER HEAD WITH ARM - 2.0 GPM

- ABS construction shower head
- Steel flange
- Brass shower arm
- Chrome



PART #	DESCRIPTION	UNIT ORDER	INN/MAS	PACK	LIST
15029	Brass Ball Joint Shower Head with Arm	10	-/50	BOX	12.86
15039	Replacement Shower Head Only	10	10/100	BOX	6.73

### S-SHAPE SHOWER ARM & FLANGE

- Brass shower arm
- Includes steel flange
- Increases height by 11"
- 1/2" MIP both ends
- Chrome



PART #	DESCRIPTION	UNIT ORDER	INN/MAS	PACK	LIST
15058	11" Height	10	10/40	BAG	22.18

### S-SHAPE SHOWER ARM & FLANGE

- Brass shower arm
- 1/2" MIP both ends
- Includes steel flange
- Chrome



PART #	DESCRIPTION	UNIT ORDER	INN/MAS	PACK	LIST
15054	8" Height	5	5/50	BAG	23.29
15056	11" Height	5	5/50	BAG	26.12

### ADJUSTABLE SWIVEL SHOWER ARM

- Brass construction
- Fits standard 1/2" pipe threads
- Swings up and down to adjust shower head height
- 9-1/2" Length



PART #	DESCRIPTION	UNIT ORDER	INN/MAS	PACK	LIST
15116	Chrome	1	-/50	BULK	27.49

### SHOWER ARM FLANGE

- Fits all 1/2" shower arms



25723



25703



15041



PART #	DESCRIPTION	UNIT ORDER	INN/MAS	PACK	LIST
15041	Chrome ABS with Set Screw	10	10/200	BULK	1.85
25703	Chrome Steel	25	500/2000	BULK	0.26
25723	Brushed Nickel ABS	1	50/500	BULK	4.48

Supply Connectors

Stop Valves

Water Heater

Gas Connectors

Water Filtration

Sinks/Faucets

Tubular/Drainage

Faucet Repair

Bath Accessories

Pipe Fittings/Repair

Valves

Cements/Sealants

Tools/Safety

Toilet Repair

Appliance/HVAC

Hardware

Electrical

Index

# BATHROOM ACCESSORIES

## Shower Arms and Parts

### BALL JOINT SHOWER ARM ADAPTER

- Converts Price Pfister® ball shower arm to standard thread
- Chrome-plated brass



PART #	DESCRIPTION	UNIT ORDER	INN/MAS	PACK	LIST
15060	1/2" IPS x 1-1/8" - 20-Thread	10	10/50	BULK	4.70

### THIN-WALL SHOWER STALL ELBOW

- Used to install shower arm on fiberglass or acrylic shower units
- For 1/2" copper or iron pipe
- Brass with locking nut



PART #	DESCRIPTION	UNIT ORDER	INN/MAS	PACK	LIST
15361	1/2" With Two Nuts	10	-/200	BULK	7.38

## SHOWER HEAD VOLUME CONTROL

- Used to increase or decrease flow of water to shower head
- Brass construction
- Chrome



PART #	DESCRIPTION	UNIT ORDER	INN/MAS	PACK	LIST
15043	Fits 1/2" Shower Arms	10	10/100	BAG	6.36

## NEW FIT-ALL TUB SPOUTS!

See all **NEW** tubspouts and accessories

See pages... **97-99**



Visit us online at...

[www.ez-flo.net](http://www.ez-flo.net)

# PIPE FITTINGS AND REPAIR

## PVC DWV Fittings

### COUPLING - PVC/DWV

- Schedule 40
- Hub x hub



PART #	DESCRIPTION	UNIT ORDER	INN/MAS	PACK	LIST
85550	1-1/2"	100	-/100	BULK	<b>CALL FOR CURRENT PRICE</b>
85555	1-1/2" x 2"	50	-/50	BULK	
85556	1-1/2" x 3"	50	-/50	BULK	
85551	2"	100	-/100	BULK	
85557	3" x 2"	50	-/50	BULK	
85552	3"	50	-/50	BULK	
85558	4" x 2"	10	-/10	BULK	
85559	4" x 3"	10	-/10	BULK	
85553	4"	25	-/25	BULK	
85554	6"	10	-/10	BULK	

### REPAIR COUPLING - PVC/DWV

- Schedule 40
- Slip x slip



PART #	DESCRIPTION	UNIT ORDER	INN/MAS	PACK	LIST
85560	1-1/2" Less Stop	20	-/20	BULK	<b>CALL FOR CURRENT PRICE</b>
85561	2" Less Stop	20	-/20	BULK	
85562	3" Less Stop	20	-/20	BULK	
85563	4" Less Stop	10	-/10	BULK	
85730	6" Less Stop	5	-/5	BULK	

### 90° ELBOW - PVC/DWV

- Schedule 40
- Hub x hub



PART #	DESCRIPTION	UNIT ORDER	INN/MAS	PACK	LIST
85699	1-1/2"	100	-/100	BULK	<b>CALL FOR CURRENT PRICE</b>
85700	2"	50	-/50	BULK	
85701	3"	25	-/25	BULK	
85702	4"	10	-/10	BULK	
85731	6"	5	-/5	BULK	

### 90° LONG SWEEP ELBOW - PVC/DWV

- Schedule 40
- Hub x hub



PART #	DESCRIPTION	UNIT ORDER	INN/MAS	PACK	LIST
85703	1-1/2"	50	-/50	BULK	<b>CALL FOR CURRENT PRICE</b>
85704	2"	25	-/25	BULK	
85705	3"	20	-/20	BULK	
85706	4"	10	-/10	BULK	

### 90° STREET ELBOW - PVC/DWV

- Schedule 40
- Spigot x hub



PART #	DESCRIPTION	UNIT ORDER	INN/MAS	PACK	LIST
85707	1-1/2"	100	-/100	BULK	<b>CALL FOR CURRENT PRICE</b>
85708	2"	50	-/50	BULK	
85709	3"	20	-/20	BULK	
85710	4"	10	-/10	BULK	
85732	6"	5	-/5	BULK	

### 90° LONG SWEEP STREET ELBOW - PVC/DWV

- Schedule 40
- Spigot x hub



PART #	DESCRIPTION	UNIT ORDER	INN/MAS	PACK	LIST
85711	1-1/2"	50	-/50	BULK	<b>CALL FOR CURRENT PRICE</b>
85712	2"	20	-/20	BULK	
85713	3"	20	-/20	BULK	
85733	4"	10	-/10	BULK	

### 90° CLOSET ELBOW - PVC/DWV

- Schedule 40
- Hub x hub



PART #	DESCRIPTION	UNIT ORDER	INN/MAS	PACK	LIST
85714	4" x 3"	10	-/10	BULK	<b>CALL FOR CURRENT PRICE</b>

### 90° CLOSET STREET ELBOW - PVC/DWV

- Schedule 40
- Spigot x hub



PART #	DESCRIPTION	UNIT ORDER	INN/MAS	PACK	LIST
85715	4" x 3"	10	-/10	BULK	<b>CALL FOR CURRENT PRICE</b>

Supply Connectors

Stop Valves

Water Heater

Gas Connectors

Water Filtration

Sinks/Faucets

Tubular/Drainage

Faucet Repair

Bath Accessories

Pipe Fittings/Repair

Valves

Cements/Sealants

Tools/Safety

Toilet Repair

Appliance/HVAC

Hardware

Electrical

Index

# PIPE FITTINGS AND REPAIR

## PVC DWV Fittings

### 90° VENT ELBOW - PVC/DWV

- Schedule 40
- Hub x hub



PART #	DESCRIPTION	UNIT ORDER	INN/MAS	PACK	LIST
85716	1-1/2"	100	-/100	BULK	<b>CALL FOR CURRENT PRICE</b>
85717	2"	50	-/50	BULK	
85718	3"	25	-/25	BULK	
*85734	4"	10	-/10	BULK	

\*While Supplies Last

### 90° ELBOW WITH LOW HEEL INLET - PVC/DWV

- Schedule 40
- All hub



PART #	DESCRIPTION	UNIT ORDER	INN/MAS	PACK	LIST
85719	3" x 3" x 2"	20	-/20	BULK	<b>CALL FOR CURRENT PRICE</b>

### 45° ELBOW - PVC/DWV

- Schedule 40
- Hub x hub



PART #	DESCRIPTION	UNIT ORDER	INN/MAS	PACK	LIST
85569	1-1/2"	100	-/100	BULK	<b>CALL FOR CURRENT PRICE</b>
85570	2"	50	-/50	BULK	
85571	3"	20	-/20	BULK	
85572	4"	10	-/10	BULK	
85573	6"	5	-/5	BULK	

### 45° STREET ELBOW - PVC/DWV

- Schedule 40
- Spigot x hub



PART #	DESCRIPTION	UNIT ORDER	INN/MAS	PACK	LIST
85574	1-1/2"	100	-/100	BULK	<b>CALL FOR CURRENT PRICE</b>
85575	2"	50	-/50	BULK	
85576	3"	20	-/20	BULK	
85577	4"	10	-/10	BULK	
85578	6"	5	-/5	BULK	

### 22-1/2° ELBOW - PVC/DWV

- Schedule 40
- Hub x hub



PART #	DESCRIPTION	UNIT ORDER	INN/MAS	PACK	LIST
85579	1-1/2"	50	-/50	BULK	<b>CALL FOR CURRENT PRICE</b>
85580	2"	50	-/50	BULK	
85581	3"	20	-/20	BULK	
85582	4"	10	-/10	BULK	
85735	6"	5	-/5	BULK	

### 22-1/2° STREET ELBOW - PVC/DWV

- Schedule 40
- Spigot x hub



PART #	DESCRIPTION	UNIT ORDER	INN/MAS	PACK	LIST
85583	1-1/2"	50	-/50	BULK	<b>CALL FOR CURRENT PRICE</b>
85584	2"	50	-/50	BULK	
85585	3"	20	-/20	BULK	
85586	4"	10	-/10	BULK	

### 60° ELBOW - PVC/DWV

- Schedule 40
- Hub x hub



PART #	DESCRIPTION	UNIT ORDER	INN/MAS	PACK	LIST
85587	1-1/2"	50	-/50	BULK	<b>CALL FOR CURRENT PRICE</b>
85588	2"	20	-/20	BULK	
85589	3"	10	-/10	BULK	
85590	4"	10	-/10	BULK	

### DOUBLE ELBOW - PVC/DWV

- Schedule 40
- All hub



PART #	DESCRIPTION	UNIT ORDER	INN/MAS	PACK	LIST
85591	1-1/2"	50	-/50	BULK	<b>CALL FOR CURRENT PRICE</b>
85595	2" x 1-1/2" x 1-1/2"	25	-/25	BULK	
85592	2"	25	-/25	BULK	
85593	3"	10	-/10	BULK	
85594	4"	5	-/5	BULK	

# PIPE FITTINGS AND REPAIR

## PVC DWV Fittings

### 45° WYE - PVC/DWV

- Schedule 40
- All hub



PART #	DESCRIPTION	UNIT ORDER	INN/MAS	PACK	LIST
85596	1-1/2"	50	-/50	BULK	<b>CALL FOR CURRENT PRICE</b>
85601	2" x 1-1/2" x 1-1/2"	50	-/50	BULK	
85602	2" x 2" x 1-1/2"	50	-/50	BULK	
85597	2"	25	-/25	BULK	
85603	3" x 3" x 1-1/2"	20	-/20	BULK	
85604	3" x 3" x 2"	20	-/20	BULK	
85598	3"	20	-/20	BULK	
85605	4" x 4" x 2"	10	-/10	BULK	
85606	4" x 4" x 3"	10	-/10	BULK	
85599	4"	10	-/10	BULK	
85607	6" x 6" x 4"	5	-/5	BULK	
85600	6"	3	-/3	BULK	

### COMBO WYE - PVC/DWV

- Schedule 40
- All hub



PART #	DESCRIPTION	UNIT ORDER	INN/MAS	PACK	LIST
85608	1-1/2"	20	-/20	BULK	<b>CALL FOR CURRENT PRICE</b>
85612	2" x 2" x 1-1/2"	20	-/20	BULK	
85609	2"	20	-/20	BULK	
85613	3" x 3" x 2"	10	-/10	BULK	
85610	3"	10	-/10	BULK	
85614	4" x 4" x 2"	10	-/10	BULK	
85615	4" x 4" x 3"	5	-/5	BULK	
85611	4"	5	-/5	BULK	

### DOUBLE WYE - PVC/DWV

- Schedule 40
- All hub



PART #	DESCRIPTION	UNIT ORDER	INN/MAS	PACK	LIST
85616	1-1/2"	25	-/25	BULK	<b>CALL FOR CURRENT PRICE</b>
85617	2"	20	-/20	BULK	
85620	3" x 3" x 2" x 2"	10	-/10	BULK	
85618	3"	10	-/10	BULK	
85621	4" x 4" x 3" x 3"	5	-/5	BULK	
85619	4"	5	-/5	BULK	
85737	6" x 6" x 4" x 4"	3	-/3	BULK	
85736	6"	2	-/2	BULK	

## DOUBLE FIXTURE TEE - PVC/DWV

- Schedule 40
- All hub



PART #	DESCRIPTION	UNIT ORDER	INN/MAS	PACK	LIST
85622	2" x 1-1/2" x 1-1/2" x 1-1/2"	25	-/25	BULK	<b>CALL FOR CURRENT PRICE</b>

## SANITARY TEE - PVC/DWV

- Schedule 40
- All hub



PART #	DESCRIPTION	UNIT ORDER	INN/MAS	PACK	LIST
85635	1-1/2"	100	-/100	BULK	<b>CALL FOR CURRENT PRICE</b>
85639	2" x 1-1/2" x 1-1/2"	50	-/50	BULK	
85640	2" x 1-1/2" x 2"	50	-/50	BULK	
85641	2" x 2" x 1-1/2"	50	-/50	BULK	
85636	2"	35	-/35	BULK	
85642	3" x 3" x 1-1/2"	20	-/20	BULK	
85643	3" x 3" x 2"	20	-/20	BULK	
85637	3"	20	-/20	BULK	
85644	4" x 4" x 2"	10	-/10	BULK	
85645	4" x 4" x 3"	10	-/10	BULK	
85638	4"	10	-/10	BULK	
85740	6"	3	-/3	BULK	

## DOUBLE SANITARY TEE - PVC/DWV

- Schedule 40
- All hub



PART #	DESCRIPTION	UNIT ORDER	INN/MAS	PACK	LIST
85646	1-1/2"	50	-/50	BULK	<b>CALL FOR CURRENT PRICE</b>
85650	2" x 2" x 1-1/2" x 1-1/2"	25	-/25	BULK	
85647	2"	20	-/20	BULK	
85651	3" x 3" x 1-1/2" x 1-1/2"	20	-/20	BULK	
85652	3" x 3" x 2" x 2"	20	-/20	BULK	
85648	3"	10	-/10	BULK	
85653	4" x 4" x 3" x 3"	5	-/5	BULK	
85649	4"	5	-/5	BULK	

## SANITARY TEE WITH SIDE INLET - PVC/DWV

- Schedule 40
- All hub



PART #	DESCRIPTION	UNIT ORDER	INN/MAS	PACK	LIST
85663	(Left) 3" x 3" x 3" x 2"	10	-/10	BULK	<b>CALL FOR CURRENT PRICE</b>
85664	(Right) 3" x 3" x 3" x 2"	10	-/10	BULK	

Supply Connectors

Stop Valves

Water Heater

Gas Connectors

Water Filtration

Sinks/Faucets

Tubular/Drainage

Faucet Repair

Bath Accessories

Pipe Fittings/Repair

Valves

Cements/Sealants

Tools/Safety

Toilet Repair

Appliance/HVAC

Hardware

Electrical

Index

# PIPE FITTINGS AND REPAIR

## PVC DWV Fittings

### TWO-WAY CLEANOUT TEE - PVC/DWV

- Schedule 40
- All hub



PART #	DESCRIPTION	UNIT ORDER	INN/MAS	PACK	LIST
85654	Two-Way 3"	10	-/10	BULK	CALL FOR CURRENT PRICE
85655	Two-Way 4"	5	-/5	BULK	

### SANITARY STREET TEE - PVC/DWV

- Schedule 40
- Spigot x hub x hub



PART #	DESCRIPTION	UNIT ORDER	INN/MAS	PACK	LIST
85742	1-1/2"	50	-/50	BULK	CALL FOR CURRENT PRICE
85743	2"	20	-/20	BULK	
85667	3"	15	-/15	BULK	
85744	4"	10	-/10	BULK	

### TEST TEE - PVC/DWV

- Schedule 40
- Hub x hub x FIP



PART #	DESCRIPTION	UNIT ORDER	INN/MAS	PACK	LIST
85656	1-1/2"	50	-/50	BULK	CALL FOR CURRENT PRICE
85657	2"	25	-/25	BULK	
85658	3"	10	-/10	BULK	
85659	4"	10	-/10	BULK	

### TEST TEE WITH CLEANOUT PLUG - PVC/DWV

- Schedule 40
- Hub x hub x FIP



PART #	DESCRIPTION	UNIT ORDER	INN/MAS	PACK	LIST
85660	1-1/2"	50	-/50	BULK	CALL FOR CURRENT PRICE
85661	2"	50	-/50	BULK	
85662	3"	10	-/10	BULK	
85741	4"	10	-/10	BULK	

### CLEANOUT PLUG - PVC/DWV

- Schedule 40
- MIP



PART #	DESCRIPTION	UNIT ORDER	INN/MAS	PACK	LIST
85623	1-1/2"	100	-/100	BULK	CALL FOR CURRENT PRICE
85624	2"	100	-/100	BULK	
85625	3"	50	-/50	BULK	
85626	4"	20	-/20	BULK	
85738	6"	10	-/10	BULK	

### FITTING CLEANOUT ADAPTER - PVC/DWV

- Schedule 40
- Spigot x FIP



PART #	DESCRIPTION	UNIT ORDER	INN/MAS	PACK	LIST
85627	1-1/2"	50	-/50	BULK	CALL FOR CURRENT PRICE
85628	2"	50	-/50	BULK	
85629	3"	20	-/20	BULK	
85630	4"	10	-/10	BULK	
85739	6"	10	-/10	BULK	

### MALE ADAPTER - PVC/DWV

- Schedule 40
- Hub x MIP



PART #	DESCRIPTION	UNIT ORDER	INN/MAS	PACK	LIST
85631	1-1/2"	100	-/100	BULK	CALL FOR CURRENT PRICE
85632	2"	100	-/100	BULK	
85633	3"	20	-/20	BULK	
85634	4"	10	-/10	BULK	

## PVC DWV Fittings

### FEMALE ADAPTER - PVC/DWV

- Schedule 40
- FIP x hub



PART #	DESCRIPTION	UNIT ORDER	INN/MAS	PACK	LIST
85669	1-1/2"	50	-/50	BULK	<b>CALL FOR CURRENT PRICE</b>
85670	2"	50	-/50	BULK	
85671	3"	20	-/20	BULK	
85672	4"	10	-/10	BULK	
85745	6"	10	-/10	BULK	

### SEWER ADAPTER COUPLING - PVC/DWV

- Schedule 40
- SD spigot x DWV hub



PART #	DESCRIPTION	UNIT ORDER	INN/MAS	PACK	LIST
85673	4" x 3"	10	-/10	BULK	<b>CALL FOR CURRENT PRICE</b>

### NO-HUB ADAPTER - PVC/DWV

- Schedule 40
- No hub x hub



PART #	DESCRIPTION	UNIT ORDER	INN/MAS	PACK	LIST
85674	3"	10	-/10	BULK	<b>CALL FOR CURRENT PRICE</b>
85675	4"	10	-/10	BULK	

### TRAP ADAPTER - PVC/DWV

- Schedule 40
- Male spigot x slip-joint



PART #	DESCRIPTION	UNIT ORDER	INN/MAS	PACK	LIST
85676	1-1/4" x 1-1/4"	100	-/100	BULK	<b>CALL FOR CURRENT PRICE</b>

### TRAP ADAPTER - PVC/DWV

- Schedule 40
- Female hub x slip-joint



PART #	DESCRIPTION	UNIT ORDER	INN/MAS	PACK	LIST
85677	1-1/2" x 1-1/4"	100	-/100	BULK	<b>CALL FOR CURRENT PRICE</b>
85678	1-1/2" x 1-1/2"	100	-/100	BULK	

### FLUSH BUSHING - PVC/DWV

- Schedule 40
- Spigot x hub



PART #	DESCRIPTION	UNIT ORDER	INN/MAS	PACK	LIST
85679	2" x 1-1/2"	100	-/100	BULK	<b>CALL FOR CURRENT PRICE</b>
85680	3" x 1-1/2"	50	-/50	BULK	
85681	3" x 2"	30	-/30	BULK	
85682	4" x 2"	10	-/10	BULK	
85683	4" x 3"	10	-/10	BULK	
85684	6" x 4"	5	-/5	BULK	

### CAP - PVC/DWV

- Schedule 40
- Slip



PART #	DESCRIPTION	UNIT ORDER	INN/MAS	PACK	LIST
85564	1-1/2"	50	-/50	BULK	<b>CALL FOR CURRENT PRICE</b>
85565	2"	50	-/50	BULK	
85566	3"	15	-/15	BULK	
85567	4"	9	-/9	BULK	
85568	6"	3	-/3	BULK	

Supply Connectors

Stop Valves

Water Heater

Gas Connectors

Water Filtration

Sinks/Faucets

Tubular/Drainage

Faucet Repair

Bath Accessories

Pipe Fittings/Repair

Valves

Cements/Sealants

Tools/Safety

Toilet Repair

Appliance/HVAC

Hardware

Electrical

Index

# PIPE FITTINGS AND REPAIR

## PVC DWV Fittings

### P-TRAP - PVC/DWV

- Schedule 40
- Hub x hub



PART #	DESCRIPTION	UNIT ORDER	INN/MAS	PACK	LIST
85685	1-1/2"	25	-/25	BULK	<b>CALL FOR CURRENT PRICE</b>
85686	2"	20	-/20	BULK	
85687	3"	10	-/10	BULK	
85688	4"	5	-/5	BULK	

### P-TRAP WITH UNION - PVC/DWV

- Schedule 40
- Hub x hub



PART #	DESCRIPTION	UNIT ORDER	INN/MAS	PACK	LIST
85689	1-1/2"	50	-/50	BULK	<b>CALL FOR CURRENT PRICE</b>
85690	2"	25	-/25	BULK	

### PERMOSEAL® P-TRAP

- Innovative ball-joint style union helps overcome installation problems such as pipe misalignment and offset fittings
- Gasket seal ensures a leak-proof connection in almost any situation
- Oversized union nut easily hand-tightens for a positive seal
- Hub x hub



PART #	DESCRIPTION	UNIT ORDER	INN/MAS	PACK	LIST
73001	1-1/2" PVC	1	-/35	BULK	<b>6.90</b>

### REDUCING P-TRAP - PVC/DWV

- Schedule 40
- Hub x slip-joint



PART #	DESCRIPTION	UNIT ORDER	INN/MAS	PACK	LIST
85691	1-1/2" x 1-1/2" or 1-1/4"	50	-/50	BULK	<b>CALL FOR CURRENT PRICE</b>

### P-TRAP WITH CLEANOUT - PVC/DWV

- Schedule 40
- Hub x hub



PART #	DESCRIPTION	UNIT ORDER	INN/MAS	PACK	LIST
85692	1-1/2"	25	-/25	BULK	<b>CALL FOR CURRENT PRICE</b>

## PVC Sewer and Drain Fittings

### COUPLING

- PVC solvent weld sewer fitting SDR 35
- Hub x hub



PART #	DESCRIPTION	UNIT ORDER	INN/MAS	PACK	LIST
84228	3"	1	-/40	BULK	<b>CALL FOR CURRENT PRICE</b>
84230	4"	1	-/36	BULK	
84231	6"	1	-/18	BULK	

### SEWER ADAPTER COUPLING

- PVC solvent weld sewer fitting SDR 35
- SD hub x DWV hub



PART #	DESCRIPTION	UNIT ORDER	INN/MAS	PACK	LIST
84232	4" x 3"	1	-/45	BULK	<b>CALL FOR CURRENT PRICE</b>
84235	4"	1	-/15	BULK	
*84237	6"	1	-/12	BULK	

\*While Supplies Last

### REDUCER COUPLING

- PVC solvent weld sewer fitting SDR 35
- Hub x hub



PART #	DESCRIPTION	UNIT ORDER	INN/MAS	PACK	LIST
84240	4" x 3"	1	-/45	BULK	<b>CALL FOR CURRENT PRICE</b>
84241	6" x 4"	1	-/15	BULK	



## PVC Sewer and Drain Fittings

### 90° ELBOW

- PVC solvent weld sewer fitting SDR 35
- Hub x hub



PART #	DESCRIPTION	UNIT ORDER	INN/MAS	PACK	LIST
84207	3"	1	-/25	BULK	<b>CALL FOR CURRENT PRICE</b>
84209	4"	1	-/24	BULK	
84211	6"	1	-/8	BULK	

### LONG TURN 90° ELBOW

- PVC solvent weld sewer fitting SDR 35
- Hub x hub



PART #	DESCRIPTION	UNIT ORDER	INN/MAS	PACK	LIST
84213	3"	1	-/20	BULK	<b>CALL FOR CURRENT PRICE</b>
84215	4"	1	-/20	BULK	

### LONG TURN 90° STREET ELBOW

- PVC solvent weld sewer fitting SDR 35
- Spigot x hub



PART #	DESCRIPTION	UNIT ORDER	INN/MAS	PACK	LIST
84218	4"	1	-/20	BULK	<b>CALL FOR CURRENT PRICE</b>

### 45° ELBOW

- PVC solvent weld sewer fitting SDR 35
- Hub x hub



PART #	DESCRIPTION	UNIT ORDER	INN/MAS	PACK	LIST
84201	3"	1	-/60	BULK	<b>CALL FOR CURRENT PRICE</b>
84202	4"	1	-/30	BULK	
84203	6"	1	-/12	BULK	

### 45° STREET ELBOW

- PVC solvent weld sewer fitting SDR 35
- Spigot x hub



PART #	DESCRIPTION	UNIT ORDER	INN/MAS	PACK	LIST
*84204	3"	1	-/30	BULK	<b>CALL FOR CURRENT PRICE</b>
84205	4"	1	-/30	BULK	
*84206	6"	1	-/12	BULK	

\*While Supplies Last

### 22-1/2° ELBOW

- PVC solvent weld sewer fitting SDR 35
- Hub x hub



PART #	DESCRIPTION	UNIT ORDER	INN/MAS	PACK	LIST
84219	3"	1	-/13	BULK	<b>CALL FOR CURRENT PRICE</b>
84220	4"	1	-/45	BULK	
84221	6"	1	-/10	BULK	

### 22-1/2° STREET ELBOW

- PVC solvent weld sewer fitting SDR 35
- Spigot x hub



PART #	DESCRIPTION	UNIT ORDER	INN/MAS	PACK	LIST
84223	4"	1	-/22	BULK	<b>CALL FOR CURRENT PRICE</b>

### 45° WYE

- PVC solvent weld sewer fitting SDR 35
- All hub



PART #	DESCRIPTION	UNIT ORDER	INN/MAS	PACK	LIST
*84270	3"	1	-/25	BULK	<b>CALL FOR CURRENT PRICE</b>
84271	4"	1	-/16	BULK	
84274	6"	1	-/4	BULK	

\*While Supplies Last

Supply Connectors

Stop Valves

Water Heater

Gas Connectors

Water Filtration

Sinks/Faucets

Tubular/Drainage

Faucet Repair

Bath Accessories

Pipe Fittings/Repair

Valves

Cements/Sealants

Tools/Safety

Toilet Repair

Appliance/HVAC

Hardware

Electrical

Index

# PIPE FITTINGS AND REPAIR

## PVC Sewer and Drain Fittings

### TEE

- PVC solvent weld sewer fitting SDR 35
- All hub



PART #	DESCRIPTION	UNIT ORDER	INN/MAS	PACK	LIST
*84261	3"	1	-/30	BULK	CALL FOR CURRENT PRICE
84262	4"	1	-/20	BULK	CALL FOR CURRENT PRICE

\*While Supplies Last

### MALE ADAPTER

- PVC solvent weld sewer fitting SDR 35
- Hub x MIP



PART #	DESCRIPTION	UNIT ORDER	INN/MAS	PACK	LIST
*84281	3"	1	-/40	BULK	CALL FOR CURRENT PRICE
*84282	4"	1	-/30	BULK	CALL FOR CURRENT PRICE

\*While Supplies Last

### SANITARY TEE

- PVC solvent weld sewer fitting SDR 35
- All hub



PART #	DESCRIPTION	UNIT ORDER	INN/MAS	PACK	LIST
84265	3"	1	-/30	BULK	CALL FOR CURRENT PRICE
84266	4"	1	-/18	BULK	CALL FOR CURRENT PRICE

### FEMALE ADAPTER

- PVC solvent weld sewer fitting SDR 35
- Hub x FIP



PART #	DESCRIPTION	UNIT ORDER	INN/MAS	PACK	LIST
84269	4"	1	-/20	BULK	CALL FOR CURRENT PRICE
84280	6"	1	-/15	BULK	CALL FOR CURRENT PRICE

### TWO-WAY CLEANOUT TEE

- PVC solvent weld sewer fitting SDR 35
- All hub



PART #	DESCRIPTION	UNIT ORDER	INN/MAS	PACK	LIST
84304	4"	1	-/10	BULK	CALL FOR CURRENT PRICE

### CORRUGATED ADAPTER

- PVC solvent weld sewer fitting SDR 35
- Spigot x SD hub



PART #	DESCRIPTION	UNIT ORDER	INN/MAS	PACK	LIST
84295	4"	1	-/24	BULK	CALL FOR CURRENT PRICE

### FITTING CLEANOUT ADAPTER

- PVC solvent weld sewer fitting SDR 35
- Spigot x FIP



PART #	DESCRIPTION	UNIT ORDER	INN/MAS	PACK	LIST
*84275	3"	1	-/25	BULK	CALL FOR CURRENT PRICE
84276	4"	1	-/20	BULK	CALL FOR CURRENT PRICE
*84277	6"	1	-/20	BULK	CALL FOR CURRENT PRICE

\*While Supplies Last

### DOWNSPOUT ADAPTER

- PVC solvent weld sewer fitting SDR 35
- Downspout x SD hub



PART #	DESCRIPTION	UNIT ORDER	INN/MAS	PACK	LIST
*84284	2" x 3" x 3"	1	-/36	BULK	CALL FOR CURRENT PRICE
84285	2" x 3" x 4"	1	-/22	BULK	CALL FOR CURRENT PRICE
*84287	3" x 4" x 3"	1	-/24	BULK	CALL FOR CURRENT PRICE
84286	3" x 4" x 4"	1	-/8	BULK	CALL FOR CURRENT PRICE

\*While Supplies Last

## PVC Sewer and Drain Fittings

### OFFSET DOWNSPOUT ADAPTER

- PVC solvent weld sewer fitting SDR 35
- Downspout x SD hub



PART #	DESCRIPTION	UNIT ORDER	INN/MAS	PACK	LIST
84288	2" x 3" x 3"	1	-/36	BULK	<b>CALL FOR CURRENT PRICE</b>
84289	2" x 3" x 4"	1	-/22	BULK	
84290	3" x 4" x 4"	1	-/24	BULK	
*84291	4" x 6" x 6"	1	-/8	BULK	

\*While Supplies Last

### OFFSET CORRUGATED DOWNSPOUT ADAPTER

- PVC solvent weld sewer fitting SDR 35
- Downspout x SD hub



PART #	DESCRIPTION	UNIT ORDER	INN/MAS	PACK	LIST
*84292	2" x 3" x 4"	1	-/32	BULK	<b>CALL FOR CURRENT PRICE</b>

\*While Supplies Last

### SEWER ADAPTER BUSHING

- PVC solvent weld sewer fitting SDR 35
- DWV spigot x SD hub



PART #	DESCRIPTION	UNIT ORDER	INN/MAS	PACK	LIST
84278	4"	1	-/36	BULK	<b>CALL FOR CURRENT PRICE</b>
*84283	6"	1	-/20	BULK	

\*While Supplies Last

### DWV ADAPTER BUSHING

- PVC solvent weld sewer fitting SDR 35
- SD spigot x DWV hub



PART #	DESCRIPTION	UNIT ORDER	INN/MAS	PACK	LIST
84249	4" x 2"	1	-/8	BULK	<b>CALL FOR CURRENT PRICE</b>

### REDUCER BUSHING

- PVC solvent weld sewer fitting SDR 35
- Hub x hub



PART #	DESCRIPTION	UNIT ORDER	INN/MAS	PACK	LIST
84260	6" x 4"	1	-/15	BULK	<b>CALL FOR CURRENT PRICE</b>

### DRAIN GRATE

- PVC solvent weld sewer fitting SDR 35
- Slip



PART #	DESCRIPTION	UNIT ORDER	INN/MAS	PACK	LIST
*84296	3"	1	-/50	BULK	<b>CALL FOR CURRENT PRICE</b>
84297	4"	1	-/30	BULK	
*84298	6"	1	-/15	BULK	

\*While Supplies Last

### THREADED PLUG

- PVC solvent weld sewer fitting SDR 35
- MIP



PART #	DESCRIPTION	UNIT ORDER	INN/MAS	PACK	LIST
84299	3"	1	-/75	BULK	<b>CALL FOR CURRENT PRICE</b>
84300	4"	1	-/40	BULK	
84301	6"	1	-/35	BULK	

### COUNTERSUNK PLUG

- PVC solvent weld sewer fitting SDR 35
- MIP



PART #	DESCRIPTION	UNIT ORDER	INN/MAS	PACK	LIST
84302	4"	1	-/20	BULK	<b>CALL FOR CURRENT PRICE</b>
84303	6"	1	-/40	BULK	

### CAP

- PVC solvent weld sewer fitting SDR 35
- Slip



PART #	DESCRIPTION	UNIT ORDER	INN/MAS	PACK	LIST
84224	3"	1	-/100	BULK	<b>CALL FOR CURRENT PRICE</b>
84226	4"	1	-/20	BULK	
84227	6"	1	-/40	BULK	

# PIPE FITTINGS AND REPAIR

## ABS DWV Fittings

### COUPLING - ABS/DWV

- Schedule 40
- Hub x hub



PART #	DESCRIPTION	UNIT ORDER	INN/MAS	PACK	LIST
85400	1-1/2"	100	-/100	BULK	<b>CALL FOR CURRENT PRICE</b>
85401	2"	100	-/100	BULK	
85405	3" x 2"	50	-/50	BULK	
85402	3"	50	-/50	BULK	
85406	4" x 2"	10	-/10	BULK	
85407	4" x 3"	10	-/10	BULK	
85403	4"	25	-/25	BULK	

### 90° ELBOW - ABS/DWV

- Schedule 40
- Hub x hub



PART #	DESCRIPTION	UNIT ORDER	INN/MAS	PACK	LIST
85412	1-1/2"	100	-/100	BULK	<b>CALL FOR CURRENT PRICE</b>
85413	2"	50	-/50	BULK	
85414	3"	25	-/25	BULK	
85415	4"	10	-/10	BULK	

### 90° LONG SWEEP ELBOW - ABS/DWV

- Schedule 40
- Hub x hub



PART #	DESCRIPTION	UNIT ORDER	INN/MAS	PACK	LIST
85416	1-1/2"	50	-/50	BULK	<b>CALL FOR CURRENT PRICE</b>
85417	2"	25	-/25	BULK	
85418	3"	20	-/20	BULK	
85419	4"	10	-/10	BULK	

### 90° STREET ELBOW - ABS/DWV

- Schedule 40
- Spigot x hub



PART #	DESCRIPTION	UNIT ORDER	INN/MAS	PACK	LIST
85420	1-1/2"	100	-/100	BULK	<b>CALL FOR CURRENT PRICE</b>
85421	2"	50	-/50	BULK	
85422	3"	20	-/20	BULK	
85423	4"	10	-/10	BULK	

### 90° LONG SWEEP STREET ELBOW - ABS/DWV

- Schedule 40
- Spigot x hub



PART #	DESCRIPTION	UNIT ORDER	INN/MAS	PACK	LIST
85424	1-1/2"	50	-/50	BULK	<b>CALL FOR CURRENT PRICE</b>
85425	2"	20	-/20	BULK	
85426	3"	20	-/20	BULK	

### 90° CLOSET ELBOW - ABS/DWV

- Schedule 40
- Hub x hub



PART #	DESCRIPTION	UNIT ORDER	INN/MAS	PACK	LIST
85427	4" x 3"	10	-/10	BULK	<b>CALL FOR CURRENT PRICE</b>

### 90° VENT ELBOW - ABS/DWV

- Schedule 40
- Hub x hub



PART #	DESCRIPTION	UNIT ORDER	INN/MAS	PACK	LIST
85429	1-1/2"	100	-/100	BULK	<b>CALL FOR CURRENT PRICE</b>
85430	2"	50	-/50	BULK	
85431	3"	25	-/25	BULK	

### 90° ELBOW WITH LOW HEEL INLET - ABS/DWV

- Schedule 40
- All hub



PART #	DESCRIPTION	UNIT ORDER	INN/MAS	PACK	LIST
85432	3" x 3" x 2"	20	-/20	BULK	<b>CALL FOR CURRENT PRICE</b>

## ABS DWV Fittings

### 45° ELBOW - ABS/DWV

- Schedule 40
- Hub x hub



PART #	DESCRIPTION	UNIT ORDER	INN/MAS	PACK	LIST
85433	1-1/2"	100	-/100	BULK	<b>CALL FOR CURRENT PRICE</b>
85434	2"	50	-/50	BULK	
85435	3"	20	-/20	BULK	
85436	4"	10	-/10	BULK	

### 45° STREET ELBOW - ABS/DWV

- Schedule 40
- Spigot x hub



PART #	DESCRIPTION	UNIT ORDER	INN/MAS	PACK	LIST
85437	1-1/2"	100	-/100	BULK	<b>CALL FOR CURRENT PRICE</b>
85438	2"	50	-/50	BULK	
85439	3"	20	-/20	BULK	
85440	4"	10	-/10	BULK	

### 22-1/2° ELBOW - ABS/DWV

- Schedule 40
- Hub x hub



PART #	DESCRIPTION	UNIT ORDER	INN/MAS	PACK	LIST
85441	1-1/2"	50	-/50	BULK	<b>CALL FOR CURRENT PRICE</b>
85442	2"	50	-/50	BULK	
85443	3"	20	-/20	BULK	
85444	4"	10	-/10	BULK	

### 22-1/2° STREET ELBOW - ABS/DWV

- Schedule 40
- Spigot x hub



PART #	DESCRIPTION	UNIT ORDER	INN/MAS	PACK	LIST
85445	1-1/2"	50	-/50	BULK	<b>CALL FOR CURRENT PRICE</b>
85446	2"	50	-/50	BULK	
85447	3"	20	-/20	BULK	

### 60° ELBOW - ABS/DWV

- Schedule 40
- Hub x hub



PART #	DESCRIPTION	UNIT ORDER	INN/MAS	PACK	LIST
85448	1-1/2"	50	-/50	BULK	<b>CALL FOR CURRENT PRICE</b>
85449	2"	20	-/20	BULK	
85450	3"	10	-/10	BULK	

### 45° WYE - ABS/DWV

- Schedule 40
- All hub



PART #	DESCRIPTION	UNIT ORDER	INN/MAS	PACK	LIST
85451	1-1/2"	50	-/50	BULK	<b>CALL FOR CURRENT PRICE</b>
85455	2" x 1-1/2" x 1-1/2"	50	-/50	BULK	
85456	2" x 2" x 1-1/2"	50	-/50	BULK	
85452	2"	25	-/25	BULK	
85457	3" x 3" x 1-1/2"	20	-/20	BULK	
85458	3" x 3" x 2"	20	-/20	BULK	
85453	3"	20	-/20	BULK	
85459	4" x 4" x 2"	10	-/10	BULK	
85460	4" x 4" x 3"	10	-/10	BULK	
85454	4"	10	-/10	BULK	

### COMBO WYE - ABS/DWV

- Schedule 40
- All hub



PART #	DESCRIPTION	UNIT ORDER	INN/MAS	PACK	LIST
85461	1-1/2"	20	-/20	BULK	<b>CALL FOR CURRENT PRICE</b>
85465	2" x 1-1/2" x 1-1/2"	20	-/20	BULK	
85540	2" x 2" x 1-1/2"	20	-/20	BULK	
85462	2"	20	-/20	BULK	
85466	3" x 3" x 1-1/2"	10	-/10	BULK	
85467	3" x 3" x 2"	10	-/10	BULK	
85463	3"	10	-/10	BULK	
85468	4" x 4" x 2"	10	-/10	BULK	
85469	4" x 4" x 3"	5	-/5	BULK	
85464	4"	5	-/5	BULK	

### DOUBLE FIXTURE TEE - ABS/DWV

- Schedule 40
- All hub



PART #	DESCRIPTION	UNIT ORDER	INN/MAS	PACK	LIST
85470	2" x 1-1/2" x 1-1/2" x 1-1/2"	25	-/25	BULK	<b>CALL FOR CURRENT PRICE</b>

# PIPE FITTINGS AND REPAIR

## ABS DWV Fittings

### SANITARY TEE - ABS/DWV

- Schedule 40
- All hub



PART #	DESCRIPTION	UNIT ORDER	INN/MAS	PACK	LIST
85483	1-1/2"	100	-/100	BULK	CALL FOR CURRENT PRICE
85487	2" x 1-1/2" x 1-1/2"	25	-/25	BULK	
85488	2" x 1-1/2" x 2"	50	-/50	BULK	
85489	2" x 2" x 1-1/2"	50	-/50	BULK	
85484	2"	35	-/35	BULK	
85490	3" x 3" x 1-1/2"	20	-/20	BULK	
85491	3" x 3" x 2"	20	-/20	BULK	
85485	3"	20	-/20	BULK	
85492	4" x 4" x 2"	10	-/10	BULK	
85493	4" x 4" x 3"	10	-/10	BULK	
85486	4"	10	-/10	BULK	

### DOUBLE SANITARY TEE - ABS/DWV

- Schedule 40
- All hub



PART #	DESCRIPTION	UNIT ORDER	INN/MAS	PACK	LIST
85494	1-1/2"	50	-/50	BULK	CALL FOR CURRENT PRICE
85498	2" x 2" x 1-1/2" x 1-1/2"	25	-/25	BULK	
85495	2"	20	-/20	BULK	
85499	3" x 3" x 2" x 2"	20	-/20	BULK	
85496	3"	10	-/10	BULK	

### TWO-WAY CLEANOUT TEE - ABS/DWV

- Schedule 40
- All hub



PART #	DESCRIPTION	UNIT ORDER	INN/MAS	PACK	LIST
85500	3"	10	-/10	BULK	CALL FOR CURRENT PRICE
85501	4"	5	-/5	BULK	

### TEST TEE WITH CLEANOUT PLUG - ABS/DWV

- Schedule 40
- Hub x hub x FIP



PART #	DESCRIPTION	UNIT ORDER	INN/MAS	PACK	LIST
85533	1-1/2"	50	-/50	BULK	CALL FOR CURRENT PRICE
85534	2"	50	-/50	BULK	
85535	3"	10	-/10	BULK	
85536	4"	10	-/10	BULK	

### CLEANOUT PLUG - ABS/DWV

- Schedule 40
- MIP

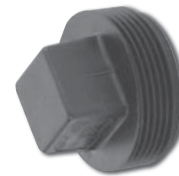

PART #	DESCRIPTION	UNIT ORDER	INN/MAS	PACK	LIST
43461	1-1/2"	1	-/100	BULK	CALL FOR CURRENT PRICE
43462	2"	1	-/100	BULK	
43464	3"	1	-/50	BULK	
43466	4"	1	-/20	BULK	

### FITTING CLEANOUT ADAPTER - ABS/DWV

- Schedule 40
- Spigot x FIP



PART #	DESCRIPTION	UNIT ORDER	INN/MAS	PACK	LIST
85475	1-1/2"	50	-/50	BULK	CALL FOR CURRENT PRICE
85476	2"	50	-/50	BULK	
85477	3"	20	-/20	BULK	
85478	4"	10	-/10	BULK	

### MALE ADAPTER - ABS/DWV

- Schedule 40
- Hub x MIP



PART #	DESCRIPTION	UNIT ORDER	INN/MAS	PACK	LIST
85479	1-1/2"	100	-/100	BULK	CALL FOR CURRENT PRICE
85480	2"	100	-/100	BULK	
85481	3"	20	-/20	BULK	
85482	4"	10	-/10	BULK	

## ABS DWV Fittings

### FEMALE ADAPTER - ABS/DWV

- Schedule 40
- Hub x FIP



PART #	DESCRIPTION	UNIT ORDER	INN/MAS	PACK	LIST
85516	1-1/2"	50	-/50	BULK	<b>CALL FOR CURRENT PRICE</b>
85517	2"	50	-/50	BULK	
85518	3"	20	-/20	BULK	
85519	4"	10	-/10	BULK	

### FLUSH BUSHING - ABS/DWV

- Schedule 40
- Spigot x hub



PART #	DESCRIPTION	UNIT ORDER	INN/MAS	PACK	LIST
85525	1-1/2" x 1-1/4"	50	-/50	BULK	<b>CALL FOR CURRENT PRICE</b>
85520	2" x 1-1/2"	50	-/50	BULK	
85521	3" x 1-1/2"	50	-/50	BULK	
85522	3" x 2"	50	-/50	BULK	
85523	4" x 2"	10	-/10	BULK	
85524	4" x 3"	10	-/10	BULK	
85532	6" x 4"	10	-/10	BULK	

### CAP - ABS/DWV

- Schedule 40
- Slip



PART #	DESCRIPTION	UNIT ORDER	INN/MAS	PACK	LIST
85408	1-1/2"	100	-/100	BULK	<b>CALL FOR CURRENT PRICE</b>
85409	2"	100	-/100	BULK	
85410	3"	50	-/50	BULK	
85411	4"	20	-/20	BULK	

### P-TRAP - ABS/DWV

- Schedule 40
- Hub x hub



PART #	DESCRIPTION	UNIT ORDER	INN/MAS	PACK	LIST
85511	1-1/2"	25	-/25	BULK	<b>CALL FOR CURRENT PRICE</b>
85512	2"	20	-/20	BULK	
85513	3"	10	-/10	BULK	
85514	4"	5	-/5	BULK	

### P-TRAP LA PATTERN - ABS/DWV

- Schedule 40
- Hub x slip-joint



PART #	DESCRIPTION	UNIT ORDER	INN/MAS	PACK	LIST
85515	1-1/2" x 1-1/2" or 1-1/4"	35	-/35	BULK	<b>CALL FOR CURRENT PRICE</b>

### PERMOSEAL® P-TRAP

- Innovative ball-joint style union allows the installer to overcome installation problems such as pipe misalignment and offset fittings
- Gasket seal ensures a leak-proof connection in almost any situation
- Oversized union nut easily hand-tightens for a positive seal
- Hub x hub



PART #	DESCRIPTION	UNIT ORDER	INN/MAS	PACK	LIST
73000	1-1/2" ABS	1	-/35	BULK	<b>5.65</b>

## PVC Schedule 40 Pressure Fittings

### COUPLING - PVC PRESSURE 40

- Schedule 40
- Slip x slip



PART #	DESCRIPTION	UNIT ORDER	INN/MAS	PACK	LIST
48468	1/2"	100	-/100	BULK	<b>CALL FOR CURRENT PRICE</b>
48469	3/4"	50	-/50	BULK	
48470	1"	50	-/50	BULK	
48471	1-1/4"	25	-/25	BULK	
48472	1-1/2"	25	-/25	BULK	
48473	2"	25	-/25	BULK	

### 90° ELBOW - PVC PRESSURE 40

- Schedule 40
- Slip x slip



PART #	DESCRIPTION	UNIT ORDER	INN/MAS	PACK	LIST
48456	1/2"	50	-/50	BULK	<b>CALL FOR CURRENT PRICE</b>
48457	3/4"	50	-/50	BULK	
48458	1"	50	-/50	BULK	
48459	1-1/4"	25	-/25	BULK	
48460	1-1/2"	25	-/25	BULK	
48461	2"	25	-/25	BULK	

Supply Connectors

Stop Valves

Water Heater

Gas Connectors

Water Filtration

Sinks/ Faucets

Tubular/ Drainage

Faucet Repair

Bath Accessories

Pipe Fittings/ Repair

Valves

Cements/ Sealants

Tools/ Safety

Toilet Repair

Appliance/ HVAC

Hardware

Electrical

Index

# PIPE FITTINGS AND REPAIR

## PVC Schedule 40 Pressure Fittings

### 90° STREET ELBOW - PVC PRESSURE 40

- Schedule 40
- Spigot x slip



PART #	DESCRIPTION	UNIT ORDER	INN/MAS	PACK	LIST
48553	3/4"	50	-/50	BULK	<b>CALL FOR CURRENT PRICE</b>

### REDUCING TEE - PVC PRESSURE 40

- Schedule 40
- All slip



PART #	DESCRIPTION	UNIT ORDER	INN/MAS	PACK	LIST
48453	3/4" x 1/2" x 3/4"	50	-/50	BULK	<b>CALL FOR CURRENT PRICE</b>

### 90° FEMALE ELBOW - PVC PRESSURE 40

- Schedule 40
- Slip x FIP



PART #	DESCRIPTION	UNIT ORDER	INN/MAS	PACK	LIST
48562	1/2"	50	-/50	BULK	<b>CALL FOR CURRENT PRICE</b>

### FEMALE REDUCING TEE - PVC PRESSURE 40

- Schedule 40
- Slip x slip x FIP



PART #	DESCRIPTION	UNIT ORDER	INN/MAS	PACK	LIST
48556	3/4" x 3/4" x 1/2"	50	-/50	BULK	<b>CALL FOR CURRENT PRICE</b>

### 45° ELBOW - PVC PRESSURE 40

- Schedule 40
- Slip x slip



PART #	DESCRIPTION	UNIT ORDER	INN/MAS	PACK	LIST
48462	1/2"	50	-/50	BULK	<b>CALL FOR CURRENT PRICE</b>
48463	3/4"	50	-/50	BULK	
48464	1"	50	-/50	BULK	
48465	1-1/4"	25	-/25	BULK	
48466	1-1/2"	25	-/25	BULK	
48467	2"	25	-/25	BULK	

### MALE ADAPTER - PVC PRESSURE 40

- Schedule 40
- MIP x slip



PART #	DESCRIPTION	UNIT ORDER	INN/MAS	PACK	LIST
48482	1/2" MIP x SLIP	100	-/100	BULK	<b>CALL FOR CURRENT PRICE</b>
48483	3/4" MIP x SLIP	50	-/50	BULK	
48484	1" MIP x SLIP	50	-/50	BULK	
48485	1-1/4" MIP x SLIP	25	-/25	BULK	
48486	1-1/2" MIP x SLIP	25	-/25	BULK	
48487	2" MIP x SLIP	25	-/25	BULK	

### TEE - PVC PRESSURE 40

- Schedule 40
- All slip



PART #	DESCRIPTION	UNIT ORDER	INN/MAS	PACK	LIST
48447	1/2"	50	-/50	BULK	<b>CALL FOR CURRENT PRICE</b>
48448	3/4"	50	-/50	BULK	
48449	1"	50	-/50	BULK	
48450	1-1/4"	25	-/25	BULK	
48451	1-1/2"	25	-/25	BULK	
48452	2"	25	-/25	BULK	

### FEMALE ADAPTER - PVC PRESSURE 40

- Schedule 40
- FIP x slip



PART #	DESCRIPTION	UNIT ORDER	INN/MAS	PACK	LIST
48474	1/2" FIP x SLIP	100	-/100	BULK	<b>CALL FOR CURRENT PRICE</b>
48475	3/4" FIP x SLIP	50	-/50	BULK	
48476	1" FIP x SLIP	50	-/50	BULK	



## PVC Schedule 40 Pressure Fittings

### REDUCER BUSHING - PVC PRESSURE 40

- Schedule 40
- Spigot x slip



PART #	DESCRIPTION	UNIT ORDER	INN/MAS	PACK	LIST
48488	3/4" SPIG x 1/2" SLIP	100	-/100	BULK	<b>CALL FOR CURRENT PRICE</b>
48489	1" SPIG x 1/2" SLIP	100	-/100	BULK	
48490	1" SPIG x 3/4" SLIP	100	-/100	BULK	
48493	1-1/4" SPIG x 1" SLIP	25	-/25	BULK	
48495	1-1/2" SPIG x 3/4" SLIP	25	-/25	BULK	
48496	1-1/2" SPIG x 1" SLIP	25	-/25	BULK	
48497	1-1/2" SPIG x 1-1/4" SLIP	25	-/25	BULK	
48498	2" SPIG x 1/2" SLIP	10	-/10	BULK	
48503	2" SPIG x 1" SLIP	10	-/10	BULK	
48504	2" SPIG x 1-1/4" SLIP	10	-/10	BULK	
48505	2" SPIG x 1-1/2" SLIP	10	-/10	BULK	

### FEMALE REDUCER BUSHING - PVC PRESSURE 40

- Schedule 40
- Spigot x FIP



PART #	DESCRIPTION	UNIT ORDER	INN/MAS	PACK	LIST
48508	3/4" SPIG x 1/2" FIP	100	-/100	BULK	<b>CALL FOR CURRENT PRICE</b>
48509	1" SPIG x 1/2" FIP	100	-/100	BULK	
48510	1" SPIG x 3/4" FIP	100	-/100	BULK	
48511	1-1/4" SPIG x 1/2" FIP	25	-/25	BULK	
48512	1-1/4" SPIG x 3/4" FIP	25	-/25	BULK	
48513	1-1/4" SPIG x 1" FIP	25	-/25	BULK	
48514	1-1/2" SPIG x 1/2" FIP	25	-/25	BULK	
48515	1-1/2" SPIG x 3/4" FIP	25	-/25	BULK	
48516	1-1/2" SPIG x 1" FIP	25	-/25	BULK	
48518	2" SPIG x 1/2" FIP	10	-/10	BULK	
48519	2" SPIG x 3/4" FIP	10	-/10	BULK	
48521	2" SPIG x 1-1/4" FIP	10	-/10	BULK	
48522	2" SPIG x 1-1/2" FIP	10	-/10	BULK	

### CAP - PVC PRESSURE 40

- Schedule 40
- Slip



PART #	DESCRIPTION	UNIT ORDER	INN/MAS	PACK	LIST
48523	1/2"	100	-/100	BULK	<b>CALL FOR CURRENT PRICE</b>
48524	3/4"	100	-/100	BULK	
48525	1"	50	-/50	BULK	
48526	1-1/4"	25	-/25	BULK	

### CAP - PVC PRESSURE 40

- Schedule 40
- FIP



PART #	DESCRIPTION	UNIT ORDER	INN/MAS	PACK	LIST
48529	1/2"	100	-/100	BULK	<b>CALL FOR CURRENT PRICE</b>
48530	3/4"	100	-/100	BULK	
48534	2"	10	-/10	BULK	

### CONDENSATE P-TRAP - PVC PRESSURE 40

- Schedule 40
- Spigot x spigot



PART #	DESCRIPTION	UNIT ORDER	INN/MAS	PACK	LIST
45218	3/4"	1	-/1	BULK	<b>3.28</b>

### CONDENSATE RUNNING TRAP - PVC PRESSURE 40

- Schedule 40
- Spigot x spigot



PART #	DESCRIPTION	UNIT ORDER	INN/MAS	PACK	LIST
45219	3/4"	1	-/1	BULK	<b>2.17</b>

## PVC Schedule 80 Pressure Fittings

### UNION - PVC PRESSURE 80

- Schedule 80
- Slip x slip



PART #	DESCRIPTION	UNIT ORDER	INN/MAS	PACK	LIST
88731	1/2" SLIP	12	12/96	BULK	<b>CALL FOR CURRENT PRICE</b>
88733	3/4" SLIP	12	12/72	BULK	
88735	1" SLIP	12	12/60	BULK	
88737	1-1/4" SLIP	12	12/48	BULK	
88739	1-1/2" SLIP	12	12/36	BULK	
88741	2" SLIP	12	12/24	BULK	

# PIPE FITTINGS AND REPAIR

## Copper Pressure Fittings

### COPPER TUBE SIZES

Nominal Sizes In Inches ID (Inner Diameter) Size	Actual OD (Outer Diameter) Size In Inches
1/8" ID	1/4" OD
1/4" ID	3/8" OD
3/8" ID	1/2" OD
1/2" ID	5/8" OD
5/8" ID	3/4" OD
3/4" ID	7/8" OD
1" ID	1-1/8" OD
1-1/4" ID	1-3/8" OD
1-1/2" ID	1-5/8" OD
2" ID	2-1/8" OD

### COUPLING - COPPER

• C x C

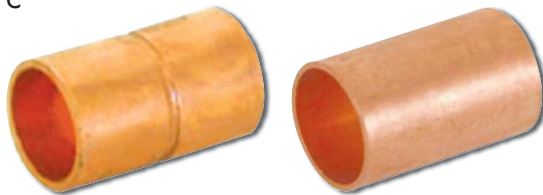

85800

85817



#### WITH ROLLED STOP

PART #	DESCRIPTION	UNIT ORDER	INN/MAS	PACK	LIST
85800	1/4" ID	100	100/2000	BULK	<b>CALL FOR CURRENT PRICE</b>
85802	3/8" ID	100	100/2000	BULK	
85803	1/2" ID x 1/4" ID	50	50/2000	BULK	
85804	1/2" ID x 3/8" ID	100	100/1000	BULK	
85805	1/2" ID	100	100/2000	BULK	
85806	5/8" ID x 1/2" ID	50	50/500	BULK	
85807	5/8" ID	100	100/1000	BULK	
85801	3/4" ID x 1/4" ID	50	50/1000	BULK	
85808	3/4" ID x 1/2" ID	25	25/500	BULK	
85809	3/4" ID x 5/8" ID	50	50/500	BULK	
85810	3/4" ID	50	50/500	BULK	
85909	1" ID x 1/2" ID	25	25/250	BULK	
85908	1" ID x 5/8" ID	25	25/250	BULK	
85811	1" ID x 3/4" ID	25	25/250	BULK	
85812	1" ID x 1" ID	25	25/250	BULK	
85964	1-1/4" ID x 1/2" ID	25	25/250	BULK	
85910	1-1/4" ID x 3/4" ID	25	25/250	BULK	
85814	1-1/4" ID x 1" ID	25	25/250	BULK	
85813	1-1/4" ID	25	25/250	BULK	
85968	1-1/2" ID x 1/2" ID	10	10/200	BULK	
85967	1-1/2" ID x 3/4" ID	10	10/200	BULK	
85966	1-1/2" ID x 1" ID	10	10/200	BULK	
85965	1-1/2" ID x 1-1/4" ID	10	10/200	BULK	
85815	1-1/2" ID	10	10/100	BULK	
85971	2" ID x 1" ID	10	10/100	BULK	
85970	2" ID x 1-1/4" ID	5	5/100	BULK	
85969	2" ID x 1-1/2" ID	5	5/100	BULK	
85816	2" ID	5	5/100	BULK	

#### LESS STOP

PART #	DESCRIPTION	UNIT ORDER	INN/MAS	PACK	LIST
85817	1/2" ID	100	100/1000	BULK	<b>CALL FOR CURRENT PRICE</b>
85818	3/4" ID	50	50/500	BULK	
85819	1" ID	25	25/250	BULK	

### DRAIN COUPLING - CAST COPPER

• C x C



PART #	DESCRIPTION	UNIT ORDER	INN/MAS	PACK	LIST
85821LF	3/4" ID	25	-/25	BULK	<b>CALL FOR CURRENT PRICE</b>

### FITTING REDUCER - COPPER

• FTG x C



PART #	DESCRIPTION	UNIT ORDER	INN/MAS	PACK	LIST
85892	1/2" ID x 1/4" ID	50	50/1000	BULK	<b>CALL FOR CURRENT PRICE</b>
85893	1/2" ID x 3/8" ID	50	50/1000	BULK	
85894	5/8" ID x 1/2" ID	50	50/1000	BULK	
85895	3/4" ID x 1/2" ID	25	25/500	BULK	
85896	3/4" ID x 5/8" ID	25	25/500	BULK	
85897	1" ID x 1/2" ID	25	25/500	BULK	
85898	1" ID x 3/4" ID	25	25/250	BULK	
85899	1-1/4" ID x 3/4" ID	25	25/250	BULK	
85900	1-1/4" ID x 1" ID	25	25/250	BULK	
85901	1-1/2" ID x 3/4" ID	10	10/200	BULK	
85902	1-1/2" ID x 1" ID	10	10/200	BULK	
85903	1-1/2" ID x 1-1/4" ID	10	10/200	BULK	
85904	2" ID x 3/4" ID	10	10/100	BULK	
85905	2" ID x 1" ID	10	10/100	BULK	
85906	2" ID x 1-1/4" ID	5	5/100	BULK	
85907	2" ID x 1-1/2" ID	5	5/100	BULK	

### 90° ELBOW - COPPER

• C x C



PART #	DESCRIPTION	UNIT ORDER	INN/MAS	PACK	LIST
85822	1/4" ID	50	50/2000	BULK	<b>CALL FOR CURRENT PRICE</b>
85823	3/8" ID	50	50/1000	BULK	
85824	1/2" ID	50	50/500	BULK	
85825	3/4" ID x 1/2" ID	50	50/400	BULK	
85826	3/4" ID	25	25/250	BULK	
85828	1" ID	10	10/100	BULK	
85829	1-1/4" ID	25	-/25	BULK	
85830	1-1/2" ID	20	-/20	BULK	
85831	2" ID	15	-/15	BULK	

## Copper Pressure Fittings

### LONG RADIUS 90° ELBOW - COPPER

• C x C



PART #	DESCRIPTION	UNIT ORDER	INN/MAS	PACK	LIST
85952	1/4" ID	1	50/500	BULK	<b>CALL FOR CURRENT PRICE</b>
85953	3/8" ID	1	50/1000	BULK	
85954	1/2" ID	1	50/500	BULK	
85955	5/8" ID	1	50/400	BULK	
85956	3/4" ID	1	50/250	BULK	
85957	1" ID	1	50/100	BULK	

### 90° STREET ELBOW - COPPER

• FTG x C



PART #	DESCRIPTION	UNIT ORDER	INN/MAS	PACK	LIST
85832	3/8" ID	50	50/500	BULK	<b>CALL FOR CURRENT PRICE</b>
85833	1/2" ID	2	2/20	BULK	
85834	3/4" ID	25	25/250	BULK	
85835	1" ID	10	10/100	BULK	
85836	1-1/4" ID	10	10/100	BULK	
85837	1-1/2" ID	5	5/50	BULK	
85838	2" ID	5	5/50	BULK	

### LONG RADIUS 90° STREET ELBOW - COPPER

• FTG x C



PART #	DESCRIPTION	UNIT ORDER	INN/MAS	PACK	LIST
85958	1/4" ID	1	50/500	BULK	<b>CALL FOR CURRENT PRICE</b>
85959	3/8" ID	1	50/500	BULK	
85960	1/2" ID	1	50/500	BULK	
85961	5/8" ID	1	50/250	BULK	
85962	3/4" ID	1	50/250	BULK	
85963	1" ID	1	50/100	BULK	

### 90° FEMALE ELBOW - CAST COPPER

• C x FIP



PART #	DESCRIPTION	UNIT ORDER	INN/MAS	PACK	LIST
85842LF	1/2" ID	50	-/50	BULK	<b>CALL FOR CURRENT PRICE</b>

### 90° DROP EAR ELBOW - CAST COPPER

• C x C



PART #	DESCRIPTION	UNIT ORDER	INN/MAS	PACK	LIST
85879LF	1/2" ID	50	-/50	BULK	<b>CALL FOR CURRENT PRICE</b>

### 45° ELBOW - COPPER

• C x C



PART #	DESCRIPTION	UNIT ORDER	INN/MAS	PACK	LIST
85845	1/4" ID	50	50/500	BULK	<b>CALL FOR CURRENT PRICE</b>
85846	3/8" ID	50	50/500	BULK	
85847	1/2" ID	50	50/500	BULK	
85848	5/8" ID	50	50/500	BULK	
85849	3/4" ID	25	25/250	BULK	
85850	1" ID	10	10/200	BULK	
85851	1-1/4" ID	10	10/200	BULK	
85852	1-1/2" ID	10	10/100	BULK	
85853	2" ID	5	5/50	BULK	

### 45° STREET ELBOW - COPPER

• FTG x C



PART #	DESCRIPTION	UNIT ORDER	INN/MAS	PACK	LIST
85884	1/2" ID	2	2/20	BULK	<b>CALL FOR CURRENT PRICE</b>
85885	3/4" ID	25	25/250	BULK	
85886	1" ID	10	10/100	BULK	
85887	1-1/4" ID	10	10/100	BULK	

Supply Connectors

Stop Valves

Water Heater

Gas Connectors

Water Filtration

Sinks/ Faucets

Tubular/ Drainage

Faucet Repair

Bath Accessories

Pipe Fittings/ Repair

Valves

Cements/ Sealants

Tools/ Safety

Toilet Repair

Appliance/ HVAC

Hardware

Electrical

Index

# PIPE FITTINGS AND REPAIR

## Copper Pressure Fittings

### TEE - COPPER

• C x C x C

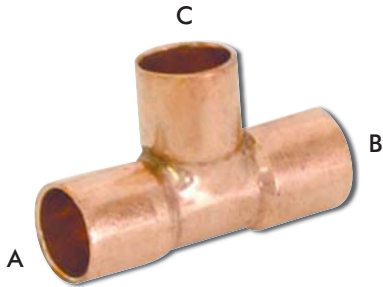

PART #	A x B x C	UNIT ORDER	INN/MAS	PACK	LIST
85854	1/4" ID	50	50/1000	BULK	<b>CALL FOR CURRENT PRICE</b>
85855	3/8" ID	50	50/500	BULK	
85974	1/2" ID x 1/2" ID x 1/4" ID	50	50/500	BULK	
85973	1/2" ID x 1/2" ID x 3/8" ID	50	50/500	BULK	
85856	1/2" ID	50	50/500	BULK	
85857	1/2" ID x 1/2" ID x 3/4"	25	25/250	BULK	
85972	1/2" ID x 1/2" ID x 1" ID	10	10/100	BULK	
85858	3/4" ID x 1/2" ID x 1/2" ID	25	25/250	BULK	
85946	3/4" ID x 1/2" ID x 3/4" ID	25	25/250	BULK	
85859	3/4" ID x 3/4" ID x 1/2" ID	25	25/250	BULK	
85860	3/4" ID	25	25/250	BULK	
85975	3/4" ID x 3/4" ID x 1" ID	10	10/100	BULK	
85980	1" ID x 1/2" ID x 1/2" ID	10	10/200	BULK	
85979	1" ID x 1/2" ID x 3/4" ID	10	10/100	BULK	
85863	1" ID x 1/2" ID x 1" ID	10	10/100	BULK	
85978	1" ID x 3/4" ID x 1/2" ID	10	10/100	BULK	
85864	1" ID x 3/4" ID x 3/4" ID	10	10/100	BULK	
85865	1" ID x 3/4" ID x 1" ID	10	10/100	BULK	
85862	1" ID x 1" ID x 1/2" ID	10	10/100	BULK	
85866	1" ID x 1" ID x 3/4" ID	10	10/100	BULK	
85867	1" ID	10	10/100	BULK	
85977	1" ID x 1" ID x 1-1/4" ID	5	5/50	BULK	
85976	1" ID x 1" ID x 1-1/2" ID	5	5/50	BULK	
85991	1-1/4" ID x 1/2" ID x 1-1/4" ID	5	5/50	BULK	
85990	1-1/4" ID x 3/4" ID x 1/2" ID	5	5/50	BULK	
85989	1-1/4" ID x 3/4" ID x 3/4" ID	5	5/50	BULK	
85988	1-1/4" ID x 3/4" ID x 1" ID	5	5/50	BULK	
85987	1-1/4" ID x 3/4" ID x 1-1/4" ID	5	5/50	BULK	
85986	1-1/4" ID x 1" ID x 1/2" ID	5	5/50	BULK	
85985	1-1/4" ID x 1" ID x 3/4" ID	5	5/50	BULK	
85868	1-1/4" ID x 1" ID x 1" ID	5	5/50	BULK	
85984	1-1/4" ID x 1" ID x 1-1/4" ID	5	5/50	BULK	
85983	1-1/4" ID x 1-1/4" ID x 1/2" ID	5	5/50	BULK	
85869	1-1/4" ID x 1-1/4" ID x 3/4" ID	5	5/50	BULK	
85870	1-1/4" ID x 1-1/4" ID x 1" ID	5	5/50	BULK	
85871	1-1/4" ID	5	5/50	BULK	
85982	1-1/4" ID x 1-1/4" ID x 1-1/2" ID	5	5/50	BULK	
85981	1-1/4" ID x 1-1/4" ID x 2" ID	2	2/20	BULK	
86068	1-1/2" ID x 1/2" ID x 1-1/2" ID	5	5/50	BULK	
86042	1-1/2" ID x 3/4" ID x 1/2" ID	5	5/50	BULK	
86024	1-1/2" ID x 3/4" ID x 3/4" ID	5	5/50	BULK	
86023	1-1/2" ID x 3/4" ID x 1" ID	5	5/50	BULK	
86022	1-1/2" ID x 3/4" ID x 1-1/4" ID	5	5/50	BULK	
86021	1-1/2" ID x 3/4" ID x 1-1/2" ID	5	5/50	BULK	
86016	1-1/2" ID x 1" ID x 1/2" ID	5	5/50	BULK	
86015	1-1/2" ID x 1" ID x 3/4" ID	5	5/50	BULK	
85749	1-1/2" ID x 1" ID x 1" ID	5	5/50	BULK	
85748	1-1/2" ID x 1" ID x 1-1/4" ID	5	5/50	BULK	
85747	1-1/2" ID x 1" ID x 1-1/2" ID	5	5/50	BULK	

### TEE - COPPER

• C x C x C

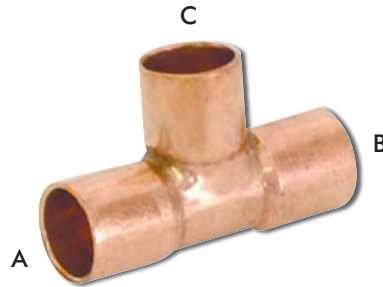

PART #	A x B x C	UNIT ORDER	INN/MAS	PACK	LIST
85746	1-1/2" ID x 1-1/4" ID x 1/2" ID	5	5/50	BULK	<b>CALL FOR CURRENT PRICE</b>
85999	1-1/2" ID x 1-1/4" ID x 3/4" ID	5	5/50	BULK	
85998	1-1/2" ID x 1-1/4" ID x 1" ID	5	5/50	BULK	
85997	1-1/2" ID x 1-1/4" ID x 1-1/4" ID	5	5/50	BULK	
85996	1-1/2" ID x 1-1/4" ID x 1-1/2" ID	5	5/50	BULK	
85995	1-1/2" ID x 1-1/2" ID x 1/2" ID	5	5/50	BULK	
85994	1-1/2" ID x 1-1/2" ID x 3/4" ID	5	5/50	BULK	
85993	1-1/2" ID x 1-1/2" ID x 1" ID	5	5/50	BULK	
85873	1-1/2" ID x 1-1/2" ID x 1-1/4" ID	5	5/50	BULK	
85872	1-1/2" ID	5	5/50	BULK	
85992	1-1/2" ID x 1-1/2" ID x 2" ID	2	2/20	BULK	
86082	2" ID x 1" ID x 1" ID	5	5/50	BULK	
86081	2" ID x 1" ID x 2" ID	5	5/25	BULK	
86080	2" ID x 1-1/4" ID x 1" ID	2	2/20	BULK	
86079	2" ID x 1-1/4" ID x 1-1/4" ID	2	2/20	BULK	
86078	2" ID x 1-1/4" ID x 1-1/2" ID	2	2/20	BULK	
86077	2" ID x 1-1/4" ID x 2" ID	2	2/20	BULK	
86074	2" ID x 1-1/2" ID x 1" ID	2	2/20	BULK	
86073	2" ID x 1-1/2" ID x 1-1/4" ID	2	2/20	BULK	
86072	2" ID x 1-1/2" ID x 1-1/2" ID	2	2/20	BULK	
86071	2" ID x 1-1/2" ID x 2" ID	2	2/20	BULK	
86070	2" ID x 2" ID x 1" ID	5	5/50	BULK	
86069	2" ID x 2" ID x 1-1/4" ID	5	5/50	BULK	
85875	2" ID x 2" ID x 1-1/2" ID	5	5/50	BULK	
85874	2" ID	5	5/25	BULK	

### FEMALE TEE - CAST COPPER

• C x C x FIP

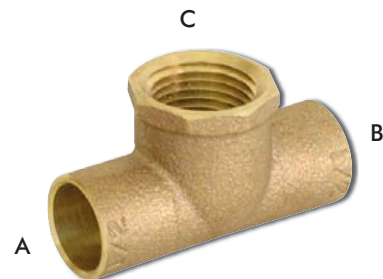

PART #	A x B x C	UNIT ORDER	INN/MAS	PACK	LIST
85876LF	1/2" ID x 1/2" ID x 1/2" ID	25	-/25	BULK	<b>CALL FOR CURRENT PRICE</b>
85877LF	3/4" ID x 3/4" ID x 1/2" ID	25	-/25	BULK	
85878LF	3/4" ID x 3/4" ID x 3/4" ID	10	-/10	BULK	

## Copper Pressure Fittings

### MALE ADAPTER - COPPER

• C x MIP



PART #	DESCRIPTION	UNIT ORDER	INN/MAS	PACK	LIST
85912	3/8" ID x 1/2" ID	50	50/500	BULK	<b>CALL FOR CURRENT PRICE</b>
85913	1/2" ID x 3/8" ID	50	50/1000	BULK	
85914	1/2" ID x 1/2" ID	50	50/500	BULK	
85915	1/2" ID x 3/4" ID	25	25/250	BULK	
85916	5/8" ID x 3/4" ID	25	25/250	BULK	
85917	3/4" ID x 1/2" ID	50	50/500	BULK	
85918	3/4" ID x 3/4" ID	25	25/250	BULK	
85919	3/4" ID x 1" ID	20	20/200	BULK	
85920	1" ID x 3/4" ID	25	25/250	BULK	
85921	1" ID x 1" ID	10	10/100	BULK	
85922	1-1/4" ID x 1-1/4" ID	10	10/100	BULK	
85923	1-1/2" ID x 1-1/2" ID	10	10/100	BULK	
85924	2" ID x 2" ID	5	5/50	BULK	

### FEMALE ADAPTER - COPPER

• C x FIP



PART #	DESCRIPTION	UNIT ORDER	INN/MAS	PACK	LIST
85926	1/2" ID x 1/4" ID	50	50/500	BULK	<b>CALL FOR CURRENT PRICE</b>
85925	1/2" ID x 3/8" ID	50	50/500	BULK	
85927	1/2" ID x 1/2" ID	50	50/500	BULK	
85928	1/2" ID x 3/4" ID	25	25/250	BULK	
85929	3/4" ID x 1/2" ID	50	50/500	BULK	
85930	3/4" ID x 3/4" ID	25	25/250	BULK	
85931	1" ID x 3/4" ID	25	25/250	BULK	
85932	1" ID x 1" ID	10	10/100	BULK	
85933	1-1/4" ID x 1-1/4" ID	10	10/100	BULK	
85934	1-1/2" ID x 1-1/2" ID	10	10/100	BULK	
85935	2" ID x 2" ID	5	5/50	BULK	

### UNION - COPPER

• C x C



PART #	DESCRIPTION	UNIT ORDER	INN/MAS	PACK	LIST
85936	1/2" ID	25	25/250	BULK	<b>CALL FOR CURRENT PRICE</b>
85937	3/4" ID	10	10/100	BULK	
85938	1" ID	10	10/100	BULK	

### FLUSH BUSHING - COPPER

• FTG x C



PART #	DESCRIPTION	UNIT ORDER	INN/MAS	PACK	LIST
85888	1/2" ID x 1/4" ID	50	-/50	BULK	<b>CALL FOR CURRENT PRICE</b>
85889	1/2" ID x 3/8" ID	50	-/50	BULK	
85890	3/4" ID x 1/2" ID	50	-/50	BULK	
85891	1" ID x 3/4" ID	25	-/25	BULK	

### CAP - COPPER

• C



PART #	DESCRIPTION	UNIT ORDER	INN/MAS	PACK	LIST
85939	3/8" ID	50	50/1000	BULK	<b>CALL FOR CURRENT PRICE</b>
85940	1/2" ID	100	100/1000	BULK	
85941	3/4" ID	50	50/50	BULK	
85942	1" ID	10	10/10	BULK	
85943	1-1/4" ID	25	25/250	BULK	
85944	1" ID	10	10/100	BULK	
85945	2" ID	10	10/100	BULK	

### TYPE R SOFT COPPER TUBING

• 50' Coil



PART #	DESCRIPTION	UNIT ORDER	INN/MAS	PACK	LIST
80169	1/4" OD	1	-/1	ROLL	<b>CALL FOR CURRENT PRICE</b>
80170	3/8" OD	1	-/1	ROLL	
80171	1/2" OD	1	-/1	ROLL	
80172	5/8" OD	1	-/1	ROLL	
80173	3/4" OD	1	-/1	ROLL	
80174	7/8" OD	1	-/1	ROLL	

## Copper Press Fittings

### COUPLING

- Operating pressure: 200 PSI CWP
- Temperature range: -20° F to 250° F
- Dezincification-resistant



PART #	DESCRIPTION	UNIT ORDER	INN/MAS	PACK	LIST
80176	1/2" Press x 1/2" Press	1	10/550	BAG	<b>3.85</b>
80178	3/4" Press x 1/2" Press	1	10/300	BAG	<b>17.42</b>
80177	3/4" Press x 3/4" Press	1	10/260	BAG	<b>5.84</b>
80181	1" Press x 1/2" Press	1	10/200	BAG	<b>30.39</b>
80180	1" Press x 3/4" Press	1	10/200	BAG	<b>19.96</b>
80179	1" Press x 1" Press	1	5/170	BAG	<b>11.75</b>

Supply Connectors

Stop Valves

Water Heater

Gas Connectors

Water Filtration

Sinks/ Faucets

Tubular/ Drainage

Faucet Repair

Bath Accessories

Pipe Fittings/ Repair

Valves

Cements/ Sealants

Tools/ Safety

Toilet Repair

Appliance/ HVAC

Hardware

Electrical

Index

# PIPE FITTINGS AND REPAIR

## Copper Press Fittings

### REPAIR COUPLING

- Operating pressure: 200 PSI CWP
- Temperature range: -20° F to 250° F
- Dezincification-resistant



PART #	DESCRIPTION	UNIT ORDER	INN/MAS	PACK	LIST
80185	1/2" Press x 1/2" Press	1	10/450	BAG	9.24
80186	3/4" Press x 3/4" Press	1	10/260	BAG	12.63
80187	1" Press x 1" Press	1	5/170	BAG	15.43

### FITTING REDUCER

- Operating pressure: 200 PSI CWP
- Temperature range: -20° F to 250° F
- Dezincification-resistant



PART #	DESCRIPTION	UNIT ORDER	INN/MAS	PACK	LIST
80182	3/4" FTG x 1/2" Press	1	10/400	BAG	4.28
80184	1" FTG x 1/2" Press	1	10/300	BAG	10.95
80183	1" FTG x 3/4" Press	1	10/240	BAG	11.32

### 90° ELBOW

- Operating pressure: 200 PSI CWP
- Temperature range: -20° F to 250° F
- Dezincification-resistant



PART #	DESCRIPTION	UNIT ORDER	INN/MAS	PACK	LIST
80202	1/2" Press x 1/2" Press	1	10/350	BAG	4.28
80203	3/4" Press x 3/4" Press	1	10/180	BAG	7.19
80204	1" Press x 1" Press	1	5/100	BAG	14.43

### 90° STREET ELBOW

- Operating pressure: 200 PSI CWP
- Temperature range: -20° F to 250° F
- Dezincification-resistant



PART #	DESCRIPTION	UNIT ORDER	INN/MAS	PACK	LIST
80248	1/2" FTG x 1/2" Press	1	10/400	BAG	4.28
80249	3/4" FTG x 3/4" Press	1	10/200	BAG	7.19
80250	1" FTG x 1" Press	1	5/100	BAG	16.57

### 45° ELBOW

- Operating pressure: 200 PSI CWP
- Temperature range: -20° F to 250° F
- Dezincification-resistant



PART #	DESCRIPTION	UNIT ORDER	INN/MAS	PACK	LIST
80199	1/2" Press x 1/2" Press	1	10/400	BAG	4.96
80200	3/4" Press x 3/4" Press	1	10/200	BAG	6.10
80201	1" Press x 1" Press	1	5/140	BAG	19.53

### 45° STREET ELBOW

- Operating pressure: 200 PSI CWP
- Temperature range: -20° F to 250° F
- Dezincification-resistant



PART #	DESCRIPTION	UNIT ORDER	INN/MAS	PACK	LIST
80245	1/2" FTG x 1/2" Press	1	10/450	BAG	3.85
80246	3/4" FTG x 3/4" Press	1	10/260	BAG	5.70
80247	1" FTG x 1" Press	1	5/140	BAG	18.68

### TEE

- Operating pressure: 200 PSI CWP
- Temperature range: -20° F to 250° F
- Dezincification-resistant



PART #	DESCRIPTION	UNIT ORDER	INN/MAS	PACK	LIST
80205	1/2" x 1/2" x 1/2" Press	1	10/200	BAG	6.53
80206	1/2" x 1/2" x 3/4" Press	1	10/140	BAG	21.78
80211	3/4" x 1/2" x 1/2" Press	1	10/150	BAG	17.68
80210	3/4" x 1/2" x 3/4" Press	1	5/120	BAG	18.39
80209	3/4" x 3/4" x 1/2" Press	1	10/140	BAG	9.67
80207	3/4" x 3/4" x 3/4" Press	1	10/120	BAG	11.46
80208	3/4" x 3/4" x 1" Press	1	5/60	BAG	34.64
80217	1" x 1/2" x 1" Press	1	5/80	BAG	33.22
80216	1" x 3/4" x 3/4" Press	1	5/100	BAG	31.39
80215	1" x 3/4" x 1" Press	1	5/70	BAG	35.47
80214	1" x 1" x 1/2" Press	1	5/100	BAG	23.64
80213	1" x 1" x 3/4" Press	1	5/80	BAG	23.49
80212	1" x 1" x 1" Press	1	5/70	BAG	20.64

## Copper Press Fittings

### MALE ADAPTER

- Operating pressure: 200 PSI CWP
- Temperature range: -20° F to 250° F
- Dezincification-resistant



PART #	DESCRIPTION	UNIT ORDER	INN/MAS	PACK	LIST
80194	1/2" Press x 1/2" MPT	1	10/300	BAG	5.02
80195	1/2" Press x 3/4" MPT	1	10/180	BAG	9.84
80197	3/4" Press x 1/2" MPT	1	10/180	BAG	10.29
80196	3/4" Press x 3/4" MPT	1	5/160	BAG	9.10
80198	1" Press x 1" MPT	1	10/160	BAG	16.62

### FEMALE ADAPTER

- Operating pressure: 200 PSI CWP
- Temperature range: -20° F to 250° F
- Dezincification-resistant



PART #	DESCRIPTION	UNIT ORDER	INN/MAS	PACK	LIST
80188	1/2" Press x 1/2" FPT	1	10/300	BAG	6.07
80189	1/2" Press x 3/4" FPT	1	10/180	BAG	12.43
80191	3/4" Press 1/2" FPT	1	10/180	BAG	9.10
80190	3/4" Press x 3/4" FPT	1	10/150	BAG	9.84
80193	1" Press x 3/4" FPT	1	10/200	BAG	32.02
80192	1" Press x 1" FPT	1	10/180	BAG	18.13

### UNION

- Operating pressure: 200 PSI CWP
- Temperature range: -20° F to 250° F
- Dezincification-resistant



PART #	DESCRIPTION	UNIT ORDER	INN/MAS	PACK	LIST
80233	1/2" Press x 1/2" Press	1	1/144	BAG	32.02
80234	3/4" Press x 3/4" Press	1	1/60	BAG	41.94
80235	1" Press x 1" Press	1	1/32	BAG	67.03

### MALE UNION

- Operating pressure: 200 PSI CWP
- Temperature range: -20° F to 250° F
- Dezincification-resistant



PART #	DESCRIPTION	UNIT ORDER	INN/MAS	PACK	LIST
80239	1/2" Press x 1/2" MPT	1	1/144	BAG	27.94
80240	3/4" Press x 3/4" MPT	1	1/60	BAG	38.66
80241	1" Press x 1" MPT	1	1/32	BAG	55.57

### FEMALE UNION

- Operating pressure: 200 PSI CWP
- Temperature range: -20° F to 250° F
- Dezincification-resistant



PART #	DESCRIPTION	UNIT ORDER	INN/MAS	PACK	LIST
80236	1/2" Press x 1/2" FPT	1	1/192	BAG	25.20
80237	3/4" Press x 3/4" FPT	1	1/90	BAG	32.93
80238	1" Press x 1" FPT	1	1/90	BAG	53.57

### CAP

- Operating pressure: 200 PSI CWP
- Temperature range: -20° F to 250° F
- Dezincification-resistant



PART #	DESCRIPTION	UNIT ORDER	INN/MAS	PACK	LIST
80218	1/2" Press	1	10/450	BAG	8.24
80231	3/4" Press	1	10/450	BAG	13.83
80232	1" Press	1	5/250	BAG	21.36

### FULL-PORT BALL VALVE

- Two-piece body with full port and bronze trim
- Blowout-proof stem
- 250 PSI / 17.2 Bar non-shock CWP
- 250° F Max operating temperature



PART #	DESCRIPTION	UNIT ORDER	INN/MAS	PACK	LIST
80242	1/2" Press x 1/2" Press	1	10/50	BAG	23.64
80243	3/4" Press x 3/4" Press	1	10/30	BAG	32.85
80244	1" Press x 1" Press	1	5/20	BAG	55.57

Supply Connectors

Stop Valves

Water Heater

Gas Connectors

Water Filtration

Sinks/Faucets

Tubular/Drainage

Faucet Repair

Bath Accessories

Pipe Fittings/Repair

Valves

Cements/Sealants

Tools/Safety

Toilet Repair

Appliance/HVAC

Hardware

Electrical

Index



## EASTMAN®

### PUSH-FIT FITTINGS

- A connection system for copper, CPVC or PEX pipe
- Use underground and behind walls without access panels
- No soldering required
- Compact and corrosion-resistant
- DZR and lead-free brass material
- NSF-14 Listed



#### Brass Push-Fit Fittings

##### PUSH-FIT FITTING - COUPLING

- A connection system for copper, CPVC, or PEX pipe
- Use underground and behind walls without access panels
- No soldering required
- Compact and corrosion-resistant



PART #	DESCRIPTION	UNIT ORDER	INN/MAS	PACK	LIST
75011LF	1/2" x 1/2"	6	6/60	BAG	8.47
75013LF	3/4" x 1/2"	6	6/60	BAG	10.66
75012LF	3/4" x 3/4"	6	6/60	BAG	10.66
75179LF	1" x 3/4"	3	3/30	BAG	18.68
75178LF	1" x 1"	3	3/30	BAG	19.36

##### PUSH-FIT FITTING - MALE ELBOW

- A connection system for copper, CPVC, or PEX pipe
- Use underground and behind walls without access panels
- No soldering required
- Compact and corrosion-resistant



PART #	DESCRIPTION	UNIT ORDER	INN/MAS	PACK	LIST
75186LF	1/2" x 1/2" MIP	6	6/60	BAG	9.27

##### PUSH-FIT FITTING - REPAIR COUPLING

- Push-fit connections on both ends
- Use for copper and CPVC only



PART #	DESCRIPTION	UNIT ORDER	INN/MAS	PACK	LIST
75194LF	1/2" x 1/2"	6	6/60	BAG	16.59
75195LF	3/4" x 3/4"	6	6/30	BAG	21.84

##### PUSH-FIT FITTING - FEMALE ELBOW

- A connection system for copper, CPVC, or PEX pipe
- Use underground and behind walls without access panels
- No soldering required
- Compact and corrosion-resistant



PART #	DESCRIPTION	UNIT ORDER	INN/MAS	PACK	LIST
75187LF	1/2" x 1/2" FIP	6	6/60	BAG	9.49

##### PUSH-FIT FITTING - ELBOW

- A connection system for copper, CPVC, or PEX pipe
- Use underground and behind walls without access panels
- No soldering required
- Compact and corrosion-resistant



PART #	DESCRIPTION	UNIT ORDER	INN/MAS	PACK	LIST
75018LF	1/2" x 1/2"	6	6/60	BAG	9.64
75020LF	3/4" x 1/2"	6	6/60	BAG	14.68
75019LF	3/4" x 3/4"	6	6/60	BAG	15.82
75185LF	1" x 1"	3	3/30	BAG	24.63

##### PUSH-FIT FITTING - DROP EAR ELBOW

- A connection system for copper, CPVC, or PEX pipe
- Use underground and behind walls without access panels
- No soldering required
- Compact and corrosion-resistant



PART #	DESCRIPTION	UNIT ORDER	INN/MAS	PACK	LIST
75021LF	1/2" x 1/2" FIP	6	6/60	BAG	11.38



## Brass Push-Fit Fittings

### PUSH-FIT FITTING - TEE

- A connection system for copper, CPVC, or PEX pipe
- Use underground and behind walls without access panels
- No soldering required
- Compact and corrosion-resistant

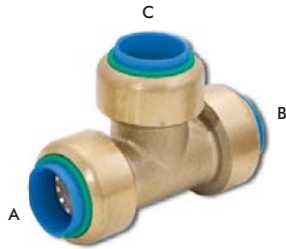

COMPLIES WITH NSF-61 **EASTMAN**

PART #	A x B x C	UNIT ORDER	INN/MAS	PACK	LIST
75023LF	1/2" x 1/2" x 1/2"	6	6/60	BAG	13.63
75027LF	3/4" x 1/2" x 1/2"	6	6/60	BAG	16.17
75026LF	3/4" x 1/2" x 3/4"	6	6/60	BAG	17.82
75025LF	3/4" x 3/4" x 1/2"	6	6/60	BAG	16.22
75024LF	3/4" x 3/4" x 3/4"	6	6/60	BAG	18.50
75188LF	1" x 1" x 1"	3	3/24	BAG	31.33

### PUSH-FIT FITTING - MALE ADAPTER

- A connection system for copper, CPVC, or PEX pipe
- Use underground and behind walls without access panels
- No soldering required
- Compact and corrosion-resistant



COMPLIES WITH NSF-61 **EASTMAN**

PART #	DESCRIPTION	UNIT ORDER	INN/MAS	PACK	LIST
75016LF	1/2" x 1/2" MIP	6	6/60	BAG	7.04
75182LF	1/2" x 3/4" MIP	6	6/60	BAG	9.95
75017LF	3/4" x 3/4" MIP	6	6/60	BAG	10.66
75183LF	1" x 1" MIP	3	3/30	BAG	14.88

### PUSH-FIT FITTING - FEMALE ADAPTER

- A connection system for copper, CPVC, or PEX pipe
- Use underground and behind walls without access panels
- No soldering required
- Compact and corrosion-resistant



COMPLIES WITH NSF-61 **EASTMAN**

PART #	DESCRIPTION	UNIT ORDER	INN/MAS	PACK	LIST
75014LF	1/2" x 1/2" FIP	6	6/60	BAG	8.04
75180LF	1/2" x 3/4" FIP	6	6/60	BAG	9.47
75015LF	3/4" x 3/4" FIP	6	6/60	BAG	11.01
75181LF	1" x 1" FIP	3	3/30	BAG	15.48

### PUSH-FIT FITTING - END CAP

- A connection system for copper, CPVC, or PEX pipe
- Use underground and behind walls without access panels
- No soldering required
- Compact and corrosion-resistant



COMPLIES WITH NSF-61 **EASTMAN**

PART #	DESCRIPTION	UNIT ORDER	INN/MAS	PACK	LIST
75028LF	1/2"	6	6/120	BAG	5.33
75029LF	3/4"	6	6/120	BAG	7.30
75189LF	1"	6	6/30	BAG	11.29

### PUSH-FIT FITTING - BALL VALVE

- Push-fit connections on both ends
- Connects copper, PEX and CPVC



COMPLIES WITH NSF-61 **EASTMAN**

PART #	DESCRIPTION	UNIT ORDER	INN/MAS	PACK	LIST
75197LF	1/2" x 1/2"	20	20/100	BAG	17.39
75198LF	3/4" x 3/4"	10	10/60	BAG	25.15
75199LF	1" x 1"	5	5/50	BAG	42.37

### PUSH-FIT FITTING - STOP VALVE TEE ADAPTER

- Screws onto existing stop valve
- Provides push-fit outlet for PEX or copper risers



**EASTMAN**

PART #	DESCRIPTION	UNIT ORDER	INN/MAS	PACK	LIST
75022	3/8" Comp x 1/4" x 1/4"	1	12/48	BAG	11.40

### PUSH-FIT FITTING - INSTALLATION KIT

**NEW**

- Includes one of each in 1/2" and 3/4": coupling, FIP adapter, MIP adapter, elbow, tee, end stop and demount clip
- Carrying case included



COMPLIES WITH NSF-61 **EASTMAN**

PART #	DESCRIPTION	UNIT ORDER	INN/MAS	PACK	LIST
75100	14-Piece Kit	8	-/8	BULK	115.45

Supply Connectors

Stop Valves

Water Heater

Gas Connectors

Water Filtration

Sinks/Faucets

Tubular/Drainage

Faucet Repair

Bath Accessories

Pipe Fittings/Repair

Valves

Cements/Sealants

Tools/Safety

Toilet Repair

Appliance/HVAC

Hardware

Electrical

Index

# PIPE FITTINGS AND REPAIR

## Brass Push-Fit Fittings

### PUSH-FIT FITTING - DEMOUNT CLIP

- Designed to disconnect push-fit fittings



**EASTMAN**

PART #	DESCRIPTION	UNIT ORDER	INN/MAS	PACK	LIST
75030	1/2"	10	10/200	BULK	<b>0.91</b>
75031	3/4"	10	10/200	BULK	<b>1.14</b>
75190	1"	10	10/100	BULK	<b>1.77</b>

### PEX PIPE STIFFENER

- Add to Eastman® push-fit fittings for a secure PEX connection



**EASTMAN**

PART #	DESCRIPTION	UNIT ORDER	INN/MAS	PACK	LIST
75200	1/2"	1	-/100	BAG	<b>0.34</b>
75201	3/4"	1	-/100	BAG	<b>0.57</b>
75202	1"	1	-/100	BAG	<b>0.74</b>

## Plastic Push-Fit Fittings

### COUPLING - PLASTIC

- Lead-free, nontoxic
- Works with copper, CPVC and PEX
- No tools required
- Removable and reusable without damage to plumbing or fittings
- No risk of flame or fire from a blowtorch



**NSF**

PART #	DESCRIPTION	UNIT ORDER	INN/MAS	PACK	LIST
84042	1/4" OD	10	350/700	BULK	<b>2.20</b>
84049	3/8" OD x 1/4" OD	10	150/300	BULK	<b>2.97</b>
84050	3/8" OD	10	150/300	BULK	<b>3.31</b>
84051	1/2" OD	10	100/200	BULK	<b>4.02</b>

### ELBOW - PLASTIC

- Lead-free, nontoxic
- Works with copper, CPVC and PEX
- No tools required
- Removable and reusable without damage to plumbing or fittings
- No risk of flame or fire from a blowtorch



**NSF**

PART #	DESCRIPTION	UNIT ORDER	INN/MAS	PACK	LIST
84055	1/4" OD	10	350/700	BULK	<b>2.20</b>
84056	3/8" OD	10	150/300	BULK	<b>3.65</b>
84057	1/2" OD	10	80/160	BULK	<b>4.53</b>

### MALE ELBOW - PLASTIC

- Lead-free, nontoxic
- Works with copper, CPVC and PEX
- No tools required
- Removable and reusable without damage to plumbing or fittings
- No risk of flame or fire from a blowtorch



**NSF**

PART #	DESCRIPTION	UNIT ORDER	INN/MAS	PACK	LIST
84094	1/4" OD x 1/8" MIP	10	400/800	BULK	<b>1.94</b>
84095	1/4" OD x 1/4" MIP	10	300/600	BULK	<b>2.02</b>
84096	1/4" OD x 3/8" MIP	10	180/360	BULK	<b>2.00</b>
84097	3/8" OD x 1/4" MIP	10	200/400	BULK	<b>2.85</b>
84098	3/8" OD x 3/8" MIP	10	150/300	BULK	<b>4.33</b>
84099	1/2" OD x 3/8" MIP	10	100/200	BULK	<b>3.48</b>
84100	1/2" OD x 1/2" MIP	10	80/160	BULK	<b>3.88</b>

### TEE - PLASTIC

- Lead-free, nontoxic
- Works with copper, CPVC and PEX
- No tools required
- Removable and reusable without damage to plumbing or fittings
- No risk of flame or fire from a blowtorch



**NSF**

PART #	DESCRIPTION	UNIT ORDER	INN/MAS	PACK	LIST
84052	1/4" OD	10	200/400	BULK	<b>3.19</b>
84053	3/8" OD	10	100/200	BULK	<b>4.02</b>
84054	1/2" OD	10	50/100	BULK	<b>4.85</b>

### MALE ADAPTER - PLASTIC

- Lead-free, nontoxic
- Works with copper, CPVC and PEX
- No tools required
- Removable and reusable without damage to plumbing or fittings
- No risk of flame or fire from a blowtorch



**NSF**

PART #	DESCRIPTION	UNIT ORDER	INN/MAS	PACK	LIST
84058	1/4" OD x 1/8" MIP	10	400/800	BULK	<b>1.88</b>
84059	1/4" OD x 1/4" MIP	10	400/800	BULK	<b>1.91</b>
84060	1/4" OD x 3/8" MIP	10	300/600	BULK	<b>1.94</b>
84061	1/4" OD x 1/2" MIP	10	150/300	BULK	<b>2.11</b>
84062	3/8" OD x 1/8" MIP	10	200/400	BULK	<b>2.71</b>
84089	3/8" OD x 1/4" MIP	10	200/400	BULK	<b>2.97</b>
84090	3/8" OD x 3/8" MIP	10	200/400	BULK	<b>3.11</b>
84091	3/8" OD x 1/2" MIP	10	150/300	BULK	<b>3.34</b>
84092	1/2" OD x 3/8" MIP	10	150/300	BULK	<b>3.62</b>
84093	1/2" OD x 1/2" MIP	10	100/200	BULK	<b>3.85</b>

### FEMALE ADAPTER - PLASTIC

- Lead-free, nontoxic
- Works with copper, CPVC and PEX
- No tools required
- Removable and reusable without damage to plumbing or fittings
- No risk of flame or fire from a blowtorch



**NSF**

PART #	DESCRIPTION	UNIT ORDER	INN/MAS	PACK	LIST
84043	1/4" OD x 1/4" Female Comp	10	600/2400	BULK	<b>2.22</b>
84044	3/8" OD x 1/4" Female Comp	10	500/2400	BULK	<b>3.56</b>

## Plastic Push-Fit Fittings

### END CAP - PLASTIC

- Lead-free, nontoxic
- Works with copper, CPVC and PEX
- No tools required
- Removable and reusable without damage to plumbing or fittings
- No risk of flame or fire from a blowtorch



PART #	DESCRIPTION	UNIT ORDER	INN/MAS	PACK	LIST
84025	1/4" OD	10	100/400	BULK	1.28
84000	3/8" OD	10	100/400	BULK	2.00

### STRAIGHT VALVE - PLASTIC

- Lead-free, nontoxic
- Works with copper, CPVC and PEX
- No tools required
- Removable and reusable without damage to plumbing or fittings
- No risk of flame or fire from a blowtorch



PART #	DESCRIPTION	UNIT ORDER	INN/MAS	PACK	LIST
84040	1/4" OD x 1/4" OD	10	100/200	BULK	9.89
84041	3/8" OD x 3/8" OD	10	50/100	BULK	10.49

### MALE STRAIGHT VALVE - PLASTIC

- Lead-free, nontoxic
- Works with copper, CPVC and PEX
- No tools required
- Removable and reusable without damage to plumbing or fittings
- No risk of flame or fire from a blowtorch



PART #	DESCRIPTION	UNIT ORDER	INN/MAS	PACK	LIST
84038	1/4" OD x 1/4" MIP	10	80/160	BULK	9.98
84039	3/8" OD x 3/8" MIP	10	50/100	BULK	10.75

## Twistloc Plastic Push-Fit Fittings

### UNION - PLASTIC

- Lead-free, nontoxic
- Works with copper, CPVC and PEX
- No tools required
- Removable and reusable without damage to plumbing or fittings
- No risk of flame or fire from a blowtorch



PART #	DESCRIPTION	UNIT ORDER	INN/MAS	PACK	LIST
84011	1/2" OD	10	180/360	BAG	7.70
84012	5/8" OD x 1/2" OD	10	150/300	BAG	8.30
84013	5/8" OD	10	130/260	BAG	8.75
84014	7/8" OD x 5/8" OD	10	100/200	BAG	10.64
84015	7/8" OD	10	80/160	BAG	12.37

### ELBOW - PLASTIC

- Lead-free, nontoxic
- Works with copper, CPVC and PEX
- No tools required
- Removable and reusable without damage to plumbing or fittings
- No risk of flame or fire from a blowtorch



PART #	DESCRIPTION	UNIT ORDER	INN/MAS	PACK	LIST
84022	1/2" OD	10	140/280	BULK	8.44
84023	5/8" OD	10	130/260	BULK	9.21
84024	7/8" x 5/8" OD	5	80/160	BULK	10.24
84026	7/8" OD	5	75/150	BULK	12.86

### TUBE ELBOW - PLASTIC

- Lead-free, nontoxic
- Works with copper, CPVC and PEX
- No tools required
- Removable and reusable without damage to plumbing or fittings
- No risk of flame or fire from a blowtorch



PART #	DESCRIPTION	UNIT ORDER	INN/MAS	PACK	LIST
84037	5/8" OD	10	140/280	BULK	9.12

### MALE ELBOW - PLASTIC

- Lead-free, nontoxic
- Works with copper, CPVC and PEX
- No tools required
- Removable and reusable without damage to plumbing or fittings
- No risk of flame or fire from a blowtorch



PART #	DESCRIPTION	UNIT ORDER	INN/MAS	PACK	LIST
84032	5/8" OD x 1/2" MIP	10	170/340	BULK	7.93

### FEMALE SWIVEL ELBOW - PLASTIC

- Lead-free, nontoxic
- Works with copper, CPVC and PEX
- No tools required
- Removable and reusable without damage to plumbing or fittings
- No risk of flame or fire from a blowtorch



PART #	DESCRIPTION	UNIT ORDER	INN/MAS	PACK	LIST
84034	5/8" OD x 1/2" FIP	10	130/260	BULK	7.67

Supply Connectors

Stop Valves

Water Heater

Gas Connectors

Water Filtration

Sinks/ Faucets

Tubular/ Drainage

Faucet Repair

Bath Accessories

Pipe Fittings/ Repair

Valves

Cements/ Sealants

Tools/ Safety

Toilet Repair

Appliance/ HVAC

Hardware

Electrical

Index

# PIPE FITTINGS AND REPAIR

## Twistloc Plastic Push-Fit Fittings

### DROP EAR ELBOW - PLASTIC

- Lead-free, nontoxic
- Works with copper, CPVC and PEX
- No tools required
- Removable and reusable without damage to plumbing or fittings
- No risk of flame or fire from a blowtorch



PART #	DESCRIPTION	UNIT ORDER	INN/MAS	PACK	LIST
84033	5/8" OD x 1/2" FIP	10	100/200	BULK	10.35

### TEE - PLASTIC

- Lead-free, nontoxic
- Works with copper, CPVC and PEX
- No tools required
- Removable and reusable without damage to plumbing or fittings
- No risk of flame or fire from a blowtorch



PART #	DESCRIPTION	UNIT ORDER	INN/MAS	PACK	LIST
84017	1/2" OD	10	110/220	BULK	12.72
84018	5/8" OD	10	80/160	BULK	11.32
84019	7/8" x 5/8" x 5/8" OD	5	60/120	BULK	14.68
84020	7/8" x 7/8" x 5/8" OD	5	50/100	BULK	15.37
84021	7/8" OD	5	45/90	BULK	16.19

### TUBE TEE - PLASTIC

- Lead-free, nontoxic
- Works with copper, CPVC and PEX
- No tools required
- Removable and reusable without damage to plumbing or fittings
- No risk of flame or fire from a blowtorch



PART #	DESCRIPTION	UNIT ORDER	INN/MAS	PACK	LIST
84016	5/8" OD	10	90/180	BULK	12.74

### STRAIGHT STEM-TO-TUBE ADAPTER - PLASTIC

- Lead-free, nontoxic
- Works with copper, CPVC and PEX
- No tools required
- Removable and reusable without damage to plumbing or fittings
- No risk of flame or fire from a blowtorch



PART #	DESCRIPTION	UNIT ORDER	INN/MAS	PACK	LIST
84035	1/2" OD x 5/8" OD	10	200/400	BULK	9.41
84036	7/8" OD x 5/8" OD	5	145/290	BULK	8.38

### MALE ADAPTER - PLASTIC

- Lead-free, nontoxic
- Works with copper, CPVC and PEX
- No tools required
- Removable and reusable without damage to plumbing or fittings
- No risk of flame or fire from a blowtorch



PART #	DESCRIPTION	UNIT ORDER	INN/MAS	PACK	LIST
84029	1/2" OD x 1/2" MIP	10	220/440	BULK	6.81
84030	5/8" OD x 1/2" MIP	10	180/360	BULK	7.24
84031	7/8" OD x 3/4" MIP	5	120/240	BULK	11.01

### FEMALE ADAPTER - PLASTIC

- Lead-free, nontoxic
- Works with copper, CPVC and PEX
- No tools required
- Removable and reusable without damage to plumbing or fittings
- No risk of flame or fire from a blowtorch



PART #	DESCRIPTION	UNIT ORDER	INN/MAS	PACK	LIST
84027	1/2" OD x 5/8" OD	10	160/320	BULK	9.12
84028	7/8" OD x 5/8" OD	5	120/240	BULK	11.83

### FEMALE SWIVEL ADAPTER - PLASTIC

- Lead-free, nontoxic
- Works with copper, CPVC and PEX
- No tools required
- Removable and reusable without damage to plumbing or fittings
- No risk of flame or fire from a blowtorch



PART #	DESCRIPTION	UNIT ORDER	INN/MAS	PACK	LIST
84065	5/8" OD x 1/2" FIP	5	60/120	BULK	6.70

### END CAP - PLASTIC

- Lead-free, nontoxic
- Works with copper, CPVC and PEX
- No tools required
- Removable and reusable without damage to plumbing or fittings
- No risk of flame or fire from a blowtorch



PART #	DESCRIPTION	UNIT ORDER	INN/MAS	PACK	LIST
84009	5/8" OD	10	230/460	BULK	5.67
84010	7/8" OD	5	150/300	BULK	7.27

## Twistloc Plastic Push-Fit Fittings

### STRAIGHT VALVE

- Lead-free, nontoxic
- Works with copper, CPVC and PEX
- No tools required
- Removable and reusable without damage to plumbing or fittings
- No risk of flame or fire from a blowtorch



PART #	DESCRIPTION	UNIT ORDER	INN/MAS	PACK	LIST
84004	1/4" OD x 5/8" OD	5	60/120	BULK	18.45
84005	1/2" OD x 5/8" OD	5	60/120	BULK	17.36
84006	5/8" OD x 5/8" OD	5	60/120	BULK	19.47
84007	7/8" OD x 7/8" OD	5	25/75	BULK	23.95

### STRAIGHT VALVE

- Lead-free, nontoxic
- Works with copper, CPVC and PEX
- No tools required
- Removable and reusable without damage to plumbing or fittings
- No risk of flame or fire from a blowtorch



PART #	DESCRIPTION	UNIT ORDER	INN/MAS	PACK	LIST
84008	3/8" OD x 1/2" FIP	5	80/100	BULK	15.65

### ANGLE VALVE

- Lead-free, nontoxic
- Works with copper, CPVC and PEX
- No tools required
- Removable and reusable without damage to plumbing or fittings
- No risk of flame or fire from a blowtorch



PART #	DESCRIPTION	UNIT ORDER	INN/MAS	PACK	LIST
84002	3/8" OD x 5/8" OD	5	80/160	BULK	13.89
84003	1/2" OD x 5/8" OD	5	80/160	BULK	13.95

### SLIP TEE VALVE

- Lead-free, nontoxic
- Works with copper, CPVC and PEX
- No tools required
- For icemaker and humidifier lines



PART #	DESCRIPTION	UNIT ORDER	INN/MAS	PACK	LIST
84001	5/8" OD x 5/8" OD x 1/4" OD	5	120/240	BULK	17.02

## ADD-AN-OUTLET VALVE

- Screws onto existing stop valve
- Provides outlet for icemaker or dishwasher
- No tools required
- Lead-free, nontoxic
- 3/8" OD female compression thread inlet
- 3/8" OD male compression thread outlet
- 3/8" OD or 1/4" OD push-fit outlet



PART #	DESCRIPTION	UNIT ORDER	INN/MAS	PACK	LIST
84048	3/8" x 3/8" x 1/4" OD	5	400/800	BAG	13.54
84045	3/8" x 3/8" x 3/8" OD	5	300/600	BAG	14.11

## ADD-AN-OUTLET VALVE

- Works with copper, CPVC and PEX
- No tools required
- Lead-free, nontoxic



PART #	DESCRIPTION	UNIT ORDER	INN/MAS	PACK	LIST
84046	1/2" FIP x 1/2" MIP x 1/4" OD	5	200/400	BAG	14.97
84047	1/2" FIP x 1/2" MIP x 3/8" OD	1	200/400	BAG	15.82

## PEX Tubing

### PEX TUBING

- For use with hot or cold potable water plumbing applications
- Copper tube size
- Not for use with LP or natural gas
- Blue, red, or white color



85792

85795

85724



PART #	DESCRIPTION	UNIT ORDER	INN/MAS	PACK	LIST
85724	White 1/8" ID x 100'	1	-/1	BAG	51.01
85725	White 1/4" ID x 100'	1	-/1	BAG	52.03
85786	White 3/8" ID x 100'	1	-/1	BAG	51.15
85792	Blue 1/2" ID x 100'	1	-/1	BAG	59.02
85793	Red 1/2" ID x 100'	1	-/1	BAG	59.02
85787	White 1/2" ID x 100'	1	-/1	BAG	59.02
85794	Blue 3/4" ID x 100'	1	-/1	BAG	107.55
85795	Red 3/4" ID x 100'	1	-/1	BAG	107.55
85788	White 3/4" ID x 100'	1	-/1	BAG	107.55
85796	Blue 1/2" ID x 300'	1	-/1	BAG	177.03
85797	Red 1/2" ID x 300'	1	-/1	BAG	177.03
85790	White 1/2" ID x 300'	1	-/1	BAG	177.03
85798	Blue 3/4" ID x 300'	1	-/1	BAG	322.67
85799	Red 3/4" ID x 300'	1	-/1	BAG	322.67
85791	White 3/4" ID x 300'	1	-/1	BAG	322.19

Supply Connectors

Stop Valves

Water Heater

Gas Connectors

Water Filtration

Sinks/Faucets

Tubular/Drainage

Faucet Repair

Bath Accessories

Pipe Fittings/Repair

Valves

Cements/Sealants

Tools/Safety

Toilet Repair

Appliance/HVAC

Hardware

Electrical

Index

# PIPE FITTINGS AND REPAIR

## Polymer F1807 PEX Fittings

### COUPLING - POLYMER

- High-performance polymer
- For use with ASTM F1807 Crimp PEX



PART #	DESCRIPTION	UNIT ORDER	INN/MAS	PACK	LIST
66030	1/2"	10	10/200	BAG	0.63
66031	3/4" x 1/2"	10	10/200	BAG	0.83
66032	3/4"	10	10/200	BAG	1.03
66090	1" x 3/4"	5	5/100	BAG	1.48
66033	1"	5	5/100	BAG	1.94

### ELBOW - POLYMER

- High-performance polymer
- For use with ASTM F1807 Crimp PEX



PART #	DESCRIPTION	UNIT ORDER	INN/MAS	PACK	LIST
66051	1/2"	10	10/200	BAG	0.91
66087	3/4" x 1/2"	10	10/200	BAG	1.37
66088	3/4"	10	10/200	BAG	1.80
66089	1"	5	5/100	BAG	3.28

### TEE - POLYMER

- High-performance polymer
- For use with ASTM F1807 Crimp PEX



PART #	A x B x C	UNIT ORDER	INN/MAS	PACK	LIST
66040	1/2"	10	10/200	BAG	1.23
66041	1/2" x 1/2" x 3/4"	10	10/200	BAG	1.63
66042	3/4" x 1/2" x 1/2"	10	10/200	BAG	1.63
66043	3/4" x 1/2" x 3/4"	10	10/200	BAG	2.05
66044	3/4" x 3/4" x 1/2"	10	10/200	BAG	2.05
66045	3/4"	5	5/100	BAG	2.57
65008	3/4" x 3/4" x 1"	5	5/100	BAG	3.65
66046	1" x 3/4" x 3/4"	5	5/100	BAG	3.65
65009	1" x 3/4" x 1"	5	5/100	BAG	3.65
66047	1" x 1" x 1/2"	5	5/100	BAG	3.59
66048	1" x 1" x 3/4"	5	5/100	BAG	3.65
66049	1"	5	5/100	BAG	4.73

## MALE ADAPTER - POLYMER

- High-performance polymer
- For use with ASTM F1807 Crimp PEX



PART #	DESCRIPTION	UNIT ORDER	INN/MAS	PACK	LIST
66098	1/2" PEX x 1/2" MIP	10	10/200	BAG	1.48
66124	1/2" PEX x 3/4" MIP	10	10/200	BAG	1.71
66125	3/4" PEX x 1/2" MIP	10	10/200	BAG	1.71
66126	3/4" PEX x 3/4" MIP	10	10/200	BAG	1.91

## PLUG - POLYMER

- High-performance polymer
- For use with ASTM F1807 Crimp PEX



PART #	DESCRIPTION	UNIT ORDER	INN/MAS	PACK	LIST
66091	1/2"	10	10/200	BAG	0.54
66092	3/4"	10	10/200	BAG	0.91
66093	1"	5	5/100	BAG	1.43

## Polymer F1960 PEX Fittings

### COUPLING - POLYMER

**NEW**

- High-performance polymer
- For use with ASTM F1960 Expansion PEX



PART #	DESCRIPTION	UNIT ORDER	INN/MAS	PACK	LIST
66150	1/2"	10	10/200	BAG	1.80
66152	1/2" x 3/4"	10	10/200	BAG	3.74
66151	3/4"	10	10/200	BAG	2.28
66154	1" x 3/4"	5	5/100	BAG	5.39
66153	1"	5	5/100	BAG	3.51

## Polymer F1960 PEX Fittings

### ELBOW - POLYMER

- High-performance polymer
- For use with ASTM F1960 Expansion PEX



**NEW**



PART #	DESCRIPTION	UNIT ORDER	INN/MAS	PACK	LIST
66155	1/2"	10	10/200	BAG	2.22
66157	3/4" x 1/2"	10	10/200	BAG	2.74
66156	3/4"	10	10/200	BAG	2.74
66158	1"	5	5/100	BAG	5.65

### TEE - POLYMER

- High-performance polymer
- For use with ASTM F1960 Expansion PEX



**NEW**



PART #	A x B x C	UNIT ORDER	INN/MAS	PACK	LIST
66159	1/2"	10	10/200	BAG	2.22
66160	1/2" x 1/2" x 3/4"	10	10/200	BAG	8.50
66163	3/4" x 1/2" x 1/2"	10	10/200	BAG	3.39
66164	3/4" x 1/2" x 3/4"	10	10/200	BAG	3.39
66162	3/4" x 3/4" x 1/2"	10	10/200	BAG	2.82
66161	3/4"	10	10/200	BAG	3.51
66168	1" x 3/4" x 3/4"	5	5/100	BAG	5.59
66166	1" x 3/4" x 1"	5	5/100	BAG	6.73
66165	1" x 1" x 1/2"	5	5/100	BAG	5.84
66169	1" x 1" x 3/4"	5	5/100	BAG	6.50
66167	1"	5	5/100	BAG	6.39

### PLUG - POLYMER

- High-performance polymer
- For use with ASTM F1960 Expansion PEX



**NEW**



PART #	DESCRIPTION	UNIT ORDER	INN/MAS	PACK	LIST
66170	1/2"	10	10/200	BAG	1.37
66171	3/4"	10	10/200	BAG	2.17
66172	1"	5	5/100	BAG	2.82

## Brass F1807 PEX Fittings

### COUPLING - PEX x PEX - BRASS

- Brass
- For use with ASTM F1807 Crimp PEX



PART #	DESCRIPTION	UNIT ORDER	INN/MAS	PACK	LIST
65029LF	3/8" PEX x 3/8" PEX	20	20/120	BAG	0.91
65030LF	1/2" PEX x 1/2" PEX	10	10/60	BAG	1.05
65031LF	3/4" PEX x 1/2" PEX	10	10/60	BAG	1.74
65032LF	3/4" PEX x 3/4" PEX	10	10/60	BAG	1.57
65001LF	1" PEX x 3/4" PEX	10	10/60	BAG	3.16
65033LF	1" PEX x 1" PEX	5	5/30	BAG	3.22

### ELBOW - PEX x PEX - BRASS

- Brass
- For use with ASTM F1807 Crimp PEX



PART #	DESCRIPTION	UNIT ORDER	INN/MAS	PACK	LIST
65050LF	3/8" PEX x 3/8" PEX	20	20/120	BAG	1.05
65051LF	1/2" PEX x 1/2" PEX	10	10/60	BAG	1.60
65087LF	3/4" PEX x 1/2" PEX	10	10/60	BAG	2.14
65088LF	3/4" PEX x 3/4" PEX	10	10/60	BAG	2.65
65089LF	1" PEX x 1" PEX	5	5/30	BAG	4.88

### MALE ELBOW - PEX x MIP - BRASS

- Brass
- For use with ASTM F1807 Crimp PEX



PART #	DESCRIPTION	UNIT ORDER	INN/MAS	PACK	LIST
65140LF	1/2" PEX x 1/2" MIP	5	5/30	BAG	4.53
65142LF	3/4" PEX x 3/4" MIP	5	5/30	BAG	6.59

Supply Connectors

Stop Valves

Water Heater

Gas Connectors

Water Filtration

Sinks/ Faucets

Tubular/ Drainage

Faucet Repair

Bath Accessories

Pipe Fittings/ Repair

Valves

Cements/ Sealants

Tools/ Safety

Toilet Repair

Appliance/ HVAC

Hardware

Electrical

Index

# PIPE FITTINGS AND REPAIR

## Brass F1807 PEX Fittings

### DROP EAR ELBOW - PEX x FEMALE - BRASS

- Brass
- For use with ASTM F1807 Crimp PEX



PART #	DESCRIPTION	UNIT ORDER	INN/MAS	PACK	LIST
65144LF	1/2" PEX x 1/2" FIP	10	10/60	BAG	6.16
65002LF	3/4" PEX x 3/4" FIP	10	10/60	BAG	8.41

### FEMALE SWIVEL ELBOW - PEX x FEMALE SWIVEL - BRASS

- Brass with plastic nut
- For use with ASTM F1807 Crimp PEX



PART #	DESCRIPTION	UNIT ORDER	INN/MAS	PACK	LIST
65135LF	1/2" PEX x 1/2" Female Swivel	10	10/60	BAG	2.59

### TEE - PEX x PEX x PEX - BRASS

- Brass
- For use with ASTM F1807 Crimp PEX

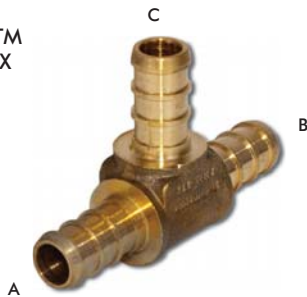

PART #	A x B x C	UNIT ORDER	INN/MAS	PACK	LIST
65039LF	3/8" PEX x 3/8" PEX x 3/8" PEX	20	20/120	BAG	1.80
65040LF	1/2" PEX x 1/2" PEX x 1/2" PEX	10	10/60	BAG	2.08
65041LF	1/2" PEX x 1/2" PEX x 3/4" PEX	10	10/60	BAG	2.97
65042LF	3/4" PEX x 1/2" PEX x 1/2" PEX	10	10/60	BAG	3.16
65043LF	3/4" PEX x 1/2" PEX x 3/4" PEX	10	10/60	BAG	5.16
65044LF	3/4" PEX x 3/4" PEX x 1/2" PEX	10	10/60	BAG	3.16
65045LF	3/4" PEX x 3/4" PEX x 3/4" PEX	10	10/60	BAG	3.22
65006LF	3/4" PEX x 3/4" PEX x 1" PEX	5	5/30	BAG	4.33
65046LF	1" PEX x 3/4" PEX x 3/4" PEX	5	5/30	BAG	6.59
65007LF	1" PEX x 3/4" PEX x 1" PEX	5	5/30	BAG	6.27
65047LF	1" PEX x 1" PEX x 1/2" PEX	5	5/30	BAG	5.33
65048LF	1" PEX x 1" PEX x 3/4" PEX	5	5/30	BAG	6.27
65049LF	1" PEX x 1" PEX x 1" PEX	5	5/30	BAG	7.36

### MALE ADAPTER - PEX x MIP - BRASS

- Brass
- For use with ASTM F1807 Crimp PEX



PART #	DESCRIPTION	UNIT ORDER	INN/MAS	PACK	LIST
65098LF	1/2" PEX x 1/2" MIP	10	10/60	BAG	3.51
65124LF	1/2" PEX x 3/4" MIP	10	10/60	BAG	4.53
65125LF	3/4" PEX x 1/2" MIP	10	10/60	BAG	3.96
65126LF	3/4" PEX x 3/4" MIP	10	10/60	BAG	4.70
65127LF	3/4" PEX x 1" MIP	5	5/30	BAG	6.81
65003LF	1" PEX x 3/4" MIP	5	5/30	BAG	6.87
65129LF	1" PEX x 1" MIP	5	5/30	BAG	6.93

### FEMALE ADAPTER - PEX x FIP - BRASS

- Brass
- Non-swivel
- For use with ASTM F1807 Crimp PEX



PART #	DESCRIPTION	UNIT ORDER	INN/MAS	PACK	LIST
65094LF	1/2" PEX x 1/2" FIP	10	10/60	BAG	3.28
65095LF	1/2" PEX x 3/4" FIP	5	5/30	BAG	4.56
65096LF	3/4" PEX x 3/4" FIP	5	5/30	BAG	4.62
65004LF	3/4" PEX x 1" FIP	5	5/30	BAG	7.53
65099LF	1" PEX x 1" FIP	5	5/30	BAG	7.58

### MALE SWEAT ADAPTER - PEX x MALE SWEAT - BRASS

- Brass
- For use with ASTM F1807 Crimp PEX



PART #	DESCRIPTION	UNIT ORDER	INN/MAS	PACK	LIST
65034LF	1/2" PEX x 1/2" Male Sweat	10	10/60	BAG	1.43
65035LF	3/4" PEX x 3/4" Male Sweat	10	10/60	BAG	2.40
65053LF	1" PEX x 1" Male Sweat	5	5/30	BAG	4.93

### FEMALE SWEAT ADAPTER - PEX x FEMALE SWEAT - BRASS

- Brass
- For use with ASTM F1807 Crimp PEX



PART #	DESCRIPTION	UNIT ORDER	INN/MAS	PACK	LIST
65132LF	1/2" PEX x 1/2" Female Sweat	10	10/60	BAG	1.54
65133LF	3/4" PEX x 1/2" Female Sweat	10	10/60	BAG	1.71
65134LF	3/4" PEX x 3/4" Female Sweat	10	10/60	BAG	2.40
65154LF	1" PEX x 1" Female Sweat	5	5/30	BAG	4.93



## Brass F1807 PEX Fittings

### FEMALE SWIVEL ADAPTER - PEX x FEMALE SWIVEL - BRASS

- Brass body
- For use with ASTM F1807 Crimp PEX



PART #	DESCRIPTION	UNIT ORDER	INN/MAS	PACK	LIST
65036LF	1/2" PEX x 1/2" Female Swivel (Plastic Nut)	10	10/60	BAG	1.88
65037LF	1/2" PEX x 1/2" Female Swivel (Brass Nut)	10	10/60	BAG	2.40
65038LF	3/4" PEX x 3/4" Female Swivel (Brass Nut)	10	10/60	BAG	4.02

### TRANSITION - PEX x POLYBUTYLENE - BRASS

- Brass
- For use with ASTM F1807 Crimp PEX



PART #	DESCRIPTION	UNIT ORDER	INN/MAS	PACK	LIST
65130LF	1/2" PEX x 1/2" Polybutylene	10	10/60	BAG	1.97
65131LF	3/4" PEX x 3/4" Polybutylene	10	10/60	BAG	3.08

### PLUG - PEX - BRASS

- Brass
- For use with ASTM F1807 Crimp PEX



PART #	DESCRIPTION	UNIT ORDER	INN/MAS	PACK	LIST
65091LF	1/2" PEX	10	10/60	BAG	0.74
65092LF	3/4" PEX	10	10/60	BAG	1.31
65093LF	1" PEX	5	5/30	BAG	2.62

### PEX CRIMP RINGS - COPPER

- Priced each & sold in case quantities only



PART #	DESCRIPTION	UNIT ORDER	INN/MAS	PACK	LIST
65150	3/8" (Bagged 100 Pcs.)	100	100/1000	BULK	0.37
65151	1/2" (Bagged 100 Pcs.)	100	100/2000	BULK	0.37
65152	3/4" (Bagged 100 Pcs.)	100	100/1000	BULK	0.48
65153	1" (Bagged 100 Pcs.)	25	25/500	BULK	0.71

## PEX CLAMPS - STEEL

- Meets or exceeds the requirement of ASTM F2098
- Priced each & sold in case quantities only



PART #	DESCRIPTION	UNIT ORDER	INN/MAS	PACK	LIST
65181	3/8" - (Bagged 100)	100	100/2000	BULK	0.40
65182	1/2" - (Bagged 100)	100	100/2000	BULK	0.43
65183	3/4" - (Bagged 50)	50	50/1000	BULK	0.66
65184	1" - (Bagged 50)	50	50/500	BULK	0.83

## Brass F1960 PEX Fittings

### COUPLING - BRASS

**NEW**

- For use with ASTM F1960 expansion PEX



PART #	DESCRIPTION	UNIT ORDER	INN/MAS	PACK	LIST
65280	1/2" PEX	10	10/60	BAG	1.85
65281	3/4" PEX x 1/2" PEX	10	10/60	BAG	3.03
65282	3/4" PEX	10	10/60	BAG	3.71
65283	1" PEX x 3/4" PEX	5	5/30	BAG	5.56
65284	1" PEX	5	5/30	BAG	6.07

### ELBOW - BRASS

**NEW**

- For use with ASTM F1960 expansion PEX



PART #	DESCRIPTION	UNIT ORDER	INN/MAS	PACK	LIST
65286	1/2" PEX x 1/2" PEX	10	10/60	BAG	3.28
65287	3/4" PEX x 3/4" PEX	10	10/60	BAG	4.92
65288	1" PEX x 1" PEX	5	5/30	BAG	10.78

### MALE ELBOW - BRASS

**NEW**

- For use with ASTM F1960 expansion PEX



PART #	DESCRIPTION	UNIT ORDER	INN/MAS	PACK	LIST
65305	1/2" PEX x 1/2" MIP	10	10/60	BAG	3.65
65306	3/4" PEX x 3/4" MIP	5	5/30	BAG	5.27

Supply Connectors

Stop Valves

Water Heater

Gas Connectors

Water Filtration

Sinks/Faucets

Tubular/Drainage

Faucet Repair

Bath Accessories

Pipe Fittings/Repair

Valves

Cements/Sealants

Tools/Safety

Toilet Repair

Appliance/HVAC

Hardware

Electrical

Index

# PIPE FITTINGS AND REPAIR

## Brass F1960 PEX Fittings

### MALE SWEAT ELBOW - BRASS

- For use with ASTM F1960 expansion PEX



**NEW**



PART #	DESCRIPTION	UNIT ORDER	INN/MAS	PACK	LIST
65304	3/4" PEX x 3/4" Male Sweat	5	5/30	BAG	5.17

### FEMALE SWEAT ELBOW - BRASS

- For use with ASTM F1960 expansion PEX



**NEW**



PART #	DESCRIPTION	UNIT ORDER	INN/MAS	PACK	LIST
65307	3/4" PEX x 3/4" Female Sweat	5	5/30	BAG	5.13

### DROP EAR ELBOW - BRASS

- For use with ASTM F1960 expansion PEX



**NEW**



PART #	DESCRIPTION	UNIT ORDER	INN/MAS	PACK	LIST
65285	1/2" PEX x 1/2" FIP	10	10/60	BAG	5.09

### FEMALE SWIVEL ELBOW - BRASS

- For use with ASTM F1960 expansion PEX
- Brass with plastic nut



**NEW**



PART #	DESCRIPTION	UNIT ORDER	INN/MAS	PACK	LIST
65303	1/2" PEX x 1/2" Female Swivel	10	10/60	BAG	4.37

### TEE - BRASS

- For use with ASTM F1960 expansion PEX

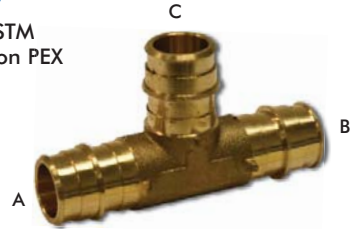

**NEW**



PART #	A x B x C	UNIT ORDER	INN/MAS	PACK	LIST
65289	1/2" PEX	10	10/60	BAG	4.36
65292	1/2" PEX x 1/2" PEX x 3/4" PEX	10	10/60	BAG	5.03
65293	3/4" PEX x 1/2" PEX x 1/2" PEX	10	10/60	BAG	4.86
65294	3/4" PEX x 1/2" PEX x 3/4" PEX	10	10/60	BAG	5.79
65295	3/4" PEX x 3/4" PEX x 1/2" PEX	10	10/60	BAG	5.60
65290	3/4" PEX	10	10/60	BAG	6.81
65296	3/4" PEX x 3/4" PEX x 1" PEX	5	5/30	BAG	8.85
65297	1" PEX x 3/4" PEX x 3/4" PEX	5	5/30	BAG	8.51
65298	1" PEX x 1" PEX x 1/2" PEX	5	5/30	BAG	9.18
65299	1" PEX x 1" PEX x 3/4" PEX	5	5/30	BAG	10.30
65291	1" PEX	5	5/30	BAG	13.18

### MALE ADAPTER - BRASS

- For use with ASTM F1960 expansion PEX



**NEW**



PART #	DESCRIPTION	UNIT ORDER	INN/MAS	PACK	LIST
65254	1/2" PEX x 1/2" MIP	10	10/60	BAG	2.45
65255	1/2" PEX x 3/4" MIP	10	10/60	BAG	3.77
65256	3/4" PEX x 1/2" MIP	10	10/60	BAG	3.17
65257	3/4" PEX x 3/4" MIP	10	10/60	BAG	3.94
65258	3/4" PEX x 1" MIP	5	5/30	BAG	6.22
65259	1" PEX x 3/4" MIP	5	5/30	BAG	5.72
65260	1" PEX x 1" MIP	5	5/30	BAG	7.31

### FEMALE ADAPTER - BRASS

- For use with ASTM F1960 expansion PEX



**NEW**



PART #	DESCRIPTION	UNIT ORDER	INN/MAS	PACK	LIST
65261	1/2" PEX x 1/2" FIP	10	10/60	BAG	2.92
65262	1/2" PEX x 3/4" FIP	5	5/30	BAG	4.18
65263	3/4" PEX x 1/2" FIP	5	5/30	BAG	3.46
65264	3/4" PEX x 3/4" FIP	5	5/30	BAG	4.67
65265	3/4" PEX x 1" FIP	5	5/30	BAG	7.45
65266	1" PEX x 1" FIP	5	5/30	BAG	8.03

## Brass F1960 PEX Fittings

### MALE SWEAT ADAPTER - BRASS

- For use with ASTM F1960 expansion PEX



PART #	DESCRIPTION	UNIT ORDER	INN/MAS	PACK	LIST
65267	1/2" PEX x 1/2" Male Sweat	10	10/60	BAG	1.97
65268	1/2" PEX x 3/4" Male Sweat	10	10/60	BAG	2.96
65269	3/4" PEX x 1/2" Male Sweat	10	10/60	BAG	2.70
65270	3/4" PEX x 3/4" Male Sweat	10	10/60	BAG	3.17
65271	3/4" PEX x 1" Male Sweat	5	5/30	BAG	4.32
65272	1" PEX x 1" Male Sweat	5	5/30	BAG	5.95

### FEMALE SWEAT ADAPTER - BRASS

- For use with ASTM F1960 expansion PEX



PART #	DESCRIPTION	UNIT ORDER	INN/MAS	PACK	LIST
65273	1/2" PEX x 1/2" Female Sweat	10	10/60	BAG	1.68
65275	1/2" PEX x 3/4" Female Sweat	10	10/60	BAG	2.49
65274	3/4" PEX x 1/2" Female Sweat	10	10/60	BAG	2.57
65276	3/4" PEX x 3/4" Female Sweat	10	10/60	BAG	3.32
65277	3/4" PEX x 1" Female Sweat	5	5/30	BAG	5.02
65278	1" PEX x 1" Female Sweat	5	5/30	BAG	6.04

### CPVC ADAPTER - BRASS

- A quick and easy transition from ASTM F1960 expansion PEX to CPVC



PART #	DESCRIPTION	UNIT ORDER	INN/MAS	PACK	LIST
65156	1/2" PEX x 1/2" CPVC	10	-/50	BOX	12.00
65187	3/4" PEX x 3/4" CPVC	10	-/50	BOX	20.53

### PLUG - BRASS

- For use with ASTM F1960 expansion PEX



PART #	DESCRIPTION	UNIT ORDER	INN/MAS	PACK	LIST
65300	1/2" PEX	10	10/60	BAG	1.34
65301	3/4" PEX	10	10/60	BAG	2.47
65302	1" PEX	5	5/30	BAG	4.22

### PEX EXPANSION RING

- For use with PEX-A SDR9 tubing with ASTM F1960 expansion PEX fittings



PART #	DESCRIPTION	UNIT ORDER	INN/MAS	PACK	LIST
65120	1/2"	50	-/1000	BAG	0.31
65121	3/4"	50	-/500	BAG	0.54
65122	1"	25	-/250	BAG	1.03

## PEX Tools and Accessories

### GO/NO-GO GAUGE

- For use with copper crimp rings



PART #	DESCRIPTION	UNIT ORDER	INN/MAS	PACK	LIST
65149	Go/No-Go Gauge	1	-/10	BULK	3.96

### CRIMP TOOL

- High mechanical advantage in a compact lightweight design
- For use with ASTM F1807 crimp PEX systems



PART #	DESCRIPTION	UNIT ORDER	INN/MAS	PACK	LIST
65145	3/8"	1	-/10	BOX	311.95
65146	1/2"	1	-/10	BOX	192.46
65147	3/4"	1	-/10	BOX	192.46
65148	1"	1	-/10	BOX	327.18

### COMBINATION CRIMP TOOL

- For use with PEX fittings
- Tool length is 12" and weighs 2 lbs.
- 1/2" and 3/4" combination
- Go/no-go gauge included



PART #	DESCRIPTION	UNIT ORDER	INN/MAS	PACK	LIST
65155	1/2" or 3/4"	1	-/10	BOX	242.35

### COMPACT CRIMP TOOL

- Allows one hand crimping to ASTM 1807 specifications
- Tool length is 12" and weighs 2 lbs.



PART #	DESCRIPTION	UNIT ORDER	INN/MAS	PACK	LIST
65179	1/2"	1	-/10	BOX	201.81
65180	3/4"	1	-/10	BOX	201.81

### CRIMP RING EASY SHEAR TOOL

- Suitable for use on 1/2", 5/8", 3/4", 1" PEX pipe sizes
- Cutting blade only penetrates the PEX pipe, so no fitting damage is possible with this tool
- Tool length is 8" and weighs 1lb



PART #	DESCRIPTION	UNIT ORDER	INN/MAS	PACK	LIST
65178	1/2", 5/8", 3/4", 1"	1	-/25	BOX	110.48
65186	Replacement Blade	1	-/5	BOX	22.44

Supply Connectors

Stop Valves

Water Heater

Gas Connectors

Water Filtration

Sinks/Faucets

Tubular/Drainage

Faucet Repair

Bath Accessories

Pipe Fittings/Repair

Valves

Cements/Sealants

Tools/Safety

Toilet Repair

Appliance/HVAC

Hardware

Electrical

Index

# PIPE FITTINGS AND REPAIR

## PEX Tools and Accessories

### STAINLESS STEEL CLAMP RATCHET TOOL

- One tool needed for 3/8", 1/2", 3/4", 1"
- Ratchet mechanism assures complete crimps
- Crimps conform to ASTM F2098 specifications
- Tool length is 11"



**EASTMAN**

PART #	DESCRIPTION	UNIT ORDER	INN/MAS	PACK	LIST
65177	3/8", 1/2", 3/4", 1"	1	-/1	BOX	247.54

### PEX L-BEND BRACKET - PLASTIC

- Secure plastic elbow to side of stud or joist using approved hardware (not included)
- Designed to support 1/2" PEX when penetrating a wall
- Glass-filled nylon



PART #	DESCRIPTION	UNIT ORDER	INN/MAS	PACK	LIST
65119	1/2" PEX	50	-/50	BULK	1.82

### PEX BEND SUPPORT - PLASTIC

**NEW**

- Costs less than using fittings and saves installation time
- Lower pressure drop than using elbow fittings
- Drop ear helps secure bracket to a stud or other wooden surface
- Nonabrasive and noncorrosive



**EASTMAN**

PART #	DESCRIPTION	UNIT ORDER	INN/MAS	PACK	LIST
65198	1/2" PEX	50	-/50	BULK	1.31
65199	3/4" PEX	50	-/50	BULK	2.62

### COPPER EARED TUBE STRAP

- Mount strap directly to stud, joist or bracket using a #6-#10 sheet metal screw

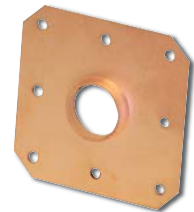

PART #	DESCRIPTION	UNIT ORDER	INN/MAS	PACK	LIST
65116	1/2" PEX	100	-/100	BULK	0.83
65118	3/4" PEX	100	-/100	BULK	0.86

### PEX BEND SUPPORT - METAL

- Forms tight radius 90° bends in PEX tube without kinking



PART #	DESCRIPTION	UNIT ORDER	INN/MAS	PACK	LIST
65112	1/2" PEX	50	-/50	BULK	1.57
65114	3/4" PEX	25	-/25	BULK	2.68

### COPPER PUSH-FIT STUB-OUT ELBOW

**NEW**

- Removable or permanent plumbing connection
- Rotates after installation
- Spun closed end



COMPLIES WITH NSF-61 UFG LEAD-FREE **EASTMAN**

PART #	DESCRIPTION	UNIT ORDER	INN/MAS	PACK	LIST
75106	1/2" x 8" x 1/2" Push-Fit	1	24/96	BAG	12.37

### PEX BEND SUPPORT WITH NAIL PLATE - METAL

- Forms tight radius 90° bends in flexible PEX tube without kinking
- Nail plate has unique open corner that allows tube to be inserted after bracket is installed and after tubing end has been plugged
- Pre-drilled hole for 3/8" (#3) rebar allows installer to use as a ground stake for flexible PEX tubing
- Mount several SideWinders to PowerBar™ to organize pipes underground before the pour



PART #	DESCRIPTION	UNIT ORDER	INN/MAS	PACK	LIST
65117	1/2" PEX	25	-/25	BULK	5.65

### COPPER F1807 PEX STUB-OUT ELBOW

- 1/2" & 3/4" PEX connection
- Accepts sweat and compression valves
- Adapts copper stub-out with installation of F1807 PEX
- Stub-out ells combine elbow and cap in one quick and easy fitting



Made in USA NSF UFG LEAD-FREE

PART #	DESCRIPTION	UNIT ORDER	INN/MAS	PACK	LIST
65160	3-1/2" x 6" x 1/2" PEX	1	-/50	BULK	6.50
65161	3-1/2" x 8" x 1/2" PEX	1	-/50	BULK	7.47
65163	3-1/2" x 8" x 3/4" PEX	1	-/50	BULK	16.17

## PEX Tools and Accessories

### COPPER F1960 PEX STUB-OUT ELBOW

- Combines easy adapting of copper stub-outs with easy installation of F1960 PEX
- Accepts sweat, push-fit and compression valves



PART #	DESCRIPTION	UNIT ORDER	INN/MAS	PACK	LIST
65158	4" x 8" x 1/2" PEX	1	-/50	BULK	12.00

### COPPER MALE SWEAT STUB-OUT ELBOW

- Rough-in ready
- Spun closed end



PART #	DESCRIPTION	UNIT ORDER	INN/MAS	PACK	LIST
65190	6" x 7" x 1/2" Male Sweat	1	-/50	BULK	9.95
65192	8" x 7" x 1/2" Male Sweat	1	-/50	BULK	11.09

### COPPER STRAIGHT STUB-OUT

- Rough-in ready
- Perfect for any stub-out application



PART #	DESCRIPTION	UNIT ORDER	INN/MAS	PACK	LIST
65164	Type M - 6" x 1/2" Female Sweat	10	-/10	BULK	3.22
65165	Type M - 8" x 1/2" Female Sweat	10	-/10	BULK	4.19
65166	Type M - 12" x 1/2" Female Sweat	10	-/10	BULK	6.16
65167	Type L - 6" x 1/2" Female Sweat	10	-/10	BULK	4.16

### COPPER F1807 PEX MANIFOLD

- Spun closed end
- 3/4" PEX inlet
- 1/2" PEX branch outlet
- Branches are 2" on center

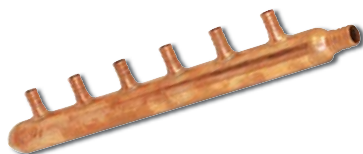

PART #	DESCRIPTION	UNIT ORDER	INN/MAS	PACK	LIST
65100	4 Branches	25	-/25	BULK	31.59
65101	6 Branches	25	-/25	BULK	40.12
65102	8 Branches	25	-/25	BULK	50.47
65103	10 Branches	25	-/25	BULK	63.01
65104	12 Branches	25	-/25	BULK	78.18

### COPPER F1807 PEX MANIFOLD

- Open-end design
- 3/4" PEX inlet & outlet
- 1/2" PEX branch outlet
- Branches are 2" on center



PART #	DESCRIPTION	UNIT ORDER	INN/MAS	PACK	LIST
65105	4 Branches	25	-/25	BULK	31.73
65106	6 Branches	25	-/25	BULK	39.92
65107	8 Branches	25	-/25	BULK	51.95

## CPVC Fittings

### CPVC PIPE

- Sold in case quantities only
- Priced per foot



FLOWGUARD® GOLD™

PART #	DESCRIPTION	UNIT ORDER	INN/MAS	PACK	LIST
85784	1/2" x 10' Pipe	250	-/250	BULK	CALL FOR CURRENT PRICE
85785	3/4" x 10' Pipe	500	-/500	BULK	CALL FOR CURRENT PRICE

### COUPLING - CPVC

- Slip x slip



FLOWGUARD® GOLD™

PART #	DESCRIPTION	UNIT ORDER	INN/MAS	PACK	LIST
85750	1/2"	20	20/1000	BULK	CALL FOR CURRENT PRICE
85753	3/4" x 1/2"	10	10/250	BULK	CALL FOR CURRENT PRICE
85751	3/4"	20	20/500	BULK	CALL FOR CURRENT PRICE
85752	1"	10	10/100	BULK	CALL FOR CURRENT PRICE

### COUPLING - CPVC

- Slip x slip



PART #	DESCRIPTION	UNIT ORDER	INN/MAS	PACK	LIST
88750	1/2" x 1/2"	1	20/500	BULK	CALL FOR CURRENT PRICE
88751	3/4" x 3/4"	1	20/260	BULK	CALL FOR CURRENT PRICE
88752	1" x 1"	1	10/100	BULK	CALL FOR CURRENT PRICE

### 90° ELBOW - CPVC

- Slip x slip



FLOWGUARD® GOLD™

PART #	DESCRIPTION	UNIT ORDER	INN/MAS	PACK	LIST
85754	1/2"	20	20/1000	BULK	CALL FOR CURRENT PRICE
85755	3/4"	20	20/500	BULK	CALL FOR CURRENT PRICE
85756	1"	10	10/100	BULK	CALL FOR CURRENT PRICE

Supply Connectors

Stop Valves

Water Heater

Gas Connectors

Water Filtration

Sinks/ Faucets

Tubular/ Drainage

Faucet Repair

Bath Accessories

Pipe Fittings/ Repair

Valves

Cements/ Sealants

Tools/ Safety

Toilet Repair

Appliance/ HVAC

Hardware

Electrical

Index

# PIPE FITTINGS AND REPAIR

## CPVC Fittings

### 90° ELBOW - CPVC

- Slip x slip



PART #	DESCRIPTION	UNIT ORDER	INN/MAS	PACK	LIST
88754	1/2" x 1/2"	1	20/500	BULK	CALL FOR CURRENT PRICE
88755	3/4" x 3/4"	1	20/260	BULK	CALL FOR CURRENT PRICE
88756	1" x 1"	1	10/100	BULK	CALL FOR CURRENT PRICE

### 90° STREET ELBOW - CPVC

- Slip x spigot



PART #	DESCRIPTION	UNIT ORDER	INN/MAS	PACK	LIST
85757	1/2"	10	10/500	BULK	CALL FOR CURRENT PRICE
85758	3/4"	10	10/250	BULK	CALL FOR CURRENT PRICE

### 90° STREET ELBOW - CPVC

- Slip x spigot



PART #	DESCRIPTION	UNIT ORDER	INN/MAS	PACK	LIST
88757	1/2" x 1/2"	1	10/500	BULK	CALL FOR CURRENT PRICE
88758	3/4" x 3/4"	1	10/250	BULK	CALL FOR CURRENT PRICE

### 90° WING ELBOW - CPVC

- Slip x slip



PART #	DESCRIPTION	UNIT ORDER	INN/MAS	PACK	LIST
85761	1/2"	90	-/90	BULK	CALL FOR CURRENT PRICE

### 90° WING ELBOW - CPVC

- Slip x slip



PART #	DESCRIPTION	UNIT ORDER	INN/MAS	PACK	LIST
88761	1/2" x 1/2"	1	-/25	BULK	CALL FOR CURRENT PRICE

### 90° FEMALE WING ELBOW - CPVC

- Slip x FIP



PART #	DESCRIPTION	UNIT ORDER	INN/MAS	PACK	LIST
85762	1/2"	100	-/100	BULK	CALL FOR CURRENT PRICE

### 90° FEMALE WING ELBOW - CPVC

- Slip x FIP



PART #	DESCRIPTION	UNIT ORDER	INN/MAS	PACK	LIST
88762	1/2" x 1/2"	1	-/25	BULK	CALL FOR CURRENT PRICE

### 90° DROP EAR ELBOW - CPVC X STAINLESS STEEL

- Slip x FIP



PART #	DESCRIPTION	UNIT ORDER	INN/MAS	PACK	LIST
86030	1/2" x 1/2"	1	25/100	BULK	CALL FOR CURRENT PRICE

### 45° ELBOW - CPVC

- Slip x slip



PART #	DESCRIPTION	UNIT ORDER	INN/MAS	PACK	LIST
85763	1/2"	20	20/500	BULK	CALL FOR CURRENT PRICE
85764	3/4"	20	20/500	BULK	CALL FOR CURRENT PRICE
85765	1"	10	10/50	BULK	CALL FOR CURRENT PRICE

### 45° ELBOW - CPVC

- Slip x slip



PART #	DESCRIPTION	UNIT ORDER	INN/MAS	PACK	LIST
88763	1/2" x 1/2"	1	20/500	BULK	CALL FOR CURRENT PRICE
88764	3/4" x 3/4"	1	20/260	BULK	CALL FOR CURRENT PRICE
88765	1" x 1"	1	10/50	BULK	CALL FOR CURRENT PRICE

## CPVC Fittings

### 45° STREET ELBOW - CPVC

- Slip x spigot



PART #	DESCRIPTION	UNIT ORDER	INN/MAS	PACK	LIST
85759	1/2"	25	25/500	BULK	CALL FOR CURRENT PRICE
85760	3/4"	25	25/500	BULK	CALL FOR CURRENT PRICE

### 45° STREET ELBOW - CPVC

- Slip x spigot



PART #	DESCRIPTION	UNIT ORDER	INN/MAS	PACK	LIST
88759	1/2" x 1/2"	1	20/500	BULK	CALL FOR CURRENT PRICE
88760	3/4" x 3/4"	1	20/260	BULK	CALL FOR CURRENT PRICE

### TEE - CPVC

- All slip



PART #	DESCRIPTION	UNIT ORDER	INN/MAS	PACK	LIST
85766	1/2"	20	20/1000	BULK	CALL FOR CURRENT PRICE
85769	3/4" x 1/2" x 1/2"	25	25/250	BULK	CALL FOR CURRENT PRICE
85771	3/4" x 1/2" x 3/4"	25	25/250	BULK	CALL FOR CURRENT PRICE
85770	3/4" x 3/4" x 1/2"	25	25/250	BULK	CALL FOR CURRENT PRICE
85767	3/4"	20	20/500	BULK	CALL FOR CURRENT PRICE
85772	1" x 1" x 3/4"	5	5/25	BULK	CALL FOR CURRENT PRICE
85768	1"	10	10/100	BULK	CALL FOR CURRENT PRICE

### TEE - CPVC

- All slip



PART #	DESCRIPTION	UNIT ORDER	INN/MAS	PACK	LIST
88766	1/2" x 1/2" x 1/2"	1	20/500	BULK	CALL FOR CURRENT PRICE
88769	3/4" x 1/2" x 1/2"	1	20/260	BULK	CALL FOR CURRENT PRICE
88771	3/4" x 1/2" x 3/4"	1	20/260	BULK	CALL FOR CURRENT PRICE
88770	3/4" x 3/4" x 1/2"	1	20/260	BULK	CALL FOR CURRENT PRICE
88767	3/4" x 3/4" x 3/4"	1	20/260	BULK	CALL FOR CURRENT PRICE
88772	1" x 1" x 3/4"	1	5/25	BULK	CALL FOR CURRENT PRICE
88768	1" x 1" x 1"	1	10/100	BULK	CALL FOR CURRENT PRICE

### MALE ADAPTER - CPVC

- Slip x MIP



PART #	DESCRIPTION	UNIT ORDER	INN/MAS	PACK	LIST
85776	1/2"	20	20/1000	BULK	CALL FOR CURRENT PRICE
85777	3/4"	10	10/500	BULK	CALL FOR CURRENT PRICE
85778	1"	10	10/100	BULK	CALL FOR CURRENT PRICE

### MALE ADAPTER - CPVC

- Slip x MIP



PART #	DESCRIPTION	UNIT ORDER	INN/MAS	PACK	LIST
88776	1/2" x 1/2"	1	20/500	BULK	CALL FOR CURRENT PRICE
88777	3/4" x 3/4"	1	10/250	BULK	CALL FOR CURRENT PRICE
88778	1" x 1"	1	10/100	BULK	CALL FOR CURRENT PRICE

### FEMALE ADAPTER - CPVC

- Slip x FIP



PART #	DESCRIPTION	UNIT ORDER	INN/MAS	PACK	LIST
85779	1/2"	25	25/500	BULK	CALL FOR CURRENT PRICE
85780	3/4"	25	25/500	BULK	CALL FOR CURRENT PRICE

### FEMALE ADAPTER - CPVC

- Slip x FIP



PART #	DESCRIPTION	UNIT ORDER	INN/MAS	PACK	LIST
88779	1/2" x 1/2"	1	20/500	BULK	CALL FOR CURRENT PRICE
88780	3/4" x 3/4"	1	10/250	BULK	CALL FOR CURRENT PRICE

### TRANSITION MALE ADAPTER - CPVC X STAINLESS STEEL

- Slip x MIP



PART #	DESCRIPTION	UNIT ORDER	INN/MAS	PACK	LIST
86025	1/2" x 1/2"	1	25/150	BULK	CALL FOR CURRENT PRICE
86026	3/4" x 3/4"	1	25/100	BULK	CALL FOR CURRENT PRICE

### TRANSITION FEMALE ADAPTER - CPVC X STAINLESS STEEL

- Slip x FIP



PART #	DESCRIPTION	UNIT ORDER	INN/MAS	PACK	LIST
86027	1/2" x 1/2"	1	25/150	BULK	CALL FOR CURRENT PRICE
86028	3/4" x 3/4"	1	25/100	BULK	CALL FOR CURRENT PRICE
86029	1" x 1"	1	25/50	BULK	CALL FOR CURRENT PRICE

Supply Connectors

Stop Valves

Water Heater

Gas Connectors

Water Filtration

Sinks/ Faucets

Tubular/ Drainage

Faucet Repair

Bath Accessories

Pipe Fittings/ Repair

Valves

Cements/ Sealants

Tools/ Safety

Toilet Repair

Appliance/ HVAC

Hardware

Electrical

Index

# PIPE FITTINGS AND REPAIR

## CPVC Fittings

### TRANSITION PEX ADAPTER - CPVC X STAINLESS STEEL

- Spigot x PEX



PART #	DESCRIPTION	UNIT ORDER	INN/MAS	PACK	LIST
86091	1/2" x 1/2"	1	25/150	BULK	CALL FOR CURRENT PRICE
86092	3/4" x 3/4"	1	25/100	BULK	CALL FOR CURRENT PRICE

### UNION - CPVC

- Slip x slip



PART #	DESCRIPTION	UNIT ORDER	INN/MAS	PACK	LIST
86038	1/2"	1	-/20	BULK	CALL FOR CURRENT PRICE
86039	3/4"	1	-/10	BULK	CALL FOR CURRENT PRICE

### BUSHING - CPVC

- Spigot x slip



PART #	DESCRIPTION	UNIT ORDER	INN/MAS	PACK	LIST
85773	3/4" x 1/2"	10	10/250	BULK	CALL FOR CURRENT PRICE
85774	1" x 1/2"	10	10/100	BULK	CALL FOR CURRENT PRICE
85775	1" x 3/4"	10	10/100	BULK	CALL FOR CURRENT PRICE

### BUSHING - CPVC

- Spigot x slip



PART #	DESCRIPTION	UNIT ORDER	INN/MAS	PACK	LIST
88773	3/4" x 1/2"	1	10/500	BULK	CALL FOR CURRENT PRICE
88774	1" x 1/2"	1	10/100	BULK	CALL FOR CURRENT PRICE
88775	1" x 3/4"	1	10/100	BULK	CALL FOR CURRENT PRICE

### CAP - CPVC

- Slip



FLOWGUARD® GOLD™

PART #	DESCRIPTION	UNIT ORDER	INN/MAS	PACK	LIST
85781	1/2"	10	10/1000	BULK	CALL FOR CURRENT PRICE
85782	3/4"	10	10/500	BULK	CALL FOR CURRENT PRICE
85783	1"	10	10/100	BULK	CALL FOR CURRENT PRICE

### CAP - CPVC

- Slip



PART #	DESCRIPTION	UNIT ORDER	INN/MAS	PACK	LIST
88781	1/2"	1	10/500	BULK	CALL FOR CURRENT PRICE
88782	3/4"	1	10/250	BULK	CALL FOR CURRENT PRICE
88783	1"	1	10/100	BULK	CALL FOR CURRENT PRICE

### BALL VALVE - CPVC

- Slip x slip



PART #	DESCRIPTION	UNIT ORDER	INN/MAS	PACK	LIST
86044	1/2"	1	-/10	BULK	7.21
86045	3/4"	1	-/5	BULK	10.24
86046	1"	1	-/12	BULK	17.85

### LINE VALVE - CPVC

- Slip x slip



PART #	DESCRIPTION	UNIT ORDER	INN/MAS	PACK	LIST
86047	1/2"	1	-/10	BULK	8.04
86048	3/4"	1	-/10	BULK	8.04



## Brass Compression Fittings

### COMPRESSION UNION

- Brass
- Comp x comp

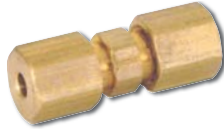

PART #	DESCRIPTION	UNIT ORDER	INN/MAS	PACK	LIST
65333LF	3/16" OD Tube	5	5/200	BULK	1.81
65335LF	1/4" OD Tube	5	5/200	BULK	2.34
65339LF	3/8" OD Tube	5	5/200	BULK	3.02
65343LF	1/2" OD Tube	5	5/200	BULK	4.69
65345LF	5/8" OD Tube	5	5/100	BULK	5.23
65347LF	7/8" OD Tube	5	5/100	BULK	11.26

### COMPRESSION REDUCING UNION

- Brass
- Comp x comp



PART #	DESCRIPTION	UNIT ORDER	INN/MAS	PACK	LIST
65361LF	3/8" x 1/4" OD Tube	5	5/200	BULK	2.65
65367LF	1/2" x 3/8" OD Tube	5	5/100	BULK	4.08
65369LF	5/8" x 3/8" OD Tube	5	5/100	BULK	4.20

### COMPRESSION ELBOW

- Brass
- Comp x comp



PART #	DESCRIPTION	UNIT ORDER	INN/MAS	PACK	LIST
65401LF	1/4" OD Tube	5	5/200	BULK	3.42
65405LF	3/8" OD Tube	5	5/100	BULK	3.55

### COMPRESSION MALE ELBOW

- Brass
- Comp x MIP



PART #	DESCRIPTION	UNIT ORDER	INN/MAS	PACK	LIST
65509LF	3/8" OD Tube x 3/8" MIP	5	5/100	BAG	4.15

### COMPRESSION MALE REDUCING ELBOW

- Brass
- Comp x MIP



PART #	DESCRIPTION	UNIT ORDER	INN/MAS	PACK	LIST
65507LF	3/8" OD Tube x 1/4" MIP	5	5/200	BULK	3.40
65513LF	3/8" OD Tube x 1/2" MIP	5	5/200	BULK	7.72
65517LF	1/2" OD Tube x 3/8" MIP	5	5/200	BULK	6.42

### COMPRESSION DISHWASHER ELBOW

- Fits dishwashers with 3/4" MHT inlet
- 3/4" FHT x 3/8" comp



**EASTMAN**

PART #	DESCRIPTION	UNIT ORDER	INN/MAS	PACK	LIST
65446LF	Less Nut & Sleeve	5	5/200	BULK	4.99
65447LF	With 3/8" OD Nut & Ring	12	12/48	CLAM	6.42

### COMPRESSION TEE

- Brass
- All comp



PART #	DESCRIPTION	UNIT ORDER	INN/MAS	PACK	LIST
65375LF	1/4" OD Tube	5	5/200	BULK	4.48
65379LF	3/8" OD Tube	5	5/200	BULK	6.42
62557LF	5/8" OD Tube	5	5/200	BULK	12.40

### COMPRESSION MALE ADAPTER

- Brass
- Comp x MIP



PART #	DESCRIPTION	UNIT ORDER	INN/MAS	PACK	LIST
65457LF	1/4" OD Tube x 1/4" MIP	5	5/100	BULK	1.71
65469LF	3/8" OD Tube x 3/8" MIP	5	5/100	BULK	2.79
65475LF	1/2" OD Tube x 1/2" MIP	5	5/100	BULK	4.04

### COMPRESSION FEMALE ADAPTER

- Brass
- Comp x FIP



PART #	DESCRIPTION	UNIT ORDER	INN/MAS	PACK	LIST
65423LF	1/4" OD Tube x 1/4" FIP	5	5/200	BULK	3.39

### COMPRESSION MALE REDUCING ADAPTER

- Brass
- Comp x MIP



PART #	DESCRIPTION	UNIT ORDER	INN/MAS	PACK	LIST
65455LF	1/4" OD Tube x 1/8" MIP	5	5/200	BULK	1.48
65458LF	1/4" OD Tube x 3/8" MIP	5	5/100	BULK	2.37
65460LF	1/4" OD Tube x 1/2" MIP	5	5/100	BULK	3.24
65465LF	3/8" OD Tube x 1/4" MIP	5	5/100	BULK	2.14
65471LF	3/8" OD Tube x 1/2" MIP	5	5/100	BULK	3.52
65473LF	1/2" OD Tube x 3/8" MIP	5	5/200	BULK	3.55
65479LF	5/8" OD Tube x 1/2" MIP	5	5/100	BULK	4.08
65481LF	5/8" OD Tube x 3/4" MIP	5	5/100	BULK	6.58
65487LF	7/8" OD Tube x 3/4" MIP	5	5/100	BULK	9.01

Supply Connectors

Stop Valves

Water Heater

Gas Connectors

Water Filtration

Sinks/Faucets

Tubular/Drainage

Faucet Repair

Bath Accessories

Pipe Fittings/Repair

Valves

Cements/Sealants

Tools/Safety

Toilet Repair

Appliance/HVAC

Hardware

Electrical

Index

# PIPE FITTINGS AND REPAIR

## Brass Compression Fittings

### COMPRESSION FEMALE REDUCING ADAPTER

- Brass
- Comp x FIP



PART #	DESCRIPTION	UNIT ORDER	INN/MAS	PACK	LIST
65431LF	3/8" OD Tube x 1/2" FIP	5	5/100	BULK	3.51
65435LF	5/8" OD Tube x 1/2" FIP	5	5/200	BULK	5.22
62550LF	7/8" OD Tube x 3/4" FIP	10	10/100	BULK	10.09

### COMPRESSION FEMALE FLARE ADAPTER

- Brass
- Comp x female flare



PART #	DESCRIPTION	UNIT ORDER	INN/MAS	PACK	LIST
65680LF	1/4" OD Tube x 1/4" Female Flare	25	25/200	BULK	6.64

### COMPRESSION FHT ADAPTER

- Brass with washer
- Comp x FHT



PART #	DESCRIPTION	UNIT ORDER	INN/MAS	PACK	LIST
65444LF	1/4" OD Tube x 3/4" FHT	10	10/100	BULK	4.56
65445LF	3/8" OD Tube x 3/4" FHT	10	10/100	BULK	8.44

### COMPRESSION NUT

- Brass
- Comp x comp



PART #	DESCRIPTION	UNIT ORDER	INN/MAS	PACK	LIST
65201LF	1/4" OD Tube	10	10/500	BULK	0.71
65205LF	3/8" OD Tube	10	10/200	BULK	0.80
65211LF	5/8" OD Tube	25	25/500	BULK	2.00

### PLASTIC COMPRESSION SLEEVE

- Sold & priced 100 per bag



PART #	DESCRIPTION	UNIT ORDER	INN/MAS	PACK	LIST
65234	For 1/4" OD - 100 Pack	1	10/100	BULK	11.55
65236	For 3/8" OD - 100 Pack	1	10/100	BULK	7.84

### COMPRESSION SLEEVE

- Brass



PART #	DESCRIPTION	UNIT ORDER	INN/MAS	PACK	LIST
65221LF	For 1/4" OD	100	100/2000	BULK	0.18
65225LF	For 3/8" OD	100	100/2000	BULK	0.18
65229LF	For 1/2" OD	100	100/2000	BULK	0.23
65231LF	For 5/8" OD	100	100/2000	BULK	0.26

### COMPRESSION CAP

- Brass
- Comp



PART #	DESCRIPTION	UNIT ORDER	INN/MAS	PACK	LIST
65243LF	1/4" OD Tube	5	5/500	BULK	0.71
65247LF	3/8" OD Tube	5	5/500	BULK	0.91
65251LF	1/2" OD Tube	5	5/500	BULK	1.76
65253LF	5/8" OD Tube	5	5/500	BULK	2.14

### BRASS TUBE INSERT

- Sold & priced 100 per bag



PART #	DESCRIPTION	UNIT ORDER	INN/MAS	PACK	LIST
65239LF	For 1/4" ID - 100 Pack	1	-/20	BULK	20.27

## Brass Flare Fittings

### FLARE UNION

- Brass
- Flare x flare



PART #	DESCRIPTION	UNIT ORDER	INN/MAS	PACK	LIST
65625	3/8" OD Tube	5	5/200	BULK	2.77

### FLARE SWIVEL CONNECTOR

- Brass
- Female flare x female flare



PART #	DESCRIPTION	UNIT ORDER	INN/MAS	PACK	LIST
62516	3/8" OD Tube x 3/8" OD Tube	5	5/200	BULK	5.79

## Brass Flare Fittings

### FLARE MALE ADAPTER

- Brass
- Flare x MIP
- Tapped female



PART #	DESCRIPTION	UNIT ORDER	INN/MAS	PACK	LIST
62744	3/8" OD Tube x 3/8" MIP (Tapped 1/8" FIP)	5	5/100	BULK	2.71
62745	3/8" OD Tube x 1/2" MIP (Tapped 3/8" FIP)	5	5/100	BULK	2.71
62730	5/8" OD Tube x 1/2" MIP (Tapped 3/8" FIP)	5	5/100	BULK	3.28
62731	5/8" OD Tube x 3/4" MIP (Tapped 1/2" FIP)	5	5/100	BULK	5.02
65726	1/2" OD Tube x 1/2" MIP (Tapped 3/8" FIP)	5	5/100	BULK	3.02
62740	1/2" OD Tube x 3/4" MIP (Tapped 1/2" FIP)	5	5/100	BULK	2.54
65720	1" OD Tube x 3/4" MIP (Tapped 1/2" FIP)	5	5/100	BULK	4.33

### FLARE MALE ADAPTER

- Brass
- Flare x MIP



PART #	DESCRIPTION	UNIT ORDER	INN/MAS	PACK	LIST
65704	1/2" OD Tube x 1/2" MIP	5	-/25	BULK	3.56
65703	5/8" OD Tube x 1/2" MIP	5	-/25	BULK	3.96
*65705	5/8" OD Tube x 3/4" MIP	5	5/200	BULK	2.25

\*While Supplies Last

### FLARE FEMALE ADAPTER

- Brass
- Flare x FIP



PART #	DESCRIPTION	UNIT ORDER	INN/MAS	PACK	LIST
62747	3/8" OD Tube x 3/8" FIP	5	-/100	BULK	2.42
65728	1/2" OD Tube x 1/2" FIP	5	-/100	BULK	3.02
65722	1" OD Tube x 3/4" FIP	5	-/100	BULK	4.33

### FLARE NUT - SHORT

- Brass
- Female flare



PART #	DESCRIPTION	UNIT ORDER	INN/MAS	PACK	LIST
65605	3/8" OD Tube	5	5/100	BULK	1.17
65609	1/2" OD Tube	5	5/200	BULK	2.05

### FLARE PLUG

- Brass
- Flare



PART #	DESCRIPTION	UNIT ORDER	INN/MAS	PACK	LIST
62633	1/2" OD Tube	5	25/100	BULK	2.79

### FLARE CAP

- Brass
- Female flare



PART #	DESCRIPTION	UNIT ORDER	INN/MAS	PACK	LIST
65751	1/4" OD Tube	5	25/200	BULK	0.77
65753	3/8" OD Tube	5	25/100	BULK	1.28
65754	1/2" OD Tube	5	-/100	BULK	1.91
65755	5/8" OD Tube	5	-/25	BULK	4.11

## Brass Iron Pipe Fittings

### DROP EAR ELBOW

- Brass



48676LF

48675LF



PART #	DESCRIPTION	UNIT ORDER	INN/MAS	PACK	LIST
48675LF	1/2" Sweat x 1/2" FIP	50	10/100	BULK	CALL FOR CURRENT PRICE
48676LF	1/2" Sweat x 1/2" Sweat	60	10/100	BULK	CALL FOR CURRENT PRICE

### BRASS PIPE TEE

- Brass
- OD tube fittings on all ends



PART #	DESCRIPTION	UNIT ORDER	INN/MAS	PACK	LIST
*62576LF	3/4" x 3/4" x 3/4"	1	-/75	BULK	12.66

\*While Supplies Last

### BRASS PIPE REDUCING BUSHING

- Brass
- MIP x FIP



PART #	DESCRIPTION	UNIT ORDER	INN/MAS	PACK	LIST
62593LF	3/8" x 1/4"	25	-/100	BULK	1.40
62595LF	1/2" x 1/4"	25	-/100	BULK	2.79
62600LF	3/4" x 1/2"	25	-/100	BULK	3.68
62601LF	1" x 3/4"	100	-/100	BULK	6.36

### BRASS PIPE PLUG - SQUARE-HEAD

- Brass
- MIP



PART #	DESCRIPTION	UNIT ORDER	INN/MAS	PACK	LIST
62617LF	1/2"	1	-/100	BULK	5.79

# PIPE FITTINGS AND REPAIR

## Brass Iron Pipe Fittings

### BRASS HEX-HEAD PLUG

- Brass
- MIP



PART #	DESCRIPTION	UNIT ORDER	INN/MAS	PACK	LIST
62620	1/4" MIP	1	-/100	BULK	1.63

### PIPE CAP

- Brass
- FIP



PART #	DESCRIPTION	UNIT ORDER	INN/MAS	PACK	LIST
*62628LF	1/8"	1	25/100	BULK	1.25
*62631LF	1/2"	1	25/100	BULK	2.17

\*While Supplies Last

## Red Brass Nipples

### RED BRASS NIPPLE - 3/8" MIP

- Red brass



PART #	DESCRIPTION	UNIT ORDER	INN/MAS	PACK	LIST
78661LF	3/8" x Close	25	25/100	BULK	1.85
78665LF	3/8" x 2" Length	25	25/100	BULK	2.02

### RED BRASS NIPPLE - 1/2" MIP

- Red brass



PART #	DESCRIPTION	UNIT ORDER	INN/MAS	PACK	LIST
78691LF	1/2" x Close	25	25/300	BULK	2.11
78693LF	1/2" x 1-1/2" Length	25	25/300	BULK	2.57
78695LF	1/2" x 2" Length	25	25/100	BULK	3.05
78697LF	1/2" x 2-1/2" Length	25	25/100	BULK	4.05
78699LF	1/2" x 3" Length	25	25/100	BULK	4.82
78701LF	1/2" x 3-1/2" Length	25	25/100	BULK	5.50
78703LF	1/2" x 4" Length	25	25/100	BULK	6.36
78704LF	1/2" x 4-1/2" Length	25	25/100	BULK	7.13
78707LF	1/2" x 5" Length	25	25/100	BULK	7.81
78705LF	1/2" x 5-1/2" Length	25	25/100	BULK	8.58
78711LF	1/2" x 6" Length	25	25/100	BULK	9.35

### RED BRASS NIPPLE - 3/4" MIP

- Red brass



PART #	DESCRIPTION	UNIT ORDER	INN/MAS	PACK	LIST
78721LF	3/4" x Close	25	25/200	BULK	2.94
78723LF	3/4" x 1-1/2" Length	25	25/100	BULK	3.42
78725LF	3/4" x 2" Length	25	25/100	BULK	4.25
78729LF	3/4" x 3" Length	25	25/100	BULK	6.50
78733LF	3/4" x 4" Length	25	25/100	BULK	9.01
78741LF	3/4" x 6" Length	25	25/100	BULK	13.40

### RED BRASS NIPPLE - 1" MIP

- Red brass



PART #	DESCRIPTION	UNIT ORDER	INN/MAS	PACK	LIST
78742LF	1" x 2" Length	25	25/100	BULK	7.13
78744LF	1" x 3" Length	25	25/100	BULK	9.52

## Galvanized Malleable Iron Fittings

### GALVANIZED BANDED COUPLING

- 300 PSI



PART #	DESCRIPTION	UNIT ORDER	INN/MAS	PACK	LIST
78074	3/8"	10	120/480	BULK	2.25
78075	1/2"	10	120/240	BULK	1.82
78076	3/4"	10	75/150	BULK	2.08
78077	1"	10	50/100	BULK	3.45
78078	1-1/4"	8	16/64	BULK	4.73
78079	1-1/2"	9	18/36	BULK	5.39
78080	2"	12	12/24	BULK	7.84

## Galvanized Malleable Iron Fittings

### GALVANIZED BELL REDUCER

• 300 PSI



PART #	DESCRIPTION	UNIT ORDER	INN/MAS	PACK	LIST
78081	1/2" x 3/8"	10	150/300	BULK	1.82
78082	3/4" x 1/2"	10	90/180	BULK	2.11
78083	1" x 1/2"	10	60/120	BULK	3.51
78084	1" x 3/4"	10	50/100	BULK	3.28
78416	1-1/4" x 1/2"	25	25/75	BULK	5.53
78085	1-1/4" x 3/4"	5	25/75	BULK	4.48
78086	1-1/4" x 1"	10	30/60	BULK	4.48
78417	1-1/2" x 1/2"	30	30/60	BULK	6.53
78087	1-1/2" x 3/4"	10	30/60	BULK	5.79
78088	1-1/2" x 1"	25	25/50	BULK	5.79
78089	1-1/2" x 1-1/4"	12	24/48	BULK	5.79
78418	2" x 1/2"	18	18/36	BULK	9.41
78090	2" x 3/4"	18	18/36	BULK	9.41
78091	2" x 1"	18	18/36	BULK	7.84
78092	2" x 1-1/4"	9	9/27	BULK	8.30
78093	2" x 1-1/2"	9	9/27	BULK	7.84

### GALVANIZED 90° ELBOW

• 300 PSI



PART #	DESCRIPTION	UNIT ORDER	INN/MAS	PACK	LIST
78040	3/8"	10	90/360	BULK	1.94
78387	1/2" x 3/8"	10	120/240	BULK	2.25
78041	1/2"	10	100/200	BULK	1.31
78047	3/4" x 1/2"	10	80/160	BULK	2.59
78042	3/4"	5	35/105	BULK	1.57
78388	1" x 1/2"	50	50/100	BULK	3.51
78048	1" x 3/4"	10	50/100	BULK	3.34
78043	1"	10	30/60	BULK	2.88
78389	1-1/4" x 1/2"	40	40/80	BULK	6.81
78390	1-1/4" x 3/4"	30	30/60	BULK	6.70
78044	1-1/4"	10	20/40	BULK	4.45
78391	1-1/2" x 1/2"	30	30/60	BULK	8.75
78392	1-1/2" x 3/4"	20	20/40	BULK	8.55
78045	1-1/2"	15	15/30	BULK	5.84
78393	1-1/2" x 1"	20	20/40	BULK	8.55
78394	1-1/2" x 1-1/4"	15	15/30	BULK	8.55
78046	2"	8	8/16	BULK	9.75
78395	2" x 1/2"	20	20/40	BULK	12.15
78396	2" x 3/4"	18	18/36	BULK	12.15
78397	2" x 1"	14	14/28	BULK	11.89
78398	2" x 1-1/4"	10	10/20	BULK	11.89
78399	2" x 1-1/2"	10	10/20	BULK	10.78

### GALVANIZED 90° STREET ELBOW

• 300 PSI



PART #	DESCRIPTION	UNIT ORDER	INN/MAS	PACK	LIST
78049	3/8"	10	60/240	BULK	2.68
78050	1/2"	10	90/180	BULK	2.74
78051	3/4"	5	35/105	BULK	2.68
78052	1"	10	-/90	BULK	3.62
78053	1-1/4"	10	25/50	BULK	6.07
78054	1-1/2"	9	9/27	BULK	7.50
78055	2"	8	8/16	BULK	13.00

### GALVANIZED 45° ELBOW

• 300 PSI



PART #	DESCRIPTION	UNIT ORDER	INN/MAS	PACK	LIST
78383	3/8"	75	75/300	BULK	2.59
78056	1/2"	10	100/200	BULK	2.00
78057	3/4"	10	60/120	BULK	2.79
78058	1"	10	30/60	BULK	3.19
78384	1-1/4"	20	20/40	BULK	5.82
78385	1-1/2"	15	15/30	BULK	6.90
78386	2"	12	12/24	BULK	10.38

### GALVANIZED BANDED CROSS

• 300 PSI



PART #	DESCRIPTION	UNIT ORDER	INN/MAS	PACK	LIST
78119	1/2"	45	45/90	BULK	6.44
78120	3/4"	30	30/60	BULK	6.84
78121	1"	15	15/30	BULK	9.58

Supply Connectors

Stop Valves

Water Heater

Gas Connectors

Water Filtration

Sinks/ Faucets

Tubular/ Drainage

Faucet Repair

Bath Accessories

Pipe Fittings/ Repair

Valves

Cements/ Sealants

Tools/ Safety

Toilet Repair

Appliance/ HVAC

Hardware

Electrical

Index

# PIPE FITTINGS AND REPAIR

## Galvanized Malleable Iron Fittings

### GALVANIZED TEE

• 300 PSI



PART #	A x B x C	UNIT ORDER	INN/MAS	PACK	LIST
78400	1/4" x 1/4" x 1/4"	75	75/300	BULK	2.51
78059	3/8"	45	45/180	BULK	2.51
78401	1/2" x 1/2" x 3/8"	80	80/160	BULK	3.82
78060	1/2"	10	60/120	BULK	1.57
78066	3/4" x 3/4" x 1/2"	40	40/80	BULK	3.59
78061	3/4"	35	35/70	BULK	2.62
78402	1" x 1" x 1/2"	30	30/60	BULK	5.05
78067	1" x 1" x 3/4"	6	24/48	BULK	5.05
78062	1"	10	20/40	BULK	4.28
78039	1-1/4" x 3/4" x 1-1/4"	20	20/40	BULK	8.78
78403	1-1/4" x 1" x 1"	20	20/40	BULK	9.52
78404	1-1/4" x 1-1/4" x 1/2"	20	20/40	BULK	8.27
78038	1-1/4" x 1-1/4" x 3/4"	20	20/40	BULK	8.15
78405	1-1/4" x 1-1/4" x 1"	20	20/40	BULK	7.81
78063	1-1/4"	14	14/28	BULK	6.73
78407	1-1/2" x 1-1/2" x 1/2"	18	18/36	BULK	10.24
78408	1-1/2" x 1-1/2" x 3/4"	15	15/30	BULK	9.67
78409	1-1/2" x 1-1/2" x 1"	15	15/30	BULK	9.67
78410	1-1/2" x 1-1/2" x 1-1/4"	12	12/24	BULK	11.98
78064	1-1/2"	12	12/24	BULK	8.41
78411	2" x 2" x 1/2"	10	10/20	BULK	15.65
78412	2" x 2" x 3/4"	10	10/20	BULK	14.11
78413	2" x 2" x 1"	10	10/20	BULK	14.11
78414	2" x 2" x 1-1/4"	8	8/16	BULK	16.42
78415	2" x 2" x 1-1/2"	8	8/16	BULK	16.42
78065	2"	8	8/16	BULK	14.06

### GALVANIZED UNION

• 300 PSI



PART #	DESCRIPTION	UNIT ORDER	INN/MAS	PACK	LIST
78112	3/8"	75	75/150	BULK	5.79
78113	1/2"	50	50/100	BULK	5.25
78114	3/4"	35	35/70	BULK	6.13
78115	1"	20	20/40	BULK	7.64
78116	1-1/4"	15	15/30	BULK	10.98
78117	1-1/2"	10	10/20	BULK	14.68
78118	2"	6	6/12	BULK	19.53

### BUSHING - GALVANIZED MALLEABLE IRON

• 300 PSI



PART #	DESCRIPTION	UNIT ORDER	INN/MAS	PACK	LIST
78419	1/2" x 1/4"	300	300/600	BULK	2.74
78094	1/2" x 3/8"	10	300/600	BULK	2.74
78095	3/4" x 1/2"	10	150/300	BULK	2.51
78096	1" x 1/2"	10	100/200	BULK	2.99
78097	1" x 3/4"	10	100/200	BULK	2.85
78420	1-1/4" x 1/2"	60	60/120	BULK	4.22
78098	1-1/4" x 3/4"	10	60/120	BULK	3.85
78099	1-1/4" x 1"	10	60/120	BULK	3.85
78421	1-1/2" x 1/2"	25	25/75	BULK	5.59
78100	1-1/2" x 3/4"	5	25/75	BULK	5.59
78101	1-1/2" x 1"	5	25/75	BULK	5.05
78422	2" x 1/2"	30	30/60	BULK	6.96
78423	2" x 3/4"	30	30/60	BULK	6.50
78424	2" x 1"	30	30/60	BULK	6.19
78102	2" x 1-1/4"	10	30/60	BULK	6.13
78103	2" x 1-1/2"	10	30/60	BULK	5.39

### NUT - GALVANIZED MALLEABLE IRON

• 300 PSI



PART #	DESCRIPTION	UNIT ORDER	INN/MAS	PACK	LIST
78122	1/2"	25	300/600	BULK	1.57

### PLUG - GALVANIZED MALLEABLE IRON

• 300 PSI



PART #	DESCRIPTION	UNIT ORDER	INN/MAS	PACK	LIST
78104	3/8"	300	300/1200	BULK	1.48
78105	1/2"	300	300/600	BULK	1.85
78106	3/4"	180	180/360	BULK	1.85
78107	1"	120	120/240	BULK	2.02
78108	1-1/4"	40	40/120	BULK	3.14
78110	1-1/2"	45	45/90	BULK	4.22
78111	2"	30	30/60	BULK	5.25

## Galvanized Malleable Iron Fittings

### CAP - GALVANIZED MALLEABLE IRON

• 300 PSI



PART #	DESCRIPTION	UNIT ORDER	INN/MAS	PACK	LIST
78068	1/2"	10	150/300	BULK	1.34
78069	3/4"	10	80/160	BULK	1.94
78070	1"	10	50/100	BULK	2.11
78071	1-1/4"	10	20/80	BULK	3.08
78072	1-1/2"	9	27/54	BULK	3.93
78073	2"	6	18/36	BULK	4.96

### GALVANIZED NIPPLE - 3/8"

• 300 PSI



PART #	DESCRIPTION	UNIT ORDER	INN/MAS	PACK	LIST
78123	3/8" x Close	25	25/600	BULK	1.17
78124	3/8" x 1-1/2"	25	25/600	BULK	1.23
78125	3/8" x 2"	25	25/600	BULK	1.23
78126	3/8" x 2-1/2"	25	25/400	BULK	1.63
78127	3/8" x 3"	25	25/400	BULK	1.63
78128	3/8" x 3-1/2"	25	25/400	BULK	1.94
78129	3/8" x 4"	25	25/300	BULK	1.94
78425	3/8" x 4-1/2"	25	25/300	BULK	2.74
78130	3/8" x 5"	25	25/300	BULK	2.68
78426	3/8" x 5-1/2"	25	25/300	BULK	3.02
78131	3/8" x 6"	25	25/200	BULK	2.97

### GALVANIZED NIPPLE - 1/2"

• 300 PSI



PART #	DESCRIPTION	UNIT ORDER	INN/MAS	PACK	LIST
78132	1/2" x Close	25	25/600	BULK	0.94
78133	1/2" x 1-1/2"	25	25/600	BULK	0.94
78134	1/2" x 2"	25	25/600	BULK	1.03
78135	1/2" x 2-1/2"	25	25/400	BULK	1.20
78136	1/2" x 3"	25	25/400	BULK	1.31
78137	1/2" x 3-1/2"	25	25/400	BULK	1.34
78138	1/2" x 4"	25	25/250	BULK	1.45
78139	1/2" x 4-1/2"	25	25/300	BULK	1.60
78140	1/2" x 5"	25	25/300	BULK	1.63
78141	1/2" x 5-1/2"	25	25/200	BULK	1.91
78142	1/2" x 6"	25	25/200	BULK	1.91
78143	1/2" x 7"	25	25/200	BULK	3.16
78144	1/2" x 8"	25	25/100	BULK	3.14
78145	1/2" x 9"	25	25/100	BULK	3.79
78146	1/2" x 10"	25	25/75	BULK	3.79
78147	1/2" x 11"	25	25/75	BULK	4.31
78148	1/2" x 12"	25	25/75	BULK	4.31

### GALVANIZED NIPPLE - 3/4"

• 300 PSI



PART #	DESCRIPTION	UNIT ORDER	INN/MAS	PACK	LIST
78150	3/4" x Close	25	25/400	BULK	1.08
78151	3/4" x 1-1/2"	25	25/400	BULK	1.14
78152	3/4" x 2"	25	25/300	BULK	1.23
78153	3/4" x 2-1/2"	25	25/300	BULK	1.25
78154	3/4" x 3"	25	25/200	BULK	1.31
78155	3/4" x 3-1/2"	25	25/200	BULK	1.63
78156	3/4" x 4"	25	25/150	BULK	1.68
78157	3/4" x 4-1/2"	25	25/150	BULK	1.97
78158	3/4" x 5"	25	25/100	BULK	1.97
78159	3/4" x 5-1/2"	25	25/100	BULK	2.34
78160	3/4" x 6"	25	25/100	BULK	2.45
78162	3/4" x 8"	25	25/75	BULK	4.05
78163	3/4" x 9"	25	25/75	BULK	4.48
78164	3/4" x 10"	25	25/50	BULK	4.48
78165	3/4" x 11"	25	25/50	BULK	5.05
78166	3/4" x 12"	25	25/50	BULK	5.16

### GALVANIZED NIPPLE - 1"

• 300 PSI



PART #	DESCRIPTION	UNIT ORDER	INN/MAS	PACK	LIST
78167	1" x Close	25	25/300	BULK	1.60
78168	1" x 2"	25	25/200	BULK	1.74
78169	1" x 2-1/2"	25	25/200	BULK	1.82
78170	1" x 3"	25	25/150	BULK	1.91
78171	1" x 3-1/2"	25	25/150	BULK	2.22
78172	1" x 4"	25	25/100	BULK	3.11
78173	1" x 4-1/2"	25	25/100	BULK	2.82
78174	1" x 5"	25	25/100	BULK	2.97
78175	1" x 5-1/2"	25	25/75	BULK	3.11
78176	1" x 6"	25	25/75	BULK	3.56
78177	1" x 8"	25	25/75	BULK	5.10
78178	1" x 10"	25	25/50	BULK	5.84
78179	1" x 12"	25	25/50	BULK	6.81

### GALVANIZED NIPPLE - 1-1/4"

• 300 PSI



PART #	DESCRIPTION	UNIT ORDER	INN/MAS	PACK	LIST
78180	1-1/4" x Close	25	25/150	BULK	1.94
78181	1-1/4" x 2"	25	25/150	BULK	2.08
78182	1-1/4" x 2-1/2"	25	25/150	BULK	2.25
78183	1-1/4" x 3"	25	25/100	BULK	2.45
78184	1-1/4" x 3-1/2"	25	25/100	BULK	2.82
78185	1-1/4" x 4"	25	25/100	BULK	2.97
78427	1-1/4" x 4-1/2"	25	25/100	BULK	3.42
78186	1-1/4" x 5"	25	25/100	BULK	3.62
78428	1-1/4" x 5-1/2"	25	25/75	BULK	3.99
78187	1-1/4" x 6"	25	25/75	BULK	4.19
78188	1-1/4" x 8"	25	25/50	BULK	6.44
78189	1-1/4" x 10"	10	-/40	BULK	7.93
78190	1-1/4" x 12"	10	-/30	BULK	9.44

Supply Connectors

Stop Valves

Water Heater

Gas Connectors

Water Filtration

Sinks/Faucets

Tubular/Drainage

Faucet Repair

Bath Accessories

Pipe Fittings/Repair

Valves

Cements/Sealants

Tools/Safety

Toilet Repair

Appliance/HVAC

Hardware

Electrical

Index

# PIPE FITTINGS AND REPAIR

## Galvanized Malleable Iron Fittings

### GALVANIZED NIPPLE - 1-1/2"

- 300 PSI



PART #	DESCRIPTION	UNIT ORDER	INN/MAS	PACK	LIST
78191	1-1/2" x Close	25	25/100	BULK	2.31
78192	1-1/2" x 2"	25	25/75	BULK	2.57
78193	1-1/2" x 2-1/2"	25	25/75	BULK	2.74
78194	1-1/2" x 3"	25	25/50	BULK	2.97
78195	1" x 3-1/2"	25	25/50	BULK	3.51
78196	1" x 4"	25	25/50	BULK	3.62
78197	1-1/2" x 4-1/2"	25	25/50	BULK	4.68
78198	1-1/2" x 5"	25	25/50	BULK	4.62
78199	1-1/2" x 5-1/2"	25	25/50	BULK	4.79
78200	1-1/2" x 6"	25	25/50	BULK	5.16
78201	1-1/2" x 8"	10	-/40	BULK	7.64
78202	1-1/2" x 12"	10	-/20	BULK	9.75

### GALVANIZED NIPPLE - 2"

- 300 PSI



PART #	DESCRIPTION	UNIT ORDER	INN/MAS	PACK	LIST
78203	2" x Close	25	25/75	BULK	3.42
78204	2" x 2-1/2"	25	25/50	BULK	3.59
78205	2" x 3"	25	25/50	BULK	3.68
78206	2" x 3-1/2"	25	25/50	BULK	4.33
78207	2" x 4"	10	-/40	BULK	4.62
78429	2" x 4-1/2"	10	-/40	BULK	5.67
78208	2" x 5"	10	-/40	BULK	5.99
78430	2" x 5-1/2"	10	-/40	BULK	6.59
78209	2" x 6"	10	-/30	BULK	6.84
78210	2" x 8"	10	-/20	BULK	10.78
78211	2" x 10"	5	-/15	BULK	12.32
78212	2" x 12"	5	-/15	BULK	14.11

## NIPPLE KIT - GALVANIZED MALLEABLE IRON

- Comes with heavy-duty cardboard nipple caddy
- Assorted 66-piece kit



PART #	DESCRIPTION	UNIT ORDER	INN/MAS	PACK	LIST
78213	1/2" Galvanized Nipple Kit	1	-/1	BOX	96.77
78214	3/4" Galvanized Nipple Kit	1	-/1	BOX	117.98

## Black Malleable Iron Fittings

### BLACK MALLEABLE BANDED COUPLING

- 300 PSI



PART #	DESCRIPTION	UNIT ORDER	INN/MAS	PACK	LIST
78267	3/8"	10	120/480	BULK	1.77
78268	1/2"	10	120/240	BULK	1.45
78270	3/4"	5	75/150	BULK	1.71
78271	1"	10	50/100	BULK	2.57
78272	1-1/4"	8	32/64	BULK	3.31
78273	1-1/2"	9	18/36	BULK	4.39
78274	2"	12	12/24	BULK	6.39



## Black Malleable Iron Fittings

### BLACK MALLEABLE BELL REDUCER

• 300 PSI



PART #	DESCRIPTION	UNIT ORDER	INN/MAS	PACK	LIST
78275	1/2" x 3/8"	10	150/300	BULK	1.48
78276	3/4" x 1/2"	10	90/180	BULK	1.71
78277	1" x 1/2"	10	60/120	BULK	2.62
78278	1" x 3/4"	10	50/100	BULK	2.62
78464	1-1/4" x 1/2"	5	25/75	BULK	3.79
78279	1-1/4" x 3/4"	5	25/75	BULK	3.31
78280	1-1/4" x 1"	10	30/60	BULK	3.31
78281	1-1/2" x 1/4"	12	24/48	BULK	4.82
78465	1-1/2" x 1/2"	10	30/60	BULK	4.82
78466	1-1/2" x 3/4"	10	30/60	BULK	5.42
78467	1-1/2" x 1"	5	25/50	BULK	4.82
78468	2" x 1/2"	1	18/36	BULK	7.81
78469	2" x 3/4"	1	18/36	BULK	6.90
78470	2" x 1"	1	18/36	BULK	6.53
78471	2" x 1-1/4"	1	9/27	BULK	6.90
78472	2" x 1-1/2"	1	9/27	BULK	6.02

### BLACK MALLEABLE 90° ELBOW

• 300 PSI



PART #	DESCRIPTION	UNIT ORDER	INN/MAS	PACK	LIST
78231	3/8"	10	90/360	BULK	1.40
78435	1/2" x 3/8"	10	120/240	BULK	1.94
78232	1/2"	10	100/200	BULK	1.08
78238	3/4" x 1/2"	10	80/160	BULK	2.00
78233	3/4"	5	35/105	BULK	1.45
78239	1" x 1/2"	10	50/100	BULK	2.74
78240	1" x 3/4"	10	50/100	BULK	2.57
78234	1"	10	30/60	BULK	2.25
78437	1-1/4" x 1/2"	10	40/80	BULK	5.53
78438	1-1/4" x 3/4"	10	30/60	BULK	4.73
78222	1-1/4" x 1"	10	20/40	BULK	4.19
78235	1-1/4"	10	20/40	BULK	3.62
78439	1-1/2" x 1/2"	10	30/60	BULK	7.01
78440	1-1/2" x 3/4"	10	20/40	BULK	6.84
78441	1-1/2" x 1"	10	20/40	BULK	6.84
78442	1-1/2" x 1-1/4"	15	15/30	BULK	6.84
78236	1-1/2"	15	15/30	BULK	4.82
78443	2" x 1/2"	10	20/40	BULK	10.04
78444	2" x 3/4"	18	18/36	BULK	10.04
78445	2" x 1"	14	14/28	BULK	9.87
78446	2" x 1-1/4"	10	10/20	BULK	9.87
78447	2" x 1-1/2"	10	10/20	BULK	8.92
78237	2"	8	8/16	BULK	8.24

### BLACK MALLEABLE 90° STREET ELBOW

• 300 PSI



PART #	DESCRIPTION	UNIT ORDER	INN/MAS	PACK	LIST
78241	3/8"	10	60/240	BULK	2.14
78242	1/2"	10	90/180	BULK	2.20
78243	3/4"	5	35/105	BULK	2.14
78244	1"	10	-/90	BULK	3.08
78245	1-1/4"	10	-/50	BULK	4.70
78246	1-1/2"	9	9/27	BULK	6.27
78247	2"	8	8/16	BULK	10.15

### BLACK MALLEABLE 45° ELBOW

• 300 PSI



PART #	DESCRIPTION	UNIT ORDER	INN/MAS	PACK	LIST
78431	3/8"	75	75/300	BULK	2.00
78248	1/2"	100	100/200	BULK	1.74
78249	3/4"	60	60/120	BULK	2.11
78250	1"	30	30/60	BULK	2.71
78432	1-1/4"	20	20/40	BULK	4.70
78433	1-1/2"	15	15/30	BULK	5.82
78434	2"	12	12/24	BULK	8.75

Supply Connectors

Stop Valves

Water Heater

Gas Connectors

Water Filtration

Sinks/Faucets

Tubular/Drainage

Faucet Repair

Bath Accessories

Pipe Fittings/Repair

Valves

Cements/Sealants

Tools/Safety

Toilet Repair

Appliance/HVAC

Hardware

Electrical

Index

# PIPE FITTINGS AND REPAIR

## Black Malleable Iron Fittings

### BLACK MALLEABLE TEE

• 300 PSI



PART #	A x B x C	UNIT ORDER	INN/MAS	PACK	LIST
78448	1/4"	5	75/300	BULK	2.14
78251	3/8"	5	45/180	BULK	2.14
78449	1/2" x 1/2" x 3/8"	10	80/160	BULK	2.94
78252	1/2"	10	60/120	BULK	1.37
78215	3/4" x 1/2" x 1/2"	10	50/100	BULK	3.14
78223	3/4" x 1/2" x 3/4"	10	40/80	BULK	3.45
78258	3/4" x 3/4" x 1/2"	10	40/80	BULK	2.99
78253	3/4"	5	35/70	BULK	2.00
78036	1" x 1/2" x 3/4" - <b>NEW!</b>	10	40/80	BULK	5.02
78218	1" x 1/2" x 1" - <b>NEW!</b>	10	30/60	BULK	4.22
78226	1" x 3/4" x 1/2"	10	40/360	BULK	4.33
78224	1" x 3/4" x 3/4"	10	30/60	BULK	4.05
78227	1" x 3/4" x 1"	10	30/60	BULK	4.39
78259	1" x 1" x 1/2"	10	30/60	BULK	3.85
78260	1" x 1" x 3/4"	8	24/48	BULK	3.85
78254	1"	10	20/40	BULK	3.45
78217	1-1/4" x 3/4" x 3/4" - <b>NEW!</b>	10	20/40	BULK	7.81
78228	1-1/4" x 3/4" x 1"	10	90/360	BULK	7.41
78225	1-1/4" x 3/4" x 1-1/4"	10	20/40	BULK	7.21
78216	1-1/4" x 1" x 1/2" - <b>NEW!</b>	10	20/40	BULK	7.87
78229	1-1/4" x 1" x 3/4"	10	90/360	BULK	7.01
78451	1-1/4" x 1" x 1"	10	20/40	BULK	7.01
78499	1-1/4" x 1" x 1-1/4"	15	15/30	BULK	7.98
78452	1-1/4" x 1-1/4" x 1/2"	10	20/40	BULK	6.96
78219	1-1/4" x 1-1/4" x 3/4"	10	20/40	BULK	6.13
78453	1-1/4" x 1-1/4" x 1"	10	20/40	BULK	6.13
78255	1-1/4"	14	14/28	BULK	5.59
78220	1-1/2" x 1-1/4" x 3/4"	12	12/24	BULK	9.52
78454	1-1/2" x 1-1/4" x 1"	12	12/24	BULK	8.15
78230	1-1/2" x 1-1/4" x 1-1/4"	12	12/24	BULK	12.86
78455	1-1/2" x 1-1/2" x 1/2"	18	18/36	BULK	8.15
78456	1-1/2" x 1-1/2" x 3/4"	5	15/30	BULK	7.70
78457	1-1/2" x 1-1/2" x 1"	5	15/30	BULK	7.70
78458	1-1/2" x 1-1/2" x 1-1/4"	12	12/24	BULK	9.52
78256	1-1/2"	12	12/24	BULK	6.96
78459	2" x 2" x 1/2"	10	10/20	BULK	12.09
78460	2" x 2" x 3/4"	10	10/20	BULK	12.09
78461	2" x 2" x 1"	10	10/20	BULK	12.09
78462	2" x 2" x 1-1/4"	8	8/16	BULK	12.80
78463	2" x 2" x 1-1/2"	8	8/16	BULK	12.80
78257	2"	8	8/16	BULK	11.83

### BLACK MALLEABLE UNION

• 300 PSI



PART #	DESCRIPTION	UNIT ORDER	INN/MAS	PACK	LIST
78299	3/8"	10	80/160	BULK	4.90
78300	1/2"	10	50/100	BULK	4.70
78301	3/4"	5	35/70	BULK	5.59
78302	1"	10	20/40	BULK	7.30
78303	1-1/4"	10	15/30	BULK	9.67
78304	1-1/2"	10	10/20	BULK	11.83
78305	2"	6	6/12	BULK	17.02

### BLACK MALLEABLE BUSHING

• 300 PSI



PART #	DESCRIPTION	UNIT ORDER	INN/MAS	PACK	LIST
78473	1/2" x 1/4"	10	300/600	BULK	1.88
78282	1/2" x 3/8"	10	300/600	BULK	1.88
78283	3/4" x 1/2"	10	150/300	BULK	1.71
78284	1" x 1/2"	10	100/200	BULK	1.77
78285	1" x 3/4"	10	100/200	BULK	1.77
78474	1-1/4" x 1/2"	10	60/120	BULK	2.51
78286	1-1/4" x 3/4"	10	60/120	BULK	2.31
78287	1-1/4" x 1"	10	60/120	BULK	2.31
78475	1-1/2" x 1/2"	5	25/75	BULK	2.88
78288	1-1/2" x 3/4"	5	25/75	BULK	2.88
78289	1-1/2" x 1"	5	25/75	BULK	2.48
78476	2" x 1/2"	10	30/60	BULK	4.33
78477	2" x 3/4"	10	30/60	BULK	3.68
78478	2" x 1"	10	30/60	BULK	3.45
78290	2" x 1-1/4"	10	30/60	BULK	3.39
78291	2" x 1-1/2"	10	30/60	BULK	3.85

### BLACK MALLEABLE PLUG

• 300 PSI



PART #	DESCRIPTION	UNIT ORDER	INN/MAS	PACK	LIST
78292	3/8"	10	300/1200	BULK	0.91
78293	1/2"	10	300/600	BULK	0.97
78294	3/4"	10	180/360	BULK	0.97
78295	1"	10	120/240	BULK	1.23
78296	1-1/4"	10	60/120	BULK	1.43
78297	1-1/2"	5	45/90	BULK	2.14
78298	2"	10	30/60	BULK	2.99

## Black Malleable Iron Fittings

### BLACK MALLEABLE CAP

• 300 PSI



PART #	DESCRIPTION	UNIT ORDER	INN/MAS	PACK	LIST
78261	1/2"	10	150/300	BULK	1.08
78262	3/4"	10	80/160	BULK	1.45
78263	1"	10	50/100	BULK	1.74
78264	1-1/4"	10	20/80	BULK	2.25
78265	1-1/2"	9	18/54	BULK	3.08
78266	2"	6	12/36	BULK	3.99

### BLACK MALLEABLE 3/8" NIPPLE

• 300 PSI



PART #	DESCRIPTION	UNIT ORDER	INN/MAS	PACK	LIST
78306	3/8" x Close	25	25/600	BULK	0.94
78307	3/8" x 1-1/2"	25	25/600	BULK	1.00
78308	3/8" x 2"	25	25/600	BULK	1.00
78479	3/8" x 2-1/2"	25	25/400	BULK	1.34
78309	3/8" x 3"	25	25/400	BULK	1.37
78480	3/8" x 3-1/2"	25	25/400	BULK	1.54
78310	3/8" x 4"	25	25/300	BULK	1.63
78311	3/8" x 4-1/2"	25	25/300	BULK	2.14
78312	3/8" x 5"	25	25/300	BULK	2.22
78313	3/8" x 6"	25	25/200	BULK	2.45
78314	3/8" x 8"	25	25/150	BULK	4.31
78315	3/8" x 12"	25	25/100	BULK	5.50

### BLACK MALLEABLE 1/2" NIPPLE

• 300 PSI



PART #	DESCRIPTION	UNIT ORDER	INN/MAS	PACK	LIST
78316	1/2" x Close	25	25/600	BULK	0.77
78317	1/2" x 1-1/2"	25	25/600	BULK	0.83
78318	1/2" x 2"	25	25/600	BULK	0.86
78319	1/2" x 2-1/2"	25	25/400	BULK	1.00
78320	1/2" x 3"	25	25/400	BULK	1.03
78321	1/2" x 3-1/2"	25	25/300	BULK	1.23
78322	1/2" x 4"	25	25/300	BULK	1.31
78323	1/2" x 4-1/2"	25	25/200	BULK	1.40
78324	1/2" x 5"	25	25/200	BULK	1.54
78325	1/2" x 5-1/2"	25	25/200	BULK	1.60
78326	1/2" x 6"	25	25/200	BULK	1.74
78328	1/2" x 8"	25	25/100	BULK	2.68
78329	1/2" x 9"	25	25/100	BULK	3.02
78330	1/2" x 10"	25	25/75	BULK	3.02
78331	1/2" x 12"	25	25/75	BULK	3.59

### BLACK MALLEABLE 3/4" NIPPLE

• 300 PSI



PART #	DESCRIPTION	UNIT ORDER	INN/MAS	PACK	LIST
78332	3/4" x Close	25	25/400	BULK	0.88
78333	3/4" x 1-1/2"	25	25/400	BULK	0.91
78334	3/4" x 2"	25	25/300	BULK	0.91
78335	3/4" x 2-1/2"	25	25/300	BULK	1.14
78336	3/4" x 3"	25	25/200	BULK	1.20
78337	3/4" x 3-1/2"	25	25/200	BULK	1.31
78338	3/4" x 4"	25	25/150	BULK	1.37
78339	3/4" x 4-1/2"	25	25/150	BULK	1.63
78340	3/4" x 5"	25	25/100	BULK	1.68
78341	3/4" x 5-1/2"	25	25/100	BULK	1.85
78342	3/4" x 6"	25	25/100	BULK	1.91
78343	3/4" x 8"	25	25/75	BULK	3.08
78344	3/4" x 9"	25	25/75	BULK	3.59
78345	3/4" x 10"	25	25/50	BULK	3.59
78346	3/4" x 12"	25	25/50	BULK	3.99

### BLACK MALLEABLE 1" NIPPLE

• 300 PSI



PART #	DESCRIPTION	UNIT ORDER	INN/MAS	PACK	LIST
78347	1" x Close	25	25/300	BULK	1.25
78348	1" x 2"	25	25/200	BULK	1.37
78349	1" x 2-1/2"	25	25/200	BULK	1.45
78350	1" x 3"	25	25/150	BULK	1.60
78351	1" x 3-1/2"	25	25/150	BULK	1.82
78352	1" x 4"	25	25/100	BULK	1.91
78353	1" x 4-1/2"	25	25/100	BULK	2.17
78354	1" x 5"	25	25/100	BULK	2.22
78355	1" x 5-1/2"	25	25/75	BULK	2.57
78356	1" x 6"	25	25/75	BULK	2.65
78357	1" x 8"	25	25/50	BULK	4.11
78358	1" x 10"	25	25/50	BULK	4.82
78359	1" x 12"	25	25/50	BULK	5.50

### BLACK MALLEABLE 1-1/4" NIPPLE

• 300 PSI



PART #	DESCRIPTION	UNIT ORDER	INN/MAS	PACK	LIST
78360	1-1/4" x Close	25	25/150	BULK	1.63
78361	1-1/4" x 2"	25	25/150	BULK	1.82
78482	1-1/4" x 2-1/2"	25	25/150	BULK	1.94
78362	1-1/4" x 3"	25	25/100	BULK	1.94
78483	1-1/4" x 3-1/2"	25	25/100	BULK	2.28
78363	1-1/4" x 4"	25	25/100	BULK	2.28
78484	1-1/4" x 4-1/2"	25	25/75	BULK	2.79
78364	1-1/4" x 5"	25	25/75	BULK	2.82
78485	1-1/4" x 5-1/2"	25	25/75	BULK	3.28
78365	1-1/4" x 6"	25	25/50	BULK	3.22
78366	1-1/4" x 8"	25	25/50	BULK	5.19
78367	1-1/4" x 10"	10	-/40	BULK	6.19
78368	1-1/4" x 12"	10	-/30	BULK	7.04

Supply Connectors

Stop Valves

Water Heater

Gas Connectors

Water Filtration

Sinks/Faucets

Tubular/Drainage

Faucet Repair

Bath Accessories

Pipe Fittings/Repair

Valves

Cements/Sealants

Tools/Safety

Toilet Repair

Appliance/HVAC

Hardware

Electrical

Index

# PIPE FITTINGS AND REPAIR

## Black Malleable Iron Fittings

### BLACK MALLEABLE 1-1/2" NIPPLE

- 300 PSI



PART #	DESCRIPTION	UNIT ORDER	INN/MAS	PACK	LIST
78369	1-1/2" x Close	25	25/100	BULK	2.00
78370	1-1/2" x 2"	25	25/75	BULK	2.14
78486	1-1/2" x 2-1/2"	25	25/75	BULK	2.45
78371	1-1/2" x 3"	25	25/50	BULK	2.45
78487	1-1/2" x 3-1/2"	25	25/50	BULK	2.74
78372	1-1/2" x 4"	25	25/50	BULK	2.71
78488	1-1/2" x 4-1/2"	25	25/50	BULK	3.34
78373	1-1/2" x 5"	25	25/50	BULK	3.36
78489	1-1/2" x 5-1/2"	10	-/50	BULK	3.82
78374	1-1/2" x 6"	10	-/50	BULK	3.82
78490	1-1/2" x 8"	10	-/40	BULK	6.04
78491	1-1/2" x 10"	10	-/30	BULK	7.10
78492	1-1/2" x 12"	10	-/30	BULK	8.18

### BLACK MALLEABLE 2" NIPPLE

- 300 PSI



PART #	DESCRIPTION	UNIT ORDER	INN/MAS	PACK	LIST
78375	2" x Close	25	25/75	BULK	2.71
78376	2" x 2-1/2"	25	25/50	BULK	3.08
78377	2" x 3"	25	25/50	BULK	3.08
78493	2" x 3-1/2"	10	-/30	BULK	3.82
78378	2" x 4"	10	-/40	BULK	3.82
78494	2" x 4-1/2"	10	-/30	BULK	4.39
78379	2" x 5"	10	-/40	BULK	4.48
78495	2" x 5-1/2"	10	-/30	BULK	5.16
78380	2" x 6"	10	-/30	BULK	5.19
78381	2" x 8"	10	-/20	BULK	8.44
78496	2" x 10"	10	-/20	BULK	10.12
78382	2" x 12"	5	-/15	BULK	11.40

### BLACK MALLEABLE NIPPLE KIT

- Comes with heavy-duty cardboard nipple caddy
- Assorted 66-piece kit



PART #	DESCRIPTION	UNIT ORDER	INN/MAS	PACK	LIST
78498	1/2" Black Nipple Kit	1	-/1	BOX	87.87
78497	3/4" Black Nipple Kit	1	-/1	BOX	101.19

## COMBINATION 1/2" & 3/4" NIPPLE CADDY

- Made from high-density polyethylene plastic
- Quick-reference ruler laid out on tray
- Slots for teflon tape and pipe dope
- Drain holes for nipples



PART #	DESCRIPTION	UNIT ORDER	INN/MAS	PACK	LIST
81016	Combination 1/2" & 3/4" Nipple Caddy	1	-/5	BOX	55.20

## DARK CUTTING OIL

**NEW**

- Formulated to work on high-speed machines
- Ideal for stripping, broaching, or milling applications
- Anti-mist lubricant
- Quality of oil remains uniform at all times



PART #	DESCRIPTION	UNIT ORDER	INN/MAS	PACK	LIST
55190	1 Gallon	1	-/6	BOX	42.34

## Pipe Repair Couplings and Clamps

### COMPRESSION COUPLING - BRASS 3" SHORT-PATTERN

- 125 PSI
- Dual-size IPS and CTS



PART #	DESCRIPTION	UNIT ORDER	INN/MAS	PACK	LIST
20521LF	3/8" IPS and 1/2" CTS	1	24/120	BULK	10.12
20523LF	1/2" IPS and 3/4" CTS	1	12/120	BULK	13.97
20525LF	3/4" IPS and 1" CTS	1	12/72	BULK	23.52

### COMPRESSION COUPLING - BRASS 5" LONG-PATTERN

- 125 PSI
- Dual-size IPS and CTS



PART #	DESCRIPTION	UNIT ORDER	INN/MAS	PACK	LIST
20541LF	3/8" IPS and 1/2" CTS	1	12/144	BULK	13.91
20543LF	1/2" IPS and 3/4" CTS	1	12/120	BULK	19.16
20545LF	3/4" IPS and 1" CTS	1	12/48	BULK	31.11
20547LF	1" IPS and 1-1/4" CTS	1	12/48	BULK	33.87
20549LF	1-1/4" IPS and 1-1/2" CTS	1	3/48	BULK	47.05

## Pipe Repair Couplings and Clamps

### COMPRESSION COUPLING - GALVANIZED LONG-PATTERN

- 125 PSI



PART #	DESCRIPTION	UNIT ORDER	INN/MAS	PACK	LIST
20562	1/2" IPS x 3-7/8" Length	1	12/48	BULK	6.30
20564	3/4" IPS x 4-1/8" Length	1	12/48	BULK	7.59
20566	1" IPS x 4-3/8" Length	1	12/24	BULK	10.12
20568	1-1/4" IPS x 4-5/8" Length	1	6/24	BULK	15.75
20570	1-1/2" IPS x 5" Length	1	6/24	BULK	19.25
20572	2" IPS x 5-1/2" Length	1	-/12	BULK	22.97

### COMPRESSION COUPLING - PVC

- PVC schedule 40



PART #	DESCRIPTION	UNIT ORDER	INN/MAS	PACK	LIST
20583	1/2" IPS	1	-/100	BULK	2.05
20585	3/4" IPS	1	-/100	BULK	2.54
20587	1" IPS	1	-/100	BULK	3.28
20589	1-1/4" IPS	1	-/60	BULK	4.53
20591	1-1/2" IPS	1	-/60	BULK	6.50
20593	2" IPS	1	-/60	BULK	8.21
20597	3" IPS	1	-/10	BULK	26.09
20599	4" IPS	1	-/10	BULK	27.34

### COMPRESSION COUPLING - CPVC

- CPVC



PART #	DESCRIPTION	UNIT ORDER	INN/MAS	PACK	LIST
20607	1/2" CTS (5/8" OD)	1	20/360	BULK	4.28
20609	3/4" CTS (7/8" OD)	1	20/240	BULK	5.57

### TELESCOPING REPAIR COUPLING - PVC

- Schedule 40
- 150 PSI pressure rated in all positions
- Complies with ASTM & ANSI standards
- One-piece cylinder
- Internal high-quality, self-lubricating EPDM O-ring



PART #	DESCRIPTION	UNIT ORDER	INN/MAS	PACK	LIST
86051	1/2" Slip x Spigot	1	-/30	BULK	6.87
86052	3/4" Slip x Spigot	1	-/24	BULK	6.56
86053	1" Slip x Spigot	1	-/18	BULK	7.57
86055	1-1/4" Slip x Spigot	1	-/12	BULK	13.45
86054	1-1/2" Slip x Spigot	1	-/12	BULK	16.62
86056	2" Slip x Spigot	1	-/8	BULK	20.27

### PIPE REPAIR CLAMP - 3" LONG

- 301 Stainless steel shield
- Galvanized malleable iron lugs
- Plated long-neck carriage bolt & nut
- High content neoprene gasket



PART #	DESCRIPTION	UNIT ORDER	INN/MAS	PACK	LIST
45181	1/2" IPS	1	10/100	BULK	7.41
45183	3/4" IPS	1	10/100	BULK	8.15
45185	1" IPS	1	10/100	BULK	8.84
45187	1-1/4" IPS	1	10/50	BULK	9.29
45189	1-1/2" IPS	1	10/50	BULK	12.52
45191	2" IPS	1	10/50	BULK	14.00

### FLEXIBLE COUPLING

- Stainless steel clamps
- For cast-iron, plastic, copper and steel pipes



PART #	DESCRIPTION	UNIT ORDER	INN/MAS	PACK	LIST
86000	1-1/4" x 1-1/4"	1	-/100	BULK	4.13
86085	1-1/2" x 1-1/4" - NEW!	1	-/50	BULK	4.45
86001	1-1/2" x 1-1/2"	1	-/100	BULK	4.48
86002	2" x 1-1/2"	1	-/100	BULK	5.25
86003	2" x 2"	1	-/100	BULK	5.02
86086	3" x 1-1/2" - NEW!	1	-/20	BULK	8.27
86004	3" x 2"	1	-/80	BULK	8.70
86005	3" x 3"	1	-/80	BULK	7.13
86087	4" x 1-1/2" - NEW!	1	-/20	BULK	9.95
86088	4" x 2" - NEW!	1	-/20	BULK	9.21
86006	4" x 3"	1	-/60	BULK	11.01
86007	4" x 4"	1	-/60	BULK	8.92
86008	6" x 4"	1	-/20	BULK	21.81
86009	6" x 6"	1	-/20	BULK	21.04

### FLEXIBLE COUPLING

- Stainless steel clamps
- For clay to cast-iron, copper, steel or lead pipes



PART #	DESCRIPTION	UNIT ORDER	INN/MAS	PACK	LIST
86094	4" x 3" - NEW!	1	-/20	BULK	9.93
86010	4" x 4"	1	-/60	BULK	9.67
86011	6" x 4"	1	-/20	BULK	23.12
86096	6" x 6" - NEW!	1	-/20	BULK	24.24

Supply Connectors

Stop Valves

Water Heater

Gas Connectors

Water Filtration

Sinks/Faucets

Tubular/Drainage

Faucet Repair

Bath Accessories

Pipe Fittings/Repair

Valves

Cements/Sealants

Tools/Safety

Toilet Repair

Appliance/HVAC

Hardware

Electrical

Index

# PIPE FITTINGS AND REPAIR

## Pipe Repair Couplings and Clamps

### DRAIN AND TRAP CONNECTOR

- Stainless steel clamps
- Connects PVC DWV to under sink tubular



PART #	DESCRIPTION	UNIT ORDER	INN/MAS	PACK	LIST
86012	1-1/2" x 1-1/2" or 1-1/4"	1	-/100	BULK	3.51
86013	2" x 1-1/2" or 1-1/4"	1	-/100	BULK	4.48

### TUBULAR DRAIN CONNECTOR

- Stainless steel clamps
- Connects tubular to tubular



PART #	DESCRIPTION	UNIT ORDER	INN/MAS	PACK	LIST
86014	1-1/2" x 1-1/4"	1	-/100	BULK	3.51

### FLEXIBLE 90° ELBOW

- Stainless steel clamps
- For cast-iron, plastic, copper, steel or lead to cast-iron, plastic, copper, steel or lead pipes



PART #	DESCRIPTION	UNIT ORDER	INN/MAS	PACK	LIST
86062	1-1/2"	1	-/10	BULK	8.92
86162	2" - <b>NEW!</b>	1	-/20	BULK	7.53
86163	3" - <b>NEW!</b>	1	-/20	BULK	14.04
86164	4" - <b>NEW!</b>	1	-/6	BULK	22.70

### FLEXIBLE J-TRAP

- Stainless steel clamps
- Flexible to adjust to misaligned pipes
- Can be cut down for 1-1/2" sink drain



PART #	DESCRIPTION	UNIT ORDER	INN/MAS	PACK	LIST
86061	1-1/4" or 1-1/2"	1	-/30	BULK	8.81

### FLEXIBLE TEE

- Stainless steel clamps
- For cast-iron, plastic, copper, steel or lead to cast-iron, plastic, copper, steel or lead pipes



PART #	DESCRIPTION	UNIT ORDER	INN/MAS	PACK	LIST
86063	1-1/2"	1	-/10	BULK	10.92
86152	2" - <b>NEW!</b>	1	-/20	BULK	8.94
86153	3" - <b>NEW!</b>	1	-/20	BULK	17.11
86154	4" - <b>NEW!</b>	1	-/6	BULK	28.54

### HOSE GRIPPER

- Stainless steel clamp
- Secure washing machine hoses in standpipe



PART #	DESCRIPTION	UNIT ORDER	INN/MAS	PACK	LIST
86175	1-1/2" or 2" Standard Laundry Standpipe	1	-/40	BULK	3.74

### NO-HUB COUPLING

- Stainless steel band & clamps
- For use in joining hubless cast-iron soil pipe and fittings in drainage, waste and vent systems
- Complies with ASTM C1277



PART #	DESCRIPTION	UNIT ORDER	INN/MAS	PACK	LIST
43401	1-1/2"	1	-/100	BULK	4.13
43417	2" x 1-1/2"	1	-/100	BULK	5.27
43403	2"	1	-/100	BULK	4.48
43404	3" x 2"	1	-/100	BULK	10.52
43405	3"	1	-/100	BULK	4.91
43419	4" x 2"	1	-/50	BULK	13.30
43421	4" x 3"	1	-/50	BULK	12.12
43407	4"	1	-/100	BULK	6.42
43411	6"	1	-/30	BULK	14.68

## Pipe Repair Couplings and Clamps

### SHIELDED COUPLING

- Stainless steel band and clamps
- For cast-iron or plastic to cast-iron or plastic pipes
- Complies with ATSM C1460 and CSA B602



PART #	DESCRIPTION	UNIT ORDER	INN/MAS	PACK	LIST
86064	1-1/2"	1	-/100	BULK	<b>4.72</b>
86065	2"	1	-/100	BULK	<b>5.13</b>
86066	3"	1	-/100	BULK	<b>6.19</b>
86067	4"	1	-/100	BULK	<b>7.65</b>

## Test Caps and Plugs

### TEST CAP

- Stainless steel clamp



PART #	DESCRIPTION	UNIT ORDER	INN/MAS	PACK	LIST
43451	1-1/2"	1	-/100	BULK	<b>2.77</b>
43453	2"	1	-/100	BULK	<b>2.99</b>
43455	3"	1	-/100	BULK	<b>4.08</b>
43457	4"	1	-/100	BULK	<b>3.95</b>

### TECHNO TEST CAP

- Heavy-duty PVC high-pressure test cap
- Can be used for water or air test
- Solvent welds on the end of DWV pipe



PART #	DESCRIPTION	UNIT ORDER	INN/MAS	PACK	LIST
43477	1-1/2"	1	100/800	BAG	<b>0.83</b>
43478	2"	1	100/600	BAG	<b>0.88</b>
43479	3"	1	50/250	BAG	<b>1.11</b>
43480	4"	1	25/150	BAG	<b>1.23</b>

### DEEP TECHNO TEST CAP

- Extra deep solvent weld socket provides room for errors on pipe that is not cut straight
- Offers an economical solution to heavy-duty PVC or ABS schedule 40 DWV end caps
- Tested to 5 stories of head pressure (22 PSIG)
- Safer than flexible and metal wing nut caps on multi-story



PART #	DESCRIPTION	UNIT ORDER	INN/MAS	PACK	LIST
43481	1-1/2"	1	50/800	BAG	<b>0.86</b>
43482	2"	1	50/600	BAG	<b>1.51</b>
43483	3"	1	25/250	BAG	<b>1.51</b>
43484	4"	1	25/150	BAG	<b>2.20</b>

## PNEUMATIC CLEANOUT TEST PLUG

- Made from a durable natural rubber compound
- Designed for testing of pipelines above the cleanout tee
- Will allow for passing of the test water or air by deflating the plug
- The poly head on each plug has finger tabs for turning and a hex for tightening



PART #	DESCRIPTION	UNIT ORDER	INN/MAS	PACK	LIST
78021	1-1/2"	1	-/12	BAG	<b>51.15</b>
78023	2"	1	-/12	BAG	<b>59.11</b>
78025	3"	1	-/12	BAG	<b>64.21</b>
78027	4"	1	-/12	BAG	<b>74.53</b>

## PNEUMATIC TEST PLUG

- Made from a durable natural rubber compound
- Designed for testing of pipeline or to temporarily stop the flow
- Comes with a 12" chain and ring assembly attached to a molded inflation valve



PART #	DESCRIPTION	UNIT ORDER	INN/MAS	PACK	LIST
78000	1-1/2"	1	-/12	BULK	<b>46.22</b>
78001	2"	1	-/12	BULK	<b>49.67</b>
78002	3"	1	-/12	BULK	<b>53.80</b>
78803	4"	1	-/12	BULK	<b>62.21</b>

## TWIST-TITE MECHANICAL TEST PLUG

- Designed to be a temporary or permanent plug for pipe
- Die-cast wing nut and nylon washer provide for easy tightening
- The "ramp" style expansion surface between the top and bottom help the plug seal effectively in a small area



PART #	DESCRIPTION	UNIT ORDER	INN/MAS	PACK	LIST
78032	1-1/2"	1	-/10	BAG	<b>7.13</b>
78033	2"	1	-/10	BAG	<b>8.24</b>
78034	3"	1	-/10	BAG	<b>11.01</b>
78035	4"	1	-/10	BAG	<b>13.54</b>

Supply Connectors

Stop Valves

Water Heater

Gas Connectors

Water Filtration

Sinks/Faucets

Tubular/Drainage

Faucet Repair

Bath Accessories

Pipe Fittings/Repair

Valves

Cements/Sealants

Tools/Safety

Toilet Repair

Appliance/HVAC

Hardware

Electrical

Index

# PIPE FITTINGS AND REPAIR

## Test Caps and Plugs

### MECHANICAL TEST PLUG

- Galvanized steel flange with rubber gasket



PART #	DESCRIPTION	UNIT ORDER	INN/MAS	PACK	LIST
43431	1-1/2"	1	10/200	BULK	1.85
43433	2"	1	10/100	BULK	2.28
43435	3"	1	10/60	BULK	3.91
43437	4"	1	10/40	BULK	4.70

### T-CONE TEST PLUG

- Rustproof and reusable
- Test up to 50 feet of head pressure



PART #	DESCRIPTION	UNIT ORDER	INN/MAS	PACK	LIST
86017	Tests 1-1/2" Sch. 40 DWV	50	-/50	BULK	6.02
86018	Tests 2" Sch. 40 DWV & Type M Copper Tube	50	-/50	BULK	6.50
86019	Tests 3" Sch. 40 & Copper DWV - 2" Cast-Iron Hub	10	-/10	BULK	8.01
86020	Test 4" Sch. 40 & Copper DWV, SW, Cast-Iron & VCP Barrel - 3" Cast-Iron Hub	10	-/10	BULK	13.40

### NO-HUB TORQUE WRENCH

- 5/16" Hex socket for tightening nut or worm drive clamps, no-hub coupling or test cap
- 60 lb pressure release



PART #	DESCRIPTION	UNIT ORDER	INN/MAS	PACK	LIST
45061	Reverse Lever	1	10/100	BULK	18.53

## Tubing and Hoses

### CLEAR VINYL TUBING - BULK

- Clear, nontoxic material
- Great for low-pressure applications
- Not recommended for icemakers
- Handles a wide variety of chemicals, gases and liquids
- Priced and sold per foot



**NEW**



PART #	DESCRIPTION	UNIT ORDER	INN/MAS	PACK	LIST
98561	.17" ID (1/4" OD)	150 ft.	-/150	ROLL	0.17
98564	1/4" ID (3/8" OD)	100 ft.	-/100	ROLL	0.34
98565	5/16" ID (7/16" OD)	100 ft.	-/100	ROLL	0.34
98567	3/8" ID (1/2" OD)	100 ft.	-/100	ROLL	0.40
98569	1/2" ID (5/8" OD)	100 ft.	-/100	ROLL	0.51
98571	5/8" ID (3/4" OD)	50 ft.	-/50	ROLL	0.68
98572	3/4" ID (1" OD)	50 ft.	-/50	ROLL	1.48
98573	1" ID (1-1/4" OD)	30 ft.	-/30	ROLL	1.68
98574	1-1/4" ID (1-5/8" OD)	25 ft.	-/25	ROLL	3.11

### CLEAR VINYL TUBING - PRECUT

**NEW**

- Clear, nontoxic material
- Great for low-pressure applications
- Not recommended for icemakers
- Handles a wide variety of chemicals, gases and liquids



PART #	DESCRIPTION	UNIT ORDER	INN/MAS	PACK	LIST
98615	.17" ID (1/4" OD) x 10'	20	-/20	ROLL	2.25
98617	1/4" ID (3/8" OD) x 10'	20	-/20	ROLL	3.71
98620	3/8" ID (1/2" OD) x 10'	10	-/10	ROLL	4.25
98568	1/2" ID (5/8" OD) x 10'	10	-/10	ROLL	5.47
98570	5/8" ID (3/4" OD) x 10'	8	-/8	ROLL	6.90
98624	3/4" ID (1" OD) x 10'	8	-/8	ROLL	15.62
98560	.17" ID (1/4" OD) x 20'	10	-/10	ROLL	4.13
98562	3/16" ID (5/16" OD) x 20'	10	-/10	ROLL	5.84
98563	1/4" ID (3/8" OD) x 20'	10	-/10	ROLL	6.70
98619	5/16" ID (7/16" OD) x 20'	10	-/10	ROLL	7.56
98566	3/8" ID (1/2" OD) x 20'	10	-/10	ROLL	7.98
98622	1/2" ID (5/8" OD) x 20'	5	-/5	ROLL	10.41
98623	1/2" ID (5/8" OD) x 50'	1	-/1	ROLL	25.60
98618	1/4" ID (3/8" OD) x 100'	4	-/4	ROLL	34.10
98621	3/8" ID (1/2" OD) x 100'	4	-/4	ROLL	39.83
98616	.17" ID (1/4" OD) x 150'	4	-/4	ROLL	26.94

### REINFORCED BRAIDED VINYL TUBING - BULK

**NEW**

- Clear, nontoxic material
- Kink-resistant heavy wall
- Polyester-braid reinforced PVC
- Great choice for hydraulic, pneumatic and vacuum lines
- Priced and sold per foot



PART #	DESCRIPTION	UNIT ORDER	INN/MAS	PACK	LIST
98575	3/8" ID (5/8" OD)	100 ft.	-/100	ROLL	0.83
98576	1/2" ID (3/4" OD)	50 ft.	-/50	ROLL	1.20
98577	5/8" ID (7/8" OD)	50 ft.	-/50	ROLL	1.51
98578	3/4" ID (1" OD)	50 ft.	-/50	ROLL	1.82
98579	1" ID (1-1/4" OD)	25 ft.	-/25	ROLL	2.79
98580	1-1/2" ID (2" OD)	25 ft.	-/25	ROLL	4.33



## Tubing and Hoses

### REINFORCED BRAIDED VINYL TUBING - PRECUT

**NEW**

- Clear, nontoxic material
- Kink-resistant heavy wall
- Polyester-braid reinforced PVC
- Great choice for hydraulic, pneumatic and vacuum lines



PART #	DESCRIPTION	UNIT ORDER	INN/MAS	PACK	LIST
98631	2" ID (2-1/2" OD) x 2'	6	-/6	BOX	16.91
98626	3/8" ID (5/8" OD) x 10'	10	-/10	BOX	8.70
98628	1/2" ID (3/4" OD) x 10'	10	-/10	BOX	12.32
98629	5/8" ID (7/8" OD) x 10'	10	-/10	BOX	15.45
98630	3/4" ID (1" OD) x 10'	5	-/5	BOX	18.59
98625	1/4" ID (1/2" OD) x 20'	10	-/10	BOX	17.02
98627	3/8" ID (5/8" OD) x 20'	5	-/5	BOX	16.68

### POLYETHYLENE TUBING - BULK

**NEW**

- Nontoxic material
- Lightweight, semi-rigid tubing
- Strong resistance to chemicals, corrosion and impact
- Great choice for air and water lines
- Priced and sold per foot



PART #	DESCRIPTION	UNIT ORDER	INN/MAS	PACK	LIST
98582	1/4" OD	150 ft.	-/150	ROLL	0.20
98585	3/8" OD	100 ft.	-/100	ROLL	0.31
98586	1/2" OD	100 ft.	-/100	ROLL	0.37

### POLYETHYLENE TUBING - PRECUT

**NEW**

- Nontoxic material
- Lightweight, semi-rigid tubing
- Strong resistance to chemicals, corrosion and impact
- Great choice for air and water lines



PART #	DESCRIPTION	UNIT ORDER	INN/MAS	PACK	LIST
98583	5/16" OD x 10'	5	-/5	BOX	4.22
98581	1/4" OD x 25'	10	-/10	BOX	5.65
98584	3/8" OD x 25'	10	-/10	BOX	8.70
98634	1/2" OD x 25'	8	-/8	BOX	9.89
98633	3/8" OD x 100'	4	-/4	BOX	31.25
98635	1/2" OD x 100'	4	-/4	BOX	37.01
98632	1/4" OD x 150'	4	-/4	BOX	28.43

### LATEX TUBING - PRECUT

**NEW**

- Latex construction
- Smooth natural latex
- Flexible in low temperatures
- Designed for elastic bands, tourniquets and shock absorbers



PART #	DESCRIPTION	UNIT ORDER	INN/MAS	PACK	LIST
98598	1/4" ID x 10'	5	-/5	BOX	21.53

### BILGE DISCHARGE HOSE - PRECUT

**NEW**

- PVC construction
- Lightweight, corrugated hose
- High resistance to abrasions and kinks
- Suitable for marine and low-pressure water discharge



PART #	DESCRIPTION	UNIT ORDER	INN/MAS	PACK	LIST
98587	1-1/4" ID x 6'	3	-/3	BOX	20.50

### FLAT DISCHARGE HOSE - BULK

**NEW**

- PVC construction
- Easy to store, lays flat
- Flexible and durable
- Great choice for agriculture, drip irrigation or drainage
- Priced and sold per foot



PART #	DESCRIPTION	UNIT ORDER	INN/MAS	PACK	LIST
98588	1-1/2" ID	100 ft.	-/100	ROLL	0.91
98589	2" ID	100 ft.	-/100	ROLL	1.20

### FLAT DISCHARGE HOSE - PRECUT

**NEW**

- PVC construction
- Easy to store, lays flat
- Flexible and durable
- Great choice for agriculture, drip irrigation or drainage



PART #	DESCRIPTION	UNIT ORDER	INN/MAS	PACK	LIST
98636	1-1/2" ID x 15'	6	-/6	BOX	14.17
98638	2" ID x 15'	6	-/6	BOX	18.36
98637	1-1/2" ID x 30'	6	-/6	BOX	27.43
98639	2" ID x 30'	6	-/6	BOX	36.07

Supply Connectors

Stop Valves

Water Heater

Gas Connectors

Water Filtration

Sinks/Faucets

Tubular/Drainage

Faucet Repair

Bath Accessories

Pipe Fittings/Repair

Valves

Cements/Sealants

Tools/Safety

Toilet Repair

Appliance/HVAC

Hardware

Electrical

Index

# PIPE FITTINGS AND REPAIR

## Tubing and Hoses

### HIGH-PRESSURE AIR HOSE - PRECUT

**NEW**

- PVC construction
- Reinforced for increased strength
- Ideal for high-temperature and high-pressure applications
- Designed for general air and water applications



PART #	DESCRIPTION	UNIT ORDER	INN/MAS	PACK	LIST
98593	3/8" ID x 10'	5	-/5	BOX	10.69
98594	1/2" ID x 10'	3	-/3	BOX	12.12

### AUTOMOTIVE HEATER HOSE - PRECUT

**NEW**

- Rubber construction
- High resistance to weather and heat
- Reinforced for increased strength and durability
- Designed for use with automotive coolant



PART #	DESCRIPTION	UNIT ORDER	INN/MAS	PACK	LIST
98592	7/8" ID x 2'	6	-/6	BOX	4.96
98590	5/8" ID x 10'	3	-/3	BOX	16.39
98591	3/4" ID x 10'	3	-/3	BOX	24.09

### FUEL HOSE - PRECUT

**NEW**

- Rubber construction
- Reinforced for increased strength
- High fitting retention
- Designed for use with petroleum based products



PART #	DESCRIPTION	UNIT ORDER	INN/MAS	PACK	LIST
98595	1/4" ID x 10'	5	-/5	BOX	10.69

### MICRO FUEL HOSE - PRECUT

**NEW**

- Extremely flexible and resilient
- Not easily flammable
- Resistant to oil, grease and fuels



PART #	DESCRIPTION	UNIT ORDER	INN/MAS	PACK	LIST
98640	3/32" ID (3/16" OD) x 10'	8	-/8	BOX	7.24
98641	1/8" ID (1/4" OD) x 10'	8	-/8	BOX	7.24

### POOL AND SPA VACUUM HOSE - BULK

**NEW**

- Polyethylene construction
- High resistance to abrasion and crushing
- Floats and is flexible
- Designed for pool, spa and vacuum applications
- Priced and sold per foot



PART #	DESCRIPTION	UNIT ORDER	INN/MAS	PACK	LIST
98596	1-1/2" ID	25	-/25	ROLL	3.28

### SPA HOSE - BULK

**NEW**

- Rigid PVC with spiral reinforcement
- Can be glued in to standard PVC fittings
- Designed for spas, jetted tubs and other open systems
- Priced and sold per foot



PART #	DESCRIPTION	UNIT ORDER	INN/MAS	PACK	LIST
98642	1" ID	25 ft.	-/25	ROLL	3.28
98643	1-1/4" ID	25 ft.	-/25	ROLL	3.62
98597	1-1/2" ID	25 ft.	-/25	ROLL	4.05

## Clamps, Supports and Hangers

### HOSE CLAMP - STAINLESS STEEL BAND

- Slotted 5/16" hex-head, zinc-plated, carbon steel screw



PART #	DESCRIPTION	UNIT ORDER	INN/MAS	PACK	LIST
43251	#4 - 7/32" to 5/8"	100	100/2000	BULK	0.48
43253	#6 - 7/16" to 25/32"	100	100/2000	BULK	0.48
43255	#8 - 1/2" to 29/32"	100	100/2000	BULK	0.48
43257	#10 - 9/16" to 1-1/16"	100	100/1000	BULK	0.57
43259	#12 - 11/16" to 1-1/4"	100	100/1000	BULK	0.54
43296	#12 - 11/16" to 1-1/4" 500 pk	500	-/500	BULK	246.69
43261	#16 - 13/16" to 1-1/2"	100	100/1000	BULK	0.57
43297	#16 - 13/16" to 1-1/2" 500 pk	500	-/500	BULK	246.69
43263	#20 - 13/16" to 1-3/4"	100	100/1000	BULK	0.60
43265	#24 - 1-1/16" to 2"	100	100/1000	BULK	0.71
43267	#28 - 1-5/16" to 2-1/4"	100	100/1000	BULK	0.80
43269	#32 - 1-9/16" to 2-1/2"	100	100/1000	BULK	0.83
43271	#36 - 1-13/16" to 2-3/4"	100	100/1000	BULK	0.86
43273	#40 - 2-1/16" to 3"	100	100/500	BULK	1.00
43277	#52 - 2-13/16" to 3-3/4"	100	100/500	BULK	1.05
43287	#72 - 4-1/8" to 5"	100	100/500	BULK	1.17
43295	#88 - 5-1/8" to 6"	100	100/500	BULK	1.40

## Clamps, Supports and Hangers

### HOSE CLAMP - STAINLESS STEEL BAND & SCREW

- Slotted 5/16" hex-head, stainless steel screw



PART #	DESCRIPTION	UNIT ORDER	INN/MAS	PACK	LIST
43301	#4 - 7/32" to 5/8"	100	100/2000	BULK	<b>0.83</b>
43305	#8 - 1/2" to 29/32"	100	100/2000	BULK	<b>0.68</b>
43307	#10 - 9/16" to 1-1/16"	100	100/1000	BULK	<b>1.05</b>
43309	#12 - 11/16" to 1-1/4"	100	100/1000	BULK	<b>0.83</b>
43311	#16 - 13/16" to 1-1/2"	100	100/1000	BULK	<b>0.96</b>
43313	#20 - 13/16" to 1-3/4"	100	100/1000	BULK	<b>0.98</b>
43315	#24 - 1-1/16" to 2"	100	100/1000	BULK	<b>1.14</b>
43317	#28 - 1-5/16" to 2-1/4"	100	100/1000	BULK	<b>1.20</b>
43335	#72 - 4-1/8" to 5"	100	100/500	BULK	<b>1.91</b>
43343	#88 - 5-1/8" to 6"	100	100/500	BULK	<b>1.94</b>

### SAFETY PLATE - 20-GAUGE

- Also known as stud protectors - notched plated
- **Sold per box of 100**
- Galvanized



PART #	DESCRIPTION	UNIT ORDER	INN/MAS	PACK	LIST
43061	1-1/2" x 3"	100	-/100	BULK	<b>17.25</b>

### SAFETY PLATE - 18-GAUGE

- Triangle points
- **Priced each & sold per box of 100**
- Galvanized



PART #	DESCRIPTION	UNIT ORDER	INN/MAS	PACK	LIST
85071	1-1/2" x 3"	100	-/100	BULK	<b>0.26</b>
85073	1-1/2" x 6"	100	-/100	BULK	<b>0.43</b>

### SAFETY PLATE - 16-GAUGE

- 16-Hole
- **Priced each & sold per box of 50**
- Galvanized



PART #	DESCRIPTION	UNIT ORDER	INN/MAS	PACK	LIST
85043	3" x 18"	1	-/25	BOX	<b>63.13</b>
85045	5" x 18"	1	-/25	BOX	<b>97.77</b>

### NAIL PLATE - 18-GAUGE

- 8-Hole
- **Priced each & sold per box of 50**
- Galvanized



PART #	DESCRIPTION	UNIT ORDER	INN/MAS	PACK	LIST
85040	9" x 1-1/2"	1	-/50	BOX	<b>49.18</b>

### NAIL PLATE - 16-GAUGE

- 6-Hole
- **Priced each & sold per box of 50**
- Galvanized



PART #	DESCRIPTION	UNIT ORDER	INN/MAS	PACK	LIST
85041	5" x 8"	1	-/50	BOX	<b>92.66</b>

### STUD GUARD - 16-GAUGE

- Self-nailing
- **Priced each & sold per box of 50**
- Galvanized



PART #	DESCRIPTION	UNIT ORDER	INN/MAS	PACK	LIST
85048	3-1/2" x 6"	1	-/50	BOX	<b>55.60</b>

### STUD SUPPORT SHOE

- Galvanized
- 18-Gauge
- 2-1/2" Pipe opening



PART #	DESCRIPTION	UNIT ORDER	INN/MAS	PACK	LIST
85056	Single 5-1/2" W x 3-1/4" H x 1-1/4" D	1	-/25	BULK	<b>2.88</b>
85057	Double 5-1/2" W x 3-1/4" H x 3-1/8" D	1	-/25	BULK	<b>3.56</b>
85058	Triple 5-1/2" W x 3-1/4" H x 4-5/8" D	1	-/10	BULK	<b>4.25</b>

### SINGLE-SHOT PIPE HANGER

- Use on a metal stud, hang from a joint or guide through a hole
- Preloaded nail
- Copper safe copolymer
- **Priced each & sold per box of 50**



PART #	DESCRIPTION	UNIT ORDER	INN/MAS	PACK	LIST
85111	1/2"	50	50/1000	BOX	<b>0.43</b>
85112	3/4"	50	50/1000	BOX	<b>0.51</b>

Supply Connectors

Stop Valves

Water Heater

Gas Connectors

Water Filtration

Sinks/ Faucets

Tubular/ Drainage

Faucet Repair

Bath Accessories

Pipe Fittings/ Repair

Valves

Cements/ Sealants

Tools/ Safety

Toilet Repair

Appliance/ HVAC

Hardware

Electrical

Index

# PIPE FITTINGS AND REPAIR

## Clamps, Supports and Hangers

### TUBE TALON™ MULTIFUNCTIONAL PIPE CLAMP

- Preloaded ring-shank nails ensure a permanent hold
- Absorbs vibration
- Tube is not damaged if nail is overdriven
- Install in alternating directions to ensure secure piping
- Compatible with copper, PEX and CPVC
- Priced each and sold per bag of 100

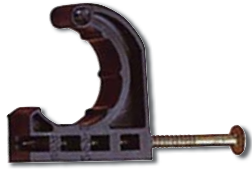

PART #	DESCRIPTION	UNIT ORDER	INN/MAS	PACK	LIST
85113	1/2"	100	-/1000	BULK	0.23
85114	3/4"	100	-/1000	BULK	0.40

### HALF PIPE CLAMP

- Standard plastic half clamp
- Preloaded nail
- Not recommended for CPVC



PART #	DESCRIPTION	UNIT ORDER	INN/MAS	PACK	LIST
85123	1/2"	50	50/1000	BULK	0.14
85124	3/4"	100	100/1000	BULK	0.20
85125	1"	50	50/600	BULK	0.26

### PIPE HANGER STRAPPING - PLASTIC

- 16-Gauge



PART #	DESCRIPTION	UNIT ORDER	INN/MAS	PACK	LIST
85092	100' Roll	1	-/10	BOX	11.40

### PIPE HANGER STRAPPING

- 3/4"
- Perforated hanger
- Galvanized



Alternating Nail & Bolt Holes

PART #	DESCRIPTION	UNIT ORDER	INN/MAS	PACK	LIST
43017	10' - 22-Gauge	1	-/50	BULK	3.34
43015	10' - 24-Gauge	1	-/100	BULK	2.57
43013	10' - 26-Gauge	1	-/100	BULK	2.28
43011	10' - 28-Gauge	1	-/50	BULK	1.88
85076	100' - 28-Gauge	1	-/5	BULK	16.82

### PIPE HANGER STRAPPING

- 3/4" - 20-Gauge
- 1/4" Bolt holes
- Galvanized

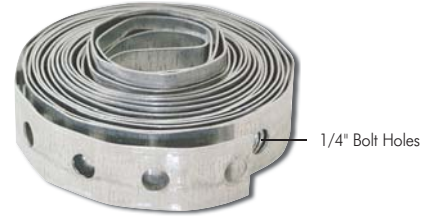

PART #	DESCRIPTION	UNIT ORDER	INN/MAS	PACK	LIST
85077	10'	1	-/25	BULK	3.16
85079	100'	1	-/5	BULK	29.94

### COPPER-CLAD PIPE HANGER STRAPPING

- 22-Gauge
- Copper



PART #	DESCRIPTION	UNIT ORDER	INN/MAS	PACK	LIST
85080	3/4" x 10'	1	-/50	BULK	6.02

### ZIPSTICK™ UNIVERSAL PIPE HANGER

- Universal cradle hangs any pipe from 1" CTS to 6" IPS
- Releasable locking mechanism
- Graduated numerals at nail ways for easy measuring



PART #	DESCRIPTION	UNIT ORDER	INN/MAS	PACK	LIST
85081	14" White	100	-/100	BULK	4.90
85082	26" White	50	-/50	BULK	7.78
85088	14" Black	100	-/100	BULK	4.90
85089	26" Black	50	-/50	BULK	7.90

### PIPE HANGER - PLASTIC-COATED



PART #	DESCRIPTION	UNIT ORDER	INN/MAS	PACK	LIST
85035	1-1/2"	1	-/50	BOX	3.31
85036	2"	1	-/50	BOX	3.56
85037	3"	1	-/50	BOX	3.85
85038	4"	1	-/25	BOX	4.31

## Clamps, Supports and Hangers

### 2-HOLE PIPE CLAMP

- Plastic 2-hole pipe clamps
- Isolates supply tubing from wood framing



PART #	DESCRIPTION	UNIT ORDER	INN/MAS	PACK	LIST
85120	1/2"	100	100/1000	BULK	0.11
85121	3/4"	100	100/1000	BULK	0.20

### INSULATING SUSPENSION CLAMP

- Plastic suspension clamps
- Isolates supply tubing from wood framing



PART #	DESCRIPTION	UNIT ORDER	INN/MAS	PACK	LIST
85115	1/2"	100	100/2000	BULK	0.26
85116	3/4"	100	100/1000	BULK	0.26

### PIPE INSULATOR

- Plastic pipe insulators
- Isolates supply tubing from wood framing



PART #	DESCRIPTION	UNIT ORDER	INN/MAS	PACK	LIST
85117	1/2"	25	-/100	BULK	0.37
85118	3/4"	25	50/200	BULK	0.26
85119	1"	25	25/1000	BULK	0.26

### GALVANIZED PIPE STRAPS

- 2-Ear
- IPS



PART #	DESCRIPTION	UNIT ORDER	INN/MAS	PACK	LIST
43021	1/2"	100	-/100	BULK	0.14
43023	3/4"	100	-/100	BULK	0.20
43025	1"	50	-/50	BULK	0.40
43027	1-1/4"	50	-/50	BULK	0.57
43029	1-1/2"	50	-/50	BULK	0.74
43031	2"	50	-/50	BULK	1.00
43035	3"	25	-/25	BULK	2.40
43039	4"	25	-/25	BULK	3.82

### COPPER-CLAD TUBE STRAPS

- 2-Ear
- IPS
- Sold per bag of 100 - priced each



PART #	DESCRIPTION	UNIT ORDER	INN/MAS	PACK	LIST
43022	1/2" IPS (5/8" OD)	100	100/1000	BULK	0.40
43024	3/4" IPS (7/8" OD)	100	100/1000	BULK	0.51

### COPPER-CLAD TUBE STRAPS

- 2-Ear
- Copper pipe size
- Sold per bag of 100 - priced each



PART #	DESCRIPTION	UNIT ORDER	INN/MAS	PACK	LIST
85026	1/4"	100	100/2000	BULK	0.11
85027	3/8"	100	100/2000	BULK	0.11
85028	1/2"	100	100/2000	BULK	0.09
85030	3/4"	100	100/1000	BULK	0.14
85031	1"	100	100/1000	BULK	0.20
85033	1-1/2"	100	-/100	BULK	0.34
85034	2"	100	-/100	BULK	0.48

### RISER CLAMP

- IPS



PART #	DESCRIPTION	UNIT ORDER	INN/MAS	PACK	LIST
85101	1/2"	25	-/25	BOX	4.85
85102	3/4"	25	-/25	BOX	4.85
85103	1"	25	-/25	BOX	5.02
85104	1-1/4"	25	-/25	BOX	5.73
85105	1-1/2"	25	-/25	BOX	5.93
85106	2"	25	-/25	BOX	6.10
85107	2-1/2"	25	-/25	BOX	6.64
85108	3"	25	-/25	BOX	7.19

### J-HOOKS - PLASTIC

- Comes with nails



PART #	DESCRIPTION	UNIT ORDER	INN/MAS	PACK	LIST
85130	1/2"	10	10/200	BULK	1.00
85131	3/4"	10	10/800	BULK	1.11
85132	1"	10	10/800	BULK	1.14
85126	1-1/2"	10	10/200	BULK	1.40
85127	2"	25	25/125	BULK	1.23
85128	3"	25	25/100	BULK	1.45
85129	4"	25	25/75	BULK	1.60

### PLASTIC-COATED COPPER-CLAD TUBE HOOKS

- Sold per bag of 50 - priced each



PART #	DESCRIPTION	UNIT ORDER	INN/MAS	PACK	LIST
85022	1/2" x 4"	50	50/500	BULK	1.28
85024	1/2" x 6"	50	50/500	BULK	1.34
85023	3/4" x 4"	50	50/500	BULK	1.28
85025	3/4" x 6"	50	50/500	BULK	1.34

Supply Connectors

Stop Valves

Water Heater

Gas Connectors

Water Filtration

Sinks/Faucets

Tubular/Drainage

Faucet Repair

Bath Accessories

Pipe Fittings/Repair

Valves

Cements/Sealants

Tools/Safety

Toilet Repair

Appliance/HVAC

Hardware

Electrical

Index

# PIPE FITTINGS AND REPAIR

## Clamps, Supports and Hangers

### COPPER-CLAD TUBE HOOKS

- Sold per bag of 50 - priced each

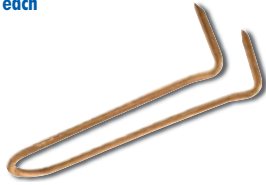

PART #	DESCRIPTION	UNIT ORDER	INN/MAS	PACK	LIST
85001	1/2" x 4"	50	50/500	BULK	0.43
85004	1/2" x 6"	50	50/500	BULK	0.48
85002	3/4" x 4"	50	50/500	BULK	0.48
85005	3/4" x 6"	50	50/500	BULK	0.48

### SPLIT-RING PIPE HANGER - GALVANIZED

- Suspends non-insulated, stationary copper tubing from joists, steel beams, wooden rafters or walls
- Rigid support that holds tubing away from mounting surfaces
- Can be used in both horizontal and vertical applications



PART #	DESCRIPTION	UNIT ORDER	INN/MAS	PACK	LIST
85009	1/2"	1	-/50	BOX	1.51
85010	3/4"	1	-/50	BOX	1.91
85011	1"	1	-/50	BOX	2.02

### SPLIT-RING PIPE HANGER - COPPER-CLAD

- Suspends non-insulated, stationary copper tubing from joists, steel beams, wooden rafters or walls
- Rigid support that holds tubing away from mounting surfaces
- Can be used in both horizontal and vertical applications



PART #	DESCRIPTION	UNIT ORDER	INN/MAS	PACK	LIST
85012	1/2"	1	-/25	BOX	1.45
85013	3/4"	1	-/25	BOX	1.82
85014	1"	1	-/25	BOX	2.00

### TOP BEAM CLAMP

- Supports threaded rod or threaded bridle ring
- Max load 400 lbs



PART #	DESCRIPTION	UNIT ORDER	INN/MAS	PACK	LIST
85015	3/8"	1	-/100	BOX	1.82

### SIDE BEAM CONNECTOR

- Provides connection for various types of pipe hangers
- Constructed of malleable iron for durability
- Mount to steel "I" beams and joists
- Use to secure 3/8" x 1/6-threaded rod



PART #	DESCRIPTION	UNIT ORDER	INN/MAS	PACK	LIST
85019	3/8"	1	-/100	BOX	1.31

### FLANGE HANGER PLATE

- Made from steel
- Rated 200 lbs in vertical loading proof tested to 2000 lbs
- Load limited by fasteners



PART #	DESCRIPTION	UNIT ORDER	INN/MAS	PACK	LIST
85016	3/8" - Steel	1	-/100	BOX	1.74
85017	3/8" - Galvanized Steel	1	-/100	BOX	1.88
85018	3/8" - Copper-Clad Steel	1	-/100	BOX	2.59

### STRUT PIPE CLAMP

- For suspending electrical pipes and tubes overhead
- Zinc-plated steel construction
- Compatible with 12- or 14-gauge metal framing channel



PART #	DESCRIPTION	UNIT ORDER	INN/MAS	PACK	LIST
85050	1/2" IPS	1	-/50	BOX	1.25
85051	3/4" IPS	1	-/50	BOX	1.31
85052	1" IPS	1	-/50	BOX	1.40
85053	1-1/4" IPS	1	-/50	BOX	1.68
85054	1-1/2" IPS	1	-/50	BOX	1.82
85055	2" IPS	1	-/50	BOX	2.11

### CLEVIS PIPE HANGER

- Recommended for the suspension of non-insulated pipe or insulated pipe



PART #	DESCRIPTION	UNIT ORDER	INN/MAS	PACK	LIST
85095	1/2"	1	-/100	BOX	1.34
85096	3/4"	1	-/100	BOX	1.40
85097	1"	1	-/100	BOX	1.48
85098	1-1/4"	1	-/100	BOX	1.51
85099	1-1/2"	1	-/100	BOX	1.68
85100	2"	1	-/50	BOX	1.85

## Clamps, Supports and Hangers

### COPPER-PLATED SUPPORT BRACKET

- Can be nailed or screwed to wood or metal studs
- 16-Gauge
- 20" Length



PART #	DESCRIPTION	UNIT ORDER	INN/MAS	PACK	LIST
85133	1/2" Holes	5	-/50	BULK	6.30
85134	1/2", 3/4", 1" Holes	5	-/50	BULK	6.16

## Roof Flashing

### ROOF FLASHING

- Galvanized steel base with elastomer collar



PART #	DESCRIPTION	UNIT ORDER	INN/MAS	PACK	LIST
86245	1-1/4" or 1-1/2"	20	-/20	BULK	9.89
86246	2"	20	-/20	BULK	10.64
86247	3"	20	-/20	BULK	12.17
86248	4"	20	-/20	BULK	17.71

### ROOF FLASHING - ALUMINUM

- Aluminum base with elastomer collar



PART #	DESCRIPTION	UNIT ORDER	INN/MAS	PACK	LIST
86256	1-1/4" or 1-1/2"	20	-/20	BULK	10.49
86257	2"	20	-/20	BULK	10.92
86258	3"	20	-/20	BULK	11.35
86259	4"	20	-/20	BULK	15.82

### ALL-FLEXIBLE ROOF FLASHING



PART #	DESCRIPTION	UNIT ORDER	INN/MAS	PACK	LIST
86250	1-1/4" or 1-1/2"	20	-/20	BULK	5.59
86251	2"	20	-/20	BULK	6.24
86252	3"	20	-/20	BULK	7.70
86253	4"	20	-/20	BULK	10.78

### 3-N-1 ROOF FLASHING

- Fits 1-1/4" or 1-1/2", 2", 3" vent pipe
- Tested for ultraviolet, ozone & weather resistance
- Galvanized blade with adjustable elastomer collar



PART #	DESCRIPTION	UNIT ORDER	INN/MAS	PACK	LIST
86249	3-N-1	20	-/20	BULK	12.17

### MULTISIZE ROOF FLASHING

- Aluminum base with adjustable elastomer collar



PART #	DESCRIPTION	UNIT ORDER	INN/MAS	PACK	LIST
86260	1-1/4" - 3"	20	-/20	BULK	13.00
86261	3" - 4"	20	-/20	BULK	16.74

### MULTISIZE ROOF FLASHING

- Thermoplastic hard base with adjustable elastomer collar
- Tested for U/V, ozone and weather resistance

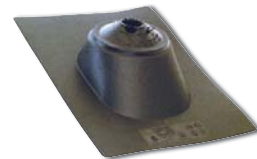

PART #	DESCRIPTION	UNIT ORDER	INN/MAS	PACK	LIST
86254	1-1/4" or 1-1/2", 2", 3"	20	-/20	BULK	6.81
86255	3" or 4"	20	-/20	BULK	7.61

### ROOF FLASHING CEMENT - BLACK

- Wet or dry weather plastic cement
- For repairing and sealing leaks around flashings, sky lights, vents, gutters and other protrusions
- Asbestos-free



PART #	DESCRIPTION	UNIT ORDER	INN/MAS	PACK	LIST
87200	1 Quart	1	-/12	BOX	19.39
87201	1 Gallon	1	-/4	BOX	41.09

# PIPE FITTINGS AND REPAIR

## Roof Flashing

### MULTISIZE RAIN AND REPAIR COLLAR

- Use to quickly and easily repair elastomer sealing collar on all types of residential no-caulk roof vent flashing
- Eliminates the need for a mastic or caulking
- Can be used to instantly repair a leak during a wet period until the flashing can be replaced
- Large size covers the entire existing elastomer collar
- Fully tested for ultraviolet, ozone, and weather resistance



PART #	DESCRIPTION	UNIT ORDER	INN/MAS	PACK	LIST
86198	1-1/4", 1-1/2", 2" and 3"	1	-/20	BOX	6.27
86199	3" and 4"	1	-/20	BOX	7.10

### VENT STACK FLASHING REPAIR COLLAR

- Fixes cracked, leaky vent stack flashing
- Unique design works on pitched and flat roofs as well as wall applications



PART #	DESCRIPTION	UNIT ORDER	INN/MAS	PACK	LIST
86340	1-1/2" - 2"	6	-/6	BAG	21.78
86341	2-1/2" - 3"	6	-/6	BAG	31.51

### TERMINATION SCREEN

- Prevents foreign objects from entering a venting system and causing obstruction
- Fits inside hub end of schedule 40 DWV fittings
- Friction fit
- Does not conduct heat like metal
- Can be removed if necessary



PART #	DESCRIPTION	UNIT ORDER	INN/MAS	PACK	LIST
73002	2" Black	1	-/250	BULK	1.14
73003	3" Black	1	-/100	BULK	4.70
73022	2" White	1	-/250	BULK	1.23
73023	3" White	1	-/100	BULK	4.93

## Air Vents

### TRAP AIR VENT WITH TAILPIECE

- 1-1/2" Trap air vent



PART #	DESCRIPTION	UNIT ORDER	INN/MAS	PACK	LIST
15343	Trap Air Vent	10	10/160	BULK	5.73

## MINI-VENT

- Fits 1-1/4", 1-1/2" & 2" pipe sizes
- Residential and commercial use
- Listed to ASSE 1051, ASTE 1050 & NSF 14 standards
- Protective screens inside and outside



PART #	DESCRIPTION	UNIT ORDER	INN/MAS	PACK	LIST
86075	Air Admittance Valve	1	-/40	BULK	55.60

## REDI-VENT

- Fits 1-1/2" & 2" pipe sizes
- For venting single fixtures such as island sinks
- Compact size for tight installations
- Protective screens inside and outside
- Listed to ASSE 1051 and NSF 61



PART #	DESCRIPTION	UNIT ORDER	INN/MAS	PACK	LIST
86076	Air Admittance Valve	1	-/24	BULK	39.57



## Pipe Insulation

### ELASTOMERIC INSULATION TAPE

- Flexible, closed-cell elastomeric insulation
- Ideal for insulating short runs of pipe or valves and fittings where it is impractical to install tubing insulation
- Temperature rating of -40° F to 200° F
- Black



PART #	DESCRIPTION	UNIT ORDER	INN/MAS	PACK	LIST
82331	1/8" x 2" x 30' - MFG #800-EL-018	1	-/12	BULK	19.13

### PIPE SLEEVING

- Use on 1/2", 3/4", 1" copper, PEX, poly or CPVC tube
- 6 mil. x 200'



PART #	DESCRIPTION	UNIT ORDER	INN/MAS	PACK	LIST
86262	Blue Pipe Sleeving	1	-/20	BULK	28.40
86263	Red Pipe Sleeving	1	-/20	BULK	28.40

### POLYETHYLENE FOAM PIPE INSULATION

- Self-sealing
- Peel-off tape
- Closed-cell, low-density polyethylene
- Pre-slit, self-adhesive
- Priced per 6' length
- Must order in case quantity



PART #	DESCRIPTION	UNIT ORDER	INN/MAS	PACK	LIST
82320	5/8" ID 3/8" Wall	66	-/66	BULK	<b>CALL FOR CURRENT PRICE</b>
82323	5/8" ID 1/2" Wall	50	-/50	BULK	
82326	5/8" ID 1" Wall	20	-/20	BULK	
82321	7/8" ID 3/8" Wall	46	-/46	BULK	
82324	7/8" ID 1/2" Wall	40	-/40	BULK	
82327	7/8" ID 1" Wall	16	-/16	BULK	
82322	1-1/8" ID 3/8" Wall	37	-/37	BULK	
82325	1-1/8" ID 1/2" Wall	31	-/31	BULK	
82328	1-1/8" ID 1" Wall	14	-/14	BULK	

## Pumps and Accessories

### SUBMERSIBLE SUMP PUMP

- 1/2 HP
- 1-1/2" NPT discharge
- Rugged cast-iron and stainless steel construction
- Automatic vertical float switch
- Pumps up to 3300 GPH
- 15' Power supply cord



PART #	DESCRIPTION	UNIT ORDER	INN/MAS	PACK	LIST
95069	Automatic	1	-/1	BOX	227.70

### SUMP PUMP CHECK VALVE

**NEW**

- Flapper design helps prevent water from entering back into the pump or basin
- Rubber construction
- Corrosion-resistant
- Easy to install



PART #	DESCRIPTION	UNIT ORDER	INN/MAS	PACK	LIST
95089	1-1/4" or 1-1/2"	12	12/48	BOX	14.54
95090	2"	6	6/24	BOX	26.54

Supply Connectors

Stop Valves

Water Heater

Gas Connectors

Water Filtration

Sinks/ Faucets

Tubular/ Drainage

Faucet Repair

Bath Accessories

Pipe Fittings/ Repair

Valves

Cements/ Sealants

Tools/ Safety

Toilet Repair

Appliance/ HVAC

Hardware

Electrical

Index

# PIPE FITTINGS AND REPAIR

## Pumps and Accessories

### TRI-CHECK PVC CHECK VALVE

- Full-flow check valve design
- Meets plumbing codes requiring a ball valve installed in conjunction with a check valve



PART #	DESCRIPTION	UNIT ORDER	INN/MAS	PACK	LIST
95082	2"	1	-/6	BULK	72.78

### DRILL PUMP

- Garden hose thread
- Use with any drill
- 1/4" Shank fits all common chucks
- Great for draining small bodies of water quickly
- Self-priming



PART #	DESCRIPTION	UNIT ORDER	INN/MAS	PACK	LIST
95068	Multipurpose Utility Drill Pump	6	-/125	CLAM	12.32



## HAS ALL OF YOUR WATER FILTRATION NEEDS

From complete kits, to replacement filters

See pages... **47-53**



Visit us online at...

[www.ez-flo.net](http://www.ez-flo.net)

## Foot Valves

### BRASS FOOT VALVE

- Brass screen ensures longevity in all conditions
- Holds prime for jet well pumps and irrigation pumps
- Prevents backflow with spring-loaded positive sealing
- 200 PSI max pressure



**NEW**



PART #	DESCRIPTION	UNIT ORDER	INN/MAS	PACK	LIST
95130	3/4" FIP	1	6/48	BULK	19.70
95131	1" FIP	1	6/48	BULK	25.95
95132	1-1/4" FIP	1	6/48	BULK	34.07

### BRASS FOOT VALVE

- Brass screen ensures longevity in all conditions
- Holds prime for jet well pumps and irrigation pumps
- Prevents backflow with spring-loaded positive sealing
- 200 PSI max pressure



**NEW**



PART #	DESCRIPTION	UNIT ORDER	INN/MAS	PACK	LIST
95133	1" FIP x 1-1/4" MIP	1	6/48	BULK	25.60

## Pressure Valves

### PRESSURE SWITCH

- Factory preset at 20-40 or 30-50 PSI
- For control of electric water pumps
- 1/4" - 18 NPSF
- 1/2" Knock-out for electrical line



PART #	DESCRIPTION	UNIT ORDER	INN/MAS	PACK	LIST
60042	20-40 PSI	1	-/50	BOX	8.70
60043	30-50 PSI	1	-/50	BOX	8.70

### PRESSURE REGULATOR

- Automatically reduces and regulates inlet pressure down to standard factory setting at 45 PSI
- Compact iron body
- Outlet pressure adjustable from 10-70 PSI
- \* **NOT for drinking water applications**



PART #	DESCRIPTION	UNIT ORDER	INN/MAS	PACK	LIST
95045	1/2" FIP	1	-/12	BOX	68.43
95046	3/4" FIP	1	-/12	BOX	77.07

## PRESSURE REDUCING BOILER FEED VALVE

- Balanced piston construction for closer outlet control regardless of fluctuations in the inlet pressure
- Bronze body
- \* **NOT for drinking water applications**



PART #	DESCRIPTION	UNIT ORDER	INN/MAS	PACK	LIST
95038	1/2" Sweat	1	-/24	BOX	115.45

## Ball Valves

### BRASS FULL-PORT BALL VALVE - COMPRESSION

- 125 PSIG for saturated steam
- 600 WOG
- Stamped-steel handle with vinyl grip
- Teflon® seal



PART #	DESCRIPTION	UNIT ORDER	INN/MAS	PACK	LIST
20096LF	1/2" Comp x Comp	15	15/60	TAG	15.34
20097LF	3/4" Comp x Comp	15	15/60	TAG	25.92

### BRASS HEAVY-DUTY FULL-PORT BALL VALVE

- Brass construction
- Stamped-steel handle with vinyl grip
- Teflon® seal
- 150 PSIG for saturated steam
- 600 WOG



PART #	DESCRIPTION	UNIT ORDER	INN/MAS	PACK	LIST
20041LF	1/4" IPS	10	10/100	TAG	9.98
20043LF	3/8" IPS	10	10/100	TAG	9.49
20045LF	1/2" IPS	10	10/100	TAG	11.26
20047LF	3/4" IPS	15	15/60	TAG	16.96
20049LF	1" IPS	6	6/30	TAG	26.09
20051LF	1-1/4" IPS	5	5/20	TAG	49.75
20053LF	1-1/2" IPS	4	4/16	TAG	73.79
20055LF	2" IPS	2	2/8	TAG	104.21

Supply Connectors

Stop Valves

Water Heater

Gas Connectors

Water Filtration

Sinks/Faucets

Tubular/Drainage

Faucet Repair

Bath Accessories

Pipe Fittings/Repair

Valves

Cements/Sealants

Tools/Safety

Toilet Repair

Appliance/HVAC

Hardware

Electrical

Index

# VALVES

## Ball Valves

### BRASS HEAVY-DUTY FULL-PORT BALL VALVE

- Brass construction
- Stamped-steel handle with vinyl grip
- Teflon® seal
- 150 PSIG for saturated steam
- 600 WOG



PART #	DESCRIPTION	UNIT ORDER	INN/MAS	PACK	LIST
20061LF	1/2" C x C	10	10/100	TAG	10.41
20063LF	3/4" C x C	12	12/48	TAG	16.11
20065LF	1" C x C	8	8/32	TAG	24.95
20067LF	1-1/4" C x C	4	4/16	TAG	49.75
20069LF	1-1/2" C x C	2	2/12	TAG	70.94
20071LF	2" C x C	2	2/6	TAG	101.36

### BRASS FULL-PORT BALL VALVE - F1807 PEX

- Stamped-steel handle with vinyl grip
- Full-port
- 400 WOG



PART #	DESCRIPTION	UNIT ORDER	INN/MAS	PACK	LIST
20093LF	1/2" PEX x 1/2" PEX	10	10/100	TAG	8.13
20094LF	3/4" PEX x 3/4" PEX	10	10/100	TAG	10.98
20095LF	1" PEX x 1" PEX	12	12/60	TAG	19.53

### BRASS FULL-PORT BALL VALVE WITH DRAIN - F1807 PEX

**NEW**

- Ball valve allows line to be drained for maintenance or to prevent freeze-up
- Full-port, heavy-duty forged brass
- Stamped-steel handle with vinyl grip
- Rated 400 PSI



PART #	DESCRIPTION	UNIT ORDER	INN/MAS	PACK	LIST
20140LF	1/2" PEX x 1/2" PEX	10	10/100	BULK	8.67
20142LF	3/4" PEX x 3/4" PEX	10	10/100	BULK	11.23

### BRASS BALL VALVE - F1960 PEX

**NEW**

- 400 WOG
- Teflon® seal
- For use with F1960 expansion pex



PART #	DESCRIPTION	UNIT ORDER	INN/MAS	PACK	LIST
20091LF	1/2" PEX x 1/2" PEX	10	10/100	BULK	8.78
20098LF	3/4" PEX x 3/4" PEX	10	10/100	BULK	12.37
20099LF	1" PEX x 1" PEX	6	6/48	BULK	21.95

### BRASS SLIP BALL VALVE - PUSH-FIT

**NEW**

- A connection system for copper, CPVC or PEX pipe
- Has a slip feature for quick and easy installation
- Compact, corrosion-resistant
- Rated 200 PSI



PART #	DESCRIPTION	UNIT ORDER	INN/MAS	PACK	LIST
75160LF	1/2" Push-Fit x 1/2" Push-Fit	20	20/100	BULK	21.93
75162LF	3/4" Push-Fit x 3/4" Push-Fit	10	10/100	BULK	27.97

### BRASS BALL VALVE - PUSH-FIT

**NEW**

- A connection system for copper, CPVC or PEX pipe
- Use underground and behind walls without access panels
- No soldering required
- Compact, corrosion-resistant
- Rated 200 PSI



PART #	DESCRIPTION	UNIT ORDER	INN/MAS	PACK	LIST
75168LF	3/4" Push-Fit x 3/4" FIP	10	10/100	BULK	20.87

## Ball Valves

### SCHEDULE 40 PVC BALL VALVE - SLIP

- One-piece body construction
- 1/4-Turn operation – standard port
- 150 PSI working pressure
- For use on water lines to 140° F
- White body with red handle
- Solvent weld



PART #	DESCRIPTION	UNIT ORDER	INN/MAS	PACK	LIST
20111	1/2" Slip	10	10/100	BOX	2.08
20113	3/4" Slip	10	10/100	BOX	3.08
20115	1" Slip	10	10/50	BOX	4.48
20117	1-1/4" Slip	5	5/50	BOX	7.93
20119	1-1/2" Slip	6	6/24	BOX	9.29
20121	2" Slip	6	6/24	BOX	13.46
20123	3" Slip	2	2/12	BOX	73.65

### SCHEDULE 80 CPVC BALL VALVE - SLIP



PART #	DESCRIPTION	UNIT ORDER	INN/MAS	PACK	LIST
48636	1/2" Slip	10	10/100	BOX	8.24
48637	3/4" Slip	10	10/100	BOX	10.64
48638	1" Slip	10	10/100	BOX	17.65

### SCHEDULE 40 PVC BALL VALVE - IPS

- One-piece body construction
- 1/4-Turn operation – standard port
- 150 PSI working pressure
- For use on water lines to 140° F
- White body with red handle



PART #	DESCRIPTION	UNIT ORDER	INN/MAS	PACK	LIST
20077	1/2" IPS	10	10/100	BOX	2.08
20079	3/4" IPS	10	10/100	BOX	3.08
20081	1" IPS	10	10/50	BOX	5.93
20085	1-1/2" IPS	6	6/24	BOX	10.64
20087	2" IPS	6	6/24	BOX	15.54

## Check Valves

### PVC IN-LINE CHECK VALVE

- 150 PSI working pressure
- 5 PSI to open
- Used on water lines up to 140° F
- 316 Stainless steel spring



PART #	DESCRIPTION	UNIT ORDER	INN/MAS	PACK	LIST
20452	1/2" Slip	10	10/120	BAG	7.84
20453	3/4" Slip	10	10/120	BAG	9.01
20454	1" Slip	8	8/96	BAG	14.00
20455	1-1/4" Slip	6	6/48	BAG	16.48
20456	1-1/2" Slip	4	4/48	BAG	18.11
20457	2" Slip	4	4/32	BAG	22.21

### BRASS IN-LINE CHECK VALVE

- Maintenance-free operation
- Used to prevent the backflow of fluids
- 200 PSI
- 5 PSI to open
- Stainless steel spring
- Brass body



PART #	DESCRIPTION	UNIT ORDER	INN/MAS	PACK	LIST
20401LF	1/2" IPS	10	10/100	BOX	14.57
20403LF	3/4" IPS	10	10/80	BOX	20.64
20405LF	1" IPS	10	10/60	BOX	27.69

### BRASS IN-LINE CHECK VALVE

- Used to prevent backflow of fluids
- Hex nut for easy installation
- Rated 200 PSI



PART #	DESCRIPTION	UNIT ORDER	INN/MAS	PACK	LIST
20400	1/2" MIP x 1/2" MIP	1	-/100	BULK	7.13

### BRASS SWING CHECK VALVE

- Straight-pattern
- 125 PSI - 200 WOG
- Brass body
- Used to prevent the backflow of fluids



PART #	DESCRIPTION	UNIT ORDER	INN/MAS	PACK	LIST
20423LF	3/4" IPS	1	10/80	TAG	16.96
20425LF	1" IPS	5	5/80	TAG	22.05
20429LF	1-1/2" IPS	2	2/40	TAG	50.49
20431LF	2" IPS	2	2/20	TAG	77.37

### BRASS SWING CHECK VALVE

- Straight-pattern
- 125 PSI - 200 WOG
- Brass body
- Used to prevent the backflow of fluids



PART #	DESCRIPTION	UNIT ORDER	INN/MAS	PACK	LIST
20443LF	3/4" C x C	1	10/80	TAG	17.68
20445LF	1" C x C	4	4/40	TAG	27.03

# VALVES

## Hose Bibbs

### BRASS HOSE BIBB

- Brass construction
- SSS hose bibb
- MHT outlet
- Rough brass
- Non-potable



PART #	DESCRIPTION	UNIT ORDER	INN/MAS	PACK	LIST
20181	1/2" MIP x MHT	12	12/120	TAG	7.41
20183	3/4" MIP x MHT	12	12/120	TAG	8.13

### HEAVY-PATTERN HOSE BIBB

- Heavy-pattern forged brass body
- With stuffing box
- Heavy handle
- Rough brass
- MHT outlet
- Non-potable



PART #	DESCRIPTION	UNIT ORDER	INN/MAS	PACK	LIST
48628	1/2" MIP x MHT	10	10/100	TAG	13.60
48629	3/4" MIP x MHT	10	10/100	TAG	14.14

### BENT NOSE GARDEN VALVE

- MHT outlet
- Rough brass
- Non-potable



PART #	DESCRIPTION	UNIT ORDER	INN/MAS	PACK	LIST
20251	1/2" FIP x MHT	10	10/100	TAG	10.69
20253	3/4" FIP x MHT	10	10/80	TAG	11.86

### BENT NOSE LOOSE KEY GARDEN VALVE

- MHT outlet
- Rough brass
- Non-potable



PART #	DESCRIPTION	UNIT ORDER	INN/MAS	PACK	LIST
20263	3/4" FIP x MHT	10	10/80	TAG	13.12

### LOOSE KEY HOSE BIBB - FEMALE

- Includes key
- MHT outlet
- 1/4" Square key pattern
- Rough brass
- Non-potable



PART #	DESCRIPTION	UNIT ORDER	INN/MAS	PACK	LIST
20213	1/2" FIP x MHT	10	10/100	TAG	9.95
20215	3/4" FIP x MHT	10	10/100	TAG	10.49

### LOOSE KEY HOSE BIBB - MALE

- Includes key
- MHT outlet
- 1/4" Square key pattern
- Rough brass
- Non-potable



PART #	DESCRIPTION	UNIT ORDER	INN/MAS	PACK	LIST
20217	1/2" MIP x MHT	10	10/100	TAG	9.27

### MALE LOCK-LEVER HOSE BIBB

- 1/4-Turn ball valve
- Nickel-plated brass
- Lockable handle
- Non-potable



PART #	DESCRIPTION	UNIT ORDER	INN/MAS	PACK	LIST
20182	1/2" MIP	10	10/80	TAG	13.80

## Hose Bibbs

### MALE HOSE BIBB - 1/4-TURN

- Forged brass
- 3/4" MHT outlet
- Rough brass
- Non-potable



48601



48600

COMPLIES WITH NSF-61 **EASTMAN**

PART #	DESCRIPTION	UNIT ORDER	INN/MAS	PACK	LIST
48600	1/2" MIP	15	15/120	TAG	12.83
48601	3/4" MIP	10	10/80	TAG	14.20

### CELCON HOSE BIBB

- Celcon body valves can be used in hot or cold water systems
- Up to 180° F
- MHT outlet



PART #	DESCRIPTION	UNIT ORDER	INN/MAS	PACK	LIST
20838	1/2" MIP	20	20/200	TAG	3.34
20839	3/4" MIP	20	20/200	TAG	3.34

### FEMALE NO-KINK HOSE BIBB

- Brass body
- MHT outlet
- Rough brass
- Non-potable



PART #	DESCRIPTION	UNIT ORDER	INN/MAS	PACK	LIST
20201	1/2" FIP	10	10/100	TAG	7.50
20203	3/4" FIP	10	10/100	TAG	9.21

### MALE NO-KINK HOSE BIBB

- Brass body
- MHT outlet
- Rough brass
- Non-potable



PART #	DESCRIPTION	UNIT ORDER	INN/MAS	PACK	LIST
20205	1/2" MIP	10	10/100	TAG	8.41
20207	3/4" MIP	10	10/100	TAG	9.75

### NO-KINK HOSE BIBB

- Brass body
- Fits 3/4" fittings or 1/2" pipe
- Rough brass
- Non-potable



PART #	DESCRIPTION	UNIT ORDER	INN/MAS	PACK	LIST
20208	1/2" or 3/4" C	10	10/100	TAG	8.47

### HEAVY-PATTERN FEMALE NO-KINK HOSE BIBB

- Heavy-pattern forged brass body
- With stuffing box
- Oversized handle
- Rough brass body
- Non-potable



PART #	DESCRIPTION	UNIT ORDER	INN/MAS	PACK	LIST
48624	1/2" FIP	10	10/100	TAG	11.18
48625	3/4" FIP	10	10/100	TAG	12.00

### HEAVY-PATTERN MALE NO-KINK HOSE BIBB

- Heavy-pattern forged brass body
- With stuffing box
- Oversized handle
- Rough brass body
- Non-potable



PART #	DESCRIPTION	UNIT ORDER	INN/MAS	PACK	LIST
48626	1/2" MIP	10	10/100	TAG	11.60
48627	3/4" MIP	10	10/100	TAG	13.40

Supply Connectors

Stop Valves

Water Heater

Gas Connectors

Water Filtration

Sinks/Faucets

Tubular/Drainage

Faucet Repair

Bath Accessories

Pipe Fittings/Repair

Valves

Cements/Sealants

Tools/Safety

Toilet Repair

Appliance/HVAC

Hardware

Electrical

Index

# VALVES

## Sill Cocks

### FROST-FREE SILL COCK

- Heavy brass construction
- Notched
- MHT outlet
- Large wheel handle



PART #	DESCRIPTION	UNIT ORDER	INN/MAS	PACK	LIST
80219	4" - 1/2" MIP x 1/2" C	2	2/24	BOX	25.23
80220	6" - 1/2" MIP x 1/2" C	2	2/24	BOX	27.14
80221	8" - 1/2" MIP x 1/2" C	2	2/24	BOX	28.17
80222	10" - 1/2" MIP x 1/2" C	2	2/24	BOX	29.22
80223	12" - 1/2" MIP x 1/2" C	2	2/24	BOX	30.96

### FROST-FREE SILL COCK WITH VACUUM BREAKER

- Heavy brass construction
- Notched
- MHT outlet
- 1/2" MIP x 1/2" C
- Large wheel handle



PART #	DESCRIPTION	UNIT ORDER	INN/MAS	PACK	LIST
80230	4" Length	2	2/24	BOX	31.99
80226	6" Length	2	2/24	BOX	33.96
80227	10" Length	2	2/24	BOX	36.07
80228	12" Length	2	2/24	BOX	39.55

### BRASS SILL COCK

- MHT outlet
- Rough brass body
- Non-potable



PART #	DESCRIPTION	UNIT ORDER	INN/MAS	PACK	LIST
20221	1/2" FIP	10	10/100	TAG	9.84
20223	3/4" FIP	10	10/100	TAG	10.12
20222	1/2" C	10	10/100	TAG	9.72

## Boiler Drains

### BOILER DRAIN

- Brass body
- MHT outlet
- Rough brass
- Non-potable



PART #	DESCRIPTION	UNIT ORDER	INN/MAS	PACK	LIST
20271	1/2" MIP	10	10/100	TAG	8.41
20273	3/4" MIP	10	10/100	TAG	9.07
20281	1/2" FIP	10	10/100	TAG	8.44
20283	3/4" FIP	10	10/100	TAG	8.87

### HEAVY-PATTERN BOILER DRAIN WITH STUFFING BOX

- MHT outlet
- Brass with stuffing box
- Non-potable



PART #	DESCRIPTION	UNIT ORDER	INN/MAS	PACK	LIST
48620	1/2" MIP	10	10/100	TAG	9.27
48621	3/4" MIP	10	10/100	TAG	9.64

### MALE BOILER DRAIN - 1/4-TURN

- Forged brass
- 3/4" MHT outlet
- Rough brass
- Non-potable



PART #	DESCRIPTION	UNIT ORDER	INN/MAS	PACK	LIST
48604	1/2" MIP	12	12/72	TAG	11.77

## Specialty Valves

### HOSE BIBB ANTI-SIPHON VACUUM BREAKER

- 125 PSI, temp. rating 180 PSI
- Self-draining
- Break-off screw for permanent installation



PART #	DESCRIPTION	UNIT ORDER	INN/MAS	PACK	LIST
20199	Rough Brass	20	20/200	BAG	5.67



## Specialty Valves

### WATER HEATER DRAIN VALVE

- 3/4" MIP x 3/4" MHT



60093 **EASTMAN**  
LEAD-FREE

PART #	DESCRIPTION	UNIT ORDER	INN/MAS	PACK	LIST
60092LF	2-1/4" Shank - Brass	10	10/100	BAG	10.92
60093	2-1/2" Shank - Nylon	1	-/150	BAG	4.62

### WASHING MACHINE VALVE - COMPRESSION

- Brass body
- T-handle
- MHT outlet
- Satin chrome finish



60301

60303

PART #	DESCRIPTION	UNIT ORDER	INN/MAS	PACK	LIST
60301	5/8" OD Inlet	1	10/100	TAG	9.27
60303	1/2" FIP Inlet	1	10/100	TAG	7.56

### EVAPORATIVE COOLER FLOAT VALVE ASSEMBLY

- Brass body & rod
- Plastic float
- Compression inlet



PART #	DESCRIPTION	UNIT ORDER	INN/MAS	PACK	LIST
20289	1/4" OD	10	10/100	BULK	10.98
20290	3/8" OD	10	10/100	BULK	13.20

### STRAIGHT NEEDLE VALVE

- Brass
- Straight - Comp x comp



**EASTMAN**  
LEAD-FREE **COMPLIES WITH NSF-372**

PART #	DESCRIPTION	UNIT ORDER	INN/MAS	PACK	LIST
65823LF	1/4" x 1/4" OD Tube	1	10/100	BULK	4.45
65827LF	3/8" x 3/8" OD Tube	1	10/100	BULK	6.24

### ANGLE MALE NEEDLE VALVE

- Brass
- Angle - Comp x MIP



**EASTMAN**  
LEAD-FREE **COMPLIES WITH NSF-372**

PART #	DESCRIPTION	UNIT ORDER	INN/MAS	PACK	LIST
65833LF	1/4" OD Tube x 1/8" MIP	10	10/100	BULK	4.31

### BRASS SELF-PIERCING SADDLE VALVE

- 1/4" OD comp outlet on needle valve kit consists of needle valve, saddle & clamp
- Brass



**EASTMAN**  
LEAD-FREE **COMPLIES WITH NSF-372**

PART #	DESCRIPTION	UNIT ORDER	INN/MAS	PACK	LIST
65801LF	3/8" to 1" Copper Tube	10	10/200	BAG	4.68

## Steam Radiator Valves

### RADIATOR AIR VALVE

- Max operating pressure - 5 PSI
- Max pressure - 10 PSI



PART #	DESCRIPTION	UNIT ORDER	INN/MAS	PACK	LIST
20371	1/8" Angle MIP	12	12/144	BAG	10.29

### ADJUSTABLE RADIATOR AIR VALVE

- Max operating pressure - 1-1/2 PSI
- Max pressure - 10 PSI
- Adjustable



PART #	DESCRIPTION	UNIT ORDER	INN/MAS	PACK	LIST
20378	1/8" Angle MIP	12	12/144	BAG	16.14

Supply Connectors

Stop Valves

Water Heater

Gas Connectors

Water Filtration

Sinks/Faucets

Tubular/Drainage

Faucet Repair

Bath Accessories

Pipe Fittings/Repair

Valves

Cements/Sealants

Tools/Safety

Toilet Repair

Appliance/HVAC

Hardware

Electrical

Index

# VALVES

## Steam Radiator Valves

### KEYED AIR VALVE

- Nickel-plated
- Must order key valve separately



20322



20381

PART #	DESCRIPTION	UNIT ORDER	INN/MAS	PACK	LIST
20381	Coin Key Air Valve	10	10/500	BULK	1.88
20322	Key Only 7/32" Square Hole	1	-/3000	BULK	0.77

## Gas Valves

### BRASS GAS BALL VALVE - STRAIGHT

- Lever handle
- For use with liquefied petroleum, natural gas and air mixtures up to 175 PSI
- Brass body
- FIP x FIP



PART #	DESCRIPTION	UNIT ORDER	INN/MAS	PACK	LIST
60009	1/2" FIP	12	12/144	BULK	6.42
60011	3/4" FIP	12	12/120	BULK	9.89
60013	1" FIP	6	12/36	BULK	21.33

### BRASS GAS BALL VALVE - STRAIGHT

- Lever handle
- For use with liquefied petroleum, natural gas and air mixtures up to 175 PSI
- Brass body
- Flare x flare



PART #	DESCRIPTION	UNIT ORDER	INN/MAS	PACK	LIST
60004	3/8" OD Tube x 3/8" OD Tube	10	10/120	BULK	6.67
60006	1/2" OD Tube x 1/2" OD Tube	10	10/120	BULK	7.53

**NEW**

### BRASS GAS BALL VALVE - STRAIGHT

- Lever handle
- For use with liquefied petroleum, natural gas and air mixtures up to 175 PSI
- Brass body
- Flare x FIP



PART #	DESCRIPTION	UNIT ORDER	INN/MAS	PACK	LIST
60001	1/2" FIP x 3/8" OD Tube	10	10/120	BULK	8.33
60003	1/2" FIP x 1/2" OD Tube	10	10/120	BULK	8.27
60031	1/2" FIP x 15/16" OD Tube	10	10/100	BULK	11.80
60030	3/4" FIP x 1/2" OD Tube	10	10/80	BULK	13.54
60005	3/4" FIP x 15/16" OD Tube	10	10/80	BULK	12.80

### BRASS GAS BALL VALVE - ANGLE

- Lever handle
- For use with liquefied petroleum, natural gas and air mixtures up to 175 PSI
- Brass body
- Flare x FIP



PART #	DESCRIPTION	UNIT ORDER	INN/MAS	PACK	LIST
60032	1/2" FIP x 3/8" OD Tube	8	8/80	BULK	10.52
60034	1/2" FIP x 1/2" OD Tube	8	8/80	BULK	10.95
60029	3/4" FIP x 15/16" OD Tube	4	4/80	BULK	14.60

## Replacement Keys and Handles

### FOUR-WAY SILL COCK KEY

- Hardened steel
- Fits square stems 1/4", 5/16", 9/32" & 11/32"



PART #	DESCRIPTION	UNIT ORDER	INN/MAS	PACK	LIST
45401	Universal Valve Key	1	50/100	BULK	4.68

### HOSE BIBB KEY

- For loose key hose bibbs
- Square hole



PART #	DESCRIPTION	UNIT ORDER	INN/MAS	PACK	LIST
45403	5/16" Square Hole Key	10	10/400	BULK	1.60

## Replacement Keys and Handles

### LOG LIGHTER KEY

- For square rod



PART #	DESCRIPTION	UNIT ORDER	INN/MAS	PACK	LIST
45415	5/16" x 3"	10	10/250	BULK	2.37

### RADIATOR KEY

- Nickel-plated
- Fits keyed air valve #20381



PART #	DESCRIPTION	UNIT ORDER	INN/MAS	PACK	LIST
20322	7/32" Square Hole	1	-/3000	BULK	0.77

### T-HANDLE



PART #	DESCRIPTION	UNIT ORDER	INN/MAS	PACK	LIST
*45421	Round 12-Point Broach Hole	1	-/1750	BULK	1.11

### WHEEL HANDLE



45431



45435

PART #	DESCRIPTION	UNIT ORDER	INN/MAS	PACK	LIST
45431	Round 12-Point Broach Hole	10	10/800	BULK	1.11
45435	5/16" Square Hole	10	10/800	BULK	1.11

### SILL COCK HANDLE

- Die-cast
- Fits Eastman® frost-free sill cocks 80219-80223, 80226-80230



**EASTMAN**

PART #	DESCRIPTION	UNIT ORDER	INN/MAS	PACK	LIST
45419	Handle	1	12/48	BAG	2.57

### HANDLE SCREW

- Fits Eastman® frost-free sill cocks 80219-80223, 80226-80230
- Bag of 100



**EASTMAN**

PART #	DESCRIPTION	UNIT ORDER	INN/MAS	PACK	LIST
45420	Sill Cock Handle Screw - 100 Pack	1	5/20	BAG	17.05

### VACUUM BREAKER REPAIR KIT

- Includes cap plunger and O-ring
- Fits Eastman® frost-free sill cocks 80226-80230



**EASTMAN**

PART #	DESCRIPTION	UNIT ORDER	INN/MAS	PACK	LIST
45417	Repair Kit	1	12/48	BAG	2.59

### STEM BOTTOM ASSEMBLY

- Includes O-ring, spring seat, flat gasket, retainer cup stem packing, seat screw
- Fits Eastman® frost-free sill cocks 80226-80230



**EASTMAN**

PART #	DESCRIPTION	UNIT ORDER	INN/MAS	PACK	LIST
45418	Repair Kit	1	12/48	BAG	2.08

Supply Connectors

Stop Valves

Water Heater

Gas Connectors

Water Filtration

Sinks/ Faucets

Tubular/ Drainage

Faucet Repair

Bath Accessories

Pipe Fittings/ Repair

Valves

Cements/ Sealants

Tools/ Safety

Toilet Repair

Appliance/ HVAC

Hardware

Electrical

Index

# VALVES

## Sewer Valves

### SEWER RELIEF VALVE



PART #	DESCRIPTION	UNIT ORDER	INN/MAS	PACK	LIST
43507	3"	10	10/100	BULK	5.68
43509	3-1/2"	10	10/100	BULK	5.81
43511	4"	10	10/100	BULK	5.96

## Test Gauges

### GAS PRESSURE TEST GAUGE

- 3/4" IPS connection
- Shatter-resistant lens
- Precision made
- Steel case



PART #	DESCRIPTION	UNIT ORDER	INN/MAS	PACK	LIST
45167	2" Face 0 to 30 PSI	1	-/50	BOX	15.68

### WATER PRESSURE TEST GAUGE

- 3/4" Brass hose connection
- Shatter-resistant lens
- Precision made
- Steel case



PART #	DESCRIPTION	UNIT ORDER	INN/MAS	PACK	LIST
45169	2-1/2" Face 0 to 300 PSI	1	-/50	BOX	11.12

## PRESSURE TEST GAUGE

- 1/4" NPT brass lower connection
- Steel case
- Shatter-resistant lens



PART #	DESCRIPTION	UNIT ORDER	INN/MAS	PACK	LIST
45156	2" Face - 15 PSI	1	-/50	BOX	6.02
45160	2" Face - 30 PSI	1	-/50	BOX	6.02
45162	2" Face - 60 PSI	1	-/50	BOX	6.02
45171	2" Face - 100 PSI	1	-/100	BOX	6.02
45173	2" Face - 160 PSI	1	-/100	BOX	6.02

## TIRE PUMP

- Steel barrel with double holding wire



PART #	DESCRIPTION	UNIT ORDER	INN/MAS	PACK	LIST
55001	Tire Pump	1	-/25	BULK	14.09

# CEMENTS AND SEALANTS

## Solder

### SOLDER - 1 LB SPOOL

\* **NOT for drinking water applications**



PART #	DESCRIPTION	UNIT ORDER	INN/MAS	PACK	LIST
45331	50/50 Wire	1	-/50	BULK	<b>CALL FOR CURRENT PRICE</b>

### FLO SAFE® LEAD-FREE SOLDER

- Contains tin, copper and FloPure®
- Temperature range: 440° - 590° F
- Shear strength: 6500 PSI
- Tensile strength: 5500 PSI



PART #	DESCRIPTION	UNIT ORDER	INN/MAS	PACK	LIST
85311	97/3 - 1 lb.	1	-/50	BULK	<b>CALL FOR CURRENT PRICE</b>

### 97/3 LEAD-FREE SOLDER

- Economy tin copper alloy, wide paste range
- Melts, flows & performs better than 95/5
- Melting point 445° F
- Tensile strength 5800 PSI



PART #	DESCRIPTION	UNIT ORDER	INN/MAS	PACK	LIST
85326	1 lb	1	-/50	BULK	<b>CALL FOR CURRENT PRICE</b>

### 100% WATER SAFE® LEAD-FREE SOLDER

- A silver/tin/copper enhanced alloy
- Temperature range: 418° - 440° F
- Shear strength: 6000 PSI
- Tensile strength: 5000 PSI



PART #	DESCRIPTION	UNIT ORDER	INN/MAS	PACK	LIST
85310	1/2 lb.	1	-/75	BULK	<b>CALL FOR CURRENT PRICE</b>
85309	1 lb.	1	-/50	BULK	

### SILVER FLO™ LEAD-FREE SOLDER

- Silver bearing solder
- Temperature range: 420° - 460° F
- Shear strength: 6800 PSI
- Tensile strength: 7100 PSI



PART #	DESCRIPTION	UNIT ORDER	INN/MAS	PACK	LIST
85308	1/2 lb.	1	-/75	BULK	<b>CALL FOR CURRENT PRICE</b>
85307	1 lb.	1	-/50	BULK	

## LEAD-FREE SOLDER

- Flows like old tin/lead solder
- Meets ASTM B-32 alloy TC specification
- Melting point 410° F
- Tensile strength 7130 PSI



PART #	DESCRIPTION	UNIT ORDER	INN/MAS	PACK	LIST
85325	1 lb	1	-/50	BULK	<b>CALL FOR CURRENT PRICE</b>

## SILVERSAFE LEAD-FREE SOLDER

- Narrow pasty range allows solder to set-up quick with excellent working quality
- Tensile strength 7130 PSI
- Melting point 410° - 424° F
- For use on potable water systems



PART #	DESCRIPTION	UNIT ORDER	INN/MAS	PACK	LIST
85329	1 lb	1	-/50	BULK	<b>CALL FOR CURRENT PRICE</b>

## BRAZING RODS

- Each tube weighs 1 lb.
- Sold per tube of 28



PART #	DESCRIPTION	UNIT ORDER	INN/MAS	PACK	LIST
85324	Sil Fos 5	1	-/25	BAG	<b>CALL FOR CURRENT PRICE</b>
85322	Sil Fos 15	1	-/25	BAG	

## Solder Accessories

### COPPERMATE LEAD-FREE FLUX

- Recommended for all soft solder work and for potable water
- Removes oxidation on everything but aluminum
- Won't burn, char, or spatter
- 100% Water safe
- Meets federal specification 0-F-506 and GSA A-A-51145C



PART #	DESCRIPTION	UNIT ORDER	INN/MAS	PACK	LIST
85297	2 oz	1	-/72	BULK	9.89
85298	4 oz	1	-/48	BULK	13.40
85299	1 lb	1	-/24	BULK	32.56

Supply Connectors

Stop Valves

Water Heater

Gas Connectors

Water Filtration

Sinks/ Faucets

Tubular/ Drainage

Faucet Repair

Bath Accessories

Pipe Fittings/ Repair

Valves

Cements/ Sealants

Tools/ Safety

Toilet Repair

Appliance/ HVAC

Hardware

Electrical

Index

# CEMENTS AND SEALANTS

## Solder Accessories

### LEAD-FREE FLUX

- Flux contains zinc and ammonia chloride
- Water-soluble flux



PART #	DESCRIPTION	UNIT ORDER	INN/MAS	PACK	LIST
85300	1.7 oz.	1	-/30	BULK	5.96

### LEAD-FREE FLUX

- Flux contains zinc and ammonia chloride
- Water-soluble flux



PART #	DESCRIPTION	UNIT ORDER	INN/MAS	PACK	LIST
85301	8 oz.	1	-/12	BULK	15.57
85302	16 oz.	1	-/12	BULK	23.07

### NOKORODE® AQUA FLUX™

- Water washable paste flux
- Meets ASTM B-813 standards
- Use with 95/5, 60/40, 50/50 and 40/60



PART #	DESCRIPTION	UNIT ORDER	INN/MAS	PACK	LIST
86283	4 oz.	1	-/24	BULK	8.98
86284	16 oz.	1	-/12	BULK	25.01

### SOLDER PASTE

- Does not freeze or decompose
- Cleans as it fluxes for complete bonding of solder and metal



PART #	DESCRIPTION	UNIT ORDER	INN/MAS	PACK	LIST
45337	1.7 oz.	1	-/24	BULK	3.02

### COPPER FITTING CLEANING BRUSH

- Plastic handle



PART #	DESCRIPTION	UNIT ORDER	INN/MAS	PACK	LIST
45245	1/2"	1	12/240	BULK	3.34
45247	3/4"	1	12/240	BULK	2.62
45249	1"	1	12/240	BULK	2.79
45251	1-1/4"	1	12/240	BULK	4.22

### COPPER FITTING CLEANING BRUSH

- Loop wire handle



PART #	DESCRIPTION	UNIT ORDER	INN/MAS	PACK	LIST
45260	Loop Wire Handle - 1/2"	1	12/240	BAG	2.51
45261	Loop Wire Handle - 3/4"	1	12/240	BAG	2.51
45262	Loop Wire Handle - 1"	1	12/240	BAG	2.88

### CLEANING BRUSH - 4-IN-1 FITTING/TUBING

- High-quality dense wire for long life, quick cleaning and etching
- Includes 1/2" and 3/4" fitting and tube cleaning brushes



PART #	DESCRIPTION	UNIT ORDER	INN/MAS	PACK	LIST
85321N	4-In-1 Cleaning Brush	1	-/12	BULK	15.54

### ACID BRUSH

- Tin handle
- Sold per bag of 6



PART #	DESCRIPTION	UNIT ORDER	INN/MAS	PACK	LIST
86297	#1 Size — 3/8" Width	1	10/150	BAG	2.45

### ACID BRUSH

- Tin handle
- Sold per box of 144



PART #	DESCRIPTION	UNIT ORDER	INN/MAS	PACK	LIST
45211	#1 Size — 3/8" Width	1	1/12	BOX	33.49
45213	#2 Size — 1/2" Width	1	1/12	BOX	35.41

### COPPER TUBE BRUSH

- For cleaning outside of copper tube
- Nonslip grip outer cover



PART #	DESCRIPTION	UNIT ORDER	INN/MAS	PACK	LIST
45266	1/2"	20	20/200	BOX	2.74
45267	3/4"	20	20/200	BOX	2.88
45268	1"	20	20/200	BOX	3.19

## Solder Accessories

### EMERY CLOTH - BROWN

- 120 Grit



PART #	DESCRIPTION	UNIT ORDER	INN/MAS	PACK	LIST
45201	1-1/2" x 10 Yards	1	1/100	BOX	6.10

### WATERPROOF EMERY CLOTH - BLUE

- 120 Grit



PART #	DESCRIPTION	UNIT ORDER	INN/MAS	PACK	LIST
45205	1-1/2" x 5 Yards	1	1/50	BOX	3.65

### STERLING® SAND CLOTH - TARAMET

- 120 Grit
- Water-resistant



PART #	DESCRIPTION	UNIT ORDER	INN/MAS	PACK	LIST
85314	1-1/2" x 2 Yards	1	1/36	BOX	2.45
85315	1-1/2" x 5 Yards	1	1/12	BOX	6.10
85316	1-1/2" x 10 Yards	1	1/6	BOX	9.55
85317	1-1/2" x 25 Yards	1	1/6	BOX	18.96

### STERLING® MESH SAND CLOTH - TARAMET

- 180 Grit
- Waterproof



PART #	DESCRIPTION	UNIT ORDER	INN/MAS	PACK	LIST
85318	1-1/2" x 2 Yards	1	1/36	BOX	4.99
85319	1-1/2" x 5 Yards	1	1/12	BOX	10.89
85320	1-1/2" x 10 Yards	1	1/6	BOX	17.53

## Torches

### PROPANE FUEL CYLINDER

- 14.1 oz propane cylinder



PART #	DESCRIPTION	UNIT ORDER	INN/MAS	PACK	LIST
85353	Refill for Most Propane Appliances	12	1/12	BOX	13.03

### MAPP GAS FUEL CYLINDER

- Hotter burn than propane



PART #	DESCRIPTION	UNIT ORDER	INN/MAS	PACK	LIST
85354	Refill for Most MAPP Gas Appliances	12	-/12	BOX	17.36

### FLINT TORCH LIGHTER



85355



45209

PART #	DESCRIPTION	UNIT ORDER	INN/MAS	PACK	LIST
45209	Round File Replaceable Flint	1	25/200	BULK	3.62
85355	Magna Flint Renewal 5 per Card	1	-/12	BULK	7.41

### PROPANE PENCIL-TIP TORCH

- Brass pencil-tip burner
- Replaceable orifice
- Brass adjustable flame control knob
- Brass valve body
- Basic-use torch



Mag-Torch

PART #	DESCRIPTION	UNIT ORDER	INN/MAS	PACK	LIST
85216	Propane Pencil-Tip Torch	1	-/12	BULK	26.00

### SWIVEL TORCH - SELF-LIGHTING MAPP/PROPANE

- All brass body with stainless steel burn tube
- 360° Swivel with adjustable flame control
- Target heat: Propane - 1700° F, MAPP 2400° F



Mag-Torch

PART #	DESCRIPTION	UNIT ORDER	INN/MAS	PACK	LIST
85357	MAPP/Propane Torch Instant Flame Auto Lighter	1	-/6	BULK	81.46

### MAPP/PROPANE HEAVY-DUTY PENCIL-TIP BURNER TORCH

- For use on high heat jobs



Mag-Torch

PART #	DESCRIPTION	UNIT ORDER	INN/MAS	PACK	LIST
85358	Brass Torch	1	-/6	BULK	45.96

Supply Connectors

Stop Valves

Water Heater

Gas Connectors

Water Filtration

Sinks/Faucets

Tubular/Drainage

Faucet Repair

Bath Accessories

Pipe Fittings/Repair

Valves

Cements/Sealants

Tools/Safety

Toilet Repair

Appliance/HVAC

Hardware

Electrical

Index

# CEMENTS AND SEALANTS

## Cements

### PVC CEMENT - CLEAR REGULAR BODY

- Fast setting PVC cement for all classes & schedules through 4" diameter (except schedule 80)
- Approved for use on PVC foam core pipe
- Meets ASTM D-2564
- Low VOC



PART #	DESCRIPTION	UNIT ORDER	INN/MAS	PACK	LIST
87204	1/4 Pint	24	-/24	BULK	4.85
87205	1/2 Pint	24	-/24	BULK	6.70
87206	Pint	12	-/12	BULK	13.14
87207	Quart	12	-/12	BULK	21.47
87208	Gallon	6	-/6	BULK	78.55

### PVC CEMENT - CLEAR MEDIUM BODY

- Fast setting PVC cement for all classes through 6" Schedule 80 through 4"
- Approved for use on PVC foam core pipe
- Meets ASTM D-2564
- Low VOC



PART #	DESCRIPTION	UNIT ORDER	INN/MAS	PACK	LIST
76209	1/4 Pint	24	-/24	BULK	5.10
76210	1/2 Pint	24	-/24	BULK	7.19
76211	Pint	12	-/12	BULK	12.77
76212	Quart	12	-/12	BULK	20.96

### PVC CEMENT - CLEAR REGULAR BODY

- Fast setting PVC cement for all classes & schedules through 4" diameter (except schedule 80)
- Approved for use on PVC foam core pipe
- Meets ASTM D-2564
- Low VOC



PART #	DESCRIPTION	UNIT ORDER	INN/MAS	PACK	LIST
76204	1/4 Pint	24	-/24	BULK	4.48
76205	1/2 Pint	24	-/24	BULK	5.84
76206	Pint	12	-/12	BULK	12.32
76207	Quart	12	-/12	BULK	18.53
76208	Gallon	6	-/6	BULK	62.07

### PVC CEMENT - CLEAR HEAVY BODY

- Medium setting PVC cement for all classes & schedules through 12", including schedule 80
- Great gap filling properties - allows for more working time in warmer weather
- Meets ASTM D-2564
- Low VOC



PART #	DESCRIPTION	UNIT ORDER	INN/MAS	PACK	LIST
87213	1/2 Pint	24	-/24	BULK	9.81
87214	Pint	12	-/12	BULK	16.14
87215	Quart	12	-/12	BULK	26.20

### PVC CEMENT - CLEAR MEDIUM BODY

- Clear
- Fast setting PVC cement for all classes through 6" Schedule 80 through 4"
- Approved for use on PVC foam core pipe
- Meets ASTM D-2564
- Low VOC



PART #	DESCRIPTION	UNIT ORDER	INN/MAS	PACK	LIST
87209	1/4 Pint	24	-/24	BULK	6.13
87210	1/2 Pint	24	-/24	BULK	8.98
87211	Pint	12	-/12	BULK	14.80
87212	Quart	12	-/12	BULK	23.95

### PVC CEMENT - CLEAR HEAVY BODY

- Medium setting PVC cement for all classes & schedules through 12", including schedule 80
- Great gap filling properties - allows for more working time in warmer weather
- Meets ASTM D-2564



PART #	DESCRIPTION	UNIT ORDER	INN/MAS	PACK	LIST
76213	1/2 Pint	24	-/24	BULK	8.33
76214	Pint	12	-/12	BULK	13.83
76215	Quart	12	-/12	BULK	22.18



## Cements

### PVC HOT 'R COLD™ CEMENT - CLEAR MEDIUM BODY

- Cold weather product will perform to (-15° F)
- Extremely fast setting, PVC cement for all classes & schedules through 6", schedule 80 through 4"
- Meets ASTM D-2564
- Low VOC



PART #	DESCRIPTION	UNIT ORDER	INN/MAS	PACK	LIST
86216	Pint	12	-/12	BULK	17.02
86217	Quart	12	-/12	BULK	26.37

### WET 'N FAST™ PVC CEMENT - BLUE MEDIUM BODY

- For PVC - All classes & schedules through 6", schedule 80 through 4"
- Very fast setting
- Meets ASTM D-2564
- For rigid or flexible applications, wet conditions and/or quick pressurization
- Low VOC



PART #	DESCRIPTION	UNIT ORDER	INN/MAS	PACK	LIST
86241	1/4 Pint	24	-/24	BULK	6.59
86242	1/2 Pint	24	-/24	BULK	9.92
86243	Pint	12	-/12	BULK	17.02
86244	Quart	12	-/12	BULK	28.17

### ALL-CLIMATE PVC CEMENT - BLUE REGULAR BODY

- For PVC - All classes & schedules through 6", schedule 80 through 4"
- Very fast setting
- Meets ASTM D-2564
- For rigid or flexible applications, wet conditions and/or quick pressurization
- Low VOC



PART #	DESCRIPTION	UNIT ORDER	INN/MAS	PACK	LIST
76241	1/4 Pint	24	-/24	BULK	5.70
76242	1/2 Pint	24	-/24	BULK	8.53
76243	Pint	12	-/12	BULK	15.82
76244	Quart	12	-/12	BULK	27.80

### ABS CEMENT - BLACK MEDIUM BODY

- Fast setting - for all classes & schedules through 8"
- Meets ASTM D-2235
- Low VOC



PART #	DESCRIPTION	UNIT ORDER	INN/MAS	PACK	LIST
86226	1/4 Pint	24	-/24	BULK	7.84
86227	1/2 Pint	24	-/24	BULK	10.41
86228	Pint	12	-/12	BULK	12.97
86229	Quart	12	-/12	BULK	20.81
86230	Gallon	6	-/6	BULK	76.98

### ABS CEMENT - BLACK MEDIUM BODY

- Fast setting - for all classes & schedules through 8"
- Meets ASTM D-2235
- Low VOC



PART #	DESCRIPTION	UNIT ORDER	INN/MAS	PACK	LIST
76227	1/2 Pint	24	-/24	BULK	7.95
76228	Pint	12	-/12	BULK	11.09
76229	Quart	12	-/12	BULK	18.19

### 713™ CPVC CEMENT - ORANGE REGULAR BODY

- Regular bodied, fast-setting, orange CPVC cement
- Designed for copper tube size and schedule 40 CPVC pipe and fittings with interference fit through 2" diameter
- For potable water to 180° F
- Meets ASTM D-2846, ASTM F-493, NSF/ANSI 14, NSF/ANSI 61
- Low VOC



PART #	DESCRIPTION	UNIT ORDER	INN/MAS	PACK	LIST
87245	1/4 Pint	24	-/24	BULK	6.02
87246	1/2 Pint	24	-/24	BULK	8.13
87247	1 Pint	12	-/12	BULK	18.33
87248	1 Quart	12	-/12	BULK	29.08

Supply Connectors

Stop Valves

Water Heater

Gas Connectors

Water Filtration

Sinks/Faucets

Tubular/Drainage

Faucet Repair

Bath Accessories

Pipe Fittings/Repair

Valves

Cements/Sealants

Tools/Safety

Toilet Repair

Appliance/HVAC

Hardware

Electrical

Index

# CEMENTS AND SEALANTS

## Cements

### CPVC CEMENT - ORANGE REGULAR BODY

- Regular bodied, fast-setting, orange CPVC cement
- Designed for copper tube size and schedule 40 CPVC pipe and fittings with interference fit through 2" diameter
- Specially formulated for plumbing applications
- For potable water to 180° F (82° C)
- Meets ASTM D-2846
- Low VOC



PART #	DESCRIPTION	UNIT ORDER	INN/MAS	PACK	LIST
76245	1/4 Pint	24	-/24	BULK	4.73
76247	1 Pint	12	-/12	BULK	13.14

### WELD-ON® MULTIPURPOSE CLEAR CEMENT - MEDIUM BODY

- Fast setting ABS, PVC, CPVC & Styrene all classes & schedules through 6" diameter except schedule 80
- Meets ASTM F-493
- Low VOC



PART #	DESCRIPTION	UNIT ORDER	INN/MAS	PACK	LIST
86231	1/4 Pint	24	-/24	BULK	6.53
86232	1/2 Pint	24	-/24	BULK	9.69
86233	Pint	12	-/12	BULK	16.91
86234	Quart	12	-/12	BULK	26.37

### FLOWGUARD GOLD® CPVC CEMENT - YELLOW MEDIUM BODY

- Fast setting
- For CPVC pipe through 2" (if codes permit)
- Meets ASTM F-493 and ASTM D-2846
- Low VOC



PART #	DESCRIPTION	UNIT ORDER	INN/MAS	PACK	LIST
86237	1/4 Pint	24	-/24	BULK	8.21
86238	1/2 Pint	24	-/24	BULK	12.20
86239	Pint	12	-/12	BULK	20.67
86240	Quart	12	-/12	BULK	34.93

### MULTIPURPOSE CLEAR CEMENT - MEDIUM BODY

- Fast setting ABS, PVC, CPVC & Styrene all classes & schedules through 6" diameter except schedule 80
- Exceeds ASTM D-2235, D-2564 & F-493
- Low VOC



PART #	DESCRIPTION	UNIT ORDER	INN/MAS	PACK	LIST
76231	1/4 Pint	24	-/24	BULK	5.33
76232	1/2 Pint	24	-/24	BULK	8.15
76233	Pint	12	-/12	BULK	13.91
76234	Quart	12	-/12	BULK	22.67

### FLOWGUARD GOLD® CPVC CEMENT - YELLOW MEDIUM BODY

- Fast setting
- For CPVC pipe through 2" (if codes permit)
- Meets ASTM F-493 and ASTM D-2846
- Low VOC

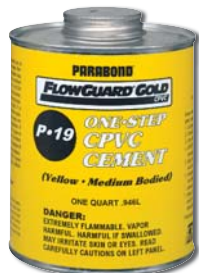

PART #	DESCRIPTION	UNIT ORDER	INN/MAS	PACK	LIST
76237	1/4 Pint	24	-/24	BULK	6.81
76238	1/2 Pint	24	-/24	BULK	10.55
76239	Pint	12	-/12	BULK	16.68
76240	Quart	12	-/12	BULK	29.74

## Primers and Cleaners

### WELD-ON® PURPLE PRIMER - LOW VOC

- For surface preparation on PVC & CPVC pipe and fittings
- Before cement application
- Meets ASTM F-656



PART #	DESCRIPTION	UNIT ORDER	INN/MAS	PACK	LIST
87235	Pint	12	-/12	BULK	16.19
87236	Quart	12	-/12	BULK	23.75

## Primers and Cleaners

### PURPLE PRIMER - LOW VOC

- For surface preparation on PVC & CPVC pipe and fittings
- Before cement application
- Meets ASTM F-656



PART #	DESCRIPTION	UNIT ORDER	INN/MAS	PACK	LIST
76216	1/4 Pint	24	-/24	BULK	5.39
76217	1/2 Pint	24	-/24	BULK	7.36
76235	Pint	12	-/12	BULK	13.14
76236	Quart	12	-/12	BULK	19.96

### WELD-ON® PURPLE PRIMER-CONDITIONER - ALL-PURPOSE LOW VOC

- For PVC, CPVC pipe application
- Fast-acting cleaner removes dirt & grease
- Meets SCAQMD 1168/316A & ASTM F-656



PART #	DESCRIPTION	UNIT ORDER	INN/MAS	PACK	LIST
86218	1/4 Pint	24	-/24	BULK	6.24
86219	1/2 Pint	24	-/24	BULK	8.98
86220	Pint	12	-/12	BULK	15.11
86221	Quart	12	-/12	BULK	27.03

### CLEAR PRIMER

- For PVC & CPVC surface preparation
- Before cement application
- Meets ASTM F-656
- Low VOC



PART #	DESCRIPTION	UNIT ORDER	INN/MAS	PACK	LIST
87274	1/4 Pint	24	-/24	BULK	5.79
87275	1/2 Pint	24	-/24	BULK	8.50
87276	Pint	12	-/12	BULK	16.39
87277	Quart	12	-/12	BULK	23.75

### PURPLE PRIMER-CLEANER - ALL-PURPOSE LOW VOC

- For PVC, CPVC pipe application
- Fast acting cleaner removes dirt & grease
- Meets SCAQMD 1168/316A & ASTM F-656



PART #	DESCRIPTION	UNIT ORDER	INN/MAS	PACK	LIST
76218	1/4 Pint	24	-/24	BULK	4.99
76219	1/2 Pint	24	-/24	BULK	8.15
76220	Pint	12	-/12	BULK	12.77
76221	Quart	12	-/12	BULK	20.50

### CLEAR PRIMER

- For PVC & CPVC surface preparation
- Before cement application
- Meets ASTM F-656
- Low VOC



PART #	DESCRIPTION	UNIT ORDER	INN/MAS	PACK	LIST
76274	1/4 Pint	24	-/24	BULK	5.65
76275	1/2 Pint	24	-/24	BULK	9.27
76276	Pint	12	-/12	BULK	11.78
76277	Quart	12	-/12	BULK	19.67

### WELD-ON® CLEAR CLEANER - LOW VOC

- For PVC, CPVC, ABS & Styrene
- Fast-acting cleaner removes dirt and grease



PART #	DESCRIPTION	UNIT ORDER	INN/MAS	PACK	LIST
86223	1/2 Pint	24	-/24	BULK	7.38
86224	Pint	12	-/12	BULK	12.12
86225	Quart	12	-/12	BULK	19.82

Supply Connectors

Stop Valves

Water Heater

Gas Connectors

Water Filtration

Sinks/ Faucets

Tubular/ Drainage

Faucet Repair

Bath Accessories

Pipe Fittings/ Repair

Valves

Cements/ Sealants

Tools/ Safety

Toilet Repair

Appliance/ HVAC

Hardware

Electrical

Index

# CEMENTS AND SEALANTS

## Primers and Cleaners

### CLEAR CLEANER - LOW VOC

- For PVC, CPVC, ABS & Styrene
- Fast-acting cleaner removes dirt and grease



PART #	DESCRIPTION	UNIT ORDER	INN/MAS	PACK	LIST
76222	1/4 Pint	24	-/24	BULK	4.79
76223	1/2 Pint	24	-/24	BULK	6.24
76224	Pint	12	-/12	BULK	10.78
76225	Quart	12	-/12	BULK	16.74

### PROFESSIONAL HAND CLEANER WIPES

- An advanced strong hard cleaner wipe for removing solvent cements (PVC, CPVC and ABS), primer and sealants
- For hands, tools and equipment
- Also removes dirt, oil, grease, roof mastics (tar) and much more



PART #	DESCRIPTION	UNIT ORDER	INN/MAS	PACK	LIST
50000	Hand Wipes	6	-/6	BULK	47.96

## Cement, Primer and Cleaner Accessories

### CAP DAUBER

- Replacement dauber
- For 1/2 pint or quart



PART #	DESCRIPTION	UNIT ORDER	INN/MAS	PACK	LIST
86202	Fits 1/2 Pint & Up to 1-1/2" Pipe	10	-/50	BULK	1.05
86203	Fits 1 Quart & Up to 3" Pipe	10	-/50	BULK	1.63

### ADJUSTABLE PLASTIC DAUBER

- Adjustable plastic dauber
- Telescoping stem - fits all cans with 1-3/4" mouth except gallons



PART #	DESCRIPTION	UNIT ORDER	INN/MAS	PACK	LIST
86200	3/4"	5	-/50	BULK	5.65
86201	1-1/2"	5	-/50	BULK	6.76

### WELD-ON® EASY TWIST™ CAN OPENER

**NEW**

- Serrated inner edges provide a solid "grip" making can opening and closing easy
- Flat-edge handle used to open paint-style solvent cement cans
- No more damaged caps or dried out cements and primers
- Not to be used on wide mouth gallon cans



PART #	DESCRIPTION	UNIT ORDER	INN/MAS	PACK	LIST
86150	2" Can Opener	1	-/8	BULK	9.58

## Roof Flashing

### ROOF FLASHING CEMENT - BLACK

- Wet or dry weather plastic cement
- For repairing and sealing leaks around flashings, sky lights, vents, gutters and other protrusions
- Asbestos-free



PART #	DESCRIPTION	UNIT ORDER	INN/MAS	PACK	LIST
87200	1 Quart	1	-/12	BOX	19.39
87201	1 Gallon	1	-/4	BOX	41.09

## Shower Pan

### SHOWER PAN LINER - 40 MIL PVC

- SBCCI BUCA approved



PART #	DESCRIPTION	UNIT ORDER	INN/MAS	PACK	LIST
86266	4' x 50'	1	-/1	BOX	306.45
86267	5' x 40'	1	-/1	BOX	306.45
86281	6' x 50'	1	-/1	BOX	381.03
86313	5' x 100'	1	-/1	BOX	660.96

### WELD-ON® SHOWER PAN SOLVENT - PVC

- For shower pan liners
- Low VOC



PART #	DESCRIPTION	UNIT ORDER	INN/MAS	PACK	LIST
86268	Pint	12	-/12	BULK	17.53

# CEMENTS AND SEALANTS

## Tub Boxes

### PLASTIC TUB BOXES

- 13" x 13" Top OD - #86098
- 12" x 8" Top OD - #86099



PART #	DESCRIPTION	UNIT ORDER	INN/MAS	PACK	LIST
86098	Large 7"	1	-/20	BULK	8.63
86099	Small 6-1/2"	1	-/20	BULK	7.08

## Tape

### TEFLON® PIPE THREAD TAPE

- 3.5 mil



PART #	DESCRIPTION	UNIT ORDER	INN/MAS	PACK	LIST
50011	1/2" x 260"	120	120/600	BULK	0.46
50013	1/2" x 520"	120	120/600	BULK	0.63
50021	3/4" x 260"	120	120/600	BULK	0.88
50023	3/4" x 520"	120	120/600	BULK	0.94
50031	1" x 520"	120	120/600	BULK	1.23

### TEFLON® PIPE THREAD TAPE - GAS (YELLOW)

- Yellow tape for gas lines
- 4 mil



PART #	DESCRIPTION	UNIT ORDER	INN/MAS	PACK	LIST
50033	1/2" x 260"	120	120/600	BULK	1.68

### PVC PIPE WRAP TAPE

- 10 mil
- Protects metal piping systems against corrosion



PART #	DESCRIPTION	UNIT ORDER	INN/MAS	PACK	LIST
50043	2" x 50'	1	-/48	BULK	4.70
50045	2" x 100'	1	-/54	BULK	9.64

### ALUMINUM FOIL TAPE

- 3.0 mil
- Rated to 250° F
- Self-adhesive



PART #	DESCRIPTION	UNIT ORDER	INN/MAS	PACK	LIST
50099	2" x 50 Yards	1	-/24	BULK	17.53

### DUCT TAPE - CLOTH REINFORCED

- 2" Width



PART #	DESCRIPTION	UNIT ORDER	INN/MAS	PACK	LIST
50087	Silver - 60 Yards — 8.5 mil	24	-/24	BULK	10.92
50088	Black - 60 Yards — 9 mil	24	-/24	BULK	12.77

### PVC ELECTRICAL TAPE

- 60' Length
- UL approved



PART #	DESCRIPTION	UNIT ORDER	INN/MAS	PACK	LIST
50059	3/4" - 7.5 mil	10	10/200	BULK	1.23

## Sealants

### STAINLESS PLUMBER'S PUTTY

- Stays pliable and flexible - will not shrink, bleed, harden, crack or crumble
- Use for setting toilet bowls, fixtures, faucets, strainers, sink frames & many other sealing and caulking applications
- Gas-proof, odor-proof and water-resistant



PART #	DESCRIPTION	UNIT ORDER	INN/MAS	PACK	LIST
45375	14 oz.	1	-/24	BULK	2.71
45377	5 lb.	1	-/6	BULK	10.64

### PIPE JOINT COMPOUND

- Smooth, grit-free, gray color
- Seals threaded joints tight and will not crack or crumble
- Contains no lead and is safe for all water systems



50003

50005



PART #	DESCRIPTION	UNIT ORDER	INN/MAS	PACK	LIST
50003	2 oz. Tube	1	24/72	BULK	1.80
50005	1/2 Pint Can with Brush	1	6/24	BULK	5.02

# CEMENTS AND SEALANTS

## Sealants

### PLUMBER'S GREASE

- Protects against rust, oxidation and corrosion
- Lubricates stems, valves, ballcocks, etc.
- Waterproof, will not melt



PART #	DESCRIPTION	UNIT ORDER	INN/MAS	PACK	LIST
50001	1 oz.	1	12/24	BULK	2.57

### NO. 5® PIPE THREAD SEALANT

- Soft-set, slow-drying compound
- Conforms to TT-S-1732



PART #	DESCRIPTION	UNIT ORDER	INN/MAS	PACK	LIST
86291	1/4 Pint	24	-/24	BULK	14.03
86292	1/2 Pint	24	-/24	BULK	20.73
86293	1 Pint	12	-/12	BULK	31.85

### SWAN SEAL THREAD SEALANT

- A white, smooth, grit-free, homogenized PTFE pipe joint compound
- Forms a film of PTFE over the threaded surface for lasting protection against leaks, will not harden, crack or crumble
- Meets federal specification TT-S-1732 NSF certified
- Temperature range use: -50° F (-46° C) to +400° F (+204° C)
- Pressure range use: gases up to 3000 PSI, liquids up to 10,000 PSI



PART #	DESCRIPTION	UNIT ORDER	INN/MAS	PACK	LIST
86307	1/4 Pint	1	-/24	BULK	9.12
86308	1/2 Pint	1	-/12	BULK	12.43
86309	Pint	1	-/12	BULK	20.96

### ALL-PURPOSE PIPE DOPE

- A yellow, soft-set, nontoxic pipe joint compound
- Provides leak-proof resistance to high pressure, temperature expansion, contraction and extreme vibration
- Temperature range use: gases and liquids -50° F (-46° C) to +400° F (+204° C)
- Pressure range: gases up to 3000 PSI, liquids up to 6000 PSI



PART #	DESCRIPTION	UNIT ORDER	INN/MAS	PACK	LIST
86304	1/4 Pint	1	-/24	BULK	6.87
86305	1/2 Pint	1	-/12	BULK	10.24
86306	Pint	1	-/12	BULK	15.97

### BIG BLUE THREAD SEALANT

- A blue, soft-set, nontoxic pipe joint compound
- Provides leak-proof resistance to high pressure, temperature expansion, contraction and extreme vibration
- Temperature range use: gases & liquids -50° F (-46° C) to +400° F (+204° C)
- Pressure range: gases up to 3000 PSI, liquids up to 6000 PSI



PART #	DESCRIPTION	UNIT ORDER	INN/MAS	PACK	LIST
86310	1/4 Pint	1	-/24	BULK	8.15
86311	1/2 Pint	1	-/12	BULK	11.06
86312	Pint	1	-/12	BULK	20.59

### TRU-BLU™ PIPE THREAD SEALANT WITH TEFLON®

- Vibration-resistant
- Fast-dry, flexible-set sealant
- Conforms to TT-S-1732



PART #	DESCRIPTION	UNIT ORDER	INN/MAS	PACK	LIST
86289	1/2 Pint	24	-/24	BULK	18.36
86290	1 Pint	12	-/12	BULK	30.37

### T PLUS 2® TEFLON® ENRICHED THREAD SEALANT

- Conforms to TT-S-1732
- Not for use on LP
- May be pressurized immediately following application



PART #	DESCRIPTION	UNIT ORDER	INN/MAS	PACK	LIST
86285	1/4 Pint	24	-/24	BULK	13.09
86286	1/2 Pint	24	-/24	BULK	21.58
86287	1 Pint	12	-/12	BULK	33.84

### GAS LEAK DETECTOR

- Plastic bottle with applicator
- Formulated to locate gas leaks in pipe lines, pressure vessels, cylinders, tanks, etc.
- Use to find leaks of air, natural gas, refrigerants, CO2 and most other gases
- After application large bubbles will appear if there is gas escaping



PART #	DESCRIPTION	UNIT ORDER	INN/MAS	PACK	LIST
50039	8 oz.	12	-/12	BULK	9.49

## Sealants

### DARK CUTTING OIL

- Formulated to work on high-speed machines
- Ideal for stripping, broaching, or milling applications
- Anti-mist lubricant
- Quality of oil remains uniform at all times



**NEW**



PART #	DESCRIPTION	UNIT ORDER	INN/MAS	PACK	LIST
55190	1 Gallon	1	-/6	BOX	42.34

### ZOOM-SPOUT® OILER

- High-grade turbine oil
- Spout adjusts to 14" length



PART #	DESCRIPTION	UNIT ORDER	INN/MAS	PACK	LIST
55191	4 oz. Squeeze Bottle	12	12/72	BULK	2.57

### KITCHEN & BATH SILICONIZED ACRYLIC CAULK

- Odorless, mildew-resistant formula fortified with silicone to provide a long-lasting watertight seal around tubs, showers, sinks and fixtures
- Interior use
- Water cleanup
- 35-Year limited warranty

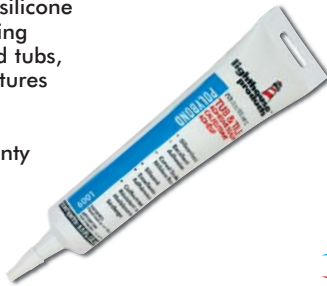

PART #	DESCRIPTION	UNIT ORDER	INN/MAS	PACK	LIST
95058	5.5 oz. Tube - White	12	-/12	BULK	3.74

### ACRYLIC LATEX CAULK

- General-purpose economical caulk for use on masonry, painted, unpainted wood and most siding
- Interior/exterior use
- Water cleanup
- 5-Year limited warranty



PART #	DESCRIPTION	UNIT ORDER	INN/MAS	PACK	LIST
95060	10 oz. Cartridge	12	-/12	BULK	3.19

### MAX EXPANDING FOAM SEALANT

- Fills & insulates holes
- Blocks insects and other pests
- Water- and fire-resistant



PART #	DESCRIPTION	UNIT ORDER	INN/MAS	PACK	LIST
95100	12 oz	12	-/12	BULK	10.21
95101	20 oz	12	-/12	BULK	14.28

### MIN EXPANDING FOAM SEALANT

- Fills & insulates gaps & cracks
- Dries in 30 minutes
- Water- and fire-resistant



PART #	DESCRIPTION	UNIT ORDER	INN/MAS	PACK	LIST
95102	12 oz	12	-/12	BULK	11.80

### DAPTX PLUS® MULTIPURPOSE FOAM SEALANT

- Easy water cleanup
- Latex polymer technology
- Water-resistant and paintable
- Remains soft and flexible when dry



PART #	DESCRIPTION	UNIT ORDER	INN/MAS	PACK	LIST
58199	12 oz	12	-/12	BULK	13.57

### 100% RTV SILICONE SEALANT

- Available in clear, white and aluminum
- FDA and USDA approved
- Permanently flexible
- Excellent mold and mildew resistance



PART #	DESCRIPTION	UNIT ORDER	INN/MAS	PACK	LIST
90131	Polysil® Silicone - Clear	1	-/12	BULK	9.01
90132	Polysil® Silicone - White	1	-/12	BULK	9.01
90133	Polysil® Silicone - Aluminum	1	-/12	BULK	9.01

Supply Connectors

Stop Valves

Water Heater

Gas Connectors

Water Filtration

Sinks/ Faucets

Tubular/ Drainage

Faucet Repair

Bath Accessories

Pipe Fittings/ Repair

Valves

Cements/ Sealants

Tools/ Safety

Toilet Repair

Appliance/ HVAC

Hardware

Electrical

Index

# CEMENTS AND SEALANTS

## Sealants

### HI-TEMP RED SILICONE SEALANT

- For use on application up to 600° F
- FDA and USDA approved
- Permanently flexible
- Excellent mold and mildew resistance



PART #	DESCRIPTION	UNIT ORDER	INN/MAS	PACK	LIST
90134	Polysil® Hi-Temp Red Silicone	1	-/12	BULK	16.14

### HIGH TEMP RED SILICONE SEALANT

- Ideal for flue pipes and other high-temperature applications
- Remains flexible up to 550° F (intermittent)
- Will not crack or shrink
- Weather-resistant



PART #	DESCRIPTION	UNIT ORDER	INN/MAS	PACK	LIST
58193	10.3 oz - Red	12	-/12	BULK	12.09

### KWIK SEAL® ADHESIVE SEALANT

- Cured caulk is mold- and mildew-resistant
- Paintable
- Easy water cleanup
- Waterproof seal



PART #	DESCRIPTION	UNIT ORDER	INN/MAS	PACK	LIST
59150	5.5 oz - White	1	-/12	BULK	5.13
59151	5.5 oz - Almond	1	-/12	BULK	5.13
59159	5.5 oz - Clear	1	-/12	BULK	5.13

### KWIK SEAL® ADHESIVE SEALANT

- Cured caulk is mold- and mildew-resistant
- Paintable
- Easy water cleanup
- Waterproof seal



PART #	DESCRIPTION	UNIT ORDER	INN/MAS	PACK	LIST
59152	10 oz - White	1	-/12	BULK	9.84
59162	10 oz - Clear	1	-/12	BULK	9.84

### KWIK SEAL PLUS® ADHESIVE SEALANT

- Cured caulk is mold- and mildew-resistant
- Paintable
- Easy water cleanup
- Waterproof seal



PART #	DESCRIPTION	UNIT ORDER	INN/MAS	PACK	LIST
59153	5.5 oz - White	1	-/12	BULK	8.33
59160	5.5 oz - Clear	1	-/12	BULK	8.33
59161	5.5 oz - Biscuit	1	-/12	BULK	8.33

### KWIK SEAL ULTRA® PREMIUM SILICONIZED SEALANT

- Repels water, dirt, and soap scum
- Crack- and stain-proof
- 4-Hour water ready
- 100% Waterproof
- Lifetime mold and mildew guarantee
- Easy to use



PART #	DESCRIPTION	UNIT ORDER	INN/MAS	PACK	LIST
59127	5.5 oz - White	1	-/12	BULK	10.04
59128	5.5 oz - Clear	1	-/12	BULK	10.04

### KWIK SEAL ULTRA® PREMIUM SILICONIZED SEALANT

- Repels water, dirt, and soap scum
- Crack- and stain-proof
- 4-Hour water ready
- 100% Waterproof
- Lifetime mold and mildew guarantee
- Easy to use



PART #	DESCRIPTION	UNIT ORDER	INN/MAS	PACK	LIST
59129	10 oz - White	1	-/12	BULK	12.09
59130	10 oz - Clear	1	-/12	BULK	12.09

### KITCHEN AND BATH SILICONE RUBBER SEALANT

- 100% Silicone rubber sealant provides excellent durability, flexibility, and adhesion for a long-lasting, waterproof seal around non-porous surfaces such as ceramic tile and plumbing fixtures
- Cured sealant is mildew-resistant



PART #	DESCRIPTION	UNIT ORDER	INN/MAS	PACK	LIST
58143	10 oz - White	1	-/12	BULK	9.92
58144	10 oz - Clear	1	-/12	BULK	9.92



## Sealants

### 3.0 ADHESIVE SEALANT

- Formulated with Microban to fight mold and mildew
- Waterproof in 30 minutes
- Easy to clean and stays cleaner
- Lifetime guarantee



PART #	DESCRIPTION	UNIT ORDER	INN/MAS	PACK	LIST
58172	9 oz - White	1	-/12	BULK	11.55
58173	9 oz - Clear	1	-/12	BULK	15.31

### SIMPLE SEAL™ KITCHEN AND BATH SEALANT

- No caulk gun needed
- Waterproof and paintable
- Easy to handle and navigate
- Mold- and mildew-resistant
- Easy water cleanup



PART #	DESCRIPTION	UNIT ORDER	INN/MAS	PACK	LIST
58190	9 oz	1	-/9	BULK	9.58

### 100% SILICONE SEALANT

- Excellent durability
- High flexibility
- 100% Waterproof
- Mildew-resistant



PART #	DESCRIPTION	UNIT ORDER	INN/MAS	PACK	LIST
58170	10 oz - White	1	-/12	BULK	9.92
58171	10 oz - Clear	1	-/12	BULK	9.92

### ALEX® PAINTER'S ACRYLIC LATEX SEALANT

- Paintable
- Flexible
- Easy water cleanup
- Indoor/outdoor use



PART #	DESCRIPTION	UNIT ORDER	INN/MAS	PACK	LIST
59157	10 oz - White	1	-/12	BULK	4.68

### ALEX® PAINTER'S ACRYLIC LATEX SILICONE SEALANT

- Waterproof seal
- Paintable
- Cured caulk is mold- and mildew-resistant
- Excellent flexibility
- Easy water cleanup
- Indoor/outdoor use



PART #	DESCRIPTION	UNIT ORDER	INN/MAS	PACK	LIST
59156	5.5 oz - White	1	-/12	BULK	6.39

### ALEX® PAINTER'S ACRYLIC LATEX SILICONE SEALANT

- Waterproof seal
- Paintable
- Cured caulk is mold- and mildew-resistant
- Excellent flexibility
- Easy water cleanup
- Indoor/outdoor use



PART #	DESCRIPTION	UNIT ORDER	INN/MAS	PACK	LIST
59154	10 oz - White	1	-/12	BULK	5.02
59155	10 oz - Almond	1	-/12	BULK	6.24
59158	10 oz - Clear	1	-/12	BULK	6.70

### DYNAFLEX 230® PREMIUM SEALANT

- Indoor/outdoor premium latex sealant
- Waterproof and paintable
- Ideal for a wide variety of applications such as sealing around windows, doors, siding, trim, molding and baseboards



PART #	DESCRIPTION	UNIT ORDER	INN/MAS	PACK	LIST
58148	10 oz - White	1	-/12	BULK	9.87
58149	10 oz - Clear	1	-/12	BULK	9.87

### FLEXIBLE SEALANT

- High-performance, elastomeric clear sealant
- Excellent adhesion even on damp surfaces
- Indoor/outdoor use
- Cured sealant is mildew-resistant
- Paintable



PART #	DESCRIPTION	UNIT ORDER	INN/MAS	PACK	LIST
58169	10 oz - Clear	1	-/12	BULK	18.82

Supply Connectors

Stop Valves

Water Heater

Gas Connectors

Water Filtration

Sinks/ Faucets

Tubular/ Drainage

Faucet Repair

Bath Accessories

Pipe Fittings/ Repair

Valves

Cements/ Sealants

Tools/ Safety

Toilet Repair

Appliance/ HVAC

Hardware

Electrical

Index

# CEMENTS AND SEALANTS

## Sealants

### FIRE STOP SEALANT

- Meets ASTM E 814/UL 1479 and UL 2079 specifications
- Classified for sealing fire-rated, non-combustible service penetrations and construction joints in horizontal and vertical fire separations
- Elastomeric - capable of +-25% dynamic joint movement



PART #	DESCRIPTION	UNIT ORDER	INN/MAS	PACK	LIST
58166	10 oz - Gray	1	-/12	BULK	26.12

### SEAL 'N PEEL® WEATHERSTRIP SEALANT

- Unique, removable weatherstrip caulk to seal drafty windows and doors
- Provides a temporary waterproof and weatherproof seal
- Peels away easily when removal is desired
- Indoor/outdoor use



PART #	DESCRIPTION	UNIT ORDER	INN/MAS	PACK	LIST
58165	10 oz - Clear	1	-/12	BULK	16.88

### BEATS THE NAIL® ALL-PURPOSE CONSTRUCTION ADHESIVE

- For general construction, remodeling, maintenance and repair projects
- Provides high-strength heat- and water-resistant bond to a variety of substrates
- Interior and exterior use



PART #	DESCRIPTION	UNIT ORDER	INN/MAS	PACK	LIST
58191	10.3 oz - Gray	12	-/12	BULK	4.68

### STIK-IT EPOXY PUTTY

- Hardens like steel in 20 minutes
- Can be drilled, filed, tapped, sanded and machined after 1 hour of curing
- Used for plumbing, electrical, ceramic and underwater repairs
- Convenient multipurpose sealing, patching and mending compound



PART #	DESCRIPTION	UNIT ORDER	INN/MAS	PACK	LIST
50004	4 oz Stick	1	-/24	BOX	9.38

### CAULK-BE-GONE® LATEX CAULK REMOVER

- Specially formulated gel softens caulks and sealants for easy removal
- Fast-acting formula, works in as little as two hours
- Fresh scent
- Will not harm most surfaces
- Interior/exterior use



PART #	DESCRIPTION	UNIT ORDER	INN/MAS	PACK	LIST
58147	5.5 oz - Green Gel	1	-/12	BULK	9.32

### DRYDEX® DRY TIME INDICATOR SPACKLING

- Goes on pink and turns white when ready to sand and paint
- Easy to use indoors and out on drywall, plaster, wood, and more



PART #	DESCRIPTION	UNIT ORDER	INN/MAS	PACK	LIST
58168	1 Quart	1	-/6	BULK	14.77

## Sealant Accessories

### CAULKING GUN

- Holds 9" caulking tube



PART #	DESCRIPTION	UNIT ORDER	INN/MAS	PACK	LIST
55401	Ratchet Style	1	-/24	BULK	4.79

## Batteries

### AAA PREMIUM ALKALINE BATTERY 24 PACK

- Compatible with any devices that use AAA batteries
- Ideal for high-drain devices
- Mercury- and cadmium-free



PART #	DESCRIPTION	UNIT ORDER	INN/MAS	PACK	LIST
40520	AAA - OEM #41-1636 - 24 Pack	1	12/48	BULK	15.08

## Hand Tools

### ADJUSTABLE WRENCH

- Professional quality
- Drop forged steel
- Coated handle



PART #	DESCRIPTION	UNIT ORDER	INN/MAS	PACK	LIST
40165	6"	6	6/120	CARD	6.50
40166	8"	6	6/60	CARD	7.57
40167	10"	6	6/24	CARD	12.05
40168	12"	6	6/24	CARD	12.91

### TONGUE AND GROOVE PLIERS

- Professional quality
- Drop forged steel
- Cushion grips



PART #	DESCRIPTION	UNIT ORDER	INN/MAS	PACK	LIST
40182	8"	6	6/36	CARD	7.58
40183	10"	6	6/24	CARD	11.01
40184	12"	6	6/24	CARD	12.31

### SLIP-JOINT PLIERS

- Professional quality
- Drop forged steel
- Cushion grips



PART #	DESCRIPTION	UNIT ORDER	INN/MAS	PACK	LIST
40179	6"	6	6/36	CARD	5.16
40181	8"	6	6/36	CARD	6.22

## LINEMAN PLIERS

- Professional quality
- Drop forged steel
- Cushion grips



PART #	DESCRIPTION	UNIT ORDER	INN/MAS	PACK	LIST
40169	7"	6	6/36	CARD	7.56
40171	8"	6	6/36	CARD	8.58

## DIAGONAL PLIERS

- Professional quality
- Drop forged steel
- Cushion grips



PART #	DESCRIPTION	UNIT ORDER	INN/MAS	PACK	LIST
40172	6-1/2"	6	6/36	CARD	6.67
40173	7-1/2"	6	6/36	CARD	7.04

## LONG NOSE PLIERS

- Professional quality
- Drop forged steel
- Cushion grips



PART #	DESCRIPTION	UNIT ORDER	INN/MAS	PACK	LIST
40174	5-1/2"	6	6/36	CARD	5.45
40175	6-1/2"	6	6/36	CARD	6.67
40176	8"	6	6/36	CARD	6.79

## LOCKING PLIERS

- Professional quality
- Drop forged steel
- Positive locking action
- Cushion grips



PART #	DESCRIPTION	UNIT ORDER	INN/MAS	PACK	LIST
40178	10"	6	6/24	CARD	12.00

Supply Connectors

Stop Valves

Water Heater

Gas Connectors

Water Filtration

Sinks/ Faucets

Tubular/ Drainage

Faucet Repair

Bath Accessories

Pipe Fittings/ Repair

Valves

Cements/ Sealants

Tools/ Safety

Toilet Repair

Appliance/ HVAC

Hardware

Electrical

Index

# TOOLS AND SAFETY

## Hand Tools

### UTILITY KNIFE

- Includes 2 blades



PART #	DESCRIPTION	UNIT ORDER	INN/MAS	PACK	LIST
55352	3-Position	1	12/144	CARD	4.79

### QUICK-CHANGE UTILITY KNIFE

- Quick blade release and change
- Blade storage in handle
- Professional quality



PART #	DESCRIPTION	UNIT ORDER	INN/MAS	PACK	LIST
40185	Quick-Change	12	12/72	CARD	9.15

### HEAVY-DUTY PIPE WRENCH

- Professional quality
- Enamel finish with cast-iron pipe handle



PART #	DESCRIPTION	UNIT ORDER	INN/MAS	PACK	LIST
40155	10"	6	6/36	BULK	11.83
40156	14"	6	6/24	BULK	14.74
40157	18"	3	3/6	BULK	20.59

### INDIVIDUAL SLOTTED SCREWDRIVER

- Cushion grip handles
- Chromium vanadium blade



PART #	DESCRIPTION	UNIT ORDER	INN/MAS	PACK	LIST
40197	1/4" x 6"	12	12/144	CARD	3.08
40198	5/16" x 6"	12	12/144	CARD	4.68

## Plumbing Tools

### FLARING TOOL

- For 3/16" to 5/8" tubing
- Vinyl pouch



PART #	DESCRIPTION	UNIT ORDER	INN/MAS	PACK	LIST
45033	Standard	1	12/24	POUCH	20.41

### TUBING CUTTER

- Cuts and deburs a large variety of pipe tubing
- Lightweight
- Mini tubing cutter for use in confined areas on copper, aluminum and mild steel



45029



45025

PART #	DESCRIPTION	UNIT ORDER	INN/MAS	PACK	LIST
45025	Standard Size Tubing Cutter 1/8" to 1-1/8"	1	10/60	BULK	8.98
45029	Mini Tubing Cutter 1/8" to 5/8"	1	10/60	BULK	6.56
45027	Mini Tubing Cutter 1/8" to 7/8"	1	10/60	BULK	7.64

### TUBING CUTTER

- Zip action



PART #	DESCRIPTION	UNIT ORDER	INN/MAS	PACK	LIST
45021	1/4" to 2-1/2"	1	6/36	BULK	46.76

## Plumbing Tools

### WATER METER KEY

- Used to turn on/off water supply valves
- Made from heavy-duty metal



PART #	DESCRIPTION	UNIT ORDER	INN/MAS	PACK	LIST
82652	1/2" x 36"	1	-/20	BOX	33.16
82653	3/4" x 36"	1	-/6	BOX	36.12

### WATER METER BOX KEY

- Brass construction
- Compact design



PART #	DESCRIPTION	UNIT ORDER	INN/MAS	PACK	LIST
82650	Water Meter Key Only	1	-/50	BULK	13.54

### WATER METER BOX KEY & WRENCH

- Brass construction
- Compact design
- Convenient 2-in-1 tool



PART #	DESCRIPTION	UNIT ORDER	INN/MAS	PACK	LIST
82651	Water Meter Key & Wrench	1	-/50	BULK	24.41

### GARBAGE DISPOSAL WRENCH

- Steel construction



PART #	DESCRIPTION	UNIT ORDER	INN/MAS	PACK	LIST
45101	Steel	1	25/50	BULK	8.30

### PLUMBER'S SOCKET SET

- Each socket fits two sizes
- Complete five-piece socket set



PART #	DESCRIPTION	UNIT ORDER	INN/MAS	PACK	LIST
45041	With Bar Handle	1	-/20	BOX	15.31

### NO-HUB TORQUE WRENCH

- 5/16" Hex socket for tightening nut on worm drive clamps of hub couplings or test caps
- 60 lb pressure release



PART #	DESCRIPTION	UNIT ORDER	INN/MAS	PACK	LIST
45061	Reversing Lever	1	10/100	BULK	18.53

### COMBINATION SPUD WRENCH

- Plated malleable iron body
- Adjustable size



PART #	DESCRIPTION	UNIT ORDER	INN/MAS	PACK	LIST
45111	Adjustable	1	20/40	BULK	13.89

### 4-IN-1 CLOSET SPUD WRENCH

- Steel construction

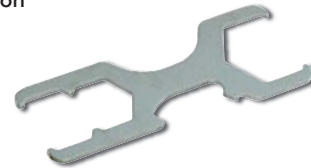

PART #	DESCRIPTION	UNIT ORDER	INN/MAS	PACK	LIST
45115	Steel Construction	1	5/20	BULK	7.33

### DUMBBELL WRENCH

- Install and remove tub drains without scratching the surface



PART #	DESCRIPTION	UNIT ORDER	INN/MAS	PACK	LIST
45089	Dumbbell Wrench	10	10/40	POUCH	17.51

### BASIN WRENCH

- Spring-loaded
- Hardened jaw



PART #	DESCRIPTION	UNIT ORDER	INN/MAS	PACK	LIST
45103	11"	1	20/40	BULK	10.04
45105	15"	1	20/40	BULK	11.53
45107	9" to 15" Adjustable	1	15/30	BULK	17.14

Supply Connectors

Stop Valves

Water Heater

Gas Connectors

Water Filtration

Sinks/ Faucets

Tubular/ Drainage

Faucet Repair

Bath Accessories

Pipe Fittings/ Repair

Valves

Cements/ Sealants

Tools/ Safety

Toilet Repair

Appliance/ HVAC

Hardware

Electrical

Index

# TOOLS AND SAFETY

## Plumbing Tools

### WATER HEATER ELEMENT WRENCH

- Includes bar handle



PART #	DESCRIPTION	UNIT ORDER	INN/MAS	PACK	LIST
45059	With Bar Handle	1	10/50	BULK	4.87

### HEAVY-DUTY WATER HEATER ELEMENT WRENCH

- Includes 3/4" to 1/2" drive adapter



PART #	DESCRIPTION	UNIT ORDER	INN/MAS	PACK	LIST
45058	Chrome Steel	1	15/30	BAG	25.78

### BREAKER BAR

- 1/2" Drive 17" long with cushion grip handle



PART #	DESCRIPTION	UNIT ORDER	INN/MAS	PACK	LIST
45060	1/2" Drive 17" Long with Cushion Grip Handle	1	12/36	BULK	17.76

### CARTRIDGE REMOVER

- Fits Moen®



PART #	DESCRIPTION	UNIT ORDER	INN/MAS	PACK	LIST
45159	Cartridge Remover	1	1/25	BULK	17.19

### BASKET STRAINER WRENCH

- Includes bar handle



PART #	DESCRIPTION	UNIT ORDER	INN/MAS	PACK	LIST
45125	With Bar Handle	1	50/100	BULK	6.36

### BASKET STRAINER WRENCH

- Hardened steel



PART #	DESCRIPTION	UNIT ORDER	INN/MAS	PACK	LIST
45165	Hardened Steel	1	25/50	BULK	7.78

### DRUM TRAP PLUG WRENCH

- Four-way



PART #	DESCRIPTION	UNIT ORDER	INN/MAS	PACK	LIST
45129	3/4", 1", 1-1/8" & 1-3/8"	1	8/16	BULK	20.36

### PICK-UP-TOOL - CLAW-TYPE

- Claw-type
- 24" Length



PART #	DESCRIPTION	UNIT ORDER	INN/MAS	PACK	LIST
55341	Spring-Release	1	72/144	BULK	3.08

### O-RING PICK

- Use to remove old or damaged O-rings without causing surface damage
- Includes scraper to remove any surface residue



PART #	DESCRIPTION	UNIT ORDER	INN/MAS	PACK	LIST
45072	Scraper & Pick	1	-/24	BAG	3.48

### P.O. PLUG & CLOSET SPUD WRENCH

- Malleable iron



PART #	DESCRIPTION	UNIT ORDER	INN/MAS	PACK	LIST
45117	4-In-1	1	5/50	BULK	6.36

## Plumbing Tools

### HEAVY-DUTY FAUCET HANDLE PULLER

- Removes large and small faucet handles
- Long adjustable grip fingers



PART #	DESCRIPTION	UNIT ORDER	INN/MAS	PACK	LIST
45088	Handle Puller	5	5/40	POUCH	14.88

### HANDLE PULLER

- Heavy plated steel construction

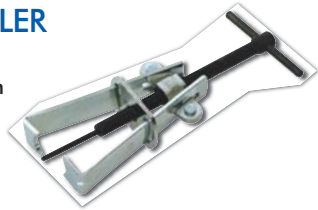

PART #	DESCRIPTION	UNIT ORDER	INN/MAS	PACK	LIST
45121	Screw Drive	1	25/100	BULK	9.15

### HANDLE PULLER

- Heavy plated steel construction



PART #	DESCRIPTION	UNIT ORDER	INN/MAS	PACK	LIST
45123	Deluxe Impact	1	15/30	BULK	21.61

### SEAT WRENCH

- For easy removal of faucet & shower seats

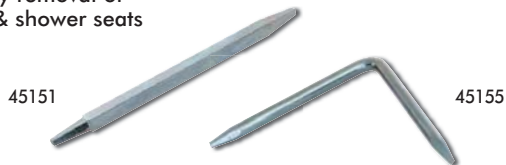

PART #	DESCRIPTION	UNIT ORDER	INN/MAS	PACK	LIST
45151	Straight with Tapered Ends	1	20/200	BULK	4.25
45155	Angle with Tapered Ends	1	10/100	BULK	4.79
45157	Angle with Stepped Ends	1	10/100	BULK	4.79

### SEAT EXTRACTOR SET

- For easy removal & installation of faucet seats
- Includes ratchet wrench



PART #	DESCRIPTION	UNIT ORDER	INN/MAS	PACK	LIST
45161	4-Piece Set	1	20/40	BAG	22.10

### PROFESSIONAL FAUCET RESEATER

- Long stem to fix faucet leaks in tubs and such hard to reach areas as recessed shower faucets



PART #	DESCRIPTION	UNIT ORDER	INN/MAS	PACK	LIST
*45093	Professional Faucet Repair	5	5/40	BAG	5.93

\*While Supplies Last

### PVC PIPE CUTTER

- For cutting PVC pipe



PART #	DESCRIPTION	UNIT ORDER	INN/MAS	PACK	LIST
45131	Cuts 1/2" to 1-1/4" Pipe	1	10/50	BAG	24.12

### PROFESSIONAL PVC PIPE CUTTER

- Push-button, spring-release blade
- Durable all-metal construction
- Cuts PVC, CPVC, and other plastic pipe
- One-hand use



**EASTMAN.**

PART #	DESCRIPTION	UNIT ORDER	INN/MAS	PACK	LIST
45132	1/2" to 1-1/4"	5	5/50	BAG	24.78

### PEX AND PLASTIC PIPE CUTTER

- High-impact ABS handles
- Replaceable stainless steel blade
- Cuts PEX pipe, plastic pipe and nonmetallic hose up to 1-1/2"



**EASTMAN.**

PART #	DESCRIPTION	UNIT ORDER	INN/MAS	PACK	LIST
95116	Pipe Cutter	1	5/100	BAG	16.77
95118	Stainless Steel Replacement Blades	5	-/200	BAG	9.21

### PVC CABLE SAW

- For fast cutting of PVC plumbing, drain and irrigation pipe
- Galvanized steel cable
- Great for tight spaces
- Need only 1/4" clearance



**EASTMAN.**

PART #	DESCRIPTION	UNIT ORDER	INN/MAS	PACK	LIST
45092	Galvanized Cable	10	10/50	BULK	9.15

Supply Connectors

Stop Valves

Water Heater

Gas Connectors

Water Filtration

Sinks/Faucets

Tubular/Drainage

Faucet Repair

Bath Accessories

Pipe Fittings/Repair

Valves

Cements/Sealants

Tools/Safety

Toilet Repair

Appliance/HVAC

Hardware

Electrical

Index

# TOOLS AND SAFETY

## Plumbing Tools

### MULTIPURPOSE PIPE SAW

- Cuts PVC, CPVC, ABS, wood, drywall and more
- 10 Teeth per inch
- Cuts to floor
- 13" Length



**EASTMAN®**

PART #	DESCRIPTION	UNIT ORDER	INN/MAS	PACK	LIST
45090	13"	5	12/48	BULK	21.41

### JUNIOR HACKSAW



PART #	DESCRIPTION	UNIT ORDER	INN/MAS	PACK	LIST
55132	Frame and Blade	1	12/240	BOX	2.51
55135	6" - 32-Tooth Blade Only	1	-/1000	BULK	0.26

## Drain Cleaning

### LIQUID DRAIN OPENER

- A special blend of potassium and sodium hydroxide designed for cleaning clogged drain pipes due to grease, hair, lint, paper, food scraps, and all organic material
- Will not harm plumbing fixtures, porcelain or septic systems
- Fast-acting and odorless



HAZARDOUS

PART #	DESCRIPTION	UNIT ORDER	INN/MAS	PACK	LIST
51998	1 Quart - OEM #09030	12	-/12	BOTTLE	5.83

### LIQUID DRAIN OPENER HEAVY-DUTY

- A special blend of potassium and sodium hydroxide designed for cleaning clogged drain pipes due to grease, hair, lint, paper, food scraps, and all organic material
- Will not harm plumbing fixtures, porcelain or septic systems
- Fast-acting and odorless



HAZARDOUS

PART #	DESCRIPTION	UNIT ORDER	INN/MAS	PACK	LIST
51997	1 Quart - OEM #09036	12	-/12	BOTTLE	7.62

## CRYSTAL CAUSTIC DRAIN OPENER

- A powdered blend of sodium hydroxide, sodium nitrate and an aluminum alloy designed for cleaning clogged drain pipes due to grease, hair, lint, paper, food scraps, and all organic material
- Will not harm plumbing fixtures, porcelain or septic systems



HAZARDOUS

PART #	DESCRIPTION	UNIT ORDER	INN/MAS	PACK	LIST
51999	1 lb - OEM #09040	1	-/12	BOTTLE	13.60

## SULPHURIC DRAIN OPENER CONTRACTOR-GRADE

- Manufactured with concentrated virgin sulfuric acid
- Contains protective, corrosion inhibitors and quick penetrating activating agents
- Will not harm septic tanks, cesspools, drainage fields and leaching systems when properly used according to directions



TRUCK LINE ONLY HAZARDOUS

PART #	DESCRIPTION	UNIT ORDER	INN/MAS	PACK	LIST
51996	1 Quart - OEM #09020	12	-/12	BOTTLE	8.63

## TELETUBE URINAL AUGER

- Spring is tough and flexible for tight urinal bends
- 48" Spring for cleaning stoppages beyond urinal
- Rust-resistant tube and rubber bumpers



**General**  
PIPE CLEANERS

PART #	DESCRIPTION	UNIT ORDER	INN/MAS	PACK	LIST
52014	Regular Head	1	-/1	BOX	71.31

## FORCE CUP PLUNGER

- Sold in case quantities only



PART #	DESCRIPTION	UNIT ORDER	INN/MAS	PACK	LIST
40287	4" Cup - 9" Handle	12	12/24	BULK	2.28
40285	5-1/2" Cup - 21" Handle	12	12/24	BULK	3.36



## Drain Cleaning

### HEAVY-DUTY FORCE CUP PLUNGER

- 21" Wood handle
- Dual cup
- Sold in case quantities only



PART #	DESCRIPTION	UNIT ORDER	INN/MAS	PACK	LIST
40281	5-7/8" Dual Cup	12	12/24	BULK	5.53

### DRAIN FLUSH

- Connects to a garden hose to safely clean and easily clear drain pipes of obstructions with pulsating water pressure
- Completely reusable
- Comes with a one-year replacement guarantee



PART #	DESCRIPTION	UNIT ORDER	INN/MAS	PACK	LIST
78029	1" - 2"	12	-/12	BAG	13.46
78030	1-1/2" - 3"	12	-/12	BAG	14.09
78031	3" - 6"	6	-/6	BAG	32.76

## Tie Downs

### TARP STRAP

- EPDM rubber
- Includes 2 S-hooks



PART #	DESCRIPTION	UNIT ORDER	INN/MAS	PACK	LIST
*50121	10"	10	10/10	BULK	1.60
*50122	14"	10	10/10	BULK	1.91

\*While Supplies Last

## Protective Gear

### SAFETY GLASSES

- Meets ANSI Z87.1 requirements



PART #	DESCRIPTION	UNIT ORDER	INN/MAS	PACK	LIST
55331	Safety Glasses	12	12/300	BAG	4.79

### SAFETY GOGGLES

- Meets ANSI Z87.1 requirements



PART #	DESCRIPTION	UNIT ORDER	INN/MAS	PACK	LIST
55332	Safety Goggles	1	25/200	BAG	2.97

## DISPOSABLE LATEX GLOVES

- General-purpose, powder-free, latex gloves with rolled cuff
- Meets FDA standards for medical exam and food contact
- 100 Disposable gloves per box



PART #	DESCRIPTION	UNIT ORDER	INN/MAS	PACK	LIST
86940	Large - 100/Box	1	1/10	BOX	21.53
86941	X-Large - 100/Box	1	1/10	BOX	21.53

## DISPOSABLE NITRILE GLOVES

- Powder-free
- 3-4 Mil thickness
- Ambidextrous
- Box of 100



PART #	DESCRIPTION	UNIT ORDER	INN/MAS	PACK	LIST
87000	Large	1	1/10	BOX	18.53
87001	X-Large	1	1/10	BOX	18.53

## BROWN COTTON JERSEY - 9 OZ

- Large size only
- Sold & priced per dozen pairs



PART #	DESCRIPTION	UNIT ORDER	INN/MAS	PACK	LIST
55606	Knit Wrists	1	1/25	BOX	21.27

## WHITE COTTON CANVAS - 8 OZ

- Large size only
- Sold & priced per dozen pairs



PART #	DESCRIPTION	UNIT ORDER	INN/MAS	PACK	LIST
55602	White Knit Wrists	1	1/25	BOX	18.02

## LEATHER PALM WITH SAFETY CUFF

- Large size only
- Quality split-cowhide palm, thumb, forefinger, fingertips & knuckle strap for strength & durability
- Sold & priced per dozen pairs



PART #	DESCRIPTION	UNIT ORDER	INN/MAS	PACK	LIST
55612	Wing Thumb	1	12/120	BOX	46.82

Supply Connectors

Stop Valves

Water Heater

Gas Connectors

Water Filtration

Sinks/ Faucets

Tubular/ Drainage

Faucet Repair

Bath Accessories

Pipe Fittings/ Repair

Valves

Cements/ Sealants

Tools/ Safety

Toilet Repair

Appliance/ HVAC

Hardware

Electrical

Index

# TOOLS AND SAFETY

## Protective Gear

### LEATHER DRIVING GLOVES

- Large size only
- Grained cowhide
- Sold & priced per dozen pairs



PART #	DESCRIPTION	UNIT ORDER	INN/MAS	PACK	LIST
55616	All Leather	1	1/10	BOX	192.37

### PROTECTIVE SHOE COVERS

- Guaranteed to fit up to size 18
- Nonskid bottoms
- Sold & priced by box of 50 pairs



PART #	DESCRIPTION	UNIT ORDER	INN/MAS	PACK	LIST
83104	Box of 50 Pairs	1	-/1	BOX	47.93

### RUBBER BOOTS

- Knee length
- Waterproof
- Black only



PART #	DESCRIPTION	UNIT ORDER	INN/MAS	PACK	LIST
83119	Size 9	1	-/10	BAG	18.53
83120	Size 10	1	-/10	BAG	18.53
83121	Size 11	1	-/10	BAG	18.53
83122	Size 12	1	-/10	BAG	18.53
83123	Size 13	1	-/10	BAG	18.53

### RUBBER BOOTS

- Mid-calf length
- Waterproof
- Black only



PART #	DESCRIPTION	UNIT ORDER	INN/MAS	PACK	LIST
83112	Size 9	1	-/10	BAG	17.11
83113	Size 10	1	-/10	BAG	17.11
83114	Size 11	1	-/10	BAG	17.11
83115	Size 12	1	-/10	BAG	17.11
83116	Size 13	1	-/10	BAG	17.11

## DISPOSABLE COVERALLS

- Includes one pair of shoe covers
- Five-pocket design
- Elastic wrist with boot-cut legs



PART #	DESCRIPTION	UNIT ORDER	INN/MAS	PACK	LIST
83105	Disposable Coveralls with Shoe Covers	1	-/25	BOX	12.15

## Toilet Tanks

### UNIVERSAL REPLACEMENT TOILET TANK

- Universal-fit
- Tank includes adapter, ballcock & flush valve kit
- Made from high-impact resin and nearly unbreakable
- Standard white tank is paintable



PART #	DESCRIPTION	UNIT ORDER	INN/MAS	PACK	LIST
34090	Toilet Tank	1	-/1	BOX	155.93

### REPLACEMENT TANK COVER

- Universal, adjustable to fit most toilet tanks
- White plastic



PART #	DESCRIPTION	UNIT ORDER	INN/MAS	PACK	LIST
40271	21-3/16" x 7-7/8"	6	-/6	BULK	19.30

## Toilet Seats

### WHITE WOOD TOILET SEAT

- Closed-front seat with lid
- Enameled wood composition
- Hardware included

5-Year Warranty



PART #	DESCRIPTION	UNIT ORDER	INN/MAS	PACK	LIST
65905	Round	6	-/6	BOX	16.99
65907	Elongated	6	-/6	BOX	21.58

### WHITE WOOD TOILET SEAT

- Stylish, contoured, closed-front seat with lid
- High-quality wood construction
- Installation hardware included
- 5-Year guarantee



PART #	DESCRIPTION	UNIT ORDER	INN/MAS	PACK	LIST
65925	Elongated	6	-/6	BOX	23.75

## WHITE PLASTIC TOILET SEAT

- Closed-front seat with lid
- Heavy plastic body - stain-resistant
- Hardware included

5-Year Warranty



PART #	DESCRIPTION	UNIT ORDER	INN/MAS	PACK	LIST
65901	Round	10	-/10	BOX	18.90
65903	Elongated	10	-/10	BOX	18.87

### WHITE SUPERIOR SOFT-CLOSE TOILET SEAT

**NEW**

- Closed-front seat with lid
- Non-slamming, touch release, slow-close lid
- Heavy-duty plastic seat
- High-strength hinges and hardware
- Hardware included

5-Year Warranty



PART #	DESCRIPTION	UNIT ORDER	INN/MAS	PACK	LIST
65931	Round	10	-/10	BOX	34.16
65933	Elongated	10	-/10	BOX	35.75

### COMMERCIAL-GRADE ELONGATED PLASTIC TOILET SEAT

- Open front less cover
- Heavy-duty
- Heavyweight solid plastic
- Includes corrosion-proof nuts & bolts



PART #	DESCRIPTION	UNIT ORDER	INN/MAS	PACK	LIST
65914	White Seat	5	-/5	BOX	29.31

### COMMERCIAL-GRADE WHITE PLASTIC TOILET SEAT

- Open front less cover
- Heavy-duty commercial-grade
- Heavyweight solid plastic
- Includes external check hinge with stainless steel post



PART #	DESCRIPTION	UNIT ORDER	INN/MAS	PACK	LIST
65912	Round	5	-/5	BOX	40.37
65913	Elongated	5	-/5	BOX	42.34

Supply Connectors

Stop Valves

Water Heater

Gas Connectors

Water Filtration

Sinks/Faucets

Tubular/Drainage

Faucet Repair

Bath Accessories

Pipe Fittings/Repair

Valves

Cements/Sealants

Tools/Safety

Toilet Repair

Appliance/HVAC

Hardware

Electrical

Index

# TOILET REPAIR

## Toilet Installation Parts

### TOILET SEAT BOLTS

- Includes nuts
- Durable plastic
- 2-1/2" Long plastic bolts



PART #	DESCRIPTION	UNIT ORDER	INN/MAS	PACK	LIST
40280	1 Pair 2-1/2" Long Plastic Bolts	1	-/500	BAG	1.14
40279	5 Pairs 2-1/2" Long Plastic Bolts	1	-/100	BAG	5.08

### NYLON CLOSET BOLTS - PAIR

- 100% Corrosion-proof
- Designed for smoother, faster threading
- Unique bolt base preloads into any flange and eliminates the need to double nut
- Resists damage due to overtightening
- Priced and sold per pair



**EASTMAN**

PART #	DESCRIPTION	UNIT ORDER	INN/MAS	PACK	LIST
40210	2-1/2" Nylon Closet Bolts	1	-/250	BAG	1.00
40211	3-1/2" Nylon Closet Bolts	1	-/100	BAG	1.11

### CLOSET BOLT SET - SOLID BRASS BOLTS

- 2 Nickel-plated open-end nuts
- 2 Nickel-plated washers
- 2 Plastic captive washers

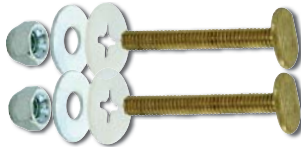

**EZ-FLO**

PART #	DESCRIPTION	UNIT ORDER	INN/MAS	PACK	LIST
40019	1/4" x 2-1/4" Bolt Set	25	25/400	BAG	2.05
40022	1/4" x 3-1/2" Bolt Set	25	25/400	BAG	2.57
40018	5/16" x 2-1/4" Bolt Set	25	25/400	BAG	2.51
40030	5/16" x 3-1/2" Bolt Set	25	25/200	BAG	3.65
40020	1/4" x 2-1/4" Break-Off Bolt Set	25	25/400	BAG	2.05
40026	5/16" x 2-1/4" Break-Off Bolt Set	25	25/400	BAG	3.56

### CLOSET BOLT SET - SOLID BRASS BOLT SET

- 4 Nickel-plated open-end nuts
- 4 Nickel-plated washers
- 2 Plastic captive washers

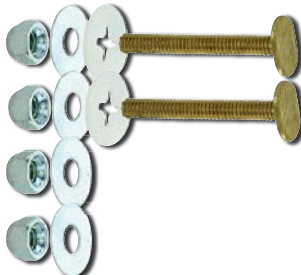

**EZ-FLO**

PART #	DESCRIPTION	UNIT ORDER	INN/MAS	PACK	LIST
40021	1/4" x 2-1/4" Bolt Set	25	25/400	BAG	2.17

### CLOSET BOLT SET - BRASS-PLATED BOLTS

- 2 Nickel-plated open-end nuts
- 2 Nickel-plated washers
- 2 Plastic captive washers

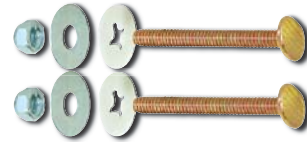

**EZ-FLO**

PART #	DESCRIPTION	UNIT ORDER	INN/MAS	PACK	LIST
40042	1/4" x 1-1/2" Bolt Set	25	25/400	BAG	0.66
40044	1/4" x 1-3/4" Bolt Set	25	25/400	BAG	0.68
40024	1/4" x 2-1/4" Bolt Set	25	25/400	BAG	0.71
40025	1/4" x 3-1/2" Bolt Set	25	25/400	BAG	1.00
40028	5/16" x 2-1/4" Bolt Set	25	25/400	BAG	1.05
40032	5/16" x 3-1/2" Bolt Set	25	25/100	BAG	1.28

### CLOSET BOLT SET - BRASS-PLATED BOLT SET

- 4 Nickel-plated open-end nuts
- 4 Nickel-plated washers
- 2 Plastic captive washers

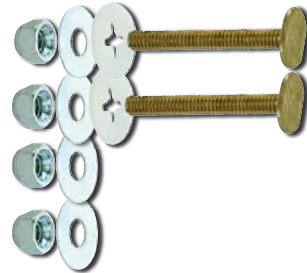

**EZ-FLO**

PART #	DESCRIPTION	UNIT ORDER	INN/MAS	PACK	LIST
40027	1/4" x 2-1/4" Bolt Set	25	25/400	BAG	1.08

### CLOSET SCREW SET

- 2 Nickel-plated open-end nuts
- 2 Nickel-plated washers



**EZ-FLO**

PART #	DESCRIPTION	UNIT ORDER	INN/MAS	PACK	LIST
40029	1/4" x 2-1/4" Screw Set	25	25/400	BAG	0.86
40031	1/4" x 3-1/2" Screw Set	25	25/500	BAG	0.80

### TOILET BOWL BOLT CAP

- White plastic construction
- Two-piece for 1/4" or 5/16" bolt nut



PART #	DESCRIPTION	UNIT ORDER	INN/MAS	PACK	LIST
40050	1 Pair Round with Washer	1	10/500	BAG	1.11
40035	50 Pairs Round with Washer	1	10/20	BAG	19.82
40039	50 Pairs Round without Washer	1	10/500	BAG	20.53

## Toilet Installation Parts

### ADJUSTABLE TOILET TANK-TO-BOWL BOLT SET

- Complete with nuts & washers & fully adjustable
- Used to accommodate offset bolt hole patterns
- **Priced and sold by the pair**



PART #	DESCRIPTION	UNIT ORDER	INN/MAS	PACK	LIST
40045	Solid Brass - 5/16" x 2"	25	25/200	BAG	10.12

### TOILET TANK-TO-BOWL BOLT SET

- Complete with nuts & washers
- Round- or flat-head
- **Priced and sold by the pair**

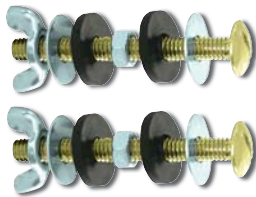

PART #	DESCRIPTION	UNIT ORDER	INN/MAS	PACK	LIST
40047	Brass-Plated 5/16" x 3" Round-Head Bolts	25	25/200	BAG	1.68
40041	Solid Brass 5/16" x 3" Round-Head Bolts	25	25/200	BAG	5.05
40043	Solid Brass 5/16" x 3" Flat-Head Bolts	25	25/200	BAG	5.25

### TOILET TANK-TO-BOWL BOLT SET

- Round-head bolts with nuts & washers
- Sponge-rubber tank-to-bowl gasket
- **Priced and sold by the pair**



PART #	DESCRIPTION	UNIT ORDER	INN/MAS	PACK	LIST
40048	Solid Brass 5/16" x 3" Round-Head Bolts	25	25/200	BAG	5.47

### TOILET TANK-TO-BOWL HARDWARE SET

- 5/16" x 3" Solid brass bolts
- Cloth inserted washers
- Stainless steel washers
- Solid brass nuts & bolts



PART #	DESCRIPTION	UNIT ORDER	INN/MAS	PACK	LIST
91063N	Fits American Standard® Toilets	1	10/100	BAG	4.85

### RUBBER SPUD WASHER

- Fits brass closet spuds
- Rubber



PART #	DESCRIPTION	UNIT ORDER	INN/MAS	PACK	LIST
36274	1-1/2"	12	12/288	BULK	1.37

### CAST-BRASS CLOSET SPUD

- Complete with brass locknut, rubber & metal washers
- Cast-brass body



**EASTMAN.**

PART #	DESCRIPTION	UNIT ORDER	INN/MAS	PACK	LIST
40131	1" x 3/4"	10	10/100	BULK	6.36
40133	1-1/4"	10	10/100	BULK	9.21
40135	1-1/2"	10	10/100	BULK	10.12
40139	2" x 1-1/4"	10	10/100	BULK	11.53
40141	2" x 1-1/2"	10	10/100	BULK	12.36
40137	2"	10	10/100	BULK	15.60

### TANK-TO-BOWL GASKET

- Used on flush valve to seal tank-to-bowl connection
- Beveled sponge-rubber



PART #	DESCRIPTION	UNIT ORDER	INN/MAS	PACK	LIST
36251	Universal-Type	10	10/200	BULK	1.05

### TANK-TO-BOWL GASKET

- Used on flush valve to seal tank-to-bowl connection
- Recessed molded rubber



PART #	DESCRIPTION	UNIT ORDER	INN/MAS	PACK	LIST
36257	Fits American Standard®, Kohler®	10	10/175	BULK	3.25

### TANK-TO-BOWL GASKET

- Used on flush valve to seal tank-to-bowl connection
- Beveled sponge-rubber



PART #	DESCRIPTION	UNIT ORDER	INN/MAS	PACK	LIST
36256	Fits American Standard®, Kohler®, Western Pottery® & Briggs®	10	10/300	BULK	1.91

# TOILET REPAIR

## Toilet Installation Parts

### TANK-TO-BOWL GASKET

- Used on flush valve to seal tank-to-bowl connection
- Beveled sponge-rubber



PART #	DESCRIPTION	UNIT ORDER	INN/MAS	PACK	LIST
36255	Fits Gerber®	10	10/300	BULK	2.14

### TANK-TO-BOWL GASKET

- Used on flush valve to seal tank-to-bowl connection
- Recessed molded rubber



PART #	DESCRIPTION	UNIT ORDER	INN/MAS	PACK	LIST
36259	Fits Eljer®	10	10/350	BULK	2.17

### TOILET BOWL GASKET

- Rubber
- For setting most wall-hung toilets



PART #	DESCRIPTION	UNIT ORDER	INN/MAS	PACK	LIST
40013	5-1/4" x 3/4" Thick	10	10/150	BULK	2.97

### ELASTOMER TOILET BOWL GASKET

**NEW**

- Sticky gasket ensures a tight seal
- Fits 3" or 4" waste lines
- Can be repositioned and compresses up to 50%
- Allows movement without leaking
- Will not break or become brittle



**EASTMAN**

PART #	DESCRIPTION	UNIT ORDER	INN/MAS	PACK	LIST
40113	Gasket Only - M61001	1	-/24	BOX	3.71
40114	Gasket with Flange - M61002	1	-/24	BOX	4.13

### WAX RING

- Fits 3" or 4" waste lines
- Fits all floor-type toilet bowls



**EASTMAN**

PART #	DESCRIPTION	UNIT ORDER	INN/MAS	PACK	LIST
40143	4" Wax Ring Only	48	-/48	BOX	1.82
40144	4" x 3" Wax Ring with Flange	24	-/24	BOX	1.94

### WAX RING SET

- (1) 4" x 3" Wax ring with flange
- (2) 1-1/4" x 2-1/4" Brass bolts
- (2) Nuts
- (2) Washers



**EASTMAN**

PART #	DESCRIPTION	UNIT ORDER	INN/MAS	PACK	LIST
40007	4" x 3" Wax Ring Set	24	-/24	BOX	4.99

### WAX RING SET

- (1) 4" x 3" Wax ring with flange
- (2) 1-1/4" x 2-1/4" Brass bolts
- (4) Nuts
- (4) Washers



**EASTMAN**

PART #	DESCRIPTION	UNIT ORDER	INN/MAS	PACK	LIST
86300	4" x 3" Wax Ring Set	24	-/24	BOX	5.82

### URINAL WAX RING

- Use on all wall-mounted urinals with 2" waste outlet



**EASTMAN**

PART #	DESCRIPTION	UNIT ORDER	INN/MAS	PACK	LIST
40150	2"	48	-/48	BOX	2.45

### REINFORCED WAX RING WITH FLANGE

- Fits 3" or 4" waste lines
- Ideal for use where a regular ring does not provide enough wax
- Reinforced with felt gasket



**EASTMAN**

PART #	DESCRIPTION	UNIT ORDER	INN/MAS	PACK	LIST
40148	4" With Flange	24	-/24	BOX	3.36

### JUMBO WAX RING

- Fits 3" or 4" waste lines
- Ideal for use where a regular ring does not provide enough wax



**EASTMAN**

PART #	DESCRIPTION	UNIT ORDER	INN/MAS	PACK	LIST
40146	4" Wax Ring Only	24	-/24	BOX	2.74

## Toilet Installation Parts

### JUMBO FLANGED WAX RING

- Ideal to use where a regular ring does not provide enough wax to make a good seal
- Forms a watertight, gastight and odor-tight seal



**EASTMAN**

PART #	DESCRIPTION	UNIT ORDER	INN/MAS	PACK	LIST
40145	4" x 3"	24	-/24	BOX	3.51

## Closet Flanges

### CLOSET FLANGE EXTENSION KIT

- Kit contains:  
3 PVC extension rings, 2 closet bolts, 2 nuts and 4 washers
- 1/4" x 3-1/2" Bolts
- OEM #86209



**WATER TITE**  
IPS CORPORATION

PART #	DESCRIPTION	UNIT ORDER	INN/MAS	PACK	LIST
40059	Extension Kit	1	-/20	BAG	9.27

### CLOSET FLANGE EXTENSION RINGS

- Includes 2 rings
- 1/4" Thick PVC
- Can be stacked to desired height
- Brings flange flush to desired height level after retiling
- OEM #86208



**WATER TITE**  
IPS CORPORATION

PART #	DESCRIPTION	UNIT ORDER	INN/MAS	PACK	LIST
40082	Pair - 1/4" Rings	1	-/20	BAG	6.36

### SPANNER FLANGE

- Zinc-plated
- Repairs broken closet flanges
- Mounts to floor



PART #	DESCRIPTION	UNIT ORDER	INN/MAS	PACK	LIST
40010	Spanner Flange	1	125/250	BULK	1.88

### SPANNER FLANGE REPAIR KIT

- Includes anchor flange, 2 plastic anchors, 2 metal screws, and 6 plastic washers
- Used to repair cracked or broken toilet flanges
- Mounts to floor to stabilize toilet
- Zinc-plated



**EZ-FLO**

PART #	DESCRIPTION	UNIT ORDER	INN/MAS	PACK	LIST
40017	Hardware Included	1	-/250	BLISTER	3.11

### 4" CAST-BRASS CLOSET FLANGE

- Brass



PART #	DESCRIPTION	UNIT ORDER	INN/MAS	PACK	LIST
40015	4"	1	10/50	BULK	11.09

### STAINLESS STEEL CLOSET FLANGE REPAIR RING

- One-piece construction
- Replaces both metal and plastic closet flange rings with an inside diameter greater than 5"
- Adjustable
- Grade 304-2B stainless steel
- OEM #133608



**canplas**  
PLUMBING

PART #	DESCRIPTION	UNIT ORDER	INN/MAS	PACK	LIST
73010	4" x 3"	1	-/10	BAG	35.41

### CLOSET FLANGE REPAIR RING

- Corrosion-resistant stainless steel ring
- Perfect for repairs to damaged closet flanges or new concrete floor installations
- Fits securely over damaged flanges
- OEM #886-MR



**UPC**

PART #	DESCRIPTION	UNIT ORDER	INN/MAS	PACK	LIST
73040	Stainless Steel	1	-/20	BULK	10.81

Supply  
Connectors

Stop  
Valves

Water  
Heater

Gas  
Connectors

Water  
Filtration

Sinks/  
Faucets

Tubular/  
Drainage

Faucet  
Repair

Bath  
Accessories

Pipe Fittings/  
Repair

Valves

Cements/  
Sealants

Tools/  
Safety

Toilet  
Repair

Appliance/  
HVAC

Hardware

Electrical

Index

# TOILET REPAIR

## Clotet Flanges

### CLAM CLOSET FLANGE REPAIR RING

- 2-Piece ring made from rust-resistant 409 stainless steel
- Stainless steel assembly screws included
- Designed with a lip to fit groove of most plastic flanges
- Stronger than replaced steel ring when installed properly on a solid base
- Drastically saves time and costs



PART #	DESCRIPTION	UNIT ORDER	INN/MAS	PACK	LIST
73044	Stainless Steel	1	-/10	BULK	23.41

### CLOSET FLANGE REPAIR RING

- Two-piece "Moss Bay" design for replacing broken or rusted swivel rings without removing flange
- Includes two-piece galvanized ring, 2 closet bolts, 4 nuts and 4 washers
- OEM #886-MRM



PART #	DESCRIPTION	UNIT ORDER	INN/MAS	PACK	LIST
73042	Galvanized Steel	1	-/8	CARD	25.46

### BIGFOOT COVER PLATE

- Covers stained or damaged floor when converting to 1.6 GPF toilet



PART #	DESCRIPTION	UNIT ORDER	INN/MAS	PACK	LIST
31003	Cover Plate	10	-/10	BULK	25.83

### TOILET WEDGE

- Priced and sold 8 per bag



PART #	DESCRIPTION	UNIT ORDER	INN/MAS	PACK	LIST
31001	Hard	12	-/12	BAG	4.70
31002	Soft	12	-/12	BAG	4.70

### PVC CLOSET FLANGE

- Fits on 3" or 4"
- Schedule 40 PVC
- Without stop or knocker
- Standard pattern



PART #	DESCRIPTION	UNIT ORDER	INN/MAS	PACK	LIST
40012	4" x 3" Hub	1	-/12	BULK	4.39

### PVC CLOSET FLANGE WITH KNOCK-OUT

- Knock-out breaks in one piece
- Allows flush installation over 3" pipe or inside 4" pipe



PART #	DESCRIPTION	UNIT ORDER	INN/MAS	PACK	LIST
85727	4" x 3" Hub	1	-/12	BULK	4.85

### ABS CLOSET FLANGE WITH KNOCK-OUT

- Knock-out breaks in one piece
- Allows flush installation over 3" pipe or inside 4" pipe



PART #	DESCRIPTION	UNIT ORDER	INN/MAS	PACK	LIST
85726	4" x 3" Hub	1	-/12	BULK	4.85

### PVC CLOSET FLANGE WITH KNOCK-OUT

- Knock-out breaks in one piece
- Allows flush installation over 3" pipe or inside 4" pipe
- With metal swivel ring



PART #	DESCRIPTION	UNIT ORDER	INN/MAS	PACK	LIST
85729	4" x 3" Hub	1	-/12	BULK	9.72

### ABS CLOSET FLANGE WITH KNOCK-OUT

- Knock-out breaks in one piece
- Allows flush installation over 3" pipe or inside 4" pipe
- With metal swivel ring



PART #	DESCRIPTION	UNIT ORDER	INN/MAS	PACK	LIST
85728	4" x 3" Hub	1	-/12	BULK	9.72



## Closest Flanges

### PVC CLOSET FLANGE WITH KNOCK-OUT

- One-piece knock-out will not fall down drain line
- Knock-out breaks out in one piece
- Flush-Tite design allows flush installation over 3" pipe or inside 4" pipe



PART #	DESCRIPTION	UNIT ORDER	INN/MAS	PACK	LIST
85720	4" x 3" Hub	1	-/40	BULK	7.56

### ABS CLOSET FLANGE WITH KNOCK-OUT

- Knock-out breaks out in one piece
- Flush-Tite design allows flush installation over 3" pipe or inside 4" pipe



PART #	DESCRIPTION	UNIT ORDER	INN/MAS	PACK	LIST
85721	4" x 3" Hub	1	-/40	BULK	6.70

### PVC CLOSET FLANGE WITH KNOCK-OUT

- With stainless steel swivel ring
- Knock-out breaks out in one piece
- Flush-Tite design allows flush installation over 3" pipe or inside 4" pipe



PART #	DESCRIPTION	UNIT ORDER	INN/MAS	PACK	LIST
85722	4" x 3" Hub	1	-/40	BULK	16.19

### ABS CLOSET FLANGE WITH KNOCK-OUT

- With stainless steel swivel ring
- Knock-out breaks out in one piece
- Flush-Tite design allows flush installation over 3" pipe or inside 4" pipe



PART #	DESCRIPTION	UNIT ORDER	INN/MAS	PACK	LIST
85723	4" x 3" Hub	1	-/40	BULK	16.19

### PVC ADJUSTABLE CLOSET FLANGE

- With metal ring
- Schedule 40 PVC
- Adjustable metal ring



PART #	DESCRIPTION	UNIT ORDER	INN/MAS	PACK	LIST
85695	4" x 3" Hub	1	-/12	BULK	11.58

### ABS ADJUSTABLE CLOSET FLANGE

- With metal ring
- Schedule 40 ABS
- Adjustable metal ring



PART #	DESCRIPTION	UNIT ORDER	INN/MAS	PACK	LIST
85504	4" x 3" Hub	1	-/40	BULK	7.27

### PVC OFFSET CLOSET FLANGE

- Schedule 40 PVC
- Offset
- With metal ring



PART #	DESCRIPTION	UNIT ORDER	INN/MAS	PACK	LIST
85693	4" x 3" Hub	1	-/20	BULK	18.28

### ABS OFFSET CLOSET FLANGE

- Schedule 40 ABS
- Offset
- With metal ring



PART #	DESCRIPTION	UNIT ORDER	INN/MAS	PACK	LIST
85502	4" x 3" Hub	1	-/20	BULK	18.53

### 45° PVC CLOSET FLANGE

- Designed with 45° discharge
- Keeps drain line tight to the subfloor



PART #	DESCRIPTION	UNIT ORDER	INN/MAS	PACK	LIST
73005	4" x 3" Hub	1	-/20	BULK	12.12

### 45° ABS CLOSET FLANGE

- Designed with 45° discharge
- Keeps drain line tight to the subfloor



PART #	DESCRIPTION	UNIT ORDER	INN/MAS	PACK	LIST
73004	4" x 3" Hub	1	-/20	BULK	12.12

Supply Connectors

Stop Valves

Water Heater

Gas Connectors

Water Filtration

Sinks/Faucets

Tubular/Drainage

Faucet Repair

Bath Accessories

Pipe Fittings/Repair

Valves

Cements/Sealants

Tools/Safety

Toilet Repair

Appliance/HVAC

Hardware

Electrical

Index

# TOILET REPAIR

## Closet Flanges

### 3" X 4" PVC ADJUSTABLE CLOSET FLANGE

- Solvent weld over 3" schedule 40 DWV or inside 4" schedule 40 DWV
- Extended length to reach riser below floor height
- Extended shank 5-1/2"



PART #	DESCRIPTION	UNIT ORDER	INN/MAS	PACK	LIST
40054	3" x 4"	1	-/12	BULK	25.01

### 3" X 4" ABS ADJUSTABLE CLOSET FLANGE

- Solvent weld over 3" schedule 40 DWV or inside 4" schedule 40 DWV
- Extended length to reach riser below floor height
- Extended shank 5-1/2"



PART #	DESCRIPTION	UNIT ORDER	INN/MAS	PACK	LIST
40056	3" x 4"	1	-/12	BULK	24.95

### 3" PVC ADJUSTABLE CLOSET FLANGE

- Slides inside 3" cast-iron schedule 40 DWV
- Extended length to reach riser below floor height
- Eliminates need for chipping and repairing concrete
- 3-3/4" Extended shank



PART #	DESCRIPTION	UNIT ORDER	INN/MAS	PACK	LIST
40000	3"	1	-/12	BULK	15.54

### 3" ABS ADJUSTABLE CLOSET FLANGE

- Slides inside 3" cast-iron schedule 40 DWV
- Extended length to reach riser below floor height
- Eliminates need for chipping and repairing concrete
- 3-3/4" Extended shank



PART #	DESCRIPTION	UNIT ORDER	INN/MAS	PACK	LIST
40004	3"	1	-/12	BULK	16.82

### 4" PVC PUSH-IN REPAIR FLANGE

- Replaces broken cast-iron closet flanges
- Slides inside 4" cast-iron, PVC or ABS
- No need to remove lead joint
- Simply slip into pipe and tighten top 3 stainless steel bolts



PART #	DESCRIPTION	UNIT ORDER	INN/MAS	PACK	LIST
40096	4"	1	-/24	BULK	39.29

### 4" ABS PUSH-IN REPAIR FLANGE

- Replaces broken cast-iron closet flanges
- Slides inside 4" cast-iron, PVC or ABS
- No need to remove lead joint
- Simply slip into pipe and tighten top 3 stainless steel bolts



PART #	DESCRIPTION	UNIT ORDER	INN/MAS	PACK	LIST
40052	4"	1	-/12	BULK	39.49

### 3" PVC PUSH-IN REPAIR FLANGE

- Fits 3" PVC DWV, no-hub-service weight and extra heavy cast-iron
- Seals the entire length of the tailpiece extension
- Can be cut to desired length
- Prelubricated gasket
- Full 3" of flow with no obstructions of bolts
- Easy Push 'N installation with no bolts to tighten
- OEM #86191



PART #	DESCRIPTION	UNIT ORDER	INN/MAS	PACK	LIST
40006	3"	1	-/12	BULK	26.91

### 3" ABS PUSH-IN REPAIR FLANGE

- Replaces broken cast-iron closet flanges
- Slides inside 3" cast-iron, PVC or ABS
- Also fits schedule 30 and 40 ABS and PVC
- Compression O-ring joint with two O-ring diameters to accommodate different inside pipe diameters
- OEM #86192



PART #	DESCRIPTION	UNIT ORDER	INN/MAS	PACK	LIST
40008	3"	1	-/12	BULK	26.91

### 4" PVC PUSH-IN REPAIR FLANGE

- Replaces broken cast-iron closet flanges
- Slides inside 4" cast-iron, PVC or ABS
- No need to remove lead joint
- No bolts to tighten
- Can be cut to desired length
- One-piece construction - gasket permanently attached to hub of flange
- OEM #86193



PART #	DESCRIPTION	UNIT ORDER	INN/MAS	PACK	LIST
40107	4"	1	-/12	BULK	37.27

## Toilet Tank Flappers

### PVC BLUE FLAPPER - PRO SERIES

- Fit-all style fits most brass or plastic flush valves
- Stainless steel chain
- Compare to Korky®
- 15-Year guarantee



**EASTMAN**

PART #	DESCRIPTION	UNIT ORDER	INN/MAS	PACK	LIST
48550	Blue PVC Flapper	10	10/100	BOX	2.08

### PVC BLUE FLAPPER - PRO SERIES

- Fit-all style fits most brass or plastic flush valves
- PVC with reinforced fiber strap



**EASTMAN**

PART #	DESCRIPTION	UNIT ORDER	INN/MAS	PACK	LIST
48551	PVC Blue Flapper	10	10/100	BOX	1.71

### TOILET TANK FLAPPER

- COAST™ style
- Beaded chain



PART #	DESCRIPTION	UNIT ORDER	INN/MAS	PACK	LIST
40316	Tank Flapper	10	-/10	CLAM	3.08

### TOILET TANK FLAPPER

- Blue rubber resists hard water
- Universal-fit fits most brass or plastic flush valves
- With stainless steel chain and hook



PART #	DESCRIPTION	UNIT ORDER	INN/MAS	PACK	LIST
40077	Removable Trundle	10	10/200	BAG	2.05

### TOILET TANK FLAPPER - ECONOMY

- Universal-fit fits most brass or plastic flush valves
- With stainless steel chain and hook



PART #	DESCRIPTION	UNIT ORDER	INN/MAS	PACK	LIST
40071	Removable Trundle	10	10/200	BAG	1.77

### TOILET TANK FLAPPER - ECONOMY

- Universal-fit fits most brass or plastic flush valves
- With stainless steel chain and hook



PART #	DESCRIPTION	UNIT ORDER	INN/MAS	PACK	LIST
40073	Cut-Off Type Trundle	10	10/200	BAG	1.68

### KORKY® BLACK FLAPPER

- Molded of durable rubber
- OEM #0054BP



**korky**

PART #	DESCRIPTION	UNIT ORDER	INN/MAS	PACK	LIST
40097	Black Flapper	12	12/72	BLISTER	5.36

### KORKY® PRO RED FLAPPER

- Premium-quality chlorazone rubber
- Material made to withstand chloramine & toilet bowl cleaners
- 5-Year warranty
- Universal replacement
- OEM #2001BP



**korky**

PART #	DESCRIPTION	UNIT ORDER	INN/MAS	PACK	LIST
40098	Red Flapper	12	12/72	BLISTER	7.10

Supply Connectors

Stop Valves

Water Heater

Gas Connectors

Water Filtration

Sinks/ Faucets

Tubular/ Drainage

Faucet Repair

Bath Accessories

Pipe Fittings/ Repair

Valves

Cements/ Sealants

Tools/ Safety

Toilet Repair

Appliance/ HVAC

Hardware

Electrical

Index

# TOILET REPAIR

## Toilet Tank Flappers

### KORKY® UNIVERSAL 3" FLAPPER

- Universal design fits large 3" flush valves
- Adjusts to match performance of original flapper
- Premium red rubber resists chlorine and lasts longer
- Fits Kohler®, TOTO®, American Standard® and all other brands



PART #	DESCRIPTION	UNIT ORDER	INN/MAS	PACK	LIST
40092	Universal 3" Flapper	1	-/5	BLISTER	25.63

### KORKY® ULTRA WATER SAVER 2" FLAPPER

- Adjusts to match original performance for 5, 3.5, 1.6 & 1.28 GPF toilets
- Premium red rubber resists chlorine and lasts longer
- Fits Kohler®, TOTO®, American Standard® and all other brands



PART #	DESCRIPTION	UNIT ORDER	INN/MAS	PACK	LIST
40088	2" Adjustable Flapper	1	-/12	BLISTER	11.58

### TANK FLAPPER - 1.6 GPF

- Designed for newer (since 1995) 1.6 gallon toilets
- Premium red chlorazone rubber resists chlorine



PART #	DESCRIPTION	UNIT ORDER	INN/MAS	PACK	LIST
95004	1.6 GPF Flapper	12	12/72	BLISTER	11.09

### ADJUSTABLE TOILET TANK FLAPPER

- Adjust flush volume with moveable float on chain
- Premium red chlorazone rubber resists chlorine
- Fits Kohler® and American Standard® models
- 5-Year guarantee



PART #	DESCRIPTION	UNIT ORDER	INN/MAS	PACK	LIST
95003	Adjustable Flapper	12	-/12	BLISTER	9.58

### TANK FLAPPER

- Fits Mansfield®
- 3" Flapper



PART #	DESCRIPTION	UNIT ORDER	INN/MAS	PACK	LIST
40311	Tank Flapper	10	-/10	BLISTER	18.16

### TANK FLAPPER

- Replaces Kohler® p/n 1016546 and 1042313
- Premium red chlorazone rubber resists chlorine
- 5-Year guarantee



PART #	DESCRIPTION	UNIT ORDER	INN/MAS	PACK	LIST
95009	Tank Flapper	5	-/5	BLISTER	16.36

### TOILET TANK FLAPPER

- Fits TOTO® G-Max® toilets
- With stainless steel chain



PART #	DESCRIPTION	UNIT ORDER	INN/MAS	PACK	LIST
31010	Flapper	5	-/5	BAG	21.67

### TOILET TANK FLAPPER

- Fits TOTO® Power Gravity®
- With stainless steel chain



PART #	DESCRIPTION	UNIT ORDER	INN/MAS	PACK	LIST
31009	Flapper	10	-/10	BAG	21.67

## Toilet Tank Flappers

### ADJUSTABLE FLAPPER

- Universal-fit
- Includes 5 adjustable time-release tips



PART #	DESCRIPTION	UNIT ORDER	INN/MAS	PACK	LIST
40307	Adjustable Flapper	10	-/10	CLAM	6.64

### ADJUSTABLE FLAPPER

- Fits American Standard® and Kohler®
- Adjust flush volume with movable float on chain



PART #	DESCRIPTION	UNIT ORDER	INN/MAS	PACK	LIST
40306	Adjustable Flapper	1	-/10	CLAM	6.36

### TOILET TANK FLAPPER

- Fits both American Standard® & COAST™ OEM #738071-0070a



PART #	DESCRIPTION	UNIT ORDER	INN/MAS	PACK	LIST
31015	Flapper	1	-/10	BULK	6.81

### TANK FLAPPER

- Fits Crane®



PART #	DESCRIPTION	UNIT ORDER	INN/MAS	PACK	LIST
40308	Tank Flapper	1	-/10	CLAM	5.53

### TANK FLAPPER

- Fits Eljer®



PART #	DESCRIPTION	UNIT ORDER	INN/MAS	PACK	LIST
31004	Flapper	10	-/10	BAG	7.47

### TOILET TANK FLAPPER

- Fits Kohler® Part #738071-0070a



PART #	DESCRIPTION	UNIT ORDER	INN/MAS	PACK	LIST
31005	Flapper	10	-/10	BAG	13.80

### TOILET TANK FLAPPER

- Replaces Kohler® p/n 83064
- Premium chlorazone rubber resists chlorine
- Embedded styrofoam float
- 5-Year guarantee



PART #	DESCRIPTION	UNIT ORDER	INN/MAS	PACK	LIST
95006	Tank Flapper	12	-/12	BLISTER	10.21

### TANK FLAPPER

- Replaces Kohler® p/n 84995 and 1000490
- Premium red chlorazone rubber resists chlorine
- Flapper hinges onto back of flush valve
- 5-Year guarantee



PART #	DESCRIPTION	UNIT ORDER	INN/MAS	PACK	LIST
95007	Tank Flapper	10	-/10	BLISTER	10.21

Supply Connectors

Stop Valves

Water Heater

Gas Connectors

Water Filtration

Sinks/Faucets

Tubular/Drainage

Faucet Repair

Bath Accessories

Pipe Fittings/Repair

Valves

Cements/Sealants

Tools/Safety

Toilet Repair

Appliance/HVAC

Hardware

Electrical

Index

# TOILET REPAIR

## Toilet Tank Flappers

### TANK FLAPPER

- Replaces Kohler® p/n 84318, 84314 and 89825
- Premium red chlorazone rubber resists chlorine
- 5-Year guarantee



PART #	DESCRIPTION	UNIT ORDER	INN/MAS	PACK	LIST
95008	Tank Flapper	10	-/10	BLISTER	10.12

### TOILET TANK FLAPPER

- Fits Kohler®



PART #	DESCRIPTION	UNIT ORDER	INN/MAS	PACK	LIST
40076	With Stainless Steel Chain and Hook	10	10/200	BULK	2.17

### TANK FLAPPER

- Fits American Standard® Cadet III® and Champion®
- 3" Flapper



PART #	DESCRIPTION	UNIT ORDER	INN/MAS	PACK	LIST
40309	Tank Flapper	1	-/10	CLAM	9.89

### TANK FLAPPER

- Fits Eljer® Titan®
- 3" Flapper



PART #	DESCRIPTION	UNIT ORDER	INN/MAS	PACK	LIST
40310	Tank Flapper	1	-/10	CLAM	11.95

## Fill Valves

### TANK BALL

- Fits Eljer® and Kohler®
- Premium red chlorazone rubber resists chlorine
- 5-Year guarantee



PART #	DESCRIPTION	UNIT ORDER	INN/MAS	PACK	LIST
95005	Tank Ball	10	-/10	BLISTER	10.49

### TOILET TANK BALL

- Fits Fit-Rite® style and most brass or plastic flush valves



40086



40085

PART #	DESCRIPTION	UNIT ORDER	INN/MAS	PACK	LIST
40085	With Glide Seat Tip	1	10/100	BAG	1.48
40086	Without Tip	1	10/100	BAG	1.28

### TILT VALVE ACTUATING UNIT

- Fits American Standard® OEM #67388007
- With disc clip



PART #	DESCRIPTION	UNIT ORDER	INN/MAS	PACK	LIST
31019	Actuating Unit	5	-/5	BAG	12.32

### TILT VALVE ACTUATING UNIT

- Fits American Standard®



4-5/8"

PART #	DESCRIPTION	UNIT ORDER	INN/MAS	PACK	LIST
40220	New Style Low Unit	1	25/50	BULK	7.10

## Fill Valves

### TILT VALVE SEAT DISC

- Fits American Standard® tilt flush valves



PART #	DESCRIPTION	UNIT ORDER	INN/MAS	PACK	LIST
40081	Screw-On	1	10/100	BULK	1.05
40083	Snap-On	1	10/200	BULK	0.83

### TOUCH FLUSH VALVE

- Fits Eljer®
- Rubber float



PART #	DESCRIPTION	UNIT ORDER	INN/MAS	PACK	LIST
40079	Chrome-Plated Plastic Handle	1	10/100	BAG	9.58

### ADJUSTABLE ANTI-SIPHON FILL VALVE

- Anti-siphon fill valve
- Adjustable from 8" to 13"
- Easy no-tool installation
- Compare to Fluidmaster® 400A
- 5-Year warranty



PART #	DESCRIPTION	UNIT ORDER	INN/MAS	PACK	LIST
40202	Adjustable Fill Valve	12	-/12	BOX	12.57

### KORKY® QUIETFILL® TOILET FILL VALVE

- Universal replacement for faulty fill valves and ballcocks
- Enclosed float does not hang up on toilet tank walls
- Adjustable from 7-3/4" to 13-1/2"
- Engineered materials resist chlorine
- One-step adjustment with no tool required
- OEM #528



PART #	DESCRIPTION	UNIT ORDER	INN/MAS	PACK	LIST
95001	Adjustable Fill Valve	24	-/24	BOX	16.68

### FLUIDMASTER® ANTI-SIPHON FILL VALVE

- Stop noise and dripping
- Adjustable from 9" to 14"
- Refill tube included
- OEM #400A



PART #	DESCRIPTION	UNIT ORDER	INN/MAS	PACK	LIST
40237	Adjustable Fill Valve	25	-/25	BOX	17.05

### KORKY® PRO GRADE® FILL VALVE

- The most universal fill valve
- Designed to perform better in high-pressure properties
- Adjustable refill port controls amount of water diverted to toilet bowl
- Best fill valve option for new 1.6 and 1.28 GPF toilets
- Fits TOTO®, Kohler®, American Standard®, Gerber® and all other brands
- OEM #528PRO



PART #	DESCRIPTION	UNIT ORDER	INN/MAS	PACK	LIST
40209	Max Performance Pro Grade® Fill Valve	1	-/12	BOX	31.65

Supply Connectors

Stop Valves

Water Heater

Gas Connectors

Water Filtration

Sinks/ Faucets

Tubular/ Drainage

Faucet Repair

Bath Accessories

Pipe Fittings/ Repair

Valves

Cements/ Sealants

Tools/ Safety

Toilet Repair

Appliance/ HVAC

Hardware

Electrical

Index

# TOILET REPAIR

## Fill Valves

### KORKY® WATERWISE® FILL VALVE

- The only dual-shutoff fill valve for flapper leaks & hang ups
- Minimizes costly water loss from leaks
- Universal replacement for faulty fill valves and ballcocks



PART #	DESCRIPTION	UNIT ORDER	INN/MAS	PACK	LIST
*40212	Water Saving Fill Valve	1	-/12	BOX	<b>24.49</b>

\*While Supplies Last

### PLASTIC BALLCOCK

- Water level adjustment screw
- Refill tube
- 5/8" or 1/2" coupling nut
- Flange nut - shank washer - float rod



PART #	DESCRIPTION	UNIT ORDER	INN/MAS	PACK	LIST
40201	8-1/2"	1	-/50	BOX	<b>6.36</b>
40203	10" Anti-Siphon	1	-/50	BOX	<b>7.56</b>

### FLOAT BALL

- High-buoyancy
- Noncorrosive
- Plastic



PART #	DESCRIPTION	UNIT ORDER	INN/MAS	PACK	LIST
40231	4" x 6"	1	-/100	BULK	<b>1.25</b>

### BRASS FLOAT ROD

- Solid brass rod
- 1/4" - 20-Thread on both ends

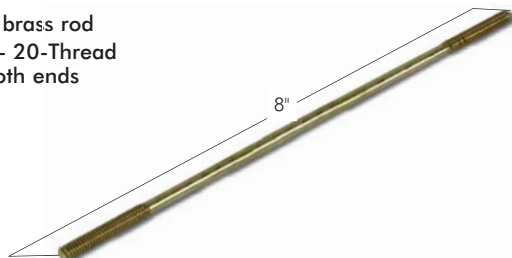

PART #	DESCRIPTION	UNIT ORDER	INN/MAS	PACK	LIST
40093	8" Length	1	-/500	BULK	<b>3.62</b>

## LIFT WIRE

- Solid brass rod

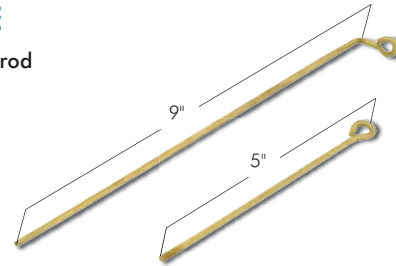

40103

40101

PART #	DESCRIPTION	UNIT ORDER	INN/MAS	PACK	LIST
40101	5" Lower	1	-/2000	BULK	<b>1.57</b>
40103	9" Upper	1	-/1000	BULK	<b>1.85</b>

## Flush Valves

### FLUSH VALVE

- Includes locknut & washer



PART #	DESCRIPTION	UNIT ORDER	INN/MAS	PACK	LIST
40053	Nonmetallic Valve with Flapper and Chain Included	1	10/50	BAG	<b>4.05</b>

### FLUSH VALVE WITH PRO SERIES FLAPPER

- 2" Flush valve
- Universal design, fits most two-piece toilets
- Includes blue pro series flapper



**EASTMAN**

PART #	DESCRIPTION	UNIT ORDER	INN/MAS	PACK	LIST
40080	Universal Flush Valve	1	10/50	BAG	<b>4.33</b>



## Flush Valves

### FLUSH VALVE

- Includes locknut & washer



PART #	DESCRIPTION	UNIT ORDER	INN/MAS	PACK	LIST
40051	Brass Valve & Overflow Tube	2	2/30	BAG	24.99

### KORKY® 3" ADJUSTABLE FLUSH VALVE KIT

- Fits specific toilets since 2000 with large 3" drain openings
- Kit includes: Large 3" flush valve, Korky® 3" adjustable flapper, tank-to-bowl gasket, nuts, bolts & washers
- Fits most 3" two-piece toilet tanks
- Height easily adjusts with oversized tube and funnel to reduce flood risk
- Does not fit any Kohler® toilets



PART #	DESCRIPTION	UNIT ORDER	INN/MAS	PACK	LIST
40214	Flush Valve Kit	1	-/3	BOX	52.23

### KORKY® 2" ADJUSTABLE FLUSH VALVE KIT

- Universal design, fits most two-piece toilets
- Height easily adjusts from 7" to 11.5"
- Oversized tube and funnel reduce flood risk
- 5-Year guarantee
- Adjustable flush valve, Korky® plus flapper, tank-to-bowl gasket, nuts bolts and washers



PART #	DESCRIPTION	UNIT ORDER	INN/MAS	PACK	LIST
95066	Adjustable Flush Valve Kit	1	-/6	BOX	32.02

### JUMBO FLUSH VALVE FOR TWO-PIECE TOILET

- Fits American Standard® Cadet III®, American Standard® Champion®, Eljer®, Kohler® Cimмерon®, Kohler® Class V®, Mansfield® and TOTO®
- Improve flush by increasing velocity of water
- Complete with threaded base, flush valve seal, tank-to-bowl gasket, nut wrench, largest Kohler® Class V® size flapper with 6 E baffles and six-piece tank-to-bowl bolt seal and balance kit



PART #	DESCRIPTION	UNIT ORDER	INN/MAS	PACK	LIST
40312	Jumbo Flush Valve	1	-/1	BOX	26.12

### JUMBO FLUSH VALVE FOR TWO-PIECE TOILET

- Fits American Standard® Cadet III®, American Standard® Champion®, Eljer®, Kohler® Cimмерon®, Kohler® Class V®, Mansfield® and TOTO®
- Improve flush by increasing velocity of water
- Converts most old 2" flush valves for two-piece toilets to larger Kohler® Class V® size
- Complete with threaded base, flush valve seal, tank-to-bowl gasket, nut wrench, largest Kohler® Class V® size flapper with 6 E baffles and six-piece tank-to-bowl bolt seal and balance kit



PART #	DESCRIPTION	UNIT ORDER	INN/MAS	PACK	LIST
40313	2' x 3" Conversion Kit	1	-/1	BOX	34.81

### JUMBO FLUSH VALVE FOR ONE-PIECE TOILET

- Fits Eljer®, Kohler® Cimмерon®, Kohler® Class V®, Mansfield®, Pegusus® and TOTO®
- Improve flush by increasing velocity of water
- Uses largest Kohler® Class V® flapper size



PART #	DESCRIPTION	UNIT ORDER	INN/MAS	PACK	LIST
40314	Jumbo Flush Valve	1	-/1	BOX	61.04

### JUMBO FLUSH VALVE FOR ONE-PIECE TOILET

- Fits American Standard®, Kohler® Class V®, Eljer®, Mansfield® and TOTO®
- Improve flush by increasing velocity of water
- Converts most old 2" flush valves for one-piece toilets to larger Kohler® Class V® size



PART #	DESCRIPTION	UNIT ORDER	INN/MAS	PACK	LIST
40315	2' x 3" Conversion Kit	1	-/1	BOX	39.18

Supply Connectors

Stop Valves

Water Heater

Gas Connectors

Water Filtration

Sinks/Faucets

Tubular/Drainage

Faucet Repair

Bath Accessories

Pipe Fittings/Repair

Valves

Cements/Sealants

Tools/Safety

Toilet Repair

Appliance/HVAC

Hardware

Electrical

Index

# TOILET REPAIR

## Toilet Repair Parts

### BALLCOCK REPAIR KIT

- Fits EZ-FLO® #40202 fill valve



PART #	DESCRIPTION	UNIT ORDER	INN/MAS	PACK	LIST
*40207	Replacement Seal Cap	1	-/25	BAG	2.14

\*While Supplies Last

### BALLCOCK REPAIR KIT

- Fits COAST™



PART #	DESCRIPTION	UNIT ORDER	INN/MAS	PACK	LIST
40208	COAST™ MASTER™ Ballcock Repair Kit	1	-/100	BAG	1.54

### BALLCOCK SEAL

- Fits Fluidmaster®
- Sold and priced per bag of 100



PART #	DESCRIPTION	UNIT ORDER	INN/MAS	PACK	LIST
40225	Ballcock Seal - 100 Pack	1	100/1000	BAG	47.05

### BALLCOCK REPAIR KIT

- Fits Hoover® and Ameriline®
- Includes 4 screws



PART #	DESCRIPTION	UNIT ORDER	INN/MAS	PACK	LIST
40217	Repair Kit	1	50/1000	BAG	4.56

### BALLCOCK TOP

- Fits COAST™ OEM #42393



PART #	DESCRIPTION	UNIT ORDER	INN/MAS	PACK	LIST
31017	Kit	10	-/10	BAG	8.07

### BALLCOCK REPAIR KIT

- Fits Hoover®/ Amerline®
- One screw



PART #	DESCRIPTION	UNIT ORDER	INN/MAS	PACK	LIST
31011	Cartridge with Tool	10	-/10	BAG	2.79

### BALLCOCK KIT

- Fits Mansfield® OEM #630-7984



PART #	DESCRIPTION	UNIT ORDER	INN/MAS	PACK	LIST
31007	Kit	10	-/10	BAG	2.71

### CAP AND PLUNGER WITH SEAT

- Fits American Standard® OEM #7307



PART #	DESCRIPTION	UNIT ORDER	INN/MAS	PACK	LIST
31016	Cap & Plunger	10	-/10	BAG	2.85

### SMALL CLIP SMALL TOP

- Fits COAST™ MARK IV™



PART #	DESCRIPTION	UNIT ORDER	INN/MAS	PACK	LIST
31013	Clip and Top	10	-/10	BAG	3.19

### FLUSH VALVE SEAL GASKET

- Fits Mansfield® OEM #741-0009



PART #	DESCRIPTION	UNIT ORDER	INN/MAS	PACK	LIST
31008	Flush Valve	10	-/10	BAG	1.54

## Toilet Repair Parts

### FLUSH VALVE SEAL GASKET

- Fits Mansfield® OEM #630-483



PART #	DESCRIPTION	UNIT ORDER	INN/MAS	PACK	LIST
31006	Valve Seal	10	-/10	BAG	4.85

## Tank Levers

### 8-1/2" BRASS-PLATED ARM

- Brass-plated arm
- Universal-fit



PART #	DESCRIPTION	UNIT ORDER	INN/MAS	PACK	LIST
40065	Chrome Handle, Plastic Nut	10	10/200	BAG	2.28
40066	Chrome Handle, Metal Nut	10	10/200	BAG	2.68
40049	Brushed Nickel Handle with Plastic Nut	10	10/100	BAG	5.84

### 8-1/2" BRASS ARM

- Heavy-duty universal-fit
- Die-cast handle and nut



PART #	DESCRIPTION	UNIT ORDER	INN/MAS	PACK	LIST
40064	Chrome Handle, Metal Nut	10	10/100	BAG	7.27

### 8-1/2" BRASS ARM

- Heavy-duty universal-fit
- Solid brass arm



PART #	DESCRIPTION	UNIT ORDER	INN/MAS	PACK	LIST
40067	Chrome Handle, Metal Nut	10	10/200	BAG	5.62

### 8-1/2" PLASTIC ARM

- Plastic handle, plastic nut
- Universal-fit with white plastic arm



PART #	DESCRIPTION	UNIT ORDER	INN/MAS	PACK	LIST
40057	Chrome Handle	10	10/200	BAG	1.91
40058	White Handle	10	10/200	BAG	1.48

### 8-1/2" BRASS ARM - HEAVY-DUTY

- Universal-fit
- Solid brass arm



PART #	DESCRIPTION	UNIT ORDER	INN/MAS	PACK	LIST
40062	Chrome Handle, Metal Nut	10	10/200	BAG	5.62

### 9-1/4" BRASS ARM

- Fits Eljer®
- Side mount



PART #	DESCRIPTION	UNIT ORDER	INN/MAS	PACK	LIST
40063	Chrome Handle, Plastic Nut	10	10/200	BAG	5.96

### 4-1/8" BRASS ARM

- Fits American Standard®
- Plastic handle, plastic nut



PART #	DESCRIPTION	UNIT ORDER	INN/MAS	PACK	LIST
*40112	Chrome Handle, Plastic Nut	10	10/50	BAG	2.14

\*While Supplies Last

### 5-1/2" BRASS ARM

- Fits Eljer®, Briggs®, & American Standard®
- Solid brass arm



PART #	DESCRIPTION	UNIT ORDER	INN/MAS	PACK	LIST
40069	Chrome Handle, Metal Nut	10	10/200	BAG	4.90

### 4-1/4" PLASTIC ARM

- Fits Eljer®, Briggs®, & American Standard®
- Plastic handle, plastic nut



PART #	DESCRIPTION	UNIT ORDER	INN/MAS	PACK	LIST
40055	Chrome Handle, Plastic Nut	1	10/200	BAG	1.71

Supply Connectors

Stop Valves

Water Heater

Gas Connectors

Water Filtration

Sinks/Faucets

Tubular/Drainage

Faucet Repair

Bath Accessories

Pipe Fittings/Repair

Valves

Cements/Sealants

Tools/Safety

Toilet Repair

Appliance/HVAC

Hardware

Electrical

Index

# TOILET REPAIR

## Tank Levers

### 4-1/2" SIDE MOUNT BRASS ARM

- Heavy-duty
- Solid brass arm
- Fits Kohler® Rialto®



PART #	DESCRIPTION	UNIT ORDER	INN/MAS	PACK	LIST
*14307	Polished Brass Handle with Metal Nut	1	-/50	BAG	4.28

\*While Supplies Last

### 8-1/2" SOLID BRASS ARM - HEAVY-DUTY

- Brass handle, brass nut
- Heavy-duty arm with external adjustment
- Fits Kohler®



PART #	DESCRIPTION	UNIT ORDER	INN/MAS	PACK	LIST
40061	Chrome Handle, Brass Nut	10	10/60	BAG	23.95

### 8-1/2" SOLID BRASS ARM - HEAVY-DUTY

- Fits Kohler®
- Brass handle



PART #	DESCRIPTION	UNIT ORDER	INN/MAS	PACK	LIST
40060	Chrome Handle, Plastic Nut	10	10/60	BAG	25.12

### 8-1/2" PLASTIC ARM

- Fits Kohler®
- Die-cast handle



PART #	DESCRIPTION	UNIT ORDER	INN/MAS	PACK	LIST
40070	Chrome Handle, Plastic Nut	10	10/200	BAG	9.78

### 9-1/8" PLASTIC ARM

- Fits Mansfield®
- Blue bendable arm
- Plastic handle, plastic nut



PART #	DESCRIPTION	UNIT ORDER	INN/MAS	PACK	LIST
40119	Chrome Handle, Plastic Nut	10	10/100	BAG	2.59

## Toilet Installation Parts

### URINAL FLANGE

- Corrosion-resistant ABS & PVC plastic
- 2" Connection offered in hub and spigot versions
- 4"-7" Adjustable center can be cut easily to accommodate most applications
- Reinforced with a cross rib to prevent the fork from spreading
- Thick foam gasket for positive seal



canplas  
PLUMBING

PART #	DESCRIPTION	UNIT ORDER	INN/MAS	PACK	LIST
73029	PVC - Spigot	1	1/20	BAG	19.02
73030	PVC - Hub	1	1/20	BAG	19.02
73026	ABS - Spigot	1	1/20	BAG	19.02
73027	ABS - Hub	1	1/20	BAG	19.02

### COMBO MAST-R-PRO KIT - FLUSH VALVE REPAIR PARTS

- One kit rebuilds most all royal and regal style Sloan®/Zurn® flush valves
- Rebuilds 4.5, 3.5, 1.6, 1.5 & 1.0 urinals
- Contains: 4.5 GPF inside parts kit, vacuum breaker kit, handle seal kit, 1" shutoff cup seal, 3/4" shutoff cup seal, tailpiece O-ring, GPF reducer adapter set, silicone lube capsule



PART #	DESCRIPTION	UNIT ORDER	INN/MAS	PACK	LIST
86131	Rebuild Kit for Flush Valves	1	1/5	BOX	23.15

### FLUSH VALVE REPAIR KIT

- For Sloan®/Zurn® flush valves
- Control stop repair kit
- 1" Control stop
- Sloan® reference #H-541-A



PART #	DESCRIPTION	UNIT ORDER	INN/MAS	PACK	LIST
86120	Flush Valve Kit	1	1/10	BAG	8.04

## Toilet Installation Parts

### FLUSH VALVE REPAIR KIT

- For Coyne & Delany® closet or urinal flush valves
- Contains: relief valve, bushing, auxiliary valve seal retainer with seal, diaphragm guides, choke ring main seals and friction ring



PART #	DESCRIPTION	UNIT ORDER	INN/MAS	PACK	LIST
60531	4.5 GPF Closet Repair Kit	1	1/100	BULK	49.36
60530	1.5 GPF Urinal Repair Kit	1	1/100	BULK	49.36

### FLUSH VALVE DIAPHRAGM

- For Coyne & Delany® urinal flush valves



PART #	DESCRIPTION	UNIT ORDER	INN/MAS	PACK	LIST
60532	Valve Diaphragm	1	1/100	BULK	10.98

### FLUSH VALVE REPAIR KIT

- Closet/urinal master repair kit
- Includes v/b kit, handle kit, inside repair kit & O-ring
- Sloan® reference numbers:  
(R-1001-A — 4.5 GPF)  
(R-1003-A — 3.5 GPF)  
(R-1002-A — 1.5 GPF Urinal)



PART #	DESCRIPTION	UNIT ORDER	INN/MAS	PACK	LIST
86122	3.5 GPF Closet Repair Kit	1	1/60	BOX	18.42
86123	1.5 GPF Urinal Repair Kit	1	1/60	BOX	18.21

## FLUSH VALVE REPAIR PARTS

- For Sloan®/Zurn® flush valves, closets & urinals
- Sloan® reference numbers:  
(A-156-A — Diaphragm)  
(A-36-A — 4.5 GPF Repair Kit)  
(A-38-A — 3.5 GPF Repair Kit)  
(A-37-A — 1.5 GPF Urinal Repair Kit)  
(A-15-A — Disc)

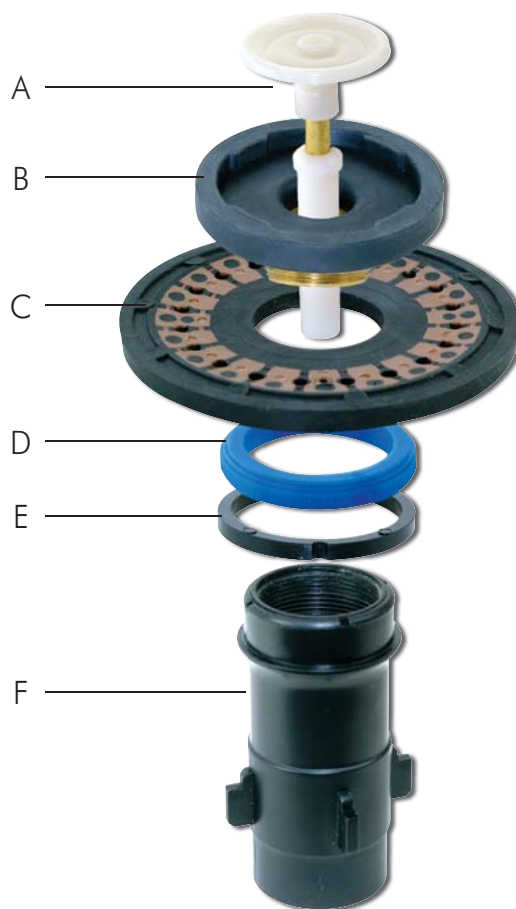

PART #	DESCRIPTION	UNIT ORDER	INN/MAS	PACK	LIST
86128	Disc (B)	1	1/10	BAG	5.73
86124	Diaphragm (C)	1	1/10	BAG	4.39
86125	3.5 GPF Closet Repair Kit - (Includes A-F)	1	1/10	BAG	13.38
86126	4.5 GPF Closet Repair Kit - (Includes A-F)	1	1/10	BAG	13.38
86127	1.5 GPF Urinal Repair Kit - (Includes A-F)	1	1/10	BAG	13.38

Supply Connectors

Stop Valves

Water Heater

Gas Connectors

Water Filtration

Sinks/Faucets

Tubular/Drainage

Faucet Repair

Bath Accessories

Pipe Fittings/Repair

Valves

Cements/Sealants

Tools/Safety

Toilet Repair

Appliance/HVAC

Hardware

Electrical

Index

# TOILET REPAIR

## Toilet Installation Parts

### FLUSH VALVE HANDLE REPAIR KIT

- For Sloan®/Zurn®
- Sloan® OEM #B-51-A



PART #	DESCRIPTION	UNIT ORDER	INN/MAS	PACK	LIST
86129	Handle Repair Kit	1	1/25	BAG	2.51

### VACUUM BREAKER REPAIR KIT

- For Sloan®/Zurn® flush valves, closets & urinals



PART #	DESCRIPTION	UNIT ORDER	INN/MAS	PACK	LIST
86130	Vacuum Breaker Repair Kit	1	1/5	BULK	2.14

## SEE OUR COMPLETE LINE OF ELECTRIC CORDS!

**NEW**

See page... **316**

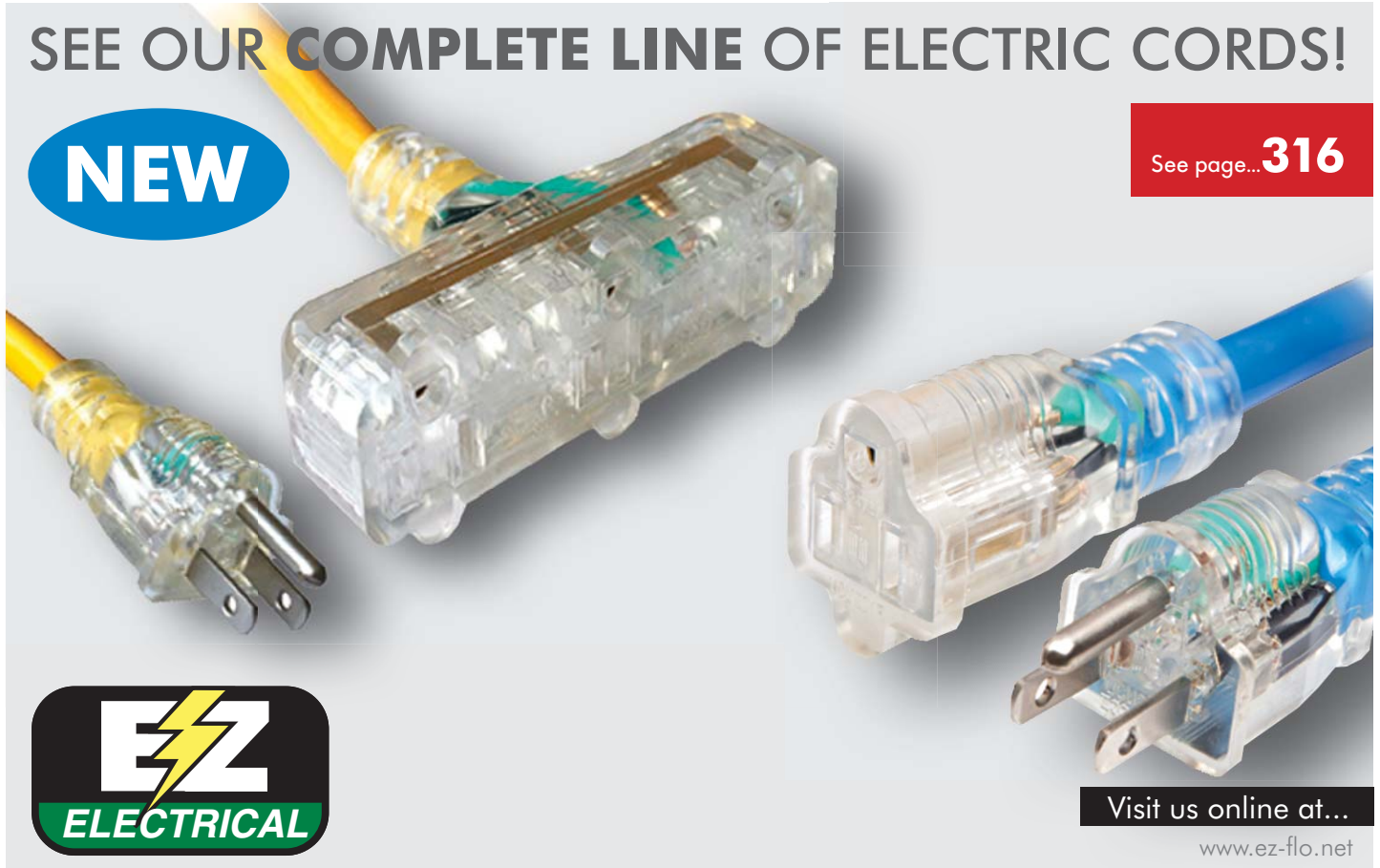

Visit us online at...

[www.ez-flo.net](http://www.ez-flo.net)

## Icemaker Installation Supplies

### STAINLESS STEEL ICEMAKER CONNECTOR 1/4" COMP X 1/4" COMP

- Stainless steel braided
- Nickel-plated brass nuts



PART #	DESCRIPTION	UNIT ORDER	INN/MAS	PACK	LIST
48383	1'	12	12/48	BAG	4.38
48384	2'	12	12/48	BAG	4.90
48387	5'	12	12/48	BAG	9.31
48388	6'	12	-/12	BAG	10.53
48283	8' - <b>NEW!</b>	12	-/12	BAG	11.81
48389	10'	12	-/12	BAG	14.70
48390	15'	12	-/12	BAG	16.74
48391	20' - <b>NEW!</b>	12	-/12	BAG	26.07
48392	25'	12	-/12	BAG	30.48

### STAINLESS STEEL ICEMAKER CONNECTOR 1/4" COMP X 1/4" COMP

- Stainless steel braided
- Nickel-plated brass nuts



PART #	DESCRIPTION	UNIT ORDER	INN/MAS	PACK	LIST
41033	5'	12	-/12	SLEEVE	10.21
41036	10'	12	-/12	SLEEVE	13.28

### STAINLESS STEEL ICEMAKER CONNECTOR 1/4" COMP X 1/4" COMP

- Stainless steel braided
- Nickel-plated brass nuts



PART #	DESCRIPTION	UNIT ORDER	INN/MAS	PACK	LIST
41035	5'	50	-/150	BULK	8.27

### REINFORCED PVC ICEMAKER CONNECTOR 1/4" COMP X 1/4" COMP

- Reinforced PVC
- Nickel-plated brass nuts



PART #	DESCRIPTION	UNIT ORDER	INN/MAS	PACK	LIST
48996	1'	25	25/100	BAG	4.41
48379	5'	12	12/48	BAG	5.91
41062	6'	12	12/48	BAG	6.67
48380	10'	12	-/12	BAG	8.85
48381	15' - <b>NEW!</b>	12	-/12	BAG	13.28

### PEX ICEMAKER CONNECTOR

**NEW**

- PEX 1/8" ID (1/4" OD) gray roll
- Includes captured brass nuts on each end

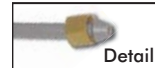

PART #	DESCRIPTION	UNIT ORDER	INN/MAS	PACK	LIST
65013	6'	12	-/12	SLEEVE	3.81
48316	8'	12	-/12	SLEEVE	4.27
65015	10'	12	-/12	SLEEVE	5.28
65017	15'	12	-/12	SLEEVE	7.13

### STAINLESS STEEL ICEMAKER KIT 1/4" COMP X 1/4" COMP

**NEW**

- 10' Stainless steel braided icemaker hose
- Brass self-piercing saddle valve



PART #	DESCRIPTION	UNIT ORDER	INN/MAS	PACK	LIST
91311N	10' Kit	12	-/12	BAG	16.79

### REINFORCED PVC ICEMAKER KIT

- Includes:
  - 1 - 1/4" Female flare x 1/4" comp adapter
  - 1 - 1/4" Comp x comp union
  - 1 - 5' or 10' PVC hose



PART #	DESCRIPTION	UNIT ORDER	INN/MAS	PACK	LIST
60489	5' Kit	1	-/50	BAG	12.52
60490	10' Kit	1	-/50	BAG	13.55

Supply Connectors

Stop Valves

Water Heater

Gas Connectors

Water Filtration

Sinks/ Faucets

Tubular/ Drainage

Faucet Repair

Bath Accessories

Pipe Fittings/ Repair

Valves

Cements/ Sealants

Tools/ Safety

Toilet Repair

Appliance/ HVAC

Hardware

Electrical

Index

# APPLIANCE AND HVAC

## Icemaker Installation Supplies

### REINFORCED PVC ICEMAKER KIT 1/4" COMP X 1/4" COMP

**NEW**

- 10' Reinforced PVC icemaker hose
- Brass self-piercing saddle valve



PART #	DESCRIPTION	UNIT ORDER	INN/MAS	PACK	LIST
91310N	10' Kit	12	-/12	BAG	12.00

### PEX ICEMAKER KIT

- PEX 1/8" ID (1/4" OD) gray roll
- (2) 1/4" OD push-fit x 1/4" female comp adapters



PART #	DESCRIPTION	UNIT ORDER	INN/MAS	PACK	LIST
60479N	15' Kit	1	-/12	BAG	15.10
60474N	25' Kit	1	-/12	BAG	18.37

### PEX ICEMAKER KIT

- PEX 1/8" ID (1/4" OD) gray roll
- (1) 1/4" OD push-fit x 1/4" female comp adapter
- (1) 1/4" OD push-fit union
- (1) 5/8" OD push-fit x 5/8" OD push-fit x 1/4" OD push-fit slip tee valve



PART #	DESCRIPTION	UNIT ORDER	INN/MAS	PACK	LIST
60466N	15' Kit	1	-/12	BAG	30.35
60451N	25' Kit	1	-/12	BAG	34.02

### PEX ICEMAKER KIT

- PEX 1/8" ID (1/4" OD) gray roll
- (1) 1/4" OD push-fit x 1/4" female comp adapter
- (1) 3/8" Female comp x 3/8" male comp x 1/4" OD push-fit add-an-outlet valve



PART #	DESCRIPTION	UNIT ORDER	INN/MAS	PACK	LIST
60473N	15' Kit	1	-/12	BAG	26.89
60467N	25' Kit	1	-/12	BAG	29.53

## POLYETHYLENE TUBING ICEMAKER FILTER KIT

- Includes:
  - 1 - 10" Water filter - taste & odor
  - 1 - 25' x 1/4" Poly tube
  - 1 - Self-piercing saddle valve
  - 2 - 1/4" MIP x comp adapters



PART #	DESCRIPTION	UNIT ORDER	INN/MAS	PACK	LIST
48355	Filter Kit	10	-/40	BAG	24.39

## POLYETHYLENE TUBING ICEMAKER KIT

- Includes:
  - 1 - 1/4" x 25' Poly tube
  - 1 - Self-piercing saddle valve
  - 1 - 1/4" Comp x comp union
  - 2 - Brass inserts
  - 2 - Delrin sleeves



PART #	DESCRIPTION	UNIT ORDER	INN/MAS	PACK	LIST
48362	Installation Kit	1	-/50	BAG	13.20

## COPPER TUBE ICEMAKER KIT

- Includes:
  - 1 - 1/4" x 15' Copper tube
  - 1 - Self-piercing saddle valve
  - 1 - 1/4" Comp x comp union



PART #	DESCRIPTION	UNIT ORDER	INN/MAS	PACK	LIST
48398	Copper Tube Kit	6	6/24	BAG	28.71



## Icemaker Installation Supplies

### PEX TUBING

- PEX 1/8" ID (1/4" OD) gray roll



COMPLIES WITH NSF-61 UFC LEAD-FREE EASTMAN

PART #	DESCRIPTION	UNIT ORDER	INN/MAS	PACK	LIST
86089	15'	1	-/25	BULK	10.75
86090	25'	1	-/25	BULK	13.39

### POLYETHYLENE TUBING - BULK

**NEW**

- Lightweight, semi-rigid tubing
- Strong resistance to chemicals, corrosion and impact
- 150 ft. per box
- Priced per foot, sold per box



EZ-FLO

PART #	DESCRIPTION	UNIT ORDER	INN/MAS	PACK	LIST
98582	1/4" OD	150 ft.	-/150	ROLL	0.20

### SELF-PIERCING SADDLE VALVE

- Brass
- 1/4" OD comp outlet on needle valve kit consists of needle valve, saddle and clamp



COMPLIES WITH NSF-372 UFC LEAD-FREE EASTMAN

PART #	DESCRIPTION	UNIT ORDER	INN/MAS	PACK	LIST
65801LF	Fits 3/8" - 1" Copper Tube	10	-/200	BAG	4.68

### IN-LINE WATER FILTER

- In-line filter for icemaker & drinking water
- 6" Taste & odor water filter
- Includes 2 brass 1/4" MIP x 1/4" comp adapters



LEAD-FREE EZ-FLO

PART #	DESCRIPTION	UNIT ORDER	INN/MAS	PACK	LIST
60476N	6" Taste and Odor Filter	1	-/50	BULK	16.29

### IN-LINE WATER FILTER

- 1500 Gallon capacity
- 10" Water filter
- Includes 2 brass 1/4" MIP x 1/4" comp adapters



LEAD-FREE EZ-FLO

PART #	DESCRIPTION	UNIT ORDER	INN/MAS	PACK	LIST
<b>TASTE AND ODOR</b>					
60461N	10" Filter	1	-/48	BAG	15.09
<b>TASTE, ODOR AND SCALE</b>					
60458N	10" Filter	1	-/48	BAG	26.80

### FREEZER/REFRIGERATOR THERMOMETER

- Temperature range of -20° F to 80° F
- Four safe-zone temperature indicators
- Stands or hangs
- Works with all freezer and refrigerator brands



EZ-FLO

PART #	DESCRIPTION	UNIT ORDER	INN/MAS	PACK	LIST
77501	Chrome-Plated Freezer Thermometer	1	-/48	BLISTER	5.53

## Dishwasher Installation Supplies

### STAINLESS STEEL DISHWASHER CONNECTOR COMP X 3/8" MIP ELBOW

- Stainless steel braided
- Nickel-plated brass nuts
- Includes 3/8" comp x 3/8" MIP elbow



UFC SP LEAD-FREE EASTMAN

PART #	DESCRIPTION	UNIT ORDER	INN/MAS	PACK	LIST
48747	3/8" Comp x 3/8" MIP Elbow - 4'	12	-/12	BAG	12.93
48364	3/8" Comp x 3/8" MIP Elbow - 5'	12	-/12	BAG	13.20
48365	3/8" Comp x 3/8" MIP Elbow - 6'	12	-/12	BAG	14.15
48366	3/8" Comp x 3/8" MIP Elbow - 8'	12	-/12	BAG	18.10
48363	1/2" Comp x 3/8" MIP Elbow - 5'	12	-/12	BAG	16.22

Supply Connectors

Stop Valves

Water Heater

Gas Connectors

Water Filtration

Sinks/Faucets

Tubular/Drainage

Faucet Repair

Bath Accessories

Pipe Fittings/Repair

Valves

Cements/Sealants

Tools/Safety

Toilet Repair

Appliance/HVAC

Hardware

Electrical

Index

# APPLIANCE AND HVAC

## Dishwasher Installation Supplies

### STAINLESS STEEL DISHWASHER CONNECTOR - UNIVERSAL-FIT

**NEW**

- Stainless steel braided
- Nickel-plated brass nuts
- 1/2" Comp and 1/2" FIP water supply valve adapters
- 3/8" MIP elbow and 3/4" FHT elbow



PART #	DESCRIPTION	UNIT ORDER	INN/MAS	PACK	LIST
41130	5' Kit	12	-/12	SLEEVE	16.85
41132	8' Kit	12	-/12	SLEEVE	20.82
69008	12' Kit	10	-/10	BAG	22.21

### STAINLESS STEEL DISHWASHER CONNECTOR 3/8" COMP X 3/8" MIP ELBOW

- Stainless steel braided
- Nickel-plated brass nuts
- Includes 3/8" comp x 3/8" MIP elbow



PART #	DESCRIPTION	UNIT ORDER	INN/MAS	PACK	LIST
41040	6'	50	-/50	BULK	13.58

### STAINLESS STEEL DISHWASHER CONNECTOR 3/8" COMP X 3/8" COMP

- Fits all dishwasher connections
- Includes 2 elbow fittings 3/8" MIP and 3/4" FHT
- Stainless steel braided
- Nickel-plated brass nuts



PART #	DESCRIPTION	UNIT ORDER	INN/MAS	PACK	LIST
41037	4'	12	-/12	BAG	14.04
41041	5'	12	-/12	BAG	14.89
41045	6'	12	-/12	BAG	15.81
41059	8'	12	-/12	BAG	20.36
41060	10'	12	-/12	BAG	25.17
41058	12'	12	-/12	BAG	30.13

### STAINLESS STEEL DISHWASHER CONNECTOR 1/2" FIP X 3/8" MIP ELBOW

- Stainless steel braided
- Nickel-plated brass nuts
- Includes 3/8" comp x 3/8" MIP elbow



PART #	DESCRIPTION	UNIT ORDER	INN/MAS	PACK	LIST
41032	6'	12	-/12	BAG	17.20

### STAINLESS STEEL DISHWASHER CONNECTOR 3/8" COMP X 3/4" FHT

- Stainless steel braided
- Nickel-plated brass nuts
- Connects directly to 3/4" hose thread inlet
- Fits Whirlpool® OEM dishwashers after Sept. 2009



PART #	DESCRIPTION	UNIT ORDER	INN/MAS	PACK	LIST
41042	5'	12	-/12	BAG	14.23
41043	6'	12	-/12	BAG	14.62
41013	8' - <b>NEW!</b>	12	-/12	BAG	15.30
41015	10' - <b>NEW!</b>	12	-/12	BAG	15.68

### REINFORCED PVC DISHWASHER CONNECTOR 3/8" COMP X 3/8" COMP

- Reinforced PVC
- Nickel-plated brass nuts
- Includes 3/8" MIP elbow and 3/4" FHT elbow



PART #	DESCRIPTION	UNIT ORDER	INN/MAS	PACK	LIST
41061	6'	1	-/24	BAG	12.49

## Dishwasher Installation Supplies

### STAINLESS STEEL DISHWASHER INSTALLATION KIT - 3/8" COMP X 3/8" COMP

- Includes 6' stainless steel braided water connector
- Includes both elbow fittings - hose thread and male pipe thread
- Includes one hose clamp for drain hose
- Includes 3 wire nuts and one 1/2" romex connector for cord



PART #	DESCRIPTION	UNIT ORDER	INN/MAS	PACK	LIST
48336	6' Installation Kit	1	-/12	BAG	13.83

### STAINLESS STEEL DISHWASHER KIT 3/8" COMP X 3/8" COMP

- 6' Stainless steel braided water connector
- 3/8" MIP elbow and 3/4" FHT elbow
- 1/2" Nom push-fit x 3/8" OD comp stop valve
- 1-1/2" Hub x 1-1/2" hub x 3/4" hose barb ABS DWV WYE
- 5'4" UL listed straight cord with built-on harness for quick install, 3 wire nuts, 1 stainless steel hose clamp, push-fit fitting demount clip and teflon tape



PART #	DESCRIPTION	UNIT ORDER	INN/MAS	PACK	LIST
41152	6' Kit	1	-/12	BAG	28.82

### STAINLESS STEEL QUICK-CONNECT DISHWASHER KIT 3/8" COMP X 3/4" FHT ELBOW

- 6' Stainless steel braided water connector with 3/4" FHT elbow
- 5'4" UL listed straight cord with built-on harness for quick install, 3 wire nuts and 1 stainless steel hose clamp
- Works with most major brands



PART #	DESCRIPTION	UNIT ORDER	INN/MAS	PACK	LIST
41140	6' Kit	1	-/12	BAG	16.22

### STAINLESS STEEL DISHWASHER KIT 3/8" COMP X 3/8" COMP

**NEW**

- 6' Stainless steel braided water connector
- 3/8" MIP elbow and 3/4" FHT elbow
- 6' UL listed straight or angled cord, 3 wire nuts, 1 stainless steel hose clamp, 1 romex connector and teflon tape



PART #	DESCRIPTION	UNIT ORDER	INN/MAS	PACK	LIST
41150	6' Kit with Straight Cord	1	-/12	BAG	23.51
48337N	6' Kit with Angled Cord	1	-/12	BAG	24.11

### STAINLESS STEEL DISHWASHER AND DRAIN KIT

**NEW**

- 10' Stainless steel braided water connector
- 10' White corrugated discharge hose
- 1/2" Comp and 1/2" FIP water supply valve adapters
- 3/8" MIP elbow
- Includes 1 stainless steel hose clamp



PART #	DESCRIPTION	UNIT ORDER	INN/MAS	PACK	LIST
69007	10' Small Port Kit	1	-/10	BAG	31.57
69006	10' Large Port Kit	1	-/10	BAG	32.74

### UNIVERSAL-FIT DISHWASHER DISCHARGE HOSE

**NEW**

- 5/8" or 7/8" drain outlet
- Straight ends
- White plastic



PART #	DESCRIPTION	UNIT ORDER	INN/MAS	PACK	LIST
91225	6'	1	-/10	BAG	9.50

Supply Connectors

Stop Valves

Water Heater

Gas Connectors

Water Filtration

Sinks/Faucets

Tubular/Drainage

Faucet Repair

Bath Accessories

Pipe Fittings/Repair

Valves

Cements/Sealants

Tools/Safety

Toilet Repair

Appliance/HVAC

Hardware

Electrical

Index



# APPLIANCE AND HVAC

## Dishwasher Installation Supplies

### UNIVERSAL-FIT DISHWASHER DISCHARGE HOSE

**NEW**

- 5/8" or 7/8" drain outlet
- 90° Rubber elbow end
- Gray plastic



**EASTMAN®**

PART #	DESCRIPTION	UNIT ORDER	INN/MAS	PACK	LIST
91227	6'	1	-/10	BAG	9.53
91218	8' - <b>NEW!</b>	1	-/10	BAG	12.55

### DISHWASHER DISCHARGE HOSE

**NEW**

- Fits Maytag® and Whirlpool® dishwashers
- 5/8" or 7/8" drain outlet
- Replaces factory hose for extended length
- White plastic



**EASTMAN®**

PART #	DESCRIPTION	UNIT ORDER	INN/MAS	PACK	LIST
69010	12'	1	-/10	BAG	12.36

### DISHWASHER DISCHARGE HOSE EXTENSION

**NEW**

- Fits GE® dishwashers
- White plastic



**EASTMAN®**

PART #	DESCRIPTION	UNIT ORDER	INN/MAS	PACK	LIST
69009	12'	1	-/10	BAG	12.36

### DISHWASHER HOT WATER DRAIN HOSE

- Reinforced EPDM rubber hose
- Sold and priced per coil only



PART #	DESCRIPTION	UNIT ORDER	INN/MAS	PACK	LIST
60363	5/8" ID x 50'	1	-/1	BOX	74.93
60365	7/8" ID x 50'	1	-/1	BOX	100.51

### STRAIGHT 14/3 PIGTAIL CORD

**NEW**

- 14/3 Wire
- Rated 15 Amp/125 Volt
- UL listed for garbage disposals, motors, tools and appliances



**15 AMP**

**UL EASTMAN®**

PART #	DESCRIPTION	UNIT ORDER	INN/MAS	PACK	LIST
69022	3'	10	10/100	BULK	5.84
69024	6'	10	10/100	BULK	9.27

### ANGLED 14/3 PIGTAIL CORD

**NEW**

- 14/3 Wire
- Rated 15 Amp/125 Volt
- UL listed for garbage disposals, motors, tools and appliances



**15 AMP**

**UL EASTMAN®**

PART #	DESCRIPTION	UNIT ORDER	INN/MAS	PACK	LIST
69018	3'	10	10/100	BULK	5.84
69020	6'	10	10/100	BULK	9.27
69021	8'	10	10/100	BULK	10.95

### UNIVERSAL DISHWASHER POWER CORD KIT

- 5'4" UL listed straight or angled cord with built-on harness for quick install
- 16-Gauge, 13 Amp, 125 Volt, 3-wire power cord
- Includes 3 wire nuts
- Works with most major brands



**13 AMP**

**UL EASTMAN®**

PART #	DESCRIPTION	UNIT ORDER	INN/MAS	PACK	LIST
69011	5'4" Straight Cord Kit	12	12/96	BAG	6.83
69012	5'4" Angled Cord Kit - <b>NEW!</b>	12	12/96	BAG	7.21

## Dishwasher Installation Supplies

### COMPRESSION DISHWASHER ELBOW

- Fits dishwashers with 3/4" MHT inlet
- 3/4" FHT x 3/8" comp



PART #	DESCRIPTION	UNIT ORDER	INN/MAS	PACK	LIST
65446LF	Less Nut & Sleeve	5	5/200	BULK	4.99
65447LF	With 3/8" OD Nut & Ring	12	12/48	CLAM	6.42

### DISHWASHER WYE - ABS DWV

- Can be installed in horizontal or vertical configurations during rough-in
- Snap-in plug included
- Hub x hub x hose barb



PART #	DESCRIPTION	UNIT ORDER	INN/MAS	PACK	LIST
60519	1-1/2" x 1-1/2" x 3/4"	1	-/40	BULK	2.65

### DISHWASHER MOUNTING BRACKET

- Easy installation under any type of counter
- Eliminates dishwasher anchoring problems
- 22-Gauge galvanized steel



PART #	DESCRIPTION	UNIT ORDER	INN/MAS	PACK	LIST
41016	Under-Counter EZ Bracket	1	-/25	BULK	10.69

### DISHWASHER PAN

- Protects floor from dishwasher leaks
- High-impact plastic will not rust, corrode or crack



PART #	DESCRIPTION	UNIT ORDER	INN/MAS	PACK	LIST
70486	24" x 20.5" OD	1	-/20	BOX	24.66

## Washing Machine Installation

### STAINLESS STEEL WASHING MACHINE HOSE - SINGLE

- 3/4" FHT x 3/4" FHT
- Stainless steel braided
- Nickel-plated brass nuts with stainless steel ferrules
- 3/8" Full-flow, high-pressure hose
- Working temperature of 15° F - 158° F
- For residential use only



PART #	DESCRIPTION	UNIT ORDER	INN/MAS	PACK	LIST
48367	4'	12	-/12	BAG	12.44
48368	5'	12	-/12	BAG	14.29
48369	6'	12	-/12	BAG	15.73
48640	10' - <b>NEW!</b>	12	-/12	BAG	20.98
41026	4'	12	-/12	SLEEVE	13.20
41027	5'	12	-/12	SLEEVE	12.82
41029	4'	50	-/50	BULK	11.08
41028	5'	50	-/50	BULK	13.53

### STAINLESS STEEL WASHING MACHINE HOSE - 1 PAIR

- 3/4" FHT x 3/4" FHT
- Stainless steel braided
- Nickel-plated brass nuts with stainless steel ferrules
- 3/8" Full-flow, high-pressure hose
- Working temperature of 15° F - 158° F
- For residential use only



PART #	DESCRIPTION	UNIT ORDER	INN/MAS	PACK	LIST
48370	4' Pair	12	-/12	BAG	23.73
48371	5' Pair	12	-/12	BAG	27.08
48372	6' Pair	12	-/12	BAG	30.13
41063	5' Pair	12	-/12	SLEEVE	20.28
41067	6' Pair	12	-/6	CLAM	29.37

Supply Connectors

Stop Valves

Water Heater

Gas Connectors

Water Filtration

Sinks/Faucets

Tubular/Drainage

Faucet Repair

Bath Accessories

Pipe Fittings/Repair

Valves

Cements/Sealants

Tools/Safety

Toilet Repair

Appliance/HVAC

Hardware

Electrical

Index

# APPLIANCE AND HVAC

## Washing Machine Installation

### STAINLESS STEEL WASHING MACHINE HOSE WITH 90° ELBOW - **SINGLE**

- 3/4" FHT x 3/4" FHT
- Stainless steel braided
- Nickel-plated brass nuts with stainless steel ferrules
- 3/8" Full-flow, high-pressure hose
- Working temperature of 15° F - 158° F
- For residential use only



PART #	DESCRIPTION	UNIT ORDER	INN/MAS	PACK	LIST
48373	4'	12	-/12	BAG	13.36
48374	5'	12	-/12	BAG	15.68
48375	6'	12	-/12	BAG	17.45

### STAINLESS STEEL WASHING MACHINE HOSE WITH 90° ELBOW - **1 PAIR**

- 3/4" FHT x 3/4" FHT
- Stainless steel braided
- Nickel-plated brass nuts with stainless steel ferrules
- 3/8" Full-flow, high-pressure hose
- Working temperature of 15° F - 158° F
- For residential use only



PART #	DESCRIPTION	UNIT ORDER	INN/MAS	PACK	LIST
48376	4' Pair	12	-/12	BAG	28.30
48377	5' Pair	12	-/12	BAG	29.50
48378	6' Pair	12	-/12	BAG	31.43

### STAINLESS STEEL WASHING MACHINE HOSE WITH 90° ELBOW - **1 PAIR**

- 3/4" FHT x 3/4" FHT
- Stainless steel braided
- Nickel-plated brass nuts with stainless steel ferrules
- 3/8" Full-flow, high-pressure hose
- Working temperature of 15° F - 158° F
- For residential use only



PART #	DESCRIPTION	UNIT ORDER	INN/MAS	PACK	LIST
41065	5' Pair	12	-/12	SLEEVE	22.67
41066	6' Pair	12	-/12	SLEEVE	25.07

### PVC-COATED STAINLESS STEEL WASHING MACHINE HOSE WITH 90° ELBOW - **1 PAIR**

- 3/4" FHT x 3/4" FHT
- Corrosion-resistant PVC-coated stainless steel braided hose
- Nickel-plated brass nuts with stainless steel ferrules
- 3/8" Full-flow, high-pressure hose
- Working temperature of 15° F - 158° F
- For residential use only



PVC Coated



PART #	DESCRIPTION	UNIT ORDER	INN/MAS	PACK	LIST
48319	4' Pair	1	-/12	SLEEVE	23.13

### HIGH-EFFICIENCY PVC-COATED STAINLESS STEEL WASHING MACHINE HOSE WITH 90° ELBOW - **1 PAIR**

**NEW**

- 3/4" FHT x 3/4" FHT
- Triple reinforced, PVC wrapped, stainless steel hose for maximum burst strength
- Extremely flexible for fast and easy installation
- 90° Elbow fits easier in tight spaces
- Heavy-duty solid brass nuts
- 1/2" Hose diameter for faster fill



PART #	DESCRIPTION	UNIT ORDER	INN/MAS	PACK	LIST
41180	6' Pair	1	-/6	BOX	41.45

## Washing Machine Installation

### RUBBER WASHING MACHINE HOSE - 1 PAIR

- 3/4" FHT x 3/4" FHT
- Red and blue rubber
- 200 PSI working pressure
- 800 PSI bursting pressure

**NEW**



**EASTMAN.**

PART #	DESCRIPTION	UNIT ORDER	INN/MAS	PACK	LIST
60482	4' Pair	1	-/15	BAG	<b>15.70</b>
60484	5' Pair	1	-/15	BAG	<b>16.11</b>
60486	6' Pair	1	-/15	BAG	<b>16.47</b>

### RUBBER WASHING MACHINE HOSE - 1 PAIR

- 3/4" FHT x 3/4" FHT
- 3/8" Black rubber, high-pressure hose
- 200 PSI working pressure
- 800 PSI burst pressure

**NEW**



**EASTMAN.**

PART #	DESCRIPTION	UNIT ORDER	INN/MAS	PACK	LIST
60322N	4' Pair	10	-/20	BAG	<b>10.89</b>
60326N	5' Pair	10	-/20	BAG	<b>12.14</b>
60320N	6' Pair	10	-/20	BAG	<b>13.58</b>
60304	8' Pair	10	-/20	BAG	<b>17.64</b>

### RUBBER WASHING MACHINE HOSE WITH 90° ELBOW - 1 PAIR

- 3/4" FHT x 3/4" FHT
- Red and blue rubber
- 200 PSI working pressure
- 800 PSI bursting pressure



**EASTMAN.**

PART #	DESCRIPTION	UNIT ORDER	INN/MAS	PACK	LIST
60314	4' Pair - <b>NEW!</b>	1	-/15	BAG	<b>16.49</b>
60315	5' Pair - <b>NEW!</b>	1	-/15	BAG	<b>16.85</b>
60318	6' Pair	1	-/15	BAG	<b>17.12</b>

### RUBBER WASHING MACHINE HOSE WITH 90° ELBOW - SINGLE

- 3/4" FHT x 3/4" FHT
- 3/8" Black rubber, high-pressure hose
- 200 PSI working pressure
- 800 PSI burst pressure



**EASTMAN.**

PART #	DESCRIPTION	UNIT ORDER	INN/MAS	PACK	LIST
60331N	4' - <b>NEW!</b>	10	-/20	BAG	<b>7.29</b>
60333N	5'	10	-/20	BAG	<b>9.01</b>
60335N	6' - <b>NEW!</b>	10	-/20	BAG	<b>10.70</b>

### RUBBER WASHING MACHINE HOSE - SINGLE

- 3/4" FHT x 3/4" FHT
- 3/8" Black rubber, high-pressure hose
- 200 PSI working pressure
- 800 PSI burst pressure



**EASTMAN.**

PART #	DESCRIPTION	UNIT ORDER	INN/MAS	PACK	LIST
60321N	4'	10	-/20	BAG	<b>5.72</b>
60323N	5'	10	-/20	BAG	<b>6.40</b>
60325N	6'	10	-/20	BAG	<b>7.05</b>
60327N	8'	10	-/20	BAG	<b>9.28</b>
60329N	10'	10	-/20	BAG	<b>11.81</b>

### RUBBER WASHING MACHINE HOSE WITH 90° ELBOW - 1 PAIR

**NEW**

- 3/4" FHT x 3/4" FHT
- 3/8" Black rubber, high-pressure hose
- 200 PSI working pressure
- 800 PSI burst pressure



**EASTMAN.**

PART #	DESCRIPTION	UNIT ORDER	INN/MAS	PACK	LIST
60350	4' Pair	10	-/20	BAG	<b>9.98</b>
60308	5' Pair	10	-/20	BAG	<b>17.28</b>
60310	6' Pair	10	-/20	BAG	<b>20.74</b>

Supply Connectors

Stop Valves

Water Heater

Gas Connectors

Water Filtration

Sinks/ Faucets

Tubular/ Drainage

Faucet Repair

Bath Accessories

Pipe Fittings/ Repair

Valves

Cements/ Sealants

Tools/ Safety

Toilet Repair

Appliance/ HVAC

Hardware

Electrical

Index

# APPLIANCE AND HVAC

## Washing Machine Installation

### PVC WASHING MACHINE HOSE WITH 90° ELBOW - **SINGLE**

- 3/4" FHT x 3/4" FHT
- Black PVC



**EASTMAN®**

PART #	DESCRIPTION	UNIT ORDER	INN/MAS	PACK	LIST
95111	5'	1	-/20	BAG	7.65

### SSD-STYLE WASHING MACHINE DISCHARGE HOSE

- Universal-fit gray flexible PVC
- Fits 1", 1-1/8" or 1-1/4" outlets



**EASTMAN®**

PART #	DESCRIPTION	UNIT ORDER	INN/MAS	PACK	LIST
48397	6'	1	-/12	BAG	13.36
60357	8'	1	-/12	BAG	15.35
60358	10' - <b>NEW!</b>	1	-/12	BAG	16.77

### RUBBER WASHING MACHINE EXTENSION HOSE - 3/4" MHT X 3/4" FHT

- 3/8" Rubber hose
- Nickel-plated brass nuts
- Extends reach to water supply



**NEW**

**EASTMAN®**

PART #	DESCRIPTION	UNIT ORDER	INN/MAS	PACK	LIST
41136	4'	5	-/20	BULK	8.87

### PVC WASHING MACHINE DISCHARGE HOSE

**NEW**

- Black flexible corrugated PVC



**EASTMAN®**

PART #	DESCRIPTION	UNIT ORDER	INN/MAS	PACK	LIST
60352	6'	1	-/6	BAG	13.01

### RUBBER WASHING MACHINE EXTENSION HOSE - 3/4" MHT X 3/4" MHT

- 3/8" Rubber hose
- Nickel-plated brass nuts
- Extends reach to water supply



**NEW**

**EASTMAN®**

PART #	DESCRIPTION	UNIT ORDER	INN/MAS	PACK	LIST
41138	3'	5	-/20	BULK	11.81

### WASHING MACHINE DRAIN HOSE

- Fits GE® top-load washing machines
- Fits 3/4", 7/8" or 1" outlets



**EASTMAN®**

PART #	DESCRIPTION	UNIT ORDER	INN/MAS	PACK	LIST
91228	6'	1	-/25	BULK	15.24
91229	Clip	1	-/1	BULK	2.33

### RUBBER WASHING MACHINE Y MIXER HOSE

- 3/4" FHT x 3/4" FHT inlet
- 3/4" MHT outlet
- Black rubber



**EASTMAN®**

PART #	DESCRIPTION	UNIT ORDER	INN/MAS	PACK	LIST
60349N	1' Legs	5	-/15	BAG	8.14

### WASHING MACHINE DISCHARGE HOSE

- Molded rubber
- Fits 3/4", 7/8", 1", 1-1/8" or 1-1/4" outlets



**EASTMAN®**

PART #	DESCRIPTION	UNIT ORDER	INN/MAS	PACK	LIST
60355	6'	1	-/8	BAG	8.71



## Washing Machine Installation

### RUBBER UTILITY/DEHUMIDIFIER DRAIN HOSE

**NEW**

- Premium EPDM rubber construction
- Lays flat and does not coil
- 3/4" FHT connection x open



**EASTMAN**

PART #	DESCRIPTION	UNIT ORDER	INN/MAS	PACK	LIST
60307	5'	5	-/25	BAG	8.33
60309	12'	5	-/20	BAG	12.57

### WASHING MACHINE ELBOW

**NEW**

- Durable brass construction
- Helps reduce unnecessary stress and strain on water intake hose fittings
- Designed to help prevent hose crimping to extend the life of your hose
- Winged FHT nut to easily tighten



**EASTMAN**

PART #	DESCRIPTION	UNIT ORDER	INN/MAS	PACK	LIST
65450	3/4" FHT x 3/4" MHT - 1 Pair	12	-/12	BAG	10.12

### WASHING MACHINE GOOSENECK DRAIN HOOK

**NEW**

- Secures washing machine drain hose
- 1" Drain diameter
- Burst strength: 60 PSI



**EASTMAN**

PART #	DESCRIPTION	UNIT ORDER	INN/MAS	PACK	LIST
41190	1" Aluminum Gooseneck	6	-/6	BAG	5.61

### WASHING MACHINE FILTER HOSE WASHER

**NEW**

- Brass mesh screen



PART #	DESCRIPTION	UNIT ORDER	INN/MAS	PACK	LIST
70144	Filter Hose Washer - 10 Pack	12	-/12	BAG	4.19

### WASHING MACHINE HOSE WASHER

**NEW**

- Red rubber washer



PART #	DESCRIPTION	UNIT ORDER	INN/MAS	PACK	LIST
70145	Hose Washer - 10 Pack	12	-/12	BAG	2.15

## WASHING MACHINE PAN

- Protects floor from washing machine leaks
- High-impact plastic will not rust, corrode or crack
- **52525** - Deeper pan depth allows side mount of drain fitting
- **52528** - Low-profile designed to work with front loading machines



52525



52528

**EASTMAN**

PART #	DESCRIPTION	UNIT ORDER	INN/MAS	PACK	LIST
52525	30" x 32" OD	1	-/10	BOX	31.02
52528	Low Profile - 30.5" x 34.5" OD	1	-/10	BOX	32.50

## Dryer Installation

### EPOXY-COATED GAS DRYER INSTALLATION KIT

**NEW**

- 1/2" MIP x 1/2" FIP, 1/2" OD epoxy-coated stainless steel gas connector
- Comes with a 1/2" MIP adapter and a 3/4" MIP adapter to accommodate various installations
- Includes leak detector solution and pipe thread sealant tape



**EASTMAN**

PART #	DESCRIPTION	UNIT ORDER	INN/MAS	PACK	LIST
041500	3' Kit	12	-/12	BAG	23.72
041502	4' Kit	12	-/12	BAG	27.57

### STAINLESS STEEL STEAM DRYER INSTALLATION KIT

- 1' Adapter hose
- Y connector
- 6' x 3/4" FHT x 3/4" FHT fill hose with 90° elbow



**EASTMAN**

PART #	DESCRIPTION	UNIT ORDER	INN/MAS	PACK	LIST
41025	Steam Dryer Kit	1	-/6	CLAM	32.36

Supply Connectors

Stop Valves

Water Heater

Gas Connectors

Water Filtration

Sinks/Faucets

Tubular/Drainage

Faucet Repair

Bath Accessories

Pipe Fittings/Repair

Valves

Cements/Sealants

Tools/Safety

Toilet Repair

Appliance/HVAC

Hardware

Electrical

Index

# APPLIANCE AND HVAC

## Dryer Installation

### RUBBER STEAM DRYER INSTALLATION KIT

- 1' Adapter hose
- Y connector
- 5' x 3/4" FHT x 3/4" FHT fill hose



**EASTMAN®**

PART #	DESCRIPTION	UNIT ORDER	INN/MAS	PACK	LIST
41024	Steam Dryer Kit	12	-/12	BAG	16.17

### STAINLESS STEEL STEAM DRYER ADAPTER HOSE - 3/4" FHT X 3/4" FHT

- Stainless steel braided
- Nickel-plated brass nuts



**EASTMAN®**

PART #	DESCRIPTION	UNIT ORDER	INN/MAS	PACK	LIST
41021	12"	1	10/100	BULK	6.10

### STAINLESS STEEL STEAM DRYER ADAPTER HOSE - 3/4" MHT X 3/4" FHT

- Stainless steel braided
- Nickel-plated brass nuts

**NEW**



**EASTMAN®**

PART #	DESCRIPTION	UNIT ORDER	INN/MAS	PACK	LIST
41131	12"	1	10/100	BULK	6.29

### CHROME Y ADAPTER FOR STEAM DRYER

- For steam dryer installations
- Heavy-duty, chrome-plated brass body



**EASTMAN®**

PART #	DESCRIPTION	UNIT ORDER	INN/MAS	PACK	LIST
41017	3/4" MHT x 3/4" MHT x 3/4" MHT	10	10/100	BULK	4.87
41006	3/4" FHT x 3/4" MHT x 3/4" MHT	10	10/100	BULK	5.16

### BRASS Y ADAPTER FOR STEAM DRYER

**NEW**

- For steam dryer installations
- Heavy-duty brass body



**EASTMAN®**

PART #	DESCRIPTION	UNIT ORDER	INN/MAS	PACK	LIST
41003	3/4" MHT x 3/4" MHT x 3/4" MHT	10	10/100	BULK	5.45
41005	3/4" FHT x 3/4" MHT x 3/4" MHT	10	10/100	BULK	5.03

### NYLON Y CONNECTOR FOR STEAM DRYER

- For steam dryer installation
- Heavy-duty nylon body



PART #	DESCRIPTION	UNIT ORDER	INN/MAS	PACK	LIST
41023	3/4" MHT x 3/4" MHT x 3/4" MHT	100	-/100	BOX	2.54

### ALUMINUM LINT TRAP

- Slips over end of drain hose to prevent lint from clogging tub or sink



**EASTMAN®**

PART #	DESCRIPTION	UNIT ORDER	INN/MAS	PACK	LIST
91221	10 Per Bag	1	-/100	BAG	9.55

### ANTI-VIBRATION PADS

- Reduces noise and vibrations washers and dryers make
- Works on any type of floor surface, reducing surface scratches
- Recessed area on top surface to keep washer steady



**EZ-FLO®**

PART #	DESCRIPTION	UNIT ORDER	INN/MAS	PACK	LIST
69001	4 Pack	1	-/12	BOX	15.34

## Range Installation

### EPOXY-COATED GAS RANGE INSTALLATION KIT

**NEW**

- 1/2" MIP x 1/2" MIP, 5/8" OD epoxy-coated stainless steel gas connector
- Comes with a 1/2" FIP adapter and a 3/4" MIP adapter to accommodate various installations
- Includes leak detector solution and pipe thread sealant tape



**EASTMAN**

PART #	DESCRIPTION	UNIT ORDER	INN/MAS	PACK	LIST
041600	3' Kit	12	-/12	BAG	26.69
041602	4' Kit	12	-/12	BAG	29.85

## Defrost Timers

### DEFROST TIMER

- Universal
- Energy-saving plastic construction
- 120 Volts



PART #	DESCRIPTION	UNIT ORDER	INN/MAS	PACK	LIST
*77554	Universal - Adjustable	12	-/24	BOX	16.74

\*While Supplies Last

### DEFROST TIMER

- Fits Admiral®
- Exact OEM features and specifications
- Metal construction
- Hardware kit included
- 120 Volts



PART #	DESCRIPTION	UNIT ORDER	INN/MAS	PACK	LIST
77552	6 Hr/21 Min	12	-/24	BOX	16.02

### DEFROST TIMER

- Fits GE®
- Exact OEM features and specifications
- Metal construction
- Hardware kit included
- 120 Volts



PART #	DESCRIPTION	UNIT ORDER	INN/MAS	PACK	LIST
77551	6 Hr/25 Min	12	-/12	BOX	18.79

### DEFROST TIMER

- Fits GE®
- Exact OEM features and specifications
- Metal construction
- Hardware kit included
- 120 Volts



PART #	DESCRIPTION	UNIT ORDER	INN/MAS	PACK	LIST
77550	8 Hr/21 Min	12	-/12	BOX	17.76

### FLYING LEAD DEFROST TIMER

- Energy-saving plastic construction
- Direct Whirlpool® replacement
- Hardware kit included
- 120 Volts



PART #	DESCRIPTION	UNIT ORDER	INN/MAS	PACK	LIST
77553	6 Hr/21 Min	12	-/12	BOX	14.64

## Range and Dryer Cords

### ELECTRIC RANGE CORD - 40 AMPS

- 3-Prong wire - rated 40 Amps - 125/250 Volts
- UL approved for electric ranges
- Two 8-gauge wires & one 10-gauge wire
- Closed-eyelet terminals



**EASTMAN**

PART #	DESCRIPTION	UNIT ORDER	INN/MAS	PACK	LIST
61256	4' - 3-Wire	12	-/12	BAG	11.35
61268	5' - 3-Wire	12	-/12	BAG	14.14
61269	6' - 3-Wire	12	-/12	BAG	16.68

Supply Connectors

Stop Valves

Water Heater

Gas Connectors

Water Filtration

Sinks/ Faucets

Tubular/ Drainage

Faucet Repair

Bath Accessories

Pipe Fittings/ Repair

Valves

Cements/ Sealants

Tools/ Safety

Toilet Repair

Appliance/ HVAC

Hardware

Electrical

Index

# APPLIANCE AND HVAC

## Range and Dryer Cords

### ELECTRIC RANGE CORD - 40 AMPS

- 4-Prong wire - rated 40 Amps - 125/250 Volts
- UL approved for electric ranges
- Two 8-gauge wires & two 10-gauge wires
- Closed-eyelet terminals



PART #	DESCRIPTION	UNIT ORDER	INN/MAS	PACK	LIST
61271	4' - 4-Wire	12	-/12	BAG	15.65
61272	5' - 4-Wire	12	-/12	BAG	19.05
61273	6' - 4-Wire	12	-/12	BAG	21.73

### ELECTRIC DRYER CORD - 30 AMPS

- 4-Prong wire - rated 30 Amps - 125/250 Volts
- UL approved for electric dryers
- Four 10-gauge wires
- Closed-eyelet terminals



PART #	DESCRIPTION	UNIT ORDER	INN/MAS	PACK	LIST
61253	4' - 4-Wire	12	-/12	BAG	13.29
61254	5' - 4-Wire	12	-/12	BAG	15.74
61255	6' - 4-Wire	12	-/12	BAG	17.88
61259	10' - 4-Wire	12	-/12	BAG	32.79

### ELECTRIC RANGE CORD - 50 AMPS

- 3-Prong wire - rated 50 Amps - 125/250 Volts
- UL approved for electric ranges
- Two 6-gauge wires & one 8-gauge wire
- Closed-eyelet terminals



PART #	DESCRIPTION	UNIT ORDER	INN/MAS	PACK	LIST
61241	4' - 3-Wire	12	-/12	BAG	16.88
61242	5' - 3-Wire	12	-/12	BAG	20.53
61243	6' - 3-Wire	12	-/12	BAG	23.47
61244	10' - 3-Wire	12	-/12	BAG	42.43

### APPLIANCE EXTENSION CORD

- 14-3 SPT 3-wire - rated 15 Amps at 120 Volts
- UL listed for refrigerators, microwaves and small room air conditioners
- 14-Gauge wire with ground



PART #	DESCRIPTION	UNIT ORDER	INN/MAS	PACK	LIST
60627	3'	1	-/50	CARD	6.99
60628	6'	1	-/50	CARD	8.98
60629	10'	1	-/50	CARD	12.23

### ELECTRIC RANGE CORD - 50 AMPS

- 4-Prong wire - rated 50 Amps - 125/250 Volts
- UL approved for electric ranges
- Two 6-gauge wires & two 8-gauge wires
- Closed-eyelet terminals



PART #	DESCRIPTION	UNIT ORDER	INN/MAS	PACK	LIST
61245	4' - 4-Wire	12	-/12	BAG	21.90
61246	5' - 4-Wire	12	-/12	BAG	25.55
61247	6' - 4-Wire	12	-/12	BAG	31.82
61248	10' - 4-Wire	12	-/12	BAG	49.38

### Receptacles

#### RANGE RECEPTACLE THREE-WIRE

- 50 Amp straight-blade non-grounding receptacle
- 50 Amp, 125/250 Volt
- NEMA 10-50R
- 3-Pole, 3-wire



PART #	DESCRIPTION	UNIT ORDER	INN/MAS	PACK	LIST
61260	Square Surface Mount 50 Amp	1	-/1	BAG	11.12

### ELECTRIC DRYER CORD - 30 AMPS

- 3-Prong wire - rated 30 Amps - 125/250 Volts
- UL approved for electric dryers
- Three 10-gauge wires
- Closed-eyelet terminals



PART #	DESCRIPTION	UNIT ORDER	INN/MAS	PACK	LIST
61249	4' - 3-Wire	12	-/12	BAG	9.49
61250	5' - 3-Wire	12	-/12	BAG	11.06
61251	6' - 3-Wire	12	-/12	BAG	12.89
61252	10' - 3-Wire	12	-/12	BAG	21.53

#### RANGE RECEPTACLE THREE-WIRE

- 50 Amp straight-blade non-grounding receptacle
- 50 Amp, 125/250 Volt
- NEMA 10-50R
- 3-Pole, 3-wire



PART #	DESCRIPTION	UNIT ORDER	INN/MAS	PACK	LIST
61261	Round Flush Wall Mount 50 Amp	1	-/1	BAG	8.30

## Receptacles

### RANGE RECEPTACLE FOUR-WIRE

- 50 Amp straight-blade grounding receptacle
- 50 Amp, 125/250 Volt
- NEMA 14-50R
- 3-Pole, 4-wire



PART #	DESCRIPTION	UNIT ORDER	INN/MAS	PACK	LIST
61262	Square Surface Mount 50 Amp	1	-/1	BAG	19.57

### DRYER RECEPTACLE FOUR-WIRE

- 30 Amp straight-blade grounding receptacle
- 30 Amp, 125/250 Volt
- NEMA 14-30R
- 3 Pole, 4-wire



PART #	DESCRIPTION	UNIT ORDER	INN/MAS	PACK	LIST
61267	Square Surface Mount 30 Amp	1	-/1	BAG	25.38

### RANGE RECEPTACLE FOUR-WIRE

- 50 Amp straight-blade grounding receptacle
- 50 Amp, 125/250 Volt
- NEMA 14-50R
- 3-Pole, 4-wire



PART #	DESCRIPTION	UNIT ORDER	INN/MAS	PACK	LIST
61263	Round Flush Wall Mount 50 Amp	1	-/1	BAG	22.38

## Range and Oven Parts

### PLUG-IN SURFACE ELEMENT

- Fits GE® style plug-in elements



PART #	DESCRIPTION	UNIT ORDER	INN/MAS	PACK	LIST
61706	6" - OEM #WB30M1 - 5-Turn	1	-/6	BAG	41.86
61707	8" - OEM #WB30M2 - 6-Turn	1	-/6	BAG	56.85

### DRYER RECEPTACLE THREE-WIRE

- 30 Amp straight-blade non-grounding receptacle
- 30 Amp, 125/250 Volt
- NEMA 10-30R
- 3-Pole, 3-wire



PART #	DESCRIPTION	UNIT ORDER	INN/MAS	PACK	LIST
61265	Square Surface Mount 30 Amp	1	-/1	BAG	10.26

### PLUG-IN SURFACE ELEMENT

- Fits GE® style plug-in elements



PART #	DESCRIPTION	UNIT ORDER	INN/MAS	PACK	LIST
61714	6" - OEM #WB30X218 - 5-Turn	1	-/6	BAG	33.30
61715	8" - OEM #WB30X219 - 6-Turn	1	-/6	BAG	47.73

### DRYER RECEPTACLE THREE-WIRE

- 30 Amp straight-blade non-grounding receptacle
- 30 Amp, 125/250 Volt
- NEMA 10-30R
- 3 Pole, 3-wire



PART #	DESCRIPTION	UNIT ORDER	INN/MAS	PACK	LIST
61266	Round Flush Wall Mount 30 Amp	1	-/1	BAG	6.61

### PLUG-IN SURFACE ELEMENT

- Fits Whirlpool® and replaces most plug-in elements



PART #	DESCRIPTION	UNIT ORDER	INN/MAS	PACK	LIST
61716	6" - OEM #SP12YA - 3-Turn	1	-/6	BAG	14.11
61717	8" - OEM #SP21YA - 4-Turn	1	-/6	BAG	18.11

Supply Connectors

Stop Valves

Water Heater

Gas Connectors

Water Filtration

Sinks/ Faucets

Tubular/ Drainage

Faucet Repair

Bath Accessories

Pipe Fittings/ Repair

Valves

Cements/ Sealants

Tools/ Safety

Toilet Repair

Appliance/ HVAC

Hardware

Electrical

Index

# APPLIANCE AND HVAC

## Range and Oven Parts

### ECONOMY PLUG-IN SURFACE ELEMENT

- Replaces most plug-in elements



PART #	DESCRIPTION	UNIT ORDER	INN/MAS	PACK	LIST
61730	6" - OEM #MP15YA - 4-Turn	1	-/6	BAG	19.93
61731	8" - OEM #MP26YA - 5-Turn	1	-/6	BAG	27.40

### DELUXE PLUG-IN SURFACE ELEMENT

- Replaces most plug-in elements



PART #	DESCRIPTION	UNIT ORDER	INN/MAS	PACK	LIST
61732	6" - OEM #MP15MA - 4-Turn	1	-/6	BAG	21.01
61733	8" - OEM #MP26MA - 5-Turn	1	-/6	BAG	28.91

### WIRE-IN SURFACE ELEMENT

- Fits GE® style wire-in elements
- 3-Wire



PART #	DESCRIPTION	UNIT ORDER	INN/MAS	PACK	LIST
61708	6" - OEM #WB30X342 - 5-Turn	1	-/6	BAG	50.18
61709	8" - OEM #WB30X341 - 6-Turn	1	-/6	BAG	65.89

### WIRE-IN SURFACE ELEMENT

- Fits GE® style wire-in elements
- 2-Wire with block



PART #	DESCRIPTION	UNIT ORDER	INN/MAS	PACK	LIST
61712	6" - OEM #WB30X359 - 5-Turn	1	-/6	BAG	45.96
61713	8" - OEM #WB30X348 - 6-Turn	1	-/6	BAG	53.03

### RANGE REFLECTOR PAN

- Fits hinged-type GE® or Hotpoint® ranges
- Chrome finish



PART #	DESCRIPTION	UNIT ORDER	INN/MAS	PACK	LIST
60722	6"	6	-/12	BAG	2.17
60723	8"	6	-/12	BAG	3.39

### CHROME TRIM RING

- Fits GE®/Hotpoint®
- Use with pan 60722 (6") and 60723 (8")
- Chrome finish



PART #	DESCRIPTION	UNIT ORDER	INN/MAS	PACK	LIST
60725	6"	6	-/12	BAG	2.28
60726	8"	6	-/12	BAG	3.08

### CHROME DEEP REFLECTOR BOWL

- Fits GE®/Hotpoint®
- For use with removable element
- 1-3/4" ID bottom hole - 1-3/4" deep
- Chrome finish



PART #	DESCRIPTION	UNIT ORDER	INN/MAS	PACK	LIST
60727	6" (Actual OD 7-9/16")	6	-/12	BAG	3.39
60728	8" (Actual OD 9-5/8")	6	-/12	BAG	5.42

### RANGE REFLECTOR BOWL

- Fits Whirlpool®
- For use with removable elements
- 2" ID bottom hole - 1-3/4" deep
- Chrome finish



PART #	DESCRIPTION	UNIT ORDER	INN/MAS	PACK	LIST
60746	6" (Actual OD 7-9/16")	6	-/12	BAG	3.36
60747	8" (Actual OD 9-5/8")	6	-/12	BAG	4.90

### CHROME REFLECTOR BOWL AND RING

- Fits new-style GE® and Hotpoint®
- Range pan and ring combination
- Single-element notch
- Replaces GE® #WB32X5075 and #WB32X5076 pans



PART #	DESCRIPTION	UNIT ORDER	INN/MAS	PACK	LIST
60761	6"	6	-/12	BAG	5.87
60762	8"	6	-/12	BAG	8.41

### CHROME REFLECTOR BOWL AND RING

- Fits GE® and Hotpoint®
- Range pan and ring combination
- Three-element notches
- Replaces GE® #WB32X5024 and #WB32X5025 pans



PART #	DESCRIPTION	UNIT ORDER	INN/MAS	PACK	LIST
60763	6"	6	-/12	BAG	5.99
60764	8"	6	-/12	BAG	8.21

## Range and Oven Parts

### REFLECTOR BOWL AND RING

- Fits GE®/Hotpoint®
- Range pan and ring combination
- Black finish
- Single-element notch



PART #	DESCRIPTION	UNIT ORDER	INN/MAS	PACK	LIST
60729	6"	6	-/12	BAG	<b>10.49</b>
60730	8"	6	-/12	BAG	<b>10.98</b>

### REFLECTOR BOWL AND RING

- Fits Whirlpool®
- Range pan and ring combination
- Black finish
- Single-element notch



PART #	DESCRIPTION	UNIT ORDER	INN/MAS	PACK	LIST
60719	6"	6	-/12	BAG	<b>8.13</b>
60720	8"	6	-/12	BAG	<b>10.86</b>

### UNIVERSAL RANGE REFLECTOR PAN

- Fits most hinged-type elements for electric ranges except GE®/Hotpoint®
- Chrome finish



PART #	DESCRIPTION	UNIT ORDER	INN/MAS	PACK	LIST
60748	6"	6	-/12	BAG	<b>2.31</b>
60749	8"	6	-/12	BAG	<b>3.19</b>

### UNIVERSAL TRIM RING

- Use with pan #60748 (6") or #60749 (8")
- Chrome finish



PART #	DESCRIPTION	UNIT ORDER	INN/MAS	PACK	LIST
60750	6"	6	-/12	BAG	<b>2.45</b>
60751	8"	6	-/12	BAG	<b>3.28</b>

### UNIVERSAL RANGE REFLECTOR BOWL

- For use with removable elements
- Fits most electric ranges
- Chrome finish



PART #	DESCRIPTION	UNIT ORDER	INN/MAS	PACK	LIST
60752	6"	6	-/12	BAG	<b>3.19</b>
60753	8"	6	-/12	BAG	<b>4.76</b>

### BROILER PAN

- Porcelain and chrome-plated steel



PART #	DESCRIPTION	UNIT ORDER	INN/MAS	PACK	LIST
60759	16-1/2" x 13"	1	-/10	BULK	<b>42.83</b>

### ALUMINUM PAN

- Aluminum base and cover



PART #	DESCRIPTION	UNIT ORDER	INN/MAS	PACK	LIST
*60760	14-1/2" x 9-1/2"	1	-/10	BULK	<b>26.86</b>

*\*While Supplies Last*

### OVEN THERMOMETER

- Temperature range of 100° F to 600° F
- Stands or hangs
- Works with all oven brands



PART #	DESCRIPTION	UNIT ORDER	INN/MAS	PACK	LIST
77507	Chrome-Plated Steel Thermometer	1	-/48	BLISTER	<b>5.53</b>

### ELECTRIC RANGE KNOB SET

- Set includes: 4 plastic knobs, 8 aluminum overlays, 4 sets of adapters (5 per set), bagged with instructions
- Universal-fit fits all brands

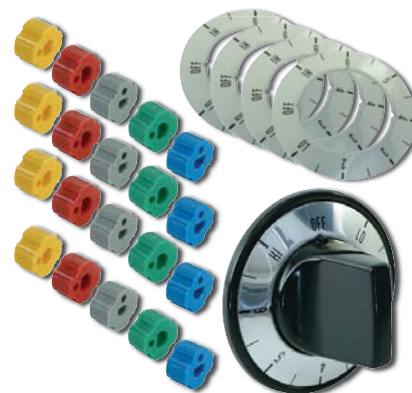

PART #	DESCRIPTION	UNIT ORDER	INN/MAS	PACK	LIST
61201	Black Knob	10	-/150	BAG	<b>14.60</b>

Supply Connectors

Stop Valves

Water Heater

Gas Connectors

Water Filtration

Sinks/Faucets

Tubular/Drainage

Faucet Repair

Bath Accessories

Pipe Fittings/Repair

Valves

Cements/Sealants

Tools/Safety

Toilet Repair

Appliance/HVAC

Hardware

Electrical

Index

# APPLIANCE AND HVAC

## Range and Oven Filters

### ALUMINUM FILTER WITH LENS

- Sold in case quantity only



PART #	DESCRIPTION	UNIT ORDER	INN/MAS	PACK	LIST
60678	Fits Broan® 9" x 12" x 5/16" - Lens Size 4" x 9"	10	-/10	BULK	13.54
60694	Fits Nutone® 10-13/16" x 11-13/16" x 1/2" - Lens Size 3-1/2" x 10"	10	-/10	BULK	14.57
60696	Fits Whirlpool® 11-7/16" x 11-13/16" x 3/8" - Lens Size 2-3/4" x 10-7/8"	10	-/10	BULK	20.41
60686	11" x 17" x 1/2" - Lens Size 6-3/4" x 11"	10	-/10	BULK	11.02

### ALUMINUM FILTER

- Sold in case quantity only
- Basket design
- Fits Broan®, Caloric®, Nautilus®, Roper®, Sears®



PART #	DESCRIPTION	UNIT ORDER	INN/MAS	PACK	LIST
60672	8-3/4" x 10-1/2" x 3-3/32"	10	-/10	BULK	8.21

### ALUMINUM FILTER

- Sold in case quantity only



PART#	DESCRIPTION	UNIT ORDER	INN/MAS	PACK	LIST
60667	Fits Nutone®, Caloric®, GE®, Whirlpool® 7-1/4" x 9-1/2" x 3/32"	10	-/10	BULK	8.98
60674	Fits Nutone®, Mercury® 8-15/16" x 8-15/16" x 3/8"	10	-/10	BULK	8.98
60675	Fits Nutone®, Mercury® 8" x 9-1/2" x 3/8"	10	-/10	BULK	8.98
60668	Fits Nutone® 8" x 11" x 3/8"	10	-/10	BULK	8.98
60671	Fits Whirlpool® 8-1/4" x 11-1/4" x 3/8"	10	-/10	BULK	9.92

### ALUMINUM FILTER

- Sold in case quantity only



PART#	DESCRIPTION	UNIT ORDER	INN/MAS	PACK	LIST
60676	Fits Broan® 8-3/4" x 10-1/2" x 3/8"	10	-/10	BULK	8.98
60680	Fits Whirlpool®, Miami-Carey® Broan®, Nutone®, GE® 8-7/16" x 11-1/4" x 3/8"	10	-/10	BULK	8.38
60679	Fits Broan® 9-1/2" x 1-3/4" x 3/8"	10	-/10	BULK	9.92
60660	Fits Broan®, Miami-Carey® 10" x 11" x 1/8"	10	-/10	BULK	7.33
60684	Fits GE®, Hotpoint® 10-7/16" x 11-7/16" x 3/8"	10	-/10	BULK	10.81

### DOME-SHAPED ALUMINUM FILTER

- Sold in case quantity only
- Fits Broan®, GE®, Nautilus®



PART #	DESCRIPTION	UNIT ORDER	INN/MAS	PACK	LIST
60683	10-1/2" Round x 3/32" x 3-3/4"	10	-/10	BULK	10.49

### ROUND-SHAPED ALUMINUM FILTER

- Sold in case quantity only
- Fits Broan®, Aubrey® Miami-Carey®



PART #	DESCRIPTION	UNIT ORDER	INN/MAS	PACK	LIST
60688	9-1/2" Round x 3/32" with Grommet	10	-/10	BULK	7.93

### ACTIVATED CARBON ALUMINUM FILTER

- Sold in case quantity only
- Fits Aire-Care®, Aubrey®, Pennys®, Rangemaster®



PART #	DESCRIPTION	UNIT ORDER	INN/MAS	PACK	LIST
60669	8" x 9-1/2" x 3/32"	10	-/10	BULK	8.98

### ACTIVATED CARBON FILTER

- Sold in case quantity only

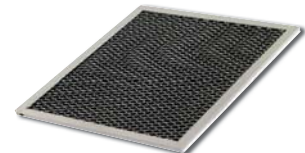

PART #	DESCRIPTION	UNIT ORDER	INN/MAS	PACK	LIST
60670	Fits Aire-Care®, Aubrey® Chefaire®, Pennys®, Rangemaster® 8" x 9-1/2" x 3/8"	10	-/10	BULK	12.15
60673	Fits Broan® 8-3/4" x 10-1/2" x 3/8"	10	-/10	BULK	12.15
60682	Fits Broan®, GE® 10-7/16" x 11-7/16" x 3/8"	10	-/10	BULK	12.83

### POLYSORB CARBON FILTER

- Sold in case quantity only
- Fits Broan®



PART #	DESCRIPTION	UNIT ORDER	INN/MAS	PACK	LIST
60691	8-15/16" x 8-15/16" x 3/8"	10	-/10	BULK	12.15
60677	8-1/4" x 11-1/4" x 3/8"	10	-/10	BULK	11.26



## Range and Oven Filters

### APPLIANCE BRUSH SET

- Universal brush is great for almost all appliance brands and models
- Great for refrigerator and air conditioner coils
- Clean dryer and vent filters
- Comfortable flex handle ideal for cleaning hard-to-reach areas
- Includes: 1 - 30" long narrow brush and 1 - 36" long wide brush



PART #	DESCRIPTION	UNIT ORDER	INN/MAS	PACK	LIST
60765	Appliance Brush Set	1	-/12	CARD	8.24

## Dryer Vents and Accessories

### TELESCOPE ALUMINUM DRYER VENT DUCT

- 4" Pipe
- Adjustable height
- For tight-fit installations



PART #	DESCRIPTION	UNIT ORDER	INN/MAS	PACK	LIST
60648	Extends from 18" to 30"	1	-/1	BOX	28.28
60649	Extends from 24" to 41"	1	-/1	BOX	32.48

### ARMORFLEX™ SUPER DRYER DUCT

**NEW**

- The flexibility of foil with the strength of semi-rigid
- Easy to install with no elbows needed
- Saves energy by maintaining efficient airflow
- Tear- and puncture-resistant
- Crush- and flame-resistant
- Easy to work with and trim



69030



69032



PART #	DESCRIPTION	UNIT ORDER	INN/MAS	PACK	LIST
69032	4" x 2' with Collars	18	-/18	BAG	7.53
69030	4" x 5' with Clamps	18	-/18	BAG	13.14
69028	4" x 8' with Clamps	18	-/18	BAG	16.11

### SEMI-RIGID ALUMINUM DRYER DUCT

- Dryer duct
- Crimped on one end
- 2ft. length



PART #	DESCRIPTION	UNIT ORDER	INN/MAS	PACK	LIST
60625	4" x 2'	12	-/1	BULK	6.24

### SEMI-RIGID ALUMINUM DRYER DUCT

- Flexible aluminum
- Plain-ended pipe
- Non-insulated general-purpose venting duct for low and medium operating pressures



PART #	DESCRIPTION	UNIT ORDER	INN/MAS	PACK	LIST
60619	4" x 5'	15	-/1	BULK	6.56
60633	4" x 8'	10	10/100	BULK	9.38

### SEMI-RIGID ALUMINUM DRYER DUCT

- 2 Clamps included
- Polybagged



PART #	DESCRIPTION	UNIT ORDER	INN/MAS	PACK	LIST
60581	4" x 8' - OEM# 3120UL	1	-/12	BAG	16.72

### SEMI-RIGID ALUMINUM DRYER DUCT

- 2 Clamps included
- Polybagged



PART #	DESCRIPTION	UNIT ORDER	INN/MAS	PACK	LIST
60580	4" x 8' - OEM# 3120L	1	-/12	BAG	10.76

### SEMI-RIGID DRYER DUCT

- Snap-Lock™ fitting on each end
- One collar crimped (male), one collar slotted (female)
- Maximum velocity: 5,000 FPM
- Operating temperature range: -100° F to 430° F



PART #	DESCRIPTION	UNIT ORDER	INN/MAS	PACK	LIST
60634	4" x 8'	1	-/20	BULK	17.05

### SEMI-RIGID DRYER DUCT

- Soft cuff ends are ready to clamp to other components
- Maximum velocity: 5,000 FPM
- Operating temperature range: -100° F to 430° F



PART #	DESCRIPTION	UNIT ORDER	INN/MAS	PACK	LIST
60635	4" x 8'	1	-/12	BULK	19.02

Supply Connectors

Stop Valves

Water Heater

Gas Connectors

Water Filtration

Sinks/Faucets

Tubular/Drainage

Faucet Repair

Bath Accessories

Pipe Fittings/Repair

Valves

Cements/Sealants

Tools/Safety

Toilet Repair

Appliance/HVAC

Hardware

Electrical

Index

# APPLIANCE AND HVAC

## Dryer Vents and Accessories

### FLEXIBLE ALUMINUM LAMINATED DUCT

- Individually boxed or bagged



PART #	DESCRIPTION	UNIT ORDER	INN/MAS	PACK	LIST
60618	4" x 5' with 2 Tension Clamps	1	-/12	BAG	8.81
60616	4" x 8' with 2 Tension Clamps	1	-/12	BAG	12.03
60612	4" x 25'	1	-/1	BOX	30.17

### LAMINATED DUCT

- LamaFlex connector
- 5-Layer foil laminate



PART #	DESCRIPTION	UNIT ORDER	INN/MAS	PACK	LIST
60583	4" x 20' - OEM# 620	1	-/12	BAG	26.29

### LAMINATED DUCT

- LamaFlex connector
- 3-Layer foil laminate



PART #	DESCRIPTION	UNIT ORDER	INN/MAS	PACK	LIST
60584	6" x 25' - OEM# 616UL	1	-/1	BAG	44.65

### LAMINATE DRYER TRANSITION DUCT

- Polybagged



PART #	DESCRIPTION	UNIT ORDER	INN/MAS	PACK	LIST
60582	4" x 8' - OEM# 498PL	24	-/24	BAG	12.94

### DRYER DUCT KIT

- One-piece flexible pipe, one crimped (male) fitting
- Kit includes 1 close elbow and 2 metal clamps
- Maximum velocity: 5,000 FPM
- Operating temperature range: -100° F to +430° F



PART #	DESCRIPTION	UNIT ORDER	INN/MAS	PACK	LIST
60630	4" x 8'	12	-/12	BOX	31.02

### TRANSITION DUCT KIT

- 4" White louvered hood
- 4" x 8' UL transition duct
- 2 Clamps included



PART #	DESCRIPTION	UNIT ORDER	INN/MAS	PACK	LIST
60593	4" x 8' - OEM #1371W	12	-/12	BOX	17.36

### TRANSITION DUCT KIT

- 4" White preferred hood
- Removable screen for cleaning
- 4" x 8' UL transition duct
- 2 Clamps



PART #	DESCRIPTION	UNIT ORDER	INN/MAS	PACK	LIST
60592	4" x 8' - OEM #1367W	10	-/10	BOX	17.36

### INDOOR DRYER VENT KIT

- Flexible 2-ply ducting
- Includes: 4" lint trap bucket, 4" x 5' flexible ducting, 2 tension clamps



PART #	DESCRIPTION	UNIT ORDER	INN/MAS	PACK	LIST
60640	Dryer Vent Kit	1	-/12	BAG	16.28

## Dryer Vents and Accessories

### ALUMINUM ROUND TO OVAL DRYER DUCT ADAPTER

**NEW**

- One female end, one male end



PART #	DESCRIPTION	UNIT ORDER	INN/MAS	PACK	LIST
60516	4" Round to Oval Adapter	1	-/16	BULK	5.52

### ALUMINUM DRYER DUCT INCREASER

- Connects ducts of different diameters
- Increases duct from 3" to 4"



PART #	DESCRIPTION	UNIT ORDER	INN/MAS	PACK	LIST
60645	3" to 4" Increaser	1	-/12	BULK	3.16

### ALUMINUM DRYER DUCT DECREASER

- Connects ducts of different diameters
- Decreases duct from 4" to 3"



PART #	DESCRIPTION	UNIT ORDER	INN/MAS	PACK	LIST
60653	4" to 3" Decreaser	1	-/12	BULK	3.16

### 4" ALUMINUM ADJUSTABLE ELBOW

- Fully adjustable to 90°
- One end crimped



PART #	DESCRIPTION	UNIT ORDER	INN/MAS	PACK	LIST
60643	4" Dryer Vent Elbow	1	-/12	BULK	3.34

### ALUMINUM DRYER DUCT CLOSE ELBOW

- Turns 90° within 4"
- One male rotating snap-lock fitting and one female rotating snap-lock fitting



PART #	DESCRIPTION	UNIT ORDER	INN/MAS	PACK	LIST
60631	4" Close Elbow	1	-/24	BULK	7.41

### PLASTIC DRYER DUCT SQUEEZE ELBOW

**NEW**

- Impact-resistant polymer resin
- Designed for use in 2x4 stud walls
- Easy installation
- Will not rust or dent



PART #	DESCRIPTION	UNIT ORDER	INN/MAS	PACK	LIST
60518	4" Plastic Squeeze Elbow	1	-/9	BULK	6.48

### PLASTIC ROOF CAPS

- Black
- Includes damper
- Includes screen



PART #	DESCRIPTION	UNIT ORDER	INN/MAS	PACK	LIST
60578	3" & 4" - OEM# 354R	1	-/1	BOX	29.17
60579	7" - OEM# 357	1	-/1	BOX	44.68

### WALL CAP - PLASTIC

- Grey
- Damper spring controlled



PART #	DESCRIPTION	UNIT ORDER	INN/MAS	PACK	LIST
60575	3-1/4" x 10" - OEM #117GR	1	-/1	BOX	18.79

### CEILING DIFFUSER

- Polybagged
- White



PART #	DESCRIPTION	UNIT ORDER	INN/MAS	PACK	LIST
60599	4" - OEM #664	3	-/3	BAG	20.76
60600	6" - OEM #666	3	-/3	BAG	20.76

Supply Connectors

Stop Valves

Water Heater

Gas Connectors

Water Filtration

Sinks/ Faucets

Tubular/ Drainage

Faucet Repair

Bath Accessories

Pipe Fittings/ Repair

Valves

Cements/ Sealants

Tools/ Safety

Toilet Repair

Appliance/ HVAC

Hardware

Electrical

Index

# APPLIANCE AND HVAC

## Dryer Vents and Accessories

### UNIVERSAL EXTENSION KIT

- 4" Connector
- Includes 2 clamps
- Polybagged
- Aluminum construction



PART #	DESCRIPTION	UNIT ORDER	INN/MAS	PACK	LIST
60597	4" - OEM #320L	12	-/12	BAG	1.76

### DRYER HOSE CLAMP

- Use with 4" ducting



PART #	DESCRIPTION	UNIT ORDER	INN/MAS	PACK	LIST
60608	4" Hose Clamp - 2 Pack	10	10/100	BAG	2.14

### METAL SPRING TENSION CLAMP

- Use with 4" ducting
- Sold & priced per bag



PART #	DESCRIPTION	UNIT ORDER	INN/MAS	PACK	LIST
60642	4" Tension Clamp - 10 Pack	1	10/50	BAG	5.50
60702	4" Tension Clamp - 2 Pack - <b>NEW!</b>	1	-/50	BAG	1.40

### PLASTIC LOUVERED HOOD

- Tailpiece included
- White



PART #	DESCRIPTION	UNIT ORDER	INN/MAS	PACK	LIST
60590	4" - OEM #26BW	12	-/12	BOX	8.10

### PLASTIC LOUVERED VENT

- White
- Includes tailpiece
- Easy to install
- Conserves energy



PART #	DESCRIPTION	UNIT ORDER	INN/MAS	PACK	LIST
60586	6" - OEM# 361WTP	12	-/12	BAG	21.58

### LOUVERED VENT

- White
- Plastic
- Includes plastic screen
- Includes tailpiece



PART #	DESCRIPTION	UNIT ORDER	INN/MAS	PACK	LIST
60587	6" - OEM# 606WP	6	-/6	BAG	21.98

### LOUVER REPLACEMENT

- Plastic louvered vent hood



PART #	DESCRIPTION	UNIT ORDER	INN/MAS	PACK	LIST
60603	White	1	-/12	BULK	2.28
60605	Brown	1	-/12	BULK	3.54

### WIDEMOUTHED ALUMINUM DRYER VENT HOOD

- 4" Widemouthed vent for better airflow
- Fully assembled
- 11.5" riveted tailpiece
- Back-draft flapper
- Back plate



PART #	DESCRIPTION	UNIT ORDER	INN/MAS	PACK	LIST
60602	4"	1	-/12	BULK	5.27

### WIDEMOUTHED GALVANIZED DRYER VENT HOOD

- 4" Widemouthed vent for better airflow
- Ready-to-paint
- 30-gauge galvanized
- Back-draft flapper
- Galvanized trim plate



PART #	DESCRIPTION	UNIT ORDER	INN/MAS	PACK	LIST
60607	4"	1	-/12	BULK	8.33

### VENT HOOD GUARD

- Keeps birds & rodents out of vent hoods
- Plastic



PART #	DESCRIPTION	UNIT ORDER	INN/MAS	PACK	LIST
60646	White	1	-/12	BULK	6.76

## Dryer Vents and Accessories

### VENT HOOD

- 4" Aluminum ducting
- White plastic



PART #	DESCRIPTION	UNIT ORDER	INN/MAS	PACK	LIST
60601	4"	12	-/12	BOX	6.59

### PLASTIC LOW-PROFILE HOOD

- White
- Low-profile heavy-duty applications
- 4" Standard tailpiece
- Removable screen for cleaning
- Paintable



PART #	DESCRIPTION	UNIT ORDER	INN/MAS	PACK	LIST
60591	4" - OEM #1472W	4	-/4	BAG	16.48

### REPLACEMENT HOOD

- 4" Hood with removable screen for cleaning
- Polybagged
- Tailpiece included
- White



PART #	DESCRIPTION	UNIT ORDER	INN/MAS	PACK	LIST
60589	4" - OEM #209W	12	-/12	BAG	8.21

### DRYER OUTLET BOX WITH ADAPTER

**NEW**

- Includes round-to-oval adapter
- Fits all 16" centers, 2x4's and 2x6's
- Six pre-scored, true 4" diameter knock-outs in most common positions
- Six starburst knock-outs for gas connections and venting
- Plastic meets UL Standard 94 HB tests for flammability



PART #	DESCRIPTION	UNIT ORDER	INN/MAS	PACK	LIST
60510	Self-Trimming Unit - 18" Wide x 24" High	1	-/3	BOX	30.79

### DRYER VENT BOX

- Sturdy 22-gauge molded aluminized steel
- Locates dryer against wall
- Reduces fire hazard
- Flex is protected from getting squashed
- Minimizes lint buildup



PART #	DESCRIPTION	UNIT ORDER	INN/MAS	PACK	LIST
60551	Aluminized Steel	1	-/5	BOX	74.65

### DRAFT BLOCKER

- 2 Plastic clamps
- Prevents outside air from entering through the dryer
- Easy to install
- Polybagged



PART #	DESCRIPTION	UNIT ORDER	INN/MAS	PACK	LIST
60594	4" - OEM #1775P	1	-/6	BAG	7.36

### QUICK-FIT ELBOW

- Plastic
- 90° Elbow with rubber gasket
- Includes 1 clamp
- Individually boxed



PART #	DESCRIPTION	UNIT ORDER	INN/MAS	PACK	LIST
60596	4" - OEM# 3003L	6	-/6	BOX	12.32

## Registers

### FLOOR DIFFUSER

- Steel floor diffuser
- Adjustable damper
- All-steel construction
- Powder-coated finish
- Includes screws



PART #	OPENING/OVERALL	UNIT ORDER	INN/MAS	PACK	LIST
61601	Br. - 4" x 8" / 5-1/2" x 9-1/2"	1	-/20	BULK	6.39
61602	Br. - 4" x 10" / 5-1/2" x 11-1/2"	1	-/20	BULK	4.85
61603	Wh. - 4" x 10" / 5-1/2" x 11-1/2"	1	-/20	BULK	5.05
61604	Br. - 4" x 12" / 5-1/2" x 13-1/2"	1	-/20	BULK	6.33
61605	Wh. - 4" x 12" / 5-1/2" x 13-1/2"	1	-/20	BULK	6.33
*61606	Wh. - 4" x 14" / 5-1/2" x 15-1/2"	1	-/20	BULK	9.38
61637	Wh. - 6" x 10" / 7-1/2" x 11-1/2"	1	-/20	BULK	6.16
61638	Wh. - 6" x 12" / 7-1/2" x 13-1/2"	1	-/20	BULK	7.19

\*While Supplies Last

Supply Connectors

Stop Valves

Water Heater

Gas Connectors

Water Filtration

Sinks/Faucets

Tubular/Drainage

Faucet Repair

Bath Accessories

Pipe Fittings/Repair

Valves

Cements/Sealants

Tools/Safety

Toilet Repair

Appliance/HVAC

Hardware

Electrical

Index

# APPLIANCE AND HVAC

## Registers

### TWO-WAY SIDEWALL/CEILING REGISTER

- Sidewall or ceiling mount
- Two-way air deflection
- All-steel construction
- Powder-coated white finish
- Includes screws



PART #	OPENING/OVERALL	UNIT ORDER	INN/MAS	PACK	LIST
61660	6" x 6" / 7-3/4" x 7-3/4"	1	-/20	BULK	<b>4.59</b>
61608	8" x 4" / 9-3/4" x 5-3/4"	1	-/20	BULK	<b>4.28</b>
61661	8" x 6" / 9-3/4" x 6-3/4"	1	-/20	BULK	<b>5.65</b>
61609	10" x 4" / 11-3/4" x 5-3/4"	1	-/20	BULK	<b>5.05</b>
61610	10" x 6" / 11-3/4" x 7-3/4"	1	-/20	BULK	<b>6.50</b>
61611	12" x 4" / 13-3/4" x 5-3/4"	1	-/20	BULK	<b>5.90</b>
61612	12" x 6" / 13-3/4" x 7-3/4"	1	-/20	BULK	<b>7.01</b>
61613	14" x 6" / 15-3/4" x 7-3/4"	1	-/20	BULK	<b>9.12</b>
61662	14" x 8" / 15-3/4" x 9-3/4"	1	-/10	BULK	<b>11.35</b>
61663	16" x 6" / 17-3/4" x 7-3/4"	1	-/20	BULK	<b>10.49</b>

### THREE-WAY SIDEWALL/CEILING REGISTER

- Sidewall or ceiling mount
- Three-way air deflection
- All-steel construction
- Powder-coated white finish
- Includes screws



PART #	OPENING/OVERALL	UNIT ORDER	INN/MAS	PACK	LIST
61658	8" x 4" / 9-3/4" x 5-3/4"	1	-/20	BULK	<b>4.28</b>
61614	10" x 6" / 11-3/4" x 7-3/4"	1	-/20	BULK	<b>6.50</b>
61615	12" x 6" / 13-3/4" x 7-3/4"	1	-/20	BULK	<b>7.01</b>
61616	14" x 6" / 15-3/4" x 7-3/4"	1	-/20	BULK	<b>9.49</b>

### FOUR-WAY SIDEWALL/CEILING REGISTER

- Four-way air deflection
- All-steel construction
- Powder-coated white finish
- Includes screws



PART #	OPENING/OVERALL	UNIT ORDER	INN/MAS	PACK	LIST
61617	6" x 6" / 7-3/4" x 7-3/4"	1	-/20	BULK	<b>4.59</b>
61618	8" x 8" / 9-3/4" x 9-3/4"	1	-/20	BULK	<b>6.64</b>
61619	10" x 10" / 11-3/4" x 11-3/4"	1	-/10	BULK	<b>9.87</b>

### ROUND CEILING DIFFUSER

- Concentric rings deflect air 360°
- All-steel construction
- Powder-coated white finish
- Includes screws



PART #	DESCRIPTION	UNIT ORDER	INN/MAS	PACK	LIST
61623	6"	1	-/30	BULK	<b>8.44</b>
61624	8"	1	-/30	BULK	<b>10.12</b>

### RETURN FILTER GRILLE

- All-steel construction
- Powder-coated white finish
- Includes screws



PART #	OPENING/OVERALL	UNIT ORDER	INN/MAS	PACK	LIST
61657	10" x 10" / 12-11/16" x 12-11/16"	1	-/10	BULK	<b>16.08</b>
61672	10" x 30" / 11-3/4" x 31-3/4"	1	-/5	BULK	<b>38.35</b>
61668	12" x 24" / 14-11/16" x 26-11/16"	1	-/5	BULK	<b>30.34</b>
61653	14" x 14" / 16-11/16" x 16-11/16"	1	-/10	BULK	<b>22.64</b>
61670	14" x 20" / 16-11/16" x 22-11/16"	1	-/5	BULK	<b>23.24</b>
61654	16" x 16" / 18-11/16" x 18-11/16"	1	-/5	BULK	<b>27.12</b>
61631	16" x 20" / 18-11/16" x 22-11/16"	1	-/5	BULK	<b>36.72</b>
61671	16" x 25" / 18-11/16" x 27-11/16"	1	-/5	BULK	<b>37.66</b>
61656	18" x 18" / 20-11/16" x 20-11/16"	1	-/5	BULK	<b>26.15</b>
61632	20" x 20" / 22-11/16" x 22-11/16"	1	-/5	BULK	<b>35.81</b>
61633	20" x 25" / 22-11/16" x 27-11/16"	1	-/5	BULK	<b>42.37</b>
61634	25" x 20" / 27-11/16" x 22-11/16"	1	-/5	BULK	<b>42.37</b>

## Registers

### RETURN AIR GRILLE

- All-steel construction
- Powder-coated white finish
- Includes screws



PART #	OPENING/OVERALL	UNIT ORDER	INN/MAS	PACK	LIST
61625	10" x 6" / 11-3/4" x 7-3/4"	1	-20	BULK	3.54
61639	10" x 10" / 11-3/4" x 11-3/4"	1	-20	BULK	5.22
61626	12" x 6" / 13-3/4" x 7-3/4"	1	-20	BULK	3.96
61627	12" x 12" / 13-3/4" x 13-3/4"	1	-20	BULK	7.07
61628	14" x 6" / 15-3/4" x 7-3/4"	1	-20	BULK	4.70
61643	14" x 8" / 15-3/4" x 9-3/4"	1	-20	BULK	5.59
61640	14" x 14" / 15-3/4" x 15-3/4"	1	-20	BULK	9.12
61664	14" x 20" / 15-3/4" x 21-3/4"	1	-10	BULK	12.49
61641	16" x 16" / 17-3/4" x 17-3/4"	1	-10	BULK	11.49
61665	16" x 20" / 17-3/4" x 21-3/4"	1	-10	BULK	14.03
61667	16" x 25" / 17-3/4" x 26-3/4"	1	-10	BULK	17.19
61642	18" x 18" / 19-3/4" x 19-3/4"	1	-10	BULK	14.20
61644	20" x 12" / 21-3/4" x 13-3/4"	1	-10	BULK	10.98
61629	20" x 20" / 21-3/4" x 21-3/4"	1	-10	BULK	17.11
61649	20" x 25" / 21-3/4" x 26-3/4"	1	-5	BULK	20.96
61645	24" x 12" / 25-3/4" x 13-3/4"	1	-10	BULK	11.35
61646	24" x 14" / 25-3/4" x 15-3/4"	1	-10	BULK	13.06
61630	30" x 6" / 31-3/4" x 7-3/4"	1	-10	BULK	9.24
61647	30" x 10" / 31-3/4" x 11-3/4"	1	-10	BULK	13.66
61648	30" x 12" / 31-3/4" x 13-3/4"	1	-10	BULK	15.88
61650	30" x 14" / 31-3/4" x 15-3/4"	1	-5	BULK	18.11
61652	30" x 20" / 31-3/4" x 21-3/4"	1	-5	BULK	24.75

## Capacitors

### MOTOR RUN CAPACITOR

- Hermetically sealed
- Drawn steel case construction
- Quad-blade quick-connect terminals



### OVAL-370 VAC

PART #	MFD	VAC	UNIT ORDER	INN/MAS	PACK	LIST
92007	3	370	1	-100	BOX	3.08
92008	4	370	1	-100	BOX	2.79
92009	5	370	1	-100	BOX	2.71
92010	7.5	370	1	-100	BOX	3.71
92011	10	370	1	-100	BOX	4.22
92012	15	370	1	-100	BOX	5.99
92013	20	370	1	-100	BOX	6.81
92014	25	370	1	-100	BOX	7.93
92015	30	370	1	-100	BOX	9.10
92016	35	370	1	-100	BOX	9.58
92017	40	370	1	-100	BOX	11.86
92018	45	370	1	-100	BOX	13.26

### MOTOR RUN CAPACITOR

- Hermetically sealed
- Drawn steel case construction
- Quad-blade quick-connect terminals



### OVAL-440 VAC

PART #	MFD	VAC	UNIT ORDER	INN/MAS	PACK	LIST
92019	4	440	1	-100	BOX	3.56
92020	5	440	1	-100	BOX	3.56
92181	7.5	440 - NEW!	1	-100	BOX	4.11
92021	10	440	1	-100	BOX	4.42
92022	15	440	1	-100	BOX	6.13
92023	20	440	1	-100	BOX	6.42
92024	25	440	1	-100	BOX	11.09
92025	30	440	1	-100	BOX	9.27
92026	35	440	1	-100	BOX	10.15
*92027	40	440	1	-100	BOX	12.23
*92028	45	440	1	-100	BOX	13.26

\*While Supplies Last

### MOTOR RUN CAPACITOR

- Hermetically sealed
- Drawn steel case construction
- Quad-blade quick-connect terminals



### ROUND-370 VAC

PART #	MFD	VAC	UNIT ORDER	INN/MAS	PACK	LIST
92182	5	370 - NEW!	1	-100	BOX	3.14
92183	7.5	370 - NEW!	1	-100	BOX	3.93
92044	25	370	1	-50	BOX	8.13
92045	30	370	1	-50	BOX	8.21
92046	35	370	1	-50	BOX	10.49

### ROUND-440 VAC

PART #	MFD	VAC	UNIT ORDER	INN/MAS	PACK	LIST
92047	5	440	1	-50	BOX	3.99
92048	10	440	1	-50	BOX	4.56
92049	15	440	1	-50	BOX	6.13
92050	20	440	1	-50	BOX	7.84
92051	25	440	1	-50	BOX	8.13
92052	30	440	1	-50	BOX	9.84
92053	35	440	1	-50	BOX	10.64
92054	45	440	1	-50	BOX	8.41

Supply Connectors

Stop Valves

Water Heater

Gas Connectors

Water Filtration

Sinks/ Faucets

Tubular/ Drainage

Faucet Repair

Bath Accessories

Pipe Fittings/ Repair

Valves

Cements/ Sealants

Tools/ Safety

Toilet Repair

Appliance/ HVAC

Hardware

Electrical

Index

# APPLIANCE AND HVAC

## Capacitors

### MOTOR RUN CAPACITOR

- Hermetically sealed
- Drawn steel case construction
- Quad-blade quick-connect terminals



#### OVAL DUAL-370 VAC

PART #	MFD	VAC	UNIT ORDER	INN/MAS	PACK	LIST
*92029	15/10	370	1	-/50	BOX	<b>7.13</b>
92030	20/5	370	1	-/50	BOX	<b>8.13</b>
*92031	25/3	370	1	-/50	BOX	<b>8.27</b>
92032	25/5	370	1	-/50	BOX	<b>12.15</b>
*92033	25/10	370	1	-/50	BOX	<b>10.12</b>
92034	30/3	370	1	-/50	BOX	<b>9.98</b>
92035	30/5	370	1	-/50	BOX	<b>10.26</b>
92036	35/5	370	1	-/50	BOX	<b>11.06</b>
92037	40/5	370	1	-/50	BOX	<b>16.22</b>
92038	45/5	370	1	-/50	BOX	<b>16.99</b>

\*While Supplies Last

#### OVAL DUAL-440 VAC

PART #	MFD	VAC	UNIT ORDER	INN/MAS	PACK	LIST
92039	25/5	440	1	-/100	BOX	<b>10.98</b>
92040	30/5	440	1	-/100	BOX	<b>9.27</b>
92041	35/5	440	1	-/100	BOX	<b>12.12</b>
92042	40/5	440	1	-/100	BOX	<b>12.83</b>
92043	45/5	440	1	-/100	BOX	<b>14.97</b>
92184	50/5	440 - NEW!	1	-/100	BOX	<b>14.54</b>

### MOTOR RUN CAPACITOR

- Hermetically sealed
- Drawn steel case construction
- Quad-blade quick-connect terminals



#### ROUND DUAL-370 VAC

PART #	MFD	VAC	UNIT ORDER	INN/MAS	PACK	LIST
*92055	20/5	370	1	-/50	BOX	<b>7.47</b>
92056	25/3	370	1	-/50	BOX	<b>7.64</b>
92057	25/5	370	1	-/50	BOX	<b>7.41</b>
92058	30/3	370	1	-/50	BOX	<b>10.12</b>
92059	30/5	370	1	-/50	BOX	<b>9.64</b>
92060	35/5	370	1	-/50	BOX	<b>10.69</b>
92062	45/5	370	1	-/50	BOX	<b>19.82</b>
92185	55/5	370- NEW!	1	-/100	BOX	<b>13.97</b>
92186	60/5	370- NEW!	1	-/100	BOX	<b>14.83</b>
92187	80/5	370- NEW!	1	-/100	BOX	<b>19.10</b>

\*While Supplies Last

#### ROUND DUAL-440 VAC

PART #	MFD	VAC	UNIT ORDER	INN/MAS	PACK	LIST
92061	40/5	440	1	-/50	BOX	<b>13.83</b>
92063	45/5	440	1	-/50	BOX	<b>21.18</b>
92064	50/5	440	1	-/50	BOX	<b>16.48</b>
92065	55/5	440	1	-/50	BOX	<b>18.36</b>
92188	80/5	440- NEW!	1	-/100	BOX	<b>20.24</b>
92189	80/7.5	440- NEW!	1	-/100	BOX	<b>20.81</b>



## Contactors

### 2-POLE DEFINITE PURPOSE CONTACTOR

- Low VA coil for cooler operation and increased life
- Reduces A/C hum for quiet operation
- Universal mounting bracket



PART #	DESCRIPTION	UNIT ORDER	INN/MAS	PACK	LIST
92097	30 Amp 24 Volts	1	-/50	BOX	16.41
92098	30 Amp 120 Volts	1	-/50	BOX	14.54
92099	30 Amp 240 Volts	1	-/50	BOX	13.80
92103	40 Amp 24 Volts	1	-/50	BOX	22.84
92104	40 Amp 120 Volts	1	-/50	BOX	22.84
92105	40 Amp 240 Volts	1	-/50	BOX	22.84

### 2-POLE MAGNETIC CONTACTOR

- Low-wattage coil
- DPST
- Quick-connect auxiliary terminals
- 50/60 Hz



PART #	DESCRIPTION	UNIT ORDER	INN/MAS	PACK	LIST
92124	30 Amp 24 Volts	1	-/80	BOX	50.64

### 3-POLE DEFINITE PURPOSE CONTACTOR

- Any position mounting
- Interchangeable, mounting plate/multiple holes
- Low-wattage coil
- Quick-connect auxiliary terminals



PART #	DESCRIPTION	UNIT ORDER	INN/MAS	PACK	LIST
92100	30 Amp 24 Volts	1	-/25	BOX	29.48
92101	30 Amp 120 Volts	1	-/25	BOX	29.48
92102	30 Amp 240 Volts	1	-/25	BOX	29.48
92106	40 Amp 24 Volts	1	-/25	BOX	31.68
92107	40 Amp 120 Volts	1	-/25	BOX	31.68
92108	40 Amp 240 Volts	1	-/25	BOX	31.68

### 1-POLE CONTACTOR

- Low VA coil for cooler operation and increased life
- Reduces A/C hum for quiet operation
- Universal mounting bracket



PART #	DESCRIPTION	UNIT ORDER	INN/MAS	PACK	LIST
92096	30 Amp 24 Volts	1	-/50	BOX	11.83

## Hard Starts

### RELAY/CAPACITOR HARD START

- Positive-temperature-coefficient technology
- Increase starting torque
- Easy 2-wire installation
- 92089 - For appliance use



PART #	DESCRIPTION	UNIT ORDER	INN/MAS	PACK	LIST
*92089	250% SPP	1	-/50	BOX	10.12
92090	300% SPP5	1	-/100	BOX	14.54
92091	500% SPP6	1	-/50	BOX	23.84
92092	600% SPP7S	1	-/50	BOX	37.58

*\*While Supplies Last*

### HARD START KIT

- Electronic-potential-relay technology
- Backup electronic timing circuit to protect the compressor
- Voltage sensing
- Instant restart
- Easy 2-wire installation
- SPP8E



PART #	DESCRIPTION	UNIT ORDER	INN/MAS	PACK	LIST
92093	Relay and Hard Start Capacitor 1 to 5 HP	1	-/50	BOX	47.30

### 3-IN-1 HARD START KIT

- Replaces relay and overload and provides a boost for hard start and unbalanced systems
- Prevents low-voltage starting problems



PART #	DESCRIPTION	UNIT ORDER	INN/MAS	PACK	LIST
92094	Relay, Overload and Start Capacitor 1/4 and 1/3 HP	1	-/50	BOX	21.75
92095	Relay, Overload and Start Capacitor 1/12 to 1/5 HP	1	-/50	BOX	22.70

Supply Connectors

Stop Valves

Water Heater

Gas Connectors

Water Filtration

Sinks/Faucets

Tubular/Drainage

Faucet Repair

Bath Accessories

Pipe Fittings/Repair

Valves

Cements/Sealants

Tools/Safety

Toilet Repair

Appliance/HVAC

Hardware

Electrical

Index

# APPLIANCE AND HVAC

## Transformers

### UNIVERSAL TRANSFORMERS

- A versatile transformer that can be used for many different applications
- Accepts input voltage of 120, 208, and 240 VAC and provides a secondary voltage of 2.5, 8, 12, 16 or 24 VAC
- Enclosed frame - plate, foot or knock-out mount



PART #	DESCRIPTION	UNIT ORDER	INN/MAS	PACK	LIST
92113	Universal Multi-Tap	1	-/20	BOX	21.30

### 40 VA FOOT-MOUNT TRANSFORMERS

- Any position mounting
- Interchangeable, mounting plate/multiple holes
- Low-wattage coil
- Quick-connect auxiliary terminals



PART #	DESCRIPTION	UNIT ORDER	INN/MAS	PACK	LIST
92110	120/240 Volts	1	-/20	BOX	14.98
*92111	208/240 Volts Multi-Tap	1	-/20	BOX	21.04

\*While Supplies Last

## Relays

### GENERAL-PURPOSE FAN RELAY

- Used for switching single- or two-speed fan motors, solenoids and general-purpose switching
- 50/60 Hz coils



PART #	DESCRIPTION	UNIT ORDER	INN/MAS	PACK	LIST
92115	SPST 24 Volts	1	-/250	BOX	10.46
92119	SPDT 24 Volts	1	-/250	BOX	11.03
92120	SPNO/SPNC 24 Volts	1	-/250	BOX	11.03

### 2-POLE SWITCHING RELAY

- Semi-enclosed
- 2-Pole, double-throw
- Suited for fan controls, HVAC, heat pumps, appliances, vending machines and general-purpose switching



PART #	DESCRIPTION	UNIT ORDER	INN/MAS	PACK	LIST
92116	24 Volts	1	-/100	BOX	10.46
92117	115/120 Volts	1	-/100	BOX	10.81
92118	208/240 Volts	1	-/100	BOX	11.03

## UNIVERSAL POTENTIAL RELAY

- Wire-to-wire replacement for virtually all potential relays
- Recycles instantly
- Accommodates screw-on or push-on connections
- Universal mounting bracket
- Start winding protection if motor does not start



PART #	DESCRIPTION	UNIT ORDER	INN/MAS	PACK	LIST
92121	Universal	1	-/100	BOX	17.36

## UV Lights

### PREMIERONE™ 24-VOLT GERMICIDAL UV LIGHT SYSTEM

- 24-Volt electronic power supply connects to 24-Volt power at control panel
- 55-Microwatt 14" lamp
- Remote unit fits in tight spaces
- Easy mounting with heavy-duty magnetic Z-bracket that has an 80 lb pull force magnet that also converts to a duct mount plate
- LED system monitor indicates power on and a second LED monitors the lamp operation
- 3-Year warranty



PART #	DESCRIPTION	UNIT ORDER	INN/MAS	PACK	LIST
*91005	14" Lamp Length	1	-/2	BOX	220.32
*91011	Replacement Bulb	1	-/2	BOX	115.30

\*While Supplies Last

## Float Switches

### DRAIN PAN FLOAT SWITCH

- Protective housing keeps out insulation and debris
- The industry leading float switch for metal drain pans
- 5-Amp high-capacity sensor designed for metal pans
- Easy, no-drill installation
- Includes AG-1100+ magnetic float switch, 6' wire, 2 thumbscrews



PART #	DESCRIPTION	UNIT ORDER	INN/MAS	PACK	LIST
71000	Float Switch - OEM# AG-1100+	1	30/120	CLAM	22.47

## Float Switches

### IN-LINE WATER SENSOR FOR PRIMARY DRAIN

- Electronic in-line water sensor with insulated housing and access port
- Unobstructed 3/4" flow switch does not impede drainage
- Integrated easy-access port for cleaning out drain lines and adding chemicals



PART #	DESCRIPTION	UNIT ORDER	INN/MAS	PACK	LIST
71001	Water Sensor - OEM# AG-2550E	1	10/60	CLAM	52.03

### WATER SENSOR FOR AUXILIARY DRAIN

- Small electronic sensor
- Water detection LED and automatic reset ensure reliability
- Eliminates false shutoffs caused by trapped condensation
- 2-in-1 secondary drain and secondary pan sensor
- Includes AG-3150E electronic water sensor control box, 6' wire, probe wire 9" and secondary drain probe



PART #	DESCRIPTION	UNIT ORDER	INN/MAS	PACK	LIST
71002	Water Sensor - OEM# AG-3150E	1	10/120	CLAM	44.62

## Driers

### BI-FLOW LIQUID LINE FILTER DRIERS

- Sweat connections
- Possible flow and filtering in any direction due to internal check valve
- Effectively removes acids, moisture and solid contaminants



PART #	DESCRIPTION	UNIT ORDER	INN/MAS	PACK	LIST
92070	3/8" Sweat 8 Cubic Inch	1	-/25	BOX	27.88
92071	3/8" Sweat 16 Cubic Inch	1	-/25	BOX	41.31

## LIQUID LINE DRIERS

- Spun copper shells and ends for easy installation
- Corrosion-resistant paint



PART #	DESCRIPTION	UNIT ORDER	INN/MAS	PACK	LIST
*92072	1/4" Flare 3 Cubic Inch	1	-/28	BOX	13.26
92073	1/4" Sweat 3 Cubic Inch	1	-/28	BOX	13.26
92074	1/4" Flare 5 Cubic Inch	1	-/28	BOX	14.68
92075	1/4" Sweat 5 Cubic Inch	1	-/28	BOX	14.68
92077	1/4" Flare 8 Cubic Inch	1	-/28	BOX	16.39
92078	1/4" Sweat 8 Cubic Inch	1	-/28	BOX	18.11
92079	3/8" Flare 8 Cubic Inch	1	-/28	BOX	17.65
92080	3/8" Sweat 8 Cubic Inch	1	-/28	BOX	17.65
92081	3/8" Flare 16 Cubic Inch	1	-/15	BOX	19.62
92082	3/8" Sweat 16 Cubic Inch	1	-/15	BOX	19.62

\*While Supplies Last

## SUCTION LINE DRIERS

- Designed for system cleanup
- Two access valves simplify pressure-drop measurements
- Corrosion-resistant paint
- Sweat connection



PART #	DESCRIPTION	UNIT ORDER	INN/MAS	PACK	LIST
92083	5/8" Sweat 16 Cubic Inch	1	-/25	BOX	43.48
92084	3/4" Sweat 16 Cubic Inch	1	-/25	BOX	43.48
92087	7/8" Sweat 16 Cubic Inch	1	-/25	BOX	46.33
*92088	1-1/8" Sweat 16 Cubic Inch	1	-/25	BOX	87.42

\*While Supplies Last

## SPUN COPPER DRIER NONDIRECTIONAL

- Hermetically sealed
- Copper shells and end tubes
- Easy break-off grooved ends



PART #	DESCRIPTION	UNIT ORDER	INN/MAS	PACK	LIST
92066	1/4" OD Inlet - 1/4" OD Outlet	1	12/300	BOX	3.93

Supply Connectors

Stop Valves

Water Heater

Gas Connectors

Water Filtration

Sinks/ Faucets

Tubular/ Drainage

Faucet Repair

Bath Accessories

Pipe Fittings/ Repair

Valves

Cements/ Sealants

Tools/ Safety

Toilet Repair

Appliance/ HVAC

Hardware

Electrical

Index

# APPLIANCE AND HVAC

## Driers

### SPUN COPPER DRIER DOUBLE-INLET

- Hermetically sealed
- Copper shells and end tubes
- Easy break-off grooved ends



PART #	DESCRIPTION	UNIT ORDER	INN/MAS	PACK	LIST
*92068	Inlet Two 1/4" OD - Outlet 1/4" OD	1	-/24	BOX	10.35

\*While Supplies Last

### SPUN COPPER DRIER 1" CHARGING

- Hermetically sealed
- Copper shells and end tubes
- Easy break-off grooved ends



PART #	DESCRIPTION	UNIT ORDER	INN/MAS	PACK	LIST
92067	1/4" OD, 1/4" Flare Inlet - Outlet 1/4" OD or Cap	1	12/300	BOX	8.50

### SPUN COPPER DRIER 3/4" CHARGING

- Hermetically sealed
- Copper shells and end tubes
- Easy break-off grooved ends



PART #	DESCRIPTION	UNIT ORDER	INN/MAS	PACK	LIST
92069	Inlet 1/4" ID, 1/4" OD, 1/4" Flare - Outlet 1/4" OD or Cap	1	12/300	BOX	7.95

### SIGHT GLASS

- Solid brass body
- Compact and extremely accurate
- Installs between liquid line drier and refrigerant metering device



PART #	DESCRIPTION	UNIT ORDER	INN/MAS	PACK	LIST
92114	3/8" Sight Glass	1	-/100	BOX	13.83

## Line Sets

### PROFLEX® ELASTOMERIC FOAM TUBE

- Flexible for easy installation
- Closed-cell foam structure prevents moisture wicking and eliminates need for additional vapor retarder
- Fiber-free and non-particulating
- ASTM E 84 25/50 rated
- Long-lasting, retains thermal integrity over time
- 6' Length



PART #	DESCRIPTION	UNIT ORDER	INN/MAS	PACK	LIST
82310	5/8" ID x 1/2" Wall	50	-/50	BOX	5.53
82311	3/4" ID x 1/2" Wall	40	-/40	BOX	5.90
82312	7/8" ID x 1/2" Wall	35	-/35	BOX	6.61
82313	1-1/8" ID x 1/2" Wall	25	-/25	BOX	7.44
82314	7/8" ID x 3/4" Wall	20	-/20	BOX	9.75
82315	5/8" ID x 1" Wall	20	-/20	BOX	13.69
82316	3/4" ID x 1" Wall	15	-/15	BOX	14.40
82317	7/8" ID x 1" Wall	15	-/15	BOX	16.11
82318	1-1/8" ID x 1" Wall	12	-/12	BOX	18.79

### ADJUSTABLE LINE TAP VALVE

- Available in two sizes to accommodate five different OD tube sizes
- Depressor valve action
- Can be mounted in any position
- Retracting needle ensures no restriction
- Throwaway depressor pin simplifies line piercing
- Can be used with all refrigerants including R410A
- Max operating pressure 800 PSI



PART #	DESCRIPTION	UNIT ORDER	INN/MAS	PACK	LIST
65820	1/4", 5/16", 3/8" OD Tube Size	12	-/12	BOX	5.47
65821	1/2", 5/8" OD Tube Size	12	-/12	BOX	5.68

## Tools

### POCKET DIAL THERMOMETERS

- 1" Magnifying dial face
- Stainless steel stem
- Watertight plastic dial cover
- Recalibration nut



PART #	DESCRIPTION	UNIT ORDER	INN/MAS	PACK	LIST
45062	0° to 200° F	1	-/100	BOX	6.73
45063	-40° to 160° F	1	-/100	BOX	6.73

## Tapes

### CLOTH DUCT TAPE

- Rubber-based adhesive
- Scrim reinforced facestock
- 48 mm x 60 yd
- 11 Mil



PART #	DESCRIPTION	UNIT ORDER	INN/MAS	PACK	LIST
90816	Silver OEM #950S	1	-/24	BULK	17.62

### FOIL TAPE

- Highly conformable dead-soft 1.5 mil foil facestock
- Quick-stick, rubber-based adhesive
- Strong, bleached 40 lb densified kraft liner
- UL rated



PART #	DESCRIPTION	UNIT ORDER	INN/MAS	PACK	LIST
90814	2" x 50 Yards OEM #1803	1	-/24	BULK	17.36

## Sealants

### FIBER REINFORCED WATER BASED DUCT SEALANT

- UL 181 A-M and B-M listed
- LEED credit EQ 4.1 eligible
- For indoor and outdoor use
- Fiber reinforced for additional strength
- Excellent mold and mildew resistance
- Use to seal all types of HVAC systems
- Gray



PART #	DESCRIPTION	UNIT ORDER	INN/MAS	PACK	LIST
90122	CADS® Duct Sealant 1 Gallon	1	-/4	BULK	28.37

### PREMIUM WATER BASED DUCT SEALANT

- UL 181 A-M and B-M listed
- LEED Credit EQ 4.1 Eligible
- High solids content formulation
- For indoor and outdoor use
- Excellent mold and mildew resistance
- Exceeds all SMACNA pressure and sealing classes



PART #	DESCRIPTION	UNIT ORDER	INN/MAS	PACK	LIST
90124	Airseal® 11 Duct Sealant 10.3 oz Tube Gray OEM #AS11-T(G)	1	-/24	BULK	6.10
90126	Airseal® 11 Duct Sealant 1 Gallon Pail Gray OEM #AS11-1(G)	1	-/4	BULK	49.18

### 100% RTV SILICONE SEALANT

- Available in clear, white and aluminum
- FDA and USDA approved
- Permanently flexible
- Excellent mold and mildew resistance



PART #	DESCRIPTION	UNIT ORDER	INN/MAS	PACK	LIST
90131	Polysil® Silicone - Clear	1	-/12	BULK	9.01
90132	Polysil® Silicone - White	1	-/12	BULK	9.01
90133	Polysil® Silicone - Aluminum	1	-/12	BULK	9.01

### HI-TEMP RED SILICONE SEALANT

- For use on application up to 600° F
- FDA and USDA approved
- Permanently flexible
- Excellent mold and mildew resistance



PART #	DESCRIPTION	UNIT ORDER	INN/MAS	PACK	LIST
90134	Polysil® Hi-Temp Red Silicone	1	-/12	BULK	16.14

Supply Connectors

Stop Valves

Water Heater

Gas Connectors

Water Filtration

Sinks/ Faucets

Tubular/ Drainage

Faucet Repair

Bath Accessories

Pipe Fittings/ Repair

Valves

Cements/ Sealants

Tools/ Safety

Toilet Repair

Appliance/ HVAC

Hardware

Electrical

Index

# APPLIANCE AND HVAC

## Sealants

### HIGH TEMP RED SILICONE SEALANT

**NEW**

- Ideal for flue pipes and other high-temperature applications
- Remains flexible up to 550° F (intermittent)
- Will not crack or shrink
- Weather-resistant



PART #	DESCRIPTION	UNIT ORDER	INN/MAS	PACK	LIST
58193	10.3 oz - Red	12	-/12	BULK	12.09

## A/C Disconnects and Fittings

### A/C DISCONNECT

- For use with aluminum or copper conductors
- Easy-on, easy-off disconnect pullout
- Knock-outs provided on the back, bottom and side for all applications
- Lift-up cover with lockable latch
- NEMA 3R rainproof enclosure for outdoor use



PART #	DESCRIPTION	UNIT ORDER	INN/MAS	PACK	LIST
90838	30 Amp - Fused	1	-/12	BOX	22.27
90837	60 Amp - Fused	1	-/12	BOX	22.78
90836	60 Amp - Non-Fused	1	-/12	BOX	16.91

### NONMETALLIC LIQUID-TIGHT STRAIGHT CONNECTOR

- Use with nonmetallic flexible liquid-tight conduit



PART #	DESCRIPTION	UNIT ORDER	INN/MAS	PACK	LIST
99018	1/2"	25	-/25	BAG	1.91
99020	3/4"	25	-/25	BAG	2.79

### NONMETALLIC LIQUID-TIGHT 90° CONNECTOR

- Use with nonmetallic flexible liquid-tight conduit



PART #	DESCRIPTION	UNIT ORDER	INN/MAS	PACK	LIST
99019	1/2"	10	-/10	BAG	3.65
99022	3/4"	10	-/10	BAG	4.39

## PVC CONDENSATE P-TRAP

- Schedule 40
- Spigot x spigot



PART #	DESCRIPTION	UNIT ORDER	INN/MAS	PACK	LIST
45218	3/4"	1	1/1	BULK	3.28

## PVC CONDENSATE RUNNING TRAP

- Schedule 40
- Spigot x spigot



PART #	DESCRIPTION	UNIT ORDER	INN/MAS	PACK	LIST
45219	3/4"	1	1/1	BULK	2.17

## Pumps

### CONDENSATE REMOVAL PUMP

**NEW**

- 1/30 HP high-performance motor
- 1/2-Gallon capacity
- 20' Shutoff
- Includes safety switch
- 6' Power cord



PART #	DESCRIPTION	UNIT ORDER	INN/MAS	PACK	LIST
50114	115 Volt Pump	1	-/4	BOX	90.10
50115	230 Volt Pump	1	-/4	BOX	91.61

## Locksets

### LEVER HANDLE LOCKSET - PRIVACY

- Heavy metal construction
- Adjustable backset 2-3/8" or 2-3/4"



PART #	DESCRIPTION	UNIT ORDER	INN/MAS	PACK	LIST
57533	Polished Brass	6	6/24	CLAM	24.86

### SINGLE CYLINDER DEADBOLT

- Adjustable backset 2-3/8" or 2-3/4"
- Case-hardened 1" throw
- Re-keyable
- Keyway KW1



PART #	DESCRIPTION	UNIT ORDER	INN/MAS	PACK	LIST
57521	Polished Brass	1	-/24	BOX	14.46
57522	Polished Brass	6	6/24	CLAM	16.96
57524	Antique Brass	6	6/24	CLAM	16.96
57526	Brushed Nickel	6	6/24	CLAM	16.96

### DOUBLE CYLINDER DEADBOLT

- Adjustable backset 2-3/8" or 2-3/4"
- Case-hardened 1" throw
- Re-keyable
- Keyway KW1



PART #	DESCRIPTION	UNIT ORDER	INN/MAS	PACK	LIST
57551	Polished Brass	1	-/24	BOX	19.84
57552	Polished Brass	6	6/24	CLAM	20.22

### LEVER HANDLE LOCKSET - PASSAGE

- Heavy metal construction
- Adjustable backset 2-3/8" or 2-3/4"
- Non-reversing



PART #	DESCRIPTION	UNIT ORDER	INN/MAS	PACK	LIST
57770	Polished Brass - Right Hand	1	-/24	BOX	23.78
57670	Brushed Nickel - Right Hand	1	-/24	BOX	23.78
57773	Polished Brass - Left Hand	1	-/24	BOX	23.78
57673	Brushed Nickel - Left Hand	1	-/24	BOX	23.78

### LEVER HANDLE LOCKSET - PRIVACY

- Heavy metal construction
- Adjustable backset 2-3/8" or 2-3/4"
- Non-reversing



PART #	DESCRIPTION	UNIT ORDER	INN/MAS	PACK	LIST
57771	Polished Brass - Right Hand	1	-/24	BOX	24.78
57671	Brushed Nickel - Right Hand	1	-/24	BOX	24.78
57774	Polished Brass - Left Hand	1	-/24	BOX	24.78
57674	Brushed Nickel - Left Hand	1	-/24	BOX	24.78

### LEVER HANDLE LOCKSET - ENTRY

- Heavy metal construction
- Adjustable backset 2-3/8" or 2-3/4"
- Non-reversing
- KW1 keyway



PART #	DESCRIPTION	UNIT ORDER	INN/MAS	PACK	LIST
57772	Polished Brass - Right Hand	1	-/24	BOX	27.83
57672	Brushed Nickel - Right Hand	1	-/24	BOX	27.83
57775	Polished Brass - Left Hand	1	-/24	BOX	27.83
57675	Brushed Nickel - Left Hand	1	-/24	BOX	27.83

### ENTRY LOCKSET - TULIP KNOB

- Adjustable back set 2-3/8" or 2-3/4"
- Re-keyable
- Keyway KW1



PART #	DESCRIPTION	UNIT ORDER	INN/MAS	PACK	LIST
57501	Polished Brass	1	-/24	BOX	17.73
57502	Polished Brass	6	6/24	CLAM	18.79
57504	Antique Brass	6	6/24	CLAM	19.53
57506	Brushed Nickel	6	6/24	CLAM	18.93

### PASSAGE LOCKSET - TULIP KNOB

- Adjustable back set 2-3/8" or 2-3/4"



PART #	DESCRIPTION	UNIT ORDER	INN/MAS	PACK	LIST
57511	Polished Brass	1	-/24	BOX	14.94
57514	Antique Brass	6	6/24	CLAM	16.88
57516	Brushed Nickel	6	6/24	CLAM	16.08

Supply Connectors

Stop Valves

Water Heater

Gas Connectors

Water Filtration

Sinks/ Faucets

Tubular/ Drainage

Faucet Repair

Bath Accessories

Pipe Fittings/ Repair

Valves

Cements/ Sealants

Tools/ Safety

Toilet Repair

Appliance/ HVAC

Hardware

Electrical

Index

# HARDWARE

## Locksets

### PRIVACY LOCKSET - TULIP KNOB

- Adjustable back set 2-3/8" or 2-3/4"



PART #	DESCRIPTION	UNIT ORDER	INN/MAS	PACK	LIST
57531	Polished Brass	1	-/24	BOX	15.94
57534	Polished Brass	6	6/24	CLAM	16.88
57532	Antique Brass	6	6/24	CLAM	16.31
57536	Brushed Nickel	6	6/24	CLAM	16.48

### ENTRY LOCKSET - COMBINATION

- Includes a combination of 1 single cylinder deadbolt & 1 entry lockset - keyed alike - same key opens both locks
- Re-keyable
- Adjustable back set 2-3/8" or 2-3/4"
- Keyway KW1



PART #	DESCRIPTION	UNIT ORDER	INN/MAS	PACK	LIST
57601	Polished Brass	1	-/12	BOX	31.88
57602	Polished Brass	6	6/12	CLAM	33.50

### STRIKE PLATE

- Includes two polished brass-plated wood screws



PART #	DESCRIPTION	UNIT ORDER	INN/MAS	PACK	LIST
57081	Polished Brass-Plated	24	24/288	BULK	1.00
57082	Brushed Nickel	24	24/288	BULK	0.57

## Mailbox Locks

### XL MAILBOX LOCK

- Zinc face
- Keyway XL-7



PART #	DESCRIPTION	UNIT ORDER	INN/MAS	PACK	LIST
57403	Type B	50	50/500	BAG	4.33

### MAILBOX LOCK

- Universal-fit
- Keyway T-146

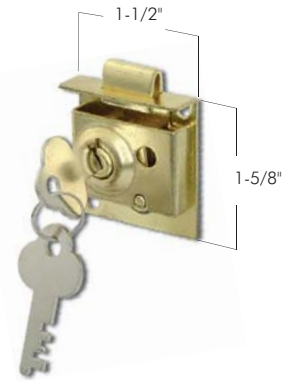

PART #	DESCRIPTION	UNIT ORDER	INN/MAS	PACK	LIST
57408	1-1/2" x 1-5/8"	1	10/200	BAG	2.74

*\*While Supplies Last*

### MAILBOX LOCK

- Multiple cams
- Includes five different cams
- Keyway HL-1

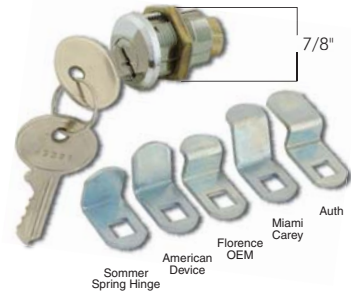

PART #	DESCRIPTION	UNIT ORDER	INN/MAS	PACK	LIST
57431	Chrome Face	20	20/100	BAG	5.47

### MAILBOX LOCK

- Multiple cams
- Includes five different cams
- Keyway HL-1

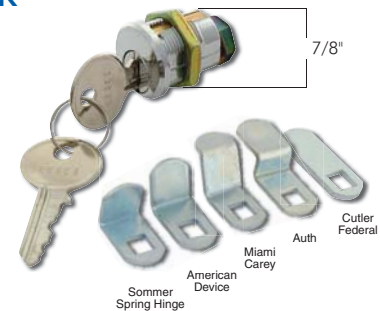

PART #	DESCRIPTION	UNIT ORDER	INN/MAS	PACK	LIST
57433	Chrome Face	20	20/100	BAG	5.47

### MAILBOX LOCK KEY - BLANK

- Keyway HL-1



PART #	DESCRIPTION	UNIT ORDER	INN/MAS	PACK	LIST
57435	Uncut	50	50/1500	BULK	0.63



## Window & Door Hardware

### DOOR VIEWER

- Fits 1-3/8" - 2" thick doors
- Glass lens



PART #	DESCRIPTION	UNIT ORDER	INN/MAS	PACK	LIST
56001	160° - .465 Dia. - Solid Brass	50	50/1000	BAG	3.11
56002	180° - .550 Dia. - Brass-Plated	24	24/600	BAG	3.28
56003	190° - .550 Dia. - Brass-Plated	20	20/600	BAG	4.99

- Fits 1-3/8" - 2-1/4" thick doors

PART #	DESCRIPTION	UNIT ORDER	INN/MAS	PACK	LIST
*56004	160° - .465 Dia. - Brass-Plated	20	20/600	BAG	3.36

\*While Supplies Last

### DOOR KNOCKER WITH VIEWER

- Fits 1-3/8" - 2" thick doors
- Viewer is 160° - .465 diameter
- Glass lens
- 4" Height



PART #	DESCRIPTION	UNIT ORDER	INN/MAS	PACK	LIST
56011	Brass-Plated	20	20/200	BAG	8.01
56012	Antique Brass	20	20/200	BAG	6.81

### SECURITY DOOR GUARD

- Swing type
- Includes screws



PART #	DESCRIPTION	UNIT ORDER	INN/MAS	PACK	LIST
56021	Brass-Plated	15	15/150	BAG	8.55
56023	Antique Brass-Plated	20	20/100	BAG	8.55

### CHAIN DOOR GUARD

- Includes screws



PART #	DESCRIPTION	UNIT ORDER	INN/MAS	PACK	LIST
56031	Polished Brass	20	20/200	BAG	2.33
56034	Chrome	20	20/200	BAG	2.45

### SLIDING DOOR & WINDOW LOCK



PART #	DESCRIPTION	UNIT ORDER	INN/MAS	PACK	LIST
56045	Single-Bolt	25	25/1000	BAG	0.77

### SLIDING DOOR & WINDOW LOCK PIN

- Includes stainless steel pin



PART #	DESCRIPTION	UNIT ORDER	INN/MAS	PACK	LIST
56041	2-1/2" x 1/4"	25	25/1000	BAG	1.71

### SLIDING DOOR LOCK WITH BAR

- Aluminum finish bar can be cut to size



PART #	DESCRIPTION	UNIT ORDER	INN/MAS	PACK	LIST
56053	48" Bar with Brackets	25	-/25	BAG	11.63

### WINDOW SASH LOCK

- Polished brass
- Includes screws



PART #	DESCRIPTION	UNIT ORDER	INN/MAS	PACK	LIST
56048	For Wood Windows	10	10/100	BAG	1.71

Supply Connectors

Stop Valves

Water Heater

Gas Connectors

Water Filtration

Sinks/ Faucets

Tubular/ Drainage

Faucet Repair

Bath Accessories

Pipe Fittings/ Repair

Valves

Cements/ Sealants

Tools/ Safety

Toilet Repair

Appliance/ HVAC

Hardware

Electrical

Index

# HARDWARE

## Window and Door Hardware

### DOOR HINGE WITH SCREWS

- Square corners
- Brass-plated steel
- Sold, priced and boxed in pairs

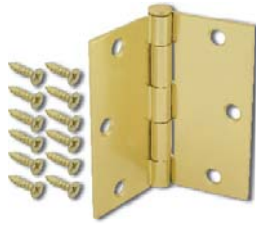

PART #	DESCRIPTION	UNIT ORDER	INN/MAS	PACK	LIST
57011	3-1/2" - 3-Hole	1	-/50	BOX	3.85

### CABINET DOOR HINGE - FLUSH MOUNT SELF-CLOSING

- Includes screws
- Flush
- Priced & bagged by the pair

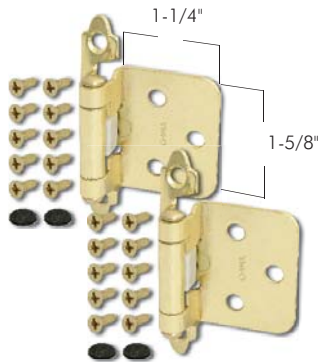

PART #	DESCRIPTION	UNIT ORDER	INN/MAS	PACK	LIST
56356	Polished Brass	10	10/200	BAG	1.68
56355	Antique Brass	10	10/200	BAG	1.68
56352	White	10	10/200	BAG	1.68
57010	Satin Nickel	1	10/200	BAG	5.27

### CABINET DOOR HINGE - 3/8" INSET SELF-CLOSING

- Includes screws
- Priced & bagged by the pair

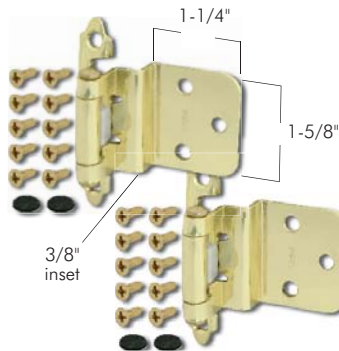

PART #	DESCRIPTION	UNIT ORDER	INN/MAS	PACK	LIST
56360	Polished Brass	10	10/200	BAG	1.88
56359	Antique Brass	10	10/200	BAG	1.88
*56354	White	10	10/200	BAG	0.91
57005	Satin Nickel	1	10/200	BAG	5.27

\*While Supplies Last

### DOOR HINGE WITH SCREWS

- Square corners
- Satin nickel finish
- Sold each



PART #	DESCRIPTION	UNIT ORDER	INN/MAS	PACK	LIST
57012	3-1/2" - 3-Hole	1	20/100	BULK	3.25
57013	4" - 4-Hole	1	20/100	BULK	4.13

### DOOR HINGE WITH SCREWS

- Round corners - 5/8" radius
- Brass-plated steel
- Sold, priced and boxed in pairs



PART #	DESCRIPTION	UNIT ORDER	INN/MAS	PACK	LIST
57037	3-1/2" - 3-Hole	1	-/50	BOX	5.39

### SPRING DOOR STOP

- Standard type

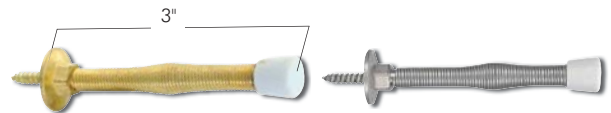

PART #	DESCRIPTION	UNIT ORDER	INN/MAS	PACK	LIST
56061	Polished Brass	10	10/500	BAG	0.57
56063	Antique Brass	10	10/500	BAG	0.57
56062	Satin Nickel	10	10/500	BAG	0.74
56065	Chrome	10	10/500	BAG	0.57

### SPRING DOOR STOP - HEAVY-DUTY

- Heavy-duty construction

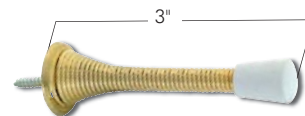

PART #	DESCRIPTION	UNIT ORDER	INN/MAS	PACK	LIST
56072	Polished Brass - 3"	10	10/500	BAG	0.57
56074	Antique Brass - 3"	10	10/500	BAG	0.48
56071	Polished Brass - 3-3/4"	5	5/200	BAG	0.63
56073	Antique Brass - 3-3/4"	5	5/200	BAG	0.66
56075	Chrome - 3-3/4"	5	5/200	BAG	0.63
56076	Brushed Nickel - 3-3/4"	5	5/200	BAG	0.80

## Window and Door Hardware

### RIGID DOOR STOP

- Standard type

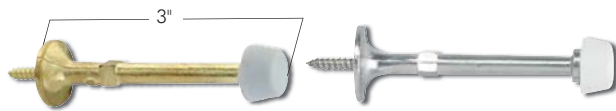

PART #	DESCRIPTION	UNIT ORDER	INN/MAS	PACK	LIST
56081	Polished Brass	10	10/500	BAG	1.00
56082	Satin Nickel	10	10/500	BAG	1.11

### RIGID DOOR STOP - HEAVY-DUTY

- Heavy-duty construction



PART #	DESCRIPTION	UNIT ORDER	INN/MAS	PACK	LIST
56087	Polished Brass	1	10/100	BAG	1.28
56092	Satin Nickel	1	10/100	BAG	2.17

### HINGE PIN DOOR STOP

- Zinc with plastic bushing & vinyl tips



PART #	DESCRIPTION	UNIT ORDER	INN/MAS	PACK	LIST
56101	Polished Brass	10	10/1000	BAG	1.20
56103	Antique Brass	10	10/1000	BAG	0.57
56104	Brushed Nickel	10	10/1000	BAG	0.83

### HINGE PIN DOOR STOP - Z-SHAPE

- Zinc with plastic bushing & vinyl tips



PART #	DESCRIPTION	UNIT ORDER	INN/MAS	PACK	LIST
56109	Polished Brass	10	10/200	BAG	2.14

### DOOR HOLDER - KICK-DOWN STYLE

- Kick-down style - 4" with screws



PART #	DESCRIPTION	UNIT ORDER	INN/MAS	PACK	LIST
56111	Polished Brass	10	10/100	BAG	7.21

### DOOR HOLDER - WEDGE STYLE

- Wedge style



PART #	DESCRIPTION	UNIT ORDER	INN/MAS	PACK	LIST
56127	Brown Rubber	10	25/400	BAG	1.68

### WALL DOOR STOP - ROUND TEXTURED

- Paintable
- With adhesive back



PART #	DESCRIPTION	UNIT ORDER	INN/MAS	PACK	LIST
56137	3-1/4" White	10	10/200	BAG	1.08
56139	5" White	10	10/200	BAG	1.60
56130	5" Navajo White	10	10/200	BAG	1.60

### WALL DOOR STOP - ROUND RUBBER

- 4-1/4" Diameter with adhesive back



PART #	DESCRIPTION	UNIT ORDER	INN/MAS	PACK	LIST
56133	White	10	10/200	BAG	2.28

### COMMERCIAL WALL DOOR STOP

- 2-1/2" Wall repair stop with screw



PART #	DESCRIPTION	UNIT ORDER	INN/MAS	PACK	LIST
56145	Stainless Steel	10	10/100	BAG	4.99

Supply Connectors

Stop Valves

Water Heater

Gas Connectors

Water Filtration

Sinks/Faucets

Tubular/Drainage

Faucet Repair

Bath Accessories

Pipe Fittings/Repair

Valves

Cements/Sealants

Tools/Safety

Toilet Repair

Appliance/HVAC

Hardware

Electrical

Index

# HARDWARE

## Window and Door Hardware

### ANGLE IRON CORNER BRACE

- Zinc-plated steel
- 4 Per bag



PART #	DESCRIPTION	UNIT ORDER	INN/MAS	PACK	LIST
57200	1" - 4 Pack	15	15/150	BAG	1.08
57201	1-1/2" - 4 Pack	10	10/200	BAG	1.14
57202	2" - 4 Pack	15	15/150	BAG	1.40
57203	2-1/2" - 4 Pack	9	9/180	BAG	1.82

## Wardrobe and Closet Hardware

### CLOSET ROD HOLDER

- Plastic
- Sold and priced by the pair



PART #	DESCRIPTION	UNIT ORDER	INN/MAS	PACK	LIST
56421	Opaque	10	10/300	BAG	0.66

### CLOSET ROD SUPPORT

- Includes mounting screws



PART #	DESCRIPTION	UNIT ORDER	INN/MAS	PACK	LIST
56423	Steel	20	-/20	BAG	4.08

### FLUSH PULL - 2-1/8" DIAMETER

- For wardrobe doors



PART #	DESCRIPTION	UNIT ORDER	INN/MAS	PACK	LIST
56405	Polished Brass	10	10/200	BAG	1.08

### FLUSH PULL - 3/4" DIAMETER

- For wardrobe doors
- Finger-pull style



PART #	DESCRIPTION	UNIT ORDER	INN/MAS	PACK	LIST
*56401	3/4" Polished Brass	10	10/200	BAG	0.17

*\*While Supplies Last*

## Cabinet Hardware

### SELF-CLOSING DRAWER SLIDE

- White metal
- Self-closing - bottom mount
- Includes 16 flat-head screws
- Sold and priced by the pair



PART #	DESCRIPTION	UNIT ORDER	INN/MAS	PACK	LIST
56251	14" Length	20	-/20	BAG	2.88
56252	16" Length	20	-/20	BAG	3.76
56253	18" Length	20	-/20	BAG	4.25
56254	20" Length	20	-/20	BAG	4.48

### DOUBLE ROLLER CATCH

- Includes screws



56341

56339

PART #	DESCRIPTION	UNIT ORDER	INN/MAS	PACK	LIST
56339	U-Type	10	10/200	BAG	0.77
56341	Spear Strike	10	10/200	BAG	0.63

### MAGNETIC CATCH

- Includes screws



PART #	DESCRIPTION	UNIT ORDER	INN/MAS	PACK	LIST
56337	Plastic Case	10	10/100	BAG	0.86
56338	Metal Case	10	10/100	BAG	1.25

## Cabinet Hardware

### CABINET & DRAWER KNOB - 1-1/2"

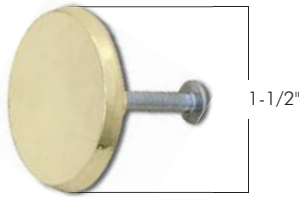

PART #	DESCRIPTION	UNIT ORDER	INN/MAS	PACK	LIST
56301	Polished Brass	10	10/1000	BAG	1.11
*56303	Antique Brass	10	10/1000	BAG	1.14
56305	Chrome	10	10/1000	BAG	1.14
56306	White	10	10/1000	BAG	1.14

\*While Supplies Last

### HANDRAIL BRACKET

- Includes screws



PART #	DESCRIPTION	UNIT ORDER	INN/MAS	PACK	LIST
56437	Brass-Plated	10	10/200	BAG	2.74
56439	Satin Nickel	1	10/200	BAG	3.45

### CABINET & DRAWER PULL - DECORATIVE

- 3" Pull with screws
- Polished brass finish



PART #	DESCRIPTION	UNIT ORDER	INN/MAS	PACK	LIST
*56373	White Ceramic Insert	20	20/200	BAG	2.74
56374	Ivory Ceramic Insert	20	20/200	BAG	2.74
56375	Wood Insert	20	20/200	BAG	2.74

\*While Supplies Last

### CABINET & DRAWER PULL

- 3" Pull with screws
- Solid brass

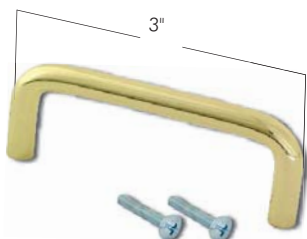

PART #	DESCRIPTION	UNIT ORDER	INN/MAS	PACK	LIST
56388	Polished Brass	50	50/250	BULK	2.74

### CABINET & DRAWER PULL

- 3" Pull with screws

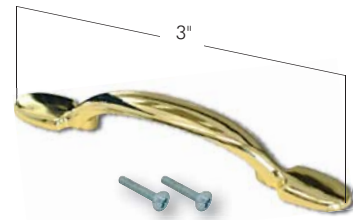

PART #	DESCRIPTION	UNIT ORDER	INN/MAS	PACK	LIST
56383	Polished Brass	10	10/200	BAG	1.71

### BIFOLD & BYPASS KNOBS - 1-7/8"

- 1-3/4" Screw length
- Sold 5 per bag



PART #	DESCRIPTION	UNIT ORDER	INN/MAS	PACK	LIST
56307	Polished Brass	1	10/40	BAG	6.70
56308	Polished Chrome	1	10/40	BAG	6.70
56309	Satin Nickel	1	10/40	BAG	7.21

### KNOB & PULL BREAKAWAY SCREW

- 8-32 x 1-3/4"
- Screws can be broken at varying lengths to accommodate different mounting material thickness
- Bag of 25



PART #	DESCRIPTION	UNIT ORDER	INN/MAS	PACK	LIST
56320	Break-Off Screw	1	-/40	BAG	3.11

## Lawn and Garden

### VALVE/METER BOX - ROUND

- Polypropylene material for maximum durability and corrosion resistance
- UV-resistant
- Lid has diamond pattern for skid resistance
- Pipe slots on each end of the box that measure 2-1/4" x 2-9/16" on 6" round and 2" x 3" on the 10" round



PART #	DESCRIPTION	UNIT ORDER	INN/MAS	PACK	LIST
70160	6" Black/Green Lid OEM #109.9G	1	-/36	BULK	5.68
70161	10" Black/Green Lid OEM #1100.10SG	1	-/10	BULK	21.53

Supply Connectors

Stop Valves

Water Heater

Gas Connectors

Water Filtration

Sinks/Faucets

Tubular/Drainage

Faucet Repair

Bath Accessories

Pipe Fittings/Repair

Valves

Cements/Sealants

Tools/Safety

Toilet Repair

Appliance/HVAC

Hardware

Electrical

Index

# HARDWARE

## Lawn and Garden

### VALVE/METER BOX - RECTANGLE

- Polypropylene material for maximum durability and corrosion resistance
- UV-resistant
- Lid has diamond pattern for skid resistance
- Pipe slots on each end of the box that measure 3" x 4"



PART #	DESCRIPTION	UNIT ORDER	INN/MAS	PACK	LIST
70162	10" Black/Green Lid OEM #1000.10SG	1	-/10	BULK	29.05
70164	12" Black/Black Reader OEM #1200.12RB	1	-/10	BULK	42.91

### HOSE NOZZLE - CHROME PISTOL GRIP

- Smooth-action lever
- Heavy-duty zinc body with solid brass mechanism



PART #	DESCRIPTION	UNIT ORDER	INN/MAS	PACK	LIST
70122	Chrome-Plated	10	10/160	BULK	6.17

### HOSE NOZZLE - INSULATED PISTOL GRIP

- Heavy-duty zinc body with solid brass mechanism
- Smooth-action lever
- Plastic insulated handle



PART #	DESCRIPTION	UNIT ORDER	INN/MAS	PACK	LIST
70124	Plastic Grip	10	10/100	BULK	7.58

### HOSE NOZZLE - 3" ADJUSTABLE



PART #	DESCRIPTION	UNIT ORDER	INN/MAS	PACK	LIST
70126	Brass	10	10/100	BULK	5.45

### TWIN HOSE CONNECTOR

- Includes one hose washer



PART #	DESCRIPTION	UNIT ORDER	INN/MAS	PACK	LIST
70131	Brass	10	10/100	BULK	5.82

### TWIN HOSE CONNECTOR - DUAL-SHUTOFF

- With dual-shutoff mechanism



PART #	DESCRIPTION	UNIT ORDER	INN/MAS	PACK	LIST
70135	Plastic	10	10/100	BULK	2.79

### MALE PIPE TO FEMALE HOSE ADAPTER

- Female hose
- Brass



PART #	DESCRIPTION	UNIT ORDER	INN/MAS	PACK	LIST
20366	3/4" FHT x 3/4" FIP	10	10/200	BULK	4.16

### HOSE-TO-PIPE ADAPTERS

- Converts garden hose threads to iron pipe threads or vice versa
- Male hose thread
- Brass



PART #	DESCRIPTION	UNIT ORDER	INN/MAS	PACK	LIST
20351	3/4" MHT x 3/4" MIP Tapped 1/2" FIP	10	10/200	BULK	3.34
20353	3/4" MHT x 3/4" MHT Tapped 1/2" FIP	10	10/200	BULK	3.16
20355	3/4" MHT x 1/2" MIP	10	10/200	BULK	3.16

## Lawn and Garden

### HOSE-TO-PIPE ADAPTERS

- Converts garden hose threads to iron pipe threads or vice versa
- Female hose thread
- Brass



PART #	DESCRIPTION	UNIT ORDER	INN/MAS	PACK	LIST
20357	3/4" FHT x 3/4" MIP Tapped 1/2" FIP	10	10/200	BULK	<b>3.68</b>

### SWIVEL HOSE CONNECTOR

- Converts garden hose threads to iron pipe threads or vice versa
- Female hose thread
- Brass



20361

20363

20365

PART #	DESCRIPTION	UNIT ORDER	INN/MAS	PACK	LIST
20361	3/4" FHT x 1/2" FIP	10	10/200	BULK	<b>4.22</b>
20363	3/4" FHT x 3/4" FIP	10	10/250	BULK	<b>5.33</b>
20365	3/4" FHT x 3/4" FHT	10	10/250	BULK	<b>4.16</b>

### HOSE END CAP

- 3/4" Female hex thread



PART #	DESCRIPTION	UNIT ORDER	INN/MAS	PACK	LIST
70136	Brass	20	20/2000	BULK	<b>1.48</b>
70137	Plastic	1	20/2000	BULK	<b>0.48</b>

### HOSE MENDER COUPLING

- ABS - black
- 5 Pieces polybagged as 1 set



PART #	DESCRIPTION	UNIT ORDER	INN/MAS	PACK	LIST
70112	Repairs 1/2" or 5/8" Hose	25	25/500	BAG	<b>2.05</b>

### HOSE MENDER - FEMALE THREAD

- ABS - black



PART #	DESCRIPTION	UNIT ORDER	INN/MAS	PACK	LIST
70114	Repairs 1/2" or 5/8" Hose	25	25/500	BULK	<b>1.60</b>
70116	Repairs 5/8" or 3/4" Hose	25	25/500	BULK	<b>1.60</b>

### HOSE MENDER - MALE THREAD

- ABS - black



PART #	DESCRIPTION	UNIT ORDER	INN/MAS	PACK	LIST
70118	Repairs 1/2" or 5/8" Hose	25	25/500	BULK	<b>1.48</b>
70120	Repairs 5/8" or 3/4" Hose	25	25/500	BULK	<b>1.48</b>

### HOSE WASHER

- Fits all garden hose connections
- Sold & priced 100 per bag



PART #	DESCRIPTION	UNIT ORDER	INN/MAS	PACK	LIST
70141	Red Rubber	1	-/100	BULK	<b>6.48</b>

### HOSE FILTER WASHER

- Brass mesh screen
- Sold & priced 100 per bag



PART #	DESCRIPTION	UNIT ORDER	INN/MAS	PACK	LIST
70143	Filter Washer	1	-/50	BAG	<b>42.11</b>

Supply Connectors

Stop Valves

Water Heater

Gas Connectors

Water Filtration

Sinks/ Faucets

Tubular/ Drainage

Faucet Repair

Bath Accessories

Pipe Fittings/ Repair

Valves

Cements/ Sealants

Tools/ Safety

Toilet Repair

Appliance/ HVAC

Hardware

Electrical

Index

# HARDWARE

## Paint Supplies

### CHIP PAINT BRUSH - DISPOSABLE

- Wood handle
- Natural bristle



PART #	DESCRIPTION	UNIT ORDER	INN/MAS	PACK	LIST
55421	1" Wide	1	36/864	BULK	0.34
55425	2" Wide	1	36/864	BULK	0.54
55427	3" Wide	1	12/432	BULK	0.80
55429	4" Wide	1	12/288	BULK	1.22

### CAULKING GUN

- Holds 9" caulking tube



PART #	DESCRIPTION	UNIT ORDER	INN/MAS	PACK	LIST
55401	Ratchet Type	1	10/40	BULK	4.79

### DUST & POLLEN MASK

- Bagged with header card
- Sold & priced per bag of 5



PART #	DESCRIPTION	UNIT ORDER	INN/MAS	PACK	LIST
55335	Five Masks per Bag	1	20/200	BAG	1.88

### YELLOW BARRIER FLAGGING TAPE

- 3" x 300' Length



PART #	DESCRIPTION	UNIT ORDER	INN/MAS	PACK	LIST
50181	Caution Tape	8	8/16	BULK	13.60

### MASKING TAPE

- 60 Yard length



PART #	DESCRIPTION	UNIT ORDER	INN/MAS	PACK	LIST
50077	2" x 60 Yards	1	-/24	BULK	5.70

**VISIT US  
ONLINE!**  
[www.EZ-FLO.net](http://www.EZ-FLO.net)



[www.EZ-FLO.net](http://www.EZ-FLO.net)



## Ground Fault Circuit Interrupters

### GROUND FAULT CIRCUIT INTERRUPTER

- Duplex receptacle with face plate
- 20 Amp feed through
- 15 Amp, 125 Volt, 60 Hz
- Matching test & reset buttons
- Circuit indicator light



PART #	DESCRIPTION	UNIT ORDER	INN/MAS	PACK	LIST
62167	White	1	10/50	BOX	18.11
62168	Ivory	1	10/50	BOX	18.11

### TAMPER-RESISTANT GFCI

- Tamper-resistant
- 15 Amp, 125 Volt, 60 Hz
- 20 Amp feed through
- Matching test & reset buttons
- LED circuit indicator light



PART #	DESCRIPTION	UNIT ORDER	INN/MAS	PACK	LIST
62173	White	10	10/50	BOX	24.09
62174	Ivory	10	10/50	BOX	24.09

### GROUND FAULT CIRCUIT INTERRUPTER

- LED circuit indicator light
- 20 Amp, 125 Volts, 60 Hz
- Matching test and reset buttons



PART #	DESCRIPTION	UNIT ORDER	INN/MAS	PACK	LIST
62177	White	10	10/50	BOX	21.47
62178	Ivory	10	10/50	BOX	21.47

### TAMPER-RESISTANT GFCI

- Tamper-resistant
- 20 Amp, 125 Volt, 60 Hz
- Matching test and reset buttons
- LED circuit indicator light



PART #	DESCRIPTION	UNIT ORDER	INN/MAS	PACK	LIST
62175	White	10	10/50	BOX	25.78
62176	Ivory	10	10/50	BOX	25.78

## Receptacles and Switches

### DUPLEX RECEPTACLE

- 15 Amp / 125V
- Side wire #12 or #14 AWG, back wire is #14 AWG only



PART #	DESCRIPTION	UNIT ORDER	INN/MAS	PACK	LIST
62023	White	10	10/200	BULK	1.14
62024	Ivory	10	10/200	BULK	1.14

### TAMPER-RESISTANT DUPLEX RECEPTACLE

- Tamper-resistant
- 15 Amp / 125V
- Side wire #12 or #14 AWG, back wire is #14 only



PART #	DESCRIPTION	UNIT ORDER	INN/MAS	PACK	LIST
62169	White	10	10/200	BULK	2.28
62170	Ivory	10	10/200	BULK	2.28

### DECO DUPLEX RECEPTACLE

- 15 Amp / 125V
- Side wire #12 or #14 AWG, back wire is #14 AWG only



PART #	DESCRIPTION	UNIT ORDER	INN/MAS	PACK	LIST
62025	White	10	10/200	BULK	1.17
62026	Ivory	10	10/200	BULK	1.17

### TAMPER-RESISTANT DECO DUPLEX RECEPTACLE

- Tamper-resistant
- 15 Amp / 125V
- Side wire #12 or #14 AWG, back wire #14 only



PART #	DESCRIPTION	UNIT ORDER	INN/MAS	PACK	LIST
62171	White	10	10/200	BULK	2.74
62172	Ivory	10	10/200	BULK	2.74

Supply Connectors

Stop Valves

Water Heater

Gas Connectors

Water Filtration

Sinks/Faucets

Tubular/Drainage

Faucet Repair

Bath Accessories

Pipe Fittings/Repair

Valves

Cements/Sealants

Tools/Safety

Toilet Repair

Appliance/HVAC

Hardware

Electrical

Index

## Receptacles and Switches

### DUAL USB CHARGER AND TAMPER-RESISTANT DUPLEX RECEPTACLE

- 15 Amp tamper-resistant duplex receptacle
- Two USB charging ports with a total power of 4 Amps
- Replaces a standard duplex receptacle
- Charge electrical devices directly without an adapter
- The USB ports are for charging portable electronic devices only



**NEW**



PART #	DESCRIPTION	UNIT ORDER	INN/MAS	PACK	LIST
62186	White	10	10/40	BULK	33.70

### DUAL USB CHARGER AND TAMPER-RESISTANT RECEPTACLE

- 15 Amp tamper-resistant receptacle
- Two USB charging ports with a total power of 4 Amps
- Replaces a standard duplex receptacle
- Charge electrical devices directly without an adapter
- The USB ports are for charging portable electronic devices only



**NEW**



PART #	DESCRIPTION	UNIT ORDER	INN/MAS	PACK	LIST
62185	White	10	10/40	BULK	31.79

### SINGLE-POLE SWITCH AND RECEPTACLE

- 15 Amp / 125V
- Side wire #12 or #14 AWG, back wire is #14 AWG only



PART #	DESCRIPTION	UNIT ORDER	INN/MAS	PACK	LIST
62078	White	10	10/200	BULK	7.27
62079	Ivory	10	10/200	BULK	7.27

### DOUBLE-TOGGLE SWITCH

- 15 Amp / 120V
- Grounded duplex toggle
- Commercial - side wired



PART #	DESCRIPTION	UNIT ORDER	INN/MAS	PACK	LIST
62257	Ivory	10	10/200	BOX	12.66

### SINGLE-POLE WALL SWITCH

- 15 Amp / 120V
- Faster installation with combination of side wiring and push-in wiring
- Punch-in terminals will accept #14 AWG wire
- Captive mounting screws



PART #	DESCRIPTION	UNIT ORDER	INN/MAS	PACK	LIST
62040	White	10	10/200	BULK	1.25
62041	Ivory	10	10/200	BULK	1.25

### DECO SINGLE-POLE WALL SWITCH

- 15 Amp / 120V
- Faster installation with combination of side wiring and push-in wiring
- Punch-in terminals will accept #14 AWG wire
- Captive mounting screws



PART #	DESCRIPTION	UNIT ORDER	INN/MAS	PACK	LIST
62042	White	10	10/200	BULK	1.71
62043	Ivory	10	10/200	BULK	1.71

### SINGLE-POLE WALL SWITCH

- 20 Amp / 120V
- Faster installation with combination of side wiring and push-in wiring
- Punch-in terminal will accept #14 AWG only
- Captive mounting screws



PART #	DESCRIPTION	UNIT ORDER	INN/MAS	PACK	LIST
62044	White	10	10/200	BULK	2.02
62045	Ivory	10	10/200	BULK	2.02

### DOUBLE-POLE WALL SWITCH

- 30 Amp - 120/277 V/AC
- Back and side wire terminal accept up to #10 solid or stranded wire
- Ground screw



PART #	DESCRIPTION	UNIT ORDER	INN/MAS	PACK	LIST
*62038	Ivory	1	10/200	BOX	32.02

\*While Supplies Last

## Receptacles and Switches

### DECO 3-WAY WALL SWITCH

- 15 Amp / 120V
- Faster installation with combination of side wiring and push-in wiring
- Punch-in terminal will accept #14 AWG only
- Captive mounting screws



PART #	DESCRIPTION	UNIT ORDER	INN/MAS	PACK	LIST
62048	White	1	10/200	BULK	2.25
62049	Ivory	1	10/200	BULK	2.25

### 3-WAY WALL SWITCH

- 20 Amp / 120V
- Faster installation with combination of side wiring and push-in wiring
- Punch-in terminal will accept #14 AWG only
- Captive mounting screws



PART #	DESCRIPTION	UNIT ORDER	INN/MAS	PACK	LIST
62046	White	1	10/200	BULK	1.71
62047	Ivory	1	10/200	BULK	1.71

## Cover Plates

### STANDARD DUPLEX RECEPTACLE WALL PLATE

- Standard wall plate
- High-impact plastic
- Captive mounting screws



PART #	DESCRIPTION	UNIT ORDER	INN/MAS	PACK	LIST
<b>SINGLE-GANG</b>					
62027	White	25	25/200	BAG	0.48
62028	Ivory	25	25/200	BAG	0.48
<b>TWO-GANG</b>					
62033	White	25	25/200	BAG	0.77
62034	Ivory	25	25/200	BAG	0.77

### MIDI DUPLEX RECEPTACLE WALL PLATE

- Midi size wall plate
- High-impact plastic
- Captive mounting screws



PART #	DESCRIPTION	UNIT ORDER	INN/MAS	PACK	LIST
<b>SINGLE-GANG</b>					
62029	White	25	25/200	BAG	0.63
62030	Ivory	25	25/200	BAG	0.63
<b>TWO-GANG</b>					
62037	White	25	25/200	BAG	1.28
62039	Ivory	25	25/200	BAG	1.28

### JUMBO DUPLEX RECEPTACLE WALL PLATE

- Jumbo wall plate
- High-impact plastic
- Captive mounting screws



PART #	DESCRIPTION	UNIT ORDER	INN/MAS	PACK	LIST
<b>SINGLE-GANG</b>					
62031	White	25	25/200	BAG	0.86
62032	Ivory	25	25/200	BAG	0.86

### JUMBO DUPLEX RECEPTACLE WALL PLATE

- Two-gang wall plate
- Screws included
- Box of 10



PART #	DESCRIPTION	UNIT ORDER	INN/MAS	PACK	LIST
62088	White	1	10/100	BOX	3.31
61020	Ivory	1	10/100	BOX	3.31

### COMBINATION SWITCH AND DUPLEX RECEPTACLE WALL PLATE

- Two-gang wall plate
- High-impact plastic
- Captive mounting screws



PART #	DESCRIPTION	UNIT ORDER	INN/MAS	PACK	LIST
62082	White	25	25/200	BAG	0.80
62083	Ivory	25	25/200	BAG	0.80

### JUMBO COMBINATION SWITCH AND DUPLEX RECEPTACLE WALL PLATE

- Two-gang wall plate
- Flush fitting, warp-resistant design
- Includes screws
- Box of 10



PART #	DESCRIPTION	UNIT ORDER	INN/MAS	PACK	LIST
62089	White	1	10/100	BOX	3.85
62263	Ivory	1	10/100	BOX	3.85

Supply Connectors

Stop Valves

Water Heater

Gas Connectors

Water Filtration

Sinks/Faucets

Tubular/Drainage

Faucet Repair

Bath Accessories

Pipe Fittings/Repair

Valves

Cements/Sealants

Tools/Safety

Toilet Repair

Appliance/HVAC

Hardware

Electrical

Index

## Cover Plates

### COMBINATION DECO SWITCH AND DUPLEX RECEPTACLE WALL PLATE

- Two-gang wall plate
- High-impact plastic
- Captive mounting screws



PART #	DESCRIPTION	UNIT ORDER	INN/ MAS	PACK	LIST
62084	White	25	25/200	BAG	0.80
62085	Ivory	25	25/200	BAG	0.80

### WALL SWITCH STANDARD FACE PLATE

- Standard plate
- High-impact plastic
- Captive mounting screws



PART #	DESCRIPTION	UNIT ORDER	INN/ MAS	PACK	LIST
<b>SINGLE-GANG</b>					
62050	White	25	25/200	BAG	0.48
62051	Ivory	25	25/200	BAG	0.48
<b>TWO-GANG</b>					
62056	White	25	25/200	BAG	0.88
62057	Ivory	25	25/200	BAG	0.88
<b>THREE-GANG</b>					
62060	White	25	25/200	BAG	1.31
62061	Ivory	25	25/200	BAG	1.31
<b>FOUR-GANG</b>					
62064	White	25	25/200	BAG	1.82
62065	Ivory	25	25/200	BAG	1.82

### WALL SWITCH MIDI FACE PLATE

- Midi size wall plate
- High-impact plastic
- Captive mounting screws



PART #	DESCRIPTION	UNIT ORDER	INN/ MAS	PACK	LIST
<b>SINGLE-GANG</b>					
62052	White	25	25/200	BAG	0.71
62053	Ivory	25	25/200	BAG	0.71
<b>TWO-GANG</b>					
62058	White	25	25/200	BAG	1.14
62059	Ivory	25	25/200	BAG	1.14

### WALL SWITCH JUMBO FACE PLATE

- Jumbo wall plate
- High-impact plastic
- Captive mounting screws



PART #	DESCRIPTION	UNIT ORDER	INN/ MAS	PACK	LIST
<b>SINGLE-GANG</b>					
62054	White	25	25/200	BAG	1.05
62055	Ivory	25	25/200	BAG	1.05

### STANDARD DECO WALL PLATE

- Standard deco wall plate
- High-impact plastic
- Captive mounting screws



PART #	DESCRIPTION	UNIT ORDER	INN/ MAS	PACK	LIST
<b>SINGLE-GANG</b>					
62066	White	25	25/200	BAG	0.48
62067	Ivory	25	25/200	BAG	0.48
<b>TWO-GANG</b>					
62068	White	25	25/200	BAG	0.77
62069	Ivory	25	25/200	BAG	0.77
<b>THREE-GANG</b>					
62070	White	25	25/200	BAG	1.25
62071	Ivory	25	25/200	BAG	1.25
<b>FOUR-GANG</b>					
62072	White	25	25/200	BAG	1.34
62073	Ivory	25	25/200	BAG	1.34

## Cover Plates

### STANDARD BLANK WALL PLATE

- Standard blank wall plate
- High-impact plastic
- Captive mounting screws



PART #	DESCRIPTION	UNIT ORDER	INN/MAS	PACK	LIST
<b>SINGLE-GANG</b>					
62074	White	25	25/200	BAG	0.54
62075	Ivory	25	25/200	BAG	0.54
<b>TWO-GANG</b>					
62076	White	25	25/200	BAG	1.00
62077	Ivory	25	25/200	BAG	1.00

### JUMBO BLANK WALL PLATE

- Oversize jumbo blank wall plate
- Single-gang
- Includes screws
- **Sold in box of 10**



PART #	DESCRIPTION	UNIT ORDER	INN/MAS	PACK	LIST
62063	White	1	10/100	BOX	1.63
62062	Ivory	1	10/100	BOX	1.63

### IN-USE WEATHERPROOF COVERS

- Interchangeable plates
- Quick-fit installs in seconds
- Includes gasket and mounting hardware
- Cover is removable
- Made of polycarbonate
- UV-resistant, noncorrosive, nonconductive



PART #	DESCRIPTION	UNIT ORDER	INN/MAS	PACK	LIST
62080	Single-Gang	1	-/20	BAG	22.01
62081	Two-Gang	1	-/20	BAG	32.99

## Ceiling Accessories

### CEILING FAN LIGHT SWITCH

- Single position



PART #	DESCRIPTION	UNIT ORDER	INN/MAS	PACK	LIST
61101	On/Off Position	1	10/200	BULK	2.46

### CEILING FAN SWITCH

- 3-Speed ceiling fan switch
- RU & CSA approved
- 3 Amp 250 VAC or 6 Amp 123 VAC



PART #	DESCRIPTION	UNIT ORDER	INN/MAS	PACK	LIST
61105	Off / Low / Med / High	1	10/200	BULK	3.36

### CEILING FAN FIXTURE FLANGE

- 12" Diameter
- White



PART #	DESCRIPTION	UNIT ORDER	INN/MAS	PACK	LIST
62021	12" Diameter - White	1	10/50	BAG	7.27

### SMOKE DETECTOR COVER PLATE

- Use to cover marks on ceiling or for mounting smoke detector to an electrical box



PART #	DESCRIPTION	UNIT ORDER	INN/MAS	PACK	LIST
61529	6-1/2" Diameter	12	-/12	BAG	5.84

## Telephone and Cable Accessories

### WALL OUTLET - FLUSH MOUNT

- 4-Conductor for use with 1 or 2 line telephones
- Standard style
- Includes screws



PART #	DESCRIPTION	UNIT ORDER	INN/MAS	PACK	LIST
61001	Ivory	1	20/500	BULK	1.30
61011	White	1	20/500	BULK	1.30

Supply Connectors

Stop Valves

Water Heater

Gas Connectors

Water Filtration

Sinks/Faucets

Tubular/Drainage

Faucet Repair

Bath Accessories

Pipe Fittings/Repair

Valves

Cements/Sealants

Tools/Safety

Toilet Repair

Appliance/HVAC

Hardware

Electrical

Index

# ELECTRICAL

## Telephone and Cable Accessories

### WALL OUTLET - SINGLE

- 4-Conductor for use with 1 or 2 line telephones
- Includes screws



PART #	DESCRIPTION	UNIT ORDER	INN/MAS	PACK	LIST
61005	Ivory	1	20/300	BULK	2.51
61013	White	1	20/300	BULK	2.51

### BASE LINE CORD

- 4-Conductor
- Ivory



PART #	DESCRIPTION	UNIT ORDER	INN/MAS	PACK	LIST
61017	25'	1	20/400	BULK	3.96

### COMBO PHONE AND CABLE WALL PLATE

- Features one 4-conductor phone jack and one coaxial cable outlet
- Includes screws



PART #	DESCRIPTION	UNIT ORDER	INN/MAS	PACK	LIST
61075	Ivory	1	5/500	BULK	1.85
61076	White	1	5/500	BULK	1.85

### COAXIAL CABLE WALL OUTLET - SINGLE

- Single outlet
- Includes screws



PART #	DESCRIPTION	UNIT ORDER	INN/MAS	PACK	LIST
61067	Ivory	1	20/40	BULK	1.60
61069	White	1	20/40	BULK	1.60

### COAXIAL CABLE WALL OUTLET - DUAL

- Dual outlet
- Includes screws



PART #	DESCRIPTION	UNIT ORDER	INN/MAS	PACK	LIST
61074	White	1	20/40	BULK	1.63

### CABLE 2-WAY SPLITTER

- Splits from single line into 2 lines



PART #	DESCRIPTION	UNIT ORDER	INN/MAS	PACK	LIST
*61071	Chrome-Plated	10	10/1000	BAG	1.45

\*While Supplies Last

## Electrical Supplies

### HALOGEN WORK LIGHT

- 5000' of light - 500 Watt
- On/off switch
- 90° Adjustable tubular steel stand
- Steel protective grill



PART #	DESCRIPTION	UNIT ORDER	INN/MAS	PACK	LIST
*62165	500 Watt	1	-/8	BOX	25.32

\*While Supplies Last

### ROMEX CONNECTOR

- 3/8" Metal romex clamp style connector
- Fits 1/2" knock-outs



PART #	DESCRIPTION	UNIT ORDER	INN/MAS	PACK	LIST
99030	1/2" Knock-Out	1	-/1000	BULK	0.54

## Electrical Supplies

### ROMEX 90° CONNECTOR

- 1/2" Zinc squeeze clamp style 90° conduit elbow
- Use to connect flexible metallic conduit to a steel outlet box or other metal enclosure



**NEW**



PART #	DESCRIPTION	UNIT ORDER	INN/MAS	PACK	LIST
99013	1/2" Conduit Elbow	1	25/250	BULK	<b>1.94</b>

### CEILING LAMP HOLDER

- Porcelain keyless fixture
- Accepts medium-base bulb
- Aluminum socket
- Screw terminals



PART #	DESCRIPTION	UNIT ORDER	INN/MAS	PACK	LIST
59409	White	28	-/28	BAG	<b>4.76</b>

### CEILING LAMP HOLDER WITH PULL CHAIN

- Accepts one medium-base bulb
- Removable interior
- 3' Cord



PART #	DESCRIPTION	UNIT ORDER	INN/MAS	PACK	LIST
59412	With Receptacle & Pull Chain	20	-/20	BAG	<b>9.52</b>
59411	With Pull Chain	20	-/20	BAG	<b>6.70</b>

### NYLON TIES

- White
- Sold & priced per bag of 100



PART #	DESCRIPTION	UNIT ORDER	INN/MAS	PACK	LIST
50153	7" - 48 lb. Strength Bag of 100	1	-/10	BAG	<b>3.51</b>
50155	11" - 48 lb. Strength Bag of 100	1	-/10	BAG	<b>8.07</b>
50157	14" - 48 lb. Strength Bag of 100	1	-/10	BAG	<b>5.67</b>

### NYLON TIES

- Black
- 48 lb tensile strength
- Sold & priced per bag of 100



PART #	DESCRIPTION	UNIT ORDER	INN/MAS	PACK	LIST
50160	7" - Bag of 100	1	-/10	BAG	<b>3.16</b>

### PLASTIC WIRE NUTS

- Plastic
- 100 per bag



PART #	DESCRIPTION	UNIT ORDER	INN/MAS	PACK	LIST
61302	Blue Wire Nut #72B 14-22 Gauge	1	-/100	BAG	<b>6.93</b>
61303	Orange Wire Nut #73B 14-22 Gauge	1	-/100	BAG	<b>9.21</b>
61304	Yellow Wire Nut #74B 12-18 Gauge	1	-/70	BAG	<b>12.66</b>
61305	Red Wire Nut #76B 10-18 Gauge	1	-/45	BAG	<b>19.27</b>

### APPLIANCE EXTENSION CORD

- 14-3 SPT 3-wire/rated 15 Amps at 120V
- UL listed for refrigerators, microwaves and small room air conditioners
- 14-Gauge wire with ground



PART #	DESCRIPTION	UNIT ORDER	INN/MAS	PACK	LIST
60627	3'	1	-/50	CARD	<b>6.99</b>
60628	6'	1	-/50	CARD	<b>8.98</b>
60629	10'	1	-/50	CARD	<b>12.23</b>

Supply Connectors

Stop Valves

Water Heater

Gas Connectors

Water Filtration

Sinks/Faucets

Tubular/Drainage

Faucet Repair

Bath Accessories

Pipe Fittings/Repair

Valves

Cements/Sealants

Tools/Safety

Toilet Repair

Appliance/HVAC

Hardware

Electrical

Index

## Electrical Supplies

### YELLOW EXTENSION CORD WITH INDICATOR LIGHT

**NEW**

- High-visibility, contractor-grade
- Indicator light lets you see when the power is on
- Resists water, oil, abrasion and corrosion
- 12/3 SJTOW / 15A / 125V / 1875W



PART #	DESCRIPTION	UNIT ORDER	INN/MAS	PACK	LIST
60986	25'	1	-/8	SLEEVE	36.35
60988	50'	1	-/5	SLEEVE	64.15

### YELLOW TRIPLE-TAP EXTENSION CORD ADAPTER WITH INDICATOR LIGHT

**NEW**

- High-visibility, contractor-grade
- Heavy-duty lighted triple-outlet lets you see when the power is on
- Resists water, oil, abrasion and corrosion
- 12/3 SJTOW / 15A / 125V / 1875W



PART #	DESCRIPTION	UNIT ORDER	INN/MAS	PACK	LIST
60992	2'	1	-/8	SLEEVE	11.26

### YELLOW TRIPLE-TAP EXTENSION CORD WITH INDICATOR LIGHT

**NEW**

- High-visibility, contractor-grade
- Heavy-duty lighted triple-outlet lets you see when the power is on
- Resists water, oil, abrasion and corrosion
- 12/3 SJTOW / 15A / 125V / 1875W



PART #	DESCRIPTION	UNIT ORDER	INN/MAS	PACK	LIST
60990	50'	1	-/5	SLEEVE	71.14

### ALL-WEATHER EXTENSION CORD WITH INDICATOR LIGHT

**NEW**

- Flexibility and performance in extreme weather conditions to -58° F
- Indicator light lets you see when the power is on
- Resists water, oil, abrasion and corrosion
- 14/3 SJEOW / 15A / 125V / 1875W



PART #	DESCRIPTION	UNIT ORDER	INN/MAS	PACK	LIST
60994	25'	1	-/8	SLEEVE	36.92
60996	50'	1	-/8	SLEEVE	64.15



# ALPHABETIC INDEX

## #

1/4-Turn Stop Valves ..... 104

## A

A/C Disconnects and Fittings ..... 298  
 Abrasive Cloths ..... 227  
 ABS Cement ..... 229 - 230  
 ABS DWV Pipe Fittings ..... 160 - 163  
 Access Panels ..... 143 - 144  
 Acid Brush ..... 226  
 Acrylic Caulk ..... 235  
 Acrylic Latex Caulk ..... 235, 237  
 Acrylic Latex Silicone Caulk ..... 237

### Adapters:

ABS DWV Fittings ..... 162 - 163  
 Add-An-Outlet Adapter ..... 22  
 Ball Joint Shower Arm ..... 150  
 Brass Tubular ..... 90  
 Compression Fittings ..... 23, 189 - 190  
 Copper Press Fittings ..... 171  
 Copper Pressure Fittings ..... 169  
 CPVC Fittings ..... 187 - 188  
 Downspout ..... 158 - 159  
 Drain - Tub ..... 107  
 Dryer Duct Fittings ..... 287 - 288  
 Extension Cord ..... 316

### F1807 PEX Fittings:

Brass ..... 180 - 181  
 Polymer ..... 178

### F1960 PEX Fittings:

Brass ..... 182 - 183  
 Flare Fittings ..... 46, 191  
 Garden Hose ..... 113, 306 - 307  
 Hose-To-Pipe ..... 306 - 307  
 Plastic PP Tubular ..... 95

### Push-Fit Fittings:

Brass ..... 173  
 Plastic ..... 174  
 Twistloc Plastic ..... 176  
 PVC DWV Fittings ..... 154 - 155  
 PVC Schedule 40 Pressure Fittings ..... 164  
 Sewer And Drain Fittings ..... 156, 158 - 159  
 Steam Dryer ..... 278

Add-An-Outlet Adapter ..... 22  
 Add-An-Outlet Valve - Push-Fit Fittings - Twistloc Plastic ..... 53, 177  
 Add-On Shower Parts ..... 137 - 138  
 Add-On Shower Units ..... 137 - 138  
 Adhesive - Beats The Nail® All-Purpose ..... 238  
 Adhesive Sealant ..... 236 - 237  
 Aerators ..... 113  
 Air Filter Grille ..... 290  
 Air Gaps ..... 84  
 Air Hose - High-Pressure ..... 206  
 Air Registers ..... 289 - 291  
 Air Valves ..... 221 - 222  
 Air Vents ..... 212  
 Aluminum Filters - Range ..... 284  
 Aluminum Foil Tape ..... 233  
 Angle Iron Corner Brace ..... 304  
 Anode Rod ..... 36  
 Anti-Scald Faucet Cartridge ..... 125 - 126  
 Anti-Scald Pressure Balance Shower Valve ..... 62  
 Anti-Siphon Fill Valve - Toilet Tank ..... 259  
 Anti-Siphon Vacuum Breaker - Hose Bibb ..... 220  
 Anti-Vibration Pads ..... 278  
 Apcom Thermostats ..... 35  
 Appliance Anti-Vibration Pads ..... 278

Appliance Brush Set ..... 285  
 Appliance Connectors ..... 267 - 279  
 Appliance Extension Cord ..... 280, 315

### Appliance Installation Kits:

Dishwasher ..... 271  
 Dryer ..... 277 - 278  
 Ice Maker ..... 267 - 268  
 Range ..... 279  
 Appliance Power Cords ..... 83, 272, 279 - 280  
 Appliance Receptacles ..... 280 - 281  
 Appliance Supplies ..... 267 - 285  
 Arm - Toilet Tank ..... 263 - 264  
 Auger - Urinal ..... 244  
 Automotive Heater Hose ..... 206

## B

Backwater Valve ..... 102  
 Balancing Spool - Shower ..... 128  
 Ball Control - Faucet ..... 125  
 Ball Crank And Nut ..... 111

### Ball Valves:

Brass ..... 173, 215 - 216  
 Compression Fittings ..... 215  
 Copper Press Connection ..... 171  
 CPVC ..... 188, 217  
 F1807 PEX Fittings - Brass ..... 216  
 F1960 PEX Fittings - Brass ..... 216  
 Flare Fittings ..... 46, 222  
 Gas ..... 46, 222  
 Push-Fit Fittings - Brass ..... 173, 216  
 Schedule 40 PVC ..... 217

Ballcock ..... 260  
 Ballcock Parts ..... 262  
 Bar Faucet ..... 73  
 Bar Sink ..... 55  
 Barrier Flagging Tape ..... 308  
 Basin Legs - Wall-Mount ..... 143  
 Basin Locknut ..... 86, 112  
 Basin Rosette ..... 112  
 Basin Wrench ..... 241  
 Basket Strainer ..... 87  
 Basket Strainer Basin Locknut ..... 86, 112  
 Basket Strainer Wrench ..... 242  
 Bath Drain Assembly ..... 106  
 Bath Drain Parts ..... 106 - 107  
 Bath Drain Stopper ..... 107 - 108  
 Bath Drain Strainer ..... 107  
 Bath Drain Strainer Body ..... 106 - 107  
 Bath Overflow Face Plate ..... 109  
 Bath Overflow Face Plate Parts ..... 110  
 Bath Pop-Up And Cam Linkage Stopper ..... 108  
 Bath Waste Drain Kit ..... 102 - 105  
 Bath Waste Parts ..... 105  
 Bathcock - Add-On Shower ..... 137  
 Bathcock Ground-Joint Couplings ..... 137  
 Bathcock-Type Add-On Shower Unit ..... 137  
 Bathroom Accessories ..... 137 - 150  
 Bathroom Faucets ..... 56 - 61, 63, 66 - 67, 70 - 71, 76 - 77  
 Bathroom Sets ..... 142 - 143  
 Bathroom Sink ..... 54  
 Bathroom Sink Drain Assembly ..... 96 - 97  
 Bathroom Sink Hanger ..... 143  
 Bathroom Sink Legs - Wall-Mount ..... 143  
 Bathroom Trap-Vent P-Trap - Plastic PP Tubular ..... 91  
 Batteries ..... 239  
 Beam Clamp - Pipe Hanger ..... 210  
 Beam Connector - Pipe Hanger ..... 210  
 Beats The Nail® All-Purpose Construction Adhesive ..... 238  
 Bell Flange ..... 24

# ALPHABETIC INDEX

## B

### Bell Reducers:

Black Malleable Iron Fittings.....	197
Galvanized Malleable Iron Fittings.....	193
Bend Support - PEX.....	184
Bend Support With Nail Plate - PEX.....	184
Bent Nose Garden Valves.....	218
Bibb Screw - Faucet.....	115
Bibb Seat - Faucet.....	132
Bibb Washer - Faucet.....	116
Bifold And Bypass Cabinet Door Knob.....	305
Bigfoot Toilet Cover Plate.....	252
Bilge Discharge Hose.....	205
Black Malleable Iron Pipe Fittings.....	196 - 200
Boiler Drain.....	220
Boiler Feed Valve - Pressure Reducing.....	215
Bolt Cap - Toilet Bowl.....	248

### Bolts:

Closet.....	248
Toilet Seat.....	248
Toilet Tank-To-Bowl.....	249
Bonnet And Stem Packing.....	117
Boots - Rubber.....	246
Brace - Angle Iron Corner.....	304

### Brackets:

Dishwasher Mounting.....	273
Handheld Shower.....	148
Handrail.....	305
PEX L-Bend - Plastic.....	184
Pipe Hanger Support.....	211
Braided Vinyl Tubing.....	204 - 205
Brazing Rods.....	225
Breakaway Screw - Knob And Pull.....	305
Breaker Bar.....	242
Broiler Pan.....	283

### Brushes:

Acid.....	226
Appliance Cleaning.....	285
Copper Fitting Cleaning.....	226
Paint.....	308
Tube Cleaning.....	226
Bubbler Faucet.....	78
Burner Torch - MAPP/Propane Pencil Tip.....	227

### Bushings:

ABS DWV Fittings.....	163
Black Malleable Iron Fittings.....	198
Copper Pressure Fittings.....	169
CPVC Fittings.....	188
Galvanized Malleable Iron Fittings.....	194
Iron Pipe Fittings - Brass.....	191
PVC DWV Fittings.....	155
PVC Schedule 40 Pressure Fittings.....	165
Sewer And Drain Fittings.....	159

## C

Cabinet And Drawer Knobs.....	305
Cabinet And Drawer Pulls.....	140, 305
Cabinet Door Hinges.....	302
Cabinet Hardware.....	304 - 305
Cable And Telephone Accessories.....	313 - 314
Cable Saw.....	243
Caddy - Nipple.....	200
Cam - Faucet.....	116
Cam Linkage Tub Stopper.....	108
Can Opener - Cements And Sealants.....	232
Canvas Gloves.....	245

### Caps:

ABS DWV Fittings.....	163
Compression Fittings.....	23, 190
Copper Press Fittings.....	171

Copper Pressure Fittings.....	169
CPVC Fittings.....	188
Dryer Vent Roof.....	287
Dryer Vent Wall.....	287
Flare Fittings.....	191
Galvanized Malleable Iron Fittings.....	195
Garden Hose End.....	307
Iron Pipe Fittings - Brass.....	192

### Push-Fit Fittings:

Brass.....	173
Plastic.....	175
Twistloc Plastic.....	176
PVC DWV Fittings.....	155
PVC Schedule 40 Pressure Fittings.....	165
Sewer And Drain Fittings.....	159
Toilet Bowl Bolt.....	248
Cap And Plunger With Seat.....	262
Cap Assembly - Faucet.....	116
Cap Dauber - Cements And Sealants.....	232
Capacitor/Relay Hard Start.....	293
Capacitors.....	291 - 292
Carbon Block Water Filter.....	47 - 50
Carbon Filter - Range.....	284
Cartridge - Faucet.....	125 - 132
Cartridge Remover.....	242
Caulk.....	235 - 238
Caulk Gun.....	238, 308
Caulk Remover.....	238
Caustic Drain Opener.....	244
Caution Tape.....	308
Ceiling Air Register.....	290
Ceiling Diffuser.....	287, 290
Ceiling Fan Accessories.....	313
Ceiling Lamp Holder.....	315

### Cements:

ABS.....	229 - 230
CPVC.....	229 - 230
Multi-Purpose.....	230
PVC.....	228 - 230
Roof Flashing.....	211, 232
Cement Primer.....	230 - 232
Cement Primer-Cleaner.....	231
Cement, Primer, And Cleaner Accessories.....	232

### Center Outlets:

Brass Tubular.....	88
Plastic PP Tubular.....	93
Center Outlet Tee - Plastic PP Tubular.....	93
Chain Door Lock.....	301

### Check Valves:

In-Line.....	217
Sump Pump.....	213
Swing.....	217
Tri-Check PVC.....	214
Chloramine Carbon Block Water Filter.....	48 - 50
Chlorine Carbon Block Water Filter.....	48 - 50
Chlorine Taste And Odor Carbon Block Water Filter.....	48 - 50
Chrome Nipple.....	23
Clamp Ratchet Tool - PEX.....	184

### Clamps:

Pipe Riser.....	209
Dryer Duct.....	288
Hose.....	206 - 207
PEX - Steel.....	181
Pipe.....	208 - 210
Cleaner - Pipe.....	230 - 232
Cleaner Wipes - Hand.....	232
Cleaner, Primer And Cement Accessories.....	232
Cleaner-Primer - Cement.....	231

### Cleaning Brushes:

Copper Fittings.....	226
Tube.....	226
Cleanout.....	101 - 102
Cleanout Cover Plate - Bathroom Accessories.....	143

### Cleanout Plugs:

# ALPHABETIC INDEX

ABS DWV Fittings .....	162	PVC Schedule 40 Pressure Fittings.....	163
Brass Fittings.....	101	Sewer And Drain Fittings .....	156
PVC DWV Fittings.....	154	<b>Covers:</b>	
<b>Cleanout Tees:</b>		Drain .....	101
ABS DWV Fittings .....	162	Faucet.....	117
PVC DWV Fittings.....	154	Faucet Hole .....	115, 143
Sewer And Drain Fittings .....	158	Outdoor Outlet And Switch.....	313
Clevis Pipe Hanger .....	210	Shoe .....	246
Clip - Mirror .....	140	Toilet Tank .....	247
Closet And Wardrobe Hardware .....	304	<b>Cover Plates:</b>	
Closet Bolts .....	248	Blank - Electrical .....	313
Closet Flanges.....	251 - 254	Cleanout - Bathroom Accessories.....	143
Closet Flange Extension Kit.....	251	Outlet .....	311 - 312
Closet Rod Accessories.....	304	Smoke Detector .....	313
Closet Screws .....	248	Switch - Electrical .....	311 - 313
Closet Spud.....	249	Toilet .....	252
Closet Spud Wrench.....	241 - 242	Coveralls.....	246
Collar - Rain And Repair Roof Flashing .....	212	CPVC Cement .....	229 - 230
Collar - Vent Stack Flashing Repair .....	212	CPVC Pipe .....	185
Combination Crimp Tool - PEX .....	183	CPVC Pipe Fittings .....	185 - 188, 217
<b>Combo Wyes:</b>		Crimp Ring Shear Tool - PEX.....	183
ABS DWV Fittings .....	161	Crimp Rings - PEX - Copper .....	181
PVC DWV Fittings.....	153	Crimp Tool - PEX.....	183
Commercial Bathroom Accessories .....	144	Cross - Galvanized Malleable Iron Fittings .....	193
Commercial Faucet Parts.....	136	Crystal Caustic Drain Opener.....	244
Commercial Grab Bar.....	144	Cup And Toothbrush Holder .....	141 - 142
Commercial Toilet Paper Holder .....	144	<b>Cutters:</b>	
Compression Pipe Fittings - Brass.....	23, 189 - 190, 215, 273	Pipe .....	243
Compression Pipe Repair Couplings .....	200 - 201	Tubing.....	240
Condensate P-Trap - PVC Schedule 40 Pressure Fittings.....	165, 298	Cutting Oil .....	200, 235
Condensate Removal Pump.....	298	<b>D</b>	
Condensate Running Trap - PVC Schedule 40 Pressure Fittings .....	165, 298	Dark Cutting Oil.....	200, 235
Conduit Elbow .....	315	Dauber - Cements And Sealants .....	232
Conduit Connector .....	314 - 315	Deadbolts.....	299 - 300
Construction Adhesive - Beats The Nail® All-Purpose.....	238	Decreaser - Dryer Duct Fittings .....	287
Contactors.....	293	Deep Techno Test Cap.....	203
Continuity Tester .....	34	Defrost Timer.....	279
Copper Press Fittings.....	169 - 171	Dehumidifier/Utility Drain Hose .....	277
Copper Pressure Fittings.....	166 - 169	Demount Clip - Push-Fit Fittings.....	174
Copper Tubing.....	169	Dewatering Pump .....	213
<b>Cords:</b>		Diagonal Pliers .....	239
Garbage Disposal .....	83, 272	Dial Thermometer - Pocket .....	296
Dishwasher.....	272	Diaphragm - Urinal Flush Valve.....	265
Dryer .....	280	Dielectric Nipple .....	37
Extension.....	280, 315 - 316	Dielectric Union .....	37
Range .....	279 - 280	<b>Diffusers:</b>	
Telephone.....	314	Ceiling.....	287, 290
Corner Brace - Angle Iron .....	304	Floor .....	289
Cotton Canvas Gloves .....	245	Dip Tube .....	36
Cotton Jersey Gloves.....	245	<b>Discharge Hoses:</b>	
Countersunk Plug - Sewer And Drain Fittings.....	159	Bilge .....	205
<b>Couplings:</b>		Dishwasher.....	271 - 272
ABS DWV Fittings .....	160	Flat .....	205
Bathcock Ground-Joint .....	137	Utility/Dehumidifier .....	277
Black Malleable Iron Fittings.....	196	Washing Machine .....	276 - 277
Brass Tubular.....	90	Dishwasher Connectors.....	269 - 271
Compression Fittings.....	200 - 201	Dishwasher Drain Hose.....	271 - 272
Copper Press Fittings.....	169 - 170	Dishwasher Elbow - Compression Fittings.....	189, 273
Copper Pressure Fittings.....	166	Dishwasher Hot Water Drain Hose.....	83, 272
CPVC Fittings.....	185	Dishwasher Installation Kits .....	271
Drain - Cast Copper Pressure Fittings.....	166	Dishwasher Installation Parts.....	273
<b>F1807 PEX Fittings:</b>		Dishwasher Mounting Bracket.....	273
Brass.....	179	Dishwasher Pan .....	273
Polymer .....	178	Dishwasher Power Cord .....	272
<b>F1960 PEX Fittings:</b>		<b>Dishwasher Tailpieces:</b>	
Brass.....	181	Brass Tubular.....	89
Polymer .....	178	Plastic PP Tubular.....	93
Flexible Rubber Pipe Fittings.....	201 - 203	Dishwasher Wye - ABS DWV Fittings.....	273
Galvanized Malleable Iron Fittings .....	192	Dispenser - Paper Towel .....	144
Plastic PP Tubular .....	95	<b>Display Racks:</b>	
<b>Push-Fit Fittings:</b>		Faucets.....	80
Brass.....	172		
Plastic .....	174		
PVC DWV Fittings.....	151		

# ALPHABETIC INDEX

## D

Water Heater Connectors .....	2	Drain Kit - Bath Waste .....	102 - 105
Water Supply Connectors .....	2	Drain Opener .....	244
Disposals .....	81	<b>Drain Pans:</b>	
Disposal Accessories .....	82 - 83	Dishwasher .....	273
Disposal Connector .....	83	Washing Machine .....	277
Disposal Drain Adapter - Plastic PP Tubular .....	94	Water Heater .....	38
Disposal Elbow - Plastic PP Tubular .....	94	Drain Pan Float Switch .....	294
Disposal Kit - Plastic PP Tubular .....	93	Drain Parts - Tub .....	107
Disposal Power Cord .....	83, 272	<b>Drain Stoppers:</b>	
Disposal Wrench .....	241	Disposal .....	82 - 83
Diverter Assembly - Faucet .....	127	Pop-Up Sink .....	111 - 112
Diverter Bathcock - Add-On Shower .....	137	Sink .....	87
Diverter Spout .....	98 - 99	Tub .....	107 - 108
Diverter Spout - Add-On Shower .....	138	<b>Drain Strainers:</b>	
Diverter Spout Reducing Face Bushing .....	99	Disposal .....	82
Diverter Washer - Faucet .....	117	In-Line .....	101
Door And Window Hardware .....	301 - 304	Shower .....	101
Door And Window Locks .....	301	Sink .....	84 - 87
Door Hinges .....	302	Tub .....	107
<b>Door Holders:</b>		Drain Strainer Body - Tub .....	106 - 107
Kick-Down .....	303	Drain Trap - Floor .....	102
Wedge .....	303	Drain Trap Seal .....	102
Door Knobs And Handles .....	299 - 300	Drain Valve - Water Heater .....	37, 221
Door Knocker With Viewer .....	301	Drain Water Sensor .....	295
Door Peephole .....	301	Drawer And Cabinet Knob .....	305
Door Pull - Closet .....	304	Drawer And Cabinet Pulls .....	140, 305
<b>Door Security Locks:</b>		Drawer Double Roller Catch .....	304
Chain .....	301	Drawer Magnetic Catch .....	304
Swing .....	301	Drawer Slide .....	304
Door Stop .....	302 - 303	Driers .....	295 - 296
Door Strike Plate .....	300	Drill Pump .....	214
Door Viewer .....	301	Drinking Fountain Faucet .....	78
Double Elbow - PVC DWV Fittings .....	152	Drinking Water Faucet .....	51, 73
<b>Double Fixture Tees:</b>		Driving Gloves - Leather .....	246
ABS DWV Fittings .....	161	<b>Drop-Ear Elbows:</b>	
PVC DWV Fittings .....	153	Cast Copper Pressure Fittings .....	167
Double Offset - Brass Tubular .....	90	CPVC Fittings .....	186
Double Roller Catch - Drawer .....	304	F1807 PEX Fittings - Brass .....	180
<b>Double Sanitary Tees:</b>		F1960 PEX Fittings - Brass .....	182
ABS DWV Fittings .....	162	Iron Pipe Fittings - Brass .....	191
PVC DWV Fittings .....	153	<b>Push-Fit Fittings:</b>	
Double Wye - PVC DWV Fittings .....	153	Brass .....	172
<b>Double-End Extension Tubes:</b>		Twistloc Plastic .....	176
Brass Tubular .....	89	Drop-In Sink .....	54 - 55
Plastic PP Tubular .....	94	Drum Trap Plug Wrench .....	242
<b>Double-End Flanged Tailpieces:</b>		Dryer Anti-Vibration Pads .....	278
Brass Tubular .....	90	Dryer Connectors .....	277 - 278
Plastic PP Tubular .....	94	Dryer Duct .....	285 - 289
Downspout Adapter .....	158 - 159	Dryer Duct Clamps .....	288
Draft Blocker - Dryer Vent .....	289	Dryer Duct Fittings .....	287 - 289
<b>Drains:</b>		Dryer Duct Kits .....	286
Boiler .....	220	Dryer Installation Parts .....	278, 280 - 281
General-Purpose .....	100 - 101	Dryer Power Cord .....	280
Lavatory Sink .....	96 - 97	Dryer Receptacle .....	281
Shower .....	99 - 100	Dryer Vent Draft Blocker .....	289
Tub .....	106	Dryer Vent Hood .....	288 - 289
Drain And Trap Connector - Flexible Rubber Pipe Fittings .....	202	Dryer Vent Hood Guard .....	288
Drain Cleaning .....	244 - 245	Dryer Vent Hood Louver .....	288
Drain Connector - Flexible Rubber Pipe Fittings .....	202	Dryer Vent Kit - Indoor .....	286
Drain Coupling - Cast Copper Pressure Fittings .....	166	Dryer Vent Outlet Box .....	289
Drain Cover - Floor .....	101	Dryer Vent Roof Cap .....	287
Drain Fittings - Shower .....	101 - 102	Dryer Vent Wall Cap .....	287
Drain Flush .....	245	Dryer Vents And Accessories .....	285 - 289
Drain Gate .....	101, 159	Duct - Dryer .....	285 - 289
Drain Hook - Washing Machine - Gooseneck .....	277	Duct Clamps - Dryer .....	288
<b>Drain Hoses:</b>		Duct Fittings - Dryer .....	287 - 289
Bilge .....	205	Duct Kits - Dryer .....	286
Dishwasher .....	271 - 272	Duct Sealant .....	297
Flat .....	205	Duct Tape .....	233, 297
Utility/Dehumidifier .....	277	Dumbbell Wrench .....	241
Washing Machine .....	276 - 277	Dust And Pollen Mask .....	308

# ALPHABETIC INDEX

## E

Eared Tube Strap - Copper .....	184
Earthquake Strap - Water Heater .....	38
Elastomer Toilet Bowl Gasket .....	250
Elastomeric Foam Tube Pipe Insulation .....	213, 296
Elastomeric Insulation Tape .....	213

### Elbows:

A/C Fittings .....	298
ABS DWV Fittings .....	160 - 161
Black Malleable Iron Fittings .....	197
Brass Tubular .....	90
Cast Copper Pressure Fittings .....	167
Compression Fittings .....	189, 273
Conduit .....	315
Copper Press Fittings .....	170
Copper Pressure Fittings .....	166 - 167
CPVC Fittings .....	185 - 187
Dryer Duct Fittings .....	287, 289

### F1807 PEX Fittings:

Brass .....	179 - 180
Polymer .....	178

### F1960 PEX Fittings:

Brass .....	181 - 182
Polymer .....	179
Flexible Rubber Pipe Fittings .....	202
Galvanized Malleable Iron Fittings .....	193
Plastic PP Tubular .....	95

### Push-Fit Fittings:

Brass .....	172
Plastic .....	53, 174
Twistloc Plastic .....	175
PVC DWV Fittings .....	151 - 152
PVC Schedule 40 Pressure Fittings .....	163 - 164
Romex .....	315
Sewer And Drain Fittings .....	157
Shower Stall .....	150
Stub-Out .....	184 - 185
Washing Machine .....	277
Electrical .....	309 - 316
Electrical Connectors .....	314 - 315
Electrical Continuity Tester .....	34
Electrical Tape .....	233

### Elements:

Range .....	281 - 282
Water Heater .....	34
Element Adapter Kit - Water Heater .....	34
Element Gasket Kit - Water Heater .....	34
Element Thermostat - Water Heater .....	35
Element Wrench - Water Heater .....	242
Emery Cloth .....	227

### End Outlets:

Brass Tubular .....	88
Plastic PP Tubular .....	92 - 93

### End Outlet Tees:

Brass Tubular .....	90
Plastic PP Tubular .....	93
Epoxy Putty .....	238

### Escutcheons:

Stop Valve .....	23 - 24
Tub And Shower .....	132 - 133
Escutcheon Nipple .....	135
Escutcheon Sleeve .....	134 - 135
Evaporative Cooler Float Valve Assembly .....	221
Expanding Foam Sealant .....	235
Expansion Ring - PEX .....	183
Extension Cord Adapter .....	316
Extension Cords .....	280, 315 - 316
Extension Hose - Washing Machine .....	276

### Extension Kits:

Dryer Duct Fittings .....	288
Toilet Flange .....	251

### Extension Tubes:

Brass Tubular .....	89
Plastic PP Tubular .....	94 - 95
Extractor Set - Faucet Seat .....	243

## F

### F1807 PEX Fittings:

Brass .....	179 - 181, 216
Copper .....	184-185
Polymer .....	178

### F1960 PEX Fittings:

Brass .....	181 - 183, 216
Copper .....	185
Polymer .....	178 - 179

### Face Plates:

Bath Overflow .....	109
Switch - Electrical .....	311 - 313
Fan Accessories - Ceiling .....	313
Fan Relay .....	294

### Faucets:

Bathroom Sink .....	56 - 61, 63, 66 - 67, 70 - 71, 76 - 77
Drinking Water .....	51, 73
Kitchen .....	56 - 61, 63 - 65, 69, 73, 75, 77
Laundry .....	73, 77
Specialty .....	78
Tub And Shower .....	56 - 58, 60, 62, 67, 71, 74
Wall-Mount .....	77
Water Fountain .....	78
Faucet Accessories .....	114 - 115
Faucet Aerator .....	113
Faucet Ball Control .....	125
Faucet Basin Rosette .....	112
Faucet Bibb Screw .....	115
Faucet Bibb Seat .....	132
Faucet Bibb Washer .....	116
Faucet Cam .....	116
Faucet Cap Assembly .....	116
Faucet Cartridge .....	125 - 132
Faucet Cover .....	117
Faucet Display Rack .....	80
Faucet Diverter Assembly .....	127
Faucet Diverter Washer .....	117
Faucet Flange .....	134
Faucet Handle .....	118 - 124
Faucet Handle Index Buttons .....	124 - 125
Faucet Handle Puller .....	243
Faucet Handle Repair Kit .....	116
Faucet Hole Cover .....	115, 143
Faucet Installation Kit .....	11
Faucet Installation Parts .....	112
Faucet Locknut .....	86, 112
Faucet Mounting Kit .....	112
Faucet O-Ring Kit .....	116
Faucet Repair .....	111 - 136
Faucet Repair Kit - Temptrol® .....	117
Faucet Replacement Parts .....	115 - 136
Faucet Reseater .....	243
Faucet Riser .....	10
Faucet Seat .....	132
Faucet Seat Extractor Set .....	243
Faucet Seat Wrench .....	243
Faucet Spout Repair Kit .....	116
Faucet Spring And Seal Kit .....	116
Faucet Stem .....	125 - 132
Faucet Temperature Control Lever .....	121
Faucet Volume Control Lever .....	121
Faucet Water Supply Connectors .....	2 - 11
Fill Hose - Washing Machine .....	273 - 276
Fill Valve Repair Parts .....	262
Fill Valves - Toilet Tank .....	258 - 260
<b>Filters:</b>	
Range .....	284
Water Filtration .....	47 - 50, 269

# ALPHABETIC INDEX

## F

### Filter Hose Washers:

Fill Valve Repair Parts .....	262
Fill Valves - Toilet Tank .....	258 - 260

### Filters:

Range .....	284
Water Filtration .....	47 - 50, 269

### Filter Hose Washers:

Garden .....	307
Washing Machine .....	277
Filter Housing .....	48 - 49
Filter Housing O-Ring .....	51
Filter Housing Parts .....	51
Fire Stop Sealant .....	238
Fitting Cleaning Brush .....	226

### Flanges:

Ceiling Fan .....	313
Faucet .....	134
Shower Arm .....	149
Shower Rod .....	139
Spanner .....	251
Toilet .....	251 - 254
Tub And Shower .....	133 - 134
Urinal .....	264
Flange Extension Kit - Toilet .....	251
Flange Nipple .....	135
Flange Nut - Tub And Shower .....	133
Flanged Pipe Hanger Plate .....	210

### Flanged Tailpieces:

Brass Tubular .....	89
Plastic PP Tubular .....	94 - 95
Flapper - Toilet Tank .....	255 - 258
Flare Pipe Fittings .....	46, 190 - 191, 222
Flaring Tool .....	240
Flashing - Roof .....	211 - 212
Flashing Cement - Roof .....	211, 232

### Flashing Repair Collars:

Roof .....	212
Vent Stack .....	212
Flat Discharge Hose .....	205
Flexible Rubber Pipe Fittings .....	201 - 203
Flexible Sealant .....	237
Flint Torch Lighter .....	227
Float Ball - Toilet Tank .....	260
Float Rod - Toilet Tank .....	260
Float Switches .....	294 - 295
Float Valve Assembly - Evaporative Cooler .....	221
Floor Air Register .....	289
Floor And Ceiling Plate .....	25
Floor And Shower Drain .....	100
Floor Diffuser .....	289
Floor Drain Trap - PVC .....	102
Flush Valve .....	259 - 261
Flush Valve Diaphragm - Urinal .....	265
Flush Valve Repair Parts .....	264 - 266
Flush Valve Seal Gasket .....	262 - 263
Flux - Solder .....	225 - 226
Foam Sealant .....	235
Foam Tube Pipe Insulation .....	213, 296
Foil Tape .....	233, 297
Foot Valve .....	215
Force Cup Toilet Plunger .....	244 - 245
Freezer Thermometer .....	269
Frost-Free Sill Cock .....	220

### Fuel Cylinders:

MAPP Gas .....	227
Propane .....	227
Fuel Hose .....	206

## G

Galvanized Malleable Iron Pipe Fittings .....	192 - 196
---	-----------

Garbage Disposal .....	81
Garbage Disposal Accessories .....	82 - 83
Garbage Disposal Connector .....	83
Garbage Disposal Power Cord .....	83, 272
Garbage Disposal Wrench .....	241
Garden And Lawn .....	305 - 307
Garden Hose Adapter .....	113, 306 - 307

### Garden Hose Connectors:

Swivel .....	307
Twin .....	306
Garden Hose End Cap .....	307
Garden Hose Filter Washer .....	307
Garden Hose Menders .....	307
Garden Hose Nozzle .....	306
Garden Hose Washer .....	307
Garden Valves .....	218
Gas Ball Valves .....	46, 222
Gas Connector .....	39 - 45
Gas Connector Fittings .....	46, 191
Gas Connector Valves .....	46, 222
Gas Fuel Cylinder - MAPP .....	227
Gas Leak Detector .....	234
Gas Outlet Box .....	46
Gas Pressure Test Gauge .....	224

### Gaskets:

Flush Valve .....	262 - 263
Mack .....	111
Overflow Face Plate .....	110
Sink Strainer .....	86
Toilet Bowl .....	249 - 250
Toilet Tank-To-Bowl .....	249
Tub Shoe .....	105

### Gauges:

PEX Go/No-Go .....	183
Test .....	224
General-Purpose Drain .....	100 - 101
Germicidal UV Light System .....	294
Glass Filler Faucet .....	51, 73
Glasses - Safety .....	245
Gloves .....	245 - 246
Go/No-Go Gauge - PEX .....	183
Goggles - Safety .....	245
Gooseneck Drain Hook - Washing Machine .....	277
Grab Bar - Commercial .....	144
Grab Bar And Soap Holder .....	142
Grease - Plumber's .....	234

### Grilles:

Return Air .....	291
Return Air Filter .....	290
Ground Fault Circuit Interrupters .....	309
Ground-Joint Couplings - Bathcock .....	137

### Guards:

Chain - Door .....	301
Dryer Vent Hood .....	288
Stud .....	207
Swing - Door .....	301

## H

Hacksaw - Junior .....	244
Hair Snare .....	87
Half Pipe Clamp .....	208
Halogen Work Light .....	314
Hammer Arrester .....	28
Hand Cleaner Wipes .....	232
Handheld Shower Bracket .....	148
Handheld Shower Hose .....	147 - 148
Handheld Shower Set .....	147 - 148
<b>Handles:</b>	
Cabinet And Drawer .....	140, 305
Door .....	299 - 300
Faucet .....	118 - 124
Sill Cock .....	223
Stop Valve .....	22

# ALPHABETIC INDEX

Valve - Other .....	223	Icemaker Installation Kit .....	267 - 268
Handle And Bibb Screw - Brass .....	115	Icemaker Outlet Box.....	26
Handle Puller - Faucet.....	243	Icemaker Water Filter .....	269
Handle Repair Kit - Faucet .....	116	Increaser - Dryer Duct Fittings.....	287
<b>Handle Screws:</b>		Index Buttons - Faucet Handle .....	124 - 125
Bibb Screw Faucet.....	115	Indoor Dryer Vent Kit.....	286
Cabinet And Drawer .....	305	In-Line Check Valve .....	217
Sill Cock.....	223	In-Line Drain Strainer.....	101
Stop Valve.....	22	In-Line Water Filter.....	269
Handrail Bracket.....	305	In-Line Water Sensor - Drain .....	295
<b>Hangers:</b>		<b>Installation Kits:</b>	
Bathroom Sink.....	143	Dishwasher.....	271
Pipe And Tube .....	207 - 211	Dryer .....	277 - 278
Hard Starts .....	293	Faucet .....	11
Hardware .....	299 - 308	Icemaker .....	267 - 268
Heat Trap Nipple .....	37	Push-Fit Fittings - Brass.....	173
Heater Hose - Automotive .....	206	Range.....	279
High Temp Red Silicone Sealant.....	236, 297 - 298	Toilet.....	11 - 12
High-Efficiency Washing Machine Fill Hose.....	274	Water Heater .....	30
High-Pressure Air Hose .....	206	<b>Installation Parts:</b>	
<b>Hinges:</b>		Dishwasher.....	273
Cabinet.....	302	Dryer .....	278, 280 - 281
Door.....	302	Faucet .....	112
Hood - Dryer Vent .....	288 - 289	Toilet.....	248 - 251, 264 - 266
Hood Guard - Dryer Vent .....	288	Washing Machine .....	28, 221, 277
Hood Louver - Dryer Vent .....	288	Insulating Suspension Clamp - Pipe .....	209
<b>Hooks:</b>		Insulation - Pipe .....	213, 296
Pipe And Tube .....	209 - 210	Insulation Kit - P-Trap And Riser.....	144
Robe .....	141, 143	Insulation Tape - Pipe.....	213
<b>Hoses:</b>		Insulator - Pipe .....	209
Air - High-Pressure .....	206	Iron Corner Brace - Angle .....	304
Automotive Heater .....	206	<b>Iron Pipe Fittings:</b>	
Bilge Discharge .....	205	Black Malleable .....	196 - 200
Discharge - Flat .....	205	Brass .....	191 - 192
Dishwasher - Drain .....	83, 271 - 272	Galvanized Malleable .....	192 - 196
Dryer - Steam .....	277 - 278	Isolation Valve Kit - Tankless Water Heater.....	36
Fuel .....	206		
Handheld Shower .....	147 - 148		
Kitchen Faucet Spray.....	114 - 115		
Pre-Rinse Faucet .....	136		
Spa.....	206		
Spa And Pool Vacuum .....	206		
Utility/Dehumidifier - Drain .....	277		
<b>Washing Machine:</b>			
Drain .....	276 - 277		
Extension .....	276		
Fill .....	273 - 276		
Hose Bibb .....	218 - 219		
Hose Bibb Anti-Siphon Vacuum Breaker .....	220		
Hose Bibb Key .....	222		
Hose Clamps.....	206 - 207		
<b>Hose Connectors - Garden:</b>			
Swivel.....	307		
Twin .....	306		
Hose End Cap - Garden .....	307		
<b>Hose Filter Washers:</b>			
Garden .....	307		
Washing Machine .....	277		
Hose Gripper - Flexible Rubber Pipe Fittings .....	202		
Hose Menders - Garden.....	307		
Hose Nozzle .....	306		
<b>Hose Washers:</b>			
Garden .....	307		
Washing Machine .....	277		
Hose-To-Pipe Adapters .....	306 - 307		
Hot Water Drain Hose - Dishwasher .....	83, 272		
Household Point-Of-Entry Water Filter Housing.....	48 - 49		
Household Point-Of-Entry Water Filtration Systems.....	48 - 49		
Hush Cushion.....	82		
HVAC.....	285 - 298		
Icemaker Connectors .....	267 - 269		

## J

<b>Jacks:</b>	
Cable.....	314
Telephone.....	313 - 314
<b>J-Bends:</b>	
Brass Tubular.....	88
Plastic PP Tubular .....	92, 95
Jersey Gloves.....	245
J-Hooks - Pipe And Tube Hanger .....	209
J-Trap - Flexible Rubber Pipe Fittings.....	202
Junior Hacksaw .....	244

## K

<b>Keys:</b>	
Hose Bibb .....	222
Log Lighter .....	223
Mailbox - Blank .....	300
Radiator Air Valve .....	222 - 223
Sill Cock.....	222
Water Meter.....	241
Keyed Radiator Air Valve .....	222
Kick-Down Door Holder .....	303
Kitchen Faucet .....	56 - 61, 63 - 65, 69, 73, 75, 77
Kitchen Faucet Side Sprayer.....	114 - 115
Kitchen Faucet Spout.....	136
Kitchen Faucet Spray Head.....	114 - 115
Kitchen Faucet Spray Hose .....	114 - 115
Kitchen Sink.....	54 - 55
Kitchen Trap-Vent P-Trap - Plastic PP Tubular.....	92
<b>Knobs:</b>	
Cabinet And Drawer .....	305
Door .....	299 - 300
Range .....	283

# ALPHABETIC INDEX

## K

Knob And Pull Breakaway Screw .....	305
Knocker With Viewer - Door .....	301

## L

Lamp Holder - Ceiling .....	315
Latex Caulk Remover .....	238
Latex Gloves .....	245
Latex Tubing .....	205
Laundry Faucet .....	73, 77
Laundry Tray Plug .....	86
Lavatory Faucet .....	56 - 61, 63, 66 - 67, 70 - 71, 76 - 77
Lavatory Sink .....	54
Lavatory Sink Drain Assembly .....	96 - 97
Lavatory Sink Hanger .....	143
Lavatory Sink Legs - Wall-Mount .....	143
Lavatory Trap-Vent P-Trap - Plastic PP Tubular .....	91
Lawn And Garden .....	305 - 307
L-Bend Bracket - PEX - Plastic .....	184
Leak Detector - Gas .....	234
Leather Gloves .....	245 - 246
Lever - Toilet Tank .....	263 - 264
Lift Wire - Toilet Tank .....	260
Light - Halogen Work .....	314
Light Switch - Wall .....	310 - 313
Light Switch Cover Plate - Blank .....	313
Light Switch Face Plate .....	311 - 313
Light System - UV .....	294
Lighter - Flint Torch .....	227
Line Driers .....	295
Line Sets .....	296
Line Tap Valve .....	296
Line Valve - CPVC .....	188
Lineman Pliers .....	239
Liner - Shower Pan .....	232
Linkage Assembly .....	108
Lint Trap .....	278
Liquid Drain Opener .....	244
Liquid Line Driers .....	295
Liquid-Tight Connectors - Nonmetallic .....	298

### Locks:

Locksets .....	299 - 300
Mailbox .....	300
Security Door Chain .....	301
Security Door Swing Bar .....	301
Sliding Door And Window .....	301
Locking Pliers .....	239

### Locknuts:

Basin .....	86, 112
Faucet .....	86, 112
Sink Strainer Basket .....	86, 112
Log Lighter Key .....	223
Long Nose Pliers .....	239
Loose Key Handle - Stop Valve .....	22
Lotion Dispenser .....	79
Louver - Dryer Vent Hood .....	288

## M

Mack Gasket .....	111
Magnetic Catch - Drawer .....	304
Mailbox Key - Blank .....	300
Mailbox Locks .....	300

### Malleable Iron Pipe Fittings:

Black .....	196 - 200
Galvanized .....	192 - 196
Manifold - F1807 PEX - Copper .....	185
MAPP Gas Fuel Cylinder .....	227
MAPP/Propane Pencil Tip Burner Torch .....	227
MAPP/Propane Self-Lighting Swivel Torch .....	227

Mask - Dust And Pollen .....	308
Masking Tape .....	308
Mechanical Test Plug .....	203 - 204
Menders - Garden Hose .....	307
Mesh Sand Cloth - Taramet .....	227
Meter And Valve Boxes .....	305 - 306
Micro Fuel Hose .....	206
Mini-Vent .....	212
Mirror Clips .....	140
Mirror Pulls .....	140
Motor Run Capacitors .....	291 - 292
Mounting Bracket - Dishwasher .....	273
Multifunctional Pipe Clamp .....	208
Multipurpose Cement .....	230
Multipurpose Foam Sealant .....	235
Multi-Turn Stop Valve .....	13 - 17

## N

Nail Plate .....	207
Needle Valves .....	221

### Nipples:

Black Malleable Iron Fittings .....	199 - 200
Chrome-Plated Brass .....	23
Dielectric .....	37
Escutcheon .....	135
Galvanized Malleable Iron Fittings .....	195 - 196
Heat Trap .....	37
Red Brass Fittings .....	192
Nipple Caddy .....	200

### Nipple Kits:

Black Malleable Iron Fittings .....	200
Galvanized Malleable Iron Fittings .....	196

Nitrile Gloves .....	245
No-Hub Coupling - Flexible Rubber Pipe Fittings .....	202
No-Hub Torque Wrench .....	204, 241
Nonmetallic Faucets .....	75 - 76
Nonmetallic Liquid-Tight Connectors .....	298
Nozzle - Garden Hose .....	306

### Nuts:

Compression Fittings .....	23, 190
Flare Fittings .....	191
Galvanized Malleable Iron Fittings .....	194
Supply Line .....	112

## O

### Oils:

Dark Cutting .....	200, 235
Zoom-Spout Oiler .....	235

O-Ring - Filter Housing .....	51
O-Ring Kit - Faucet .....	116
O-Ring Pick .....	242
O-Ring Scraper .....	242
Outdoor Outlet And Switch Covers .....	313

### Outlets:

Cable .....	314
Dryer .....	281
Electrical .....	309 - 310
Range .....	280 - 281
Telephone .....	313 - 314

### Outlet Boxes:

Dryer Vent .....	289
Gas .....	46
Icemaker .....	26
Steam Dryer .....	27
Washing Machine .....	26 - 27
Outlet Box Trim Plate .....	27
Outlet Cover - Electrical .....	313
Oven Range Bowl And Ring .....	282 - 283
Oven Range Broiler Pan .....	283
Oven Range Chrome Trim Ring .....	282 - 283
Oven Range Element .....	281 - 282



# ALPHABETIC INDEX

Oven Range Filter .....	284
Oven Range Installation Kits .....	279
Oven Range Knob Set .....	283
Oven Range Pan .....	283
Oven Range Parts .....	279 - 285
Oven Range Power Cord .....	279 - 280
Oven Range Receptacle .....	280 - 281
Oven Range Reflector Bowl .....	282 - 283
Oven Range Reflector Pan .....	282 - 283
Oven Thermometer .....	283
Overflow Face Plate .....	109
Overflow Face Plate Parts .....	110

## P

P.O. Plug And Closet Spud Wrench .....	242
Paint Brush .....	308
Paint Supplies .....	308

### Pans:

Broiler .....	283
Dishwasher .....	273
Oven Range .....	283
Washing Machine .....	277
Water Heater .....	38

Pan Liner - Shower .....	232
Paper Towel Dispenser .....	144
Paste - Solder .....	226
Peephole - Door .....	301
Pencil Tip Burner Torch - MAPP/Propane .....	227
Pencil Tip Torch - Propane .....	227
PEX Accessories .....	174, 181, 183 - 185
PEX And Plastic Pipe Cutter .....	243
PEX Bend Support .....	184
PEX Bend Support With Nail Plate .....	184
PEX Clamp Ratchet Tool .....	184
PEX Clamps - Steel .....	181
PEX Combination Crimp Tool .....	183
PEX Crimp Ring Shear Tool .....	183
PEX Crimp Rings - Copper .....	181
PEX Crimp Tool .....	183
PEX Expansion Ring .....	183
PEX F1807 Copper Stub-Out Elbow .....	184
PEX F1960 Copper Stub-Out Elbow .....	185

### PEX Fittings:

#### F1807:

Brass .....	179 - 181
Copper .....	184-185
Polymer .....	178

#### F1960:

Brass .....	181 - 183
Copper .....	185
Polymer .....	178 - 179

PEX Go/No-Go Gauge .....	183
PEX L-Bend Bracket - Plastic .....	184
PEX Pipe Stiffener .....	174
PEX Tools .....	183 - 184, 243
PEX Tubing .....	53, 177
Phone And Cable Accessories .....	313 - 314
Pick - O-Ring .....	242
Pick-Up Tool .....	242
Pipe - CPVC .....	185
Pipe And Tube Hangers .....	207 - 210
Pipe Cable Saw .....	243
Pipe Cement .....	228 - 230
Pipe Cement Primer .....	230 - 232
Pipe Cement Primer-Cleaner .....	231
Pipe Cement, Primer, And Cleaner Accessories .....	232
Pipe Clamps .....	208 - 210
Pipe Cleaner .....	230 - 232
Pipe Cutter .....	243
Pipe Dope .....	234
Pipe Fittings And Repair .....	151 - 214
Pipe Hanger Connector .....	210
Pipe Hanger Support Bracket .....	211

Pipe Insulation .....	213, 296
Pipe Insulator .....	209
Pipe Joint Compound .....	233
Pipe Repair Clamp .....	201
Pipe Repair Couplings .....	200 - 203
Pipe Saw .....	244
Pipe Sleeving .....	213
Pipe Stiffener - PEX .....	174
Pipe Thread Sealant .....	234
Pipe Thread Tape .....	232
Pipe Wrap Tape .....	233
Pipe Wrench .....	240
Plastic Flexible Tubular .....	95
Plastic PP Tubular .....	91 - 95
Plastic-Coated Pipe And Tube Hangers .....	208 - 209
Pliers .....	239

### Plugs - Fittings:

Black Malleable Iron Fittings .....	198
-------------------------------------	-----

#### F1807 PEX Fittings:

Brass .....	181
Polymer .....	178

#### F1960 PEX Fittings:

Brass .....	183
Polymer .....	179

Flare Fittings .....	191
Galvanized Malleable Iron Fittings .....	194
Iron Pipe Fittings - Brass .....	191 - 192
Sewer And Drain Fittings .....	159
Plug-In Range Element .....	281 - 282
Plumber's Grease .....	234
Plumber's Putty .....	233
Plumber's Socket Set .....	241
Plumbing Tools .....	183 - 184, 204, 241 - 244
Plunger .....	244 - 245
Pneumatic Test Plug .....	203
Pocket Dial Thermometer .....	296
Point-Of-Entry Water Filter Housing .....	48 - 49
Point-Of-Use Water Filter Housing .....	47 - 48
Pollen And Dust Mask .....	308
Polyethylene Tubing .....	205, 269
Pool And Spa Vacuum Hose .....	206
Pop-Up And Cam Linkage Tub Stopper .....	96 - 97
Pop-Up Sink Drain Assembly .....	96 - 97
Pop-Up Sink Drain Parts .....	111 - 112
Pop-Up Sink Drain Stopper .....	111 - 112
Potential Relay .....	294

### Power Cords:

Dishwasher .....	272
Dryer .....	280
Extension .....	280, 315 - 316
Garbage Disposal .....	83, 272
Range .....	279 - 280
Pre-Rinse Faucet Hose Assembly .....	136
Pre-Rinse Faucet Spray Valve Assembly .....	136
Pressure Balance Shower Valve .....	62
Pressure Reducing Boiler Feed Valve .....	215
Pressure Regulator .....	215
Pressure Relief Valve - Water Heater .....	35 - 36
Pressure Switch .....	215
Pressure Test Gauges .....	224
Pressure Valves .....	215
Primer - Cement .....	230 - 232
Primer, Cement And Cleaner Accessories .....	232
Primer-Cleaner - Cement .....	231

### Product Display Racks:

Faucets .....	80
Water Heater Connectors .....	2
Water Supply Connectors .....	2
Professional Faucet Reseater .....	243
Professional Hand Cleaner Wipes .....	232
Propane Fuel Cylinder .....	227
Propane Pencil Tip Torch .....	227
Propane/MAPP Pencil Tip Burner Torch .....	227
Propane/MAPP Self-Lighting Swivel Torch .....	227
Protective Gear .....	245 - 246, 308

# ALPHABETIC INDEX

## P

### P-Traps:

ABS DWV Fittings .....	163
Brass Tubular .....	88
Plastic PP Tubular .....	91 - 92
PVC DWV Fittings .....	156
PVC Schedule 40 Pressure Fittings .....	165, 298
P-Trap And Riser Insulation Kit .....	144

### Pulls:

Cabinet And Drawer .....	140, 305
Mirror .....	140
Pull And Knob Breakaway Screw .....	305
Pull-Chain Shower Valve .....	78
Pull-Down Kitchen Faucet Spray Head .....	114
Pull-Down Kitchen Faucet Spray Hose .....	114
Pull-Out Kitchen Faucet Spray Head .....	114
Pull-Out Kitchen Faucet Spray Hose .....	114 - 115
Pull-Out Sink Drain Assembly .....	96

### Pumps:

Condensate Removal .....	298
Drill .....	214
Sump .....	213
Tire .....	224
Pump Check Valve - Sump .....	213
Push-Button Drain Assembly .....	96

### Push-Fit Fittings:

Brass .....	53, 172 - 173, 216
Copper .....	184
Plastic .....	174 - 175
Twistloc Plastic .....	175 - 177
Push-Fit Fitting Accessories .....	174, 184

### Putties:

Plumber's .....	233
Stick-It Epoxy .....	238
PVC Cement .....	228 - 230
PVC DWV Pipe Fittings .....	151 - 156
PVC Schedule 40 Pressure Pipe Fittings .....	163 - 165
PVC Schedule 80 Pressure Pipe Fittings .....	165
PVC Water Connectors .....	2, 7 - 8

## R

R.O. Drinking Water Faucet .....	51
R.O. Membrane .....	47
R.O. Replacement Cartridges .....	47
R.O. Water Filtration System .....	47
Radiator Air Valve Key .....	222 - 223
Radiator Air Valves .....	221 - 222
Rain And Repair Roof Flashing Collar .....	212
Range Bowl And Ring .....	282 - 283
Range Broiler Pan .....	283
Range Chrome Trim Ring .....	282 - 283
Range Element .....	281 - 282
Range Filter .....	284
Range Installation Kits .....	279
Range Knob Set .....	283
Range Pan .....	283
Range Parts .....	279 - 285
Range Power Cord .....	279 - 280
Range Receptacle .....	280 - 281
Range Reflector Bowl .....	282 - 283
Range Reflector Pan .....	282 - 283
Ratchet Tool - PEX .....	184

### Receptacles:

Dryer .....	281
Electrical .....	309 - 310
Range .....	280 - 281
Receptacle And Switch Cover - Outdoor .....	313
Receptacle Wall Plate .....	311 - 312
Red Brass Fittings .....	192
Redi-Vent .....	212

### Reducers:

Copper Press Fittings .....	170
Copper Pressure Fittings .....	166
Reducing Face Bushing - Brass .....	99
Reflector Bowl - Range .....	282 - 283
Reflector Pan - Range .....	282 - 283
Refrigerator Thermometer .....	269
Registers - Air .....	289 - 291
Regulator - Pressure .....	215
Reinforced Braided Vinyl Tubing .....	204 - 205
Relay/Capacitor Hard Start .....	293
Relays .....	294
Relief Valve - Sewer .....	224
Repair Clamp - Pipe .....	201

### Repair Collars:

Roof Flashing .....	212
Vent Stack Flashing .....	212
Repair Couplings - Pipe .....	200 - 203

### Repair Kits:

Faucet Handle .....	116
Faucet Spout .....	116
Sill Cock Vacuum Breaker .....	223
Temprol® Faucet .....	117
Repair Trap - Plastic PP Tubular .....	92
Reseater - Faucet .....	243
Return Air Filter Grille .....	290
Return Air Grille .....	291
Ring Pipe Hanger .....	210

### Risers:

Add-On Shower Unit .....	137 - 138
Faucet Supply .....	10
Toilet Supply .....	10
Riser And P-Trap Insulation Kit .....	144
Riser Clamp - Pipe .....	209
Robe Hook .....	141, 143
Roller Catch - Drawer .....	304
Romex Connector .....	314 - 315
Romex Elbow .....	315
Roof Cap - Dryer Vent .....	287
Roof Flashing .....	211 - 212
Roof Flashing Cement .....	211, 232
Roof Flashing Collar .....	212
RTV Silicone Sealant .....	235, 297
Rubber Boots .....	246
Rubber Pipe Fittings - Flexible .....	201 - 203
Rubber Spud Washer .....	249
Running Trap - Condensate - PVC Schedule 40 Pressure Fittings ..	165, 298
Runoff Tube .....	36

## S

Saddle Valve - Self-Piercing .....	221, 269
Safety Glasses .....	245
Safety Goggles .....	245
Safety Plate .....	207
Safety Strap - Water Heater .....	37 - 38
Sand Cloths .....	227

### Sanitary Tees:

ABS DWV Fittings .....	162
PVC DWV Fittings .....	153 - 154
Sewer And Drain Fittings .....	158
Sash Window Lock .....	301

### Saws:

Cable .....	243
Junior Hacksaw .....	244
Pipe .....	244
Scraper - O-Ring .....	242
Screen - Termination .....	212

### Screws:

Cabinet And Drawer Knobs And Pulls .....	305
Handle And Bibb .....	115
Overflow Face Plate .....	110
Sill Cock Handle .....	223

# ALPHABETIC INDEX

Stop Valve Handle .....	22	Sleeving - Pipe.....	213
Toilet .....	248	Sliding Door And Window Locks .....	301
Screwdriver.....	240	<b>Slip-Joint Nuts:</b>	
Sealants .....	233 - 238, 297 - 298	Brass Tubular.....	91
Seat - Faucet .....	132	PVC .....	91
Seat - Toilet .....	247	Slip-Joint Pliers .....	239
Seat Extractor Set - Faucet .....	243	Slip-Joint Washer .....	91
Seat Wrench - Faucet .....	243	Smoke Detector Cover Plate .....	313
Security Door Lock .....	301	Snap-In Cleanout .....	101
Sediment Water Filter .....	47 - 50	Soap Dish .....	141 - 142
Self-Closing Shower Valve .....	78	Soap Dispenser .....	79, 144
Self-Closing Stop Valve .....	78	Soap Holder And Grab Bar .....	142
Self-Lighting Swivel Torch - MAPP/Propane .....	227	Socket Set - Plumber's.....	241
Self-Piercing Saddle Valve .....	221, 269	Solder .....	225
Sensor - Drain Water .....	295	Solder Accessories .....	225 - 227
Service Faucets .....	77	Solder Flux .....	225 - 226
Service Valve Kit - Tankless Water Heater .....	36	Solder Paste.....	226
Sewer And Drain Pipe Fittings .....	156 - 159	Solvent - Shower Pan .....	232
Sewer Relief Valve .....	224	Spa And Pool Vacuum Hose .....	206
Shielded Coupling - Flexible Rubber Pipe Fittings .....	203	Spa Hose .....	206
Shoe - Stud Support .....	207	Spackling .....	238
Shoe Covers .....	246	Spanner Flange .....	251
Shower Accessories .....	139	Specialty Faucets.....	78
Shower And Tub Faucet .....	56 - 58, 60, 62,67, 71, 74	Specialty Valves .....	220 - 221
Shower And Tub Flange Nut .....	133	<b>Splash Guards:</b>	
Shower And Tub Trim Kit.....	56 - 58, 60, 62,67, 71, 74, 118	Garbage Disposal .....	82
Shower Arms And Parts .....	148 - 150	Shower .....	139
Shower Balancing Spool.....	128	Split-Ring Pipe Hanger .....	210
Shower Bracket - Handheld .....	148	Splitter - Cable .....	314
Shower Curtain Rings.....	139	<b>Spouts:</b>	
Shower Drain .....	99 - 100	Add-On Shower.....	138
Shower Drain Fittings .....	101 - 102	Kitchen Faucet .....	136
Shower Drain Strainer .....	101	Tub .....	97 - 99
Shower Escutcheon .....	132 - 133	Spout Repair Kit .....	116
Shower Flange.....	133 - 134	Spout-Type Add-On Shower Unit.....	138
Shower Head.....	144 - 149	Spray Head - Kitchen Faucet .....	114 - 115
Shower Head Volume Control.....	150	<b>Spray Hoses:</b>	
Shower Hose - Handheld .....	147 - 148	Kitchen Faucet .....	114 - 115
Shower Pan Liner .....	232	Pre-Rinse Faucet .....	136
Shower Pan Solvent.....	232	Spray Valve Assembly - Pre-Rinse Faucet .....	136
Shower Rod .....	139	Spring And Seal Kit .....	116
Shower Rod Flange .....	139	Spring Tension Clamp .....	288
Shower Rod Frames - Add-On Shower .....	138	Spud - Closet .....	249
Shower Set - Handheld.....	147 - 148	Spud Washer - Rubber .....	249
Shower Splash Guard .....	139	Spud Wrench.....	241 - 242
Shower Stall Elbow.....	150	Spun Copper Driers .....	295 - 296
Shower Valve .....	62, 78	Squeeze Elbow - Dryer Duct Fittings .....	287
Side Beam Connector - Pipe Hanger.....	210	Stainless Steel Sink .....	54 - 55
Side Sprayer - Kitchen Faucet .....	114 - 115	Stainless Steel Water Connectors.....	2, 3 - 5, 10 - 11
Sidewall Air Register.....	290	Steam Dryer Adapter Hose .....	278
Sight Glass .....	296	Steam Dryer Anti-Vibration Pads .....	278
Silicone Sealant .....	235 - 237, 297 - 298	Steam Dryer Connectors.....	277 - 278
Sill Cock.....	220	Steam Dryer Installation Kit.....	277 - 278
Sill Cock Handle.....	223	Steam Dryer Installation Parts .....	277 - 278, 280 - 281
Sill Cock Handle Screw .....	223	Steam Dryer Outlet Box.....	27
Sill Cock Key.....	222	Steam Dryer Receptacle.....	281
Sill Cock Stem Bottom Assembly .....	223	Steam Dryer Y Adapter.....	278
Sill Cock Vacuum Breaker Repair Kit .....	223	Steam Radiator Valves.....	221 - 222
Single-Shot Pipe Hanger .....	207	Steel Box Flange .....	24
<b>Sink Drain Stoppers:</b>		Steel Clamps - PEX.....	181
Disposal .....	82 - 83	Stem - Faucet .....	125 - 132
Pop-Up .....	111 - 112	Stem Bottom Assembly - Sill Cock .....	223
Rubber .....	87	Stem Packing .....	117
Sink Hanger - Bathroom.....	143	Stick-It Epoxy Putty.....	238
Sink Legs - Wall-Mount.....	143	Stop Valve .....	13 - 28, 78
Sink Strainer .....	84 - 87	Stop Valve Escutcheon/Flange .....	23 - 24
Sink Strainer Gasket.....	86	Stop Valve Fittings .....	23
Sink Strainer Wrench.....	242	Stop Valve Handle .....	22
Sink Trap - Plastic PP Tubular .....	92	Stop Valve Handle Screw .....	22
Sink Trap J-Bend - Brass Tubular .....	88	Stop Valve Loose Key Handle.....	22
Sinks .....	54 - 55	Stop Valve Replacement Parts .....	22
<b>Sleeves:</b>		Stop Valve Sure-Grip Handle.....	24
Compression Fittings.....	190	Stop Valve Tee Adapter - Push-Fit Fittings - Brass.....	53, 173
Escutcheon .....	134 - 135		

# ALPHABETIC INDEX

## S

### Strainers:

In-Line Drain .....	101
Shower Drain .....	101
Sink Drain .....	84 - 87
Tub Drain .....	107
Strainer Gasket - Sink .....	86
Strainer Wrench .....	242

### S-Traps:

Brass Tubular .....	88
Plastic PP Tubular .....	93

### Straps:

Pipe And Tube Hanger .....	208 - 209
Tarp .....	245
Water Heater Safety .....	37 - 38

### Street Elbows:

ABS DWV Fittings .....	160 - 161
Black Malleable Iron Fittings .....	197
Copper Press Fittings .....	170
Copper Pressure Fittings .....	167
CPVC Fittings .....	186 - 187
Galvanized Malleable Iron Fittings .....	193
PVC DWV Fittings .....	151 - 152
PVC Schedule 40 Pressure Fittings .....	164
Sewer And Drain Fittings .....	157
Strike Plate - Door .....	300
Strut Pipe Clamp .....	210
Stub-Out - Straight Female Sweat - Copper .....	185

### Stub-Out Elbows:

F1807 PEX - Copper .....	184
F1960 PEX - Copper .....	185
Male Sweat - Copper .....	185
Push-Fit - Copper .....	184
Stud Guard .....	207
Stud Support Shoe .....	207
Suction Line Driers .....	295
Sulphuric Drain Opener .....	244
Sump Pump .....	213
Sump Pump Check Valve .....	213
Supply Connectors .....	2 - 12
Supply Line Nuts .....	112
Support Bracket - Pipe Hanger .....	211
Support Shoe - Stud .....	207
Sure-Grip Flange .....	23 - 24
Sure-Grip Handle - Stop Valve .....	24
Suspension Clamp - Pipe .....	209
Swing Check Valve .....	217
Swing Door Lock .....	301

### Switches:

Ceiling Fan .....	313
Pressure .....	215
Wall - Electrical .....	310 - 313
Switch And Outlet Cover - Outdoor .....	313
Switch Cover Plate - Blank - Electrical .....	313
Switch Face Plate - Electrical .....	311 - 313
Switching Relay .....	294
Swivel Adapter - PEX Fittings - F1807 - Brass .....	181
Swivel Connector - Flare Fittings .....	190

### Swivel Elbows:

F1807 PEX Fittings - Brass .....	180
F1960 PEX Fittings - Brass .....	182
Swivel Garden Hose Connector .....	307
Swivel Torch - MAPP/Propane Self-Lighting .....	227

## T

Tamper-Resistant Receptacles .....	309 - 310
Tank Booster - Water Heater .....	35
Tankless Water Heater Pressure Relief Valve .....	36
Tankless Water Heater Service Valve Kit .....	36

### Tapes:

Aluminum Foil .....	233
---------------------	-----

Caution .....	308
Duct .....	233, 297
Electrical .....	233
Masking .....	308
Pipe Insulation .....	213
Pipe Thread .....	232
Pipe Wrap .....	233
Taramet Sand Cloth .....	227
Tarp Strap .....	245
T-Cone Test Plug .....	204
Techno Test Cap .....	203

### Tees:

Black Malleable Iron Fittings .....	198
Brass Tubular .....	90
Cast Copper Pressure Fittings .....	168
Compression Fittings .....	189
Copper Press Fittings .....	170
Copper Pressure Fittings .....	168
CPVC Fittings .....	187

### F1807 PEX Fittings:

Brass .....	180
Polymer .....	178

### F1960 PEX Fittings:

Brass .....	182
Polymer .....	179
Flexible Rubber Pipe Fittings .....	202
Galvanized Malleable Iron Fittings .....	194
Iron Pipe Fittings - Brass .....	191
Plastic PP Tubular .....	95

### Push-Fit Fittings:

Brass .....	173
Plastic .....	52, 174
Twistloc Plastic .....	176
PVC DWV Fittings .....	153 - 154
PVC Schedule 40 Pressure Fittings .....	164
Sewer And Drain Fittings .....	158
Tee Valve - Push-Fit Fittings - Twistloc Plastic .....	177
Tee Valve Adapter - Push-Fit Fittings - Brass .....	53, 173
Teflon® Valve Stem Packing .....	117
Telephone And Cable Accessories .....	313 - 314
Telescoping Repair Coupling .....	201
Teletube Urinal Auger .....	244
Temperature And Pressure Relief Valve .....	35
Temperature Control Lever - Faucet .....	121
Temptrol® Repair Kit .....	117
Termination Screen .....	212
Test Cap .....	203
Test Gauges .....	224
Test Plug .....	203 - 204

### Test Tees:

ABS DWV Fittings .....	162
PVC DWV Fittings .....	154
T-Handle - Valve .....	223
Thermal Expansion Tank .....	35
Thermocouples .....	37
Therm-O-Disc Thermostat .....	35

### Thermometers:

Freezer/Refrigerator .....	269
Oven .....	283
Pocket Dial .....	296

### Thermostats:

Apcom .....	35
High Limit .....	35
Therm-O-Disc .....	35
Water Heater .....	35
Thermostatic Mixing Valve .....	35
Thread Sealant - Pipe .....	234
Threaded Plug - Sewer And Drain Fittings .....	159
Threaded Tube - Brass Tubular .....	89
Tilt Valve Actuating Unit .....	258
Tilt Valve Seat Disc .....	259
Timer - Defrost .....	279

# ALPHABETIC INDEX

Tire Pump.....	224	Tub Pop-Up And Cam Linkage Stopper .....	108
Toilet And Urinal Vacuum Breaker Repair Kit.....	266	Tub Shoe And Overflow Shoe .....	105
Toilet Bowl Bolt Cap.....	248	Tub Shoe Gasket.....	105
Toilet Bowl Gasket.....	249 - 250	Tub Spout.....	97 - 99
Toilet Cover Plate.....	252	Tub Spout Reducing Face Bushing.....	99
Toilet Flange Extension Kit.....	251	Tube And Pipe Hangers.....	207 - 210
Toilet Flanges.....	251 - 254	Tube Cleaning Brush.....	226
Toilet Installation Kit.....	11 - 12	Tube Insert - Brass.....	190
Toilet Installation Parts.....	248 - 251, 264 - 266	Tube Strap - Copper Eared.....	184
Toilet Paper Holder.....	142, 144	Tube Talon™ Multifunctional Pipe Clamp.....	208
Toilet Plunger.....	244 - 245	<b>Tubing:</b>	
Toilet Repair.....	247 - 266	Copper.....	169
Toilet Riser.....	10	Latex.....	205
Toilet Screws.....	248	PEX.....	53, 177
Toilet Seat Bolts.....	248	Polyethylene.....	205, 269
Toilet Seats.....	247	Vinyl.....	204 - 205
Toilet Tank.....	247	Tubing Cutter.....	240
Toilet Tank Ball.....	258, 260	<b>Tubular:</b>	
Toilet Tank Cover.....	247	Brass.....	88 - 91
Toilet Tank Fill Valves.....	258 - 260	Plastic Flexible.....	95
Toilet Tank Flappers.....	255 - 258	Plastic PP.....	91 - 95
Toilet Tank Float Rod.....	260	Tubular And Drainage.....	81 - 110
Toilet Tank Flush Valve.....	259 - 261	Tubular Drain Connector - Flexible Rubber Pipe Fittings.....	202
Toilet Tank Flush Valve Repair Parts.....	264 - 266	Twin Garden Hose Connector.....	306
Toilet Tank Lever/Arm.....	263 - 264	Type R Soft Copper Tubing.....	169
Toilet Tank Lift Wire.....	260		
Toilet Tank-To-Bowl Bolt Set.....	249	<b>U</b>	
Toilet Tank-To-Bowl Gasket.....	249	Under Sink Point-Of-Use Water Filter Housing.....	48
Toilet Water Supply Connectors.....	2 - 12	Under Sink Point-Of-Use Water Filtration Systems.....	47, 48
Toilet Wax Ring.....	250 - 251	Undermount Sink.....	54
Toilet Wedge.....	252	<b>Unions:</b>	
Tongue And Groove Pliers.....	239	Black Malleable Iron Fittings.....	198
<b>Tools:</b>		Compression Fittings.....	189
Pick-Up.....	242	Copper Press Fittings.....	171
PEX.....	183 - 184, 243	Copper Pressure Fittings.....	169
Plumbing.....	183 - 184, 204, 241 - 244	CPVC Fittings.....	188
Tools And Safety.....	239 - 246	Dielectric.....	37
Toothbrush And Cup Holder.....	141 - 142	Flare Fittings.....	190
Top Beam Clamp - Pipe Hanger.....	210	Galvanized Malleable Iron Fittings.....	194
<b>Torches:</b>		Push-Fit Fittings - Twistloc Plastic.....	175
MAPP/Propane Pencil Tip Burner.....	227	PVC Schedule 80 Pressure Fittings.....	165
MAPP/Propane Self-Lighting Swivel.....	227	Urinal Auger.....	244
Propane Pencil Tip.....	227	Urinal Flange.....	264
Torch Lighter - Flint.....	227	Urinal Flush Valve Diaphragm.....	265
Torque Wrench - No-Hub.....	204, 241	Urinal Flush Valve Repair Parts.....	264 - 266
Touch Flush Valve.....	259	Urinal Wax Ring.....	250
Towel Bar.....	140, 142	USB Charger Receptacles.....	310
Towel Bar Brackets.....	140	Utility Knife.....	240
Towel Bar End Caps.....	141	Utility/Dehumidifier Drain Hose.....	277
Towel Ring.....	141, 143	UV Light System.....	294
Transformers.....	294		
Transition - PEX Fittings - F1807 - Brass.....	181	<b>V</b>	
Transition Dryer Duct Kits.....	286	Vacuum Breaker - Hose Bibb Anti-Siphon.....	220
Trap Air Vent.....	212	<b>Vacuum Breaker Repair Kits:</b>	
Trap Seal - Floor Drain.....	102	Sill Cock.....	223
Tri-Check PVC Check Valve.....	214	Toilet And Urinal.....	266
Trim Kit - Tub And Shower.....	56 - 58, 60, 62,67, 71, 74, 118	Vacuum Hose - Pool And Spa.....	206
Trim Plate - Outlet Box.....	27	Vacuum Relief Valve - Water Heater.....	35
Trim Ring - Range.....	282 - 283	<b>Valves:</b>	
Trip-Lever Linkage Assembly.....	108	Air.....	221 - 222
Trip-Lever Overflow Face Plate.....	109	Backwater.....	102
Tub And Shower Escutcheon.....	132 - 133	Ball.....	46, 171, 173, 188, 215 - 217, 222
Tub And Shower Faucet.....	56 - 58, 60, 62,67, 71, 74	Boiler Drain.....	220
Tub And Shower Flange.....	133 - 134	Check.....	213 - 214, 217
Tub And Shower Flange Nut.....	133	Evaporative Cooler Float.....	221
Tub And Shower Rebuild Kit.....	117 - 118	Flush.....	259 - 261
Tub And Shower Trim Kit.....	56 - 58, 60, 62,67, 71, 74, 118	Foot.....	215
Tub Boxes.....	233	Garden.....	218
Tub Drain Assembly.....	106	Gas.....	46, 222
Tub Drain Parts.....	106 - 107	In-Line Check.....	217
Tub Drain Stopper.....	107 - 108	Line Tap.....	296
Tub Drain Strainer.....	107		
Tub Drain Strainer Body.....	106 - 107		
Tub Overflow Face Plate.....	109		
Tub Overflow Face Plate Parts.....	110		

# ALPHABETIC INDEX

## V

Needle .....	221
Pressure .....	215
<b>Push-Fit Fittings:</b>	
Brass .....	173, 216
Plastic .....	52, 175
Twistloc Plastic .....	52 - 53, 177
Self-Piercing Saddle .....	221, 269
Sewer Relief .....	224
Shower .....	62, 78
Sill Cocks .....	220
Steam Radiator .....	221 - 222
Sump Pump Check .....	213
Swing Check .....	217
Tri-Check PVC Check .....	214
Washing Machine .....	28, 221
Water Heater Drain .....	37, 221
Valve And Meter Boxes .....	305 - 306
Valve Handles .....	22, 223
Valve Key - Radiator Air .....	222 - 223
Valve Stem Packing .....	117
Vent - Air .....	212
Vent Draft Blocker - Dryer .....	289
<b>Vent Elbows:</b>	
ABS DWV Fittings .....	160
PVC DWV Fittings .....	152
Vent Hood - Dryer .....	288 - 289
Vent Hood Guard - Dryer .....	288
Vent Hood Louver - Dryer .....	288
Vent Kit - Dryer .....	286
Vent Outlet Box - Dryer .....	289
Vent Roof Cap - Dryer .....	287
Vent Stack Flashing Repair Collar .....	212
Vent Wall Cap - Dryer .....	287
Versitech Pressure Balance Shower Valve .....	62
Viewer - Door .....	301
Vinyl Tubing .....	204 - 205, 269
Vitreous China Sink .....	54
Volume Control - Shower Head .....	150
Volume Control Lever - Faucet .....	121

## W

Washing Machine Anti-Vibration Pads .....	278
<b>Wall Bend Tubes:</b>	
Brass Tubular .....	88
Plastic PP Tubular .....	94
Wall Cap - Dryer Vent .....	287
Wall Door Stop .....	303
<b>Wall Plates:</b>	
Blank - Electrical .....	313
Outlet .....	311 - 312
Wall Switch - Electrical .....	310 - 313
Wall Switch Plate - Electrical .....	311 - 313
Wall-Mount Faucets .....	77
Wall-Mount Sink Legs .....	143
Wardrobe And Closet Hardware .....	304
<b>Washers:</b>	
Faucet Bibb .....	116
Faucet Diverter .....	117
Garden Hose .....	307
Garden Hose Filter .....	307
Spud - Rubber .....	249
Washing Machine Hose .....	277
Washing Machine Hose Filter .....	277
Washing Machine Connectors .....	273 - 276
Washing Machine Discharge Hose .....	276 - 277
Washing Machine Elbow .....	277
Washing Machine Extension Hose .....	276
Washing Machine Fill Hose .....	273 - 276
Washing Machine Filter Hose Washer .....	277

Washing Machine Gooseneck Drain Hook .....	277
Washing Machine Hose Washer .....	277
Washing Machine Installation Parts .....	28, 221, 277
Washing Machine Outlet Box .....	26 - 27
Washing Machine Pan .....	277
Washing Machine Valve .....	28, 221
Washing Machine Y Mixer Hose .....	276

### Waste Arms:

Brass Tubular .....	89
Plastic PP Tubular .....	94
Waste Shoe And Overflow Shoe .....	105

### Water Connectors:

Dishwasher .....	269 - 271
Icemaker .....	267 - 269
Sink .....	2 - 5, 7 - 8, 10 - 11
Steam Dryer .....	277 - 278
Toilet .....	2, 5 - 6, 9 - 12
Washing Machine .....	273 - 276
Water Heater .....	2, 29 - 33
Water Drinking Fountain Faucet .....	78

### Water Filters:

Carbon Block .....	47 - 50
Chloramine Carbon Block .....	48 - 50
Chlorine Carbon Block .....	48 - 50
Chlorine Taste And Odor Carbon Block .....	48 - 50
In-Line .....	269
Sediment .....	47 - 50

### Water Filter Housings:

Household Point-Of-Entry .....	48 - 49
Under Sink Point-Of-Use .....	48
Water Filter Housing Parts .....	51
Water Filtration .....	47 - 53
Water Filtration Fittings .....	52 - 53, 174 - 175, 177
Water Hammer Arrestor .....	28
Water Heater Anode Rod .....	36
Water Heater Connector Display Rack .....	2
Water Heater Connector Washer .....	34
Water Heater Connectors .....	2, 29 - 33
Water Heater Dip Tube .....	36
Water Heater Drain Valve .....	37, 221
Water Heater Earthquake Strap .....	38
Water Heater Element .....	34
Water Heater Element Adapter Kit .....	34
Water Heater Element Gasket Kit .....	34
Water Heater Element Wrench .....	242
Water Heater Installation Kit .....	30
Water Heater Pan Fittings .....	38
Water Heater Pans .....	38
Water Heater Parts .....	34 - 38
Water Heater Pressure Relief Valves .....	35 - 36
Water Heater Runoff Tube .....	36
Water Heater Safety Strap .....	37 - 38
Water Heater Service Valve Kit - Tankless .....	36
Water Heater Stand .....	38
Water Heater Supplies .....	2, 29 - 38
Water Heater Tank Booster .....	35
Water Heater Temperature And Pressure Relief Valve .....	35
Water Heater Thermal Expansion Tank .....	35
Water Heater Thermostat .....	35
Water Heater Vacuum Relief Valve .....	35
Water Meter Box Key And Wrench .....	241
Water Meter Key .....	241
Water Pressure Test Gauge .....	224
Water Sensor - Drain .....	295

### Water Supply Connectors:

Dishwasher .....	269 - 271
Icemaker .....	267 - 269
Sink .....	2 - 5, 7 - 8, 10 - 11
Steam Dryer .....	277 - 278
Toilet .....	2, 5 - 6, 9 - 12
Washing Machine .....	273 - 276
Water Heater .....	2, 29 - 33
Water Supply Connector Display Rack .....	2
Waterless Trap Seal .....	102

# ALPHABETIC INDEX

## Wax Rings:

Toilet .....	250 - 251
Urinal .....	250
Weatherstrip Sealant .....	238
Wedge - Toilet .....	252
Wedge Door Holder.....	303
Wheel Handle - Valve .....	223
Window And Door Hardware .....	301 - 304
Window And Sliding Door Locks .....	301
Wing Elbow - CPVC Fittings.....	186
Wipes - Hand Cleaner .....	232
Wire Nuts.....	315
Wire-In Range Element.....	281 - 282
Work Light - Halogen.....	314

## Wrenches:

Adjustable .....	239
Basin.....	241
Basket Strainer.....	242
Drum Trap Plug .....	242
Dumbbell .....	241
Faucet Seat .....	243
Garbage Disposal .....	241
No-Hub Torque .....	204, 241
P.O. Plug And Closet Spud.....	242
Pipe .....	240
Spud .....	241 - 242
Water Heater Element .....	242
Water Meter.....	241

## Wyes:

ABS DWV Fittings .....	161, 273
PVC DWV Fittings.....	153
Sewer And Drain Fittings .....	157

## Y

Y Adapter - Steam Dryer .....	278
Y Mixer Hose - Washing Machine .....	276
Yellow Caution Tape.....	308

## Z

Zip Ties .....	315
Zipstick Pipe Hanger .....	208
Zoom-Spout Oiler.....	235

# NUMERIC INDEX

04470.....	84	10663.....	56	15011.....	144	15118.....	139	15314.....	99
04493.....	22	10665.....	56	15012.....	147	15119.....	139	15315.....	100
04494.....	22	10667.....	56	15013.....	145	15120.....	139	15316.....	99
04499.....	84	10669.....	56	15014.....	145	15121.....	139	15317.....	100
10046.....	71	10671.....	56	15015.....	145	15123.....	139	15319.....	100
10048.....	71	10673.....	56	15017.....	145	15124.....	139	15321.....	101
10066.....	67	10675.....	56	15018.....	145	15125.....	97	15322.....	101
10122.....	75	10677.....	56	15021.....	146	15126.....	98	15324.....	101
10123.....	75	10679.....	56	15022.....	146	15127.....	98	15327.....	101
10125.....	75	10681.....	56	15023.....	146	15128.....	99	15328.....	101
10130.....	75	10683.....	56	15024.....	146	15129.....	98	15329.....	101
10134.....	75	10685.....	56	15025.....	145	15130.....	99	15336.....	102
10135.....	75	10687.....	56	15027.....	146	15131.....	142	15338.....	102
10136.....	75	10689.....	58	15028.....	147	15132.....	99	15342.....	100
10137.....	75	10691.....	58	15029.....	149	15133.....	142	15343.....	212
10189.....	63	10693.....	58	15031.....	146	15135.....	142	15353.....	102
10190.....	63	10695.....	58	15035.....	144	15137.....	142	15354.....	102
10191.....	63	10697.....	58	15036.....	145	15142.....	147	15355.....	102
10192.....	63	10699.....	58	15038.....	145	15143.....	147	15356.....	102
10193.....	63	10701.....	58	15039.....	149	15144.....	148	15361.....	150
10198.....	63	10703.....	58	15041.....	149	15145.....	148	16074.....	148
10199.....	63	10705.....	58	15042.....	146	15146.....	147	16155.....	140
10200.....	63	10707.....	58	15043.....	150	15147.....	147	16173.....	140
10201.....	63	10709.....	60	15050.....	148	15148.....	147	16177.....	140
10202.....	63	10711.....	60	15051.....	148	15151.....	140	16178.....	140
10203.....	63	10713.....	60	15053.....	149	15152.....	140	16202.....	141
10204.....	63	10715.....	60	15054.....	149	15153.....	140	16203.....	141
10205.....	62	10717.....	60	15055.....	148	15155.....	140	16207.....	141
10206.....	62	10719.....	60	15056.....	149	15161.....	140	16208.....	141
10207.....	62	10721.....	60	15058.....	149	15163.....	140	16225.....	142
10252.....	76	10723.....	60	15059.....	148	15165.....	140	16226.....	142
10257.....	76	10725.....	60	15060.....	150	15171.....	140	16232.....	141
10258.....	76	10726.....	60	15061.....	97	15173.....	140	16233.....	141
10259.....	76	10758.....	28	15065.....	97	15175.....	140	16240.....	140
10260.....	76	10759.....	28	15066.....	97	15178.....	147, 148	16241.....	141
10300.....	57	10771.....	74	15067.....	98	15183.....	140	16242.....	142
10301.....	57	10772.....	74	15068.....	98	15186.....	144	16243.....	142
10303.....	57	10773.....	19	15069.....	98	15188.....	144	16244.....	142
10304.....	57	10774.....	19	15070.....	148	15190.....	144	16248.....	143
10305.....	57	10775.....	19	15071.....	98	15191.....	140	16249.....	143
10306.....	57	10776.....	19	15072.....	98	15194.....	140	16250.....	143
10307.....	65	10789.....	78	15074.....	97	15196.....	140	16251.....	143
10308.....	65	10790.....	12	15075.....	97	15198.....	140	16252.....	143
10361.....	77	10791.....	11	15076.....	97	15199.....	141	16253.....	143
10372.....	59	10901.....	96	15077.....	97	15201.....	141	16254.....	143
10373.....	59	10902.....	96	15078.....	148	15202.....	141	16255.....	143
10376.....	59	10903.....	96	15079.....	97	15204.....	142	16256.....	143
10377.....	59	10907.....	96	15080.....	98	15206.....	141	20077.....	217
10378.....	59	10908.....	96	15081.....	99	15207.....	141	20079.....	217
10379.....	59	10911.....	79	15082.....	98	15209.....	142	20081.....	217
10380.....	59	10914.....	79	15083.....	98	15215.....	142	20085.....	217
10381.....	59	10915.....	79	15084.....	98	15225.....	142	20087.....	217
10382.....	59	10997.....	77	15085.....	99	15231.....	141	20111.....	217
10383.....	59	11120.....	138	15086.....	98	15232.....	141	20113.....	217
10384.....	75	11121.....	138	15087.....	99	15235.....	142	20115.....	217
10385.....	75	11122.....	138	15088.....	98	15241.....	141	20117.....	217
10388.....	61	11123.....	137	15089.....	98	15245.....	140	20119.....	217
10389.....	61	11126.....	137	15090.....	98	15247.....	140	20121.....	217
10392.....	61	11127.....	137	15091.....	145	15261.....	139	20123.....	217
10393.....	61	11129.....	137	15092.....	139	15263.....	139	20181.....	218
10394.....	61	11135.....	138	15093.....	139	15270.....	144	20182.....	218
10395.....	61	11136.....	138	15094.....	146	15281.....	144	20183.....	218
10396.....	61	11137.....	138	15095.....	139	15284.....	144	20199.....	220
10397.....	61	12966.....	142	15097.....	139	15285.....	144	20201.....	219
10398.....	61	14138.....	149	15099.....	139	15286.....	144	20203.....	219
10399.....	61	14263.....	142	15101.....	139	15287.....	144	20205.....	219
10551.....	78	14291.....	145	15103.....	139	15301.....	100	20207.....	219
10561.....	74	14307.....	264	15105.....	139	15303.....	99	20208.....	219
10562.....	74	15000.....	146	15111.....	146	15305.....	99	20213.....	218
10572.....	62	15001.....	144	15112.....	147	15306.....	100	20215.....	218
10573.....	62	15002.....	145	15113.....	146	15308.....	99	20217.....	218
10575.....	62	15004.....	145	15115.....	99	15309.....	100	20221.....	220
10661.....	74	15009.....	145	15116.....	149	15310.....	101	20222.....	220
10662.....	74	15010.....	145	15117.....	99	15312.....	99	20223.....	220



# NUMERIC INDEX

20251	218	22047	48-50	25752	24	30105	87	31001	252
20253	218	22048	48-50	25753	25	30107	87	31002	252
20263	218	22049	48, 50	25754	24	30109	87	31003	252
20271	220	22050	48-50	25755	25	30110	87	31004	257
20273	220	22051	48-50	25756	24	30124	82	31005	257
20281	220	22052	48-50	25757	25	30125	82	31006	263
20283	220	22053	48, 50	25758	24	30126	82	31007	262
20289	221	22068	51	25759	24	30131	115	31008	262
20290	221	22069	51	25760	24	30133	115	31009	256
20322	222-223	22070	51	25761	24	30137	115	31010	256
20351	306	22071	51	25762	24	30139	115	31011	262
20353	306	22072	51	25763	24	30171	115	31013	262
20355	306	22073	51	25764	24	30173	115	31015	257
20357	307	22074	51	25765	24	30174	115	31016	262
20361	307	22100	51	25767	24	30175	115	31017	262
20363	307	22101	51	25768	24	30179	115	31019	258
20365	307	22104	51	25769	24	30184	115	31022	124
20366	306	22105	51	25770	24	30190	112	31023	124
20371	221	22108	51	25771	24	30194	112	31024	133
20378	221	22109	51	25777	24	30195	112	31025	123
20381	222	25340	10	25811	24	30196	112	31027	131
20400	217	25342	10	25813	24	30197	112	31028	131
20452	217	25344	10	25815	24	30199	112	31029	131
20453	217	25346	10	25863	23	30202	137	31030	133
20454	217	25348	10	25864	23	30216	122	31031	122
20455	217	25350	10	25865	23	30221	120	31032	122
20456	217	25680	10	25866	23	30222	120	31033	122
20457	217	25695	10	25867	23	30225	120	31035	130
20501	37	25696	10	25868	23	30226	120	31036	117
20503	37	25697	10	25870	23	30227	120	31038	128
20505	37	25698	10	25872	23	30229	118	31039	128
20507	37	25699	10	30001	84	30230	118	31040	133
20509	37	25701	23	30002	85	30234	114	31041	133
20511	37	25703	23, 149	30003	84	30236	114	31042	133
20513	37	25705	23	30005	84	30238	114	31043	132
20515	37	25707	23	30006	85	30242	119	31046	127
20562	201	25708	23	30008	84	30244	119	31047	127
20564	201	25709	23	30009	85	30246	114	31048	128
20566	201	25710	23	30011	85	30247	117	31049	127
20568	201	25711	23	30013	86	30253	129	31053	124
20570	201	25712	23	30015	86	30254	119	31056	124
20572	201	25713	23	30017	85	30255	129	31057	132
20583	201	25714	23	30019	85	30265	119	31058	132
20585	201	25715	23	30020	86	30266	119	31060	126
20587	201	25717	23	30021	85	30273	122	31075	132
20589	201	25719	23	30023	85	30275	122	31076	132
20591	201	25720	23	30031	86	30278	122	31077	132
20593	201	25721	23	30035	86	30282	122	32057	130
20597	201	25722	23	30036	86	30283	122	32102	132
20599	201	25723	149	30037	86	30287	122	32103	129
20607	201	25724	23	30041	86	30288	122	32104	129
20609	201	25726	23	30042	86	30289	122	32106	131
20838	219	25727	23	30043	86	30290	122	32107	117
20839	219	25728	24	30047	87	30291	122	32112	125
22000	47	25732	25	30051	87	30302	124	32115	116
22010	47	25733	25	30053	87	30307	125	32117	116
22011	47	25734	25	30054	87	30309	125	32119	116
22020	48	25735	25	30055	87	30311	125	32120	116
22021	48	25736	25	30057	87	30321	134	32121	116
22022	49	25737	25	30059	87	30323	134	32124	126
22023	49	25738	25	30061	87	30325	133	32125	125
22024	49	25739	25	30063	87	30327	135	32126	125
22025	48	25740	25	30065	87	30329	135	32130	132
22030	48, 50	25741	25	30067	87	30333	134	32131	119
22034	48, 50	25742	25	30071	87	30335	133	32135	119
22035	48-50	25743	25	30073	87	30346	133	32137	119
22038	48, 50	25744	25	30091	87	30381	111	32138	119
22039	48-50	25745	25	30093	82	30383	111, 112	32139	118
22040	48-50	25746	24	30097	82	30386	111	32142	118
22041	48-50	25747	25	30098	82	30396	111	32145	119
22042	48-50	25748	24	30099	82	30397	111	32147	119
22044	48, 50	25749	25	30101	83	30401	111	32154	120
22045	48, 50	25750	24	30102	82	30431	111	32155	120
22046	48-50	25751	25	30103	82	30435	112	32161	125

# NUMERIC INDEX

32164.....	116	32631.....	123	35014.....	88	35151.....	90	35305.....	92
32166.....	116	32632.....	123	35015.....	90	35201.....	103	35308.....	94
32167.....	116	32633.....	123	35016.....	88	35202.....	109	35309.....	95
32191.....	111	32636.....	123	35017.....	89	35203.....	103	35310.....	93
32309.....	128	32641.....	123	35018.....	88	35205.....	103	35311.....	93
32314.....	122	32643.....	123	35019.....	86, 112	35206.....	108	35312.....	93
32315.....	122	32644.....	123	35020.....	88	35207.....	102	35313.....	92
32316.....	122	32651.....	125	35022.....	88	35210.....	105	35314.....	92
32317.....	121	32653.....	125	35023.....	86	35211.....	105	35315.....	95
32323.....	121	32655.....	125	35027.....	86	35212.....	108	35316.....	92
32325.....	121	32680.....	134	35051.....	91	35213.....	102	35317.....	95
32327.....	121	32681.....	134	35053.....	91	35214.....	109	35318.....	92
32339.....	127	32683.....	135	35061.....	91	35215.....	102	35319.....	93
32342.....	119	32685.....	134	35064.....	91	35217.....	102	35320.....	93
32346.....	127	32725.....	134	35065.....	91	35220.....	105	35321.....	95
32347.....	127	32731.....	118	35067.....	91	35222.....	104	35322.....	93
32351.....	112	32797.....	133	35068.....	91	35224.....	105	35323.....	94
32354.....	127	32801.....	124	35069.....	91	35225.....	108	35324.....	94
32358.....	132	32805.....	121	35071.....	96	35226.....	104	35325.....	94
32359.....	135	32806.....	121	35072.....	96	35227.....	107	35326.....	91
32371.....	127	32807.....	121	35073.....	96	35228.....	104	35327.....	94
32372.....	126	32808.....	121	35074.....	96	35229.....	107	35328.....	93
32373.....	126	32809.....	121	35075.....	96	35231.....	106	35329.....	93
32374.....	126	32813.....	128	35077.....	96	35232.....	104	35330.....	94
32376.....	114	32830.....	121	35078.....	97	35233.....	106	35331.....	95
32377.....	114	32831.....	124	35081.....	89	35234.....	106	35332.....	94
32378.....	119	32832.....	124	35082.....	89	35235.....	106	35333.....	95
32379.....	119	32833.....	121	35083.....	89	35236.....	106	35335.....	95
32380.....	114	32839.....	131	35085.....	89	35237.....	105	35337.....	95
32381.....	114	32841.....	131	35086.....	91	35238.....	105	35349.....	94
32382.....	114	32842.....	131	35088.....	89	35239.....	105	35350.....	94
32383.....	114	32843.....	124	35089.....	91	35240.....	108	35351.....	94
32384.....	120	32844.....	124	35090.....	89	35242.....	108	35352.....	94
32385.....	120	32845.....	124	35092.....	89	35243.....	109	35354.....	94
32386.....	127	32846.....	124	35093.....	88	35244.....	109	35358.....	93
32387.....	127	32848.....	131	35094.....	89	35245.....	109	35360.....	94
32388.....	120	32852.....	122	35095.....	88	35246.....	109	35361.....	94
32389.....	120	32853.....	128	35096.....	88	35247.....	109	35362.....	94
32390.....	115	32854.....	131	35098.....	88	35249.....	108	35363.....	94
32391.....	115	32914.....	135	35099.....	88	35250.....	106	35366.....	94
32392.....	121	32915.....	124	35100.....	89	35251.....	108	35367.....	94
32393.....	121	32916.....	124	35101.....	89	35252.....	107	35368.....	94
32394.....	120	32919.....	135	35103.....	89	35253.....	108	35369.....	94
32395.....	120	32945.....	123	35104.....	89	35255.....	108	35371.....	92
32396.....	120	32946.....	123	35105.....	89	35256.....	106	35372.....	91
32397.....	120	32951.....	115	35106.....	89	35257.....	106	35373.....	92
32401.....	123	32955.....	115	35112.....	88	35258.....	107	35374.....	92
32403.....	123	32956.....	115	35113.....	89	35259.....	107	35375.....	92
32404.....	123	34006.....	54	35114.....	89	35260.....	108	35376.....	92
32405.....	123	34007.....	54	35115.....	89	35261.....	107	35377.....	92
32407.....	123	34008.....	54	35116.....	89	35262.....	107	35378.....	92
32408.....	123	34013.....	143	35117.....	89	35263.....	107	35379.....	92
32421.....	130	34020.....	143	35118.....	89	35264.....	104	35380.....	92
32423.....	131	34021.....	143	35119.....	89	35266.....	106	35383.....	95
32441.....	134	34022.....	143	35120.....	89	35267.....	110	35384.....	93
32442.....	134	34026.....	143	35122.....	89	35268.....	106	35385.....	92
32505.....	135	34027.....	143	35123.....	88	35269.....	106	35386.....	92
32515.....	129	34031.....	143	35124.....	89	35270.....	104	35387.....	93
32517.....	129	34041.....	143	35125.....	88	35271.....	107	35388.....	95
32531.....	120	34043.....	143	35126.....	89	35272.....	104	35389.....	94
32533.....	120	34045.....	143	35127.....	88	35273.....	104	35390.....	94
32535.....	120	34060.....	144	35128.....	89	35275.....	105	35393.....	93
32541.....	120	34062.....	144	35129.....	88	35277.....	105	35394.....	93
32543.....	120	34064.....	144	35131.....	88	35279.....	107	35395.....	93
32603.....	118	34066.....	144	35132.....	90	35280.....	107	35397.....	94
32604.....	118	34090.....	247	35133.....	89	35283.....	105	35398.....	93
32607.....	118	35001.....	88	35134.....	89	35284.....	105	35400.....	93
32608.....	118	35002.....	88	35135.....	90	35287.....	103	35401.....	90
32609.....	118	35003.....	88	35136.....	90	35291.....	103	35403.....	90
32617.....	130	35007.....	88	35137.....	90	35293.....	103	35405.....	90
32619.....	130	35008.....	88	35138.....	90	35296.....	104	35407.....	90
32620.....	130	35009.....	88	35139.....	90	35298.....	104	36002.....	116
32621.....	132	35010.....	89	35148.....	90	35301.....	95	36003.....	116
32628.....	117	35011.....	89	35149.....	89	35302.....	93	36004.....	116
32630.....	117	35013.....	88	35150.....	90	35304.....	93	36005.....	116

# NUMERIC INDEX

36007.....	116	40061.....	264	40211.....	248	43011.....	208	43489.....	143
36008.....	116	40062.....	263	40212.....	260	43013.....	208	43490.....	143
36009.....	116	40063.....	263	40214.....	261	43015.....	208	43491.....	143
36022.....	116	40064.....	263	40217.....	262	43017.....	208	43507.....	224
36023.....	116	40065.....	263	40220.....	258	43021.....	209	43509.....	224
36024.....	116	40066.....	263	40225.....	262	43022.....	209	43511.....	224
36025.....	116	40067.....	263	40231.....	260	43023.....	209	45021.....	240
36026.....	116	40069.....	263	40237.....	259	43024.....	209	45025.....	240
36027.....	116	40070.....	264	40271.....	247	43025.....	209	45027.....	240
36029.....	116	40071.....	255	40279.....	248	43027.....	209	45029.....	240
36131.....	116	40073.....	255	40280.....	248	43029.....	209	45033.....	240
36201.....	91	40076.....	258	40281.....	245	43031.....	209	45041.....	241
36203.....	91	40077.....	255	40285.....	244	43035.....	209	45058.....	242
36214.....	91	40079.....	259	40287.....	244	43039.....	209	45059.....	242
36215.....	91	40080.....	260	40306.....	257	43061.....	207	45060.....	242
36217.....	91	40081.....	259	40307.....	257	43251.....	206	45061.....	204, 241
36219.....	91	40082.....	251	40308.....	257	43253.....	206	45062.....	296
36221.....	111	40083.....	259	40309.....	258	43255.....	206	45063.....	296
36223.....	111	40085.....	258	40310.....	258	43257.....	206	45072.....	242
36251.....	249	40086.....	258	40311.....	256	43259.....	206	45088.....	243
36255.....	250	40088.....	256	40312.....	261	43261.....	206	45089.....	241
36256.....	249	40092.....	256	40313.....	261	43263.....	206	45090.....	244
36257.....	249	40093.....	260	40314.....	261	43265.....	206	45092.....	243
36259.....	250	40096.....	254	40315.....	261	43267.....	206	45093.....	243
36274.....	249	40097.....	255	40316.....	255	43269.....	206	45101.....	241
36291.....	107	40098.....	255	40471.....	84	43271.....	206	45103.....	241
36301.....	105	40101.....	260	40520.....	239	43273.....	206	45105.....	241
36305.....	110	40103.....	260	41003.....	278	43277.....	206	45107.....	241
36307.....	110	40107.....	254	41005.....	278	43287.....	206	45111.....	241
36331.....	86	40112.....	263	41006.....	278	43295.....	206	45115.....	241
40000.....	254	40113.....	250	41013.....	270	43296.....	206	45117.....	242
40004.....	254	40114.....	250	41015.....	270	43297.....	206	45121.....	243
40006.....	254	40119.....	264	41016.....	273	43301.....	207	45123.....	243
40007.....	250	40131.....	249	41017.....	278	43305.....	207	45125.....	242
40008.....	254	40133.....	249	41021.....	278	43307.....	207	45129.....	242
40010.....	251	40135.....	249	41023.....	278	43309.....	207	45131.....	243
40012.....	252	40137.....	249	41024.....	278	43311.....	207	45132.....	243
40013.....	250	40139.....	249	41025.....	277	43313.....	207	45151.....	243
40015.....	251	40141.....	249	41026.....	273	43315.....	207	45155.....	243
40017.....	251	40143.....	250	41027.....	273	43317.....	207	45156.....	224
40018.....	248	40144.....	250	41028.....	273	43335.....	207	45157.....	243
40019.....	248	40145.....	251	41029.....	273	43343.....	207	45159.....	242
40020.....	248	40146.....	250	41032.....	270	43401.....	202	45160.....	224
40021.....	248	40148.....	250	41033.....	267	43403.....	202	45161.....	243
40022.....	248	40150.....	250	41035.....	267	43404.....	202	45162.....	224
40024.....	248	40155.....	240	41036.....	267	43405.....	202	45165.....	242
40025.....	248	40156.....	240	41037.....	270	43407.....	202	45167.....	224
40026.....	248	40157.....	240	41040.....	270	43411.....	202	45169.....	224
40027.....	248	40165.....	239	41041.....	270	43417.....	202	45171.....	224
40028.....	248	40166.....	239	41042.....	270	43419.....	202	45173.....	224
40029.....	248	40167.....	239	41043.....	270	43421.....	202	45181.....	201
40030.....	248	40168.....	239	41045.....	270	43431.....	204	45183.....	201
40031.....	248	40169.....	239	41058.....	270	43433.....	204	45185.....	201
40032.....	248	40171.....	239	41059.....	270	43435.....	204	45187.....	201
40035.....	248	40172.....	239	41060.....	270	43437.....	204	45189.....	201
40039.....	248	40173.....	239	41061.....	270	43451.....	203	45191.....	201
40041.....	249	40174.....	239	41062.....	267	43453.....	203	45201.....	227
40042.....	248	40175.....	239	41063.....	273	43455.....	203	45205.....	227
40043.....	249	40176.....	239	41065.....	274	43457.....	203	45209.....	227
40044.....	248	40178.....	239	41066.....	274	43461.....	162	45211.....	226
40045.....	249	40179.....	239	41067.....	273	43462.....	162	45213.....	226
40047.....	249	40181.....	239	41130.....	270	43464.....	162	45218.....	165, 298
40048.....	249	40182.....	239	41131.....	278	43466.....	162	45219.....	165, 298
40049.....	263	40183.....	239	41132.....	270	43470.....	101	45245.....	226
40050.....	248	40184.....	239	41136.....	276	43471.....	101	45247.....	226
40051.....	261	40185.....	240	41138.....	276	43472.....	101	45249.....	226
40052.....	254	40197.....	240	41140.....	271	43477.....	203	45251.....	226
40053.....	260	40198.....	240	41150.....	271	43478.....	203	45260.....	226
40054.....	254	40201.....	260	41152.....	271	43479.....	203	45261.....	226
40055.....	263	40202.....	259	41180.....	274	43480.....	203	45262.....	226
40056.....	254	40203.....	260	41190.....	277	43481.....	203	45266.....	226
40057.....	263	40207.....	262	42033.....	101	43482.....	203	45267.....	226
40058.....	263	40208.....	262	42035.....	101	43483.....	203	45268.....	226
40059.....	251	40209.....	259	42041.....	101	43484.....	203	45331.....	225
40060.....	264	40210.....	248	42043.....	101	43488.....	143	45337.....	226

# NUMERIC INDEX

45375.....	233	48132.....	2, 7	48384.....	267	48551.....	255	50157.....	315
45377.....	233	48133.....	8	48387.....	267	48553.....	164	50160.....	315
45401.....	222	48134.....	8	48388.....	267	48556.....	164	50181.....	308
45403.....	222	48135.....	8	48389.....	267	48562.....	164	51996.....	244
45415.....	223	48136.....	8	48390.....	267	48573.....	33	51997.....	244
45417.....	223	48137.....	8	48391.....	267	48600.....	219	51998.....	244
45418.....	223	48138.....	7	48392.....	267	48601.....	219	51999.....	244
45419.....	223	48139.....	7	48397.....	276	48604.....	220	52014.....	244
45420.....	223	48141.....	5	48398.....	268	48620.....	220	52525.....	277
45421.....	223	48143.....	7	48447.....	164	48621.....	220	52528.....	277
45431.....	223	48145.....	2, 9	48448.....	164	48624.....	219	55001.....	224
45435.....	223	48149.....	8	48449.....	164	48625.....	219	55132.....	244
48003.....	2, 3	48150.....	8	48450.....	164	48626.....	219	55135.....	244
48004.....	2, 3	48151.....	8	48451.....	164	48627.....	219	55190.....	200, 235
48006.....	3	48152.....	7	48452.....	164	48628.....	218	55191.....	235
48007.....	3	48155.....	7	48453.....	164	48629.....	218	55331.....	245
48008.....	3	48166.....	8	48456.....	163	48636.....	217	55332.....	245
48011.....	22	48169.....	9	48457.....	163	48637.....	217	55335.....	308
48013.....	4	48170.....	2, 9	48458.....	163	48638.....	217	55341.....	242
48014.....	4	48175.....	2, 9	48459.....	163	48640.....	273	55352.....	240
48015.....	4	48179.....	9	48460.....	163	48722.....	9	55401.....	238, 308
48016.....	4	48183.....	9	48461.....	163	48723.....	8	55421.....	308
48017.....	4	48208.....	11	48462.....	164	48724.....	8	55425.....	308
48018.....	4	48221.....	11	48463.....	164	48731.....	7	55427.....	308
48019.....	4	48230.....	33	48464.....	164	48732.....	7	55429.....	308
48020.....	4	48231.....	33	48465.....	164	48733.....	7	55602.....	245
48021.....	4	48232.....	33	48466.....	164	48739.....	5	55606.....	245
48022.....	4	48233.....	33	48467.....	164	48741.....	5	55612.....	245
48025.....	3	48234.....	33	48468.....	163	48742.....	4	55616.....	246
48026.....	3	48250.....	2, 33	48469.....	163	48744.....	4	56001.....	301
48027.....	3	48251.....	2, 33	48470.....	163	48747.....	269	56002.....	301
48028.....	3	48252.....	2, 33	48471.....	163	48901.....	8	56003.....	301
48029.....	3	48254.....	2, 33	48472.....	163	48902.....	8	56004.....	301
48030.....	3	48255.....	33	48473.....	163	48903.....	8	56011.....	301
48032.....	4	48257.....	2, 33	48474.....	164	48904.....	8	56012.....	301
48033.....	4	48258.....	2, 33	48475.....	164	48905.....	8	56021.....	301
48034.....	4	48259.....	33	48476.....	164	48909.....	7	56023.....	301
48035.....	4	48260.....	33	48482.....	164	48910.....	7	56031.....	301
48036.....	4	48261.....	33	48483.....	164	48911.....	7	56034.....	301
48037.....	4	48262.....	33	48484.....	164	48912.....	7	56041.....	301
48041.....	4	48264.....	33	48485.....	164	48913.....	7	56045.....	301
48045.....	5	48275.....	35	48486.....	164	48914.....	7	56048.....	301
48047.....	5	48280.....	30	48487.....	164	48958.....	9	56053.....	301
48051.....	3	48281.....	30	48488.....	165	48959.....	9	56061.....	302
48064.....	5	48283.....	267	48489.....	165	48960.....	9	56062.....	302
48073.....	4	48301.....	3	48490.....	165	48972.....	9	56063.....	302
48074.....	4	48302.....	3	48493.....	165	48973.....	9	56065.....	302
48075.....	4	48303.....	3	48495.....	165	48978.....	9	56071.....	302
48076.....	4	48311.....	11	48496.....	165	48996.....	267	56072.....	302
48078.....	4	48316.....	267	48497.....	165	50000.....	232	56073.....	302
48080.....	4	48319.....	274	48498.....	165	50001.....	234	56074.....	302
48082.....	4	48336.....	271	48503.....	165	50003.....	233	56075.....	302
48083.....	6	48342.....	12	48504.....	165	50004.....	238	56076.....	302
48084.....	6	48355.....	268	48505.....	165	50005.....	233	56081.....	303
48085.....	6	48362.....	268	48508.....	165	50011.....	233	56082.....	303
48086.....	6	48363.....	269	48509.....	165	50013.....	233	56087.....	303
48087.....	2, 5	48364.....	269	48510.....	165	50021.....	233	56092.....	303
48088.....	5	48365.....	269	48511.....	165	50023.....	233	56101.....	303
48089.....	2, 5	48366.....	269	48512.....	165	50031.....	233	56103.....	303
48090.....	5	48367.....	273	48513.....	165	50033.....	233	56104.....	303
48092.....	5	48368.....	273	48514.....	165	50037.....	117	56109.....	303
48094.....	5	48369.....	273	48515.....	165	50039.....	234	56111.....	303
48097.....	6	48370.....	273	48516.....	165	50043.....	233	56127.....	303
48114.....	5	48371.....	273	48518.....	165	50045.....	233	56130.....	303
48118.....	6	48372.....	273	48519.....	165	50059.....	233	56133.....	303
48119.....	6	48373.....	274	48521.....	165	50077.....	308	56137.....	303
48121.....	7	48374.....	274	48522.....	165	50087.....	233	56139.....	303
48122.....	7	48375.....	274	48523.....	165	50088.....	233	56145.....	303
48123.....	7	48376.....	274	48524.....	165	50099.....	233	56251.....	304
48125.....	6	48377.....	274	48525.....	165	50114.....	298	56252.....	304
48127.....	7	48378.....	274	48526.....	165	50115.....	298	56253.....	304
48128.....	7	48379.....	267	48529.....	165	50121.....	245	56254.....	304
48129.....	7	48380.....	267	48530.....	165	50122.....	245	56301.....	305
48130.....	2, 7	48381.....	267	48534.....	165	50153.....	315	56303.....	305
48131.....	2, 7	48383.....	267	48550.....	255	50155.....	315	56305.....	305

# NUMERIC INDEX

56306.....	305	57775.....	299	60066.....	36	60270.....	27	60630.....	286
56307.....	305	58143.....	236	60067.....	36	60272.....	118	60631.....	287
56308.....	305	58144.....	236	60068.....	34	60273.....	117	60633.....	285
56309.....	305	58147.....	238	60069.....	34	60274.....	117	60634.....	285
56320.....	305	58148.....	237	60071.....	35	60301.....	221	60635.....	285
56337.....	304	58149.....	237	60073.....	35	60303.....	221	60640.....	286
56338.....	304	58165.....	238	60075.....	35	60304.....	275	60642.....	288
56339.....	304	58166.....	238	60076.....	38	60307.....	277	60643.....	287
56341.....	304	58168.....	238	60077.....	38	60308.....	275	60645.....	287
56352.....	302	58169.....	237	60078.....	38	60309.....	277	60646.....	288
56354.....	302	58170.....	237	60079.....	38	60310.....	275	60648.....	285
56355.....	302	58171.....	237	60080.....	38	60314.....	275	60649.....	285
56356.....	302	58172.....	237	60082.....	38	60315.....	275	60651.....	83
56359.....	302	58173.....	237	60083.....	38	60318.....	275	60653.....	287
56360.....	302	58190.....	237	60085.....	35	60350.....	275	60655.....	83
56373.....	305	58191.....	238	60086.....	38	60352.....	276	60657.....	83
56374.....	305	58193.....	236, 298	60087.....	38	60355.....	276	60660.....	284
56375.....	305	58199.....	235	60088.....	35	60357.....	276	60663.....	83
56383.....	305	59127.....	236	60089.....	38	60358.....	276	60667.....	284
56388.....	305	59128.....	236	60091.....	38	60363.....	83, 272	60668.....	284
56401.....	304	59129.....	236	60093.....	37, 221	60365.....	83, 272	60669.....	284
56405.....	304	59130.....	236	60094.....	38	60419.....	84	60670.....	284
56421.....	304	59150.....	236	60095.....	37	60421.....	84	60671.....	284
56423.....	304	59151.....	236	60098.....	37	60423.....	83	60672.....	284
56437.....	305	59152.....	236	60126.....	34	60424.....	83	60673.....	284
56439.....	305	59153.....	236	60128.....	34	60425.....	94	60674.....	284
56451.....	140	59154.....	237	60140.....	35	60482.....	275	60675.....	284
57005.....	302	59155.....	237	60145.....	36	60484.....	275	60676.....	284
57010.....	302	59156.....	237	60156.....	35	60486.....	275	60677.....	284
57011.....	302	59157.....	237	60158.....	35	60489.....	267	60678.....	284
57012.....	302	59158.....	237	60170.....	35	60490.....	267	60679.....	284
57013.....	302	59159.....	236	60172.....	35	60510.....	289	60680.....	284
57037.....	302	59160.....	236	60174.....	35	60516.....	287	60682.....	284
57081.....	300	59161.....	236	60204.....	36	60518.....	287	60683.....	284
57082.....	300	59162.....	236	60205.....	36	60519.....	273	60684.....	284
57200.....	304	59409.....	315	60210.....	30	60530.....	265	60686.....	284
57201.....	304	59411.....	315	60212.....	30	60531.....	265	60688.....	284
57202.....	304	59412.....	315	60220.....	27	60532.....	265	60691.....	284
57203.....	304	60001.....	46, 222	60222.....	27	60533.....	116	60694.....	284
57403.....	300	60003.....	46, 222	60227.....	27	60551.....	289	60696.....	284
57408.....	300	60004.....	46, 222	60228.....	34	60573.....	46	60702.....	288
57431.....	300	60005.....	46, 222	60230.....	27	60575.....	287	60719.....	283
57433.....	300	60006.....	46, 222	60231.....	27	60578.....	287	60720.....	283
57435.....	300	60009.....	46, 222	60232.....	26	60579.....	287	60722.....	282
57501.....	299	60011.....	46, 222	60233.....	26	60580.....	285	60723.....	282
57502.....	299	60013.....	46, 222	60234.....	26	60581.....	285	60725.....	282
57504.....	299	60022.....	35	60237.....	26	60582.....	286	60726.....	282
57506.....	299	60023.....	35	60238.....	26	60583.....	286	60727.....	282
57511.....	299	60029.....	46, 222	60239.....	26	60584.....	286	60728.....	282
57514.....	299	60030.....	46, 222	60240.....	26	60586.....	288	60729.....	283
57516.....	299	60031.....	46, 222	60241.....	26	60587.....	288	60730.....	283
57521.....	299	60032.....	46, 222	60242.....	26	60589.....	289	60746.....	282
57522.....	299	60034.....	46, 222	60243.....	27	60590.....	288	60747.....	282
57524.....	299	60035.....	37	60244.....	27	60591.....	289	60748.....	283
57526.....	299	60036.....	37	60245.....	27	60592.....	286	60749.....	283
57531.....	300	60037.....	37	60246.....	27	60593.....	286	60750.....	283
57532.....	300	60038.....	37	60247.....	27	60594.....	289	60751.....	283
57533.....	299	60039.....	34	60248.....	27	60596.....	289	60752.....	283
57534.....	300	60042.....	215	60249.....	27	60597.....	288	60753.....	283
57536.....	300	60043.....	215	60250.....	27	60599.....	287	60759.....	283
57551.....	299	60045.....	36	60252.....	27	60600.....	287	60760.....	283
57552.....	299	60047.....	34	60253.....	27	60601.....	289	60761.....	282
57601.....	300	60048.....	34	60254.....	27	60602.....	288	60762.....	282
57602.....	300	60049.....	34	60256.....	26	60603.....	288	60763.....	282
57670.....	299	60050.....	34	60258.....	26	60605.....	288	60764.....	282
57671.....	299	60052.....	34	60260.....	27	60607.....	288	60765.....	285
57672.....	299	60053.....	34	60261.....	27	60608.....	288	60840.....	28
57673.....	299	60054.....	34	60262.....	26	60612.....	286	60842.....	28
57674.....	299	60056.....	34	60263.....	26	60616.....	286	60844.....	28
57675.....	299	60058.....	34	60264.....	27	60618.....	286	60846.....	28
57770.....	299	60059.....	34	60265.....	27	60619.....	285	60848.....	28
57771.....	299	60060.....	34	60266.....	26	60625.....	285	60850.....	28
57772.....	299	60061.....	34	60267.....	27	60627.....	280, 315	60852.....	28
57773.....	299	60062.....	36	60268.....	117	60628.....	280, 315	60858.....	28
57774.....	299	60065.....	34	60269.....	117	60629.....	280, 315	60986.....	316

# NUMERIC INDEX

60988.....	316	61625.....	291	62044.....	310	65100.....	185	65277.....	183
60990.....	316	61626.....	291	62045.....	310	65101.....	185	65278.....	183
60992.....	316	61627.....	291	62046.....	311	65102.....	185	65280.....	181
60994.....	316	61628.....	291	62047.....	311	65103.....	185	65281.....	181
60996.....	316	61629.....	291	62048.....	311	65104.....	185	65282.....	181
61001.....	313	61630.....	291	62049.....	311	65105.....	185	65283.....	181
61005.....	314	61631.....	290	62050.....	312	65106.....	185	65284.....	181
61011.....	313	61632.....	290	62051.....	312	65107.....	185	65285.....	182
61013.....	314	61633.....	290	62052.....	312	65112.....	184	65286.....	181
61017.....	314	61634.....	290	62053.....	312	65114.....	184	65287.....	181
61020.....	311	61637.....	289	62054.....	312	65116.....	184	65288.....	181
61064.....	126	61638.....	289	62055.....	312	65117.....	184	65289.....	182
61067.....	314	61639.....	291	62056.....	312	65118.....	184	65290.....	182
61069.....	314	61640.....	291	62057.....	312	65119.....	184	65291.....	182
61071.....	314	61641.....	291	62058.....	312	65120.....	183	65292.....	182
61074.....	314	61642.....	291	62059.....	312	65121.....	183	65293.....	182
61075.....	314	61643.....	291	62060.....	312	65122.....	183	65294.....	182
61076.....	314	61644.....	291	62061.....	312	65145.....	183	65295.....	182
61101.....	313	61645.....	291	62062.....	313	65146.....	183	65296.....	182
61105.....	313	61646.....	291	62063.....	313	65147.....	183	65297.....	182
61201.....	283	61647.....	291	62064.....	312	65148.....	183	65298.....	182
61241.....	280	61648.....	291	62065.....	312	65149.....	183	65299.....	182
61242.....	280	61649.....	291	62066.....	312	65150.....	181	65300.....	183
61243.....	280	61650.....	291	62067.....	312	65151.....	181	65301.....	183
61244.....	280	61652.....	291	62068.....	312	65152.....	181	65302.....	183
61245.....	280	61653.....	290	62069.....	312	65153.....	181	65303.....	182
61246.....	280	61654.....	290	62070.....	312	65155.....	183	65304.....	182
61247.....	280	61656.....	290	62071.....	312	65156.....	183	65305.....	181
61248.....	280	61657.....	290	62072.....	312	65158.....	185	65306.....	181
61249.....	280	61658.....	290	62073.....	312	65160.....	184	65307.....	182
61250.....	280	61660.....	290	62074.....	313	65161.....	184	65450.....	277
61251.....	280	61661.....	290	62075.....	313	65163.....	184	65605.....	191
61252.....	280	61662.....	290	62076.....	313	65164.....	185	65609.....	191
61253.....	280	61663.....	290	62077.....	313	65165.....	185	65625.....	190
61254.....	280	61664.....	291	62078.....	310	65166.....	185	65703.....	46, 191
61255.....	280	61665.....	291	62079.....	310	65167.....	185	65704.....	46, 191
61256.....	279	61667.....	291	62080.....	313	65177.....	184	65705.....	46, 191
61259.....	280	61668.....	290	62081.....	313	65178.....	183	65720.....	46, 191
61260.....	280	61670.....	290	62082.....	311	65179.....	183	65722.....	46, 191
61261.....	280	61671.....	290	62083.....	311	65180.....	183	65726.....	46, 191
61262.....	281	61672.....	290	62084.....	312	65181.....	181	65728.....	46, 191
61263.....	281	61706.....	281	62085.....	312	65182.....	181	65751.....	191
61265.....	281	61707.....	281	62088.....	311	65183.....	181	65753.....	191
61266.....	281	61708.....	282	62089.....	311	65184.....	181	65754.....	191
61267.....	281	61709.....	282	62165.....	314	65186.....	183	65755.....	191
61268.....	279	61712.....	282	62167.....	309	65187.....	183	65820.....	296
61269.....	279	61713.....	282	62168.....	309	65190.....	185	65821.....	296
61271.....	280	61714.....	281	62169.....	309	65192.....	185	65901.....	247
61272.....	280	61715.....	281	62170.....	309	65198.....	184	65903.....	247
61273.....	280	61716.....	281	62171.....	309	65199.....	184	65905.....	247
61302.....	315	61717.....	281	62172.....	309	65234.....	190	65907.....	247
61303.....	315	61730.....	282	62173.....	309	65236.....	190	65912.....	247
61304.....	315	61731.....	282	62174.....	309	65254.....	182	65913.....	247
61305.....	315	61732.....	282	62175.....	309	65255.....	182	65914.....	247
61529.....	313	61733.....	282	62176.....	309	65256.....	182	65925.....	247
61601.....	289	62021.....	313	62177.....	309	65257.....	182	65931.....	247
61602.....	289	62023.....	309	62178.....	309	65258.....	182	65933.....	247
61603.....	289	62024.....	309	62185.....	310	65259.....	182	66030.....	178
61604.....	289	62025.....	309	62186.....	310	65260.....	182	66031.....	178
61605.....	289	62026.....	309	62257.....	310	65261.....	182	66032.....	178
61606.....	289	62027.....	311	62263.....	311	65262.....	182	66033.....	178
61608.....	290	62028.....	311	62516.....	190	65263.....	182	66040.....	178
61609.....	290	62029.....	311	62620.....	192	65264.....	182	66041.....	178
61610.....	290	62030.....	311	62633.....	191	65265.....	182	66042.....	178
61611.....	290	62031.....	311	62730.....	46, 191	65266.....	182	66043.....	178
61612.....	290	62032.....	311	62731.....	46, 191	65267.....	183	66044.....	178
61613.....	290	62033.....	311	62740.....	46, 191	65268.....	183	66045.....	178
61614.....	290	62034.....	311	62744.....	46, 191	65269.....	183	66046.....	178
61615.....	290	62037.....	311	62745.....	46, 191	65270.....	183	66047.....	178
61616.....	290	62038.....	310	62747.....	46, 191	65271.....	183	66048.....	178
61617.....	290	62039.....	311	65008.....	178	65272.....	183	66049.....	178
61618.....	290	62040.....	310	65009.....	178	65273.....	183	66051.....	178
61619.....	290	62041.....	310	65013.....	267	65274.....	183	66087.....	178
61623.....	290	62042.....	310	65015.....	267	65275.....	183	66088.....	178
61624.....	290	62043.....	310	65017.....	267	65276.....	183	66089.....	178

# NUMERIC INDEX

66090.....	178	73004.....	253	76247.....	230	78086.....	193	78164.....	195
66091.....	178	73005.....	253	76274.....	231	78087.....	193	78165.....	195
66092.....	178	73006.....	102	76275.....	231	78088.....	193	78166.....	195
66093.....	178	73007.....	102	76276.....	231	78089.....	193	78167.....	195
66098.....	178	73008.....	102	76277.....	231	78090.....	193	78168.....	195
66124.....	178	73009.....	102	77501.....	269	78091.....	193	78169.....	195
66125.....	178	73010.....	251	77507.....	283	78092.....	193	78170.....	195
66126.....	178	73013.....	101	77550.....	279	78093.....	193	78171.....	195
66150.....	178	73014.....	101	77551.....	279	78094.....	194	78172.....	195
66151.....	178	73015.....	107	77552.....	279	78095.....	194	78173.....	195
66152.....	178	73016.....	100	77553.....	279	78096.....	194	78174.....	195
66153.....	178	73017.....	100	77554.....	279	78097.....	194	78175.....	195
66154.....	178	73018.....	100	78000.....	203	78098.....	194	78176.....	195
66155.....	179	73019.....	100	78001.....	203	78099.....	194	78177.....	195
66156.....	179	73020.....	101	78002.....	203	78100.....	194	78178.....	195
66157.....	179	73022.....	212	78021.....	203	78101.....	194	78179.....	195
66158.....	179	73023.....	212	78023.....	203	78102.....	194	78180.....	195
66159.....	179	73024.....	101	78025.....	203	78103.....	194	78181.....	195
66160.....	179	73025.....	101	78027.....	203	78104.....	194	78182.....	195
66161.....	179	73026.....	264	78029.....	245	78105.....	194	78183.....	195
66162.....	179	73027.....	264	78030.....	245	78106.....	194	78184.....	195
66163.....	179	73029.....	264	78031.....	245	78107.....	194	78185.....	195
66164.....	179	73030.....	264	78032.....	203	78108.....	194	78186.....	195
66165.....	179	73040.....	251	78033.....	203	78110.....	194	78187.....	195
66166.....	179	73042.....	252	78034.....	203	78111.....	194	78188.....	195
66167.....	179	73044.....	252	78035.....	203	78112.....	194	78189.....	195
66168.....	179	75022.....	53, 173	78036.....	198	78113.....	194	78190.....	195
66169.....	179	75030.....	174	78038.....	194	78114.....	194	78191.....	196
66170.....	179	75031.....	174	78039.....	194	78115.....	194	78192.....	196
66171.....	179	75100.....	173	78040.....	193	78116.....	194	78193.....	196
66172.....	179	75106.....	184	78041.....	193	78117.....	194	78194.....	196
69001.....	278	75190.....	174	78042.....	193	78118.....	194	78195.....	196
69006.....	271	75200.....	174	78043.....	193	78119.....	193	78196.....	196
69007.....	271	75201.....	174	78044.....	193	78120.....	193	78197.....	196
69008.....	270	75202.....	174	78045.....	193	78121.....	193	78198.....	196
69009.....	272	76204.....	228	78046.....	193	78122.....	194	78199.....	196
69010.....	272	76205.....	228	78047.....	193	78123.....	195	78200.....	196
69011.....	272	76206.....	228	78048.....	193	78124.....	195	78201.....	196
69012.....	272	76207.....	228	78049.....	193	78125.....	195	78202.....	196
69018.....	83, 272	76208.....	228	78050.....	193	78126.....	195	78203.....	196
69020.....	83, 272	76209.....	228	78051.....	193	78127.....	195	78204.....	196
69021.....	83, 272	76210.....	228	78052.....	193	78128.....	195	78205.....	196
69022.....	83, 272	76211.....	228	78053.....	193	78129.....	195	78206.....	196
69024.....	83, 272	76212.....	228	78054.....	193	78130.....	195	78207.....	196
69028.....	285	76213.....	228	78055.....	193	78131.....	195	78208.....	196
69030.....	285	76214.....	228	78056.....	193	78132.....	195	78209.....	196
69032.....	285	76215.....	228	78057.....	193	78133.....	195	78210.....	196
70112.....	307	76216.....	231	78058.....	193	78134.....	195	78211.....	196
70114.....	307	76217.....	231	78059.....	194	78135.....	195	78212.....	196
70116.....	307	76218.....	231	78060.....	194	78136.....	195	78213.....	196
70118.....	307	76219.....	231	78061.....	194	78137.....	195	78214.....	196
70120.....	307	76220.....	231	78062.....	194	78138.....	195	78215.....	198
70122.....	306	76221.....	231	78063.....	194	78139.....	195	78216.....	198
70124.....	306	76222.....	232	78064.....	194	78140.....	195	78217.....	198
70126.....	306	76223.....	232	78065.....	194	78141.....	195	78218.....	198
70131.....	306	76224.....	232	78066.....	194	78142.....	195	78219.....	198
70135.....	306	76225.....	232	78067.....	194	78143.....	195	78220.....	198
70136.....	307	76227.....	229	78068.....	195	78144.....	195	78222.....	197
70137.....	307	76228.....	229	78069.....	195	78145.....	195	78223.....	198
70141.....	307	76229.....	229	78070.....	195	78146.....	195	78224.....	198
70143.....	307	76231.....	230	78071.....	195	78147.....	195	78225.....	198
70144.....	277	76232.....	230	78072.....	195	78148.....	195	78226.....	198
70145.....	277	76233.....	230	78073.....	195	78150.....	195	78227.....	198
70160.....	305	76234.....	230	78074.....	192	78151.....	195	78228.....	198
70161.....	305	76235.....	231	78075.....	192	78152.....	195	78229.....	198
70162.....	306	76236.....	231	78076.....	192	78153.....	195	78230.....	198
70164.....	306	76237.....	230	78077.....	192	78154.....	195	78231.....	197
70486.....	273	76238.....	230	78078.....	192	78155.....	195	78232.....	197
71000.....	294	76239.....	230	78079.....	192	78156.....	195	78233.....	197
71001.....	295	76240.....	230	78080.....	192	78157.....	195	78234.....	197
71002.....	295	76241.....	229	78081.....	193	78158.....	195	78235.....	197
73000.....	163	76242.....	229	78082.....	193	78159.....	195	78236.....	197
73001.....	156	76243.....	229	78083.....	193	78160.....	195	78237.....	197
73002.....	212	76244.....	229	78084.....	193	78162.....	195	78238.....	197
73003.....	212	76245.....	230	78085.....	193	78163.....	195	78239.....	197





# NUMERIC INDEX

84004	177	84204	157	85019	210	85132	209	85445	161
84005	177	84205	157	85022	209	85133	211	85446	161
84006	177	84206	157	85023	209	85134	211	85447	161
84007	177	84207	157	85024	209	85216	227	85448	161
84008	52, 177	84209	157	85025	209	85297	225	85449	161
84009	176	84211	157	85026	209	85298	225	85450	161
84010	176	84213	157	85027	209	85299	225	85451	161
84011	175	84215	157	85028	209	85300	226	85452	161
84012	175	84218	157	85030	209	85301	226	85453	161
84013	175	84219	157	85031	209	85302	226	85454	161
84014	175	84220	157	85033	209	85307	225	85455	161
84015	175	84221	157	85034	209	85308	225	85456	161
84016	176	84223	157	85035	208	85309	225	85457	161
84017	176	84224	159	85036	208	85310	225	85458	161
84018	176	84226	159	85037	208	85311	225	85459	161
84019	176	84227	159	85038	208	85314	227	85460	161
84020	176	84228	156	85040	207	85315	227	85461	161
84021	176	84230	156	85041	207	85316	227	85462	161
84022	175	84231	156	85043	207	85317	227	85463	161
84023	175	84232	156	85045	207	85318	227	85464	161
84024	175	84235	156	85048	207	85319	227	85465	161
84025	175	84237	156	85050	210	85320	227	85466	161
84026	175	84240	156	85051	210	85322	225	85467	161
84027	176	84241	156	85052	210	85324	225	85468	161
84028	176	84249	159	85053	210	85325	225	85469	161
84029	176	84260	159	85054	210	85326	225	85470	161
84030	176	84261	158	85055	210	85329	225	85475	162
84031	176	84262	158	85056	207	85353	227	85476	162
84032	175	84265	158	85057	207	85354	227	85477	162
84033	176	84266	158	85058	207	85355	227	85478	162
84034	175	84269	158	85071	207	85357	227	85479	162
84035	176	84270	157	85073	207	85358	227	85480	162
84036	176	84271	157	85076	208	85400	160	85481	162
84037	175	84274	157	85077	208	85401	160	85482	162
84038	52, 175	84275	158	85079	208	85402	160	85483	162
84039	52, 175	84276	158	85080	208	85403	160	85484	162
84040	52, 175	84277	158	85081	208	85405	160	85485	162
84041	52, 175	84278	159	85082	208	85406	160	85486	162
84042	52, 174	84280	158	85088	208	85407	160	85487	162
84043	52, 174	84281	158	85089	208	85408	163	85488	162
84044	52, 174	84282	158	85092	208	85409	163	85489	162
84045	53, 177	84283	159	85095	210	85410	163	85490	162
84046	53, 177	84284	158	85096	210	85411	163	85491	162
84047	53, 177	84285	158	85097	210	85412	160	85492	162
84048	53, 177	84286	158	85098	210	85413	160	85493	162
84049	52, 174	84287	158	85099	210	85414	160	85494	162
84050	52, 174	84288	159	85100	210	85415	160	85495	162
84051	174	84289	159	85101	209	85416	160	85496	162
84052	52, 174	84290	159	85102	209	85417	160	85498	162
84053	52, 174	84291	159	85103	209	85418	160	85499	162
84054	174	84292	159	85104	209	85419	160	85500	162
84055	53, 174	84295	158	85105	209	85420	160	85501	162
84056	53, 174	84296	159	85106	209	85421	160	85502	253
84057	174	84297	159	85107	209	85422	160	85504	253
84058	52, 174	84298	159	85108	209	85423	160	85511	163
84059	52, 174	84299	159	85111	207	85424	160	85512	163
84060	52, 174	84300	159	85112	207	85425	160	85513	163
84061	174	84301	159	85113	208	85426	160	85514	163
84062	174	84302	159	85114	208	85427	160	85515	163
84065	176	84303	159	85115	209	85429	160	85516	163
84089	52, 174	84304	158	85116	209	85430	160	85517	163
84090	52, 174	85001	210	85117	209	85431	160	85518	163
84091	52, 174	85002	210	85118	209	85432	160	85519	163
84092	174	85004	210	85119	209	85433	161	85520	163
84093	174	85005	210	85120	209	85434	161	85521	163
84094	53, 174	85009	210	85121	209	85435	161	85522	163
84095	53, 174	85010	210	85123	208	85436	161	85523	163
84096	53, 174	85011	210	85124	208	85437	161	85524	163
84097	53, 174	85012	210	85125	208	85438	161	85525	163
84098	53, 174	85013	210	85126	209	85439	161	85532	163
84099	174	85014	210	85127	209	85440	161	85533	162
84100	174	85015	210	85128	209	85441	161	85534	162
84201	157	85016	210	85129	209	85442	161	85535	162
84202	157	85017	210	85130	209	85443	161	85536	162
84203	157	85018	210	85131	209	85444	161	85540	161



# NUMERIC INDEX

85958.....	167	86042.....	168	86200.....	232	86309.....	234	88773.....	188
85959.....	167	86044.....	188	86201.....	232	86310.....	234	88774.....	188
85960.....	167	86045.....	188	86202.....	232	86311.....	234	88775.....	188
85961.....	167	86046.....	188	86203.....	232	86312.....	234	88776.....	187
85962.....	167	86047.....	188	86216.....	229	86313.....	232	88777.....	187
85963.....	167	86048.....	188	86217.....	229	86340.....	212	88778.....	187
85964.....	166	86051.....	201	86218.....	231	86341.....	212	88779.....	187
85965.....	166	86052.....	201	86219.....	231	86700.....	81	88780.....	187
85966.....	166	86053.....	201	86220.....	231	86701.....	81	88781.....	188
85967.....	166	86054.....	201	86221.....	231	86702.....	81	88782.....	188
85968.....	166	86055.....	201	86223.....	231	86703.....	81	88783.....	188
85969.....	166	86056.....	201	86224.....	231	86706.....	81	90030.....	126
85970.....	166	86061.....	202	86225.....	231	86707.....	81	90066.....	127
85971.....	166	86062.....	202	86226.....	229	86708.....	81	90107.....	111
85972.....	168	86063.....	202	86227.....	229	86709.....	81	90115.....	96
85973.....	168	86064.....	203	86228.....	229	86720.....	81	90122.....	297
85974.....	168	86065.....	203	86229.....	229	86721.....	81	90124.....	297
85975.....	168	86066.....	203	86230.....	229	86940.....	245	90126.....	297
85976.....	168	86067.....	203	86231.....	230	86941.....	245	90131.....	235, 297
85977.....	168	86068.....	168	86232.....	230	87000.....	245	90132.....	235, 297
85978.....	168	86069.....	168	86233.....	230	87001.....	245	90133.....	235, 297
85979.....	168	86070.....	168	86234.....	230	87200.....	211, 232	90134.....	236, 297
85980.....	168	86071.....	168	86237.....	230	87201.....	211, 232	90429.....	84
85981.....	168	86072.....	168	86238.....	230	87204.....	228	90814.....	297
85982.....	168	86073.....	168	86239.....	230	87205.....	228	90816.....	297
85983.....	168	86074.....	168	86240.....	230	87206.....	228	90836.....	298
85984.....	168	86075.....	212	86241.....	229	87207.....	228	90837.....	298
85985.....	168	86076.....	212	86242.....	229	87208.....	228	90838.....	298
85986.....	168	86077.....	168	86243.....	229	87209.....	228	91005.....	294
85987.....	168	86078.....	168	86244.....	229	87210.....	228	91011.....	294
85988.....	168	86079.....	168	86245.....	211	87211.....	228	91218.....	272
85989.....	168	86080.....	168	86246.....	211	87212.....	228	91221.....	278
85990.....	168	86081.....	168	86247.....	211	87213.....	228	91225.....	271
85991.....	168	86082.....	168	86248.....	211	87214.....	228	91227.....	272
85992.....	168	86085.....	201	86249.....	211	87215.....	228	91228.....	276
85993.....	168	86086.....	201	86250.....	211	87235.....	230	91229.....	276
85994.....	168	86087.....	201	86251.....	211	87236.....	230	92007.....	291
85995.....	168	86088.....	201	86252.....	211	87245.....	229	92008.....	291
85996.....	168	86089.....	53, 269	86253.....	211	87246.....	229	92009.....	291
85997.....	168	86090.....	53, 269	86254.....	211	87247.....	229	92010.....	291
85998.....	168	86091.....	188	86255.....	211	87248.....	229	92011.....	291
85999.....	168	86092.....	188	86256.....	211	87274.....	231	92012.....	291
86000.....	201	86094.....	201	86257.....	211	87275.....	231	92013.....	291
86001.....	201	86096.....	201	86258.....	211	87276.....	231	92014.....	291
86002.....	201	86098.....	233	86259.....	211	87277.....	231	92015.....	291
86003.....	201	86099.....	233	86260.....	211	88350.....	38	92016.....	291
86004.....	201	86100.....	54	86261.....	211	88351.....	38	92017.....	291
86005.....	201	86101.....	55	86262.....	213	88731.....	165	92018.....	291
86006.....	201	86102.....	54	86263.....	213	88733.....	165	92019.....	291
86007.....	201	86103.....	55	86266.....	232	88735.....	165	92020.....	291
86008.....	201	86104.....	55	86267.....	232	88737.....	165	92021.....	291
86009.....	201	86105.....	55	86268.....	232	88739.....	165	92022.....	291
86010.....	201	86110.....	54	86278.....	38	88741.....	165	92023.....	291
86011.....	201	86111.....	54	86279.....	38	88750.....	185	92024.....	291
86012.....	202	86120.....	264	86280.....	38	88751.....	185	92025.....	291
86013.....	202	86122.....	265	86281.....	232	88752.....	185	92026.....	291
86014.....	202	86123.....	265	86283.....	226	88754.....	186	92027.....	291
86015.....	168	86124.....	265	86284.....	226	88755.....	186	92028.....	291
86016.....	168	86125.....	265	86285.....	234	88756.....	186	92029.....	292
86017.....	204	86126.....	265	86286.....	234	88757.....	186	92030.....	292
86018.....	204	86127.....	265	86287.....	234	88758.....	186	92031.....	292
86019.....	204	86128.....	265	86289.....	234	88759.....	187	92032.....	292
86020.....	204	86129.....	266	86290.....	234	88760.....	187	92033.....	292
86021.....	168	86130.....	266	86291.....	234	88761.....	186	92034.....	292
86022.....	168	86131.....	264	86292.....	234	88762.....	186	92035.....	292
86023.....	168	86150.....	232	86293.....	234	88763.....	186	92036.....	292
86024.....	168	86152.....	202	86297.....	226	88764.....	186	92037.....	292
86025.....	187	86153.....	202	86298.....	37	88765.....	186	92038.....	292
86026.....	187	86154.....	202	86299.....	37	88766.....	187	92039.....	292
86027.....	187	86162.....	202	86300.....	250	88767.....	187	92040.....	292
86028.....	187	86163.....	202	86304.....	234	88768.....	187	92041.....	292
86029.....	187	86164.....	202	86305.....	234	88769.....	187	92042.....	292
86030.....	186	86175.....	202	86306.....	234	88770.....	187	92043.....	292
86038.....	188	86198.....	212	86307.....	234	88771.....	187	92044.....	291
86039.....	188	86199.....	212	86308.....	234	88772.....	187	92045.....	291

# NUMERIC INDEX

92046.....	291	98615.....	204	98615.....	204	0415136.....	41	0427818.....	42
92047.....	291	92184.....	292	98616.....	204	0415148.....	41	0427824.....	42
92048.....	291	92185.....	292	98617.....	204	0415160.....	41	0427830.....	42
92049.....	291	92186.....	292	98618.....	204	0415812.....	44	0427836.....	42
92050.....	291	92187.....	292	98619.....	204	0415818.....	44	0427848.....	42
92051.....	291	92188.....	292	98620.....	204	0415824.....	44	0427860.....	42
92052.....	291	92189.....	292	98621.....	204	0415830.....	44	0428724.....	42
92053.....	291	95001.....	259	98622.....	204	0415836.....	44	0428730.....	42
92054.....	291	95003.....	256	98623.....	204	0415848.....	44	0428736.....	42
92055.....	292	95004.....	256	98624.....	204	0415860.....	44	0428748.....	42
92056.....	292	95005.....	258	98625.....	205	0416112.....	41	0428760.....	42
92057.....	292	95006.....	257	98626.....	205	0416118.....	41	0428772.....	42
92058.....	292	95007.....	257	98627.....	205	0416119.....	40	0431036.....	43
92059.....	292	95008.....	258	98628.....	205	0416120.....	40	0431048.....	43
92060.....	292	95009.....	256	98629.....	205	0416121.....	40	0432118.....	32
92061.....	292	95038.....	215	98630.....	205	0416122.....	40	0432124.....	32
92062.....	292	95045.....	215	98631.....	205	0416124.....	41	0432218.....	32
92063.....	292	95046.....	215	98632.....	205	0416136.....	41	0432224.....	32
92064.....	292	95058.....	235	98633.....	205	0416148.....	41	0432318.....	32
92065.....	292	95060.....	235	98634.....	205	0416712.....	41	0432324.....	32
92066.....	295	95066.....	261	98635.....	205	0416718.....	41	0436118.....	30
92067.....	296	95068.....	214	98636.....	205	0416724.....	41	0436124.....	30
92068.....	296	95069.....	213	98637.....	205	0416736.....	41	0436312.....	30
92069.....	296	95082.....	214	98638.....	205	0416748.....	41	0436315.....	30
92070.....	295	95089.....	213	98639.....	205	0417412.....	44	0436318.....	30
92071.....	295	95090.....	213	98640.....	206	0417418.....	44	0436324.....	30
92072.....	295	95100.....	235	98641.....	206	0417424.....	44	0436912.....	2, 29
92073.....	295	95101.....	235	98642.....	206	0417430.....	44	0436915.....	29
92074.....	295	95102.....	235	98643.....	206	0417436.....	44	0436918.....	2, 29
92075.....	295	95111.....	276	99013.....	315	0417448.....	44	0436924.....	2, 29
92077.....	295	95116.....	243	99018.....	298	0417472.....	44	0437012.....	31
92078.....	295	95118.....	243	99019.....	298	0418418.....	43	0437015.....	31
92079.....	295	95130.....	215	99020.....	298	0419018.....	43	0437018.....	31
92080.....	295	95131.....	215	99022.....	298	0419836.....	42	0437024.....	31
92081.....	295	95132.....	215	99030.....	314	0421448.....	42	0437118.....	32
92082.....	295	95133.....	215	041500.....	277	0421536.....	40	0437124.....	32
92083.....	295	98560.....	204	041502.....	277	0421548.....	40	0437218.....	31
92084.....	295	98561.....	204	041600.....	279	0422024.....	40	0437224.....	31
92087.....	295	98562.....	204	041602.....	279	0422036.....	40	0437318.....	32
92088.....	295	98563.....	204	0400918.....	45	0422218.....	43	0437324.....	32
92089.....	293	98564.....	204	0400936.....	45	0422224.....	43	0437412.....	31
92090.....	293	98565.....	204	0404112.....	45	0422236.....	43	0437415.....	31
92091.....	293	98566.....	204	0404118.....	45	0422248.....	43	0437418.....	31
92092.....	293	98567.....	204	0404124.....	45	0422260.....	43	0437424.....	31
92093.....	293	98568.....	204	0404130.....	45	0423836.....	43	0437512.....	31
92094.....	293	98569.....	204	0404136.....	45	0423848.....	43	0437515.....	31
92095.....	293	98570.....	204	0404148.....	45	0423860.....	43	0437518.....	31
92096.....	293	98571.....	204	0404160.....	45	0424624.....	42	0437524.....	31
92097.....	293	98572.....	204	0404172.....	45	0424648.....	42	0437712.....	2, 29
92098.....	293	98573.....	204	0405018.....	41	0424660.....	42	0437715.....	29
92099.....	293	98574.....	204	0405024.....	41	0424718.....	39	0437718.....	2, 29
92100.....	293	98575.....	204	0405030.....	41	0424724.....	39	0437724.....	2, 29
92101.....	293	98576.....	204	0405048.....	41	0425118.....	39	0437730.....	29
92102.....	293	98577.....	204	0405060.....	41	0425124.....	39	0437736.....	29
92103.....	293	98578.....	204	0405072.....	41	0425130.....	39	0438118.....	29
92104.....	293	98579.....	204	0405612.....	45	0425136.....	39	0438124.....	29
92105.....	293	98580.....	204	0405618.....	45	0425148.....	39	0438318.....	31
92106.....	293	98581.....	205	0405624.....	45	0425160.....	39	0438324.....	31
92107.....	293	98582.....	205, 269	0405630.....	45	0425172.....	39	0438612.....	31
92108.....	293	98583.....	205	0405636.....	45	0425412.....	43	0438618.....	31
92110.....	294	98584.....	205	0405648.....	45	0425418.....	43	0438624.....	31
92111.....	294	98585.....	205	0414336.....	40	0425424.....	43	0447512.....	32
92113.....	294	98586.....	205	0414348.....	40	0425430.....	43	0447515.....	32
92114.....	296	98587.....	205	0414448.....	41	0425436.....	43	0447518.....	32
92115.....	294	98588.....	205	0415012.....	44	0425448.....	43	0447524.....	32
92116.....	294	98589.....	205	0415018.....	44	0425460.....	43	0449715.....	29
92117.....	294	98590.....	206	0415024.....	44	0425472.....	43	0449718.....	29
92118.....	294	98591.....	206	0415030.....	44	0425512.....	40	0449724.....	29
92119.....	294	98592.....	206	0415036.....	44	0425518.....	40	04129LF.....	13
92120.....	294	98593.....	206	0415048.....	44	0425524.....	40	04182LF.....	15
92121.....	294	98594.....	206	0415060.....	44	0425536.....	40	04183LF.....	15
92124.....	293	98595.....	206	0415072.....	44	0425548.....	40	04318LF.....	13
92181.....	291	98596.....	206	0415112.....	41	0425560.....	40	04319LF.....	13
92182.....	291	98597.....	206	0415118.....	41	0425572.....	40	04320LF.....	16
92183.....	291	98598.....	205	0415124.....	41	0427048.....	42	04321LF.....	13

# NUMERIC INDEX

04322LF.....	13	10341LF.....	78	20443LF.....	217	60077CPVC.....	38	65051LF.....	179
04325LF.....	17	10343LF.....	78	20445LF.....	217	60078CPVC.....	38	65053LF.....	180
04326LF.....	16	10344LF.....	78	20491LF.....	36	60079CPVC.....	38	65087LF.....	179
04327LF.....	16	10345LF.....	78	20493LF.....	36	60080CPVC.....	38	65088LF.....	179
04328LF.....	16	10490N.....	74	20521LF.....	200	60082CPVC.....	38	65089LF.....	179
04336LF.....	13	10491N.....	74	20523LF.....	200	60083CPVC.....	38	65091LF.....	181
04338LF.....	13	10494N.....	74	20525LF.....	200	60086CPVC.....	38	65092LF.....	181
04341LF.....	15	10497N.....	74	20541LF.....	200	60087CPVC.....	38	65093LF.....	181
04342LF.....	15	10718LF.....	20	20543LF.....	200	60089CPVC.....	38	65094LF.....	180
04343LF.....	17	10719LF.....	20	20545LF.....	200	60091CPVC.....	38	65095LF.....	180
04344LF.....	13	10720LF.....	18	20547LF.....	200	60092LF.....	37, 221	65096LF.....	180
04345LF.....	14	10722LF.....	22	20549LF.....	200	60094CPVC.....	38	65098LF.....	180
04346LF.....	15	10723LF.....	20	25831LF.....	23	60122N.....	34	65099LF.....	180
04347LF.....	14	10724LF.....	20	25840LF.....	23	60124N.....	34	65124LF.....	180
04348LF.....	13	10725LF.....	20	25842LF.....	23	60125N.....	34	65125LF.....	180
04349LF.....	16	10727LF.....	19	25849LF.....	23	60229N.....	34	65126LF.....	180
04350LF.....	17	10728LF.....	19	25881LF.....	22	60320N.....	275	65127LF.....	180
04351LF.....	16	10729LF.....	20	25882LF.....	22	60321N.....	275	65129LF.....	180
04352LF.....	17	10730LF.....	20	30151LF.....	113	60322N.....	275	65130LF.....	181
04353LF.....	16	10731LF.....	18	30155LF.....	113	60323N.....	275	65131LF.....	181
04354LF.....	14	10732LF.....	18	30159LF.....	113	60325N.....	275	65132LF.....	180
04356LF.....	16	10733LF.....	18	30164LF.....	113	60326N.....	275	65133LF.....	180
04357LF.....	14	10735LF.....	21	30168LF.....	113	60327N.....	275	65134LF.....	180
04358LF.....	13	10736LF.....	19	30203LF.....	136	60329N.....	275	65135LF.....	180
04384LF.....	14	10737LF.....	18	30205LF.....	136	60331N.....	275	65140LF.....	179
04385LF.....	14	10738LF.....	18	30237LF.....	125	60333N.....	275	65142LF.....	179
04387LF.....	14	10739LF.....	18	30239LF.....	126	60335N.....	275	65144LF.....	180
04423LF.....	17	10740LF.....	21	30240LF.....	126	60349N.....	276	65154LF.....	180
04456LF.....	17	10742LF.....	19	30251LF.....	129	60451N.....	268	65201LF.....	190
04492LF.....	15	10746LF.....	19	30258LF.....	130	60458N.....	269	65205LF.....	190
10025LF.....	66	10753LF.....	18	30259LF.....	130	60461N.....	269	65211LF.....	190
10026LF.....	66	10754LF.....	18	30260LF.....	130	60466N.....	268	65221LF.....	190
10029LF.....	65	10755LF.....	18	30292LF.....	113	60467N.....	268	65225LF.....	190
10030LF.....	65	10756LF.....	18	30293LF.....	113	60473N.....	268	65229LF.....	190
10036LF.....	65	10757LF.....	19	30294LF.....	113	60474N.....	268	65231LF.....	190
10071LF.....	69	10777LF.....	21	30295LF.....	113	60476N.....	269	65239LF.....	190
10072LF.....	65	10778LF.....	21	32101LF.....	125	60479N.....	268	65243LF.....	190
10073LF.....	69	10779LF.....	21	32109LF.....	125	62550LF.....	190	65247LF.....	190
10074LF.....	65	10780LF.....	21	32129LF.....	126	62557LF.....	189	65251LF.....	190
10075LF.....	65	10796LF.....	77	32216LF.....	136	62576LF.....	191	65253LF.....	190
10076LF.....	65	10809LF.....	13	32221LF.....	136	62593LF.....	191	65333LF.....	189
10077LF.....	65	10891LF.....	73	32301LF.....	128	62595LF.....	191	65335LF.....	189
10086LF.....	70	10895LF.....	77	32308LF.....	128	62600LF.....	191	65339LF.....	189
10087LF.....	70	10896LF.....	73	32501LF.....	132	62601LF.....	191	65343LF.....	189
10088LF.....	66	20041LF.....	215	32511LF.....	129	62617LF.....	191	65345LF.....	189
10089LF.....	66	20043LF.....	215	32513LF.....	129	62628LF.....	192	65347LF.....	189
10090LF.....	66	20045LF.....	215	32611LF.....	130	62631LF.....	192	65361LF.....	189
10093LF.....	66	20047LF.....	215	32613LF.....	130	65001LF.....	179	65367LF.....	189
10094LF.....	66	20049LF.....	215	32716LF.....	125	65002LF.....	180	65369LF.....	189
10115LF.....	66	20051LF.....	215	32717LF.....	125	65003LF.....	180	65375LF.....	189
10116LF.....	66	20053LF.....	215	32817LF.....	128	65004LF.....	180	65379LF.....	189
10117LF.....	65	20055LF.....	215	32818LF.....	128	65006LF.....	180	65401LF.....	189
10118LF.....	65	20061LF.....	216	32824LF.....	129	65007LF.....	180	65405LF.....	189
10119LF.....	66	20063LF.....	216	32825LF.....	129	65029LF.....	179	65423LF.....	189
10120LF.....	66	20065LF.....	216	32837LF.....	131	65030LF.....	179	65431LF.....	190
10142LF.....	77	20067LF.....	216	32838LF.....	131	65031LF.....	179	65435LF.....	190
10149LF.....	77	20069LF.....	216	48005N.....	2, 3	65032LF.....	179	65444LF.....	190
10161LF.....	69	20071LF.....	216	48284LF.....	13	65033LF.....	179	65445LF.....	190
10163LF.....	69	20091LF.....	216	48285LF.....	16	65034LF.....	180	65446LF.....	189, 273
10164LF.....	69	20093LF.....	216	48286LF.....	13	65035LF.....	180	65447LF.....	189, 273
10175LF.....	69	20094LF.....	216	48287LF.....	14	65036LF.....	181	65455LF.....	189
10177LF.....	69	20095LF.....	216	48290LF.....	14	65037LF.....	181	65457LF.....	189
10178LF.....	69	20096LF.....	215	48291LF.....	14	65038LF.....	181	65458LF.....	189
10179LF.....	73	20097LF.....	215	48292LF.....	14	65039LF.....	180	65460LF.....	189
10181LF.....	73	20098LF.....	216	48307LF.....	10	65040LF.....	180	65465LF.....	189
10187LF.....	78	20099LF.....	216	48337N.....	271	65041LF.....	180	65469LF.....	189
10256N.....	76	20140LF.....	216	48651LF.....	21	65042LF.....	180	65471LF.....	189
10273LF.....	70	20142LF.....	216	48652LF.....	21	65043LF.....	180	65473LF.....	189
10277LF.....	70	20401LF.....	217	48654LF.....	21	65044LF.....	180	65475LF.....	189
10281LF.....	70	20403LF.....	217	48655LF.....	21	65045LF.....	180	65479LF.....	189
10282LF.....	70	20405LF.....	217	48673LF.....	17	65046LF.....	180	65481LF.....	189
10287LF.....	67	20423LF.....	217	48675LF.....	191	65047LF.....	180	65487LF.....	189
10291LF.....	71	20425LF.....	217	48676LF.....	191	65048LF.....	180	65507LF.....	189
10295LF.....	67	20429LF.....	217	60057N.....	34	65049LF.....	180	65509LF.....	189
10328LF.....	73	20431LF.....	217	60076CPVC.....	38	65050LF.....	179	65513LF.....	189

# NUMERIC INDEX

65517LF.....	189	75183LF.....	173	85321N .....	226	Disp-2005 .....	2
65680LF.....	190	75185LF.....	172	85821LF.....	166	Disp-2006 .....	2
65801LF.....	221, 269	75186LF.....	172	85842LF.....	167	Disp-2007 .....	2
65823LF.....	221	75187LF.....	172	85876LF.....	168	Disp-2008 .....	2
65827LF.....	221	75188LF.....	173	85877LF.....	168		
65833LF.....	221	75189LF.....	173	85878LF.....	168		
75011LF.....	172	75194LF.....	172	85879LF.....	167		
75012LF.....	172	75195LF.....	172	91063N .....	249		
75013LF.....	172	75197LF.....	173	91310N .....	268		
75014LF.....	173	75198LF.....	173	91311N .....	267		
75015LF.....	173	75199LF.....	173	95063LF.....	23		
75016LF.....	173	78661LF.....	192	96830N .....	121		
75017LF.....	173	78665LF.....	192	98306N .....	123		
75018LF.....	172	78691LF.....	192	98307N .....	122		
75019LF.....	172	78693LF.....	192	98323N .....	135		
75020LF.....	172	78695LF.....	192	98324N .....	124		
75021LF.....	172	78697LF.....	192	98325N .....	124		
75023LF.....	173	78699LF.....	192	98345N .....	133		
75024LF.....	173	78701LF.....	192	98355N .....	122		
75025LF.....	173	78703LF.....	192	98356N .....	133		
75026LF.....	173	78704LF.....	192	98361N .....	134		
75027LF.....	173	78705LF.....	192	98364LF.....	132		
75028LF.....	173	78707LF.....	192	98366N .....	132		
75029LF.....	173	78711LF.....	192	Disp-0151 .....	80		
75160LF.....	216	78721LF.....	192	Disp-0156 .....	80		
75162LF.....	216	78723LF.....	192	Disp-0157 .....	80		
75168LF.....	216	78725LF.....	192	Disp-0160 .....	80		
75178LF.....	172	78729LF.....	192	Disp-0186 .....	80		
75179LF.....	172	78733LF.....	192	Disp-0187 .....	80		
75180LF.....	173	78741LF.....	192	Disp-0188 .....	80		
75181LF.....	173	78742LF.....	192	Disp-2003 .....	2		
75182LF.....	173	78744LF.....	192	Disp-2004 .....	2		

EZ-FLO



# EZ-FLO INTERNATIONAL, INC.



**EASTMAN**  
Peace of Mind...

**ORDER FORM**  
(minimum order \$100.00 net)

Date \_\_\_\_\_

Customer Acct. # \_\_\_\_\_

Bill To \_\_\_\_\_  
\_\_\_\_\_  
\_\_\_\_\_

Ship To \_\_\_\_\_  
\_\_\_\_\_  
\_\_\_\_\_

Phone \_\_\_\_\_

FAX \_\_\_\_\_

P.O. #	Payment Terms	Freight Terms PPD / COL	Ship Via	Ship Date	Salesman/Buyer
--------	---------------	----------------------------	----------	-----------	----------------

Item #	Qty	EZ-FLO Part #	Customer Part #	Description	Unit Price	Discount	Total
1							
2							
3							
4							
5							
6							
7							
8							
9							
10							
11							
12							
13							
14							
15							
16							
17							
18							
19							
20							
21							
22							
23							
24							

This order is accepted subject to approval by our offices. Any part or all is subject to cancellation or delay in delivery due to government regulation or contingencies beyond our control. Prices subject to change without notice.

2750 East Mission Blvd.  
Ontario, CA 91761

Visit our web site at [www.ez-flo.net](http://www.ez-flo.net)

Customer Service  
Order Fax

800-486-5256  
866-827-3012

THIS PAGE INTENTIONALLY LEFT BLANK

THIS PAGE INTENTIONALLY LEFT BLANK



# EZ-FLO INTERNATIONAL, INC.



## APPLICATION FOR OPEN CREDIT (APPLICATION MUST BE COMPLETED IN FULL)

Business Name: \_\_\_\_\_ Email Address: \_\_\_\_\_

Street Address: \_\_\_\_\_

P.O. Box #: \_\_\_\_\_ P.O. Box Zip: \_\_\_\_\_ City: \_\_\_\_\_

State: \_\_\_\_\_ Zip: \_\_\_\_\_ Phone( ) \_\_\_\_\_ Fax( ) \_\_\_\_\_

Type of Business: \_\_\_\_\_ Date Established: \_\_\_\_\_

Corporation  Officers (names and addresses) \_\_\_\_\_  
(REQUIRED)

Sole Property  Owner (name and address) \_\_\_\_\_

Partnership  Partners (names and addresses) \_\_\_\_\_

**Bank References:** Name: \_\_\_\_\_ Account# \_\_\_\_\_

Savings  Address: \_\_\_\_\_

Checking  City: \_\_\_\_\_ State: \_\_\_\_\_ Zip: \_\_\_\_\_

Loan  Phone: ( ) \_\_\_\_\_ Fax: ( ) \_\_\_\_\_

Contact: \_\_\_\_\_

**Commercial Trade References:** Give only names of those you buy from on OPEN ACCOUNT. References will NOT be considered valid unless FULL NAMES, ADDRESSES and PHONE NUMBERS are included.

NAME	ADDRESS	CITY	STATE	ZIP	PHONE	FAX (REQUIRED)

Amount of credit desired monthly: \$ \_\_\_\_\_ Resale Permit No. \_\_\_\_\_  
(REQUIRED)

Purchase Order Required?: Yes \_\_\_\_\_ No \_\_\_\_\_ Accepts Back Orders?: Yes \_\_\_\_\_ No \_\_\_\_\_

Authorized Buyer: \_\_\_\_\_

Accounts Payable Contact: \_\_\_\_\_ Billing Instructions: \_\_\_\_\_

**Should you approve this application, I (we) agree to pay for all goods purchased under terms and conditions agreed upon. EZ-FLO International, Inc. is authorized to contact any references or banks listed above. It is understood that any information so obtained will be used solely for granting credit.** (Past due accounts may be subject to a service charge. Should it become necessary to collect this account through an attorney, by legal proceedings, or otherwise, the undersigned, including endorsers, promise to pay all cost of collections, including a reasonable attorney's fee.)

Authorized Buyer/

Co. Officer/Partner: \_\_\_\_\_ Title: \_\_\_\_\_ Dated: \_\_\_\_\_

Should a credit availability be granted by EZ-FLO International, Inc., all decisions with respect to the extension or continuation shall be in the sole discretion of EZ-FLO International, Inc. EZ-FLO International, Inc. may terminate any credit availability within its sole discretion.

THIS PAGE INTENTIONALLY LEFT BLANK

THIS PAGE INTENTIONALLY LEFT BLANK



## TERMS and CONDITIONS

EZ-FLO International, Inc.

Corporate Office

2750 East Mission Blvd.  
Ontario, CA 91761

Corporate Office

909-947-5256  
909-947-5775 fax

Distribution Centers

Ontario, CA  
Rockwall, TX  
Jacksonville, FL  
Logan Township, NJ  
Kinston, NC

Sales / Customer Service

800-486-5256  
866-827-3012 fax

Manufacturing / Packaging

Rockwall, TX  
Ningbo, China

### Terms and Conditions of Sale

Freight & Shipping Policy

Orders exceeding \$900.00 net will be shipped prepaid to destinations within the continental United States. Orders to Alaska, Hawaii and Puerto Rico exceeding \$900.00 net will be shipped prepaid to nearest continental United States port.

Terms

2% 10, net 30 days. Any amount past due is subject to a finance charge of 1.5% per month (18% per annum) on the past due balance. Disputed balances should be brought to the attention of EZ-Flo International immediately for a timely resolution. If any invoice is held in question, the balance not in question shall be paid in accordance with the aforementioned terms. Open accounts are subject to approval by our credit dept. according to customer financial statements, trade references & bank references.

Order Quantities

All orders must be issued in increments of unit order quantities as listed in the catalog. Where only master case quantities are listed, orders must be issued by master case quantities as listed in the catalog. Partial order quantities will be increased to nearest inner case quantities. All orders must be placed conforming to priced units of sale, e.g. bag, dozen, etc. Minimum order - \$100.00 net.

Return Policy

EZ-FLO International, Inc. will respond in most cases, within 24 hours, to all RGA requests. An RGA number (or reason for decline) and instructions will be faxed to the customer along with a Return Materials Form. Returned item(s) must be shipped with the Returned Materials Form in order to be processed. Failure to include this form will result in the shipment being returned to the customer, at the customer's expense, and credit will not be considered.

Return transportation must be prepaid by the customer w/ freight carrier designated unless alternative shipping is authorized in advance as part of the RGA issued by EZ-FLO International. Any shipment sent collect will be rejected and returned at the customer's expense. Freight will be credited on defective merchandise or on orders caused by or resulting from shipping errors on our part.

Credits will be issued at your cost when accompanied by an invoice or P.O.#, otherwise the prevailing price will represent the credited amount due.

Material (excluding defective items) must be received by EZ-FLO International in sellable condition in the original packaging. Material not received in original packaging will be subject to an additional 20% repackaging fee. Credits must be taken within one year of receipt.

EZ-FLO International will not accept returns on any merchandise over one year from date of initial sale. Any RGA may be subject to a 20% restocking charge. All RGA's expire 30 days after date of issue. Returns on product (excluding defective items) will be accepted up to 90 days after date of delivery. Product returned without prior approval will be returned to sender freight collect.

Online Orders

Customers may visit [www.ez-flo.net](http://www.ez-flo.net) or call 800-486-5256 to set up an online account and password to order product online. Applications are subject to an approval process and will be notified of their status once all documentation has been received and reviewed.

\*Disclaimer

References to manufacturer's trade names and/or registered trademarks that appear in the EZ-FLO International Catalog, circular or correspondence are intended for the sole purpose of identifying brands.

EZ-FLO repair parts will fit designated brands, and are not to be construed as an endorsement or acknowledgment, either expressed, or implied that products sold are authentic O.E.M. products made by or licensed by such manufacturers. The original equipment manufacturer bears no liability for the quality of EZ-FLO repair or replacement parts.

Claims

No claims will be allowed unless reported within 72 hours of receipt of goods.

All claims for shortage or damage should be reported by consignee, and must be accompanied by a copy of the proof of delivery receipt noting the specific shortage or damage. Any claim should be reported to the Customer Service Department.

EZ-FLO International shall not be held responsible in any claim of injury or damage from the installation of EZ-FLO merchandise.

Customers

All merchandise is sold to wholesale customers for resale. Customer assumes full liability for all taxes or other charges assessed or imposed by any government agency. All customers are required to furnish EZ-FLO International their tax exemption number, or applicable sales tax will be charged. All customers must have a signed and completely filled out credit application on file.

Warranty

EZ-FLO International's warranty shall be limited to replacement or credit, not to exceed the purchase price of the item. Labor and installation charges of any kind are not covered by our warranty. The warranty is against defects in workmanship or material for a period of one (1) year from the date of purchase. The warranty covers only the specific use for which each item is designed. The improper use or installation of any EZ-FLO product immediately voids the warranty. All claims regarding warranty must be reported to EZ-Flo within 3 business days of occurrence.

Backorders

If requested by the customer at the time of order, backorders exceeding \$50.00 will be held for 30 days. Backorders under \$10.00 will be cancelled.

Sales Policy

Possession of this catalog does not constitute an offer to sell.

Prices

Prices are subject to change without notice. All orders will be shipped and invoiced at the prevailing price at time of shipment. For larger or O.E.M. quantities, we would like the opportunity to quote pricing and scheduled deliveries.

Illustrations

Drawings in this catalog are intended as general description only. Unless specified they do not represent any particular brand or likeness.

Reproductions

© No part of this catalog may be reproduced without the expressed written consent of EZ-FLO International, Inc. All photography and line art is the property of EZ-Flo International and cannot be reproduced or copied without written permission.

Catalog

EZ-FLO International, Inc. shall not be held responsible for typographical errors and will not be held responsible for any liability associated with misprints, errors, and/or pricing discrepancies in this publication.

CALIFORNIA PROPOSITION 65 WARNING

Products contained within our catalog and on our website may contain chemicals known to the state of California to cause cancer and birth defects or other reproductive harm. If you have any questions or need additional information on our products, please call 1-800-486-5256 ext 499.

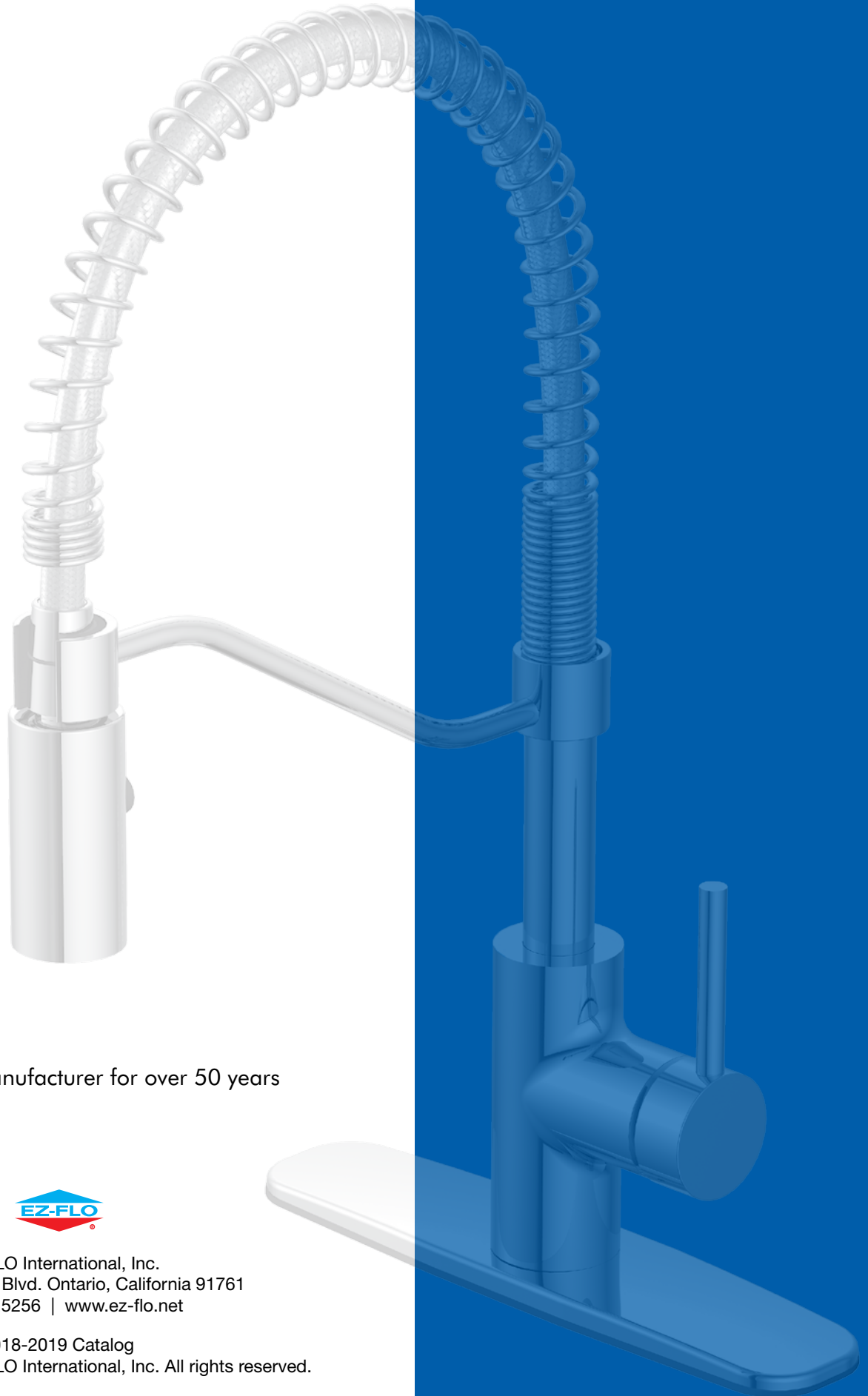

a **plumbing** manufacturer for over 50 years



EZ-FLO International, Inc.  
2750 E. Mission Blvd. Ontario, California 91761  
800.486.5256 | [www.ez-flo.net](http://www.ez-flo.net)

2018-2019 Catalog  
© 2018 Copyright. EZ-FLO International, Inc. All rights reserved.