



WELLXTROL®

Commercial Pump Systems Tanks



3

Years

188

AntiLegionella™



Antimicrobial.



Turbulator.



DeepDrawn.



WELLXTROL®

Amtrol pre-charged, potable water pressure tanks are engineered to reduce surge and ensure minimum pump run time in municipal well systems and pump applications. Available in diaphragm, full and partial acceptance bladder designs, all Well-X-Trol tanks are made at our ISO 9001:2015 certified facilities. All ASME tanks meet Section VIII, Division I standards and have an industry leading 3-year warranty.

Deep Drawn Construction

- Deep drawing doubles dome strength.
- Requires half the welds vs. head & shell.
- Integral diaphragm design features a unique hoop ring and groove configuration that securely locks together the diaphragm, liner and domes.
- Small footprint fits tight mechanical rooms.
- End-mounted charging valve for easy air adjustments on in-line models.

Patented Anti-Legionella Liner

- Safe, Silver-Ion technology targets active microorganisms to neutralize bacteria on contact.
- Compound is molded into the liner.
- Protection lasts the life of the tank.

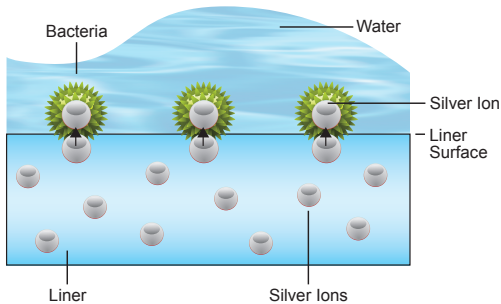

Patented Fresh Water Turbulator®

- Agitates incoming water to remove debris.
- Helps extend the life of the tank.
- Eliminates stagnant water in VFD Systems.

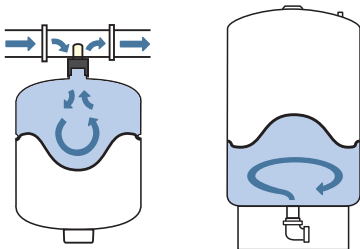

188
AntiLegionella. Antimicrobial. Turbulator.

- Patented Fresh Water Turbulator®
- High-Grade Stainless Steel Connector
- Deep Drawn Steel Domes
- Patented Anti-Legionella Liner
- Grooved Diaphragm Hoop Ring for a permanent seal
- Butyl Diaphragm for extra long life
- Works with Smart Pump, VFD and ECM Pump Systems
- Small Footprint Fits Tight Mechanical Rooms
- Convenient Air Stem Location

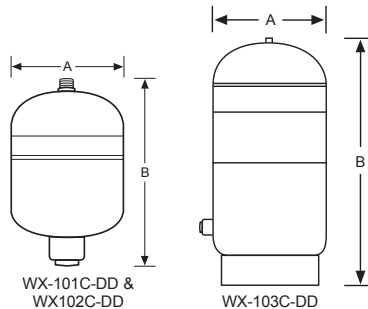

ASME Deep Drawn Diaphragm Series Specifications

Model Number	Tank Volume (Gallons)	Max. Accept. Volume (Gallons)	A Diameter (Inches)	B Length (Inches)	System Conn. ¹ NPTM (Inches)	Shipping Weight (lbs.) Max. Working Pressure		
						100 PSI	150 PSI	175 PSI
WX-101C-DD	2.0	0.9	8	14	3/4	10	10	12
WX-102C-DD	6.4	3.2	12	18	3/4	26	26	28
WX-103C-DD	8.6	3.2	12	22	3/4	36	36	38

¹Stainless Steel System Connection.
Maximum Operating Temperature: 200°F. Factory Pre-charge: 25 PSIG.

Commercial Water Systems Tanks

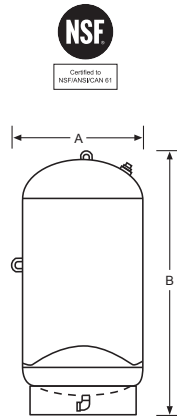

Head & Shell Construction Diaphragm Models

- Industry's thickest butyl diaphragm for extra long life.
- Patented Anti-Legionella liner neutralizes bacteria on contact.
- Tested to JIS Z 2801 for reduction of Legionella, staphylococcus and E. coli.
- Follows ASHRAE 188 Anti-Legionella guidelines.
- Patented Turbulator® prevents sediment buildup.
- NSF/ANSI/CAN STD 61.

ASME Diaphragm Series Specifications

Model Number	Tank Volume (Gallons)	Max. Accept. Volume (Gallons)	A Diameter (Inches)	B Length (Inches)	System Conn. ¹ NPTF (Inches)	Shipping Weight (lbs.) Max. Working Pressure				
						125 PSI	150 PSI	175 PSI	250 PSI	300 PSI
WX-401C	18	11	16	31	1	77	96	110	126	133
WX-402C	25	11	16	40	1	93	113	125	145	160
WX-403C	34	11	16	49	1	115	120	145	183	200
WX-404C	68	34	24	48	1¼	227	232	313	411	432
WX-405C	90	34	24	59	1¼	252	255	384	433	460
WX-406C	110	34	24	70	1¼	286	335	402	475	500
WX-407C	132	46	30	57	1¼	436	450	510	570	625

¹Malleable Iron System Connection.
Maximum Operating Temperature: 200°F. Factory Pre-charge: 25 PSIG.

Guardian CP® Digital Pump Control

Protects Submersible and Jet Pumps from Costly Damage

- E1 Rapid Cycle: Alerts user before pump damage occurs.
- E2 Low Water Cutoff: Shuts off pump when pressure drops below 10 psig. Pump automatically restarts every 60 minutes.
- E3 Improper Voltage: Shuts off pump until proper voltage is detected.

Operates as a Pump Control and a Pressure Gauge

- Adjustable from 10 to 80 psig, in 1 psig increments.
- Digital LED display accurately shows current system pressure.

10 psig Differential Produces City-Like Water Pressure

- Tight differential setting (10 psig) narrows pressure fluctuations.
- Typical setting (20 psig) can be programmed with digital accuracy.
- Maximum 55 psig differential provides maximum flexibility.

Built Tough for Reliable Performance

- Durable NEMA 3 enclosure for indoor and outdoor applications.
- UL listed for pumps up to 2 HP; can be used with motor controllers.
- Protected against line voltage noise and external interference.

Easy to Install on New or Existing Systems

- Familiar 4-wire configuration with pre-stripped leads.
- Offset conduit holes provide added wiring space.
- Automatically recognizes 115 or 230VAC systems.
- Digital LED display can rotate 180° for easy viewing.

2-Year Warranty



Access cover is sealed against moisture and bugs.

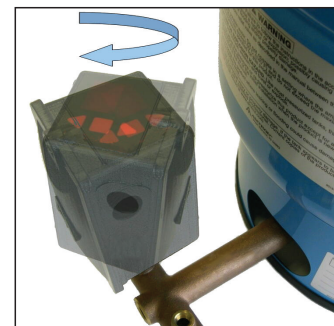

Spins on—no special fittings. LED display rotates 180°.



Commercial Water Systems Tanks

Full Acceptance Bladder Models

- Larger sizes for high flow systems.
- Replaceable bladder; full acceptance design.
- Industry's thickest heavy duty butyl bladder.
- NSF/ANSI/CAN STD 61.

ASME Full Acceptance Bladder Series Specifications

Model Number	Tank Volume (Gallons)	Max. Accept. Volume (Gallons)	A Diameter (Inches)	B Height (Inches)	System Conn. ¹ NPTF (Inches)	Shipping Weight (lbs.) Max. Working Pressure				
						125 PSI	150 PSI	175 PSI	250 PSI	300 PSI
WX-447C	53	53	24	45	2	263	289	368	420	462
WX-448C	80	80	24	59	2	315	338	430	492	540
WX-449C	106	106	24	73	2	319	350	440	507	557
WX-450C	132	132	24	87	2	351	392	454	570	627
WX-451C	158	158	30	73	2	493	587	680	813	894
WX-452C	211	211	30	91	2	602	627	694	1,007	1,107
WX-453C	264	264	36	86	3	676	752	846	1,095	1,204
WX-454C	317	317	36	98	3	762	840	959	1,264	1,390
WX-455C	370	370	36	110	3	843	930	1,060	1,350	1,485
WX-456C	422	422	48	82	3	1,154	1,418	1,655	1,700	1,826
WX-457C	528	528	48	97	3	1,331	1,500	1,870	2,231	2,450
WX-458C	660	660	60	84	4	1,450	1,740	2,030	2,320	2,750
WX-459C	792	792	60	99	4	2,169	2,385	3,036	3,470	3,690
WX-460C	925	925	60	107	4	2,300	2,530	3,220	3,680	3,910
WX-461C	1,056	1,056	60	121	4	2,638	2,900	3,695	4,220	4,485
WX-462C	1,320	1,320	72	104	4	3,500	3,850	4,900	5,600	5,950
WX-463C	1,980	1,980	72	140	4	4,100	4,510	5,740	6,560	6,970

¹Malleable Iron System Connection.
Maximum Operating Temperature: 240°F. Factory Pre-charge: 25 PSIG.

Partial Acceptance Bladder Models

- Replaceable bladder; partial acceptance design.
- Industry's thickest heavy duty butyl bladder.
- Available in compact sizes for limited space.

ASME Partial Acceptance Bladder Series Specifications

Model Number	Tank Volume (Gallons)	Max. Accept. Volume (Gallons)	A Diameter (Inches)	B Height (Inches)	System Conn. ¹ NPTF (Inches)	Shipping Weight (lbs.) Max. Working Pressure
						125 PSI
WX-35CL	10	10	10	37	1¼	69
WX-50CL	13	11	12	37	1¼	76
WX-85CL	22	11	16	35	1¼	92
WX-100CL	26	11	16	39	1¼	98
WX-130CL	34	27	20	35	1½	136
WX-165CL	44	27	20	40	1½	146
WX-200CL	53	27	24	41	1½	198
WX-300CL	80	27	24	56	1½	236
WX-400CL	106	53	24	69	2	282
WX-500CL	132	53	24	83	2	316
WX-600CL	158	53	30	67	2	450

¹Malleable Iron System Connection.
Maximum Operating Temperature: 240°F. Factory Pre-charge: 25 PSIG

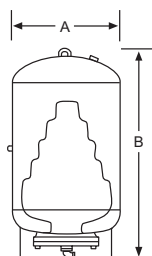
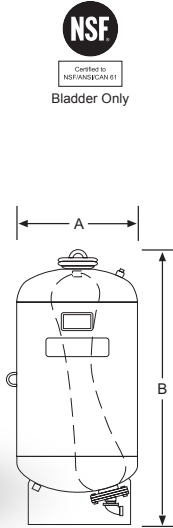

1400 Division Road, West Warwick, RI 02893 USA
T: 800.426.8765 www.amtrol.com

