

**NOW WITH QUICK
ACCESS END PANELS**

Low Profile Unit Cooler

Publication No. 411.3 rev.2
January, 2004

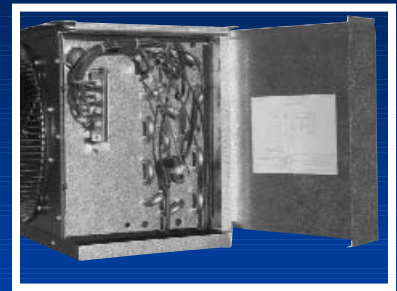

MEA

Air Defrost - 3,900 to 39,000 BTUH
Electric Defrost - 3,600 to 28,000 BTUH
Hot Gas Defrost - 3,600 to 28,000 BTUH

Small to Medium
Walk - Ins

Coolers & Freezer
Applications



Features

The Witt Super-Flo is the original low profile unit cooler that has established an industry standard as being the all purpose design for walk-in coolers, freezers and other applications. They feature an air draw-through design offering air, electric and hot gas defrost models.

Sizes

There are 35 sizes available with 3,700 to 39,000 BTUH at a 10° TD ranging from 740 to 4,980 cfm. One through six fan models are available.

Housing

Rust-free, heavy gauge, textured Aluminum casing is light weight yet durable. Each fan section is baffled to prevent short cycling of the air. The unit is designed to mount flush to the ceiling and meets all NSF requirements. Slotted hangers are provided for easy installation. Drain fittings are installed in the horizontal position to gain more usable head-room in low ceiling applications. The end panels now are hinged to open up out for easy access to both the piping and electrical ends. Optional expansion valves can be conveniently installed inside the cabinet.

Coil

Seamless Copper tubes are staggered and mechanically expanded into corrugated Aluminum fins and heavy gauge tube sheets to achieve maximum heat transfer and strength. Die formed fin collars provide even fin spacing. Fin spacings available are 4, 6, and 8 fins per inch. Sweat connections are standard on all models and optional field installed flare connection kits are available at no extra charge.

Motors

All motors are 1/20 HP, permanently lubricated, ball bearing, with thermal overload protection. Available in 115V, 208/230V and optional 460V, single Phase. Optional high efficiency PSC motors are available in 115V and 230V.

Fans

Heavy duty 12" Aluminum fans are balanced to provide vibration-free operation. Our new low throw black plastic fan guards have an improved air pattern. The optional epoxy resin high throw fan guard moves air up to 50 feet.

Air Defrost

All models with the prefix "SA" are designed for use in coolers of 35°F and warmer. Complete air defrost systems for off-cycle or timed air defrost are available from Witt.

Electrical

Available in 115V, 208/230V, and 460V (see page 4). All components are factory wired to convenient screw-type terminal strips. A large compartment is supplied internal to the unit for all electrical components and is easily accessible by removing the end panel. All models are UL & cUL listed.

Electric Defrost

Available on all models with the prefix "SE". Designed for use where electric heat is used to defrost. Placement of the heaters internal to the coil allows for an extremely rapid and efficient defrost. This arrangement enables the heat to be conducted through the fins from the center out for an even defrost pattern. All heaters are wired to a terminal strip to allow a quick field change-over from single phase to three phase, 230V to 460V and vice versa. A lower heater is installed close to the drain pan for fast, reliable drainage. A defrost termination thermostat (DT) terminates the defrost cycle when the temperature is satisfied. A heater safety thermostat is installed to prevent heaters from overheating above 75° in case of DT failure. All heaters are flexible and can be easily replaced within 12 inches of the end of the units. A fan delay thermostat is supplied to allow the warm coil to cool after a defrost cycle prior to the fans turning on. Complete electric defrost refrigeration systems are available from Witt.

Hot Gas Defrost

Two types available - Re-Evap models with the prefix "SH" and reverse cycle with the prefix "SG". All models include a fixed DTFD factory wired and a hot gas drain pan circuit to defrost the drain pan. On all Hot Gas models, the drain fitting is located on the left-hand rear of the unit when facing the fan guards. Re-eva models include a Heat Exchanger-Re-Evaporator shipped together with the unit for field installation. Complete Re-Evap Refrigeration Systems are available from Witt. Contact factory for piping information.

Optional Features

- High efficiency PSC fan motors
- 460 volt motors and heaters
- Coated Aluminum fins or Copper Fins
- Baked white enamel housing
- Epoxy resin high throw guards for up to 50 ft.
- Reheat kits (not UL listed)
- Factory mounted expansion valves

QUICK ACCESS SLOTTED HINGE END PANELS

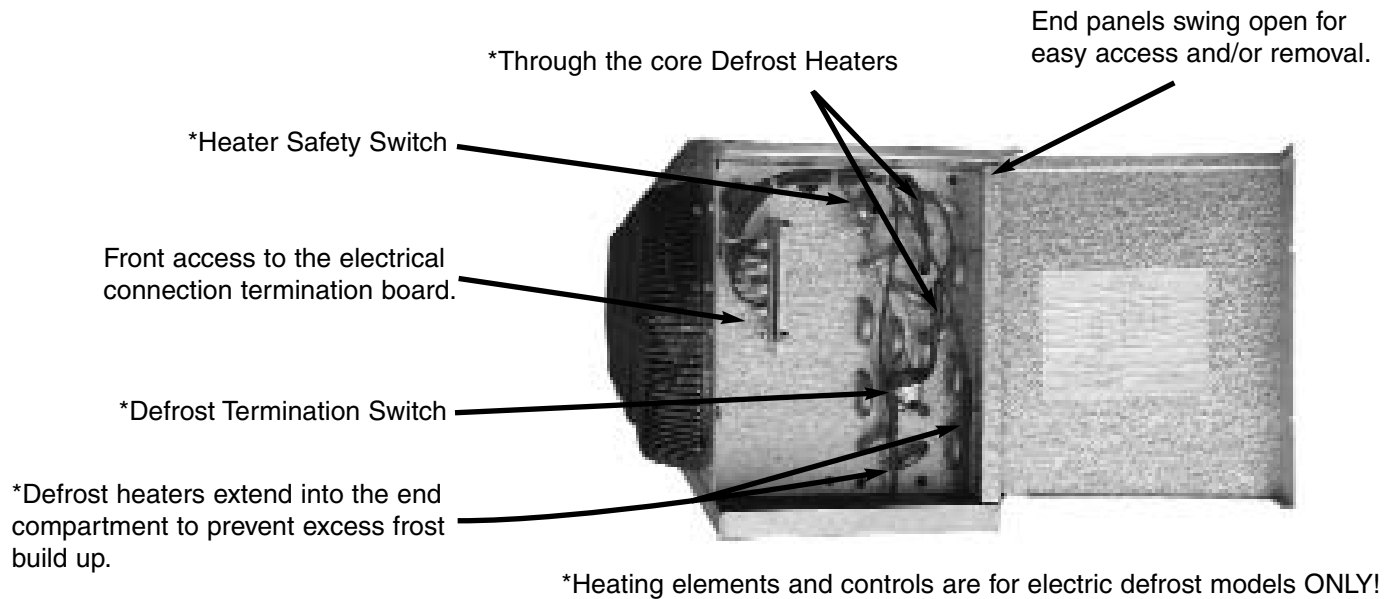
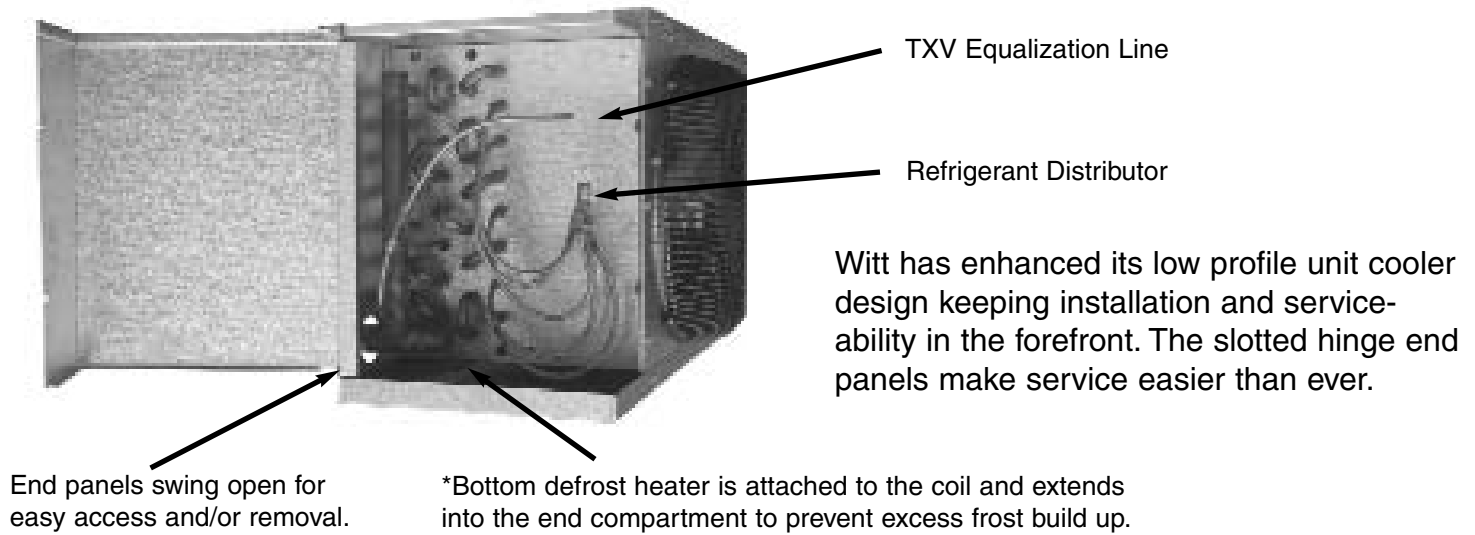

Nomenclature

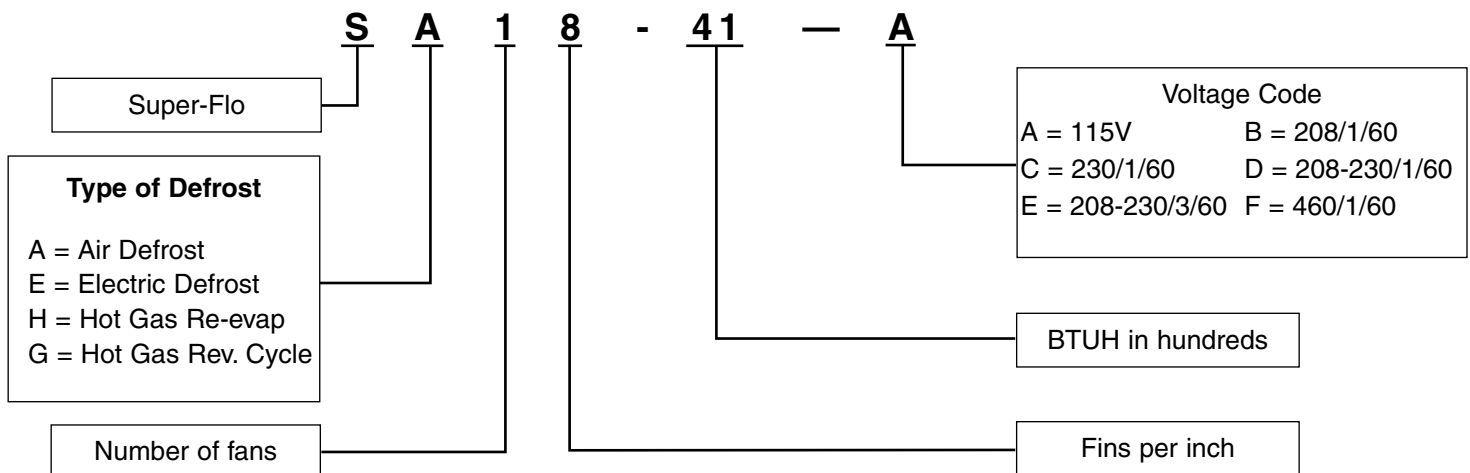



Air Defrost / Specifications

	Model Number	BTUH Capacity @ 25°F S.T.		CFM	Total Fan Motor AMPS - 1 Phase				
		10° TD	12° TD		Standard Motor			Optional PSC Motor	
					115V	230V	460V	115V	230V
8 FPI	SA18-41	4,100	4,900	800	2.0	1.0	0.5	1.0	0.5
	SA18-53	5,300	6,400	770	2.0	1.0	0.5	1.0	0.5
	SA18-66	6,600	7,900	740	2.0	1.0	0.5	1.0	0.5
	SA28-76	7,600	9,100	1,460	4.0	2.0	1.0	2.0	1.0
	SA28-97	9,700	11,600	1,420	4.0	2.0	1.0	2.0	1.0
	SA28-106	10,600	12,700	1,540	4.0	2.0	1.0	2.0	1.0
	SA28-122	12,200	14,600	1,380	4.0	2.0	1.0	2.0	1.0
	SA28-134	13,400	16,100	1,480	4.0	2.0	1.0	2.0	1.0
	SA38-160	16,000	19,200	2,310	6.0	3.0	1.5	3.0	1.5
	SA38-195	19,500	23,400	2,220	6.0	3.0	1.5	3.0	1.5
	SA48-212	21,200	25,400	3,080	8.0	4.0	2.0	4.0	2.0
	SA48-264	26,400	31,700	2,960	8.0	4.0	2.0	4.0	2.0
SA58-275	27,500	33,000	3,850	10.0	5.0	2.5	5.0	2.5	
SA68-318	31,800	38,200	4,620	12.0	6.0	3.0	6.0	3.0	
SA68-390	39,000	46,800	4,440	12.0	6.0	3.0	6.0	3.0	
6 FPI	SA16-39	3,900	4,700	830	2.0	1.0	0.5	1.0	0.5
	SA16-48	4,800	5,800	800	2.0	1.0	0.5	1.0	0.5
	SA16-58	5,800	7,000	780	2.0	1.0	0.5	1.0	0.5
	SA26-70	7,000	8,400	1,540	4.0	2.0	1.0	2.0	1.0
	SA26-87	8,700	10,400	1,500	4.0	2.0	1.0	2.0	1.0
	SA26-115	11,500	13,800	1,560	4.0	2.0	1.0	2.0	1.0
	SA36-145	14,500	17,400	2,400	6.0	3.0	1.5	3.0	1.5
	SA36-170	17,000	20,400	2,340	6.0	3.0	1.5	3.0	1.5
	SA46-192	19,200	23,000	3,200	8.0	4.0	2.0	4.0	2.0
	SA46-230	23,000	27,600	3,120	8.0	4.0	2.0	4.0	2.0
SA56-245	24,500	29,400	4,000	10.0	5.0	2.5	5.0	2.5	
SA66-295	29,500	35,400	4,800	12.0	6.0	3.0	6.0	3.0	
SA66-345	34,500	41,400	4,680	12.0	6.0	3.0	6.0	3.0	
4 FPI	SA14-42	4,200	5,000	830	2.0	1.0	0.5	1.0	0.5
	SA24-84	8,400	10,100	1,660	4.0	2.0	1.0	2.0	1.0
	SA24-105	10,500	12,600	1,620	4.0	2.0	1.0	2.0	1.0
	SA34-130	13,000	15,600	2,490	6.0	3.0	1.5	3.0	1.5
	SA44-170	17,000	20,400	3,320	8.0	4.0	2.0	4.0	2.0
	SA54-215	21,500	25,800	4,150	10.0	5.0	2.5	5.0	2.5
SA64-255	25,500	30,600	4,980	12.0	6.0	3.0	6.0	3.0	

Ordering Information Required

It is vital that the information listed below is given with each evaporator order. Orders without this information may be delayed. Evaporators with options such as solenoid and expansion valves will not be processed until all the required information is given.

- (1) Model Number
- (2) Voltage, frequency and phase of motors and heaters (when applicable)
- (3) Refrigerant type
- (4) Evaporator temperature
- (5) Evaporator T.D.

Electric Defrost / Specifications

	Model Number	BTUH Capacity @ 10° T.D. Evaporator Temperature				CFM	Motor Amps ¹			Heater Amps ²			Watts
		-30°	-20°	-10°	+20°		Standard		PSC	208/230V		460V	
							230V	460V	230V	1 PH	3 PH	1 PH	
6 FPI	SE16-36	3,400	3,600	3,700	3,900	830	1.0	0.5	0.5	4.4	2.6	2.2	1,000
	SE16-41	3,900	4,100	4,300	4,800	800	1.0	0.5	0.5	4.4	2.6	2.2	1,000
	SE16-46	4,400	4,600	4,800	5,800	780	1.0	0.5	0.5	4.4	2.6	2.2	1,000
	SE26-60	5,700	6,000	6,200	7,000	1,540	2.0	1.0	1.0	7.0	6.0	3.5	1,600
	SE26-75	7,100	7,500	7,800	8,700	1,500	2.0	1.0	1.0	7.0	6.0	3.5	1,600
	SE26-92	8,700	9,200	9,600	11,500	1,560	2.0	1.0	1.0	8.7	7.5	4.4	2,000
	SE36-120	11,400	12,000	12,500	14,500	2,400	3.0	1.5	1.5	13.0	11.3	6.4	3,000
	SE36-140	13,300	14,000	14,600	17,000	2,340	3.0	1.5	1.5	13.0	11.3	6.4	3,000
	SE46-164	15,000	16,400	17,100	19,200	3,200	4.0	2.0	2.0	17.4	15.1	8.7	4,000
SE46-185	17,600	18,500	19,200	23,000	3,120	4.0	2.0	2.0	17.4	15.1	8.7	4,000	
4 FPI	SE56-210	20,000	21,000	21,800	24,500	4,000	5.0	2.5	2.5	—	18.8	10.9	5,000
	SE66-245	23,300	24,500	25,500	29,500	4,800	6.0	3.0	3.0	—	22.6	13.0	6,000
	SE66-280	26,600	28,000	29,100	34,500	4,680	6.0	3.0	3.0	—	22.6	13.0	6,000
	SE14-37	3,500	3,700	3,800	4,200	830	1.0	0.5	0.5	4.4	2.6	2.2	1,000
	SE24-72	6,800	7,200	7,500	8,400	1,660	2.0	1.0	1.0	8.7	7.5	4.4	2,000
	SE24-85	8,100	8,500	8,800	10,500	1,620	2.0	1.0	1.0	8.7	7.5	4.4	2,000
	SE34-105	10,000	10,500	10,900	13,000	2,490	3.0	1.5	1.5	13.0	11.3	6.4	3,000
	SE44-140	13,300	14,000	14,600	17,000	3,320	4.0	2.0	2.0	17.4	15.1	8.7	4,000
	SE54-180	17,100	18,000	18,700	21,500	4,150	5.0	2.5	2.5	—	18.8	10.9	5,000
SE64-215	20,400	21,500	22,400	25,500	4,980	6.0	3.0	3.0	—	22.6	13.0	6,000	

- (1) All fan motors are wired for single phase. Standard motors are shaded pole. High efficiency PSC (Permanent Split Capacitor) motors are optional.
- (2) For 208/230 volt models, heaters are wired as standard for single phase on 1 through 4 fan models. 5 and 6 fan models are wired 3 phase. 460 Volt models are only available in single phase and are compatible with all 3 phase systems.

Hot Gas Defrost / Specifications

	Model Number		BTUH Capacity @ 10° T.D. Evaporator Temperature				CFM	Fan Motor Amps ¹					Re-Evap
	Re-Evap	Rev. Cycle	-30°	-20°	-10°	+20°		Standard			PSC		HEA
								115V	230V	460V	115V	230V	Unmtd.
6 FPI	SH16-36	SG16-36	3,400	3,600	3,700	3,900	830	1.0	1.0	0.5	1.0	0.5	1A
	SH16-41	SG16-41	3,900	4,100	4,300	4,800	800	1.0	1.0	0.5	1.0	0.5	1A
	SH16-46	SG16-46	4,400	4,600	4,800	5,800	780	1.0	1.0	0.5	1.0	0.5	1A
	SH26-60	SG26-60	5,700	6,000	6,200	7,000	1,540	2.0	2.0	1.0	2.0	1.0	2A
	SH26-75	SG26-75	7,100	7,500	7,800	8,700	1,500	2.0	2.0	1.0	2.0	1.0	2A
	SH26-92	SG26-92	8,700	9,200	9,600	11,500	1,560	2.0	2.0	1.0	2.0	1.0	2A
	SH36-120	SG36-120	11,400	12,000	12,500	14,500	2,400	3.0	3.0	1.5	3.0	1.5	3A
	SH36-140	SG36-140	13,300	14,000	14,600	17,000	2,340	3.0	3.0	1.5	3.0	1.5	3A
	SH46-164	SG46-164	15,000	16,400	17,100	19,200	3,200	4.0	4.0	2.0	4.0	2.0	3A
SH46-185	SG46-185	17,600	18,500	19,200	23,000	3,120	4.0	4.0	2.0	4.0	2.0	3A	
4 FPI	SH56-210	SG56-210	20,000	21,000	21,800	24,500	4,000	5.0	5.0	2.5	5.0	2.5	3A
	SH66-245	SG66-245	23,300	24,500	25,500	29,500	4,800	6.0	6.0	3.0	6.0	3.0	4A
	SH66-280	SG66-280	26,600	28,000	29,100	34,500	4,680	6.0	6.0	3.0	6.0	3.0	4A
	SH14-37	SG14-37	3,500	3,700	3,800	4,200	830	1.0	1.0	0.5	1.0	0.5	1A
	SH24-72	SG24-72	6,800	7,200	7,500	8,400	1,660	2.0	2.0	1.0	2.0	1.0	2A
	SH24-85	SG24-85	8,100	8,500	8,800	10,500	1,620	2.0	2.0	1.0	2.0	1.0	2A
	SH34-105	SG34-105	10,000	10,500	10,900	13,000	2,490	3.0	3.0	1.5	3.0	1.5	2A
	SH44-140	SG44-140	13,300	14,000	14,600	17,000	3,320	4.0	4.0	2.0	4.0	2.0	3A
	SH54-180	SG54-180	17,100	18,000	18,700	21,500	4,150	5.0	5.0	2.5	5.0	2.5	3A
SH64-215	SG64-215	20,400	21,500	22,400	25,500	4,980	6.0	6.0	3.0	6.0	3.0	3A	

- (1) All fan motors are wired for single phase

Physical Data

Models		TXV TYPE	Refrigerant Connections				No. of Hangers	Dimensions (Inches)				Ship Wt. (lbs.)
			All Liquid†	SA Suction	SE/SH/SG Suction	HG‡		A	B	C	W	
18-41	—	EXT	1/2 ODS	5/8 ODS	—	—	2	19	—	—	27½	33
18-53	—	EXT	1/2	5/8	—	—	2	19	—	—	27½	34
18-66	—	EXT	1/2	5/8	—	—	2	19	—	—	27½	36
28-76	—	EXT	1/2	5/8	—	—	2	33	—	—	41½	48
28-97	—	EXT	1/2	7/8	—	—	2	33	—	—	41½	51
28-106	—	EXT	1/2	7/8	—	—	2	37	—	—	45½	58
28-122	—	EXT	1/2	7/8	—	—	2	33	—	—	41½	60
28-134	—	EXT	1/2	7/8	—	—	2	37	—	—	45½	63
38-160	—	EXT	1/2	1-1/8	—	—	2	55	—	—	63½	79
38-195	—	EXT	1/2	1-1/8	—	—	2	55	—	—	63½	84
48-212	—	EXT	1/2	1-1/8	—	—	3	36½	36½	—	81½	254
48-264	—	EXT	1/2	1-1/8	—	—	3	36½	36½	—	81½	262
58-275	—	EXT	1/2	1-1/8	—	—	3	54½	36½	—	99½	312
68-318	—	EXT	1/2	1-1/8	—	—	4	36½	36	36½	117½	354
68-390	—	EXT	1/2	1-1/8	—	—	4	36½	36	36½	117½	370
16-39	16-36	EXT	1/2 ODS	5/8 ODS	5/8 ODS	5/8 ODS	2	19	—	—	27½	41
16-48	16-41	EXT	1/2	5/8	5/8	5/8	2	19	—	—	27½	44
16-58	16-46	EXT	1/2	5/8	5/8	5/8	2	19	—	—	27½	47
26-70	26-60	EXT	1/2	5/8	7/8	5/8	2	33	—	—	41½	54
26-87	26-75	EXT	1/2	7/8	7/8	5/8	2	33	—	—	41½	55
26-115	26-92	EXT	1/2	7/8	7/8	5/8	2	37	—	—	45½	62
36-145	36-120	EXT	1/2	7/8	7/8	5/8	2	55	—	—	63½	78
36-170	36-140	EXT	1/2	1-1/8	1-1/8	5/8	2	55	—	—	63½	85
46-192	46-164	EXT	1/2	1-1/8	1-1/8	5/8	3	36½	36½	—	81½	255
46-230	46-185	EXT	1/2	1-1/8	1-1/8	5/8	3	36½	36½	—	81½	265
56-245	56-210	EXT	1/2	1-1/8	1-1/8	5/8	3	54½	36½	—	99½	306
66-295	66-245	EXT	1/2	1-1/8	1-1/8	5/8	4	36½	36	36½	117½	353
66-345	66-280	EXT	1/2	1-1/8	1-1/8	5/8	4	36½	36	36½	117½	368
14-42	14-37	EXT	1/2 ODS	5/8 ODS	5/8 ODS	5/8 ODS	2	19	—	—	27½	42
24-84	24-72	EXT	1/2	7/8	7/8	5/8	2	37	—	—	45½	49
24-105	24-85	EXT	1/2	7/8	7/8	5/8	2	37	—	—	45½	55
34-130	34-105	EXT	1/2	7/8	7/8	5/8	2	55	—	—	63½	79
44-170	44-140	EXT	1/2	7/8	1-1/8	5/8	3	36½	36½	—	81½	251
54-215	54-180	EXT	1/2	1-1/8	1-1/8	5/8	3	54½	36½	—	99½	299
64-255	64-215	EXT	1/2	1-1/8	1-1/8	5/8	4	36½	36	36½	117½	340

† Optional Extended Flare Kit available upon request for field installation.

‡ Hot Gas connections only apply to the SH models.

Installation Notes:

- (1) Install 12" away from back wall.
- (2) Drain connection on SA and SE units are centered on drain pan; and on the left end (facing air discharge) on SH and SG units.
- (3) For long air throw requirements, specify high throw fan guard.
- (4) Unit height at drain end of hot gas models is as follows: 1, 2, and 3 fan models = 15-7/8", 4, 5, and 6 fan models = 16-1/4".

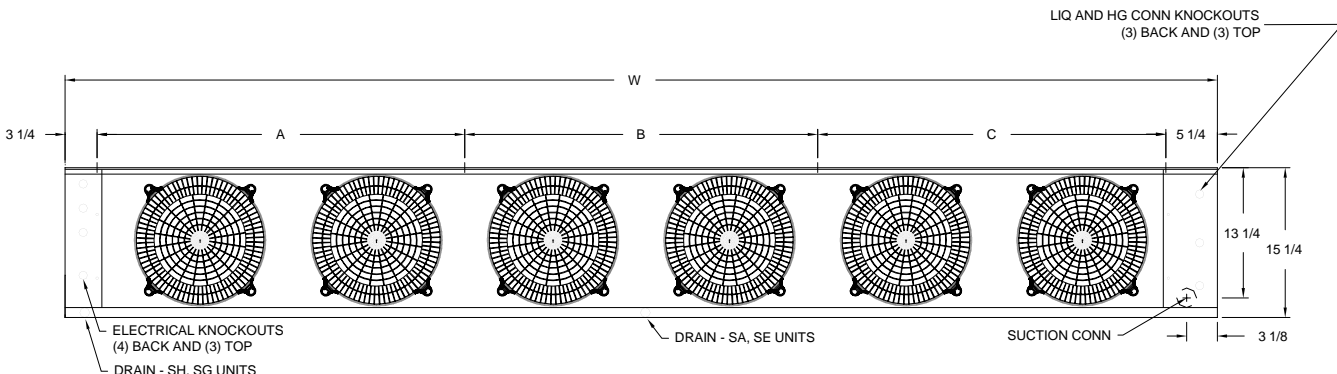
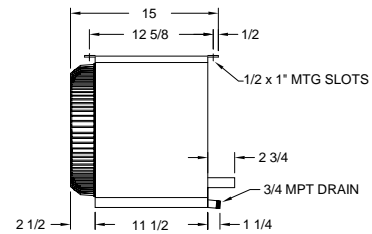

Electric Defrost Kits

Model Number	1 Unit Cooler Per System		2 Unit Coolers Per System		3 Unit Coolers Per System	
	230V	460V	230V	460V	230V	460V
SE16-36	ED-10	ED-12	ED-20*	ED-22	ED-30	ED-32
SE16-41	ED-10	ED-12	ED-20*	ED-22	ED-30	ED-32
SE16-46	ED-10	ED-12	ED-20*	ED-22	ED-30	ED-32
SE26-60	ED-10	ED-12	ED-20*	ED-22	ED-30	ED-32
SE26-75	ED-10	ED-12	ED-20*	ED-22	ED-30	ED-32
SE26-92	ED-10	ED-12	ED-20*	ED-22	ED-30	ED-32
SE36-120	ED-10	ED-12	ED-20*	ED-22	ED-33	ED-32
SE36-140	ED-10	ED-12	ED-20*	ED-22	ED-33	ED-32
SE46-164	ED-10	ED-12	ED-23*	ED-22	ED-35	ED-32
SE46-185	ED-10	ED-12	ED-23*	ED-22	ED-35	ED-32
SE56-210	ED-11	ED-12	ED-23*	ED-22	ED-35	ED-34
SE66-245	ED-11	ED-12	ED-23*	ED-22	ED-35	ED-34
SE66-280	ED-11	ED-12	ED-23*	ED-22	ED-35	ED-34
SE14-37	ED-10	ED-12	ED-20*	ED-22	ED-30	ED-32
SE24-72	ED-10	ED-12	ED-20*	ED-22	ED-30	ED-32
SE24-85	ED-10	ED-12	ED-20*	ED-22	ED-30	ED-32
SE34-105	ED-10	ED-12	ED-20*	ED-22	ED-33	ED-32
SE44-140	ED-10	ED-12	ED-23*	ED-22	ED-35	ED-32
SE54-180	ED-11	ED-12	ED-23*	ED-22	ED-35	ED-34
SE64-215	ED-11	ED-12	ED-23*	ED-22	ED-35	ED-34

Electric defrost kits consist of components that are necessary to control the defrost cycle. The optional kits are available as a factory installed option when ordered with a condensing unit. Not all Ed-Kits are available for all condensing unit models. The contents of each kit is described below, along with the function of each component.

* - 1/2 through 3 HP models require ED-210 or ED-213.

Electric Defrost Kits

KIT NO.	TIMER	AUXILIARY SWITCH	BLOCK-OUT RELAY	DEFROST CONTACTOR	FAN CONTACTOR	SEQUENCING RELAY
ED10-230/1	1	—	1-30A	—	—	—
ED11-230/3	1	1	—	1-30A	—	—
ED12-460/3	1	1	—	1-30A	1-25A	—
¹ ED210-230/1	1	—	1-30A	—	—	—
¹ ED213-230/1	1	1	—	1-50A	—	—
¹ ED213-230/3	1	1	—	1-50A	—	—
ED20-230/1	1	—	1-30A	—	—	2
ED22-460/3	1	1	—	2-15A	1-25A	2
ED23-230/1	1	1	—	2-25A	—	2
ED23-230/3	1	1	—	2-25A	—	2
ED30-230/1	1	—	1-30A	—	—	3
ED32-460/3	1	1	—	3-10A	1-25A	3
ED33-230/1	1	1	—	3-16A	—	3
ED34-460/3	1	1	—	3-16A	1-25A	3
ED35-230/1	1	1	—	3-33A	—	3
ED35-230/3	1	1	—	3-33A	—	3

Timer: Initiates the defrost cycle. Also used as a override protection for defrost termination.

Auxiliary Switch: Is mounted on the compressor contactor and prevents the defrost contactor from operating whenever the compressor is energized.

Block-Out Relay: Serves the same function as auxiliary switch. Used when defrost contactor is not required (lower wattage single phase only).

Defrost Contactor: Carries amperage load for heaters.

Fan Contactor: Used with 460V motors or when 230V motors are wired 3 phase.

Sequencing Relays: Provides interconnection of multiple unit coolers on a single system so that each unit cooler is allowed to individually terminate defrost on temperature.

¹ For use with 2 evaporators , 1/2 through 3 HP G-series systems ONLY!



1/2 Through 80 HP

COMPLETE REFRIGERATION PACKAGES

- AIR DEFROST
- ELECTRIC DEFROST
- HOT GAS DEFROST

CONTACT YOUR WITT REPRESENTATIVE FOR DETAILS

Super-Flo

Low Profile Unit coolers



Inter-Flo

Medium Profile Unit Coolers

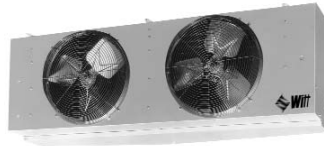

Polar-Flo

High Capacity Warehouse Unit Coolers

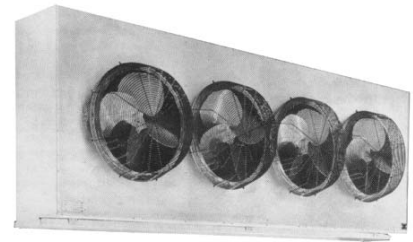

Proline

Cond. units 1/2 - 6 HP



WD-Series

Condensing Units 3-15 HP



WV-Series

Condensing Units 20-30 HP

