

Air Conditioning, Refrigeration, Plumbing, Heating, Automotive and Maintenance

HVAC/R & PLUMBING EQUIPMENT CATALOG

FOR U.S. JOBS



QUALITY TOOLS THAT GO TO WORK WITH YOU®



SINCE 1949



UNIWELD PRODUCTS, INC., FORT LAUDERDALE, FL 33312 U.S.A.



Since 1949, Uniweld, a U.S. Manufacturer, has employed over 300 workers who help design, manufacture, and distribute U.S. made products to be sold worldwide! As we celebrate 65 years of manufacturing excellence, our focus is ever set on the future to provide a superior product coupled with unmatched customer service. Uniweld's World Headquarters and manufacturing facility based in Ft. Lauderdale, FL has state of the art robotic CNC machines that produce quality flame tools, accessories, and pressure gauges for the air conditioning, refrigeration, plumbing, heating, automotive and maintenance industries. We thank you for supporting Uniweld Products...

"QUALITY TOOLS THAT GOES TO WORK WITH YOU!"

New Products

FOR U.S. JOBS
UNIWELD EMPLOYS OVER 300 WORKERS



USAM SPIRIT™ Manifold
R-410A/R-22/R-404A/R-134a
(see page 52)



RHP800
Nitrogen Regulator
(see page 79)



EZ TURN
EZ Turn Anti-Blowback
Fitting
(see page 71)



NV1 Nitrovue
Nitrogen Flow Indicator
(see page 78)



UTC704
Premium
Tubing Cutter
1/8" to 1 3/4" O.D.
(see page 87)

UTC701
Mini
Tubing Cutter
1/8" to 1" O.D.
(see page 86)



Uniweld Products, Inc. Fort Lauderdale, FL 33312 U.S.A. Customer Service: 800.323.2111
info@uniweld.com • www.uniweld.com



Introduction to Flame Tools

OVER 80% OF UNIWELD PRODUCTS ARE MADE IN THE USA



BRAZING



SOLDERING



CUTTING



WELDING

This catalog provides you with detailed information on a full range of Uniweld flame tools for the HVAC/R, Plumbing, Automotive and Industrial Maintenance professionals. When deciding on what flame tools are needed for your particular job application, it's a good idea to determine, "Will it be used specifically for welding or cutting steel, soldering or brazing copper tubing or should it be a multi-purpose outfit." We've provided the basic industry definitions for the above applications to help you decide what flame tools will be required to get the job done efficiently.

★ WELDING

Welding is the joining of similar metals by heating until molten and then fusing them together, usually with a similar filler material.

★ CUTTING

Cutting occurs when steel is heated to a pasty range (over 1600°F) and a jet of Oxygen is added into this heated area causing it to rapidly oxidize and separate.

★ SOLDERING & BRAZING

Basically, they're both very similar. It is the joining of metals through the use of heat and a filler metal. The difference between soldering and brazing is the temperature at which the filler material melts. If it melts below 800°F, it is soldering; above 800°F, it is brazing. In general, soldering will provide a permanent bond while brazing is preferred when vibration, temperature and higher tensile strength are considerations.

FIRE TRIANGLE

Fire consists of three basic elements. 1. Fuel; 2. Oxygen; 3. Ignition. This is called the Fire Triangle.

OXYACETYLENE

Combining Oxygen and Acetylene from two separate tanks produces a concentrated flame of approx. 5600°F, that is ideal for brazing copper tube, welding and cutting steel and general maintenance repairs. This type of flame tool is preferred by HVAC/R tradesmen because of its hot, concentrated flame with low heat transfer into sensitive components. Heat transfer is minimized with the use of proper tips.

AIR/ACETYLENE

These flame tools use a single tank of fuel and by induction of the outside air create an efficient flame. The target heat is 2700°F and is ideally suited for soldering and brazing copper tube. Tank size is usually a B (40 cu.ft.) or MC (10 cu.ft.)

AIR/LP GAS

These flame tools utilize a single tank of liquid petroleum fuel and by induction of the outside air create a flame. The most common LP fuels are Propane and MAP//Pro™ (Propylene). The target heat for Propane is 1750°F and for MAP//Pro™ it's 2400°F.



Uniweld Products, Inc. Fort Lauderdale, FL 33312 U.S.A. Customer Service: 800.323.2111 info@uniweld.com • www.uniweld.com



Table of Contents

1 Oxyacetylene



- 1 Introduction to Flame Tools
- 4-5 Mastar® Outfits
- 6-7 Cap'n Hook® Outfits
- 8-11 Patriot® Outfits
- 12-13 Centurion® Outfits
- 14 Cutting Attachments/Welding Handles
- 15 Oxyacetylene Operating Procedures and Safety Posters
- 16 Welding, Brazing and Cutting Tips
- 17 Rosebud Heating Tips and Flexible Brazing Tips
- 18 Tuning Fork® Tip and Micro 6000™ Miniature Tips
- 19 Cap'n Hook® High Performance Tips

4 Parts Accessories



- 34 Air Fuel Handles and Adaptors
- 35 Hoses: Single and Twin
- 36 Patriot® Series Regulators and Oxy/Fuel Adaptor
- 37 Mastar® and Centurion® Series Regulators and Replacement Gauges
- 38 CGA Cylinder Valve Connections
- 39 Adaptors and Hose Fittings
- 40 Cylinders, Tanks and Test Gauges
- 41 Carrying Stands and Cylinder Trucks
- 42 Accessories, Combination Wrenches, Goggles and Tip Cleaners
- 43 Flint Lighters, Plastic Tool Box
- 44 Flashback Arrestors and Check Valves
- 45 Cool Blue® Paste, Flame Barrier, Heat Guard

2 Air/Acetylene



- 20-21 Twister® 2 Self Igniting Tips and Kits
- 22 Twister® Tips
- 23 Twister® Kits and Components
- 24 Thruster® Kits and Components
- 25 Soft Flame Kits and Components
- 26 Specialty Tips

5 HVAC/R Tools



- 46 Humm-Vac® Vacuum Pumps
- 47 5.5 CFM and 1.5 CFM Vacuum Pumps
- 48 Vacuum Pump Replacement Parts and Vacuum Pump Oil
- 49 MaxEvac™ Kit and Valve Core Removal Kits
- 50 Electronic Refrigerant Scale
- 51 Vapor-View® A/C Flush Kit and Actuating Valve
- 52 Manifolds, SPIRIT Two-Valve Aluminum: R-410A/R-22/R-404A/R-134a
- 53 Manifolds, Four Valve Aluminum: R-410A/R-22/R-404A/R-134a
- 54 Manifolds, Two Valve Brass: 3/8" Gauges R-410A/R-22/R-404A/R-134a
- 55-56 Manifolds, Two Valve Brass: 2 1/2" Gauges R-22/R-404A/R134a

3 Air/LP



- 27 Twister® Kits and Tips
- 28 Thruster® Kits and Tips
- 29 Thruster® Swivl-IT Kits/Weed Burner
- 30 Pencil Point Flame Kits
- 31 Heat Shrink Kits/Tips
- 32 Hand Torches
- 33 Self-Igniting Hand Torches





Table of Contents

5 HVAC/R Tools



- 57 Manifold Replacement Parts
- 58-59 NPF[®] and LPF[™] Manifold Gauges
- 60 Soft Magic[®] Barrier Hose with Standard Fittings
- 61 Soft Magic[®] Barrier Hose with EZ-Turn Anti-Blowback Fittings
- 62 Soft Magic[®] Barrier Ball Valve Hoses
- 63 Ball Valve Adaptors and 6" Hoses
- 64 Soft Magic[®] Heavy Duty Vacuum and Charging Hoses
- 65 Super Black Magic[®] Refrigerant Hoses
- 66 Adaptors and Accessories
- 67 Propane Halide Leak Detector

6 Automotive A/C



- 68-69 R134a Automotive Manifold, Two Valve Brass and Aluminum
- 70 R134a Automotive Charging Hoses
- 71 R134a Automotive Service Couplers and Conversion Kits
- 72 Automotive A/C Flush Kit and Can Tap Valve
- 73 Automotive Oil/Dye Injector and A/C Adaptor Kit

7 Nitrogen, Air & CO₂



- 74 Nitrogen Sludge Sucker[®]/Blaster[®] Kits
- 75 Sludge Sucker[®], Maintenance and Accessory Kit
- 76 Sludge Sucker[®] Sludge Blaster and Drain Blaster
- 77 Blowgun, Blowgun Accessories, Rubber Plug Adaptors
- 78 NitroVue Nitrogen Flow Indicator
- 79 Nitrogen/CO₂ Regulators and Replacement Gauges

8 Tubing Tools



- 80 PVC Pipe Cutters
- 81 Ratchet Screwdrivers
- 82 Reversible and Offset Ratchet Wrenches
- 83 Deburring Tools/Pinchoff Tool
- 84 Heavy Duty Flaring Tools
- 85 Flaring and Swaging Tools
- 86-87 Premium Heavy Duty Tube Cutters
- 88 Standard and Mini Tubing Cutters
- 89 Quick Action Tubing Cutters
- 90 Ratchet Tube Bender
- 91 3-in-1 Triple Tube Bender/Lever Benders

9 Gauges/Thermometers



- 92 Gas Pressure Test Kit and Water Manometer
- 93 Tridicator Gauges and Bi-Metal Thermometers
- 94 Gas and Water Test Gauges
- 95 Utility Gauges
- 96 Liquid Filled Gauges
- 97 Replacement Welding Gauges/Lenses

10 Alloys



- 98 Aluminum Soft Solder Repair Kits
- 99 Silver Solder, Low Fuming Bronze Flux
- 99 Uni-Brite Silver Solder and Uni-1500FC Flux Coated Brazing Rod

General Information

- 100-106 Part Number Index
- 107 Uniweld Contact Information
- 108 NATE Flame Tool Safety Training
- 109-112 Marketing Sales/Aids



Uniweld Products, Inc. Fort Lauderdale, FL 33312 U.S.A. Customer Service: 800.323.2111
info@uniweld.com • www.uniweld.com

Ranked #1 for Commercial Refrigeration Technicians



Mastar® Outfits

FOR U.S. JOBS
UNIWELD EMPLOYS OVER 300 WORKERS

Highly rated by commercial refrigeration technicians, Mastar® outfits contain all the necessary top of the line components for welding, cutting and brazing.



- Industrial grade Mastar® series regulators with protective rubber gauge boots
- Rear valve welding handle with stainless steel ball point valves for accurate gas control
- Cutting attachment with one-piece solid copper mixer that cuts up to 1/2" steel with supplied cutting tip
- Rosebud tip for brazing up to 2 5/8" copper tubing
- Welding tip for brazing up to 1" copper tubing and welding up to 1/8" steel

KL550-TR



C = Metal Carrying Stand
C-T = Metal Carrying Stand & Tanks
P = Plastic Carrying Stand
P-T = Plastic Carrying Stand & Tanks
TR = Metal Hand Truck w/Wheels

Additional outfit options listed below include a variety of carrying stands and tanks*. Optional tips expand capabilities. See pages 16-19

| | Part# | UPC# | Welding Hand/Drills/dle | Welding/ Brazing Tip | Rosebud Heating Tip | Cutting Attachment | Cutting Tip | Oxygen Regulator | Acetylene Regulator | Carrying Stand | Tanks* |
|---------|------------|-------|-------------------------|----------------------|---------------------|--------------------|------------------------|------------------|---------------------|----------------|--------|
| Outfits | KL550-4 | 82200 | | | Type17-15 | | 5-101-0D | RS0 | RSMC2 | w/o | w/o |
| | KL550-4C | 82201 | | | Type17-15 | | 5-101-0D | RS0 | RSMC2 | 500S | w/o |
| | KL550-4C-T | 82202 | | | Type17-15 | | 5-101-0D | RS0 | RSMC2 | 500S | MC/R |
| | KL550-4P | 82205 | WH550 | Type17-2 | Type17-15 | CA550 | 5-101-0D | RS0 | RSMC2 | 511 | w/o |
| | KL550-4P-T | 82206 | | | Type17-15 | | 5-101-0D | RS0 | RSMC2 | 511 | MC/R |
| | KL550-5 | 82207 | | | Type17-15 | | 5-101-0D | RS0 | RSB2 | w/o | w/o |
| | KL550-TR | 82208 | | | w/o | | 5-101-2D | RS0 | RSB2 | 504 | w/o |
| | KL555-TR | 82259 | | | w/o | | 5-101-2D12106 [psi/kg] | 12107 [psi/kg] | | 504 | w/o |

Outfits Include: H32A [12.5] ft. Twin Hose, WG53 Goggles, FL34 Flint Lighter, W05 Tank Key w/chain.

*Tanks Shipped Empty



For Maintenance/Service Technicians



Master® Outfits

FOR U.S. JOBS
UNIWELD EMPLOYS OVER 300 WORKERS

This premium outfit includes all the components of the Master® outfit on page 4, plus an air/fuel adaptor that modifies the welding handle to be used with any of Uniweld's efficient quick connect air/acetylene tips.



KLT550-4

- Industrial grade Master® series regulators with protective rubber gauge boots
- Rear valve welding handle with stainless steel ball point valves for accurate gas control
- Cutting attachment with one-piece solid copper mixer that cuts up to 1/2" steel with supplied cutting tip. Optional cutting tips available for cutting up to 2" steel
- Rosebud tip for brazing up to 25/8" copper tubing
- Welding tip for brazing up to 1" copper tubing and welding up to 1/8" steel
- Twister® air/acetylene tip for plumbing and repair work



KLT550-4C-T

Additional outfit options listed below include a variety of carrying stands and tanks*. Optional tips expand capabilities. See pages 16-19

C = Metal Carrying Stand
C-T = Metal Carrying Stand & Tanks
P = Plastic Carrying Stand

P-T = Plastic Carrying Stand & Tanks
TR = Metal Hand Truck w/Wheels

| | Part# | UPC# | Welding Handle | Welding/ Brazing and Heating Tip | Acetylene Tip | Adaptor | Cutting Attachment | Cutting Tip | Oxygen Regulator | Acetylene Regulator | Carrying Stand | Tanks* |
|----------------|-------------|-------|----------------|-------------------------------------|---------------|---------|--------------------|-------------|------------------|---------------------|----------------|--------|
| Outfits | KLT550-4 | 82210 | | | | | | | | RSMC2 | w/o | w/o |
| | KLT550-4C | 82211 | | | | | | | | RSMC2 | 500S | w/o |
| | KLT550-4C-T | 82212 | | Type17-2 | A-8 Twister® | F13 | | | | RSMC2 | 500S | MC/R |
| | KLT550-4P | 82215 | WH550 | Type17-15 | Air/Fuel Tip | F13 | CA550 | 5-101-0D | RS0 | RSMC2 | 511 | w/o |
| | KLT550-4P-T | 82216 | | | | | | | | RSMC2 | 511 | MC/R |
| | KLT550-5 | 82217 | | | | | | | | RSB2 | w/o | w/o |
| | KLT550-5TR | 82218 | | | | | | | | RSB2 | 504 | w/o |

Outfits Include: H32A [12.5] Twin Hose, WG53 Goggles, FL34 Flint Lighter, W05 Tank Key w/chain.

*Tanks Shipped Empty



Uniweld Products, Inc. Fort Lauderdale, FL 33312 U.S.A. Customer Service: 800.323.2111
info@uniweld.com • www.uniweld.com

Premium Outfits for Welding and Brazing



Cap'n Hook® Outfits

FOR U.S. JOBS
UNIWELD EMPLOYS OVER 300 WORKERS

Premium portable outfits featuring Uniweld's popular patented Cap'n Hook® five flame tip for 100% wraparound brazing heat. Ideal for HVAC/R technicians and plumbers.

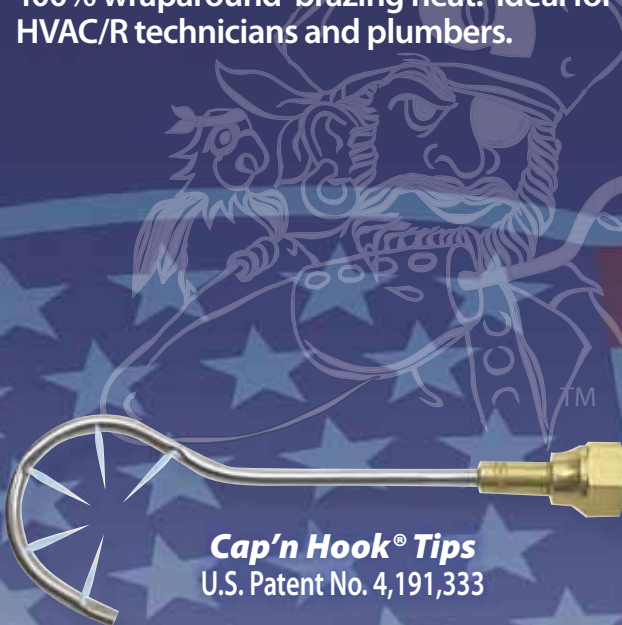

Cap'n Hook® Tips
U.S. Patent No. 4,191,333

- Single stage Patriot® series regulators with protective rubber gauge boots
- Front valve welding handle with stainless steel ball point valves for accurate gas control
- Welding tip for brazing up to 1" copper tubing and welding up to 1/8" steel
- NEW & Improved Cap'n Hook® 5 flame tip for brazing up to 1" copper tubing



FLIP UP GOGGLES



K22P-T

Additional outfit options listed below include a variety of carrying stands and tanks*. Optional tips expand capabilities. See pages 16-19

C = Metal Carrying Stand
C-T = Metal Carrying Stand & Tanks
P = Plastic Carrying Stand
P-T = Plastic Carrying Stand & Tanks

| | Part# | UPC# | Welding Handle | Welding/Brazing Tip | Oxygen Regulator | Acetylene Regulator | Carrying Stand | Tanks* |
|---------------------|--------|-------|----------------|-----------------------|------------------|---------------------|----------------|--------|
| Cap'n Hook® Outfits | K22 | 82339 | | | | | w/o | w/o |
| | K22C | 82340 | | Type17-2 | | | 500S | w/o |
| | K22C-T | 82341 | 71 | MTF-5 Cap'n Hook® Tip | RO | RMC2 | 500S | MC/R |
| | K22P | 82344 | | | | | 511 | w/o |
| | K22P-T | 82345 | | | | | 511 | MC/R |

Outfits Include: H32A [12.5 ft.] Twin Hose, WG53 Goggles, FL34 Flint Lighter, W05 Tank Key w/chain.

*Tanks Shipped Empty



Premium Outfits for Cutting, Welding and Brazing



Cap'n Hook® Outfits

FOR U.S. JOBS
UNIWELD EMPLOYS OVER 300 WORKERS

A cutting attachment and cutting tip have been added to the Cap'n Hook® outfit on page 6. You now have the added ability of cutting up to 1/2" steel with the supplied tip. The Cap'n Hook® five flame tip provides a stable, wraparound flame.

KL22C-T



FLIP UP GOGGLES

Cap'n Hook® Tips
U.S. Patent No. 4,191,333

- Single stage Patriot® series regulators with protective rubber gauge boots
- Front valve welding handle with stainless steel ball point valves for accurate gas control
- Cutting attachment with three tube tip mix for top performance and safety that cuts up to 1/2" steel with supplied tip
- Optional cutting tips available for cutting up to 2" steel
- NEW & Improved Cap'n Hook® 5 flame tip for brazing up to 1" copper tubing
- Welding tip for brazing up to 1" copper tubing and welding up to 1/8" steel

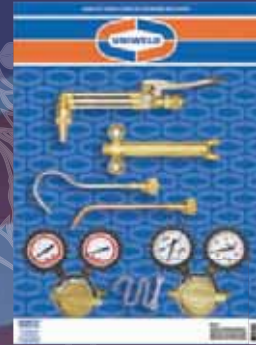

KL22



Additional outfit options listed below include a variety of carrying stands and tanks*. Optional tips expand capabilities. See pages 16-19

C = Metal Carrying Stand
C-T = Metal Carrying Stand & Tanks
P = Plastic Carrying Stand
P-T = Plastic Carrying Stand & Tanks

| | Part# | UPC# | Welding Handle | Welding Brazing Tip | Cutting Attachment | Cutting Tip | Oxygen Regulator | Acetylene Regulator | Carrying Stand | Tanks* |
|---------------------|---------|-------|----------------|-----------------------|--------------------|-------------|------------------|---------------------|----------------|--------|
| Cap'n Hook® Outfits | KL22 | 82500 | | | | | | | w/o | w/o |
| | KL22C | 82501 | | Type17-2 | | | | | 500S | w/o |
| | KL22C-T | 82502 | 71 | MTF-5 Cap'n Hook® Tip | CA100 | CT100-0D | R0 | RMC2 | 500S | MC/R |
| | KL22P | 82505 | | | | | | | 511 | w/o |
| | KL22P-T | 82506 | | | | | | | 511 | MC/R |

Outfits Include: H32A [12.5 ft.] Twin Hose, WG53 Goggles, FL34 Flint Lighter, W05 Tank Key w/chain.

*Tanks Shipped Empty



Uniweld Products, Inc. Fort Lauderdale, FL 33312 U.S.A. Customer Service: 800.323.2111
info@uniweld.com • www.uniweld.com

Tech favorite for Welding, Brazing and Cutting



Patriot® Outfits

FOR U.S. JOBS
UNIWELD EMPLOYS OVER 300 WORKERS

A favorite choice of Refrigeration and HVAC/R Service Technicians. Three different size welding tips come complete with elbow mixer and nut.

1 Oxyacetylene



KL71-4C-T

- Single stage Patriot® series regulators with protective rubber gauge boots
- Front valve welding handle with stainless steel ball point valves for accurate gas control
- Three tube tip mix cutting attachment for top performance and safety; cuts up to 1/2" steel with supplied cutting tip
- Optional cutting tips available for cutting up to 2" steel
- Three welding tips for brazing from 3/16" to 1" copper tubing and welding up to 1/8" steel

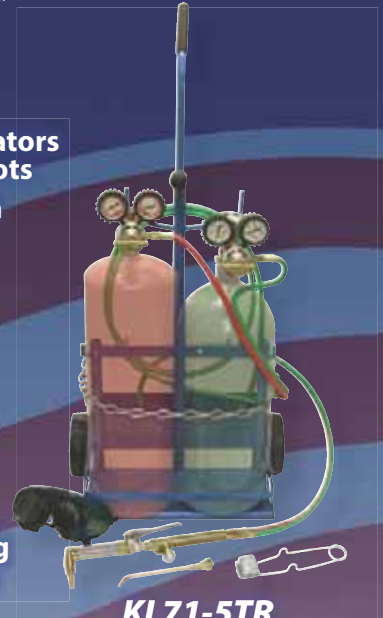

KL71-5TR



C = Metal Carrying Stand
C-T = Metal Carrying Stand & Tanks

P = Plastic Carrying Stand
P-T = Plastic Carrying Stand & Tanks



When brazing smaller copper tubing, use the proper size tip. Cutting back on the fuel and oxygen when using an oversized tip will starve the tip and may result in backfire or flashback.

Additional outfit options listed below include a variety of carrying stands and tanks*. Optional tips expand capabilities. See pages 16-19

| Part# | UPC# | Welding Handle | Welding/Brazing Tip | Cutting Attachment | Cutting Tip | Oxygen Regulator | Acetylene Regulator | Carrying Stand | Tanks* |
|-----------|-------|----------------|---------------------|--------------------|-------------|------------------|---------------------|----------------|--------|
| KL71-4 | 82319 | | | | | | RMC2 | w/o | w/o |
| KL71-4C | 82320 | | | | | | RMC2 | 500S | w/o |
| KL71-4C-T | 82321 | | Type17-0 | | | | RMC2 | 500S | MC/R |
| KL71-4P | 82324 | 71 | Type17-1 | CA100 | CT100-0D | R0 | RMC2 | 511 | w/o |
| KL71-4P-T | 82325 | | Type17-2 | | | | RMC2 | 511 | MC/R |
| KL71-5 | 82326 | | | | | | RB2 | w/o | w/o |
| KL71-5TR | 82336 | | | | | | RB2 | 504 | w/o |

Outfits Include: H32A [12.5 ft.] Twin Hose, WG53 Goggles, FL34 Flint Lighter, W05 Tank Key w/chain.

*Tanks Shipped



Maintenance Service Tech's #1 Choice



Patriot® Outfits

FOR U.S. JOBS
UNIWELD EMPLOYS OVER 300 WORKERS

Solder and braze without the use of an Oxygen cylinder when using Uniweld's Acetylene Twister® tip and air/fuel adaptor ... a real Oxygen saver!
Cuts up to 1/2" steel with supplied tip.

- Single stage Patriot® series regulators with protective rubber gauge boots
- Front valve welding handle with stainless steel ball point valves for accurate gas control
- Cutting attachment with three tube tip mix for top performance and safety. Cuts up to 1/2" steel with supplied tip
- Optional cutting tips available for cutting up to 2" steel
- Air/fuel adaptor converts welding handle to use quick connect air/fuel tips
- Welding tip for brazing up to 1" copper tubing and welding up to 1/8" steel

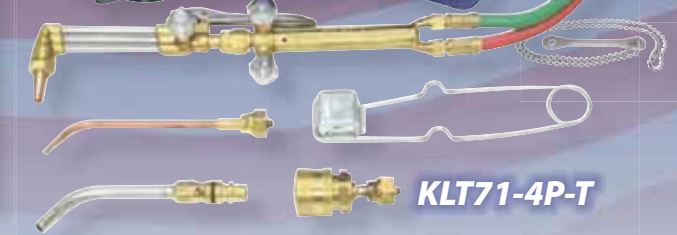
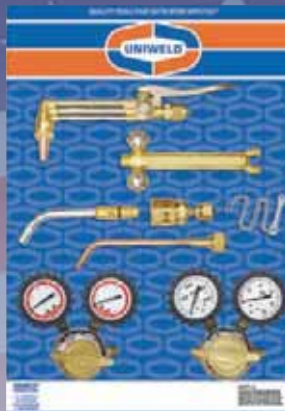

C = Metal Carrying Stand
C-T = Metal Carrying Stand & Tanks
P = Plastic Carrying Stand
P-T = Plastic Carrying Stand & Tanks

Additional outfit options listed below include a variety of carrying stands and tanks*. Optional tips expand capabilities. See pages 16-19

KLT71-4

KLT71-4P-T

| | Part# | UPC# | Welding Handle | Welding Brazing Tip | Acetylene Tip | Adaptor | Cutting Attachment | Cutting Tip | Oxygen Regulator | Acetylene Regulator | Carrying Stand | Tanks* |
|---------------------|------------|-------|----------------|---------------------|------------------|----------------------|--------------------|-------------|------------------|---------------------|----------------|--------|
| Patriot® Outfits | KLT71-4 | 82327 | | | | | | | | RMC2 | w/o | w/o |
| | KLT71-4C | 82328 | | | | | | | | RMC2 | 500S | w/o |
| | KLT71-4C-T | 82329 | | | | | | | | RMC2 | 500S | MC/R |
| | KLT71-4P | 82332 | 71 | Type17-2 | A-8 Twister® Tip | F13 Air/Fuel Adaptor | CA100 | CT100-0D | RO | RMC2 | 511 | w/o |
| | KLT71-4P-T | 82333 | | | | | | | | RMC2 | 511 | MC/R |
| | KLT71-5 | 82334 | | | | | | | | RB2 | w/o | w/o |
| | KLT71-5TR | 82335 | | | | | | | | RB2 | 504 | w/o |

Outfits Include: H32A [12.5 ft.] Twin Hose, WG53 Goggles, FL34 Flint Lighter, W05 Tank Key w/chain.

*Tanks Shipped Empty



Uniweld Products, Inc. Fort Lauderdale, FL 33312 U.S.A. Customer Service: 800.323.2111
info@uniweld.com • www.uniweld.com



1 Oxyacetylene



Basic Welding/Brazing Outfit

Patriot® Outfits

An economical, contractor grade outfit with all the basic components for brazing and for welding. Easily portable for light to medium duty jobs.

FOR U.S. JOBS
UNIWELD EMPLOYS OVER 300 WORKERS



- Single stage Patriot® series regulators with protective rubber gauge boots
- Front valve welding handle with stainless steel ball point valve for accurate gas control
- Two welding tip sizes for brazing up to 1" copper tubing and for welding up to 1/8" steel

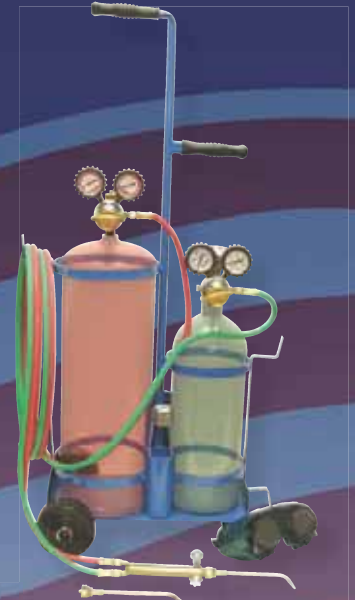

K24TB

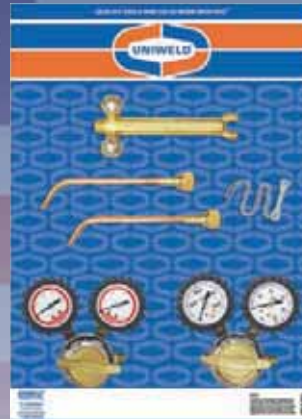

K23

C = Metal Carrying Stand
C-T = Metal Carrying Stand & Tanks
P = Plastic Carrying Stand
P-T = Plastic Carrying Stand & Tanks

Additional outfit options listed below include a variety of carrying stands and tanks*. Optional tips expand capabilities. See pages 16-19

| | Part# | UPC# | Welding Handle | Welding Brazing Tip | Oxygen Regulator | Acetylene Regulator | Carrying Stand | Tanks* |
|---------------------|--------|-------|----------------|---------------------|------------------|---------------------|----------------|--------|
| Patriot® Outfits | K23 | 82300 | | | | RMC2 | w/o | w/o |
| | K23C | 82301 | | | | RMC2 | 500S | w/o |
| | K23C-T | 82302 | | Type17-0 | | RMC2 | 500S | MC/R |
| | K23P | 82305 | 71 | Type17-2 | RO | RMC2 | 511 | w/o |
| | K23P-T | 82306 | | | | RMC2 | 511 | MC/R |
| | K24 | 82307 | | | | RB2 | w/o | w/o |
| | K24TB | 82308 | | | | RB2 | 503 | w/o |

Outfits Include: H32A [12.5 ft.] Twin Hose, WG53 Goggles, FL34 Flint Lighter, W05 Tank Key w/chain. *Tanks Shipped Empty



Welding/Brazing + Cutting Upgrade



Patriot® Outfits

FOR U.S. JOBS
UNIWELD EMPLOYS OVER 300 WORKERS

A cutting attachment and cutting tip have been added to upgrade the capabilities of the contractor outfits available for use with Acetylene Propane or MAP//Pro® [Propylene].

- Single stage Patriot® series regulators with protective rubber gauge boots
- Front valve welding handle with stainless steel ball point valves for accurate gas control
- Cutting attachment with three tube tip mix for top performance and safety. Cuts up to 1/2" steel with supplied tip

- Optional cutting tips available for cutting up to 2" steel
- Welding tip for brazing up to 1" copper tubing and welding up to 1/8" steel



K55CM



K46P-T

C = Metal Carrying Stand
C-T = Metal Carrying Stand & Tanks
P = Plastic Carrying Stand
P-T = Plastic Carrying Stand & Tanks

Additional outfit options listed below include a variety of carrying stands and tanks*. Optional tips expand capabilities. See pages 16-19

| | | Part# | UPC# | Welding Handle | Welding/Brazing Tip | Cutting Attachment | Cutting Tip | Oxygen Regulator | Fuel Gas Regulator | Carrying Stand | Tanks* |
|---------------------|--------------------------|--------|-------|----------------|---------------------|--------------------|-------------|------------------|--------------------|----------------|--------|
| Patriot® Outfits | Acetylene | K46P | 82311 | 71 | Type17-2 | CA100 | CT100-0D | R0 | RMC2 | 511 | w/o |
| | | K46P-T | 82312 | | | | CT100-0D | | RMC2 | 511 | MC/R |
| | | K56C | 82313 | | | | CT100-0D | | RMC2 | 500S | w/o |
| | | K56C-T | 82314 | | | | CT100-0D | | RMC2 | 500S | MC/R |
| | MAP//Pro™ [Propylene] | K45CM | 82315 | Type17-3 | CA550 | 5-200M-0D† | RP3A | 511 | w/o | | |
| | | K55CM | 82316 | | | 5-200M-0D† | | RP3A | 510 | w/o | |
| | Propane | K45CP | 82317 | Type17-3 | CA550 | 5-200-0D~ | RP3A | 511 | w/o | | |
| | | K55CP | 82318 | | | 5-200-0D~ | | RP3A | 510 | w/o | |

Outfits Include: H32A [12.5 ft.] Twin Hose, WG53 Goggles, FL34 Flint Lighter, W05 Tank Key w/chain †MAP//Pro™ ~Propane. *Tanks Shipped Empty.



Uniweld Products, Inc. Fort Lauderdale, FL 33312 U.S.A. Customer Service: 800.323.2111
info@uniweld.com • www.uniweld.com



Basic Welding/Brazing Outfit

Centurion® Outfits

FOR U.S. JOBS
UNIWELD EMPLOYS OVER 300 WORKERS

An economical, contractor grade outfit with all the basic components for brazing and for welding. Easily portable for light to medium duty jobs.



- Single stage Centurion® series regulators with rubber protective gauge boots
- Front valve welding handle with stainless steel ball point valve for accurate gas control
- Two welding tip sizes for brazing up to 1" copper tubing and for welding up to 1/8" steel
- Optional welding/brazing tips expand capabilities. See pages 16-19



KC100CT



KC100FC

C = Metal Carrying Stand
C-T = Metal Carrying Stand & Tanks
P = Plastic Carrying Stand
P-T = Plastic Carrying Stand & Tanks

Additional outfit options listed below include a variety of carrying stands and tanks*.

| | Part# | UPC# | Welding Handle | Welding/Brazing Tip | Cap'n Hook® Tip | Micro 6000™ Specialty Tips | Oxygen Regulator | Acetylene Regulator | Carrying Stand | Tanks* | |
|-----------------------|----------|-------|----------------|---------------------|-----------------|----------------------------|------------------|---------------------|----------------|--------|-----|
| Centurion® Outfits | KC100 | 82607 | 71 | Type17-0 | | | R0100 | RMC100 | w/o | w/o | |
| | KC100C | 82601 | | | | | | | 500S | w/o | |
| | KC100CT | 82602 | | 500S | | | | | MC/R | | |
| | KC100P | 82603 | | 511 | | | | | w/o | | |
| | KC100PT | 82604 | | 511 | | | | | MC/R | | |
| | KC122P | 82621 | | MTF-5 | | | | | MTW-1 | 511 | w/o |
| | KC122L | 82620 | | MTT | | | | | w/o | w/o | |
| | KC100FC† | 82609 | | Type17-3 | | | | | R0100 | RP3A | 510 |

Outfits Include: H32A [12.5 ft.] Twin Hose, WG53 Goggles, FL34 Flint Lighter, W05 Tank Key w/chain. *Tanks Shipped Empty
† KC100FC - Outfit Includes: H32AT [12.5 ft.] 3/16" Grade "T" Twin Hose, WG53 Goggles, FL34 Flint Lighter





Welding/Brazing + Cutting Upgrade Centurion® Outfits

FOR U.S. JOBS
UNIWELD EMPLOYS OVER 300 WORKERS

A cutting attachment and cutting tip have been added to upgrade the economical Centurion® contractor grade outfit. Portable, lightweight and suitable for light to medium duty cutting, welding and brazing jobs.

- Single stage Centurion® series regulators with protective rubber gauge boots
- Front valve welding handle with stainless steel ball point valves for accurate gas control
- Cutting attachment with three tube tip mix for top performance and safety. Cuts up to 1/2" steel with supplied tip
- Optional cutting tips available for cutting up to 2" steel
- Welding tip for brazing up to 1" copper tubing and welding (with Acetylene) up to 1/8" steel
- Optional welding/brazing tips expand capabilities. See pages 16-19

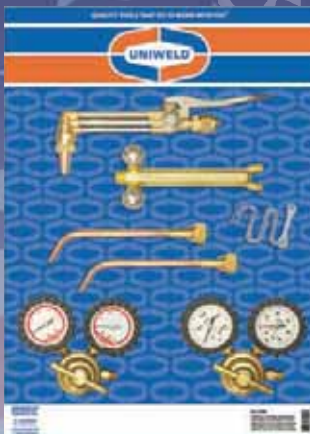

KLC100

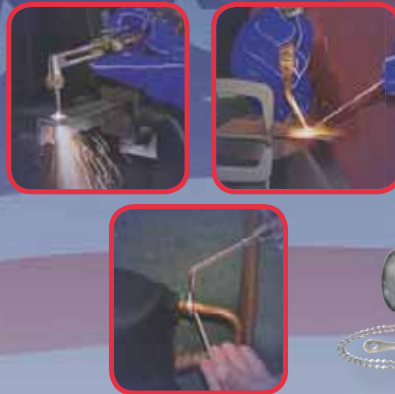

C = Metal Carrying Stand
C-T = Metal Carrying Stand & Tanks
P = Plastic Carrying Stand
P-T = Plastic Carrying Stand & Tanks



KLC100PT

Additional outfit options listed below include a variety of carrying stands and tanks*. Optional tips expand capabilities. See pages 16-19

| | Part# | UPC# | Welding Handle | Welding Brazing Tip | Cutting Attachment | Cutting Tip | Oxygen Regulator | Acetylene Regulator | Carrying Stand | Tanks* |
|-----------------------|----------|-------|----------------|---------------------|--------------------|-------------|------------------|---------------------|----------------|--------|
| Centurion® Outfits | KLC100 | 82700 | | | | | | | w/o | w/o |
| | KLC100C | 82701 | | Type17-0 | | | | | 500S | w/o |
| | KLC100CT | 82702 | 71 | Type17-2 | CA100 | CT100-0D | R0100 | RMC100 | 500S | MC/R |
| | KLC100P | 82703 | | | | | | | 511 | w/o |
| | KLC100PT | 82704 | | | | | | | 511 | MC/R |

Outfits Include: H32A [12.5 ft.] Twin Hose, WG53 Goggles, FL34 Flint Lighter, W05 Tank Key w/chain.

*Tanks Shipped Empty



Uniweild Products, Inc. Fort Lauderdale, FL 33312 U.S.A. Customer Service: 800.323.2111
info@uniweild.com • www.uniweild.com

Oxyacetylene Welding & Cutting



Handles/Attachments

FOR U.S. JOBS
UNIWELD EMPLOYS OVER 300 WORKERS

Uniweld's V-style CA550 cutting attachment is designed so that the oxygen and fuel gas mix in the bottom tube and flow to the tip along with the cutting oxygen flowing to the tip in the top tube. The CA100 A-style cutting attachment is designed so that the oxygen and fuel gas mix in the cutting tip for top performance and operator safety. Both style cutting attachments fit either the Uniweld 71 or WH550 welding handle. The 71 handle utilizes a front valve design while the WH550 handle features accurate rear valve gas and oxygen controls.

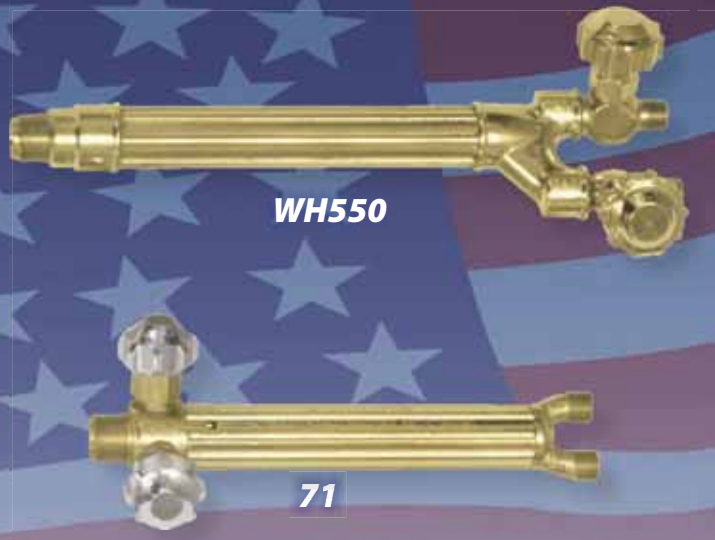

F11



F11 ADAPTOR
Adaptor converts the 71 and WH550 welding handles to use screw connect air/fuel tips for brazing and soldering without the use of an Oxygen cylinder.



F13



F13 ADAPTOR
Adaptor converts the 71 and WH550 welding handles to use quick connect air/fuel tips for brazing and soldering without the use of an Oxygen cylinder.



PUA

PUA ADAPTOR
Prest-O-Lite® tips to fit Uniweld welding handle.



UPA

UPA ADAPTOR
Uniweld tips to fit Prest-O-Lite® welding handle.

| | Part# | UPC# | Head Angle | Head Type | Length | Weight | "A" Hose Connection |
|---------------------|--------|-------|------------|-----------|--------|----------|--|
| Cutting Attachments | CA550* | 02600 | 90° | Forged | 8" | 15 oz. | - |
| | CA100 | 02700 | | | 7" | 10.8 oz. | - |
| Welding Handles | 71* | 00300 | - | - | 6" | 6.4 oz. | 3/8"-24RH, Oxygen 3/8"-24LH, Fuel Gas |
| | WH550* | 00550 | - | - | 8.5" | 12.6 oz. | |

* UL Listed



It Pays to Pay Attention in the Work Place



Play it Safe®

Always use the proper size tip for the job. Never use an oversized tip and then cut the fuel and oxygen back to work on a small job. This will starve the tip of oxygen and acetylene, resulting in improper operating pressure that may cause tip damage, overheating, backfire and flashback.

The following is a good example of proper procedure for lighting an oxyacetylene tip. This operating procedure is not a substitute for carefully reading the manufacturer's operating instructions before use.

[STEP 1] Prior to opening the cylinder valve, make sure the regulator pressure adjusting screw is backed all the way out by turning it counterclockwise until there is no pressure on the spring. When opening [or closing] the cylinder valve, always stand to the side of the cylinder with the regulator facing forward. The oxygen cylinder valve should be "cracked" open slowly until the cylinder contents gauge stops moving. Then, open the valve sufficiently to provide adequate flow. The fuel gas [acetylene] cylinder valve should be opened a maximum of $\frac{3}{4}$ turn and a wrench should remain in position on the stem of the valve while the cylinder is in use so that the valve can be quickly turned off in case of an emergency.



3A



[STEP 3] To light the tip, **open the fuel gas [acetylene] valve first about $\frac{1}{2}$ turn and quickly ignite with a spark lighter.** Adjust the flame so that it is not separated from the tip end. The flame should be bright yellow with no black soot [3A]. If necessary, increase the fuel to clear the black soot.

3B

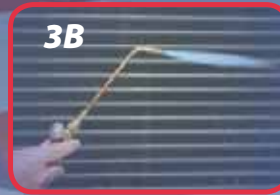

Next, open the oxygen and adjust the flow until the white feathers disappear into a well-defined bullet nose cone called the neutral flame [3B].

[STEP 2] After the proper tip has been selected and installed, the proper operating pressure needs to be determined from the manufacturer's tip chart. Set each regulator to its corresponding pressure by adjusting the pressure adjusting screw. Purge hoses and equipment by briefly opening and closing the oxygen valve and fuel gas valve separately and venting gases safely. Purge hoses and equipment before each use.



4



[STEP 4] When you have completed the job and are ready to shut off the torch, **always shut the oxygen valve first and then the fuel gas valve [acetylene].** **NOTE:** Shutting off the fuel gas first can cause backfire and/or flashback.

5



[STEP 5] To shut down the torch for storage or transportation, close the cylinder valves. Release the oxygen pressure by opening the oxygen torch valve [vent safely]. Close the torch valve and repeat this same process for the fuel gas [vent safely]. Close all valves tightly and secure the equipment. **Now the shutdown is complete!**

SK OR REE ULLSIE 33 SEYPOSER
W EN PL IN YOUR NE ORDER



Part#USP8E
English
Safety Poster

Part#USP8S
Spanish
Safety Poster

Part#USP8F
French
Safety Poster

Part#USPA
Arabic
Safety Poster



Uniweld Products, Inc. Fort Lauderdale, FL 33312 U.S.A. Customer Service: 800.323.2111
info@uniweld.com • www.uniweld.com

15

Brazing, Welding & Cutting



Tips, Tips, Tips...

FOR U.S. JOBS
UNIWELD EMPLOYS OVER 300 WORKERS

The popular Type17 tips come complete with elbow, mixer and nut. Use with Acetylene, Propane, MAP//Pro™ [Propylene] and Natural Gas.

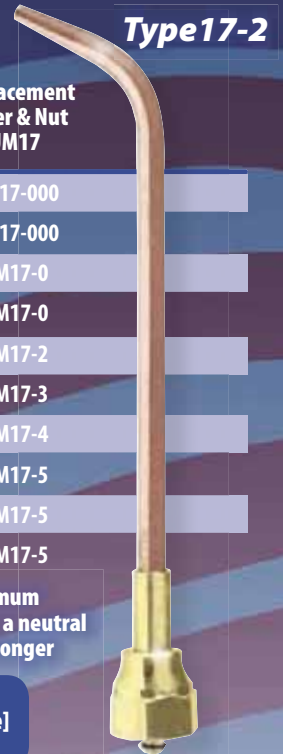

Type17 Weld/Braze Tips
Type17 tips have O-Ring seals, [X26R & X25R] so tighten the tip nut firmly hand tight. **DO NOT OVER-TIGHTEN**



X25R Small O-Ring

X26R Large O-Ring

Part# TXRK
Kit includes:
(5) X25R & (5) X26R

| Part# | UPC# | Acetylene Consumption SCFH | Fuel Pressure PSIG | Oxygen Pressure PSIG | Welding Metal Thickness | Brazing Copper Tubing | Replacement Elbow | Replacement Mixer & Nut UM17 |
|------------|-------|----------------------------|--------------------|----------------------|-------------------------|-----------------------|-------------------|------------------------------|
| Type17-000 | 30250 | 1-2 | 5 | 5 | 1/32" | 1/8" | Type17E-000 | UM17-000 |
| Type17-00 | 30251 | 2-3 | 5 | 5 | 3/64" | 1/4" | Type17E-00 | UM17-000 |
| Type17-0 | 30252 | 2-4 | 5 | 5 | 5/64" | 1/2" | Type17E-0 | UM17-0 |
| Type17-1 | 30253 | 3-6 | 5 | 5 | 3/32" | 3/4" | Type17E-1 | UM17-0 |
| Type17-2 | 30254 | 5-10 | 5 | 5 | 1/8" | 1" | Type17E-2 | UM17-2 |
| Type17-3 | 30255 | 8-18 | 6 | 7 | 3/16" | 1 1/2" | Type17E-3 | UM17-3 |
| Type17-4 | 30256 | 10-25 | 7 | 10 | 1/4" | 2" | Type17E-4 | UM17-4 |
| Type17-5 | 30257 | 15-35 | 8 | 12 | 1/4" to 1/2" | 3" | Type17E-5 | UM17-5 |
| Type17-6 | 30258 | 25-45 | 9 | 14 | 1/2" to 3/4" | 4" | Type17E-6 | UM17-5 |
| Type17-7 | 30259 | 30-60 | 10 | 16 | 3/4" to 1 1/4" | 6" | Type17E-7 | UM17-5 |

*NOTE: When acetylene weld/braze tips are used with fuel gases, use one size larger tip and maximum pressures to obtain proper heat. The chart indicates approximate torch oxygen consumption with a neutral flame ratio for various gases: Pressures are approximate for hose length up to 25 ft.; increase for longer lengths about 3 psig per 25 ft. - increase working pressure 2-3 psig for check valves and flashback arrestors. Acetylene delivery pressure should not exceed 15 psig under flow conditions.

1.1 Oxygen to 1 Acetylene
3.5 Oxygen to 1 MAP//Pro™ [Propylene]
4 Oxygen to 1 Propane / Natural gas

Cutting Tips
This is a metal to metal seating, so be sure to tighten the tip nut wrench tight

| Part# | UPC# | Cutting SCFH | Oxygen PSIG | Fuel PSIG | Cutting Tip Guide | Description |
|-----------|-------|--------------|-------------|-----------|-------------------|---|
| 5-101-00D | 34505 | 30-35 | 20-25 | 5 | 1/4" | Acetylene 6 preheats for General Purpose Cutting |
| 5-101-0D | 34506 | 40-60 | 20-30 | 5 | 1/2" | |
| 5-101-1D | 34507 | 80-85 | 30-35 | 5 | 3/4" to 1" | |
| 5-101-2D | 34508 | 140-180 | 35-40 | 7 | 1" to 2" | Propane 8 preheats for General Purpose Cutting |
| 5-200-0D | 34530 | 40-60 | 20-30 | 5 | 1/2" | |
| 5-200-1D | 34531 | 80-85 | 30-35 | 5 | 3/4" to 1" | |
| 5-200-2D | 34532 | 140-180 | 35-40 | 7 | 1" to 2" | MAP//Pro™ [Propylene] 8 preheats for General Purpose Cutting |
| 5-200M-0D | 34555 | 40-60 | 20-30 | 5 | 1/2" | |
| 5-200M-1D | 34556 | 80-85 | 30-35 | 5 | 3/4" to 1" | |
| 5-200M-2D | 34557 | 140-180 | 35-40 | 7 | 1" to 2" | Acetylene General Purpose Cutting |
| CT100-00D | 38010 | 30-35 | 20-25 | 5 | 1/4" | |
| CT100-0D | 38011 | 40-60 | 20-25 | 5 | 1/2" | |
| CT100-1D | 38012 | 80-85 | 30-35 | 5 | 3/4" to 1" | |
| CT100-2D | 38013 | 140-180 | 35-40 | 7 | 1" to 2" | |



5-101 & 5-200 Tips fit CA550 Cutting Attachment. CT100 Tips fit CA100 Cutting Attachment.





Welding/Brazing & Heating and more Tips...

FOR U.S. JOBS
UNIWELD EMPLOYS OVER 300 WORKERS

Rosebuds are your best tip choice for brazing, soldering and heating. They're available 7" and 12" lengths and in several sizes. These tips fit Uniweld 71 and WH550 welding handles.

1 Oxyacetylene

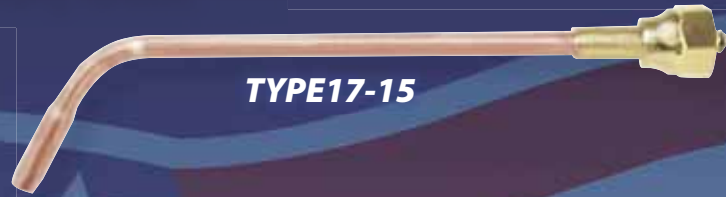

TYPE17-15

| | Part# | UPC# | Overall Length | Acetylene SCFH | Oxygen PSIG | Acetylene PSIG | Brazing Copper Tubing Guide | Replacement Mixer & Nut |
|----------------------|------------|-------|----------------|----------------|-------------|----------------|-----------------------------|-------------------------|
| Rosebud Heating Tips | Type17-15 | 31170 | 7" | 15 | 12 | 10 | 1/8" to 25/8" | UM17-5 |
| | *Type17-30 | 31171 | 7" | 30 | 15 | 12 | 1/2" to 6" | UM17-5 |
| | Type28-2 | 31450 | 12" | 9 | 8 | 7 | 1/8" to 15/8" | UM17-5 |
| | Type28-4 | 31451 | 12" | 14 | 12 | 10 | 1/2" to 3" | UM17-5 |
| | *Type28-6 | 31452 | 12" | 30 | 15 | 12 | 1/2" to 6" | UM17-5 |
| | *Type28-8 | 31453 | 12" | 60 | 25 | 15 | 6" to 8" | UM17-5 |

*Tips must be used with a 40 cu. ft. or larger cylinder.

| | Part# | UPC# |
|----------------------|------------|-------|
| Replacement Tip Ends | Type28TE-2 | 31460 |
| | Type28TE-4 | 31461 |
| | Type28TE-6 | 31462 |
| | Type28TE-8 | 31463 |

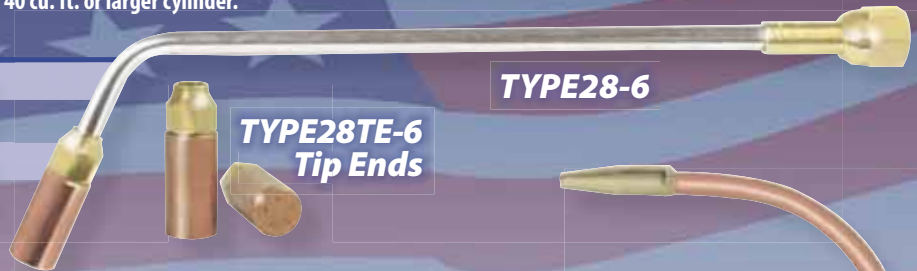

TYPE28-6

TYPE28TE-6 Tip Ends



Flexible tips that you can bend to fit the job...
...even around corners! And then, re-bend 'em for the next job. 10.5" long, including mixer.



(2) TYPE17-30 Tip Ends

TYPE13-8VM

| | Part# | UPC# | Acetylene Consumption SCFH | Oxygen Pressure PSIG | Acetylene Pressure PSIG | Brazing Copper Tubing | Replacement Elbow | Replacement Mixer & Nut |
|--------------------------|------------|-------|----------------------------|----------------------|-------------------------|-----------------------|-------------------|-------------------------|
| Flexible Brazing Tip | Type17-9 | 31181 | 4 | 5 | 5 | Up to 7/8" | Type17E-9 | UM17-5 |
| Twin Rosebud Heating Tip | Type13-8VM | 31161 | 60 | 25 | 15 | 4" - 12" | Type13E-8 | UM17-5 |

Fits 71 and WH550 Welding Handles.



Uniweld Products, Inc. Fort Lauderdale, FL 33312 U.S.A. Customer Service: 800.323.2111
info@uniweld.com • www.uniweld.com

Tuning Fork™ Tip and Micro 6000™ Tips



Hot Tips

FOR U.S. JOBS
UNIWELD EMPLOYS OVER 300 WORKERS

Heat up all the fittings of a heat pump reversing valve at once for easy removal of the defective valve with the Tuning Fork™ Tip. Remove and install the new valve without altering the original copper tube fittings. The Tuning Fork™ Tip makes it possible to work efficiently in tight spaces and get even heat quickly in tough-to-reach areas.

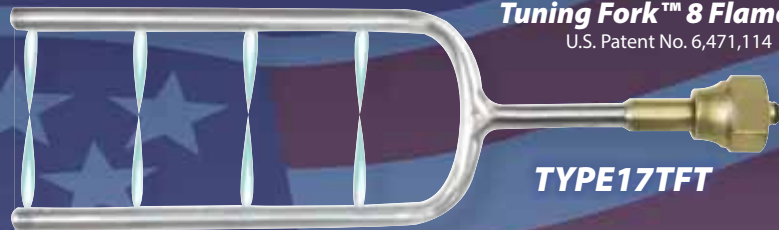

Tuning Fork™ 8 Flame Tip
U.S. Patent No. 6,471,114

TYPE17TFT

| | Part# | UPC# | Acetylene Consumption SCFH | Oxygen Pressure PSIG | Acetylene/Fuel Pressure PSIG | Overall Length | Welding Metal Thickness | Brazing Copper Tubing | Replacement Nut & Mixer |
|-------------------------|-----------|-------|----------------------------|----------------------|------------------------------|----------------|-------------------------|-----------------------|-------------------------|
| Tuning Fork™ Tip | Type17TFT | 31175 | 5-10 | 10 | 7 | 8" | N/A | 7/8" | UM17-5 |

Tuning Fork™ Tip fits 71 and WH550 welding handles.

Micro 6000™ Tips heat up to 5600°F, providing pinpoint brazing accuracy.

MTW-1

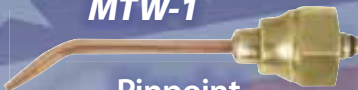

Pinpoint concentrated heat in tight spaces

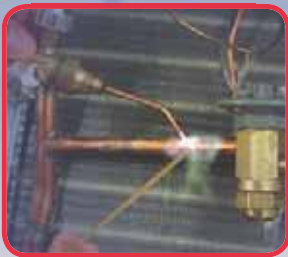

Stable concentrated flame even in windy conditions



MTR

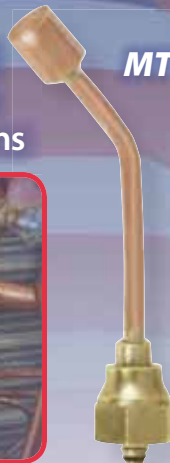

Adjustable tip ends for maximum control



MTT



| | Part# | UPC# | Acetylene Consumption SCFH | Oxygen Pressure PSIG | Acetylene/Fuel Pressure PSIG | Overall Length | Welding Metal Thickness | Brazing Copper Tubing | Replacement Nut & Mixer |
|-------------------------|-------|-------|----------------------------|----------------------|------------------------------|----------------|-------------------------|-----------------------|-------------------------|
| Micro 6000™ Tips | MTW-1 | 30551 | 2-3 | 5 | 5 | 3" | 3/64" | 1/2" | N/A |
| | MTW-2 | 30552 | 2-4 | 5 | 5 | 3" | 5/64" | 1" | N/A |
| | MTT | 30560 | 4-6 | 5 | 5 | 4" | N/A | 1" | N/A |
| | MTR | 30570 | 4-8 | 5 | 5 | 4" | N/A | 1 1/2" | N/A |

Micro 6000™ tips fit 71 and WH550 welding handles.



Oxyacetylene, MAP//Pro™ (Propylene), Propane



Cap'n Hook® Tips

U.S. Patent No. 4,191,333

FOR U.S. JOBS
UNIWELD EMPLOYS OVER 300 WORKERS

The patented Uniweld Cap'n Hook® Tip with concentrated heat up to 5600°F. The 40° flame angle flows onto copper tubing and away from sensitive areas, thus minimizing the chances of burning adjacent components. You get 100% wraparound for even heat distribution.

1 Oxyacetylene

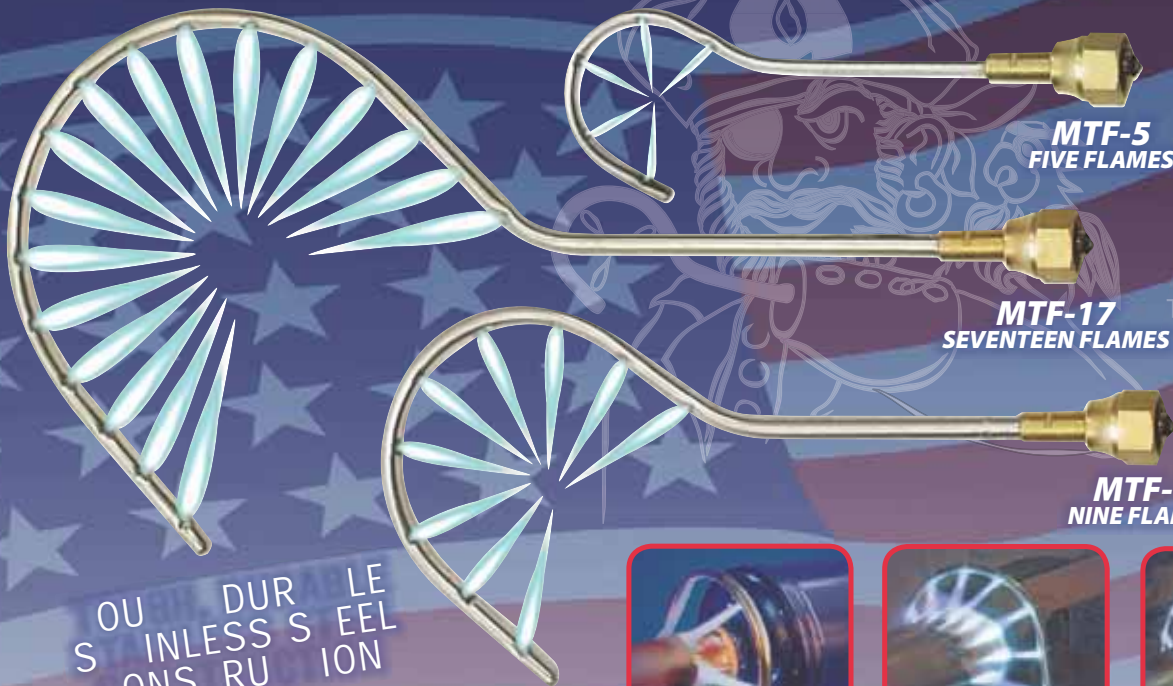

UP TO 3
SERIES
IN
SPEED

STAINLESS
SOU DUR LE
INLESS S EEL
ONS RU ION



| | Part# | UPC# | Acetylene Consumption SCFH | Oxygen Pressure PSIG | Acetylene Pressure PSIG | Overall Length | Brazing Copper Tubing [up to] |
|------------------|--------|-------|----------------------------|----------------------|-------------------------|----------------|-------------------------------|
| Acetylene | MTF-5 | 30590 | 4-6 | 8 | 5 | 5½" | 1" |
| | MTF-9 | 30591 | 5-9 | 10 | 7 | 8½" | 2" |
| | MTF-17 | 30592 | 8-14 | 18 | 12 | 11" | 3" |

| | Part# | UPC# | MAP//Pro™ [Propylene] /Propane Consumption LBS/HR | Oxygen Pressure PSIG | MAP//Pro™ [Propylene] /Propane Pressure PSIG | Overall Length | Brazing Copper Tubing [Up to] |
|--------------------------------------|---------|-------|---|----------------------|--|----------------|-------------------------------|
| MAP//Pro™ (Propylene) Propane | MTFM-5 | 30595 | 2.6 | 10 | 5 | 5½" | 1" |
| | MTFM-9 | 30596 | 3.1 | 15 | 7 | 8½" | 2" |
| | MTFM-17 | 30597 | 5.6 | 20 | 10 | 11" | 3" |

All Cap'n Hook® Tips fit 71, WH550 & WH250 Handles.



Uniweld Products, Inc. Fort Lauderdale, FL 33312 U.S.A. Customer Service: 800.323.2111 info@uniweld.com • www.uniweld.com

Self-Igniting Swirl Combustion Torch Tips



Twister[®] 2

FOR U.S. JOBS
UNIWELED EMPLOYS OVER 300 WORKERS

Twister[®] 2 Tips combine easy start electric ignition with the popular Twister[®] swirl combustion technology to produce a faster igniting and more efficient torch tip. Use with Acetylene.

2 Air/Acetylene

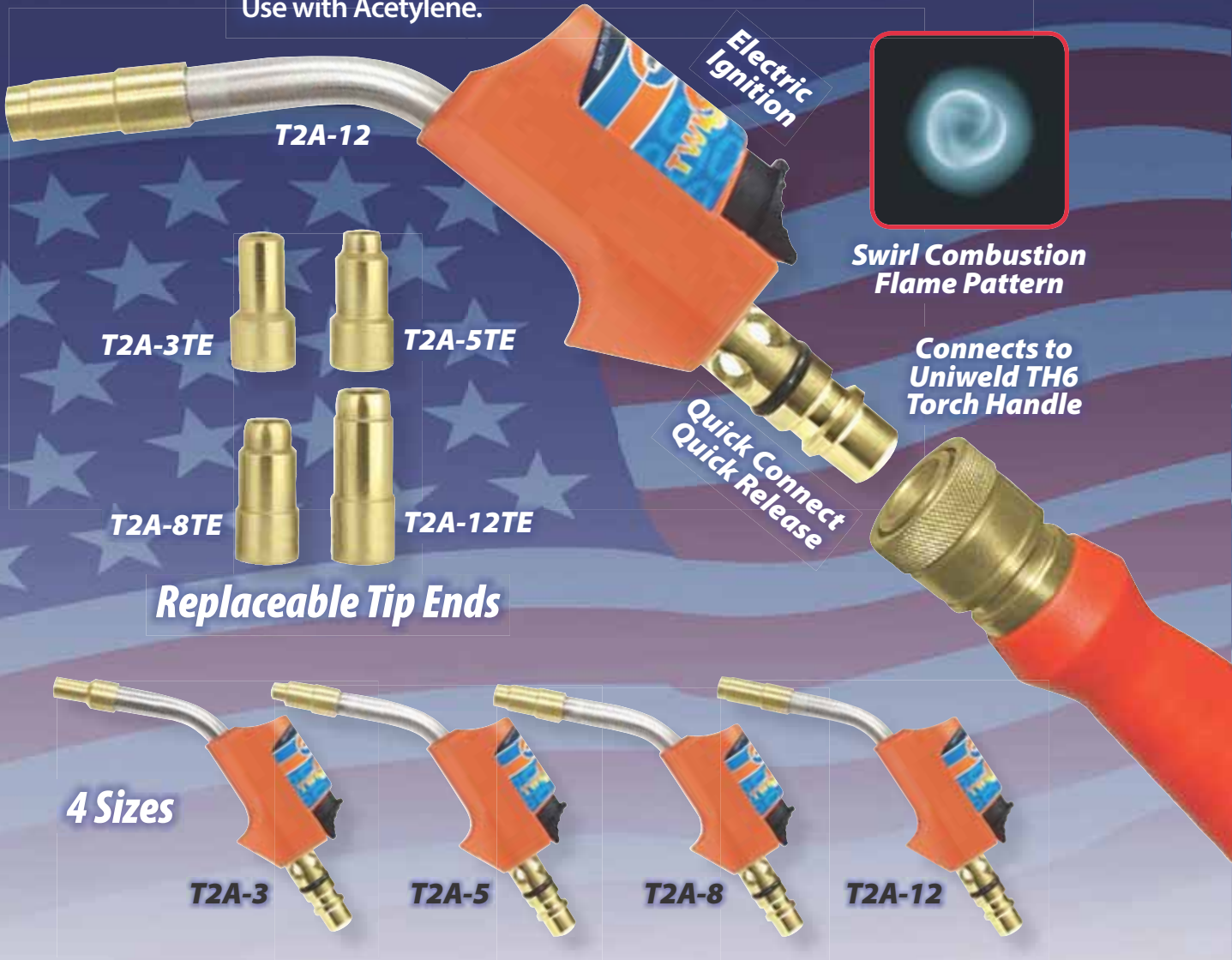

Replaceable Tip Ends

4 Sizes

| Quick Connect | Part# | UPC# | Copper Tubing Capacity | | Tip Ends | Part# | UPC# |
|---------------|--------|-------|------------------------|----------------|----------|----------|-------|
| | | | Solder | Braze | | | |
| | T2A-3 | 43050 | Up to 1" | Up to 1/2" | | T2A-3TE | 43060 |
| | T2A-5 | 43051 | 3/4" to 1 1/2" | 1/4" to 3/4" | | T2A-5TE | 43061 |
| | T2A-8 | 43052 | 1" to 2" | 1/2" to 1" | | T2A-8TE | 43062 |
| | T2A-12 | 43053 | 1 1/4" to 3" | 7/8" to 1 5/8" | | T2A-12TE | 43063 |

20



UniWeld Products, Inc. Fort Lauderdale, FL 33312 U.S.A. Customer Service: 800.323.2111
info@uniweld.com • www.uniweld.com

Self-Igniting Swirl Combustion Torch Tips



Twister[®] 2 Kits

FOR U.S. JOBS
UNIWELD EMPLOYS OVER 300 WORKERS

Twister[®] 2 self-igniting Torch Kits feature swirl combustion technology that produces a high energy efficient flame. The flame remains stable, even in windy conditions. The self-igniting tip "quick connects" to the ergonomically designed handle.



KT2A5MCT

512 Carrying Stand
U.S. Patent No. 4,294,448

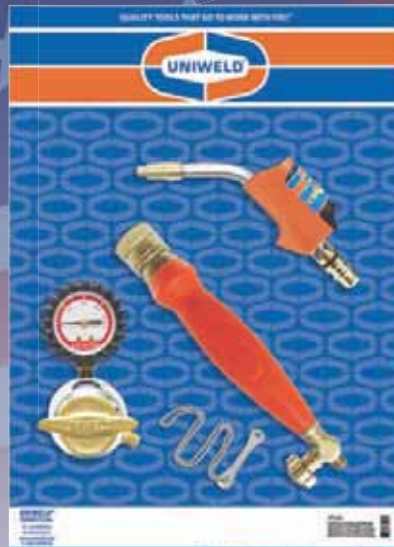

KT2A5



KT2A5T

2 Air/Acetylene

U S W I
P R O E I V E
R U E R O O S

| | Part# | UPC# | Regulator | Handle | Tips | Carrying Stands | Tanks* |
|----------------------|----------|-------|-------------------------|--|--------------------------------|-----------------|---------------------|
| Quick Connect | KT2A5 | 89650 | RB Acetylene Regulator | TH6 | T2A-5 Twister [®] Tip | w/o | w/o |
| | KT2A5T | 89651 | RB Acetylene Regulator | Quick Connect Handle with Rear Control Valve | T2A-5 Twister [®] Tip | 502 | "B" Acetylene Tank |
| | KT2A5MC | 89652 | RMC Acetylene Regulator | | T2A-5 Twister [®] Tip | w/o | w/o |
| | KT2A5MCT | 89653 | RMC Acetylene Regulator | | T2A-5 Twister [®] Tip | 512 | "MC" Acetylene Tank |

Regulators fitted with protective rubber gauge boots. Kits include H12 [12.5 ft.] Acetylene Hose, W05 Tank Key w/chain.* Tanks shipped empty.



Uniweld Products, Inc. Fort Lauderdale, FL 33312 U.S.A. Customer Service: 800.323.2111
info@uniweld.com • www.uniweld.com

21

Swirl Combustion Torch Tips



Twister® Tips

FOR U.S. JOBS
UNIWELD EMPLOYS OVER 300 WORKERS

The popular Air/Fuel Twister® Tips let you work with a stable, high energy efficient flame, even in windy conditions. Twister® helical blade technology maximizes the BTU's and speeds up the heat transfer.

STAINLESS
STEEL
TIP



ACETYLENE 2700 °F [1482 °C]

TARGET HEAT AREA
THE MOST EFFICIENT AREA
FOR HEAT TRANSFER.

Quick Connect Twister® Tips
Fit Uniweld's TH6 Quick Connect
Handles With Rear Control Valve



2 Air/Acetylene



All sizes also
available as
Screw Connect

A-S3

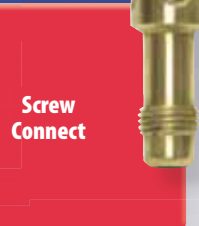

| Part# | Copper Tubing Capacity | | Swirl Flame Pattern | Copper Tubing Capacity | | Part# |
|-------|------------------------|----------------|---------------------------|------------------------|-------|-------|
| | UPC# | Solder | | UPC# | Brace | |
| A-3 | 43020 | Up to 1" | | Up to 1/2" | 43025 | AS-3 |
| A-5 | 43021 | 3/4" to 1 1/2" | | 1/4" to 3/4" | 43026 | AS-5 |
| A-8 | 43022 | 1" to 2" | | 1/2" to 1" | 43027 | AS-8 |
| A-11 | 43023 | 1 1/4" to 3" | | 7/8" to 1 5/8" | 43028 | AS-11 |
| A-14 | 43024 | 2" to 3 1/2" | | 1" to 2" | 43029 | AS-14 |
| A-32 | 43040 | 4" to 6" | | 1 1/2" to 4" | 43041 | AS-32 |

Quick
Connect

Screw
Connect



Quick Connect and Screw Connect



Twister® Kits

FOR U.S. JOBS
UNIWELD EMPLOYS OVER 300 WORKERS



USE WELDER
PROTECTIVE
EQUIPMENT

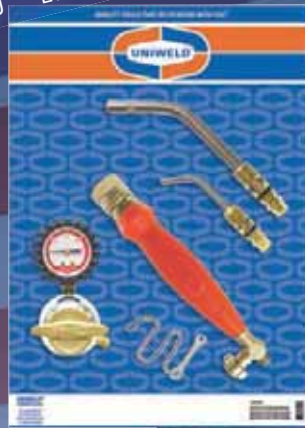

| | Part# | Regulator | Handle | Tips | Carrying Stands | Tanks* |
|----------------------|-------|-------------------------|--|---------------------------|-----------------|---------------------|
| Quick Connect | 89600 | RB Acetylene Regulator | TH6 Quick Connect Handle Rear Control Valve | A-3, A-11 Twister® Tips | w/o | w/o |
| | 89602 | RB Acetylene Regulator | | A-3, A-11 Twister® Tips | 502 | "B" Acetylene Tank |
| | 89603 | RMC Acetylene Regulator | | A-3, A-11 Twister® Tips | w/o | w/o |
| | 89605 | RMC Acetylene Regulator | | A-3, A-11 Twister® Tips | 512 | "MC" Acetylene Tank |
| | 89620 | RB Acetylene Regulator | | A-5 Twister® Tip | w/o | w/o |
| | 89621 | RB Acetylene Regulator | | A-5 Twister® Tip | 502 | "B" Acetylene Tank |
| | 89622 | RMC Acetylene Regulator | | A-5 Twister® Tip | w/o | w/o |
| | 89623 | RMC Acetylene Regulator | | A-5 Twister® Tip | 512 | "MC" Acetylene Tank |
| | 89628 | RB Acetylene Regulator | | A-5, A-14 Twister® Tips | w/o | w/o |
| | 89629 | RB Acetylene Regulator | | A-8 Twister® Tip | w/o | w/o |
| Screw Connect | 89608 | RB Acetylene Regulator | TH3 Screw Connect Handle Rear Control Valve | AS-3, AS-11 Twister® Tips | w/o | w/o |
| | 89609 | RB Acetylene Regulator | | AS-3, AS-11 Twister® Tips | 502 | "B" Acetylene Tank |
| | 89610 | RMC Acetylene Regulator | | AS-3, AS-11 Twister® Tips | w/o | w/o |
| | 89611 | RMC Acetylene Regulator | | AS-3, AS-11 Twister® Tips | 512 | "MC" Acetylene Tank |
| | 89624 | RB Acetylene Regulator | | AS-5 Twister® Tip | w/o | w/o |
| | 89625 | RB Acetylene Regulator | | AS-5 Twister® Tip | 502 | "B" Acetylene Tank |
| | 89626 | RMC Acetylene Regulator | | AS-5 Twister® Tip | w/o | w/o |
| | 89627 | RMC Acetylene Regulator | | AS-5 Twister® Tip | 512 | "MC" Acetylene Tank |

Regulators fitted with protective rubber gauge boots. Kits include H12 [12.5 ft.] Acetylene Hose, W05 Tank Key w/chain. *Tanks shipped Empty.



Uniweld Products, Inc. Fort Lauderdale, FL 33312 U.S.A. Customer Service: 800.323.2111
info@uniweld.com • www.uniweld.com

23

2 Air/Acetylene

Quick Connect and Screw Connect



Thruster® Kits

FOR U.S. JOBS
UNIWELD EMPLOYS OVER 300 WORKERS

The Air/Acetylene Thruster® Kit comes with adjustable flame tips and a fuel conserving Thruster® handle. Excellent for plumbing or repair work in very tight work areas. Select either "quick connect" or "screw connect" tips and either "B" tank or "MC" tank regulators.

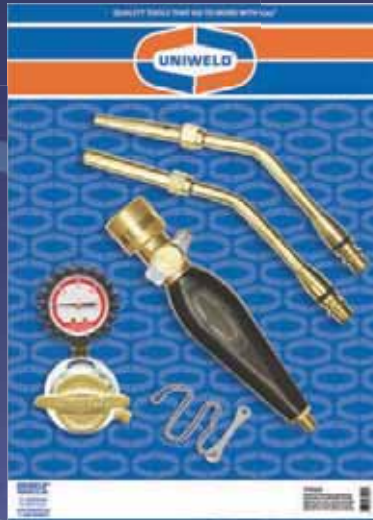
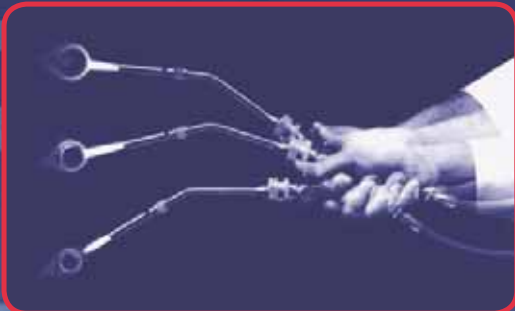

KTAQ23
Quick Connect Kit

2 Air/Acetylene

| | Part# | UPC# | Regulator | Tips | Handle |
|---------------|----------|-------|-------------------------|----------------------------|--|
| Quick Connect | KTAQ23 | 89007 | RB Acetylene Regulator | ATQ2, ATQ3 Thruster® Tips | TH7 Quick Connect Handle with Fuel-Conserving Pilot Valve |
| | KTAQ23MC | 89008 | RMC Acetylene Regulator | ATQ2, ATQ3 Thruster® Tips | |
| | KTAQ3 | 89005 | RB Acetylene Regulator | ATQ3 Thruster® Tip | |
| | KTAQ3MC | 89006 | RMC Acetylene Regulator | ATQ3 Thruster® Tip | |
| | KTAQ34 | 89009 | RB Acetylene Regulator | ATQ3, ATQ4+ Thruster® Tips | |
| Screw Connect | KTA23 | 89002 | RB Acetylene Regulator | AT2, AT3 Thruster® Tips | TH5 Screw Connect Handle with Fuel-Conserving Pilot Valve |
| | KTA23MC | 89003 | RMC Acetylene Regulator | AT2, AT3 Thruster® Tips | |
| | KTA3 | 89000 | RB Acetylene Regulator | AT3 Thruster® Tip | |
| | KTA3MC | 89001 | RMC Acetylene Regulator | AT3 Thruster® Tip | |
| | KTA34 | 89004 | RB Acetylene Regulator | AT3, AT4+ Thruster® Tips | |

+ATQ4 and AT4 tips must be used with a 40 cu. ft. or larger cylinder and regulator delivery pressure set at 15 PSIG. Kits include H12 [12.5 ft.] Acetylene Hose, W05 Tank Key w/chain. Regulators fitted with protective rubber gauge boots.

| | Part# | UPC# | Copper Tubing Capacity | |
|---------------|-------|-------|------------------------|----------------|
| | | | Solder | Brze |
| Quick Connect | ATQ2 | 43135 | 1/8" to 1" | 1/8" to 7/8" |
| | ATQ3 | 43136 | 5/8" to 3" | 3/8" to 2 1/8" |
| | ATQ4+ | 43137 | 1 1/8" to 4" | 7/8" to 3" |
| Screw Connect | AT2 | 43130 | 1/8" to 1" | 1/8" to 7/8" |
| | AT3 | 43131 | 5/8" to 3" | 3/8" to 2 1/8" |
| | AT4+ | 43132 | 1 1/8" to 4" | 7/8" to 3" |

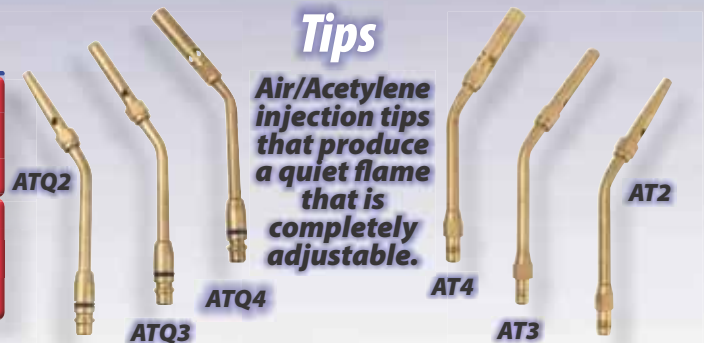

Tips
Air/Acetylene injection tips that produce a quiet flame that is completely adjustable.



Quick Connect and Screw Connect



Soft Flame Kits/Tips

The Air/Acetylene Soft Flame has always been the "Old Reliable" flametool for plumbers, producing a precise 2700°F target heat. An excellent tool for soldering copper tubing.

FOR U.S. JOBS
UNIWELD EMPLOYS OVER 300 WORKERS

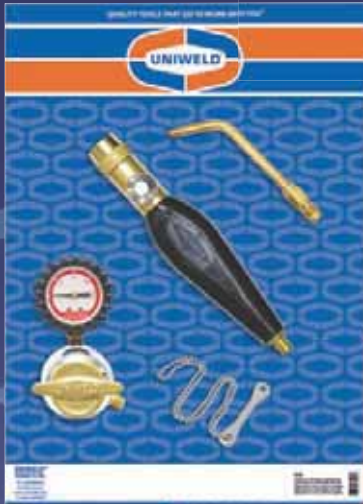

K40

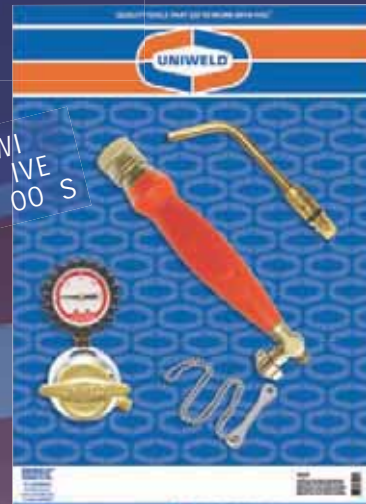

KQ37

USE WILSON
PROFESSIONAL
RUBBER HOSES

Kits

| | Part# | UPC# | Regulator | Tips | Handle |
|----------------------|-------|-------|-------------------------|----------------------|-------------------------|
| Screw Connect | K37 | 89100 | RB Acetylene Regulator | S23 Soft Flame Tip | TH3 Rear Control Valve |
| | K38 | 89101 | RMC Acetylene Regulator | S23 Soft Flame Tip | TH3 Rear Control Valve |
| | K40 | 89102 | RMC Acetylene Regulator | S23 Soft Flame Tip | TH9 Front Control Valve |
| | K41 | 89103 | RB Acetylene Regulator | S23 Soft Flame Tip | TH9 Front Control Valve |
| Quick Connect | KQ37 | 89104 | RB Acetylene Regulator | ASQ23 Soft Flame Tip | TH6 Rear Control Valve |
| | KQ38 | 89105 | RMC Acetylene Regulator | ASQ23 Soft Flame Tip | TH6 Rear Control Valve |

Kits Include H12 [12.5 ft.] Acetylene Hose, W05 Tank Key w/chain. Regulators fitted with protective rubber gauge boots.

2 Air/Acetylene

Tips

| | Part# | UPC# | Copper Tubing Capacity | | UPC# | Part# |
|----------------------|-------|-------|------------------------|----------------|-------|----------------------|
| | | | Solder | Braze | | |
| Screw Connect | S21 | 43141 | 1/16" to 1/8" | Up to 1/16" | 43151 | ASQ21 |
| | S22 | 43142 | 1/8" to 3/8" | Up to 1/8" | 43152 | ASQ22 |
| | S23 | 43143 | 3/16" to 1/2" | Up to 3/8" | 43153 | ASQ23 |
| | S24 | 43144 | 1/2" to 1" | Up to 1/2" | 43154 | ASQ24 |
| | S25 | 43145 | 3/4" to 1 1/2" | 1/2" to 3/4" | 43155 | ASQ25 |
| | S26 | 43146 | 1" to 4" | 3/4" to 1 1/2" | 43156 | ASQ26 |
| | S27 | 43147 | 1/8" to 3/8" | Up to 1/8" | 43157 | ASQ27 |
| | | | | | | Quick Connect |



Uniweild Products, Inc. Fort Lauderdale, FL 33312 U.S.A. Customer Service: 800.323.2111
info@uniweild.com • www.uniweild.com

25

Air/Acetylene Screw Connect



Specialty Tips

FOR U.S. JOBS
UNIWELD EMPLOYS OVER 300 WORKERS

Select from a wide range of Specialty Tips that fit our air/fuel "screw connect" torch handles. This grouping includes our sensitive Halide Leak Detector with probe hose.

2 Air/Acetylene

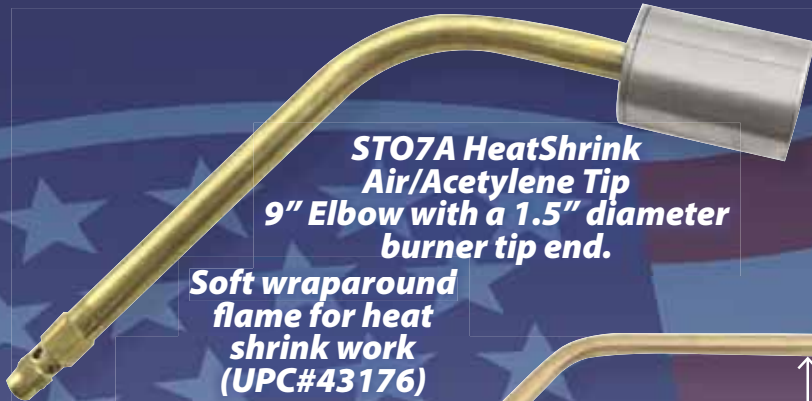

ST07A HeatShrink Air/Acetylene Tip
9" Elbow with a 1.5" diameter burner tip end.

Soft wraparound flame for heat shrink work (UPC#43176)



Halide Leak Detector Tip LD32 with probe hose for Air/Acetylene use (UPC#43200)
HO2-3
3 ft. Probe Hose for LD32 (UPC#43205)

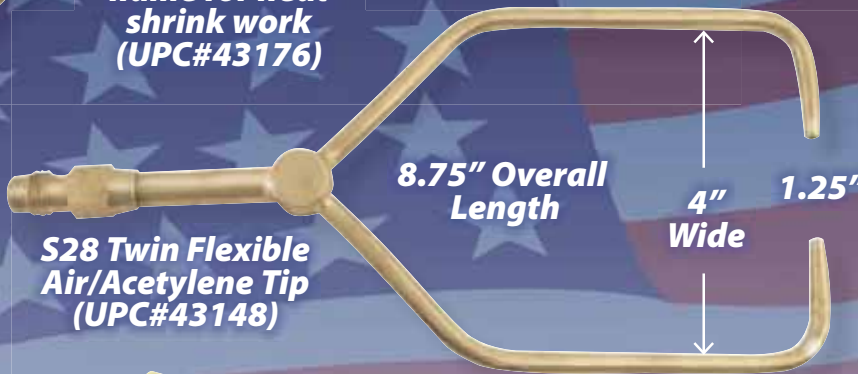

S28 Twin Flexible Air/Acetylene Tip (UPC#43148)

8.75" Overall Length

4" Wide

1.25"



Acetylene Paint Burner PB29
Heavy Duty Forged Brass Burner: 2" wide flame for paint removal and tile cutting (UPC\$43190)



Chisel Solder Iron SS37
For Acetylene (UPC#43180)



Chisel Copper Head CH20
For Acetylene (UPC#43182)



Pointed Solder Iron SS38
For Acetylene (UPC#43181)



Pointed Copper Head CH32
For Acetylene (UPC#43183)

A Plumbing and Heating Favorite



LP Twister® Kits

FOR U.S. JOBS
UNIWELD EMPLOYS OVER 300 WORKERS

The popular LP Twister® is a favorite tool among tradesmen in Plumbing and Heating. The Uniweld swirl combustion tips produce a high energy efficient flame for soldering that remains stable in windy conditions. The helical blade inside this tip efficiently premixes the fuel gas and air to deliver maximum combustion and fast heat transfer. Use this tip with Propane or MAP//Pro™ (Propylene) gas.



89606

TARGET HEAT



TARGET HEAT AREA
THE MOST EFFICIENT AREA FOR HEAT TRANSFER.

| Part#/UPC# | 89606 | 89607 |
|------------------|----------------------------|----------------------------|
| Regulator | RLPB L.P. Regulator CGA510 | RLPB L.P. Regulator CGA510 |
| Tips | T-4 Quick Connect | TS-4 Screw Connect |
| Handle | TH6B Rear Control Valve | TH3B Rear Control Valve |

Kits include HLP14B [12.5 ft.] L. P. Gas Hose.
Regulators fitted with protective rubber gauge boots.

**LP Twister®
Tips**

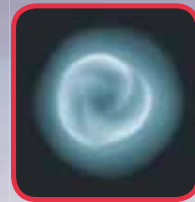
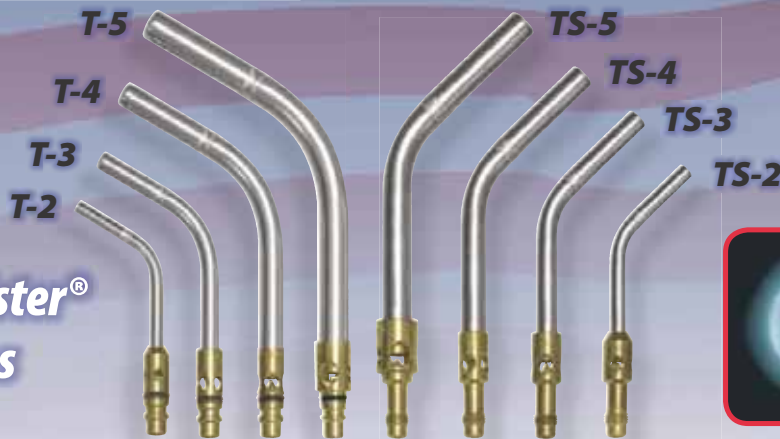

Copper Tubing Capacity
Propane Gas Solder Braze
MAP//Pro™ [Propylene] Gas Solder Braze

| | Part# | UPC# | Solder | Braze | Solder | Braze | UPC# | Part# | |
|----------------------|-------|-------|------------------|----------------|----------------|----------------|-------|-------|----------------------|
| Quick Connect | T-2 | 43030 | 1/8" to 1/4" | 1/16" to 1/4" | 1/8" to 1/2" | 1/8" to 1/4" | 43035 | TS-2 | Screw Connect |
| | T-3 | 43031 | 1/4" to 1" | 1/8" to 1/2" | 1/4" to 1 1/2" | 1/4" to 1/2" | 43036 | TS-3 | |
| | T-4 | 43032 | 1/4" to 1 1/2" | 1/4" to 3/4" | 1/4" to 2 1/2" | 1/4" to 1 1/4" | 43037 | TS-4 | |
| | T-5 | 43033 | 1 1/2" to 2 1/2" | 1/2" to 1 1/4" | 1" to 4" | 1/2" to 2" | 43038 | TS-5 | |



Uniweld Products, Inc. Fort Lauderdale, FL 33312 U.S.A. Customer Service: 800.323.2111
info@uniweld.com • www.uniweld.com

27

3 Air/LP

Quick Connect and Screw Connect



LP Thruster® Kits/Tips

Plumbers and Maintenance Repair Tradesmen prefer LP Thruster's proven efficiency and the availability of economical Propane. LP Thruster® tips have a built-in patented screen diffusion flame holder to maximize combustion. The flame is adjustable without tip burnout.

FOR U.S. JOBS
UNIWELD EMPLOYS OVER 300 WORKERS

TARGET HEAT



PROANE 1750 °F [954 °C]
MAP//Pro™ 2400 °F [1316 °C]
(Propylene)

TARGET HEAT AREA
THE MOST EFFICIENT AREA
FOR HEAT TRANSFER.

Part#
UPC#

KLPTQ4
89201

KLPT4
89200

| | | |
|-----------|-------------------------------|-------------------------------|
| Regulator | RLPB L.P. Regulator CGA510 | RLPB L.P. Regulator CGA510 |
| Tips | LPTQ4 Quick Connect | LPT4 Screw Connect |
| Handle | TH7B Rear Control Valve | TH5B Rear Control Valve |

Kits include HLP14B [12.5 ft.] L. P. Gas Hose.
Regulators fitted with protective rubber gauge boots.

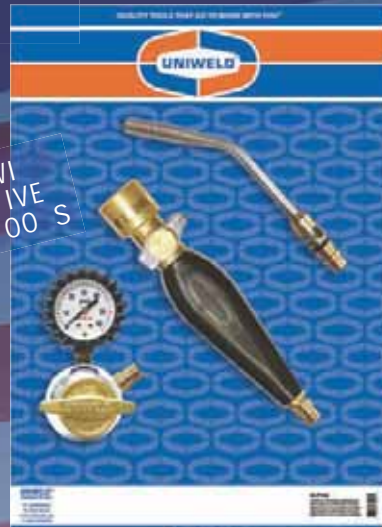

KLPTQ4

LP Thruster® Tips

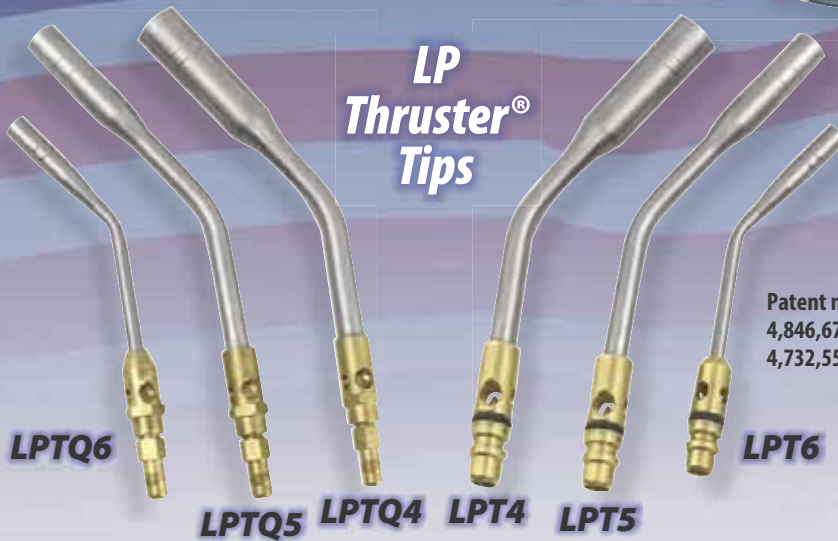

Patent numbers:
4,846,670 and
4,732,559

Copper Tubing Capacity
Propane Gas MAP//Pro™ [Propylene] Gas

| | Part# | UPC# | Solder | Braze | Solder | Braze | UPC# | Part# |
|---------------|-------|-------|----------------|----------------|----------------|--------------|-------|---------------|
| Quick Connect | LPTQ4 | 43165 | 3/8" to 1" | 1/4" to 5/8" | 3/8" to 1 1/2" | 3/8" to 1" | 43160 | LPT4 |
| | LPTQ5 | 43166 | 5/8" to 2 1/2" | 5/8" to 1 3/8" | 1" to 2 1/2" | 1" to 2" | 43161 | LPT5 |
| | LPTQ6 | 43167 | 7/8" to 3" | 7/8" to 2 1/8" | 1 1/2" to 4" | 1 1/2" to 3" | 43162 | LPT6 |
| | | | | | | | | Screw Connect |

3 Air/LP





Portable Kit with Swivl-it Fitting

LP Thruster® Kits

Lightweight, portable kits featuring "Swivl-it" fittings that eliminate hose kinking and wrist fatigue. Solder up to 1.5" and braze up to 1" copper tubing. Metal carrying stand holds two disposable cylinders.

FOR U.S. JOBS
UNIWELD EMPLOYS OVER 300 WORKERS

TARGET HEAT



TARGET HEAT AREA
THE MOST EFFICIENT AREA
FOR HEAT TRANSFER.



KTSQ2

| Part# | UPC# | Regulator | Tips | Handle | Hose | Swivl-it™ | Carrying Stand |
|-------|-------|-----------|-------|--------|--------|-----------|----------------|
| KTS2 | 89208 | RP3B | LPT4 | TH5B | HLP14B | HCC39 | 512 |
| KTSQ2 | 89205 | RP3B | LPTQ4 | TH7B | HLP14B | HCC39 | 512 |

Disposable cylinders not included in kits and are sold separately.

Swivl-it Kits

500,000 BTU Weed Burner Scorcher®

A Propane Gas Torch Kit with hundreds of uses, including weed burning, asphalt repair, ice melting, debris burning, fire ant mounds and roofing repairs. Hooks up to a standard 20 lb. Propane (barbeque) tank.

| Part# | UPC# | Description | Hose | Accessories |
|-------|-------|---------------------------------------|------|------------------------|
| WB500 | 00700 | Weed Burner 10' w/P.O.L. Safety Valve | | Flint Lighter Included |

Sold in units of 6 only.

Scorcher®



Flint Lighter included

All Steel Torch Head

All Steel Handle

10' U.L. Listed Propane Hose with P.O.L. Safety Valve



WB500

3 Air/LP



Uniweld Products, Inc. Fort Lauderdale, FL 33312 U.S.A. Customer Service: 800.323.2111
info@uniweld.com • www.uniweld.com

29



A Concentrated Heat Source

Pencil Point Flame Kits

FOR U.S. JOBS
UNIWELD EMPLOYS OVER 300 WORKERS

The Pencil Point Flame Tip produces a stable, long center cone surrounded by small preheat flames for a concentrated heat source. Use with either Propane or MAP//Pro™ (Propylene) gas without changing the orifice. Solder up to 1.5" and braze up to 7/8" copper tubing.

TARGET HEAT



TARGET HEAT AREA
THE MOST EFFICIENT AREA
FOR HEAT TRANSFER.

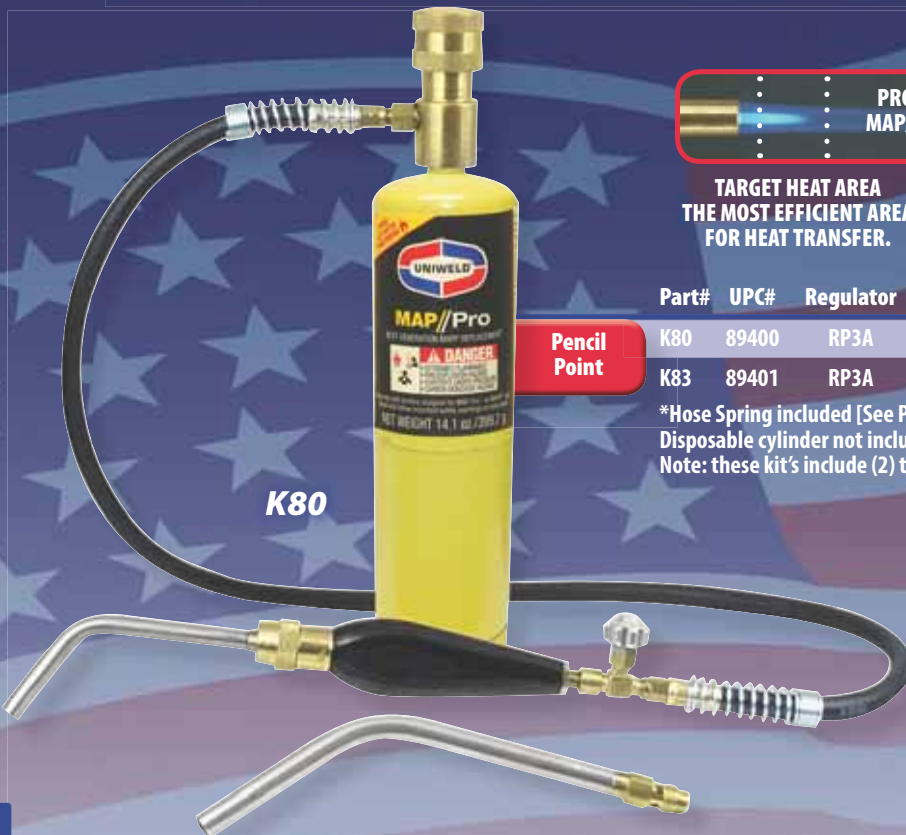

K80

Pencil Point

| Part# | UPC# | Regulator | Tips | Handle | Hose |
|-------|-------|-----------|-----------|--------|-----------------------|
| K80 | 89400 | RP3A | SM36/SM38 | TH3 | HLP10SS-3 ft.* w/SHLP |
| K83 | 89401 | RP3A | SM36/SM38 | TH9 | HLP11SS-6 ft.* w/SHLP |

*Hose Spring included [See Page 33].
Disposable cylinder not included in kits and is sold separately.
Note: these kit's include (2) tips SM36/SM38

Pencil Point Flame Tips



SM36

SM38

Copper Tubing Capacity

| | Part# | UPC# | Propane Gas | | MAP//Pro™ [Propylene] Gas | | Length |
|---------------|-------|-------|--------------|---------------|---------------------------|--------------|--------|
| | | | Solder | Braze | Solder | Braze | |
| Screw Connect | SM36 | 43170 | 1/8" to 3/8" | 1/16" to 1/4" | 1/8" to 1/2" | 1/8" to 3/8" | 6" |
| | SM38 | 43171 | 1/4" to 1" | 1/8" to 1/2" | 1/8" to 1 1/2" | 1/4" to 7/8" | 9" |

3 Air/LP

30



Uniweild Products, Inc. Fort Lauderdale, FL 33312 U.S.A. Customer Service: 800.323.2111
info@uniweild.com • www.uniweild.com

A Concentrated Heat Source



Heat Shrink Kits/Tips

FOR U.S. JOBS
UNIWELD EMPLOYS OVER 300 WORKERS

These kits feature specifically designed tips for heat shrink tubing in the telecommunications field. You'll achieve a soft, wraparound flame that spreads the heat quickly and evenly without overheating.

The air and fuel gas mix produces a bright yellow, highly visible flame. Use with either Propane or MAP//Pro™ (Propylene) gas without having to change the orifice.



| Heat Shrink Kits | Part# | UPC# | Regulator | Tips | Handle | *Hose | Size |
|------------------|--------|-------|-----------|--------|--------|---------|-----------------------|
| | KCA110 | 89300 | RP3A | ST06MP | TH9 | HLP11SS | 1" O.D. Flame Shield |
| | KCA111 | 89301 | RP3A | ST07MP | TH9 | HLP11SS | 1½" O.D. Flame Shield |

*6 ft. hose with SHLP Hose Spring [see page 35]. Disposable cylinder is not included in kits and is sold separately.

| Heat Shrink Tips Screw Connect | Part# | UPC# | Description |
|-----------------------------------|---------|-------|---|
| | ST06MP | 43175 | Propane / MAP//Pro™ [Propylene] 9" elbow with a 1" O.D. Flame Shield |
| | ST07MP | 43177 | Propane / MAP//Pro™ [Propylene] 9" elbow with a 1½" O.D. Flame Shield |
| | ST07RSM | 43178 | Propane / MAP//Pro™ [Propylene] 7" elbow with a 1½" O.D. Flame Shield |
| | ST07A | 43176 | Acetylene 9" elbow with a 1½" O.D. Flame Shield |

Unitorch® Regulators

The safest available for disposable cylinders. A piston inside the regulator eliminates leakage problems. Operates in an upside down position (time, temperature and contents dependent).



| Unitorch® Regulators | Part# | UPC# | Description |
|-------------------------|-------|-------|---|
| | RP3A | 43000 | Unitorch® Regulator with "A" outlet fitting |
| | RP3B | 43001 | Unitorch® Regulator with "B" outlet fitting |
| | RP3E | 43002 | Unitorch® Regulator with 360° swivel elbow for use with UT2, UT3, UT4, UT5 and UT6 replacement tips |



Uniweld Products, Inc. Fort Lauderdale, FL 33312 U.S.A. Customer Service: 800.323.2111
info@uniweld.com • www.uniweld.com

31

3 Air/LP

Thruster®, Twister®, Double & Triple Twister®



Hand Torches

FOR U.S. JOBS
UNIWELD EMPLOYS OVER 300 WORKERS

Uniweld Hand Torches are the right choice for small jobs in tight areas with limited access. These lightweight, portable flametools can be operated with Propane or MAP//Pro™ (Propylene). Hand torches are shipped on display cards or in clamshell packaging.

PCV25 Pencil Flame Hand Torch

Adjustable pencil point flame for soldering copper tubing and thawing frozen pipes.



RP3T5 Hand Torch

LP Twister® Tip utilizes swirl combustion technology to produce a high energy efficient flame. The flame remains stable in windy conditions. RP3E Unitorch Regulator with swivel elbow and UT5 Twister® Tip



RP3T2 Hand Torch

UT2
Double
Twister®
Tip



RP3T3 Hand Torch

UT3
Triple
Twister®
Tip



Tubing Capacity

| Part# | UPC# | Propane | | MAP//Pro™ [Propylene] | | Replacement Tip |
|--------|-------|--------------|--------------|-----------------------|--------------|-----------------|
| | | Solder | Braze | Solder | Braze | |
| PCV25 | 43210 | Up to 7/8" | Up to 3/8" | Up to 1" | Up to 5/8" | N/A |
| RP3T2 | 43007 | Up to 3 1/2" | Up to 2" | Up to 4" | Up to 3" | UT2 |
| RP3T3 | 43008 | Up to 4" | Up to 2 1/2" | Up to 6" | Up to 4" | UT3 |
| RP3T4* | 43004 | Up to 3" | Up to 1" | Up to 3 1/2" | Up to 1 3/4" | UT4* |
| RP3T5 | 43005 | Up to 3" | Up to 1" | Up to 3 1/2" | Up to 1 3/4" | UT5 |
| MKT-4L | 89501 | Up to 3" | Up to 1" | Up to 3 1/2" | Up to 1 3/4" | UT5 |

MKT-4L includes RP3T5 Hand Torch with [1] MAP//Pro™ disposable cylinder. Shipped in display box [6 per case].



MKT-4L

* LP Thruster® Tip with screen diffusion flame holder for flame adjustment without tip damage.

3 Air/LP

32



Uniweld Products, Inc. Fort Lauderdale, FL 33312 U.S.A. Customer Service: 800.323.2111
info@uniweld.com • www.uniweld.com

Self-igniting Swirl Combustion Tips



Hand Torches

FOR U.S. JOBS
UNIWELD EMPLOYS OVER 300 WORKERS

Uniweld Self-igniting Hand Torches eliminate the need for a flint lighter. Lightweight and portable, these flame tools can be operated with Propane or MAP//Pro™ (Propylene).



Tip Swivels 360°

Operates in any position, even upside down



Pull down on bullet casing to activate spark igniter

HT44 Twister®2 Hand Torch

360° Swivel Tip
Operates in any position, even upside down
HT44TE Twister® swirl combustion Tip End

RP3T6 Silver Bullet® Hand Torch

UT6 LP Twister® Silver Bullet® Tip
Stainless Steel and Aluminum construction

TARGET HEAT



TARGET HEAT AREA THE MOST EFFICIENT AREA FOR HEAT TRANSFER.

Tip Swivels 360°



Trigger Lock with Instant Safety Release
Full-size comfort grip

Tubing Capacity

| Hand Torches | Part# | UPC# | Propane | | MAP//Pro™ [Propylene] | | Replacement Tip |
|--------------|-------|-------|----------|----------|-----------------------|--------------|-----------------|
| | | | Solder | Braze | Solder | Braze | |
| | RP3T6 | 43006 | Up to 3" | Up to 1" | Up to 3 1/2" | Up to 1 3/4" | UT6 |
| | HT44 | 43216 | Up to 3" | Up to 1" | Up to 4" | Up to 1 1/4" | HT44TE |

Disposable cylinders not included and are sold separately.



Uniweld Products, Inc. Fort Lauderdale, FL 33312 U.S.A. Customer Service: 800.323.2111
info@uniweld.com • www.uniweld.com

33

3 Air/LP



Ergonomic, durable Torch Handles

Rugged, ergonomically designed air/fuel torch handles provide you with better grip, balance and comfort. Handle options include screw connect or quick connect, "A" or "B" inlet connections and front or rear control valves.

FOR U.S. JOBS
UNIWELD EMPLOYS OVER 300 WORKERS

QUICK CONNECT HANDLES

TUA Screw Connect



Screw Connect Tip to Quick Connect Air/Fuel Handle Adaptor
UPC#43120



TH6



TH7



TH8

SCREW CONNECT HANDLES

UTA Quick Connect



Quick Connect Tip to Screw Connect Air/Fuel Handle Adaptor
UPC#43121



TH3



TH5



TH9

Air/Acetylene Gas "A"
(3/8" -24) L.H. Inlet Connection

Part# UPC#

| | Part# | UPC# | |
|----------------------|-------|-------|-------------------|
| Screw Connect | TH3 | 43100 | Rear Valve |
| | TH5 | 43105 | Front Pilot Valve |
| | TH9 | 43113 | Front Valve |
| Quick Connect | TH6 | 43107 | Rear Valve |
| | TH7 | 43109 | Front Pilot Valve |
| | TH8 | 43111 | Front Valve |

Air/LP Gas "B"
(9/16" -18) L.H. Inlet Connection

Part# UPC#

| | Part# | UPC# | |
|----------------------|-------|-------|-------------------|
| Screw Connect | TH3B | 43101 | Rear Valve |
| | TH5B | 43106 | Front Pilot Valve |
| | TH9B | 43114 | Front Valve |
| Quick Connect | TH6B | 43108 | Rear Valve |
| | TH7B | 43110 | Front Pilot Valve |
| | TH8B | 43112 | Front Valve |

34



Uniweld Products, Inc. Fort Lauderdale, FL 33312 U.S.A. Customer Service: 800.323.2111
info@uniweld.com • www.uniweld.com

4 Parts & Accessories

"A", "B" and "AB" Connections



Hoses

FOR U.S. JOBS
UNIWEELD EMPLOYS OVER 300 WORKERS

Uniweld flexible Oxyfuel Hoses are color coded, have 8-sided crimp ferrules and are capable of withstanding high working pressures for reliability and long work life.



H32A

Hose Spring

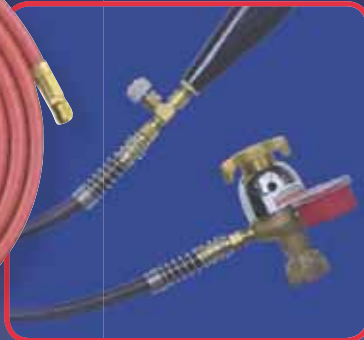

H12

HLP14B

Hose Spring (Part#SHLP) may be added to Acetylene or LP gas hoses by adding an (S) for one spring or (SS) for two springs (one @ each end) to the hose Part#.
Example: H12S, H12SS/HLP14BS, HLP14BSS

Oxyacetylene Twin Hose $\frac{3}{16}$ " I.D., Max. W.P. 200 psi

| Part# | UPC# | Length | Connection |
|-------|-------|----------|------------|
| H32A | 43510 | 12.5 ft. | "A" |
| H32B | 43512 | 12.5 ft. | "B" |
| H32AB | 43511 | 12.5 ft. | "AB**" |
| H33A | 43513 | 25 ft. | "A" |
| H33B | 43515 | 25 ft. | "B" |
| H33AB | 43514 | 25 ft. | "AB**" |
| H34A | 43516 | 50 ft. | "A" |
| H34B | 43517 | 50 ft. | "B" |

Oxyacet. Twin Hose

**"AB" - "A" fitted one end, "B" fitted opposite end

LP Gas Single Hose $\frac{3}{16}$ " I.D., Max. W.P. 125 psi

| Part# | UPC# | Length | Connection |
|--------|-------|----------|------------|
| HLP10 | 43530 | 3 ft. | "A" |
| HLP10B | 43531 | 3 ft. | "B" |
| HLP11 | 43533 | 6 ft. | "A" |
| HLP11B | 43534 | 6 ft. | "B" |
| HLP13 | 43537 | 25 ft. | "A" |
| HLP13B | 43538 | 25 ft. | "B" |
| HLP14 | 43541 | 12.5 ft. | "A" |
| HLP14B | 43542 | 12.5 ft. | "B" |

LP Gas Single Hose

Oxy/LP Gas Grade "T" Twin Hose $\frac{3}{16}$ " I.D., Max. W.P. 200 psi

| Part# | UPC# | Length | Connection |
|-------|-------|----------|------------|
| H11 | 43500 | 6 ft. | "A" |
| H11B | 43501 | 6 ft. | "B" |
| H12 | 43502 | 12.5 ft. | "A" |
| H12B | 43503 | 12.5 ft. | "B" |
| H13 | 43504 | 25 ft. | "A" |
| H13B | 43505 | 25 ft. | "B" |

Acetylene Single Hose

Oxy/LP Grade "T" Twin Hose

| Part# | UPC# | Length | Connection |
|--------|-------|----------|------------|
| H32AT | 43560 | 12.5 ft. | "A" |
| H32BT | 43561 | 12.5 ft. | "B" |
| H32ABT | 43562 | 12.5 ft. | "AB**" |

**"AB" - "A" fitted one end, "B" fitted opposite end



H32AT

Reference Information: "A" = $\frac{3}{8}$ " - 24 "B" = $\frac{9}{16}$ " - 18



Uniweld Products, Inc. Fort Lauderdale, FL 33312 U.S.A. Customer Service: 800.323.2111
info@uniweld.com • www.uniweld.com

35

4 Parts & Accessories



"Patriot" Series Regulators

FOR U.S. JOBS
UNIWELED EMPLOYS OVER 300 WORKERS

Patriot Series Regulators feature protective rubber gauge boots, rear inlet service and various CGA cylinder connections. Specially compounded diaphragm and seat material provide accuracy and reliability. Listed.

4 Parts & Accessories

| | Part# | UPC# | CGA Inlet | Outlet Connection | 1 1/2" Delivery/Contents | Delivery PSI |
|-------------|-------|-------|-----------|-------------------|---------------------------|--------------|
| Oxygen | RO | 12000 | 540 | "A" RH | [G49D] 100/4000 [G56D] | 2-60 |
| | ROB | 12001 | 540 | "B" RH | [G49D] 100/4000 [G56D] | 2-60 |
| Acetylene | RMC | 12006 | 200 | "A" LH | Contents [G19D] | 2-15 |
| | RMC2 | 12007 | 200 | "A" LH | [G15D] 30/Contents [G19D] | 2-15 |
| | RB | 12010 | 520 | "A" LH | Contents [G19D] | 2-15 |
| | RB2 | 12011 | 520 | "A" LH | [G15D] 30/Contents [G19D] | 2-15 |
| LP Fuel Gas | RLP | 12014 | 510 | "A" LH | 60 Delivery [G83D] | 2-40 |
| | RLPB | 12015 | 510 | "B" LH | 60 Delivery [G83D] | 2-40 |



RMC2

FV600 Oxy/Fuel Adapter

Fuel Valve Adapter to connect a Uniweld Acetylene MC Regulator (CGA200) to a disposable fuel cylinder (CGA600). All Uniweld Acetylene regulator diaphragms and seals are compatible for use with either Propylene (MAP//Pro™) or Propane

fuel gas. **WARNING!**: Fuel compatibility with other manufacturer's Acetylene regulators must be determined prior to use. If not compatible, another option would be to replace the Acetylene regulator with an RP3A regulator.

USE WITH
PROPANE
REGULATORS



FV600

The Uniweld 71 welding handle & Type17 Weld/Braze tips will work properly using either of the fuel gases combined with Oxygen. The CA550 cutting attachment will also work with either fuel gas. However, the cutting tip is fuel specific and must be changed (see page 16). Also, the Cap'n Hook® tips are fuel specific. (see page 19). It is recommended to use grade "T" hose (H32AT) with Propylene (MAP//Pro™) or Propane fuel gas. If using grade "R" hose (H32A) with Propylene (MAP//Pro™) or Propane fuel gas, it must never be used in extremely cold temperatures below -10 °F. This may cause the fuel gas to liquefy and act as a solvent that will attack the internal hose material. Always bleed off the remaining fuel gas in the hose after each use.

There will be a noticeable performance and temperature difference when using Propylene (MAP//Pro™) versus Acetylene and an increase in oxygen consumption.

| Fuel | Temp °F | Ratio Oxy/Fuel |
|-----------|---------|----------------|
| Acetylene | 5589 °F | 1-1 |
| MAP//Pro™ | 5193 °F | 3.5-1 |
| Propane | 4579 °F | 4-1 |

It is highly recommended to use a Type17-3 or larger tip for brazing 3/8" and 7/8" copper line sets.





"Mastar® and Centurion®" Series Regulators

FOR U.S. JOBS
UNIWELD EMPLOYS OVER 300 WORKERS

UNIVERSITY
PROFESSIONAL
REGULATORS



Centurion®

RO100

The economical, lightweight Centurion® Series Regulators feature rugged brass bodies, 1.5" gauges and protective rubber gauge boots.



Mastar®

RSMC2

Uniweld's top-of-the-line, single stage Mastar® Series Regulators have two 1.5" gauges, a 3" pressure adjusting "T" handle and protective rubber gauge boots. Listed

| | | Part# | UPC# | CGA Inlet | Outlet Connection | Delivery 1 1/2" Gauges/Contents | Delivery PSI |
|------------|-----------|--------|-------|-----------|-------------------|-------------------------------------|--------------|
| Centurion® | Oxygen | RO100 | 14100 | 540 | "A" RH | [G49D] 100/4000 [G56D] | 2-60 |
| | Acetylene | RMC100 | 14102 | 200 | "A" LH | [G15D] 30/Contents [G19D] | 2-15 |
| Mastar® | Oxygen | RS0 | 12100 | 540 | "A" RH | [G49D] 100/4000 [G56D] | 2-60 |
| | | RS0B | 12101 | 540 | "B" RH | [G49D] 100/4000 [G56D] | 2-60 |
| | | 12106 | 12106 | 540 | "A" RH | [psi/kg] [G85-1D] 100/4000 [G82-1D] | 2-60 |
| | Acetylene | RSMC2 | 12102 | 200 | "A" LH | [G15D] 30/Contents [G19D] | 2-15 |
| | | RSMC2B | 12103 | 200 | "B" LH | [G15D] 30/Contents [G19D] | 2-15 |
| | | RSB2 | 12104 | 520 | "A" LH | [G15D] 30/Contents [G19D] | 2-15 |
| | | RSB2B | 12105 | 520 | "B" LH | [G15D] 30/Contents [G19D] | 2-15 |
| | | 12107 | 12107 | 520 | "A" LH | [psi/kg] [G79-1D] 30/400 [G73-1D] | 2-15 |

All regulators with "A" [3/8" - 24] outlet fittings are available with "B" [9/16" - 18] outlet fittings. To order, add "B" to the Part Number. Pressure relief devices are not designed to protect downstream equipment.

Replacement Gauges

1 1/2" Gauges [1/8" NPT] with Protective Rubber Boots



G49D

| | Oxygen |
|------|----------------------|
| G49D | 100 psi, Steel Case |
| G56D | 4000 psi, Steel Case |

| | Acetylene |
|------|--|
| G15D | 30 psi, Steel Case, Red Line 15-30 psi |
| G19D | 1/4, 1/2, 3/4, Full [Contents] Steel Case, [400 psi Max] |



G19D

GB155 Protective Rubber Boot for all 1 1/2" Gauges [Pkg. of 2]

Gauge Part Numbers without D are individually boxed. Gauge Part Numbers with D denote hanging display packaging [D=pkg]. For complete replacement welding gauge information, refer to page 99.



Uniweld Products, Inc. Fort Lauderdale, FL 33312 U.S.A. Customer Service: 800.323.2111
info@uniweld.com • www.uniweld.com

37

4 Parts & Accessories

CGA Valve Connections



Cylinders FOR U.S. JOBS

UNIWELED EMPLOYS OVER 300 WORKERS

4 Parts & Accessories



| | Part# | Description | | CGA200 | VALVE | NIPPLE | NUT |
|--|---|-------------|-------------------------------|---|-------|--------|-----|
| "MC" Tank | MC24 | Nut | Acetylene | .625" - 20 NGO-R.H. | | | |
| | MC52 | Nipple | | 7/16" - 20 UNF, 1 1/8" Long [R] | | | |
| | Used on: RMC Approx. 10 cu. ft. cylinder only | | | | | | |
| | | | | CGA300 | | | |
| "CA" Tank | 8159-4 | Nut | Acetylene | .830" - 14 NGO-R.H. | | | |
| | 11A05 | Nipple | | 7/16" - 20 UNF, 1 5/16" Long [R] | | | |
| | 8112-3 | Nipple | | 1/4" - 18 NPT, 1 5/16" Long [RUH] | | | |
| Used on: R, RUH, RHG, RHT, RVT, MR | | | | | | | |
| | | | | CGA320 | | | |
| | 8159-3 | Nut | Carbon Dioxide | .830" - 14 NGO-R.H. | | | |
| | 8312 | Nipple | | 1/4" - 18 NPT, 2" Long | | | |
| | X09R | O-Ring | | [Do not use with Gasket] | | | |
| | Used on: CEF, RUH, RHF, RHT, RV, RVT, RHFG, R1300 [CO ₂] Use "O-Ring X09R only for 8312 Nipple, Not Gasket" | | | | | | |
| | | | | CGA346 | | | |
| | 8959 | Nut | Air | .830" - 14 NGO-R.H. | | | |
| | 1805 | Nipple | | 1/4" - 18 NPT, 2 1/2" Long | | | |
| | Used on: RV, RVT, RHT, RUH, R1800 Regulators | | | | | | |
| | | | | CGA350 | | | |
| | 8859 | Nut | Hydrogen | .830" - 14 NGO-L.H. | | | |
| | 8812-2 | Nipple | | 1/4" - 18 NPT, 2 1/2" Long | | | |
| | Used on: RUH, RV, RVT, RHT Regulators | | | | | | |
| | | | | CGA510 | | | |
| "POL" Tank | 8159-2 | Nut | Acetylene and Fuel Gas | .880" - 14 NGO-L.H. | | | |
| | 1205 | Nipple | | 7/16" - 20 UNF 2 3/16" Long [R] | | | |
| | 1205-2 | Nipple | | 1/4" - 18 NPT, 2 13/32" Long [MR] | | | |
| | 8112-2 | Nipple | | 1/4" - 18 NPT, 3 3/16" Long [RV, RUH] | | | |
| Used on: R, RUH, RHT, RHG, RV, RVT, MR Regulators CGA415 [ALC] [Canada only] on request | | | | | | | |
| | | | | CGA520 | | | |
| "B" Tank | B10 | Nut | Acetylene | .899" - 18 NGO-R.H. | | | |
| | B51 | Nipple | | 7/16" - 20 UNF 1 1/4" Long [R] | | | |
| | RU12-2 | Nipple | | 1/4" - 18 NPT, 2 3/8" Long [MR, RUH] | | | |
| Used on: RB, RUH, MR, R Regulators Cylinder: 35-75 cu. ft. only | | | | | | | |
| | | | | CGA540 | | | |
| | 8059-2 | Nut | Oxygen Only | .908" - 14 NGO-R.H. | | | |
| | 1005-3* | Nipple | | 7/16" - 20 UNF 1 9/32" Long [R] | | | |
| | 8012-2 | Nipple | | 1/4" - 18 NPT, 2" Long [RV] | | | |
| | RU12 | Nipple | | 1/4" - 18 NPT, 2 9/16" Long [RUH] | | | |
| Used on: MR, RHG, RHT, RV, RVT, RUH Regulators; For Oxygen Service Only *1005 1/4" - 18NPT[R] | | | | | | | |
| | | | | CGA580 | | | |
| | 8759 | Nut | Argon Helium Nitrogen | .960" - 14 NGO-R.H. | | | |
| | 1205 | Nipple | | 7/16" - 20 UNF 2 3/16" Long [R] | | | |
| | 1205-2 | Nipple | | 1/4" - 18 NPT, 2 13/32" Long [CEF] | | | |
| | 8112-2 | Nipple | | 1/4" - 18 NPT, 3 3/16" Long [RHF, RHFG] | | | |
| Used on: RUH, RV, RVT, RHF, CEF, RHT, RHFG, R1500 [Ni], RAR, R15NI Regulators Alternative Connections: CGA590 [LH], CGA555 [LH] on Request | | | | | | | |

Source: Compressed Gas Assoc., Std. V-1, 1994



Cylinder to Regulator



Adaptors FOR U.S. JOBS

UNIWELD EMPLOYS OVER 300 WORKERS

Part# F10X
UPC# 43300
CGA580 to
CGA540



Part# F22X
UPC# 43303
CGA540 to
CGA580



Part# F24X
UPC# 43304
CGA510 "POL"
to CGA300 "CA"



Part# F25
UPC# 43305
CGA200 "MC" 90°
to CGA510 "POL"



Part# F28
UPC# 43306
CGA300 "CA"
to CGA510 "POL"



Part# F31
UPC# 43307
CGA520 "B" to
CGA200 "MC"



Part# F33
UPC# 43309
CGA520 "B" 90°
to CGA510 "POL"



Part# F32
UPC# 43308
CGA510 "POL"
to CGA520 "B"



Part# F34
UPC# 43310
CGA200 "MC" 90°
to CGA520 "B"



Part# F35
UPC# 43311
CGA300 "CA" to
CGA520 "B"



Part# F36
UPC# 43319
CGA320 "CO2"
to CGA580



Part# F37
UPC# 43312
CGA510 "POL" to
CGA200 "MC"



Part# F38
UPC# 43313
CGA300 "CA" to
CGA200 "MC"



Part# F50
UPC# 43315
CGA520 "B" 90°
to CGA520 "B"



Part# F41
UPC# 43314
CGA200 "MC" to
CGA520 "B"



Part# F60
UPC# 43316
CGA410 Fitting to
CGA510 "POL"



Part# F61X
UPC# 43317
CGA520 "B" to
CGA300 "CA"



BRASS HOSE CLAMPS



HOSE NIPPLE

Hose Fittings



HOSE NUT



HOSE SPLICE [Push Type]

Part# UPC# HOSE I.D.

| | | |
|------|-------|-------|
| HC01 | 43376 | 3/16" |
| HC02 | 43377 | 1/4" |

Part# UPC# Nipple Size to Hose Nut

| | | | |
|-------|-------|-------|-----|
| HN83P | 43370 | 3/16" | "A" |
| HN87 | 43371 | 3/16" | "B" |
| HN84 | 43372 | 1/4" | "B" |

Part# UPC# Hose Nut to Nipple Size

| | | | |
|--------|-------|--------|---------------|
| HN82A | 43348 | "A" RH | 3/16" |
| HN83A | 43349 | "A" LH | 3/16" |
| 9059 | 43350 | "B" RH | 1/4" or 3/16" |
| 9059-2 | 43351 | "B" LH | 1/4" or 3/16" |

Part# UPC# Hose to Hose

| | | |
|------|-------|----------------|
| HS53 | 43373 | 1/4" to 1/4" |
| HS54 | 43374 | 3/16" to 1/4" |
| HS55 | 43375 | 3/16" to 3/16" |

"A" to "B"

Outlet Adaptor

| Part# | UPC# | Regulator | To | Hose |
|-------|-------|-------------|-----------------|------|
| F27L | 43320 | "A" Conn LH | "B" Hose Nut LH | LH |
| F27R | 43321 | "A" Conn RH | "B" Hose Nut RH | RH |

"A" to "B"

Outlet Adaptor

| Part# | UPC# | Regulator | To | Hose |
|-------|-------|-------------|-----------------|------|
| F58L | 43325 | "A" Conn LH | "B" Hose Nut LH | LH |
| F58R | 43326 | "A" Conn RH | "B" Hose Nut RH | RH |

"B" to "A"

Outlet Adaptor

| Part# | UPC# | Regulator | To | Hose |
|-------|-------|-------------|-----------------|------|
| F59L | 43327 | "B" Conn LH | "A" Hose Nut LH | LH |
| F59R | 43328 | "B" Conn RH | "A" Hose Nut RH | RH |

Adaptor and Connectors

"A" to "B" Welding Handle Adaptor
Part# UPC# Handle to Hose

| | | |
|------|-------|-----------------------------|
| F29L | 43322 | "A" Conn LH "B" Hose Nut LH |
| F29R | 43324 | "A" Conn RH "B" Hose Nut RH |

Hose Coupling

| Part# | UPC# | Hose Nut to | Hose Nut |
|-------|-------|-------------|----------|
| HCC40 | 43342 | "A" LH | "A" LH |
| HCC46 | 43343 | "A" LH | "B" LH |
| HCC41 | 43344 | "A" RH | "A" RH |
| HCC79 | 43345 | "B" LH | "B" LH |
| HCC47 | 43346 | "A" RH | "B" RH |
| HCC78 | 43347 | "B" RH | "B" RH |

Part# UPC# Inlet to Outlet

| "A" Size "Y" Outlet Adaptor | | | |
|-----------------------------|-------|--------|-----------------|
| FY11XA | 43332 | "A" LH | "A" Hose Nut LH |
| FY10XA | 43331 | "A" RH | "A" Hose Nut RH |
| "Y" Connectors w/Valves | | | |
| FY10XAV | 43334 | "A" RH | "A" Hose Nut RH |
| FY11XAV | 43335 | "A" LH | "A" Hose Nut LH |
| FY10XV | 43336 | "B" RH | "B" Hose Nut RH |
| FY11XV | 43337 | "B" LH | "B" Hose Nut LH |
| "B" Size "Y" Connectors | | | |
| FY11X | 43330 | "B" LH | "B" Hose Nut LH |
| FY10X | 43329 | "B" RH | "B" Hose Nut RH |



Uniweld Products, Inc. Fort Lauderdale, FL 33312 U.S.A. Customer Service: 800.323.2111
info@uniweld.com • www.uniweld.com

39

4 Parts & Accessories



Disposable and Refillable Cylinders & Tanks

FOR U.S. JOBS
UNIWELD EMPLOYS OVER 300 WORKERS

4 Parts & Accessories



| | Part# | UPC# | Approx. Cap. cu. ft. | O.D. Inches | Height w/valves Inches | Weight Lbs. | CGA Connection |
|------------|-------|-------|----------------------|-------------|------------------------|-------------|----------------|
| Acetylene | MC | 40032 | 10.00 | 4.00 | 15.00 | 8.00 | 200 |
| | B | 40033 | 40.00 | 6.00 | 23.25 | 25.5 | 520 |
| Oxygen | R | 40034 | 20.00 | 5.25 | 18.5 | 12.7 | 540 |
| | R40 | 40035 | 40.00 | 7.00 | 22.5 | 32.00 | 540 |
| Nitrogen | N20 | 40036 | 20.00 | 5.25 | 18.5 | 12.7 | 580 |
| | N40 | 40037 | 40.00 | 7.00 | 22.5 | 32.00 | 580 |
| | N60 | 40041 | 60.00 | 7.00 | 27.00 | 39.00 | 580 |
| *MAP//Pro™ | MDC | 40030 | 14.1 oz. | 3.00 | 11.00 | 2.00 | 600 |
| *Propane | PDC | 40031 | 14.1 oz. | 3.00 | 11.00 | 1.75 | 600 |

All tanks are shipped empty. • *Sold in case lot quantity only - 12 per case. - Disposable Propane and MAP//Pro™ cylinders are shipped full and meet DOT 39NRC specifications. MAP//Pro™ is a trademark of Worthington Industries.



TGCMC

40

Protect yourself against shortages by checking the cylinder contents with a Test Gauge.

Reading of Contents:

- Oxygen Pressure 1800-2200 PSI
- Acetylene Pressure 1/4, 1/2, 3/4 or FULL
- Nitrogen Pressure 1800-2200 PSI



| Part# | UPC# | Description |
|-------|-------|--------------------------|
| TGCB | 41250 | "B" Tank Test Gauge |
| TGCMC | 41251 | "MC" Tank Test Gauge |
| TGCN | 41252 | Nitrogen Tank Test Gauge |
| TGCO | 41253 | Oxygen Tank Test Gauge |



Uniweld Products, Inc. Fort Lauderdale, FL 33312 U.S.A. Customer Service: 800.323.2111
info@uniweld.com • www.uniweld.com



Plastic and Metal

Carrying Stands

FOR U.S. JOBS
UNIWELD EMPLOYS OVER 300 WORKERS

The rugged Uniweld line of Carrying Stands and Cylinder Trucks provides convenience, portability and organization. All blue enameled steel models feature fitted hand grips and hose holders. The center-balanced blue plastic tote has storage space for cylinders, hoses and accessories.

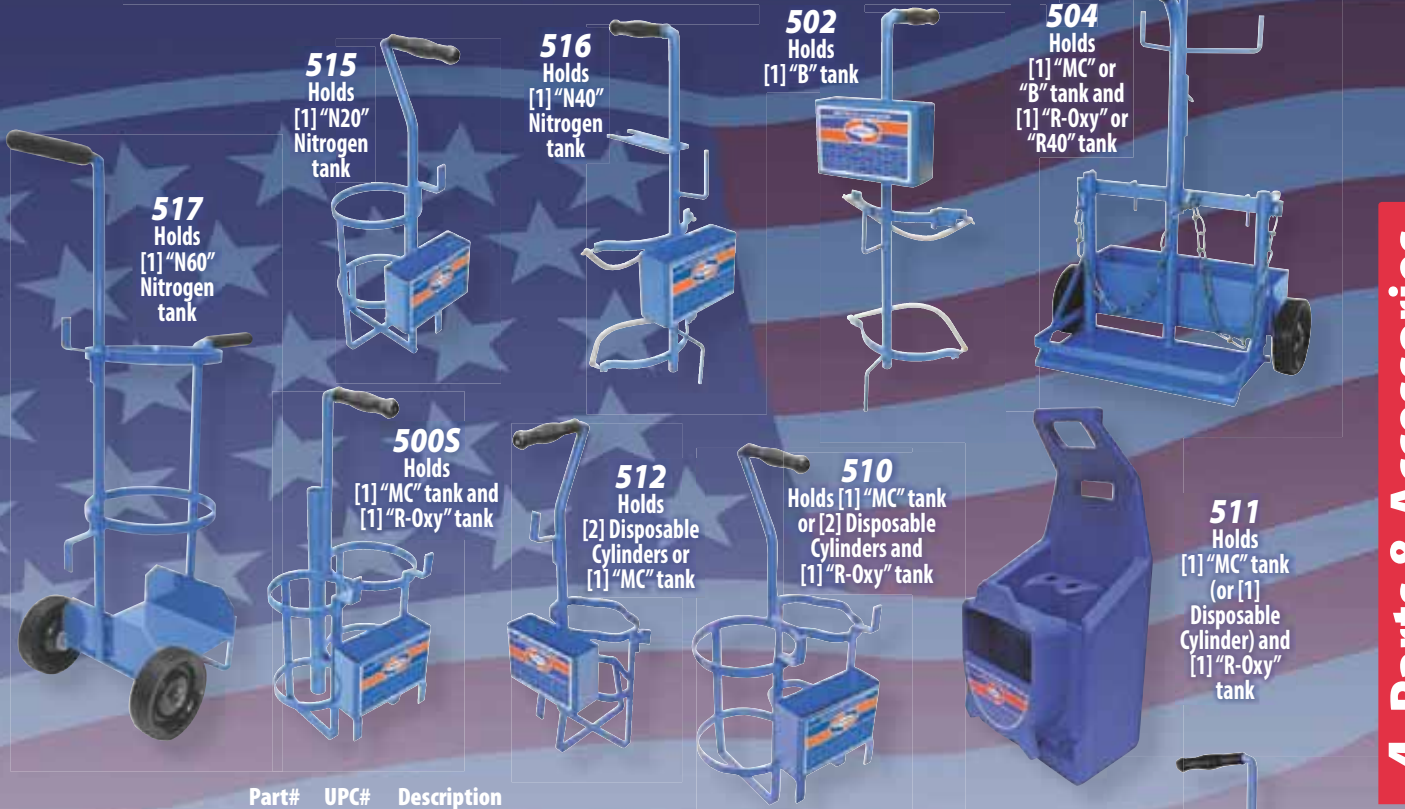

4 Parts & Accessories

| Part# | UPC# | Description |
|-----------------|---------|---|
| Carrying Stands | Metal | 500S 30001 Carrying stand for [1] "MC" tank & [1] "R-Oxy" tank w/utility tray & brazing rod holder |
| | | 502 30003 Carrying stand for [1] "B" tank w/utility tray & Air/Fuel handle holder |
| | | 503 30004 Carrying stand with wheels for [1] "B" tank & [1] "R-Oxy" tank |
| | | 504 30005 Carrying stand with wheels for [1] "MC" or "B" tank & [1] "R-Oxy" or "R40" tank |
| | | 510 30007 Carrying stand with utility tray for [1] "MC" tank or [2] disposable fuel cylinders and [1] "R-Oxy" tank |
| Carrying Stands | Plastic | 511 30008 Molded blue plastic carrying stand for [1] "MC" tank or [1] disposable fuel cylinder and [1] "R-Oxy" tank |
| | | 512 30009 Carrying stand for [2] disposable fuel cylinders or [1] "MC" tank w/utility tray and Air/Fuel handle holder |
| Carrying Stands | Metal | 515 30012 Nitrogen carrying stand for [1] 20 cu. ft. Nitrogen tank |
| | | 516 30013 Nitrogen carrying stand for [1] 40 cu. ft. Nitrogen tank |
| | | 517 30014 Nitrogen carrying stand with wheels for [1] 60 cu. ft. tank |

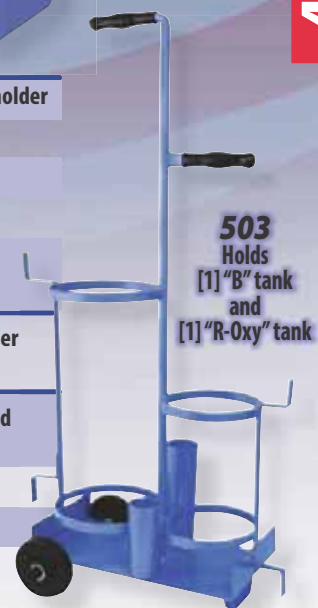

Uniweld Products, Inc. Fort Lauderdale, FL 33312 U.S.A. Customer Service: 800.323.2111
info@uniweld.com • www.uniweld.com

Wrenches/Goggles/Tip Cleaners



Accessories

FOR U.S. JOBS
UNIWELED EMPLOYS OVER 300 WORKERS

Complete selection of combination wrenches for most fittings and connections.



4 Parts & Accessories

Wrenches

| Part# | UPC# | Description |
|-------|-------|---|
| W05 | 43408 | Tank key with security chain, fits B and MC tanks |
| W06 | 43409 | 6 way wrench for torches, cylinders and hose connections |
| W10X | 43411 | 10 way wrench for torches, cylinders and hose connections |
| W94 | 43410 | B & MC combination wrench for cylinders, torches and "A" size hose nuts |

Welding Goggles featuring flip-up #5 tinted lenses and molded-in air vents.



Goggles

| Part# | UPC# | Description |
|-------|-------|---|
| WG53 | 43402 | Welding Goggles [type to wear with glasses] |

Aluminum case with tip cleaning data stamped on back. Rust-proof, stainless steel, roll-formed spiral wires. Exclusive LOCK-IN-KNOT on small wires. Tapered pilot ends will not damage tip orifices. A hardened steel file is included. The longer spirals clean a larger number of tip styles.

Tip Cleaners

| Part# | UPC# | Description |
|-------|-------|--|
| TCSD | 26060 | Standard sizes 75-49 |
| TCJD | 26062 | Jumbo sizes 48-30 |
| TCMD | 26064 | Master sizes 75-30 |
| TCPD | 26061 | Propane sizes 67-49, plus 3 blades for spline cleaning |
| TCLD | 26063 | Xtra Long sizes 75-49 |

Part#s with D denote hanging display packaging



EXCLUSIVE LOCK-IN-KNOT ON SMALL WIRES



Flint Lighters/Tool Box



Accessories

FOR U.S. JOBS
UNIWELED EMPLOYS OVER 300 WORKERS

The Uniweld line of accessories shown here and on pages 44 and 45, includes all the "extras" you'll need to work better, faster and safer.



FL34



FL3437



FL35



FL3437TC



FL34D



FL36



FL37



Use Uniweld Flint Lighters to ignite your flame torches. Two styles available. Flint Renewals for both styles in stock.



4 Parts & Accessories

| | Part# | UPC# | Description |
|----------------|----------|-------|---|
| Flint Lighters | FL34 | 43404 | Flint lighter [boxed: 10 units] |
| | FL34D | 43437 | Flint lighter on display card |
| | FL3437 | 43403 | Flint lighter with 5 flint renewals on card |
| | FL3437TC | 43419 | Tip cleaner set and flint lighter with 5 flint renewals |
| | FL35 | 43406 | Triple flint lighter on display card |
| | FL36 | 43407 | One 3 flint renewal unit for FL35 lighter |
| | FL37 | 43405 | 5 Flint renewal unit for FL34 lighter |
| Tool Box | CC61 | 43413 | Plastic tool box 12.5" Long x 7" Wide x 5" Deep |



Uniweld Products, Inc. Fort Lauderdale, FL 33312 U.S.A. Customer Service: 800.323.2111
info@uniweld.com • www.uniweld.com



Flashback Arrestors/Check Valves/Fittings



Accessories

FOR U.S. JOBS
UNIWELD EMPLOYS OVER 300 WORKERS

Flashback Arrestors quench backfire and flashback at the torch or regulator. Uniweld's Flashback Arrestors also have built-in check valves to prevent reverse flow of gases. They are color coded: Green [Oxygen]; Red [Fuel Gas] and are available for torches and regulators.



RFAB



TFAA



TFAB

FILTERED

3/8" - 24 "A" Fitting

FILTERED

9/16" - 18 "B" Fitting*

| Flashback Arrestors | Regulator | | Torch | | Regulator | | Torch | |
|---------------------------------------|-----------|-------|---------|-------|-----------|-------|--------|-------|
| | Part# | UPC# | Part# | UPC# | Part# | UPC# | Part# | UPC# |
| Single Oxygen | RFAM100 | 10211 | TFAM100 | 04061 | RFA100 | 10206 | TFA100 | 04056 |
| Single Fuel | RFAM101 | 10212 | TFAM101 | 04062 | RFA101 | 10207 | TFA101 | 04057 |
| Set of [2] on card [1] Oxy & [1] Fuel | RFAA | 10210 | TFAA | 04060 | RFAB | 10205 | TFAB | 04055 |

Available for torch and regulator. Flashback arrestors installed at the torch help protect the technician and at the regulator, help protect the equipment. *UL Listed

4 Parts & Accessories

Check Valves



RVCB

Check Valves provide protection against reverse flow of gases, but not flame flashback. Uniweld's Check Valves conform to OSHA safety standards, [*UL Listed]. They're easy to install, test and service. Color coded: Green [Oxygen]; Red [Fuel Gas].

3/8" - 24 "A" Fitting

9/16" - 18 "B" Fitting*

| Check Valves | Torch | | Regulator | | Torch | |
|---------------------------------------|-------|-------|-----------|-------|--------|-------|
| | Part# | UPC# | Part# | UPC# | Part# | UPC# |
| Single Oxygen | TCV10 | 02651 | RCV100 | 10201 | TCV100 | 04051 |
| Single Fuel | TCV11 | 02652 | RCV101 | 10202 | TCV101 | 04052 |
| Set of [2] on card [1] Oxy & [1] Fuel | TCVA | 02650 | RCVB | 10200 | TCVB | 04050 |

Check valves should be tested regularly for leakage and flow. Check valves on regulators give best service life. ** For "A" outlet regulators, use adaptor F58R or F58L [see page 39] to connect "B" size regulator check valves on small portable outfits. *UL Listed

Swiv-it™ Fittings



HCC38

Swiv-it Fittings

| Part# | UPC# | Description |
|---------|-------|----------------------------|
| HCC38 | 43338 | 3/8" - 24, A-LH, Fuel Gas |
| HCC38-0 | 43339 | 3/8" - 24, A-RH, Oxygen |
| HCC39 | 43340 | 9/16" - 18, B-LH, Fuel Gas |
| HCC39-0 | 43341 | 9/16" - 18, B-RH, Oxygen |

- Prevent hose kinks and wrist strain
- Straight pull will uncoil the hoses
- 180° movement on twin hose
- Prevent loosening of hose fittings
- 360° movement on all single hoses
- Pressure tested
- Use on torch or regulator



360° Swivel



Heat Sink Paste/Flame Barrier/Heat Guard



Accessories

FOR U.S. JOBS
UNIWELD EMPLOYS OVER 300 WORKERS

Cool Blue™ Heat Sink Paste protects the rubber and plastic seals in ball valves, solenoid valves, reversing valves and heat sensitive materials. To prevent overheating, a heat transfer cool indicator has been added. As the paste absorbs heat, it changes to a dark blue. Safe to use, non-toxic, harmless to skin and odorless. Easy to clean: wipe with cloth or wash with water.



91861

| Part# | UPC# | Description |
|------------------|-------------|---|
| Cool Blue | 91861 91861 | Cool Blue™ Heat Sink Paste [Shipped in units of 12 only] |

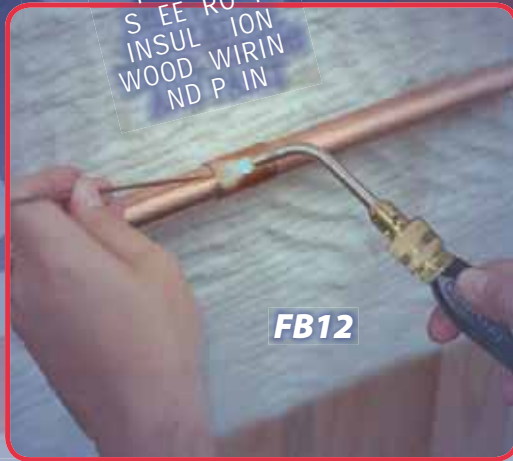
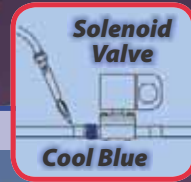
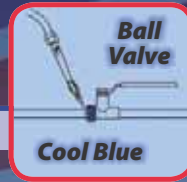

FB12

Flame Barrier

A fire resistant material that provides a protective barrier between flammable surfaces and open flames when soldering and brazing. Prevent costly fire damage to wood surfaces, wiring, sheetrock, paint and other surfaces. Flame Barrier will keep its structural integrity up to 2700°F with a melting temperature of 3200°F.

| Part# | UPC# | Description |
|----------------------|------------|-------------------------|
| Flame Barrier | FB12 43230 | Flame Barrier 12" x 12" |



HG-4

Heat Guard

A double layer of stainless steel creates an air gap that guards the surrounding work area against fire damage. The Heat Guard wraps around the pipe, increasing the heat concentration, even in windy conditions. The Heat Guard clips onto the following Uniweld tips: UT4, UT5, UT6, HT44, A11, AS11, T-4, TS-4, LPT4, LPTQ4.

| Part# | UPC# | Description |
|-------------------|-----------|------------------|
| Heat Guard | HG4 43015 | Steel Heat Guard |



4 Parts & Accessories



Uniweld Products, Inc. Fort Lauderdale, FL 33312 U.S.A. Customer Service: 800.323.2111
info@uniweld.com • www.uniweld.com

45

Residential/Commercial



Vacuum Pumps

HUMM-VAC®

FOR U.S. JOBS
UNIWELD EMPLOYS OVER 300 WORKERS

The Uniweld exclusive HUMM-VAC® Pumps remove moisture and dehydrate a system quickly and efficiently. The all-metal, heavy duty chassis; powerful, quiet running dual voltage motor; lighter weight and ergonomically designed features make these pumps the #1 choice to go to work with you.



Pump Specifications

HVP6

HVP8

HVP12

| | HVP6 | HVP8 | HVP12 |
|-----------------------------|--|---|---|
| Free Air Displacement | 6.0 CFM, 170 liter/min | 8.0 CFM, 226 liter/min. | 12.0 CFM 340 liter/min. |
| Number of Stages | 2-Stage Rotary Vane | 2-Stage Rotary Vane | 2-Stage Rotary Vane |
| Factory Micron Rating | 15 Microns | 15 Microns | 15 Microns |
| 3-Way Intake Fittings | 1/4" & 3/8" Male Flare; 1/2" Acme | 1/4", 3/8" & 1/2" Male Flare | 1/4", 3/8" & 1/2" Male Flare |
| Thermal Overload Protection | 1/2 HP | 3/4 HP | 3/4 HP |
| Voltage | 110/220V - 50/60Hz | 110/220V - 50/60Hz | 110/220V - 50/60Hz |
| Oil Capacity | 1 Quart [946ml] | 31.3 Ounces [925 ml] | 27.7 Ounces [820 ml] |
| Power Cord* | 72" [1.83m], U.S. -Type B Plug | 72" [1.83m], U.S. -Type B Plug | 72" [1.83m], U.S. -Type B Plug |
| Dimensions | 14.50" x 6.875" x 10.75" 36.83 cm x 17.46 cm x 27.30 cm | 15.0" x 6.875" x 10.75" 38.1 cm x 17.46 cm x 27.3 cm | 15.0" x 6.875" x 10.75" 38.1 cm x 17.46 cm x 27.3 cm |
| Weight | 26 lbs. [11.80 kg] | 34 lbs. [15.42 kg] | 35 lbs. [15.88 kg] |
| Shipping Weight | 30 lbs. [13.60 kg] | 38 lbs. [17.24 kg] | 39 lbs. [17.70 kg] |
| Color | Yellow | Red | Black |

5 HVAC/R TOOLS

HUMM-VAC®
Pumps

*Optional
Int'l Power
Cord Available
on request

46



Uniweld Products, Inc. Fort Lauderdale, FL 33312 U.S.A. Customer Service: 800.323.2111
info@uniweld.com • www.uniweld.com

5.5 CFM/1.5 CFM



Vacuum Pumps

FOR U.S. JOBS
UNIWELD EMPLOYS OVER 300 WORKERS

Uniweld's high-performance UVP5 Vacuum Pump has been designed and engineered to provide you with reliable service and the latest in vacuum pump technology. The UVP5 (5.5CFM) pump is built for deep vacuum service on automotive, residential and commercial A/C systems using CFC, HCFC, and HFC refrigerants in conjunction with mineral oil, ester oil, alkybenzene oil and PAG oil as lubricants.



WIDE MOUTH OIL PORT and PUMP EXHAUST

LARGE CAPACITY OIL RESERVOIR

LARGE SIGHT GLASS FOR EASY OIL MONITORING

EASY ACCESS OIL DRAIN



CENTERED MOUNTED HANDLE FOR BALANCE

DUAL INTAKE FITTING: 1/4" and 3/8" MALE FLARE WITH TETHERED CAPS

POWERFUL LOW DECIBEL FAN COOLED MOTOR

HEAT DISPERSING MOTOR FINS

WIDE STABLE BASE WITH RUBBER FEET FOR DURABILITY and VIBRATION CONTROL



UVP5

| Part# | Free Air Displacement | | Number of Stages | Factory Micron Rating | Intake Fittings [SAE] | Motor H.P. | Motor RPM | Voltage | Power Cord 72" [1.83m] Plug Type | Oil Capacity | Dimensions Inches [cm] | | | Weight Lbs. [Kg] | |
|-----------------|-----------------------|-------|------------------|-----------------------|--------------------------|------------|-----------|-----------|----------------------------------|--------------------|------------------------|-----|------|------------------|-------|
| | CFM | L/Min | | | | | | | | | L | W | H | Net | Shi |
| UVP5 | 5.5 | 155 | 2 | 15 | 1/4" and 3/8" Male Flare | 1/2 | 3440 | 115V 60Hz | U.S. -Type B | 15.22 Oz. [450 ml] | 13.9 | 5.5 | 10.2 | 22.05 | 25.20 |
| UVP5-220 | 4.66 | 132 | 2 | 15 | 1/4" and 3/8" Male Flare | 1/2 | 2880 | 220V 50Hz | Europe -Type F | 15.22 Oz. [450 ml] | 13.9 | 5.5 | 10.2 | 22.05 | 25.20 |

Ductless Mini-Split 1.5 CFM Vacuum Pump

The UVP1.5 (1.5CFM) pump is built for deep vacuum service on Ductless Mini-Splits and Automotive A/C Systems. A reliable mini-pump providing the latest in vacuum pump technology.



UVP1.5

| Part# | Free Air Displacement | | Number of Stages | Factory Micron Rating | Intake Fittings [SAE] | Motor H.P. | Voltage | Power Cord 72" [1.83m] Plug Type | Oil Capacity | Dimensions Inches [cm] | | | Weight Lbs. [Kg] | |
|-------------------|-----------------------|-------|------------------|-----------------------|-------------------------------|------------|--------------|----------------------------------|------------------|------------------------|-----|-----|------------------|-----|
| | CFM | L/Min | | | | | | | | L | W | H | Net | Shi |
| UVP1.5-110 | 1.43 | 40.5 | 2 | 38 | 1/4" Male Flare and 1/2" Acme | 1/4 | 110V 50/60Hz | U.S. -Type B | 4.7 Oz. [140 ml] | 10.23 | 3.5 | 6.4 | 10 | 14 |
| UVP1.5-220 | 1.43 | 40.5 | 2 | 38 | 1/4" Male Flare and 1/2" Acme | 1/4 | 220V 50/60Hz | Europe -Type F | 4.7 Oz. [140 ml] | 10.23 | 3.5 | 6.4 | 10 | 14 |



Uniweld Products, Inc. Fort Lauderdale, FL 33312 U.S.A. Customer Service: 800.323.2111
info@uniweld.com • www.uniweld.com



5 HVAC/R Tools

Replacement Parts for HVP6, HVP8, HVP12, UVP5 and UVP1.5



Vacuum Pumps

FOR U.S. JOBS
UNIWELD EMPLOYS OVER 300 WORKERS



| Ref# | Part# | Description |
|------|-------|---|
| 1 | 42250 | Exhaust Dome with O-Ring for UVP1.5 & UVP5 [Thread Conn. M27 x 1.5] |
| 2 | 42251 | Exhaust Dome with O-Ring for HVP6, HVP8 & HVP12 [Thread Conn. M27 x 1.5] |
| 3 | 42252 | Oil Drain Fitting with O-Ring for HVP6, HVP8 & HVP12 |
| 4 | 42253 | Gas Ballast with O-Ring for HVP6, HVP8 & HVP12 |
| 5A | 42277 | Intake Fit. [1/4" X 1/2" Acme X 3/8"] w/Tethered Caps for HVP6 |
| 5B | 42278 | Intake Fit. [1/4" X 3/8" X 1/2"] w/Tethered Caps for HVP8 & HVP12 |
| 6 | 42257 | Chassis Base with Bolt [Set of Two] HVP6 |
| 6 | 42258 | Chassis Base with Bolt [Set of Two] HVP8 |
| 6 | 42259 | Chassis Base with Bolt [Set of Two] HVP12 |
| 7 | 42260 | Base Rubber Feet with Bolt and Washer [set of two] for HVP6, HVP8 & HVP12 |
| 8 | 42261 | Electrical On/Off Rocker Switch for HVP6, HVP8 & HVP12 |
| 9 | 42262 | Voltage Slide Switch for HVP6, HVP8 & HVP12 |
| 10 | 42263 | Power Box Outlet for HVP6, HVP8 & HVP12 |
| 11 | 42264 | 6' Power Cord (U.S.-Type B Plug) for HVP6, HVP8 & HVP12 |
| 12 | 42265 | Handle w/Rubber Grip + [4 bolts] HVP6 |
| 12 | 42266 | Handle w/Rubber Grip + [4 bolts] HVP8 |
| 12 | 42267 | Handle w/Rubber Grip + [4 bolts] HVP12 |

| Ref# | Part# | Description |
|------|-------|--|
| 13 | 42274 | Oil Reservoir w/Slight Glass + [4bolts] HVP6 |
| 13 | 42275 | Oil Reservoir w/Slight Glass + [4bolts] HVP8 |
| 13 | 42276 | Oil Reservoir w/Sight Glass + [4 bolts] HVP12 |
| 14 | 42280 | Oil Reservoir w/Sight Glass + [4 bolts] UVP5 |
| 15A | 42281 | Intake Fittings [1/4" & 3/8"] w/Tethered Caps, Ball, Snap Rings & Filter for UVP5 |
| 15B | VP87 | Intake Fittings [1/4" & 1/2" ACME] w/Tethered Caps for UVP1.5 |
| 16 | 42282 | Oil Drain Fitting with O-Ring for UVP5 & UVP1.5 |
| 17 | 42283 | Platform Base with Rubber Feet for UVP5 |
| 18 | 42284 | Handle for UVP5 |
| 19A | 42285 | Electrical On/Off Rocker Switch for UVP5 |
| 19B | VP86 | Electrical On/Off Rocker Switch for UVP1.5 |
| 20 | 42286 | Metal Fan Cover for UVP5 |
| 21A | 42288 | 6' Power Cord (U.S. - Type B Plug) for UVP5 & UVP1.5 |
| 22B | 42289 | 6' Power Cord (EUROPE - Type F Plug) for UVP5 & UVP1.5-220 |
| 23 | 42268 | Black Plastic Power Box for HVP6, HVP8 & HVP12 |
| 24 | 42269 | Black Plastic Power Box for UVP5 |
| 25 | 42313 | Motor Start Capacitor for UVP5, HVP6, HVP8 & HVP12 |

Humm-Vac Repair Kits

HVP6RK Kit Includes: (2) Back Rotary Vane (17x23), (2) Front Rotary Vane (28x23), (4) Rotary Vane Spring, (1) Trap Intake O-Ring, Red, (1) Trestle Trap O-Ring, (1) Shaft Seal, (1) Oil Reservoir O-Ring, (2) Exhaust Valve

HVP8RK Kit Includes: (2) Back Rotary Vane (17x26), (2) Front Rotary Vane (30x26), (4) Rotary Vane Spring, (1) Trap Intake O-Ring, Red, (1) Trap Intake O-Ring, Black, (1) Trestle Trap O-Ring, (1) Shaft Seal, (1) Oil Reservoir O-Ring, (3) Exhaust Valve

HVP12RK Kit Includes: (2) Back Rotary Vane (17x26), (2) Front Rotary Vane (40x26), (4) Rotary Vane Spring, (1) Trap Intake O-Ring, Red, (1) Trap Intake O-Ring, Black, (1) Trestle Trap O-Ring, (1) Shaft Seal, (1) Oil Reservoir O-Ring, (3) Exhaust Valve

Vacuum Pump Oil

Uniweld's Vacuum Pump Oil is refined with excellent thermal stability for maximum efficiency in any vacuum pump. For maximum pump performance, it is recommended that the oil be changed after every evacuation. Severely hydrotreated paraffinic ISO Viscosity Grade 46.



| Part# | Description | Part# | Description |
|-----------------------|------------------|-------|-------------------|
| Vacuum Pump Oil 42005 | 1 Quart [946 ml] | 42006 | 1 Gallon [3.78 L] |

48



Uniweld Products, Inc. Fort Lauderdale, FL 33312 U.S.A. Customer Service: 800.323.2111
info@uniweld.com • www.uniweld.com

A/C & R System Evacuation



MaxEvac Kit and Valve Core Removal

FOR U.S. JOBS
UNIWELED EMPLOYS OVER 300 WORKERS

The MaxEvac Kit creates a closed system with unrestricted flow for fast, efficient evacuation of an A/C & R system. This kit includes two Valve Core Removal Tools used to remove the access-fitting valve core for unrestricted evacuation and also to isolate the micron gauge to accurately check the system for vacuum. Compatible with all refrigerants, including R-410A.

MaxEvac Kit



| Part# | Description |
|----------|---|
| 92822 | MaxEvac Kit Includes One of Each: 92825, 92838, H06A404A |
| 92869 | R-410A Mini Split MaxEvac Kit Includes One of Each: 92867, 92868 and H06A404A |
| H06A404A | 6" Micron Gauge Vacuum Service Hose, 1/4" F.F. X L45, Black |

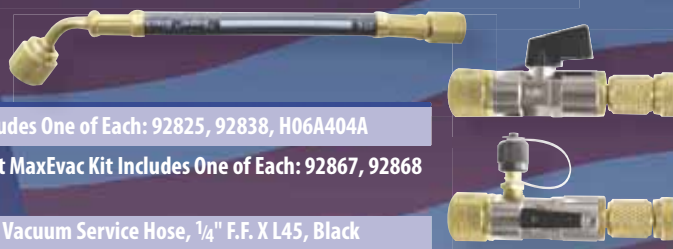

Valve Core Removal

Remove and replace valve cores without losing the system's refrigerant charge using Uniweld's Valve Core Removal Tool. Now you can temporarily remove valve cores for unrestricted line flow, providing faster recovery, evacuation and recharge of a system. The 3/8" full flow ball valve, with positive 1/4 turn on/off, swivels 360° for easy access to the system service valves. Attach and isolate a micron gauge at the system using the Valve Core Removal Tool with 1/4" side port adaptor. Compatible with all refrigerants, including R-410A.



Valve Core Removal Tool with Extractor Rod



Valve Core Removal Tool with Extractor Rod and 1/4" Side Port Fitting

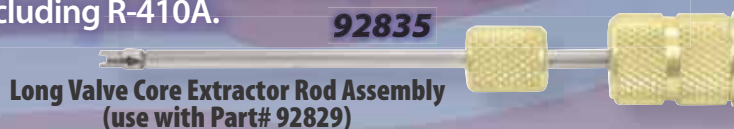

Long Valve Core Extractor Rod Assembly (use with Part# 92829)



Valve Core Extractor Rod Assembly

| Part# | Description |
|-------|--|
| 92825 | Valve Core Removal Tool [1/4"] |
| 92829 | R-134a Automotive Adaptors, 1 each [High Side and Low Side] |
| 92832 | R-134a Automotive Valve Core Removal Tool Kit includes one of each: 92825, 92829 and 92835 |
| 92835 | Long Valve Core Extractor Rod Assembly with Storage Compartment |
| 92838 | Valve Core Removal Tool with 1/4" Side Port Fitting |
| 92867 | R-410A Mini Split 5/16" Valve Core Removal Tool |
| 92868 | R-410A Mini Split 5/16" Valve Core Removal Tool with 1/4" Side Port Fitting |



R-134a Automotive Adaptors (requires Part# 92835)



Uniweld Products, Inc. Fort Lauderdale, FL 33312 U.S.A. Customer Service: 800.323.2111
info@uniweld.com • www.uniweld.com

49

5 HVAC/R Tools

Electronic Refrigerant Scale



ChargeTron®

FOR U.S. JOBS
UNIWELD EMPLOYS OVER 300 WORKERS

Now you can accurately weigh and transfer refrigerant to and from the A/C system. You will be working with a compact, battery powered, portable (7.2 lbs) workstation that has the cast aluminum scale built right into its high impact plastic carrying case. The optional charging module plugs into the scale to automatically transfer a preset amount of refrigerant.

LCD DISPLAYS
POUNDS/OUNCES OR
KILOGRAMS/GRAMS

OPTIONAL CHARGING MODULE



PART #53651 HAS
ADDITIONAL 120V AC
POWER OUTLET



53650

5 HVAC/R TOOLS

| | |
|-------------------------------|---|
| Tare Weight: | Zeros out scale at any time. |
| Power: | 9 Volt Alkaline Battery. Auto power off: after 15 minutes of operation without any change in weight, scale turns off. Approximately 48 hours battery life. Optional A/C Power Adaptor. |
| Two Weight Capacities: | 110 lbs. [50 Kg] or 176 lbs. [80 Kg] |
| Accuracy: | At 110 lbs./50 Kg Capacity: ± 0.2 oz./10g • At 176 lbs./80 Kg Capacity: ± 0.5 oz./20g |
| Weight: | 7.2 lbs. [3.26 Kg] |
| Dimensions: | 15" X 13" X 3 ³ / ₈ " [38cm x 28cm x 8.5cm] |
| Operating Temperature: | 32 °F to 120 °F [0 °C to 50 °C] |
| Case: | Rugged Plastic Carrying Case with a built-in handle. |
| Platform Size: | 9" X 9" [23cm x 23cm] Ribbed Rubber Mat. |
| Optional Accessories: | <p>Part# 53651 Automatic Charging Module. Compatible with all refrigerants including R-410A. Maximum working pressure: 300 psi.</p> <p>Part# 53654 Automatic Charging Module. 220V model [no additional power outlet] Compatible with all refrigerants, including R-410A. Maximum working pressure: 300 psi</p> <p>Part# 53652 120V AC Power Adapter connects to ChargeTron® Refrigerant Scale.</p> |

50



Uniweld Products, Inc. Fort Lauderdale, FL 33312 U.S.A. Customer Service: 800.323.2111
info@uniweld.com • www.uniweld.com

Visible Vapor Charging Device



Vapor-Vue®

FOR U.S. JOBS
UNIWELD EMPLOYS OVER 300 WORKERS

Absorbs heat naturally and flashes the liquid refrigerant from the cylinder and charges into the system as a vapor. Connecting the Vapor-Vue® to the low side of your charging manifold will increase the charging rate up to 8 times faster and the liquid is controlled by adjusting the manifold valve and monitoring the vapor rate through the double sight glass. Vapor-Vue® is factory pressure tested at 800 psi and can be used to charge any refrigeration & air conditioning system using R-410A, CFC, HCFC & HFC; Zeotropic and Azeotropic refrigerants without the danger of liquid slugging and damaging the compressor. Placing the manifold & Vapor-Vue® over hot discharge airflow of the condensing unit will increase the heat exchange and charging rate efficiency. Patent Pending.



VV1

| Part# | Description |
|-------|---|
| VV1 | Vapor-Vue with 1/4" Flare Fittings - HVAC/R |

Liquid Refrigerant to Vapor



Reseatable Pressure Relief Valve
Patent# 8,181,665

1/4" Male Flare

A/C Flush Kit

The A/C Flush Kit is ideal for system flushing after compressor burnouts and will remove contaminants, moisture and acid from the evaporator and condenser. It is also used during retrofits and flushing R-22 line sets for R-410A conversions. The R-22 mineral oil based system is not compatible with the R-410A ester oil based system.

Special design features include:

- Pressure Relief Valve that opens at 180 to 190 PSI to protect the cylinder and equipment from overpressure.
- Blowgun with rubber tip nozzle for copper tubing 3/8" to 1 1/8" O.D.
- Reusable canister holds up to 18 oz.

| Part# | Description |
|--------|--|
| 94184 | A/C System Flush Kit |
| H2SSM | 24" Service Hose |
| FG24A | A/C Rubber Tip Nozzle with 1/8" M.P.T. Fitting |
| BG1ACA | Blowgun with A/C Rubber Tip Nozzle |

94184

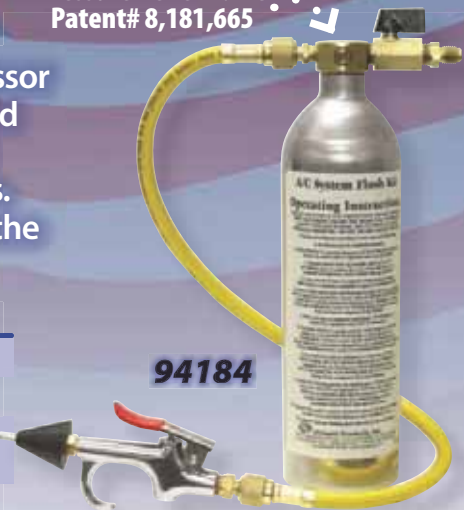

Automotive A/C Flush Kit also available (see page 70)

Actuating Valve

For use on disposable flush solvent cylinders with 1/2"-16 Acme connection. Safety Check valve built in the 1/4" M.F. outlet connection prevents pressurizing the disposable cylinder.



AV25H



Uniweld Products, Inc. Fort Lauderdale, FL 33312 U.S.A. Customer Service: 800.323.2111
info@uniweld.com • www.uniweld.com

51

2 Valve Aluminum Manifold with 3 1/8" NPF® Gauges



SPIRIT™ R-410A/R-22/R-404A/R-134a Manifold

FOR U.S. JOBS
UNIWELD EMPLOYS OVER 300 WORKERS

COLOR CODED
U E O O S



R-410A/R-22
R-404A/R-134a
3 1/8" Replacement
Gauges
#G429ND Red,
Pressure
#G430ND Blue,
Compound

USAM

The all new SPIRIT MANIFOLD! designed and built right here in the U.S.A., proudly emphasizes the quality and the superior workmanship that signifies American Made. Lightweight extruded aluminum body and easy-grip handles for positive control; double O-ring piston valve for long reliable service; easy access front hose holders; large easy-to-read 3 1/8" steel case NPF™ gauges with color-coded protective boots; 5' High Pressure Soft Magic® Barrier Hose set with optional EZ-Turn anti-blowback or ball valve fittings.

5 HVAC/R Tools



| Part# | UPC# | Description |
|-----------------|-------|--|
| USAM | 49200 | 2-Valve Aluminum Manifold [No Hoses] |
| USAM3HEZ | 49211 | 2-Valve Aluminum Manifold with 3ft. EZ-Turn Anti-Blowback Hose Set |
| USAM5HEZ | 49212 | 2-Valve Aluminum Manifold with 5ft. EZ-Turn Anti-Blowback Hose Set |
| USAM6HEZ | 49213 | 2-Valve Aluminum Manifold with 6ft. EZ-Turn Anti-Blowback Hose Set |
| USAM3HBV | 49271 | 2-Valve Aluminum Manifold with 3ft. Ball Valve Hose Set |
| USAM5HBV | 49272 | 2-Valve Aluminum Manifold with 5ft. Ball Valve Hose Set |
| USAM6HBV | 49273 | 2-Valve Aluminum Manifold with 6ft. Ball Valve Hose Set |

Other pressure and temperature scales are available upon request.

52



Uniweld Products, Inc. Fort Lauderdale, FL 33312 U.S.A. Customer Service: 800.323.2111
info@uniweld.com • www.uniweld.com

4 Valve Aluminum Manifold with 3 1/8" NPF® Gauges



Man, What a Manifold®

FOR U.S. JOBS
UNIWELD EMPLOYS OVER 300 WORKERS

R-410A/R-22/R-404A/R-134a



Lens Plug
for easy
zero reset



Q4N85SMA

Q4N8

NPF®
Silicone
Dampened
Movement



Anodized aircraft aluminum block body with 4 ports for charging, evacuating and testing a system without changing or removing hoses • 3/8" SAE port increases vacuum capacity and saves time • Optical sight glass for monitoring refrigerant • Durable, brazed brass T-handles provide smooth, precise adjustments • NPF® No Pointer Flutter® 3 1/8" gauges with color coded refrigerant scales and color coded gauge boots • High Pressure Soft Magic® Barrier Hoses [available with optional EZ-Turn anti-blowback fittings]. Man, What a Manifold!



R-410A/R-22/R-404A/R-134a
Replacement Gauges 3 1/8" [80mm]
#G429ND Red, Pressure
#G430ND Blue, Compound

| Part# | UPC# | Description | R-410A/R-22/R-404A/R-134a- PSI/°F |
|----------|-------|--|-----------------------------------|
| Q4N8 | 48700 | 4-Valve Aluminum Manifold [No Hoses] | |
| Q4N85SM | 48701 | 4-Valve Aluminum Manifold with 5ft. Soft Magic® Barrier Hose Set | |
| Q4N85MEZ | 48721 | 4-Valve Aluminum Manifold with 5ft. Soft Magic® Barrier EZ-Turn Anti-Blowback Hose Set | |

Other pressure and temperature scales are available upon request.



Uniweld Products, Inc. Fort Lauderdale, FL 33312 U.S.A. Customer Service: 800.323.2111
info@uniweld.com • www.uniweld.com

53

5 HVAC/R Tools



2 Valve Brass Manifold with 3 1/8" NPF® Gauges

Man, What a Manifold®

FOR U.S. JOBS
UNIWELED EMPLOYS OVER 300 WORKERS

R-410A/R-22/R-404A/R-134a

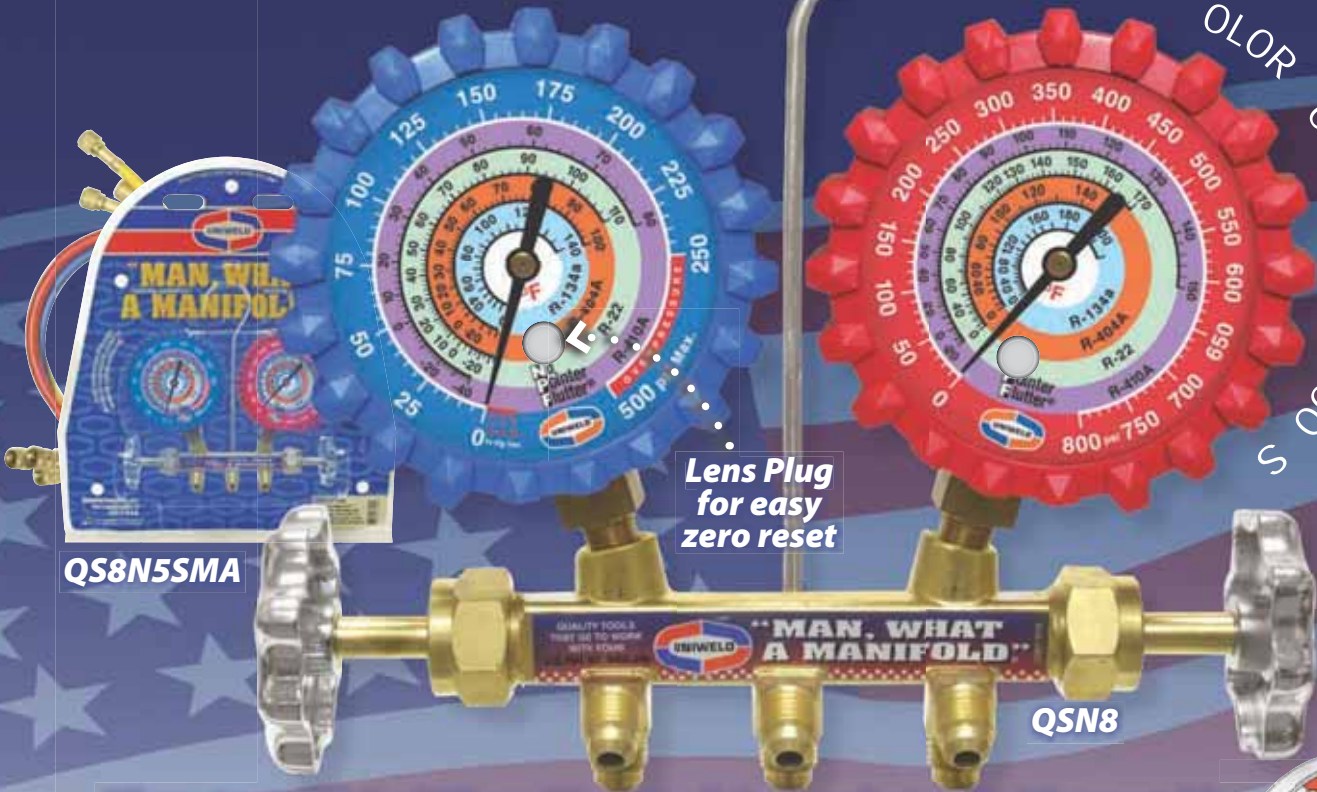

COLOR CODED
USE ONLY

Lens Plug
for easy
zero reset

QS8N5SMA

QS8

The patented Uniweld forged brass body is manufactured with reseatable Teflon® valve stem packing for durability and leakproof reliability. These user-friendly, accurate, manifolds feature:

- NPF® No Pointer Flutter® 3 1/8", easy-to-read gauges with color coded refrigerant scales and color coded gauge boots
- Metal [not plastic] hand wheels
- Extended valve stems for ample knuckle clearance
- Quick action valve assembly for 1/2 turn fully open or fully closed
- Convenient 45° front hose holders
- High Pressure Soft Magic® Barrier Hoses with EZ-Turn anti-blowback fittings. Man, What a Manifold!



5 HVAC/R TOOLS



| Part# | UPC# | Description | R-410A/R-22/R-404A/R-134a-PSI/°F |
|-----------|-------|---|----------------------------------|
| QS8N | 48600 | 2-Valve Brass Manifold [No Hoses] | |
| QS8N3SMEZ | 48671 | 2-Valve Brass Manifold with 3ft. EZ-Turn Anti-Blowback Hose Set | |
| QS8N5SMEZ | 48672 | 2-Valve Brass Manifold with 5ft. EZ-Turn Anti-Blowback Hose Set | |
| QS8N6SMEZ | 48673 | 2-Valve Brass Manifold with 6ft. EZ-Turn Anti-Blowback Hose Set | |

Other pressure and temperature scales are available upon request.
R-410A/R-22/R-404A/R-134a
Replacement Gauges 3 1/8" [80mm]
#G429ND Red, Pressure
#G430ND Blue, Compound

54



Uniweld Products, Inc. Fort Lauderdale, FL 33312 U.S.A. Customer Service: 800.323.2111
info@uniweld.com • www.uniweld.com

2 Valve Brass Manifold with 2½" LPF™ Gauges



Man, What a Manifold®

FOR U.S. JOBS
UNIWELD EMPLOYS OVER 300 WORKERS

R-410A/R-22/R-404A

COLOR CODED
USER FRIENDLY



QS4L5H



QS4L



Vapor-Vue® Charging Device connects to low side (see page 51)

The patented Uniweld forged brass body is manufactured with reseatable Teflon® valve stem packing for durability and leakproof reliability. This user-friendly, accurate, manifold features: • Limited Pointer Flutter™, easy-to-read 2½" gauges with color coded refrigerant scales and color coded gauge boots • Metal [not plastic] hand wheels • Extended valve stems for ample knuckle clearance • Quick action valve assembly for ½ turn fully open or fully closed • Convenient 45° front hose holders • High Pressure Soft Magic® Barrier Hoses (available with optional EZ-Turn anti-blowback fittings). Man, What a Manifold!

| Part# | UPC# | Description | R-410A/R-22/R-404A-PSI/°F |
|----------|-------|---|---------------------------|
| QS4L | 47500 | 2-Valve Brass Manifold [No Hoses] | |
| QS4L3H | 47501 | 2-Valve Brass Manifold with 3ft. Soft Magic® Barrier Hose Set | |
| QS4L5H | 47502 | 2-Valve Brass Manifold with 5ft. Soft Magic® Barrier Hose Set | |
| QS4L6H | 47503 | 2-Valve Brass Manifold with 6ft. Soft Magic® Barrier Hose Set | |
| QS4L3HEZ | 47411 | 2-Valve Brass Manifold with 3ft. Soft Magic® Barrier EZ-Turn Anti-Blowback Hose Set | |
| QS4L5HEZ | 47412 | 2-Valve Brass Manifold with 5ft. Soft Magic® Barrier EZ-Turn Anti-Blowback Hose Set | |
| QS4L6HEZ | 47413 | 2-Valve Brass Manifold with 6ft. Soft Magic® Barrier EZ-Turn Anti-Blowback Hose Set | |

Other pressure and temperature scales are available upon request.



R-410A/R-22/R-404A
Replacement Gauges
#G529LD Red, Pressure
#G530LD Blue, Compound



Uniweld Products, Inc. Fort Lauderdale, FL 33312 U.S.A. Customer Service: 800.323.2111
info@uniweld.com • www.uniweld.com

55

5 HVAC/R Tools



2 Valve Brass Manifold with 2 1/2" LPF™ Gauges

Man, What a Manifold®

FOR U.S. JOBS
UNIWELD EMPLOYS OVER 300 WORKERS

R-22/R-404A/R-134a



QAL5SM



QAL

The patented Uniweld forged brass body is manufactured with reseatable Teflon® valve stem packing for durability and leakproof reliability. This user-friendly, accurate, manifold features: • Limited Pointer Flutter™, easy-to-read 2 1/2" gauges with color coded refrigerant scales and color coded gauge boots • Metal [not plastic] hand wheels • Extended valve stems for ample knuckle clearance • Quick action valve assembly for 1/2 turn fully open or fully closed • Convenient 45° front hose holders • High Pressure Soft Magic® Barrier Hoses (available with optional EZ-Turn anti-blowback fittings). Man, What a Manifold!

5 HVAC/R TOOLS

| Part# | UPC# | Description | R-22/R-404A/R-134a-PSI/°F |
|----------|-------|---|---------------------------|
| QAL | 45050 | 2-V Brass Manifold [No Hoses] | |
| QAL3SM | 48001 | 2-V Brass Manifold with 3ft. Soft Magic® Hose Set | |
| QAL5SM | 48002 | 2-V Brass Manifold with 5ft. Soft Magic® Hose Set | |
| QAL6SM | 48003 | 2-V Brass Manifold with 6ft. Soft Magic® Hose Set | |
| QAL3SMEZ | 48171 | 2-V Brass Manifold with 3ft. Soft Magic® EZ-Turn Anti-Blowback Hose Set | |
| QAL5SMEZ | 48172 | 2-V Brass Manifold with 5ft. Soft Magic® EZ-Turn Anti-Blowback Hose Set | |
| QAL6SMEZ | 48173 | 2-V Brass Manifold with 6ft. Soft Magic® EZ-Turn Anti-Blowback Hose Set | |



R-22/R-404A/R-134a
Replacement Gauges
#G29LD Red, Pressure
#G30LD Blue, Compound

Other pressure and temperature scales are available upon request.

56



Uniweld Products, Inc. Fort Lauderdale, FL 33312 U.S.A. Customer Service: 800.323.2111
info@uniweld.com • www.uniweld.com

Replacement Parts for 2 Valve and 4 Valve Manifolds



Man, What a Manifold®

FOR U.S. JOBS
UNIWELD EMPLOYS OVER 300 WORKERS

2 Valve Brass Manifold Replacement Parts

QVK-2
Manifold Valve Repair Kit
[2] Teflon Washers
[2] Teflon Valve Seats

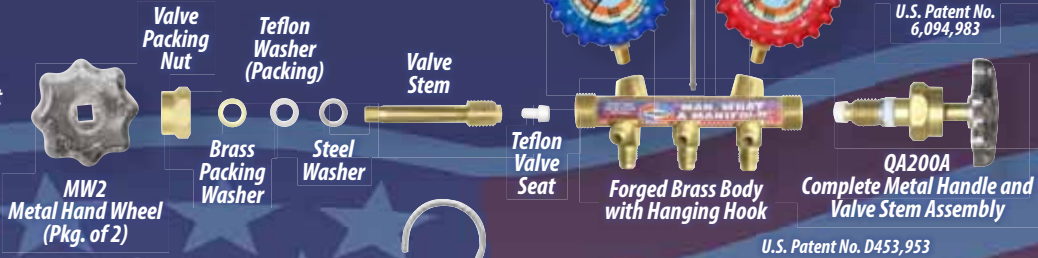

Replacement Gauges
(See pages 58-59)

U.S. Patent No.
6,094,983

U.S. Patent No. D453,953

4 Valve Aluminum Manifold Replacement Parts

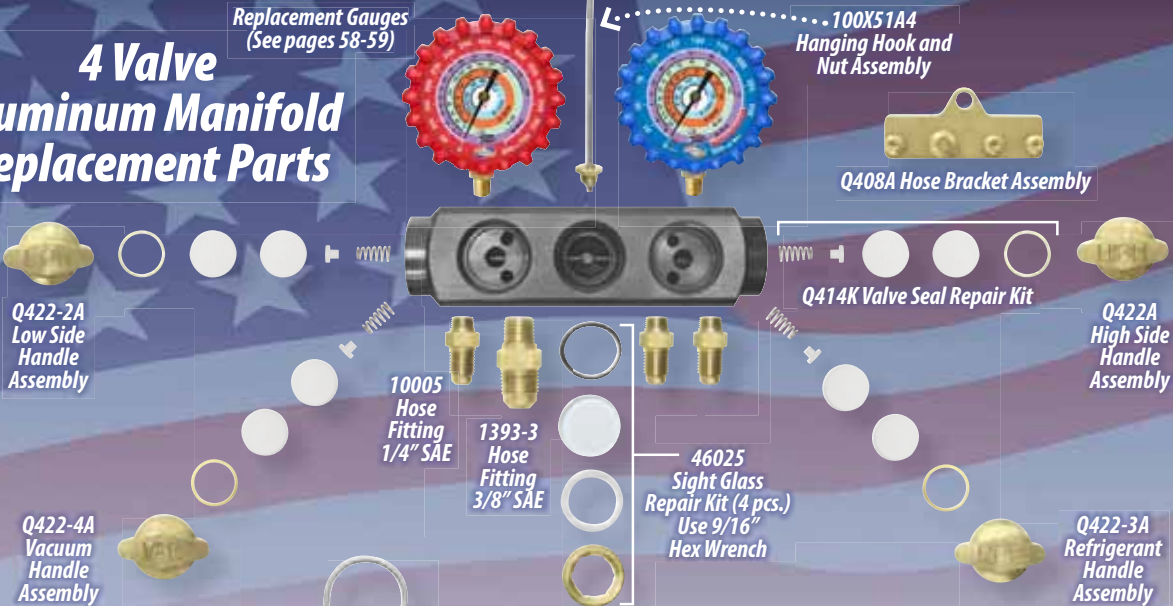

Replacement Gauges
(See pages 58-59)

100X51A4
Hanging Hook and
Nut Assembly

Q408A Hose Bracket Assembly

Q414K Valve Seal Repair Kit

Q422-2A
Low Side
Handle
Assembly

Q422A
High Side
Handle
Assembly

10005
Hose
Fitting
1/4" SAE

1393-3
Hose
Fitting
3/8" SAE

46025
Sight Glass
Repair Kit (4 pcs.)
Use 9/16" Hex Wrench

Q422-4A
Vacuum
Handle
Assembly

Q422-3A
Refrigerant
Handle
Assembly

Replacement Gauges
(See pages 58-59)

100X51A4
Hanging Hook and
Nut Assembly

2 Valve SPIRIT Manifold Replacement Parts



Extruded
Aluminum Body

SPR3K
Complete
Metal Handle
and Valve Stem
Assembly

10005
Hose
Fittings
1/4" SAE

EVX38
Retaining Ring
(Pkg. of 2)

SPR3A
Valve Stem
Assembly

Screw
Lock Washer



Uniweld Products, Inc. Fort Lauderdale, FL 33312 U.S.A. Customer Service: 800.323.2111
info@uniweld.com • www.uniweld.com



Manifold Replacement Gauges



NPF[®] Gauges

FOR U.S. JOBS
UNIWELD EMPLOYS OVER 300 WORKERS

The original NPF[®] No Pointer Flutter[®] Gauges that provide steady and accurate pressure readings. The encapsulated silicone dampened movement seldom needs recalibration. The gauge is guaranteed not to leak fluid and not to lose dampening characteristics. Scales are printed in refrigerant colors.

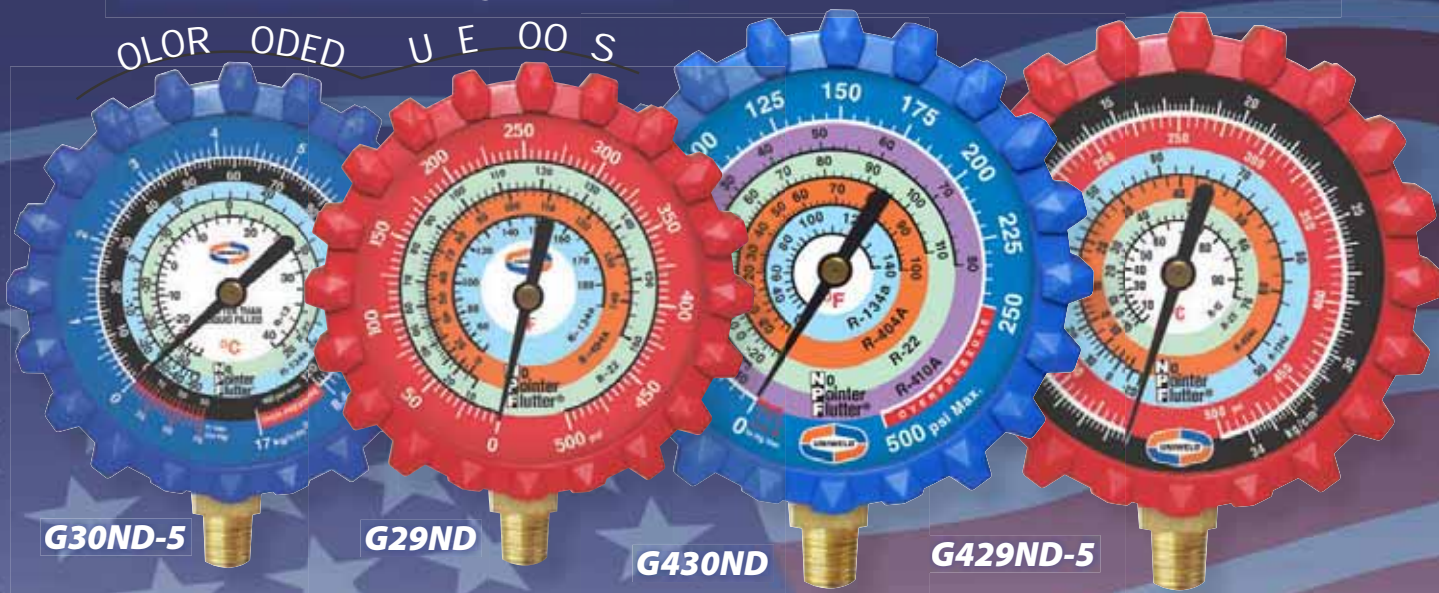

G30ND-5

G29ND

G430ND

G429ND-5



Competitor's "Vibration Free" Gauge



Uniweld's NPF[®] Gauge

| Size | Refrigerant Pressure/Temperature Scale | Color Coded Case | | Brass Case | |
|---------------|--|--------------------|---------------------|----------------------|----------------------|
| | | Red Pressure Part# | Blue Compound Part# | Pressure Part# | Compound Part# |
| 2 1/2" | R-134a/R-22/R-404A PSI °F | G29ND | G30ND | G29NBD | G30NBD |
| | R-134a/R-22/R-12 PSI-kg/cm ² -°F PSI-kg/cm ² -°C | G29ND-1 G29ND-5 | G30ND-1 G30ND-5 | G29NBD-1 G29NBD-5 | G30NBD-1 G30NBD-5 |
| | R-410A/R-22/R-404A PSI °F | G529ND | G530ND | G529NBD | G530NBD |
| 3 1/8" [80mm] | R-134a/R-12 [Automotive] PSI-°F | G409NSAD | G410NSAD | | |
| | R-410A/R-22/R-404A/R-134a PSI-°F | G429ND | G430ND | | |
| | R-134a/R-404A/R-22/R-12 PSI - kg/cm ² °C | G429ND-5 | G430ND-5 | | |



NPF[®] Silicone Dampened Movement

5 HVAC/R TOOLS



GB805

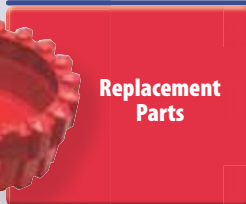

Replacement Parts

| Part# | UPC# | Description |
|-------|-------|--|
| CF25 | 51018 | 2 1/2" Clear Front Lens w/ Plug |
| CF80 | 51019 | 3 1/8" [80mm] Clear Front Lens w/ Plug |
| GB25S | 51027 | 2 1/2" Protective Gauge Boots, Pkg. [1] Red, [1] Blue |
| GB80S | 51028 | 3 1/8" [80mm] Protective Gauge Boots, Pkg. [1] Red, [1] Blue |
| PL25 | 51004 | 2 1/2" Posi-Lock Replacement Lens |

58



Uniweld Products, Inc. Fort Lauderdale, FL 33312 U.S.A. Customer Service: 800.323.2111
info@uniweld.com • www.uniweld.com

Manifold Replacement Gauges



LPF™ Gauges

FOR U.S. JOBS
UNIWELD EMPLOYS OVER 300 WORKERS

Uniweld's 2 1/2" LPF™ Limited Pointer Flutter™ Gauges with large, easy-to-read dial faces provide improved accuracy of pressure readings. Features include a high torque hair spring movement and a special pulsation dampener.

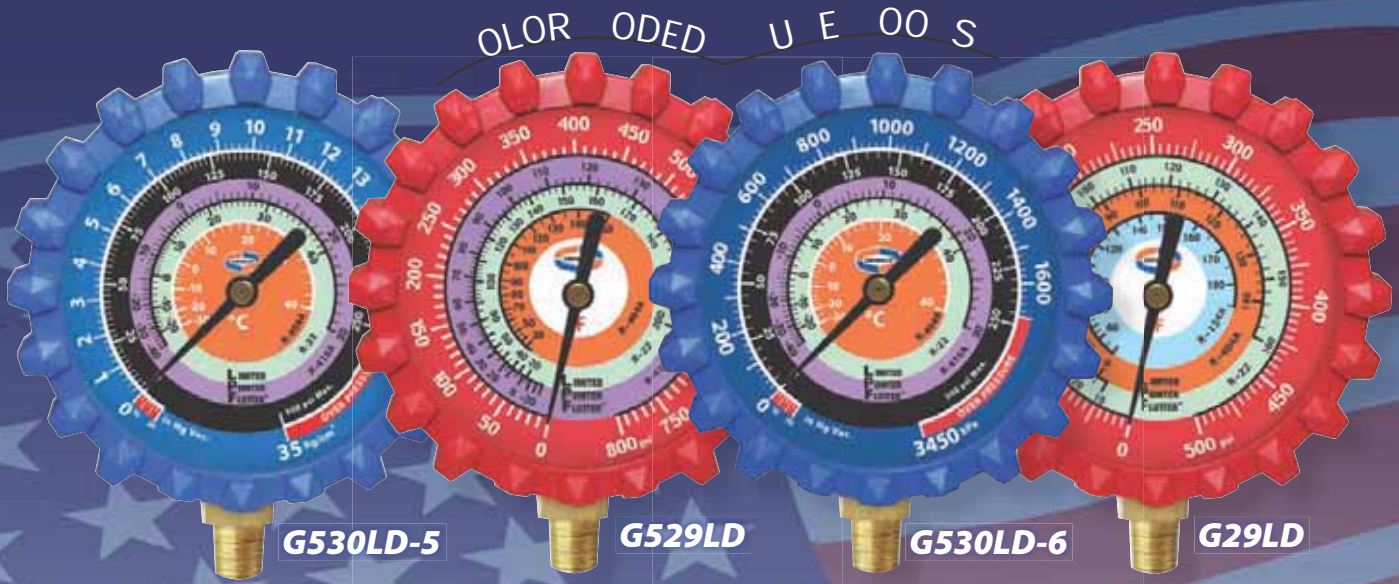

Competitor's "Vibration Free" Gauge



Uniweld's LPF™ Gauge

| Size | Refrigerant Pressure/Temperature Scale | Color Coded Case | | Brass Case | |
|--------|--|--------------------------------|--------------------------------|------------------|------------------|
| | | Red Pressure Part# | Blue Compound Part# | Pressure Part# | Compound Part# |
| 2 1/2" | R-22/R-404A/R-134a PSI °F | G29LD | G30LD | G29D | G30D |
| | R-134a /R-12/R-22 PSI-Kg/cm ² -°F PSI-Kg/cm ² -°C | G29LD-1 G29LD-5 | G30LD-1 G30LD-5 | G29D-1 G29D-5 | G30D-1 G30D-5 |
| | R-410A/R-22/R-404A PSI °F PSI-Kg/cm ² -°C PSI-kPa °C | G529LD G529LD-5 G529LD-6 | G530LD G530LD-5 G530LD-6 | G529D - | G530D - |
| | R-134a/R-12 [Automotive] PSI-°F | G9LAD | G10LAD | - | - |
| | R-134a/R-404A/R-507 PSI-Kg/cm ² -°C | G9LD-5 | G10LD-5 | - | - |



Replacement Parts

| Part# | UPC# | Description |
|-------|-------|---|
| CF25 | 51018 | 2 1/2" Clear Front Lens w/ Plug |
| GB25S | 51027 | 2 1/2" Protective Gauge Boots, Pkg. [1] Red, [1] Blue |
| PL25 | 51004 | 2 1/2" Posi-Lock Replacement Lens |

GB25S



Uniweld Products, Inc. Fort Lauderdale, FL 33312 U.S.A. Customer Service: 800.323.2111
info@uniweld.com • www.uniweld.com

59

5 HVAC/R Tools

Premium flexible barrier hose with standard fittings



Soft Magic® Barrier Hose

Rated for R-410A, CFC, HCFC
and HFC refrigerants

FOR U.S. JOBS
UNIWELD EMPLOYS OVER 300 WORKERS

**RATED FOR
R410A
*2 YEAR
WARRANTY**



Standard Fitting
(actual size)

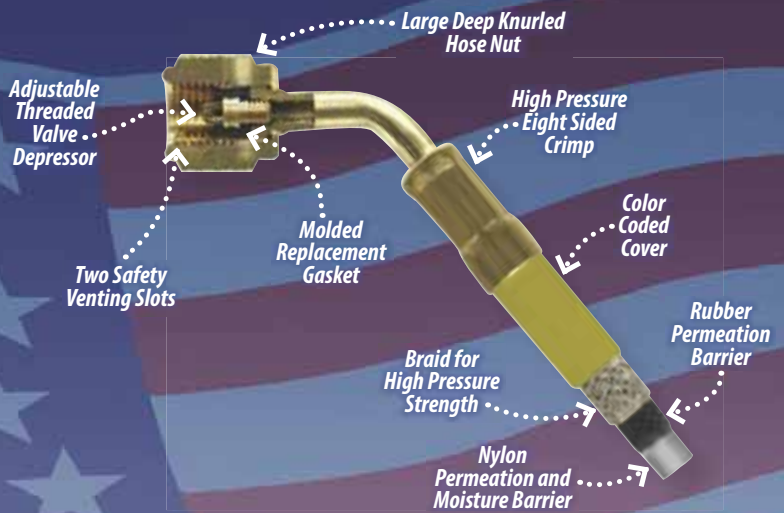

Maximum Working Pressure: 800 PSI
Burst Pressure: 4000 PSI

| Length | Red | Yellow | Blue | Hose Set 1 Each R, Y, B Part# | |
|-------------|-----------|-----------|-----------|---|--------|
| | Part# | Part# | Part# | | |
| 6" 15cm | H06SMBR | H06SMBY | H06SMBB | HC353SMB Hose Set: [2] 3 ft. hoses and [1] 5 ft. Hose | |
| 12" 30cm | H15SMBR | H15SMBY | H15SMBB | | |
| 24" 60cm | H25SMBR | H25SMBY | H25SMBB | | |
| 36" 90cm | H35SMBR | H35SMBY | H35SMBB | | HC3SMB |
| 48" 120cm | H45SMBR | H45SMBY | H45SMBB | | HC4SMB |
| 60" 150cm | H55SMBR | H55SMBY | H55SMBB | | HC5SMB |
| 72" 180cm | H65SMBR | H65SMBY | H65SMBB | HC6SMB | |
| 96" 240cm | H85SMBR | H85SMBY | H85SMBB | HDC5MB Hose Set: [3] 5 ft. 1/4" Hoses and [1] 5 ft. 3/8" Hose | |
| 25' 7.50m | H255SMBR | H255SMBY | H255SMBB | | |
| 50' 15.00m | H505SMBR | H505SMBY | H505SMBB | | |
| 100' 30.00m | H1005SMBR | H1005SMBY | H1005SMBB | | |

| Part# | Description |
|-----------|--|
| H1476 | Pkg. of (6) Gaskets and (3) Depressors |
| HX14N-10 | Pkg. of (10) Gaskets |
| HX14N-100 | Pkg. of (100) Gaskets |
| H76S-10 | Pkg. of (10) Valve Depressors |

See HVAC/R Price List for details.



92655
Soft Magic®
Barrier Hose
Display Rack
(Holds up to
50 Hoses)

5 HVAC/R TOOLS

60



Uniweld Products, Inc. Fort Lauderdale, FL 33312 U.S.A. Customer Service: 800.323.2111
info@uniweld.com • www.uniweld.com

Premium flexible barrier hose with anti-blowback fittings



Soft Magic® Barrier Hose

FOR U.S. JOBS
UNIWELD EMPLOYS OVER 300 WORKERS



EZ Turn Anti-Blowback fitting has a thrust bearing that reduces friction so the service hose can be easily connected to the access fitting while under pressure. Compact design fits in tight work spaces. Deep square knurling and textured orange and blue band for easy fingertip control!

UNDER PRESSURE



RATED FOR R-410A
*2 YEAR WARRANTY

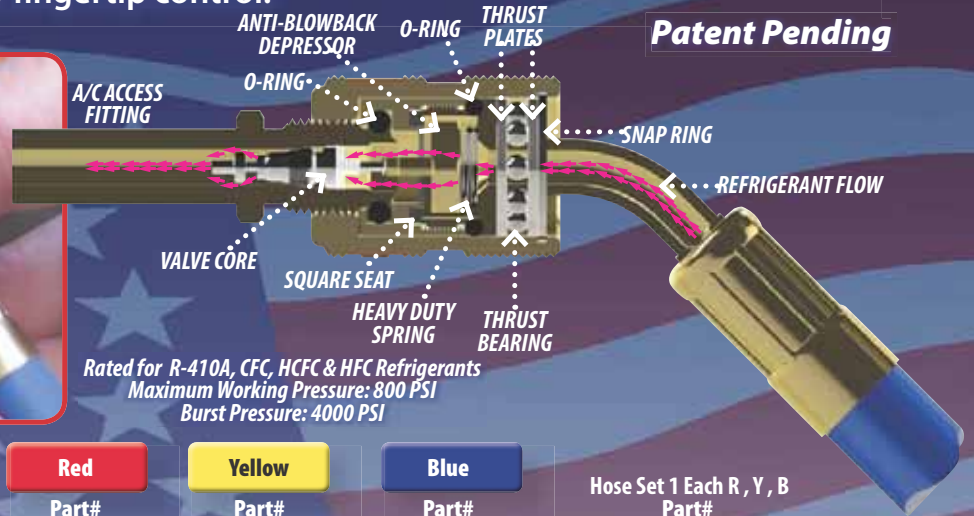

Rated for R-410A, CFC, HCFC & HFC Refrigerants
Maximum Working Pressure: 800 PSI
Burst Pressure: 4000 PSI

Patent Pending

| | Length | Red Part# | Yellow Part# | Blue Part# | Hose Set 1 Each R, Y, B Part# |
|---|------------|-----------|--------------|------------|---|
| 1/4" EZ TURN ANTI-BLOWBACK FITTING | 36" 90cm | EZ3R | EZ3Y | EZ3B | EZ3HS |
| | 60" 150cm | EZ5R | EZ5Y | EZ5B | EZ5HS |
| | 72" 180cm | EZ6R | EZ6Y | EZ6B | EZ6HS |
| | 25' 7.50m | EZ25R | EZ25Y | EZ25B | EZ5HDS Hose Set: [3] 5 ft. 1/4" Hoses and [1] 5 ft. 3/8" Hose |
| | 50' 15.00m | EZ50R | EZ50Y | EZ50B | |
| 100' 30.00m | EZ100R | EZ100Y | EZ100B | | |
| R-410A Mini Split 5/16" EZ TURN ANTI-BLOWBACK FITTING (1/4" X 5/16") | 36" 90cm | EZM3R | EZM3Y | EZM3B | |
| | 60" 150cm | EZM5R | EZM5Y | EZM5B | |
| | 72" 180cm | EZM6R | EZM6Y | EZM6B | |

EZ TURN ANTI-BLOWBACK ADAPTORS

| | Part# | Description | |
|--------------------------------|---------|--|--|
| 1/4" | EZAB | Straight 1/4" M.F. x 1/4" F.F. | |
| | EZAB90 | 90° 1/4" M.F. x 1/4" F.F. | |
| 5/16" R-410A Mini Split | EZABM | Straight 1/4" M.F. x 5/16" F.F. | |
| | EZABM90 | 90° 1/4" M.F. x 5/16" F.F. | |
| | Part# | Description | |
| Replacement Parts | EZHRK | Pkg. of (1) Spring - (1) Anti-Blowback Depressor (1) Square Seat - (2) O-Rings (1) Hose Gasket | |



EZHR EZ TURN Hose Display Rack (Holds up to 50 Hoses)

5 HVAC/R Tools



Uniweild Products, Inc. Fort Lauderdale, FL 33312 U.S.A. Customer Service: 800.323.2111
info@uniweild.com • www.uniweild.com

61

Premium flexible barrier Ball Valve hose



Soft Magic® Barrier Hose

FOR U.S. JOBS
UNIWELD EMPLOYS OVER 300 WORKERS

The Soft Magic® Barrier Ball Valve Hose has our universal ball valve with patented interchangeable service connectors and flex service hoses that connect easily to that hard-to-reach access fitting. Easy-snap-in service connectors available: straight, 45° bend, 90° bend or a 6" service hose. Maximum working pressure is 800 PSI with a burst pressure of 4000 PSI.

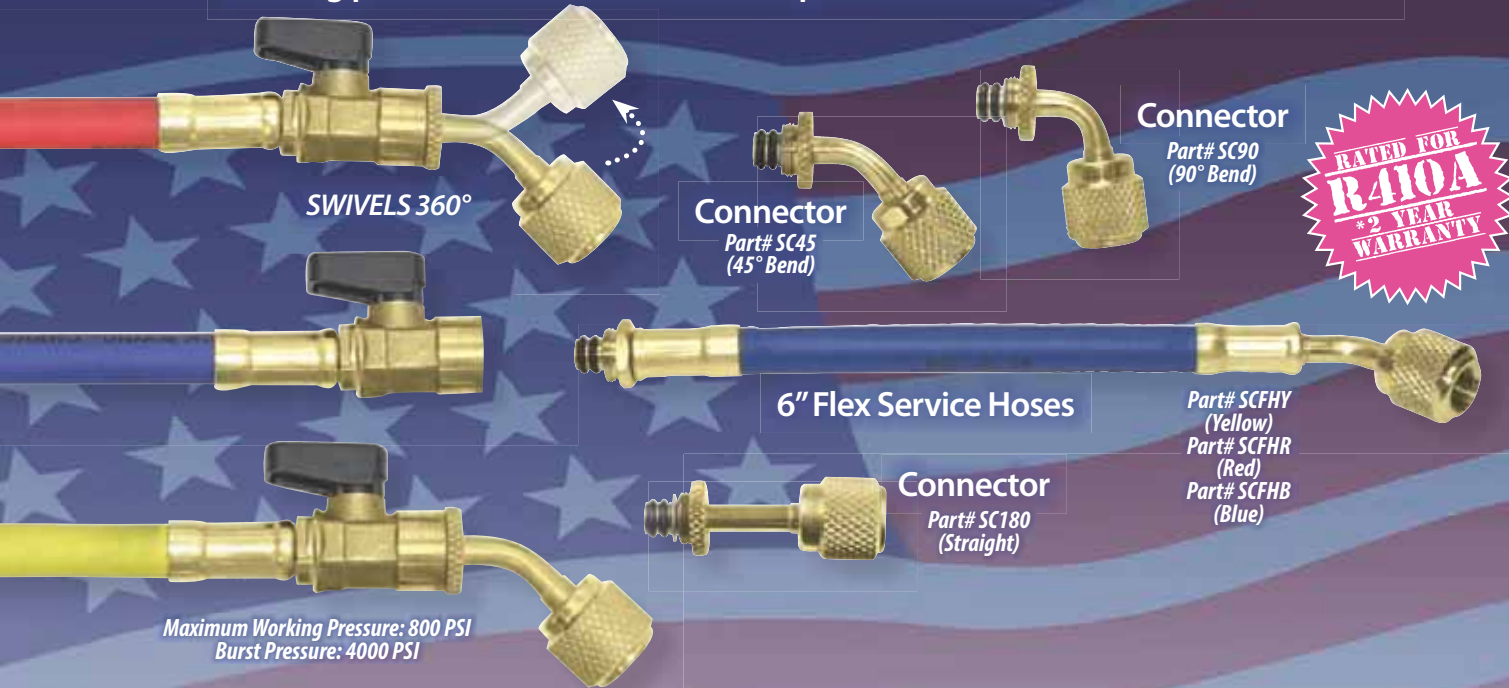

Maximum Working Pressure: 800 PSI
Burst Pressure: 4000 PSI

| | Length | | Red | Yellow | Blue | Hose Set 1 Each R, Y, B Part# |
|---|--------|--------|-----------|-----------|-----------|---|
| | | | Part# | Part# | Part# | |
| Soft Magic® Barrier Ball Valve Hoses with 45° Bend Service Connector | 36" | 90cm | H3SMBER | H3SMBEY | H3SMBEB | HC3SMBE |
| | 48" | 120cm | H4SMBER | H4SMBEY | H4SMBEB | HC4SMBE |
| | 60" | 150cm | H5SMBER | H5SMBEY | H5SMBEB | HC5SMBE |
| | 72" | 180cm | H6SMBER | H6SMBEY | H6SMBEB | HC6SMBE |
| | 96" | 240cm | H8SMBER | H8SMBEY | H8SMBEB | HC353MBE Hose Set: [2] 3 ft. Hoses and [1] 5 ft. Hose |
| | 25' | 7.50m | H25SMBER | H25SMBEY | H25SMBEB | |
| | 50' | 15.00m | H50SMBER | H50SMBEY | H50SMBEB | |
| | 100' | 30.00m | H100SMBER | H100SMBEY | H100SMBEB | |

| Part# | Description |
|-------|--|
| 21085 | Service Connector Repair Kit Includes: [2] O-Rings and [1] Retainer Clip |

5 HVAC/R TOOLS





Inline / Panel Mount / 45° Bend Ball Valve Adaptors

FOR U.S. JOBS
UNIWELD EMPLOYS OVER 300 WORKERS



Inline or Panel Mount Ball Valve Adaptor

92806

Minimize refrigerant loss by rotating valve to the closed position before disconnecting from the system. Recovery machine panel mount control valve.



45° Bend Ball Valve Adaptor

92809

Hose nut swivels 360° for easy access into tight work areas. Add to existing hose as control device.

Inline or Panel Mount Ball Valve

| Part# | Description |
|-------|--|
| 92806 | Inline or Panel Mount Ball Valve Adaptor, 1/4" M.F. x 1/4" M.F. (Yellow) |
| 92807 | Inline or Panel Mount Ball Valve Adaptor, 1/4" M.F. x 1/4" M.F. (Red) |
| 92808 | Inline or Panel Mount Ball Valve Adaptor, 1/4" M.F. x 1/4" M.F. (Blue) |

45° Bend Ball Valve Adaptor

| Part# | Description |
|-------|--|
| 92809 | Ball Valve Adaptor, 1/4" M.F. x 1/4" M.F. with 45° Bend (Red) |
| 92810 | Ball Valve Adaptor, 1/4" M.F. x 1/4" M.F. with 45° Bend (Yellow) |
| 92811 | Ball Valve Adaptor, 1/4" M.F. x 1/4" M.F. with 45° Bend (Blue) |
| 92833 | Ball Valve Adaptor Set, 1/4" M.F. x 1/4" M.F. with 45° Bend (1 each R, Y, B) |



90048



90050

90051

90052



90049



90054

6" Enviro Adaptor Hoses

| Part# | Description |
|-------|---|
| 90048 | Inline Ball Valve, 3/8" M.F. x 3/8" M.F. |
| 90049 | Inline Ball Valve, 3/8" M.F. x 1/4" M.F. |
| 90054 | Ball Valve with 6" Heavy Duty Hose, 3/8" M.F. x 3/8" F.F. |
| 90055 | Ball Valve with 6" Standard Hose, 3/8" M.F. x 1/4" F.F. Hose w/45° Bend, Yellow |

| Part# | Description |
|-------|--|
| 90050 | Ball Valve with 6" Hose, 1/4" M.F. x 1/4" F.F. w/45° Bend (Yellow) |
| 90051 | Ball Valve with 6" Hose, 1/4" M.F. x 1/4" F.F. w/45° Bend (Blue) |
| 90052 | Ball Valve with 6" Hose, 1/4" M.F. x 1/4" F.F. w/45° Bend (Red) |
| 90053 | Ball Valve with 6" Hose, 1/4" M.F. x 3/16" F.F. w/45° Bend (Red) |
| 90299 | Ball Valve with 6" Hose Set, [1 each 90050, 90051, 90052] |



Uniweld Products, Inc. Fort Lauderdale, FL 33312 U.S.A. Customer Service: 800.323.2111
info@uniweld.com • www.uniweld.com



Heavy Duty Charging and Vacuum Hoses



Soft Magic® Hoses

FOR U.S. JOBS
UNIWELD EMPLOYS OVER 300 WORKERS

Premium, large I.D. Hoses for CFC, HCFC and HFC refrigerants. Supplied with large, knurled hose nuts and rubber gaskets for easy finger tightening or wrench tight metal to metal seat hex flare nuts and copper gaskets. Choose from 3/8", 1/2" and 3/4" I.D. hoses to suit your requirements. 2-year over-the-counter replacement warranty*.



Rubber Seat

Metal Seat

| Length | 3/8" Str. x 3/8" Str. | | 3/8" Str. x 1/4" 45° | | 3/8" F.F. x 3/8" F.F. | | 3/8" F.F. x 3/8" F.F. 90° | | 3/8" F.F. 90° x 3/8" F.F. 90° | |
|--------|-----------------------|-------|----------------------|-------|-----------------------|-------|---------------------------|-------|-------------------------------|--|
| | Part# | Part# | Part# | Part# | Part# | Part# | Part# | Part# | Part# | |
| 6" | 90524 | 90527 | | | 90530 | 90533 | 90536 | | | |
| 12" | 90525 | 90528 | | | 90531 | 90534 | 90537 | | | |
| 24" | 90526 | 90529 | | | 90532 | 90535 | 90538 | | | |
| 36" | 90500 | 90206 | | | 90214 | 90222 | 90230 | | | |
| 48" | 90501 | 90207 | | | 90215 | 90223 | 90231 | | | |
| 60" | 90502 | 90208 | | | 90216 | 90224 | 90232 | | | |
| 72" | 90503 | 90209 | | | 90217 | 90225 | 90233 | | | |
| 96" | 90504 | 90210 | | | 90218 | 90226 | 90234 | | | |
| 25' | 90505 | 90211 | | | 90219 | 90227 | 90235 | | | |
| 50' | 90506 | 90212 | | | 90220 | 90228 | 90236 | | | |
| 100' | 90507 | 90213 | | | 90221 | 90229 | 90237 | | | |

3/8" Soft Magic® Heavy Duty Charging and Vacuum Hose

Max. Work Press: 600 PSI

Burst Press: 3000 PSI

Rubber Seat

Metal Seat

Metal Seat

| Length | 1/2" Str. x 1/2" Str. | | 5/8" Str. x 5/8" Str. | | 1/2" F.F. x 1/2" F.F. | | 5/8" F.F. x 5/8" F.F. | | 3/4" F.F. x 3/4" F.F. | |
|--------|-----------------------|-------|-----------------------|-------|-----------------------|-------|-----------------------|-------|-----------------------|---------|
| | Part# | Part# | Part# | Part# | Part# | Part# | Part# | Part# | Part# | |
| 36" | 90238 | 90246 | | | 90508 | 90254 | | | | H3D3M |
| 48" | 90239 | 90247 | | | 90509 | 90255 | | | | H3D4M |
| 60" | 90240 | 90248 | | | 90510 | 90256 | | | | H3D5M |
| 72" | 90241 | 90249 | | | 90511 | 90257 | | | | H3D6M |
| 96" | 90242 | 90250 | | | 90512 | 90258 | | | | H3D8M |
| 25' | 90243 | 90251 | | | 90513 | 90259 | | | | H3D25M |
| 50' | 90244 | 90252 | | | 90514 | 90260 | | | | H3D50M |
| 100' | 90245 | 90253 | | | 90515 | 90261 | | | | H3D100M |

1/2" & 3/4" Soft Magic® Heavy Duty Charging and Vacuum Hose

Max. Work Press: 350 PSI

Burst Press: 1987 PSI

3/4" Heavy Duty Charging Hi-Vacuum Hose

Max. Work Press: 350 PSI

Burst Press: 1987 PSI

See HVAC/R Price List for details.



Hex Female Flare Metal to Metal Seat

Replacement Parts

| Part# | Description |
|------------|--|
| HDX14N-10 | Pkg. of [10] Rubber Gaskets [3/8" Fittings] |
| HFX38-10 | Pkg. of [10] Copper Flare Gaskets [3/8" Fittings] |
| HD1X14N-10 | Pkg. of [10] Rubber Gaskets [1/2" & 5/8" Fittings] |
| HFX12-10 | Pkg. of [10] Copper Flare Gaskets [1/2" Fittings] |

5 HVAC/R TOOLS

64



Uniweld Products, Inc. Fort Lauderdale, FL 33312 U.S.A. Customer Service: 800.323.2111
info@uniweld.com • www.uniweld.com

Refrigerant Hoses



Super Black Magic®

FOR U.S. JOBS
UNIWELD EMPLOYS OVER 300 WORKERS

Uniweld's Super Black Magic® Refrigeration hoses for permanent installation are long lasting, trouble free alternatives to traditional copper capillary tubing used on refrigerant pressure and oil cutout controls. The wizardry of this hose is a seamless nylon tube wrapped with synthetic braid reinforcement and covered with black thermoplastic elastomer for maximum abrasion resistance. Refrigerant service technicians appreciate its easy installation in refrigeration rack systems in Supermarkets, Processing Plants and Paper Mills and its cost effectiveness. Available with optional 90° fittings.



Straight Rubber Gasket Seat

Specifications:

- Maximum Operating Pressure: 800 PSI (34 Bar)
- Burst Pressure: 4000 PSI (173 Bar)
- Maximum Working Temperature: 250°F (122°C)
- Minimum Bend Radius: 2" (50.8mm)



| | Length | Straight x Straight Part# | Straight x 90° Part# | 90° x 90° Part# | Description |
|--|-----------|---------------------------|----------------------|-----------------|---------------------------------------|
| 1/4" F.F x 1/4" F.F. Super Black Magic® Hoses | 12" 30cm | H012A400A | H012A409A | H012A410A | 1/4" Female Flare x 1/4" Female Flare |
| | 18" 45cm | H018A400A | H018A409A | H018A410A | 1/4" Female Flare x 1/4" Female Flare |
| | 24" 60cm | H024A400A | H024A409A | H024A410A | 1/4" Female Flare x 1/4" Female Flare |
| | 30" 75cm | H030A400A | H030A409A | H030A410A | 1/4" Female Flare x 1/4" Female Flare |
| | 36" 90cm | H036A400A | H036A409A | H036A410A | 1/4" Female Flare x 1/4" Female Flare |
| | 48" 120cm | H048A400A | H048A409A | H048A410A | 1/4" Female Flare x 1/4" Female Flare |
| | 60" 150cm | H060A400A | H060A409A | H060A410A | 1/4" Female Flare x 1/4" Female Flare |
| 3/8" F.F x 3/8" F.F. Super Black Magic® Hoses | 12" 30cm | HD1A700A | HD1A709A | HD1A710A | 3/8" Female Flare x 3/8" Female Flare |
| | 18" 45cm | HD018A700A | HD018A709A | HD018A710A | 3/8" Female Flare x 3/8" Female Flare |
| | 24" 60cm | HD2A700A | HD2A709A | HD2A710A | 3/8" Female Flare x 3/8" Female Flare |
| | 30" 75cm | HD030A700A | HD030A709A | HD030A710A | 3/8" Female Flare x 3/8" Female Flare |
| | 36" 90cm | HD3A700A | HD3A709A | HD3A710A | 3/8" Female Flare x 3/8" Female Flare |
| | 48" 120cm | HD4A700A | HD4A709A | HD4A710A | 3/8" Female Flare x 3/8" Female Flare |
| | 60" 150cm | HD5A700A | HD5A709A | HD5A710A | 3/8" Female Flare x 3/8" Female Flare |

| | Part# | UPC# | Description |
|--------------------------|----------|-------|---|
| Replacement Parts | HFX14-10 | 47608 | Pkg. of [10] Copper Flare Gaskets [1/4" Hose] |
| | HFX38-10 | 47609 | Pkg. of [10] Copper Flare Gaskets [3/8" Hose] |



Uniweld Products, Inc. Fort Lauderdale, FL 33312 U.S.A. Customer Service: 800.323.2111
info@uniweld.com • www.uniweld.com

65

Adaptors/Fittings/O-Rings/Tool



Adaptors & Accessories

FOR U.S. JOBS
UNIWELD EMPLOYS OVER 300 WORKERS



UNDER
PRESSURE



92836
Refrigerant Drum Adaptor
3/4" NPS Cylinder x 1/4" M.F.

| | Part # | Description |
|--------------------------|---------|---------------------------------|
| 1/4" | EZAB | Straight 1/4" M.F. x 1/4" F.F. |
| | EZAB90 | 90° 1/4" M.F. x 1/4" F.F. |
| 5/16" | EZABM | Straight 1/4" M.F. x 5/16" F.F. |
| | EZABM90 | 90° 1/4" M.F. x 5/16" F.F. |
| R-410A Mini Split | | |



92863
R-410A Mini-Split Adaptor
5/16" (1/2"-20) Female
w/Adjustable Depressor
x 1/4" Male w/Valve Core



92816
R-134a and R-12
Vacuum Pump Adaptor
1/4" F.F. x 1/2" ACME M. x 1/4" M.F.



92820
Valve Core Tool Double ended for
removing and installing both
standard and large bore
valve cores

Replacement Tethered Caps
92817 - 1/4" Plastic Cap (Pkg. 10)
92818 - 1/2" ACME Plastic Cap (Pkg. 10)



13401
1/4" F.F. x 1/2" ACME M.

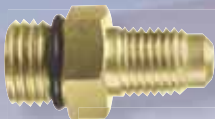

92800
14mm M. x 1/4" M.F.



92801
14mm M. x 3/8" M.F.



10005
1/4" M.F. x 1/8" M.P.T.



92799
1/2" ACME F. x 1/4" M.F.



EZABR90
R-134a to R-12
Anti-Blowback
Adaptor
14mm F. x 1/4" F.F.



ABB134
Straight Anti-blowback Adaptor
1/2" ACME F. x 1/2" ACME M.



ABBRK
Anti-Blowback
O-Ring Repair Kit
(Pkg. of 4)
For ABB125, ABB190
ABB1425, ABB410

5 HVAC/R Tools

66



Uniweld Products, Inc. Fort Lauderdale, FL 33312 U.S.A. Customer Service: 800.323.2111
info@uniweld.com • www.uniweld.com



Propane Halide Leak Detector

Halide Leak Detector

FOR U.S. JOBS
UNIWELD EMPLOYS OVER 300 WORKERS

Uniweld's Propane Halide Leak Detector instantly locates non-combustible halide (CFC & HCFC) refrigerant gas leaks. Leaks are located when the chlorine based refrigerant gases are drawn in through the probe hose and exposed to a heated copper reactor plate, changing the blue flame to green. This detector is very sensitive and can be used to locate leaks as small as 20 ppm of CFC and HCFC refrigerants. **Will not detect non-chlorine based refrigerants (such as R-410A).**



When chlorine-based refrigerant gases are detected...

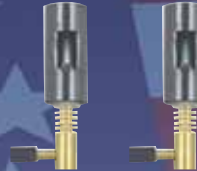

...blue flame changes to green



Part# Description

| | |
|---------|---|
| PCLD33T | Propane Halide Leak Detector w/ Tool Box includes: PLD33V Leak Detector w/probe hose, FL34 Flint Lighter, PDC Propane Cylinder & Plastic Tool Box. [9 per case] |
| PCLD33 | Propane Halide Leak Detector includes: PLD33V Leak Detector w/probe hose & PDC Propane cylinder. [6 per case] |
| PLD33 | Propane Halide Leak Detector with probe hose, for air/fuel torch handle |
| PLD33V | Propane Halide Leak Detector with probe hose valve assembly |
| LD32 | Halide Leak Detector for air/acetylene use |
| CC61 | Plastic Tool Box (12.5" L x 7" W x 5" H) |
| H02-3 | 3ft. Probe Hose |
| PCV | Valve Assembly Only |
| LDPLC | Copper Reactor Plate |
| LD7-1A | Injector for LD-16 assembly |

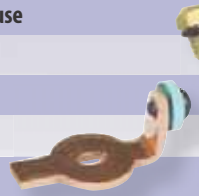

LDPLC



Uniweld Products, Inc. Fort Lauderdale, FL 33312 U.S.A. Customer Service: 800.323.2111
info@uniweld.com • www.uniweld.com

67

5 HVAC/R Tools

U OMO IVE



R-134a/R-12 Automotive 2 Valve Brass Manifolds

Man, What a Manifold®

FOR U.S. JOBS
UNIWELD EMPLOYS OVER 300 WORKERS



Lens Plug for easy zero reset

Automatic Service Couplers

90045 High Side

90046 Low Side

Manual Service Couplers

90043 High Side

90044 Low Side

6 Automotive A/C

Uniweld's Automotive 2-Valve Brass Manifold has a solid forged brass body with metal hand wheels and a convenient hose holder. The large R-134a/R-12 gauges are protected with color-coded gauge boots. Options include manual or automatic Service Couplers, Soft Magic® Hoses and either 2½" LPF™ or 3⅛" NPF® Gauges.

| | Hose Set Length | Soft Magic® Hoses Manual Couplers | Soft Magic® Hoses Auto Couplers | | Hose Set Length | Soft Magic® Hoses Manual Couplers | Soft Magic® Hoses Auto Couplers |
|---------------------------------------|-----------------|-----------------------------------|---------------------------------|---------------------------------------|-----------------|-----------------------------------|---------------------------------|
| 47827 Manifold 2½" LPF™ Gauges | 36" [90cm] | 47850 | 48050 | 48800 Manifold 3⅛" NPF® Gauges | 36" [90cm] | 48851 | 48801 |
| | 60" [150cm] | 47851 | 48051 | | 60" [150cm] | 48852 | 48802 |
| | 72" [180cm] | 47852 | 48052 | | 72" [180cm] | 48853 | 48803 |
| | 96" [240cm] | 47853 | 48053 | | 96" [240cm] | 48854 | 48804 |

48075 Manifold with [2] 3 ft., [1] 5 ft. Soft Magic® hoses and automatic couplers.

48805 Manifold with [2] 3 ft., [1] 5 ft. Soft Magic® hoses and automatic couplers.

NOTE: R-12 service connections are not included.

68



Uniweld Products, Inc. Fort Lauderdale, FL 33312 U.S.A. Customer Service: 800.323.2111 info@uniweld.com • www.uniweld.com



R-134a/R-12 Automotive 2 Valve Aluminum Manifolds

Man, What a Manifold®

FOR U.S. JOBS
UNIWELO EMPLOYS OVER 300 WORKERS

**NPF®
Silicone
Dampened
Movement**

**Lens
Plug
for easy
zero
reset**

**90044
Low Side**

**Manual
Service
Couplers**

**90043
High Side**

91600

UniweLO's R-134a Automotive anodized aircraft Aluminum Block Manifold features a large optical sight glass for monitoring refrigerant. High and low side brass valves provide precision control. Optional manual or automatic Service Couplers available with either 2½" LPF™ or 3⅛" NPF® gauge Manifolds.

| | Hose Set Length | Soft Magic® Hoses Manual Couplers | Soft Magic® Hoses Auto Couplers | | Hose Set Length | Soft Magic® Hoses Manual Couplers | Soft Magic® Hoses Auto Couplers |
|---|-----------------|-----------------------------------|---------------------------------|--|-----------------|-----------------------------------|---------------------------------|
| 90000 Manifold 2½" [127mm] LPF™ Gauges | 36" [90cm] | 90007 | 90750 | 91600 Manifold 3⅛" [80mm] NPF® Gauges | 36" [90cm] | 91651 | 91601 |
| | 60" [150cm] | 90008 | 90751 | | 60" [150cm] | 91652 | 91602 |
| | 72" [180cm] | 90009 | 90752 | | 72" [180cm] | 91653 | 91603 |
| | 96" [240cm] | 90010 | 90753 | | 96" [240cm] | 91654 | 91604 |

NOTE: R-12 service connections are not included.



UniweLO Products, Inc. Fort Lauderdale, FL 33312 U.S.A. Customer Service: 800.323.2111
info@uniweLO.com • www.uniweLO.com



6 Automotive A/C



Soft Magic® Charging Hoses

Automotive Hoses

FOR U.S. JOBS
UNIWELD EMPLOYS OVER 300 WORKERS

Uniweld's Soft Magic® super-flexible hose for under the hood and tight work areas. The yellow charging hose includes an anti-blowback fitting. Meets SAE J2196/R-134a specifications.

Specifications:

- Maximum Operating Pressure: 800 PSI (34 Bar)
- Burst Pressure: 4000 PSI (173 Bar)

1/2" ACME with
Anti-blowback fittings

14mm

14mm

| | Hose Length | Yellow 1/2" Acme x 1/2" Acme w/Anti-Blowback | Red 14mm x 1/2" Acme | Blue 14mm x 1/2" Acme | Hose Set 1 each R, V, B |
|--------------|-------------|--|-------------------------|--------------------------|----------------------------|
| Black Magic® | 36" | 90027 | 90031 | 90035 | 90039 |
| | 60" | 90028 | 90032 | 90036 | 90040 |
| | 72" | 90029 | 90033 | 90037 | 90041 |
| | 96" | 90030 | 90034 | 90038 | 90042 |
| Soft Magic® | 36" | 49008 | 49000 | 49004 | 49020 |
| | 60" | 49009 | 49001 | 49005 | 49021 |
| | 72" | 49010 | 49002 | 49006 | 49022 |
| | 96" | 49011 | 49003 | 49007 | 49023 |

| Part# | UPC# | Description |
|------------|-------|---|
| 90059 | 90059 | Package of [2] 14mm O-Rings and [4] 1/2" Acme Gaskets |
| HR134N-10 | 13414 | Package of 10 pieces. 1/2" Acme Gaskets |
| HR134N-100 | 13415 | Package of 100 pieces. 1/2" Acme Gaskets |

Replacement Parts

6 Automotive A/C



G10LAD
2 1/2" LPF™

Automotive Replacement Gauges

R-134a/R-12 - PSI°F with color coded gauge boots on large easy to read dials.

| Part# | Description |
|----------|--|
| G9LAD | 2 1/2" LPF™ 0-500 psi |
| G10LAD | 2 1/2" LPF™ 30"-Hg-120 psi, 300 psi Overpressure |
| G409NSAD | 3 1/8" NPF® 0-500 psi |
| G410NSAD | 3 1/8" NPF® 30"-Hg-120 psi, 300 psi Overpressure |



G409NSAD
3 1/8" NPF®

70



Uniweld Products, Inc. Fort Lauderdale, FL 33312 U.S.A. Customer Service: 800.323.2111
info@uniweld.com • www.uniweld.com



R-134a Manual Service Couplers with 8 balls

Service Couplers

FOR U.S. JOBS
UNIWELED EMPLOYS OVER 300 WORKERS

Uniweld's improved R-134a Manual Service Couplers accurately centers to the schrader valve. This prevents damage to the schrader and securely locks the coupler onto the A/C service port.

| Part# | Description |
|-------|--|
| 90043 | Manual Red-High Side [14mm Female] |
| 90044 | Manual Blue-Low Side [14mm Female] |
| 90478 | Manual Red-High Side w/92800 [1/4" M.F. Adaptor] |
| 90479 | Manual Blue-Low Side w/92800 [1/4" M.F. Adaptor] |
| 90480 | Manual Red-High Side w/92801 [3/8" M.F. Adaptor] |
| 90481 | Manual Blue-Low Side w/92801 [3/8" M.F. Adaptor] |



90043
High Side

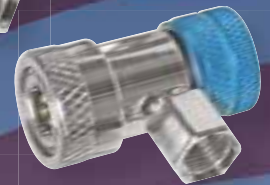

90044
Low Side

| Part# | Description |
|-------|---|
| 90045 | Automatic Red-High Side [14mm Female] |
| 90046 | Automatic Blue-Low Side [14mm Female] |
| 90483 | R-134a Automatic Coupler - Red/High w/92800 [1/4" M.F. Adaptor] |
| 90484 | R-134a Automatic Coupler - Blue/Low w/92800 [1/4" M.F. Adaptor] |
| 90485 | Automatic Service Coupler Kit: Red-High Side [14mm F.] & Blue-Low Side [14mm F.] Couplers |
| 90486 | Automatic Service Coupler/Adaptor Kit: Red-High Side [14mm F.] & Blue/Low Side [14mm F.] Couplers with two 92800 1/4" M.F. Adaptors |

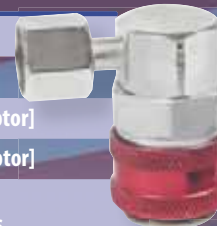

90045
High Side



90046
Low Side

| Part# | Description |
|-------|--|
| 90482 | Service Coupler O-Ring Repair Kit Includes: [1 each] X09R Low side and X11R High side |



47880 Kit

R-134a and R-12 Conversion Kits

R-134a Automatic Service Couplers are designed for working in tight spaces. Push down on the coupler to snap it easily onto the A/C service port and automatically open the valve core.

| Part# | Description |
|-------|--|
| 47881 | R-134a to R-12 Conversion Kit: [2] ABB1425 & [1] 13401 Adaptor |
| 47880 | R-12 to R-134a Conversion Kit: 90478, 90479 Manual Couplers and 92799 Adaptor 1/2" Acme F. X 1/4" M.F. |



47881
Kit



Uniweld Products, Inc. Fort Lauderdale, FL 33312 U.S.A. Customer Service: 800.323.2111
info@uniweld.com • www.uniweld.com

71

6 Automotive A/C

UNIWELD



A/C Flush Kit / Can Tap Valve / Recharge Hose

R-134a Auto Accessories

FOR U.S. JOBS
UNIWELD EMPLOYS OVER 300 WORKERS

The A/C Flush Kit is used to remove moisture, contaminants and acid from the evaporator and the condenser. It is designed to work with any A/C flush solvent that can be mixed with pressurized air. Add up to 18 oz. of solvent to the reusable canister and with the use of pressurized shop air, reverse flush the evaporator and condenser during retrofitting or replacement.

FEATURES:

- Pressure Relief Valve that opens automatically at 180 to 190 psi, protecting the cylinder and equipment from overpressure
- Valve Assembly with a Liquid Dip Tube
- Ball Valve with 1/4 turn open/close • 24" flexible Service Hose • Blow Gun fitted with Rubber Tip Nozzle

| | Part# | Description |
|------------------------------------|---------|---|
| Flush Kit | 94180 | Auto A/C System Flush Kit |
| Flush Kit Replacement Parts | BG1FA | Blowgun with Auto Rubber Tip Nozzle |
| | H2P100D | 24" Service Hose |
| | 40049 | Auto Rubber Tip Nozzle with 1/8" M.P.T. Fitting |

NOTE: Residential & Commercial A/C Flush Kit also available. See page 51



R-134a Can Tap Valve and Auto Recharge Hose

Self-piercing R-134a Can Tap Valve with 1/2" ACME fittings and "T" handle valve for easy fingertip control. The R-134a Recharge Hose assembly includes: the Can Tap Valve with hose and low side Service Coupler for quick, easy service of an auto A/C system.



| | Part# | Description |
|-------------------------------|-------|---|
| Can Tap Valve and Hose | 49016 | R-134a Auto Recharge Hose with Can Tap Valve |
| | 90060 | R-134a Can Tap Valve with 1/2" Acme Male Fittings |

UNIWELD



Oil/Dye Injector and A/C Adaptor Kit

R-134a Auto Accessories

FOR U.S. JOBS
UNIWELD EMPLOYS OVER 300 WORKERS



The refillable Oil/Dye Injector has a 2 oz. capacity. The anodized aluminum body and end caps are fitted with O-ring seals. Attach the injector directly to the manifold low side hose connection and add oil/dye to the system. Available with optional 1/2" ACME fittings or 1/4" Flare fittings.



94170

Oil Injector

| Part# | Description |
|-------|--|
| 94170 | Refillable Oil/Dye Injector with 1/2" Acme fittings |
| 94175 | Refillable Oil/Dye Injector with 1/4" Flare fittings |

Universal A/C Adaptor Kit

The Universal A/C Adaptor Kit box contains the most popular adaptors for servicing an A/C system, including a universal ball valve with interchangeable service connectors. Also included are replacement parts for R-123 and R-134a service hoses.



Universal Ball Valve with interchangeable Service Connectors



92830

**92830
Universal
Adaptor Kit
Parts
List**

| Part# | Description |
|-----------|--|
| BV501FX | Universal Ball valve with 1/4" M.F. |
| 92786 | 1/4" Service Connector, straight |
| 92788 | 1/4" Service Connector, w/90° bend |
| 92795 | 3/16" Service Connector, straight |
| 92797 | 3/16" Service Connector, w/90° bend |
| HX14N-10 | 1/4" Hose Gasket [10 pcs.] |
| H76S-10 | 1/4" Hose Depressor [10 pc.] |
| X09R | R-134a Low side Coupler O-Ring [5 pcs.] |
| X11R | R-134a High side Coupler O-Ring [5 pcs.] |
| X15R | Hose-O-Ring 14mm male [5 pcs.] |
| X40R | Service Connector O-Ring [10 pcs.] |
| HR134N-10 | 1/2" Acme Hose Gasket [10 pcs.] |

6 Automotive A/C



UniWeld Products, Inc. Fort Lauderdale, FL 33312 U.S.A. Customer Service: 800.323.2111
info@uniweld.com • www.uniweld.com

73



Sludge Sucker®/Blaster® Kit

Sludge Sucker®

FOR U.S. JOBS
UNIWELD EMPLOYS OVER 300 WORKERS

Nitrogen is a dry inert gas with multiple uses in the HVAC/R industry: purging and pressure testing copper tubing, calibrating pressure controls, cleaning a condensate drain line, cleaning coils, inflating tires, unclogging a sink, operating impact tools and much more.

Uniweld does not recommend that CO₂ be used for purging or pressure testing an A/C&R system because it may form carbonic acid within the system, causing premature equipment failure. The Sludge Sucker® Kit options include a choice of high or low-pressure regulators for Nitrogen or CO₂ [with optional F36 adaptor] and various carrying stands depending on tank size. All Sludge Sucker® Kits include the handy Sludge Blaster® for quickly unclogging drain pipes.



Blow off coils with Sludge Sucker® Blowgun



Purge and pressure test an A/C&R system



Clean out condensate drain lines with Sludge Blaster®

40004

2. Use PVC fittings, if needed, to attach vinyl hose to drain line.

1. Locate condensate drain line. Sludge Sucker® vinyl hose fits inside a 3/4" PVC fitting.



3. Allow Nitrogen to flow through Sludge Sucker® fitting and then watch the sludge get sucked out of the drain line and blown onto the ground.

| Part# | Regulators | Sludge Item | Hoses | Blowgun | Carrying Stand |
|-------|---------------------------|-----------------|----------------------|---------|----------------------|
| 40001 | R1563 [Delv. 5-175 psi] | 40000 | | | 515 [20 cu. ft.]* |
| 40002 | R1563 [Delv. 5-175 psi] | Sludge Sucker® | H5SMBY 5 ft. hose | | 516 [40/55 cu. ft.]* |
| 40003 | RHP500 [Delv. 20-500 psi] | | | BG1 | 515 [20 cu. ft.]* |
| 40004 | RHP500 [Delv. 20-500 psi] | 40061 | H2SSM 2 ft. hose | | 516 [40/55 cu. ft.]* |
| 40039 | RHP400 [Delv. 20-400 psi] | Sludge Blaster® | | | 515 [20 cu. ft.]* |
| 40040 | RHP400 [Delv. 20-400 psi] | | | | 516 [40/55 cu. ft.]* |

*Tank not included.



Sludge Sucker® Maintenance Kit



Sludge Sucker®

FOR U.S. JOBS
UNIWELD EMPLOYS OVER 300 WORKERS

A versatile, all-in-one kit that includes a Nitrogen regulator with a delivery pressure up to 400 PSI for pressure testing an A/C&R system for leaks. It also includes many accessories for cleaning condensate drain lines and for blowing off coils. It even has an air chuck to fill up that flat tire. As a bonus, our Sludge Blaster® is included (see page 80 for more information). Carry stands are sold separately (see page 41).



Blow off coils with Sludge Sucker® Blowgun



Clean condensate drain lines with the Sludge Blaster®



Inflate tire with the Sludge Sucker® Air Chuck

7 Nitrogen & CO₂

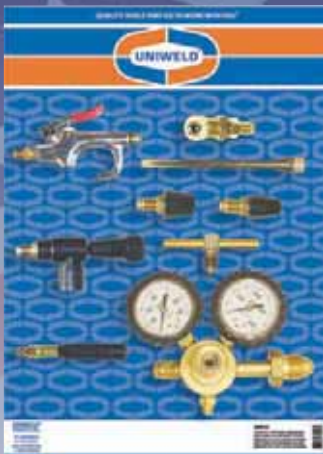

40055

40055 Sludge Sucker® Maintenance Kit

| Part# | Description | Part# | Description |
|--------|--------------------|-------|------------------|
| RHP400 | Nitrogen Regulator | 40048 | Needle Tip |
| 40000 | Sludge Sucker® | 40050 | 1/2" Rubber Plug |
| 40061 | Sludge Blaster® | 40022 | 3/4" Rubber Plug |
| H2SSM | 2 Ft. Hose | BG1 | Blowgun |
| H5SMBY | 5 Ft. Hose | 40045 | Air Chuck |

40077 Sludge Blaster® Accessory Kit

Already own a Nitrogen regulator? Then this 8-piece accessory kit is for you. It attaches to your regulator and includes the most popular tools to unclog and flush drain lines.

| Part# | Description | Part# | Description |
|--------|-----------------|-------|------------------|
| 40061 | Sludge Blaster® | 40050 | 1/2" Rubber Plug |
| H2SSM | 2 Ft. Hose | 40022 | 3/4" Rubber Plug |
| H5SMBY | 5 Ft. Hose | BG1 | Blowgun |
| 40048 | Needle Tip | 40045 | Air Chuck |

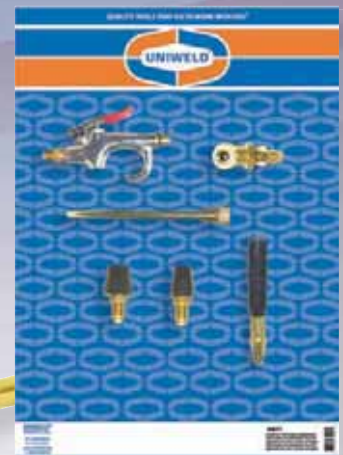

40077



Uniweld Products, Inc. Fort Lauderdale, FL 33312 U.S.A. Customer Service: 800.323.2111
info@uniweld.com • www.uniweld.com

75

Now with Twice the Suction Power



Sludge Sucker®

FOR U.S. JOBS
UNIWELD EMPLOYS OVER 300 WORKERS

The Sludge Sucker® is a tool that was developed to clean out a condensate drain line without accessing the drain pan located in the air handler. The Sludge Sucker's clear vinyl hose is attached to the 3/4" PVC condensate drain line on the outside of the building. With the use of Nitrogen or CO₂, suction is created and that pulls all the sludge and algae from the drain pan and drain line; then blows it onto the ground outside.



40000
Sludge Sucker®

1. Locate condensate drain line. Sludge Sucker® vinyl hose fits inside a 3/4" PVC fitting.



1

2. Use PVC fittings, if needed, to attach vinyl hose to drain line.



2



3

3. Allow Nitrogen to flow through Sludge Sucker® fitting and then watch the sludge get sucked out of the drain line and blown onto the ground.



40061
Sludge Blaster®

| Part# | Description |
|-------|---------------------------------------|
| 40000 | Sludge Sucker® with clear vinyl hose. |

Sludge Blaster®/Drain Blaster®

1. Insert Sludge Blaster® into the "T" connection at the air handler.



1



2



3

3. Replace PVC cap on "T" connection for future service: DO NOT GLUE PERMANENTLY.

2. Allow Nitrogen (at max. 140 PSIG) to flow through, blasting the sludge free.

Unclog A/C condensate drain pipes FAST with Sludge Blaster®. It expands inside the pipe and with pressure exerted on the clog, blasts the sludge free. Attaches to standard 1/4" service hose. Pipe capacity: 3/4" to 1" I.D.



40062

40063

40064

Unclog drain pipes FAST with Drain Blaster®. It expands inside the pipe and exerts water pressure on the clog...blasting it free. Attaches to standard 3/4" garden hose.

| Part# | Description | Pipe Capacity |
|-------|-----------------|-------------------|
| 40061 | Sludge Blaster® | 3/4" to 1" I.D. |
| 40062 | Drain Blaster™ | 1" to 2" I.D. |
| 40063 | Drain Blaster™ | 1 1/2" to 3" I.D. |
| 40064 | Drain Blaster™ | 3" to 6" I.D. |

Blowgun/Blowgun Accessories/Rubber Plugs



Accessories

FOR U.S. JOBS
UNIWELD EMPLOYS OVER 300 WORKERS



**BG1 Blowgun
for Sludge Sucker®
Kit**



**40045
Air Chuck**

Blowgun Accessories



**H5SMY
5 Ft. Service Hose**

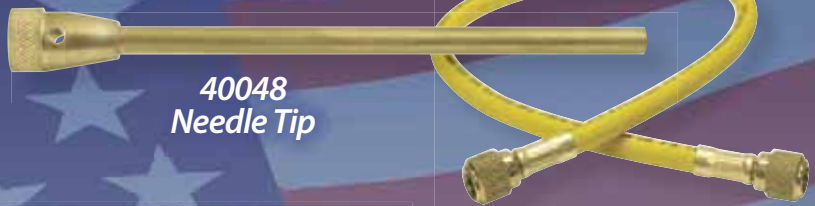

**40048
Needle Tip**

**H2SSM
2 Ft. Service Hose**

Rubber Plug Adaptors

Rubber Plug Adaptors are primarily used for drainline flushing.



Flush out a clogged sink drain using Rubber Plug Adaptors.

| Part# | Description |
|-------|---|
| 40045 | Air Chuck with 1/4" M. F. fitting |
| 40048 | Needle Tip [attaches to blowgun] |
| BG1 | Blowgun with safety tip 1/4" M. F. inlet & outlet [Maximum working pressure: 120 psi] |
| H2SSM | 2 Ft. Service Hose [attaches to blowgun] |
| H5SMY | 5 Ft. Service Hose [attaches to blowgun] |
| 40050 | Rubber Plug Adaptor* [1/2" x 3/4" Cone] |

| Part# | Description |
|-------|---|
| 40051 | Rubber Plug Adaptor* [1" x 1 1/4" Cone] |
| 40052 | Rubber Plug Adaptor* [1 1/4" x 1 1/2" Cone] |
| 40053 | Rubber Plug Adaptor* [1 1/2" x 2" Cone] |
| 40054 | Rubber Plug Adaptor* [2" x 2 1/2" Cone] |
| 40022 | Rubber Plug Adaptor* [3/4" x 7/8" Cone] |

*with 1/4" M.F. fittings.



Uniweld Products, Inc. Fort Lauderdale, FL 33312 U.S.A. Customer Service: 800.323.2111
info@uniweld.com • www.uniweld.com



7 Nitrogen & CO₂

Nitrogen Flow Indicator/Regulators



Nitrogen Flow

FOR U.S. JOBS
UNIWELD EMPLOYS OVER 300 WORKERS

NV1 NitroVue is nitrogen purging simplified. The easy to read flow indicator label and the precision adjustable valve give complete control over the low flow of nitrogen gas during the brazing of copper tubing in Air Conditioning and Refrigeration systems. The bright orange float ball visually confirms the flow of nitrogen gas and allows the technician to first "PURGE" the copper lines at 20+ SCFH and then reduce the flow to "BRAZE" at 3-5 SCFH during the brazing process thus conserving its consumption and reducing operating cost.

The nitrogen must be flowing to displace the oxygen inside the tubing during the brazing process, preventing internal oxidation and the resulting scale. Scale build up inside the tubing can cause blockage in the TXV and within the Air Conditioning and Refrigeration system resulting in premature failure. If the orange ball does not rise in the tube there is no flow of nitrogen, only static pressure and oxygen is not being displaced. The NV1 must be connected to a Nitrogen Regulator with the delivery pressure set at 60 PSI to control the nitrogen gas pressure. The NV1 can be used with complete confidence because it is protected from over pressure with a resealable safety blow off that opens at 200+ PSI.

Patent Pending



| Part# | UPC# | CGA Inlet | Outlet Connection |
|-------|-------|-----------|-------------------|
| NV1 | 14040 | 1/4" F.F. | 1/4" M.F. |



Maximum Inlet Pressure: 50 PSI

Flow Ball Indicator

| Part# | UPC# | CGA Inlet | Outlet Connection |
|-------|-------|-----------|-------------------|
| UNF3 | 14030 | 1/4" F.F. | 1/4" M.F. |

Part# Replacement Parts

| | | |
|--------|-------|---|
| R96K | 12026 | Pressure Relief Kit: Includes (1) copper disk, (2) washers and (1) brass relief cap |
| UNF93A | 14032 | Inlet Assembly |



Regulators/Replacement Gauges



Nitrogen/CO₂ Regulators

FOR U.S. JOBS
UNIWELD EMPLOYS OVER 300 WORKERS

Regulators for use with Nitrogen or CO₂ (with optional F36 adaptor) that have been specially designed for purging and pressure testing. Large "T" handle with stainless steel pressure adjusting screw and bushing prevent galling.



Reseatable Safety Blowoff Opens at 850-875 PSI

RHP800
Nitrogen Regulator



Reseatable Safety Blowoff Opens at 450-475 PSI

RHP400
Nitrogen Regulator

F36 Adaptor CO₂ Cylinder (CGA320) to Nitrogen (CGA580)



| Part# | UPC# | CGA Inlet | Outlet Connection | Gauges Delivery/Contents | Delivery PSIG |
|--------|-------|-----------|-------------------|--------------------------|---------------|
| RHP400 | 13000 | 580 | 1/4" M.F. | [G8SD] 600/4000 [G7SD] | 0-400 |
| RHP500 | 13100 | 580 | 1/4" M.F. | [G8SD] 600/4000 [G7SD] | 0-500 |
| RHP800 | 13800 | 580 | 1/4" M.F. | [G34SD] 1000/4000 [G7SD] | 0-800 |

| Part# | Pressure | Diam. | Case | N.P.T. |
|------------------------------------|----------|-------|-----------------|--------|
| Replacement Gauges G34SD | 1000 psi | 2" | Gold Steel Case | 1/4" |
| G7SD | 4000 psi | 2" | Gold Steel Case | 1/4" |
| G8SD | 600 psi | 2" | Gold Steel Case | 1/4" |

NOTE: REPLACEMENT GAUGES DO NOT INCLUDE 2" GAUGE BOOT [SOLD SEPARATELY]

GB20S
2" Gauge Boot Set (2) Black

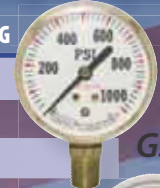

G34SD

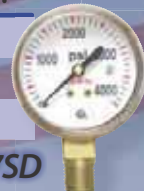

G7SD



G8SD

Nitrogen and CO₂ Regulators

A compact, proven design for soft drink dispensing systems (not beer) and for many types of pressurizing applications. Features include: an adjustable pressure screw with locking nut and a self re-seating relief valve (not designed to protect downstream systems).

| | CO ₂ Part# | Nitrogen Part# | 1 1/2" Gauges/Delivery | Delivery PSIG |
|-------------------------------|-----------------------|----------------|--|---------------|
| Single Gauge Regulator | R1346 | R1546 | 60 [G83D] | 2-50 |
| | R1349 | R1549 | 300 [G84D] | 2-175 |
| | CO ₂ Part# | Nitrogen Part# | Nitrogen/CO ₂ Delivery/Contents | Delivery PSIG |
| Dual Gauge Regulator | R1358 | R1558 | [G20D] 15/4000 [G82D] | 2-12 |
| | *R1360 | *R1560 | [G83D] 60/4000 [G82D] | 2-50 |
| | *R1362 | *R1562 | [G78D] 200/4000 [G82D] | 5-120 |
| | *R1363 | *R1563 | [G84D] 300/4000 [G82D] | 5-175 |



*Gauges shipped with protective boots

R1563

- CGA320-CO₂ inlet connection with O-ring
- CGA580-Nitrogen inlet connection
- 1/4" SAE flare outlet
- U.L. Listed



Uniweld Products, Inc. Fort Lauderdale, FL 33312 U.S.A. Customer Service: 800.323.2111
info@uniweld.com • www.uniweld.com

79

7 Nitrogen & CO₂

Ratchet-action Cutters for plastic pipe



PVC Pipe Cutters

FOR U.S. JOBS
UNIWELD EMPLOYS OVER 300 WORKERS

The ideal cutting tools for plastic pipe commonly used for condensate drain line, plumbing lines, irrigation and electrical conduit. Easy-to-use ratchet-action mechanism and hardened steel blade replaces that old saw blade that never cut clean or straight. The blade holds a sharp edge and is easily field replaceable. Cuts cleanly through all plastic pipe including: PVC, CPVC and Polyethylene.

8 Tubing Tools



1 Release safety lock and pull handles open with both hands.



2 Position pipe in the cutter and close handles together to engage ratchet. Blade begins to cut on contact.

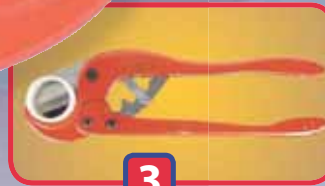

3 Close and release handles using ratcheting action to cut through the pipe.



4 Use inside/outside Deburring Tool (UniWeld #70079) to remove burrs from pipe.

70087
PVC Ratchet
Pipe Cutter
Cuts up to
2½" O.D. (63mm)



70080
Replacement
Blade

70121
Replacement
Spring



70078
PVC Ratchet Pipe
Cutter cuts up to
1⅝" O.D. (42mm)





20'N'1 and 6'N'1 Screwdrivers Ratchet Screwdrivers

FOR U.S. JOBS
UNIWELD EMPLOYS OVER 300 WORKERS

20 'N' 1 Ratchet Screwdriver

Multi-tip Ratchet Screwdriver with 14 magnetic interchangeable double-end bits, three nut drivers, two valve core extractors and one wire bender.

3 Ratchet Driver settings: Forward/Reverse/Manual



1/4" Nut Driver



5/16" Nut Driver

20N1RS D



12 Bit Storage Area



Display Package



7/16" Nut Driver



Wire Bender
(up to 12 ga.)



Valve Core
Removal Tool



Valve Core
Pick Extractor

Removes
Broken
Valve Core

| | | | | | |
|---------------|---------|-------------|---------------------------|---------|-------------------------|
| 3/16" Slotted | RSDBIT1 | #1 Phillips | T-10 Torx | RSDBIT5 | T-15 Torx |
| 1/4" Slotted | RSDBIT2 | #2 Phillips | 5/32" Allen | RSDBIT6 | 1/8" Allen |
| 5/16" Slotted | RSDBIT3 | #3 Phillips | 1/4" Allen | RSDBIT7 | 3/16" Allen |
| S-1 Square | RSDBIT4 | S-2 Square | Valve Core Pick Extractor | RSDBIT8 | Valve Core Removal Tool |

6 'N' 1 Ratchet Screwdriver

Change bits and driver sizes quickly with a pull, flip and click. Work with 4 magnetized bits and 2 driver sizes. Three ratchet driver settings: Forward, Reverse & Manual.



6N1RS D

#1 Phillips



3/16" Slotted

3 Ratchet Driver settings:
Forward/Reverse/Manual

#2 Phillips



1/4" Slotted

1/4" Nut Driver



5/16" Nut Driver



Uniweld Products, Inc. Fort Lauderdale, FL 33312 U.S.A. Customer Service: 800.323.2111
info@uniweld.com • www.uniweld.com

Reversible and Offset Wrenches/Dual Hex Wrench Adaptor



Ratchet Wrenches+

FOR U.S. JOBS
UNIWELD EMPLOYS OVER 300 WORKERS

Reversible & Offset Ratchet Wrenches

Double-end Reversible Ratchet Wrenches with offset design for knuckle clearance in tight work areas. Chrome plated, heat-treated alloy steel, strong gear teeth and easy-flip reversing mechanism. Packed with FREE! Dual Hex Wrench Adaptor.

70075
Heavy Duty
Offset Ratchet Wrench+
DHW316 Hex Adaptor
Hex openings:
1/2" and 9/16"
at one end;
Square openings:
1/4" and 3/16"
at other end



70075



For compressor
access valves and
Acetylene B & MC
tank valves



70074

70074
Medium Duty
Offset Ratchet Wrench+
DHW316 Hex Adaptor
Square openings:
1/4" and 3/16"
at one end;
5/16" and 3/8"
at other end



Dual Hex Wrench Adaptor

Dual Hex Wrench Adaptor for use on 3/16" and 5/16" hex liquid and suction valves on residential and commercial equipment. Fits Uniweld 70022 Reversible Ratchet Wrench, 1/4" square socket. Heat treat alloy steel, plated to prevent rust.



DHW316



Reversible Ratchet Wrench

Use for compressor access valves and Acetylene B & MC tank valves. Square opening: 1/4" and 3/16" at one end; 3/8" and 5/16" at other end.

70022



7 Tubing Tools

Inside / Outside Deburrers, Pinch-Off Tool



Deburring Tools

FOR U.S. JOBS
UNIWELD EMPLOYS OVER 300 WORKERS

The 70072 Inside/Outside Deburring Tool quickly removes burrs and sharp edges on all size tubing. A removable end cap exposes a convenient storage area for replacement blades.



70072

Used for deburring metal or PVC tubing ends, inside and out after cutting



The 70079 Inside/Outside Deburring Tool removes burrs and sharp edges with double edge steel blades. This heavy duty metal deburrer has a capacity of $\frac{1}{8}$ " to $1\frac{5}{8}$ " O.D. (3mm to 42mm).

Used for deburring metal or PVC tubing ends, inside and out after cutting



70079

Pinch-Off Tool

An effective way to isolate a piece of equipment in need of repair is to close off the tubing with the use of a Pinch-Off Tool. This works well in emergency situations that require immediate stopping of a leak. The maximum throat depth of this Pinch-Off Tool 70076 is 1" (25.4mm).

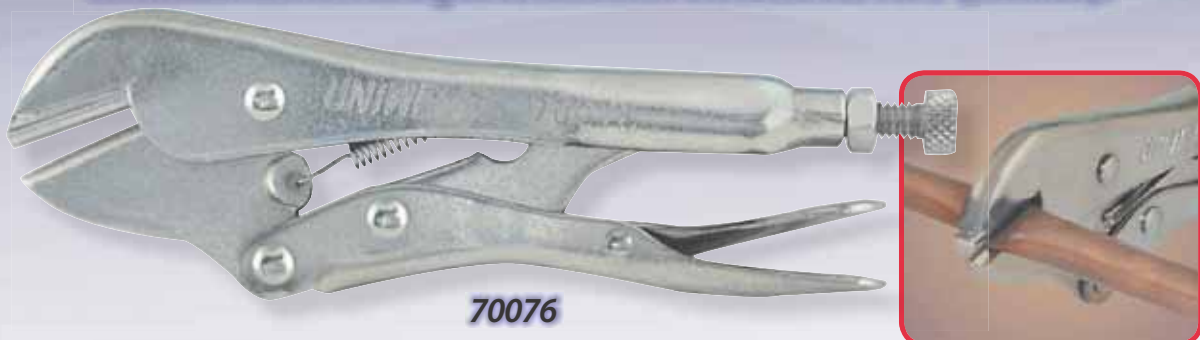

70076



Uniweild Products, Inc. Fort Lauderdale, FL 33312 U.S.A. Customer Service: 800.323.2111
info@uniweild.com • www.uniweild.com

83

Heavy Duty Flare/Burnish Tools



Flaring Tools

FOR U.S. JOBS
UNIWELD EMPLOYS OVER 300 WORKERS

The 70003 Heavy Duty Flaring Tool has a hardened steel flaring cone with a chrome finish for more uniform flares without galling. Special shaped wing nuts allow the long handle of the self-

centering yoke to be used as a lever when tightening. The hardened steel flaring bar grips tubing without scoring.

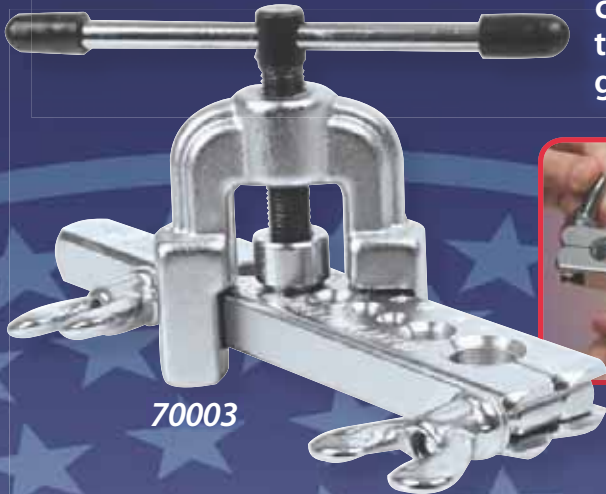

70003



For 45° flaring of 3/16", 1/4", 5/16", 3/8", 7/16", 1/2" and 5/8" O.D. soft copper, aluminum and brass tubing.

The 70004 Heavy Duty Flare/Burnish Tool has a specially designed hard chrome finish burnishing cone that automatically burnishes the flare face. The heat treated dies grip the tubing without scoring. The swivel-type yoke is self-centering.



70004



For 45° flaring of 3/16", 1/4", 5/16", 3/8", 1/2" and 5/8" O.D. soft copper, aluminum and brass tubing.



70071

The 70071 Deluxe Flaring Tool incorporates nine different sized hardened dies that rotate into position for the correct desired tube size. The compact design features a unique burnishing cone that achieves a smooth, polished flare. Heat treated dies grip the tubing without scoring or constricting.

Automatic tube height gauge shown at right.

For 45° flaring of 3/16", 1/4", 5/16", 3/8", 7/16", 1/2", 5/8", and 3/4" O.D. soft copper, aluminum and brass tubing.





Flare/Burnish/Swage Kit and Punch Type Swage Tool

Flaring/Swaging Tools

FOR U.S. JOBS
UNIWELD EMPLOYS OVER 300 WORKERS



Flare/Burnish and Swaging Tool Kit

70007



Swaging means one solder joint, not two. It now takes half the time to solder and braze the fitting with less chance of a leak.

For 45° flaring of 1/8", 3/16", 1/4", 5/16", 3/8", 7/16", 1/2", 5/8" and 3/4" O.D. soft copper, aluminum and brass tubing.



| Part# | Description | Part# | Description |
|-------|-----------------------------|-------|----------------|
| 70048 | 3/16", 1/4", 3/8" O.D. Tube | 70051 | 5/8" O.D. Tube |
| 70049 | 5/16" O.D. Tube | 70052 | 3/4" O.D. Tube |
| 70050 | 1/2" O.D. Tube | 70053 | 45° Flare |

Converts quickly to Swaging Tool with use of Swage Adaptors for 3/16", 1/4", 5/16", 3/8", 7/16", 1/2", 5/8" and 3/4" O.D. tubing. Kit with swivel-type self centering yoke fitted in plastic case with instructions.

Punch Type Swaging Tools

Designed to enlarge one end of copper tubing to make a connection without a fitting. Swaging means one solder joint, not two. It now takes half the time to solder and braze the fitting with less chance of a leak.



70006

| Part# | Description |
|-------|--|
| 70006 | Multi Swage Punch [6-in-1] 3/16", 1/4", 5/16", 3/8", 1/2", 5/8" O.D. |



70005

| Part# | Description |
|-------|---|
| 70005 | Swage Punch Kit- 5 pcs. in Vinyl Pouch 1/4", 5/16", 3/8", 1/2", 5/8" O.D. |



70046

70047

| Part# | Description |
|-------|------------------------|
| 70041 | Swage Punch 1/4" O.D. |
| 70042 | Swage Punch 5/16" O.D. |
| 70043 | Swage Punch 3/8" O.D. |
| 70044 | Swage Punch 1/2" O.D. |
| 70045 | Swage Punch 5/8" O.D. |
| 70046 | Swage Punch 3/4" O.D. |
| 70047 | Swage Punch 7/8" O.D. |



Uniweild Products, Inc. Fort Lauderdale, FL 33312 U.S.A. Customer Service: 800.323.2111
info@uniweild.com • www.uniweild.com

85



All New! Premium, Heavy Duty Tubing Cutters

FOR U.S. JOBS
UNIWELD EMPLOYS OVER 300 WORKERS

Premium Mini Cutters

UTC701



The Mini Cutter rollers are grooved to allow close cutting at flared end of tubing.



| Part# | Capacity | Application |
|--------|-----------------|---------------------------------------|
| UTC701 | 1/8" to 1" O.D. | For Copper, Brass and Aluminum Tubing |

**UTC701
MINI
TUBING
CUTTER**

FEATURES: • RUGGED CAST ALUMINUM BODY • COMPACT SIZE TO CUT IN TIGHT SPACES
• LARGE, NON-SLIP THUMBSCREW FOR PRECISE CUTTING PRESSURE CONTROL

UTC702



The sliding block design lets you cut in tight work areas.



| Part# | Capacity | Application |
|--------|---------------------|---------------------------------------|
| UTC702 | 1/8" to 1 1/8" O.D. | For Copper, Brass and Aluminum Tubing |

**UTC702
MINI
TUBING
CUTTER**

FEATURES: • RUGGED CAST ALUMINUM BODY • COMPACT SIZE TO CUT IN TIGHT SPACES
• LARGE, NON-SLIP THUMBSCREW FOR PRECISE CUTTING PRESSURE CONTROL

Premium Cutter

Handy fold-away reamer and bonus spare cutter wheel.



UTC703

| Part# | Capacity | Application |
|--------|---------------------|---------------------------------------|
| UTC703 | 1/8" to 1 3/8" O.D. | For Copper, Brass and Aluminum Tubing |

**UTC703
PREMIUM
TUBING
CUTTER**

FEATURES: • ENCLOSED TELESCOPIC FEED SCREW MECHANISM FOR SMOOTH CUTTING ACTION
• 4 ROLLER TRACKING FOR TRUE SQUARED CUT • FLARE CUT-OFF GROOVE FOR CLOSE CUTTING DAMAGED FLARE • FOLD-AWAY REAMER • SPARE CUTTER WHEEL



All New! Premium Heavy Duty/Quick-Action



Tubing Cutter

FOR U.S. JOBS
UNIWELD EMPLOYS OVER 300 WORKERS



Premium Cutter

UTC704

Use the built-in deburrer for smooth, tight fitting cut edges

| Part# | Capacity | Application |
|--------|---------------------|---------------------------------------|
| UTC704 | 1/8" to 1 3/4" O.D. | For Copper, Brass and Aluminum Tubing |

**UTC704
PREMIUM
TUBING
CUTTER**

- FEATURES:
- ENCLOSED TELESCOPIC FEED SCREW MECHANISM FOR SMOOTH CUTTING ACTION
 - 4 ROLLER TRACKING FOR TRUE SQUARED CUT
 - FLARE CUT-OFF GROOVE FOR CLOSE CUTTING DAMAGED FLARE
 - BUILT IN DEBURRING TOOL
 - SPARE CUTTER WHEEL

Quick-Action Premium Cutter

The spring loaded ratchet cutter wheel feeding system enables quick-action contact/release for tubing size adjustment. Two small and two large rollers ensure true square cut on the smallest and the largest tubing capacities. For cutting brass, aluminum and copper tubing.



UTC705

Quick-action, spring loaded mechanism adjusts and releases for tubing size changes.

| Part# | Capacity | Application |
|--------|---------------------|---------------------------------------|
| UTC705 | 1/4" to 2 3/4" O.D. | For Copper, Brass and Aluminum Tubing |

**UTC705
PREMIUM
TUBING
CUTTER**

- FEATURES:
- 4 ROLLER TRACKING FOR TRUE SQUARE CUT
 - REMOVABLE DEBURRER
 - SPARE CUTTER WHEEL

**REPLACEMENT
PARTS**

| Part# | Description |
|--------|--|
| UTC706 | • 2 Cutter Wheels • Holder Axle • C-clip |

Replacement Parts for: UTC701, UTC702, UTC703, UTC704, UTC705

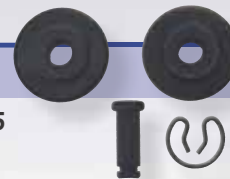

Uniweld Products, Inc. Fort Lauderdale, FL 33312 U.S.A. Customer Service: 800.323.2111
info@uniweld.com • www.uniweld.com

87

Standard and Mini Tubing Cutters



Tubing Cutters

FOR U.S. JOBS
UNIWELD EMPLOYS OVER 300 WORKERS

Precision feed screw mechanism that is enclosed to eliminate clogging and jamming for trouble-free performance. These tube cutters maintain the same length for accurate cutting of copper, brass and aluminum tubing in restricted spaces. The rollers are grooved for cutting close to flared end of tubing. A deburrer/reamer and spare cutter wheel are included.

8 Tubing Tools

70090



$\frac{5}{16}$ " to $1\frac{5}{8}$ " O.D.
(8mm to 42mm)

70090 includes a removable deburring tool for removing sharp edges from tubing. (Replacement #70091)



70001 includes a fold-away reamer tool for removing sharp edges from tubing.

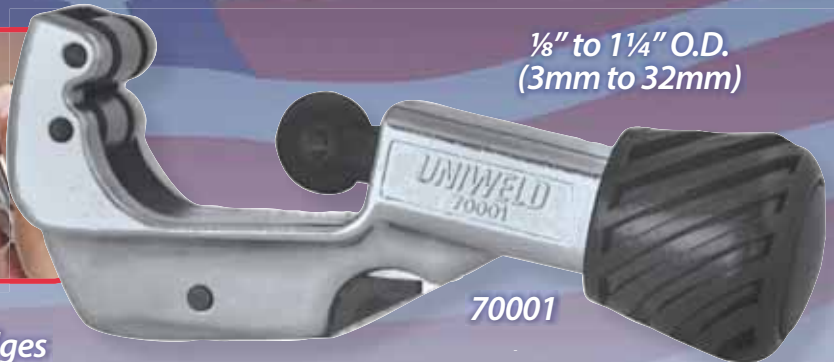

$\frac{1}{8}$ " to $1\frac{1}{4}$ " O.D.
(3mm to 32mm)

70001



$\frac{1}{8}$ " to $\frac{7}{8}$ " O.D.
(3mm to 22mm)

Mini Tubing Cutters

Compact body and sliding block design for use in restricted areas. The large, knurled feed screw knob provides precision adjustments. The rollers are grooved for cutting close to flared end of tubing. For copper, brass and aluminum tubing.



$\frac{1}{4}$ " to $1\frac{1}{8}$ " O.D.
(6mm to 28mm)
Spare Cutter Wheel



Quick Action Tubing Cutter

Tubing Cutter

FOR U.S. JOBS
UNIWELD EMPLOYS OVER 300 WORKERS

The spring loaded ratchet cutter wheel feeding system enables quick-action contact/release for tubing size adjustment. Two small and two large rollers ensure perfect cutting action on the smallest and the largest tubing capacities. For cutting brass, aluminum and copper tubing.

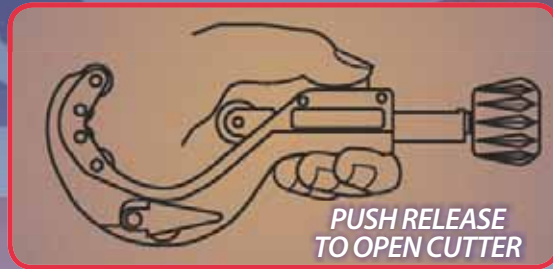
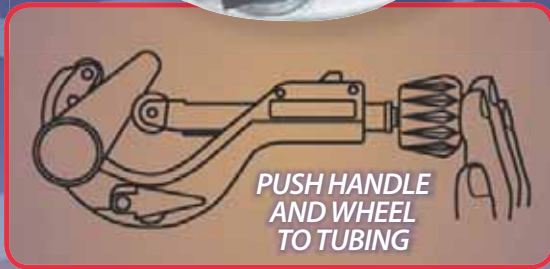
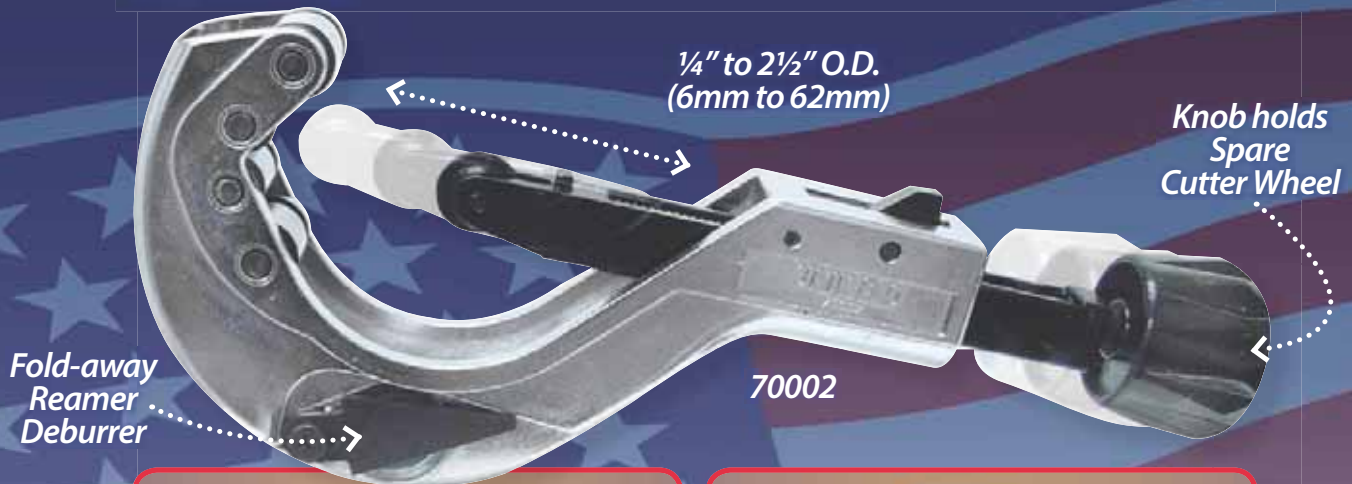

8 Tubing Tools

70054 Empty Kit Box (with card)

| | Tubing Cutter | Cutter Wheel Display Pkg. | Cutter Wheel Bulk Pkg. | Cutter Wheel Screw |
|--|---------------|---------------------------|------------------------|------------------------|
| Tubing Cutter Replacement Parts | 70000 | 70025 | 70029 | 70032 |
| | 70001 | 70025 | 70029 | 70032 |
| | 70002 | 70027 | 70031 | 70035 |
| | 70024 | 70025 | 70029 | *[A] 70038 **[B] 70039 |
| | 70090 | 70027 | 70031 | 70035 |

*[A] Holder Axle, **[B] Clip



70040
Tubing Cutter Parts Kit
Includes: 6 each: 70031, 70035, 70038, 70039
12 each: 70029, 70032



Uniweld Products, Inc. Fort Lauderdale, FL 33312 U.S.A. Customer Service: 800.323.2111
info@uniweld.com • www.uniweld.com

CrossBow™ Tube Bender/Spring Benders



Ratchet Tube Bender

FOR U.S. JOBS
UNIWELD EMPLOYS OVER 300 WORKERS

Uniweld's CrossBow™ Ratchet Tube Bender enables plumbers and HVAC/R technicians to make precision bends up to 90° with soft copper and aluminum tubing. The low friction mandrels and rotating side support blocks provide precision bending in restricted spaces. Bend tubing sizes: 3/8", 1/2", 5/8", 3/4", 7/8", 1 1/8" O.D. You can produce bends with minimum distortion for optimal flow. Repeated alternate angled bends are possible with the CrossBow™ Ratchet Tube Bender, housed in a rugged plastic carrying case.

8 Tubing Tools



*CrossBow Kit includes:
6 interchangeable
mandrels; 3 rotating
side support block bars;
1 ratchet bender;
plastic carrying case
and instructions*



RTB118

*Minimum
distortion
bends up
to 90°*

Part# Description

| | |
|----------|--|
| RTB118 | Crossbow Ratchet Tube Bender, Sizes: 3/8", 1/2", 5/8", 3/4", 7/8", 1 1/8" O.D. |
| RTBCA118 | 1 1/8" Crossbar Assembly |
| RTBCA58 | 3/8", 1/2" and 5/8" Crossbar Assembly |
| RTBCA78 | 3/4" and 7/8" Crossbar Assembly |
| RTBM118 | 1 1/8" Mandrel for Crossbow Ratchet Tube Bender |
| RTBM12 | 1/2" Mandrel for Crossbow Ratchet Tube Bender |
| RTBM34 | 3/4" Mandrel for Crossbow Ratchet Tube Bender |
| RTBM38 | 5/8" Mandrel for Crossbow Ratchet Tube Bender |
| RTBM58 | 3/8" Mandrel for Crossbow Ratchet Tube Bender |
| RTBM78 | 7/8" Mandrel for Crossbow Ratchet Tube Bender |
| RTBR | Crossbow Ratchet Tube Bender Body Assembly |
| RTBRC | Crossbow Ratchet Tube Bender Replacement Case |



70028
Spring Bender
Set

Spring Tube Benders

Free-form bending of soft copper and aluminum tubing with Uniweld Spring Tube Benders. Spring slips over tubing and prevents collapsing of tube walls during bending. Achieve fast and professional bends.

Part# Description

| | |
|-------|--|
| 70028 | Bending Spring Set [4 Sizes] 1/4", 3/8", 1/2", 5/8" O.D. |
| 70016 | Bending Spring 1/4" O.D. [0.64 cm] |
| 70017 | Bending Spring 5/16" O.D. [0.79 cm] |
| 70018 | Bending Spring 3/8" O.D. [0.95 cm] |
| 70019 | Bending Spring 1/2" O.D. [1.27 cm] |
| 70020 | Bending Spring 5/8" O.D. [1.59 cm] |
| 70021 | Bending Spring 3/4" O.D. [1.90 cm] |

90



Uniweld Products, Inc. Fort Lauderdale, FL 33312 U.S.A. Customer Service: 800.323.2111
info@uniweld.com • www.uniweld.com



3-in-1 Triple Tube Bender/Lever Benders

Tubing Benders

FOR U.S. JOBS
UNIWELD EMPLOYS OVER 300 WORKERS

The Uniweld 3-in-1 Triple Tube Bender is a compact and durable tool with multiple bending channels that is capable of bending 1/4", 5/16" and 3/8" O.D. soft copper, aluminum and soft stainless steel tubing. Calibrated markings show angle of bend for accurate left hand, right hand and offset bends up to 180°. 1" bend radius.

3-in-1 Triple Tube Bender

70010

70015

Lever Type Tube Benders



INSERT AND POSITION TUBING



SWING BENDER HANDLE INTO POSITION



BEGIN TUBING BEND



FINISH BEND

70014

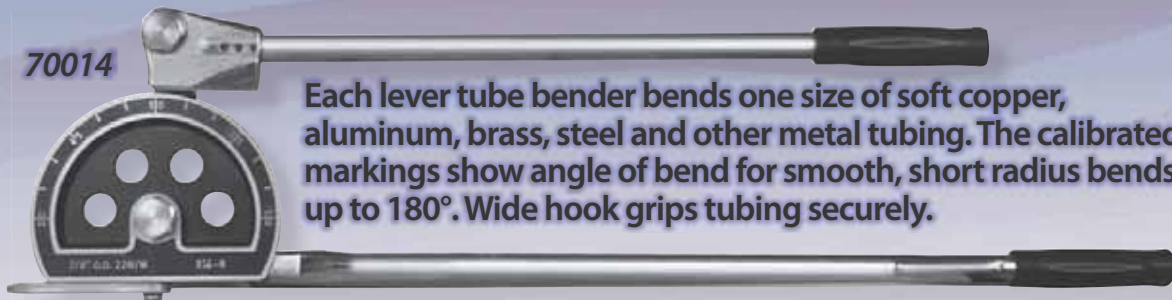

Each lever tube bender bends one size of soft copper, aluminum, brass, steel and other metal tubing. The calibrated markings show angle of bend for smooth, short radius bends up to 180°. Wide hook grips tubing securely.

| Part# | Description | Tube Diam. | Bend Radius | Part# | Description | Tube Diam. | Bend Radius | Part# | Replacement Part |
|-------|-------------|------------|-------------|-------|-------------|------------|-------------|-------|--------------------------------|
| 70009 | Bender | 5/16" O.D. | 1 1/16" | 70012 | Bender | 5/8" O.D. | 2 1/4" | 70082 | Hook for 70012 Bender |
| 70010 | Bender | 3/8" O.D. | 1" | 70013 | Bender | 3/4" O.D. | 3" | 70083 | Hook for 70013 Bender |
| 70011 | Bender | 1/2" O.D. | 1 1/2" | 70014 | Bender | 7/8" O.D. | 3 1/4" | 70084 | Hook for 70014 Bender |
| | | | | | | | | 70085 | Washer for 70086 |
| | | | | | | | | 70086 | Screw for 70082, 70083 & 70084 |

8 Tubing Tools



Uniweld Products, Inc. Fort Lauderdale, FL 33312 U.S.A. Customer Service: 800.323.2111
info@uniweld.com • www.uniweld.com

91



Gas Pressure Test Kit/Water Manometer

Check your Pressure

FOR U.S. JOBS
UNIWELD EMPLOYS OVER 300 WORKERS

This precision test kit includes a sensitive diaphragm gauge that is calibrated in inches of water column for extreme accuracy. Convenient to use without the mess of water or worry of mercury. Uniweld developed the 0-15" W.C. Gas Test Kit to accurately accommodate both natural gas at 3-4" W.C. and LP gas at 11-12" W.C.; eliminating the need for two separate kits.

Use these accurate kits to measure gas pressure across appliance manifolds. Test gas stoves, furnaces, dryers and other gas appliances.



A new Uniweld design feature allows you to easily zero reset the gauge needle by simply twisting open the dial lens to access the adjusting screw located on the dial face.



45503
Gas Pressure
Test Kit

| Part# | Description |
|-------|---|
| 45503 | Scale: 0-35" W.C., 0-20 oz./In ² |
| 45506 | Scale: 0-15" W.C., 8.6 oz./In ² |

| Part# | Description | Replacement Parts | Part# | Description |
|-------|-------------------------------------|-------------------|-------|---------------|
| 45595 | Brass Fitting, Barbed x 1/8" M.P.T. | | 45598 | Gauge Lens |
| 45596 | Rubber Nipple | | 45599 | Carrying Case |
| 45597 | Black Rubber Hose | | | |

Uniweld Gas Pressure Test Kits include: A Diaphragm Gauge that accurately sets manifold pressure for Natural or LP gas; a Brass Fitting (barbed x 1/8" M.P.T.) and rubber tube with nipple for easy connection; Molded Plastic Case; Instructions.

Water Manometer

An economical way to check/set manifold pressure in furnaces and gas appliances that use Natural or LP gas. Fill with water to zero and place in vertical position using the included magnet. Attach fitting to manifold and begin pressure test. Pressure reading (from 0-15" water column) is shown in small tube.



11482

9 Gauges

92



Uniweld Products, Inc. Fort Lauderdale, FL 33312 U.S.A. Customer Service: 800.323.2111
info@uniweld.com • www.uniweld.com

Bottom Mount/Center Back Mount/Lower Back Mount



Tridicators

FOR U.S. JOBS
UNIWELD EMPLOYS OVER 300 WORKERS

Designed primarily for hot water boiler systems. Two instruments in one...you can measure water pressure in PSI and H₂O feet, plus monitor temperature in °F and °C.

3½" Tridicator has adjustable lens with indicator mark.

Round Tridicator Gauges

Large 2½" and 3½" round dials available in bottom and center back mount.



GT565

Center Back Mount x 2" Extension

GT566 Bottom Mount

GT512-2 Bottom Mount



3½" Square Tridicator Gauges

Large 3½" square dials available in bottom mount and lower back mount.

GT562-2 Lower Back Mount



| Part# | UPC# | Description |
|---------|-------|--|
| GT512-2 | 69116 | 3½" Square Tridicator, 0-60 PSI, 0-400 kPa and 70-250 °F, 20-120 °C, ½" NPT B.M. |
| GT562-2 | 69117 | 3½" Square Tridicator, 0-60 PSI, 0-400 kPa and 70-250 °F, 20-120 °C, ½" NPT L.B.M. |
| GT565 | 69130 | 2½" Round Tridicator, 0-75 PSI/170 ft. H ₂ O, 60-260 °F/20-120 °C, ¼" NPT C.B.M. x 2" Extension |
| GT566 | 69131 | 2½" Round Tridicator, 0-75 PSI/170 ft. H ₂ O, 60-260 °F/20-120 °C, ¼" NPT C.B.M. |
| GT568 | 69133 | 3½" [80mm] Round Tridicator, 0-75 PSI/170 ft. H ₂ O, 60-260 °F/20-120 °C, ½" NPT B.M. |

Pocket Bi-Metal Thermometer

Pocket Thermometer with 1" dial and stainless steel case. Color-coded °F and °C dial face. Stainless steel 5" pointed stem. Field calibration.

69901
-40°F to 160°F
-40°C to 70°C



69902
-0°F to 220°F
-10°C to 104°C



Protective sheath with pocket clip



Uniweild Products, Inc. Fort Lauderdale, FL 33312 U.S.A. Customer Service: 800.323.2111
info@uniweild.com • www.uniweild.com

93

Top Mount and Side Mount Gauges/Water Test Gauges



Gas Test Gauges

FOR U.S. JOBS
UNIWELD EMPLOYS OVER 300 WORKERS

Use to pressure test all new installations for leaks and inspection codes. After installation and the system has been pressurized, the leakage will be indicated by a pressure drop on the gauge.



| Gauge | Replacement Gauges | 1/2" FPT | | *Top Mount 3/4" FPT | | 1" FPT | | Side Mount 3/4" FPT | |
|--|--------------------|----------|---------|---------------------|---------|---------|---------|---------------------|---------|
| | | Box | Display | Box | Display | Box | Display | Box | Display |
| **0-5 psi/in. ² -140" W.C. 360 mb [2.5" (63mm)] | GD308 | TGB205 | 41302 | TGB5 | 41355 | TGB105 | 41402 | TGH5 | 41458 |
| 15 psi, 2" 1/10 lb. incr. Full Scale | GP210-5 | TGB215 | 41304 | TGB15 | 41353 | TGB115 | 41404 | TGH15 | 41453 |
| 30 psi, 1/4 lb. incr., 2" | GP211-5 | TGB230 | 41305 | TGB30 | 41354 | TGB130 | 41405 | TGH30 | 41456 |
| 60 psi, 1 lb. incr., 2" | GP212-5 | TGB260 | 41306 | TGB60 | 41356 | TGB160 | 41406 | TGH60 | 41459 |
| 100 psi, 1 lb. incr., 2" | GP213-5 | TGB2100 | 41303 | TGB100 | 41352 | TGB1100 | 41403 | TGH100 | 41452 |
| **0-6 psi/1/10 lb., 0-12 in. of Mercury, 4" [100mm] | GD408IP | TGB206 | 41307 | TGB6 | 41357 | TGB106 | 41407 | TGH6 | 41460 |
| 0-15 psi/1/10 lb., 0-30 in. of Mercury, 4" [100mm] | GS410-51P | TGB4215 | 41308 | TGB415 | 41358 | TGB4115 | 41408 | TGH415 | 41461 |

**Special sensitive 2 1/2" diaphragm gauge for more accurate low pressure reading.

* Uniweld reserves the right to use either plated steel or an aluminum hex body when supplying a top mount gas test gauge assembly.

9 Gauges

Water Test Gauges

| Part# | Description | Replacement Parts and Gauges | Description |
|----------|---|------------------------------|--|
| TGW300 | Water test gauge with 3/4" female hose connection, 2 1/2" gauge, 300 PSI | TGW | 3/4" FHT x 3/4" female NPT connection only |
| TGW300DP | Water test gauge with 3/4" female hose connection, 2 1/2" gauge, 300 PSI Drag Pointer | GS316-5 | 2 1/2", 300 PSI, 12 o'clock dial |
| TGW160 | Water Test gauge with 3/4" female hose connection, 2 1/2" gauge, 160 PSI | GS316-5DP | 2 1/2", 300 PSI, 12 o'clock dial, Drag Pointer |

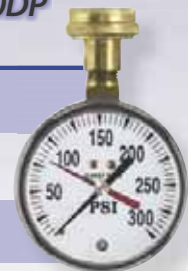

94



Uniweld Products, Inc. Fort Lauderdale, FL 33312 U.S.A. Customer Service: 800.323.2111
info@uniweld.com • www.uniweld.com



Plastic and Steel Cased Utility Gauges

FOR U.S. JOBS
UNIWELD EMPLOYS OVER 300 WORKERS

Versatile, accurate and durable, these general purpose utility gauges are suitable for use on pressure media that are non-corrosive to brass or bronze. They are fitted with either bottom mount (BM) or center back mount (CBM) connections and are available in black plastic or black steel cases.

| Pressure Range | 1 1/2" Diameter | | | | 2" Diameter | | | | 2 1/2" Diameter | |
|----------------|-----------------------------|--------------------------------|-----------------------------|--------------------------------|-----------------------------|--------------------------------|-----------------------------|--------------------------------|-----------------------------|--------------------------------|
| | Black Steel Case 1/8" BM | Black Plastic Case 1/8" CBM | Black Steel Case 1/8" BM | Black Plastic Case 1/8" CBM | Black Steel Case 1/4" BM | Black Plastic Case 1/4" CBM | Black Steel Case 1/4" BM | Black Plastic Case 1/4" CBM | Black Steel Case 1/4" BM | Black Plastic Case 1/4" CBM |
| | Part# | Part# | Part# | Part# | Part# | Part# | Part# | Part# | Part# | Part# |
| Hg PSI | | | | | | | | | | |
| 30" Hg+ | GS100 | GS150 | GP100 | GP150 | GS200 | GS250 | GP200 | GP250 | GS300 | GS350 |
| 30" Hg | GS108 | GS158 | - | - | GS208 | GS258 | - | - | GS308 | GS358 |
| 30" - 15 | GS101 | GS151 | - | - | GS201 | GS251 | - | - | GS301 | GS351 |
| 30" - 30 | GS102 | GS152 | - | - | GS202 | GS252 | - | - | GS302 | GS352 |
| 30" - 60 | - | - | - | - | - | - | - | - | GS303 | GS353 |
| 30" - 100 | - | - | - | - | - | - | - | - | GS304 | GS354 |
| 30" - 150 | - | - | - | - | GS205 | GS255 | - | - | GS305 | GS355 |
| PSI | | | | | | | | | | |
| 15 | GS109 | GS159 | - | - | GS209 | GS259 | - | - | GS309 | GS359 |
| 15+ | GS110 | GS160 | GP110 | GP160 | GS210 | GS260 | GP210 | - | GS310 | GS360 |
| .1 lb. incr. | - | - | - | - | GS210-5 | - | GP210-5 | - | - | - |
| 30 | GS111 | GS161 | GP111 | GP161 | GS211 | GS261 | GP211 | - | GS311 | GS361 |
| .25 lb. incr. | - | - | - | - | GS211-5 | - | GP211-5 | - | - | - |
| 60 | GS112 | GS162 | GP112 | GP162 | GS212 | GS262 | GP212 | - | GS312 | GS362 |
| 1 lb. incr. | - | - | - | - | GS212-5 | - | GP212-5 | - | - | - |
| 100 | GS113 | GS163 | GP113 | GP163 | GS213 | GS263 | GP213 | - | GS313 | GS363 |
| 1 lb. incr. | - | - | - | - | GS213-5 | - | GP213-5 | - | - | - |
| 160 | GS114 | GS164 | GP114 | GP164 | GS214 | GS264 | GP214 | GP264 | GS314 | GS364 |
| 200 | GS115 | GS165 | GP115 | GP165 | GS215 | GS265 | GP215 | GP265 | GS315 | GS365 |
| 300 | GS116 | GS166 | GP116 | GP166 | GS216 | GS266 | GP216 | GP266 | GS316 | GS366 |
| 400 | GS117 | GS167 | GP117 | GP167 | GS217 | GS267 | GP217 | GP267 | GS317 | GS367 |
| 600 | GS118 | GS168 | - | - | GS218 | GS268 | - | - | GS318 | GS368 |
| 1000 | GS119 | GS169 | - | - | GS219 | GS269 | - | - | GS319 | GS369 |
| 1500* | GS120 | GS170 | - | - | GS220 | GS270 | - | - | GS320 | GS370 |
| 2000* | GS121 | GS171 | - | - | GS221 | GS271 | - | - | GS321 | GS371 |
| 3000* | GS122 | GS172 | - | - | GS222 | GS272 | - | - | GS322 | GS372 |
| 4000* | GS123 | GS173 | - | - | GS223 | GS273 | - | - | GS323 | GS373 |
| 5000* | GS124 | GS174 | - | - | GS224 | GS274 | - | - | GS324 | GS374 |
| 6000* | - | - | - | - | GS225 | GS275 | - | - | GS325 | GS375 |

NOTE: The following alternate options are available: [1] Stainless steel case in 1 1/2" or 2" diameter with CBM or BM connections. To order, change "GS" to "GSC". [2] Panel mount in black steel with post-lock lens and CBM connections. To order, change "GS" to "PP". [3] 1 1/2" "PP" gauge available with chrome plated ring. To order, change "GS" to "PC". We reserve the right to send dual scaled gauges. If dual scales required, add the suffix [-1] for PSI-kg/cm², [-2] for PSI-kPa [-3] for PSI-Bar. Many other options available. Call for more information. Shipped individually boxed. Add "D" to Part# for display card. Individually boxed gauges will have a UPC#, if requested.

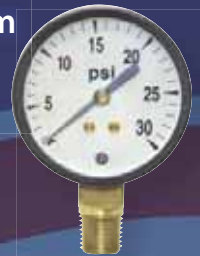

1/4" NPT • BM
2" diam. Black Steel Case



1/8" NPT • CBM
1 1/2" diam. Black Plastic Case



1/8" NPT • CBM
1 1/2" diam. Black Steel Case



1/4" NPT • BM
2 1/2" diam. Black Steel Case

2" High Pressure CO₂ Gauges Black Steel Case

2" High Pressure Gauge with red zone for gas order alert. For use with CO₂ or other compressed gases. 1/4" NPT.

☎ Listed.

| Part# | UPC# | Description |
|-------|-------|-----------------------------|
| GS241 | 51241 | Bottom Mount [RHT] 3000 PSI |
| GS242 | 51242 | Bottom Mount [LHT] 3000 PSI |
| GS243 | 51243 | Side Mount [RHT] 3000 PSI |
| GS244 | 51244 | Side Mount [LHT] 3000 PSI |



GS243

RHT - Right Hand Thread
LHT - Left Hand Thread
Not for Oxygen service



Uniweld Products, Inc. Fort Lauderdale, FL 33312 U.S.A. Customer Service: 800.323.2111
info@uniweld.com • www.uniweld.com

95

9 Gauges



Liquid Filled/Flowgauges/Medical Gauges

Liquid Filled Gauges

FORT U.S. JOBS
UNIWELED EMPLOYS OVER 300 WORKERS

Liquid fill (Glycerine) dampens the damaging effects of excessive vibration and pulsation while providing continuous lubrication of the internals; helping to prevent corrosion. Meets (A.N.S.I. B40.1) Grade B for accuracy. Normal operating pressure range is -14°F to 140°F.



2 1/2"
(63mm)
Gauge
1/4" NPT
Bottom
Mount

GSL311-3

| Part# | UPC# | Pressure Range | Part# | UPC# | Pressure Range |
|----------|-------|--------------------------------------|----------|-------|------------------------------|
| GSL301-3 | 69103 | 30" Hg - 0 - 15 PSI [-1 - 0 - 1 Bar] | GSL316-3 | 69113 | 0 - 300 PSI [0 - 20 Bar] |
| GSL302-3 | 69104 | 30" Hg - 0 - 30 PSI [-1 - 0 - 2 Bar] | GSL317-3 | 69114 | 0 - 400 PSI [0 - 27 Bar] |
| GSL303-3 | 69105 | 30" Hg - 0 - 60 PSI [-1 - 0 - 4 Bar] | GSL318-3 | 69115 | 0 - 600 PSI [0 - 40 Bar] |
| GSL308-3 | 69106 | 30" Hg Vac. [0 to - 1 Bar] | GSL319-3 | 69118 | 0 - 1000 PSI [0 - 70 Bar] |
| GSL309-3 | 69107 | 0 - 15 PSI [0 - 1 Bar] | GSL320-3 | 69119 | 0 - 1500 PSI [0 - 100 Bar] |
| GSL311-3 | 69108 | 0 - 30 PSI [0 - 2 Bar] | GSL321-3 | 69120 | 0 - 2000 PSI [0 - 140 Bar] |
| GSL312-3 | 69109 | 0 - 60 PSI [0 - 4 Bar] | GSL322-3 | 69121 | 0 - 3000 PSI [0 - 200 Bar] |
| GSL313-3 | 69110 | 0 - 100 PSI [0 - 7 Bar] | GSL324-3 | 69122 | 0 - 5000 PSI [0 - 350 Bar] |
| GSL314-3 | 69111 | 0 - 160 PSI [0 - 11 Bar] | GSL325-3 | 69123 | 0 - 6000 PSI [0 - 400 Bar] |
| GSL315-3 | 69112 | 0 - 200 PSI [0 - 14 Bar] | GSL327-3 | 69124 | 0 - 10,000 PSI [0 - 700 Bar] |



G51D

Flowgauges and Medical Gauges

Uniweled Flowgauges are designed for MIG and TIG welding applications. Uniweled Medical Gauges are designed for medical gas delivery systems in hospitals and in the home.



Green
Face with
White
increments

G55D

| Part# | UPC# | Flow Gauges |
|---------------------|-------|--|
| G51D | 54104 | 1 1/2" Gauges [1/8" NPT] Steel Case 40 SCFH, Argon, AR/CO ₂ MIX [75%-25%] Calibrated for 71 Dr./ .026 Orifice [60 PSI Max.] |
| G87D | 54104 | 1 1/2" Gauges [1/8" NPT] Steel Case 10-40 SCFH, CO ₂ Calibrated for 71 Dr./ .026 Orifice [60 PSI Max.] |
| G76D | 54217 | 2" Gauges [1/4" NPT] Brass Case 10-50 SCFH, AR/CO ₂ MIX [75%-25%] Calibrated for 67 Dr./ .032 Orifice [60 PSI Max.] |
| Flowgauges G77D | 54219 | 2" Gauges [1/4" NPT] Brass Case 20-100 SCFH, CO ₂ Calibrated for 67 Dr./ .032 Orifice [60 PSI Max.] |
| G86D | 54222 | 2" Gauges [1/4" NPT] Brass Case 10-50 SCFH, CO ₂ Calibrated for 69 Dr./ .029 Orifice [60 PSI Max.] |
| G76SD | 54217 | 2" Gauges [1/4" NPT] Steel Case 10-50 SCFH, AR/CO ₂ MIX [75%-25%] Calibrated for 67 Dr./ .032 Orifice [60 PSI Max.] |
| G77SD | 54219 | 2" Gauges [1/4" NPT] Steel Case 20-100 SCFH, CO ₂ Calibrated for 67 Dr./ .032 Orifice [60 PSI Max.] |
| G86SD | 54222 | 2" Gauges [1/4" NPT] Steel Case 10-50 SCFH, CO ₂ Calibrated for 69 Dr./ .029 Orifice [60 PSI Max.] |
| Medical Gauges G55D | 54106 | 1 1/2" Gauges [1/8" NPT] Chromed Case 15 LPM, Plated Socket, Oxy Calibr. for 73 Dr./ .024 Orifice [60 PSI Max.] |
| G54D | 54105 | 1 1/2" Gauges [1/8" NPT] Chromed Case, Plated Socket 4000 PSI. |
| G62D | 54211 | 2" Gauges [1/8" NPT] Chromed Case 15 LPM, Plated Socket, Oxy Calibr. for 77 Dr./ .018 Orifice [120 PSI Max.] |
| G63D | 54212 | 2" Gauges [1/8" NPT] Chromed Case, Plated Socket 4000 PSI. |





Replacement Gauges/Lenses/Boots

Welding Gauges

FOR U.S. JOBS
UNIWELD EMPLOYS OVER 300 WORKERS



G15D



PSI Only



**PSI/Kg
Add (-1)
to Part#**



**PSI/kPa
Add (-2)
to Part#**

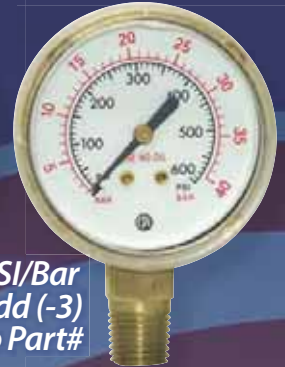

**PSI/Bar
Add (-3)
to Part#**

1 1/2" GAUGES [1/8" NPT]

2" GAUGES [1/4" NPT**]

2 1/2" GAUGES [1/4" NPT**]

Pressure
Calibration

Powder Painted
Steel Case
B.M.

Gold
Steel Case
B.M.

Gold
Steel Case
C.B.M.

Brass
Case
B.M.

Brass
Case
C.B.M.
WITH WEEP HOLE

Gold
Steel Case
B.M.

Brass
Case
B.M.

Gold
Steel Case
B.M.

| | |
|-------------------------|---------------|
| 15 PSI | - |
| 30 PSI [Red Line 15-30] | G15D* (Red) |
| 30 PSI | - |
| 60 PSI | - |
| 100 PSI | G49D* (Green) |
| 200 PSI | - |
| 300 PSI | - |
| 400 PSI | - |
| 1/4, 1/2, 3/4 CONTENTS | G19D* (Red) |
| 600 PSI | - |
| 1000 PSI | - |
| 4000 PSI, LISTED | G56D* (Green) |
| 6000 PSI, LISTED | - |

| | | | | | | | | |
|--|---------------|-------------|------|------|------|-------|------|-------|
| | - | G20D [BLUE] | - | - | - | - | - | - |
| | G15D* (Red) | G79D* | - | G2D | - | G2SD | G22D | G22SD |
| | - | G80D* | - | G74D | - | G74SD | G75D | G75SD |
| | - | G83D* | - | G5D | G105 | G5SD | G25D | G25SD |
| | G49D* (Green) | G85D* | G185 | G6D | G106 | G6SD | G26D | G26SD |
| | - | G78D* | G178 | G4D | G104 | G4SD | G24D | G24SD |
| | - | G84D* | G184 | G33D | - | G33SD | - | - |
| | - | G73D* | - | G1D | G101 | G1SD | G21D | G21SD |
| | G19D* (Red) | - | - | - | - | - | - | - |
| | - | - | - | G8D | G108 | G8SD | G28D | G28SD |
| | - | - | - | G34D | - | G34SD | - | - |
| | G56D* (Green) | G82D* | G182 | G7D | - | G7SD | G27D | G27SD |
| | - | - | - | G44D | - | G44SD | G46D | G46SD |

B.M. = Bottom Mount. C.B.M. = Center Back Mount. * With Gauge Boot.
** For 1/8" NPT add [-4] to Part Number.



**1 1/2"
Gauge
Boot Set
Black**

GB15S

Replacement Lenses



**GB20S
2"
Gauge
Boot Set
Black**

| | Part# | 1 1/2" Description | Part# | 2" Description | Part# | 2 1/2" Description |
|---------------------|------------------|--------------------|------------------|----------------|------------------|--------------------|
| DISPLAY CARD | PL15 | Posi-Lock | PL2 | Posi-Lock | PL25 | Posi-Lock |
| BULK | 05-1-52 | Flat Plastic | 05-2-52-4 | Flat Plastic | | |
| | 05-1-52-7 | Posi-Lock | 05-2-52-7 | Posi-Lock | 05-3-52-8 | Posi-Lock |
| | 05-1-63 | Friction Ring | 05-2-63-2 | Friction Ring | | |



Uniweild Products, Inc. Fort Lauderdale, FL 33312 U.S.A. Customer Service: 800.323.2111
info@uniweild.com • www.uniweild.com

97

9 Gauges



Soft Solder and Self Fluxing Aluminum Alloys

FOR U.S. JOBS
UNIWELD EMPLOYS OVER 300 WORKERS

Uniweld's UNI-4300 aluminum soft solder kit with metal tip flux applicator is a great solution for the service technician who is frequently confronted with the task of repairing or joining aluminum to aluminum and aluminum to copper or brass. A common repair problem occurs when an air conditioning system's evaporator coil develops a small pinhole leak.

UNI-4300 is an excellent product for this repair application due to its low melting point of 500 °F [260 °C] and 20,000 PSI tensile strength.

JOINS
ALUMINUM
COPPER
AND
BRASS

For best results, prepare the tubing by cleaning the surface and removing any oil, grease and oxides. To remove the oil and grease, use a chemical solvent. The oxides should be removed using only a stainless steel wire brush or emery cloth.

TUBING SURFACES MUST BE CLEAN.

When making a repair on an evaporator coil, it will be necessary to preheat the tubing prior to applying the flux. A common mistake when making this type of repair is to apply the flux and then begin heating the tubing. The evaporator coil disperses the heat and the tubing never reaches the melting temperature of the alloy. The flux then overheats and burns, then becomes an inhibitor that doesn't allow the alloy to bond properly to the base metal.

Preheat the evaporator tubing and then apply the flux using the metal tip flux applicator. Continue applying heat until the flux starts to bubble and then apply the UNI-4300 solder into the area being repaired.

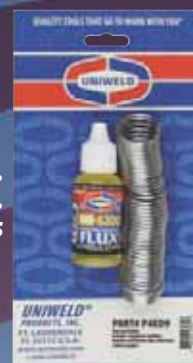

P4KD9



P4KD9S



UNI-4200 Self Fluxing Aluminum Rods

Used for joining and repairing aluminum extrusions and castings. Also can be used for the manufacture and repair of aluminum doors and windows, repairing ladders, gutters, siding, aluminum boats and instrument boxes. Most kirk-site and zinc based dies can be repaired with this alloy. May also be used as wear-facing alloy on aluminum.



P3KH9

| Part# | Description |
|--------|---|
| P3KH9 | UNI-4200 Self fluxing Aluminum rods |
| P4KD9S | UNI-4300 Aluminum solder [10 ft. coil] with a 2 oz. flux bottle & metal tip flux applicator |
| P4KD9 | UNI-4300 Aluminum solder [10 ft. coil] with a 1 oz. flux bottle |
| F6CYAK | UNI-4300 2 oz. flux bottle |
| F6CYL | UNI-4300 1 oz. flux bottle |



Silver Bearing Solder and Brazing Alloy



Alloys

FOR U.S. JOBS
UNIWELED EMPLOYS OVER 300 WORKERS

10 Alloys

UNIBRITE 1450A Acid Flux Cored Silver Bearing Solder

Uni-brite is a high strength acid core silver bearing soft solder. Free of cadmium, zinc, lead or antimony. Can be used on most alloys including copper, brass, stainless steel and nickel. A low working temperature of 430 °F [221 °C] eliminates weakening of the base metal caused by high heat brazing, resulting in greater overall strength of the components being joined.



| Product | Description | Solidus Melting Point |
|---------------------------------|-------------|-----------------------|
| B1KD9 UNIBRITE 1450A | 1/16" X 10' | 430 °F [221 °C] |

UNI-1450 Soft Soldering Flux #F4CYG

A heavy duty liquid soft soldering flux that removes oxidation from surfaces to be soldered and improves wetting characteristics of the liquid solder.

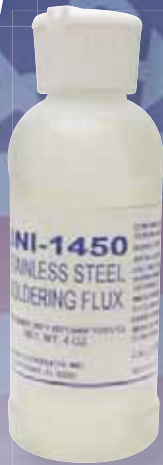

F4CYG
4 oz.
Bottle

UNI-1000 Silver Brazing Flux #F19YJ

Use with Phos-Copper silver brazing alloys when joining dissimilar base metals such as Copper to Brass
Active Range:
1000 °F - 1800 °F
(538 °C - 982 °C)



**UNI-BRITE
1450A**

F19YJ
7 oz. Jar

PPLI OR
RUS IN P

UNI-1500FC (Flux Coated) Low Fuming Bronze Brazing Alloy



F28YF
3.5 oz. Jar

Superior wetting for complete tinning and general purpose brazing. Ideal for maintenance repairs on steel materials other than stainless steel. Use for fabricating and repair of galvanized sheets, pipes or angles. Tensile strength: 75,000 psi.

Uni-1500 Flux dissolves and removes oxides rapidly and thoroughly without bubbling and flows the filler metal into the joint freely and smoothly.

| Product | 1lb. Package 3/32" X 18" Rod | 1/8" X 18" Rod | Solidus Melting Point |
|-------------------|---------------------------------|----------------|--------------------------|
| Uni-1500FC | C42F1 | C42H1 | 1620 °F [882 °C] |



Uniweled Products, Inc. Fort Lauderdale, FL 33312 U.S.A. Customer Service: 800.323.2111
info@uniweled.com • www.uniweled.com

99

PART NUMBER INDEX

| Part # | Page # | Part # | Page # | Part # | Page # | Part # | Page # |
|-----------|----------|--------|--------|-----------|----------------------------|--------|--------|
| 05-1-52 | 97 | 41406 | 94 | 48052 | 68 | 53650 | 50 |
| 05-1-52-7 | 97 | 41407 | 94 | 48053 | 68 | 53651 | 50 |
| 05-1-63 | 97 | 41408 | 94 | 48075 | 68 | 53652 | 50 |
| 05-2-52-4 | 97 | 41452 | 94 | 48800 | 68 | 53654 | 50 |
| 05-2-52-7 | 97 | 41453 | 94 | 48801 | 68 | 69901 | 93 |
| 05-2-63-2 | 97 | 41456 | 94 | 48802 | 68 | 69902 | 93 |
| 05-3-52-8 | 97 | 41458 | 94 | 48803 | 68 | 6N1RSD | 81 |
| 10005 | 57,66 | 41459 | 94 | 48804 | 68 | 70000 | 88,89 |
| 10005-2 | 57 | 41460 | 94 | 48805 | 68 | 70001 | 88,89 |
| 10005-3 | 57 | 41461 | 94 | 48851 | 68 | 70002 | 89 |
| 100X51A4 | 57 | 42005 | 48 | 48852 | 68 | 70003 | 84 |
| 11482 | 92 | 42006 | 48 | 48853 | 68 | 70004 | 84 |
| 12106 | 37 | 42250 | 48 | 48854 | 68 | 70005 | 85 |
| 12107 | 37 | 42251 | 48 | 49000 | 70 | 70006 | 85 |
| 13401 | 71 | 42252 | 48 | 49001 | 70 | 70007 | 85 |
| 134A22-2A | 57 | 42253 | 48 | 49002 | 70 | 70009 | 91 |
| 134A22A | 57 | 42257 | 48 | 49003 | 70 | 70010 | 91 |
| 1393-3 | 57 | 42258 | 48 | 49004 | 70 | 70011 | 91 |
| 20N1RSD | 81 | 42259 | 48 | 49005 | 70 | 70012 | 91 |
| 21085 | 62 | 42260 | 48 | 49006 | 70 | 70013 | 91 |
| 40000 | 74,75,76 | 42261 | 48 | 49007 | 70 | 70014 | 91 |
| 40001 | 74 | 42262 | 48 | 49008 | 70 | 70015 | 91 |
| 40002 | 74 | 42263 | 48 | 49009 | 70 | 70016 | 90 |
| 40003 | 74 | 42264 | 48 | 49010 | 70 | 70017 | 90 |
| 40004 | 74 | 42265 | 48 | 49011 | 70 | 70018 | 90 |
| 40022 | 75,77 | 42266 | 48 | 49016 | 72 | 70019 | 90 |
| 40039 | 74 | 42267 | 48 | 49020 | 70 | 70020 | 90 |
| 40040 | 74 | 42268 | 48 | 49021 | 70 | 70021 | 90 |
| 40045 | 75,77 | 42274 | 48 | 49022 | 70 | 70022 | 82 |
| 40048 | 75,77 | 42275 | 48 | 49023 | 70 | 70024 | 88,89 |
| 40049 | 72 | 42276 | 48 | 5005 | 4,5,6,7,8,9,10,11,12,13,41 | 70025 | 89 |
| 40050 | 75,77 | 42277 | 48 | 502 | 21,23,41 | 70027 | 89 |
| 40051 | 77 | 42278 | 48 | 503 | 10,41 | 70028 | 90 |
| 40052 | 77 | 42280 | 48 | 504 | 4,5,8,9,41 | 70029 | 89 |
| 40053 | 77 | 42281 | 48 | 510 | 11,12,41 | 70031 | 89 |
| 40054 | 77 | 42282 | 48 | 5-101-0 | 4,5 | 70032 | 89 |
| 40055 | 75 | 42283 | 48 | 5-101-00 | 16 | 70035 | 89 |
| 40061 | 74,75,76 | 42284 | 48 | 5-101-00D | 16 | 70038 | 89 |
| 40062 | 76 | 42285 | 48 | 5-101-0D | 16 | 70039 | 89 |
| 40063 | 76 | 42286 | 48 | 5-101-1 | 16 | 70040 | 89 |
| 40064 | 76 | 42288 | 48 | 5-101-1D | 16 | 70041 | 85 |
| 40077 | 75 | 42289 | 48 | 5-101-2 | 4,16 | 70042 | 85 |
| 41302 | 94 | 42313 | 48 | 5-101-2D | 16 | 70043 | 85 |
| 41303 | 94 | 45503 | 92 | 511 | 4,5,6,7,8,9,10,11,12,13,41 | 70044 | 85 |
| 41304 | 94 | 45506 | 92 | 512 | 21,23,29,41 | 70045 | 85 |
| 41305 | 94 | 45595 | 92 | 515 | 41,74 | 70046 | 85 |
| 41306 | 94 | 45596 | 92 | 516 | 41,74 | 70047 | 85 |
| 41307 | 94 | 45597 | 92 | 517 | 41 | 70048 | 85 |
| 41308 | 94 | 45598 | 92 | 5-200-0 | 11 | 70049 | 85 |
| 41352 | 94 | 45599 | 92 | 5-200-0D | 16 | 70050 | 85 |
| 41353 | 94 | 46025 | 57 | 5-200-1 | 16 | 70051 | 85 |
| 41354 | 94 | 47827 | 68 | 5-200-1D | 16 | 70052 | 85 |
| 41355 | 94 | 47850 | 68 | 5-200-2 | 16 | 70053 | 85 |
| 41356 | 94 | 47851 | 68 | 5-200-2D | 16 | 70054 | 89 |
| 41357 | 94 | 47852 | 68 | 5-200M-0 | 11 | 70071 | 84 |
| 41358 | 94 | 47853 | 68 | 5-200M-0D | 16 | 70072 | 83 |
| 41402 | 94 | 47880 | 71 | 5-200M-1 | 16 | 70074 | 82 |
| 41403 | 94 | 47881 | 71 | 5-200M-1D | 16 | 70075 | 82 |
| 41404 | 94 | 48050 | 68 | 5-200M-2 | 16 | 70076 | 83 |
| 41405 | 94 | 48051 | 68 | 5-200M-2D | 16 | 70078 | 80 |

PART NUMBER INDEX

| Part # | Page # | Part # | Page # | Part # | Page # | Part # | Page # |
|--------|------------------------------------|--------|--------|--------|--------|--------|-----------|
| 70079 | 83 | 90050 | 63 | 90258 | 64 | 91654 | 69 |
| 70080 | 80 | 90051 | 63 | 90259 | 64 | 91861 | 45 |
| 70082 | 91 | 90052 | 63 | 90260 | 64 | 92655 | 60,61 |
| 70083 | 91 | 90053 | 63 | 90261 | 64 | 92786 | 73 |
| 70084 | 91 | 90054 | 63 | 90299 | 63 | 92788 | 73 |
| 70085 | 91 | 90055 | 63 | 90478 | 71 | 92795 | 73 |
| 70086 | 91 | 90059 | 70 | 90479 | 71 | 92797 | 73 |
| 70087 | 80 | 90060 | 72 | 90480 | 71 | 92799 | 71, |
| 70089 | 80 | 90206 | 64 | 90481 | 71 | 92800 | 66,71 |
| 70090 | 88,89 | 90207 | 64 | 90482 | 71 | 92801 | 66,71 |
| 70091 | 88 | 90208 | 64 | 90483 | 71 | 92806 | 63 |
| 70121 | 80 | 90209 | 64 | 90484 | 71 | 92809 | 63 |
| 71 | 6,7,8,9,10,11,12,13,14,17,18,19,36 | 90210 | 64 | 90485 | 71 | 92810 | 63 |
| 89600 | 23 | 90211 | 64 | 90486 | 71 | 92811 | 63 |
| 89602 | 23 | 90212 | 64 | 90500 | 64 | 92816 | 66 |
| 89603 | 23 | 90213 | 64 | 90501 | 64 | 92817 | 66 |
| 89605 | 23 | 90214 | 64 | 90502 | 64 | 92818 | 66 |
| 89606 | 27 | 90215 | 64 | 90503 | 64 | 92820 | 66 |
| 89607 | 27 | 90216 | 64 | 90504 | 64 | 92822 | 49 |
| 89608 | 23 | 90217 | 64 | 90505 | 64 | 92825 | 49 |
| 89609 | 23 | 90218 | 64 | 90506 | 64 | 92829 | 49 |
| 89610 | 23 | 90219 | 64 | 90507 | 64 | 92830 | 73 |
| 89611 | 23 | 90220 | 64 | 90508 | 64 | 92832 | 49 |
| 89620 | 23 | 90221 | 64 | 90509 | 64 | 92833 | 63 |
| 89621 | 23 | 90222 | 64 | 90510 | 64 | 92835 | 49 |
| 89622 | 23 | 90223 | 64 | 90511 | 64 | 92836 | 66 |
| 89623 | 23 | 90224 | 64 | 90512 | 64 | 92838 | 49 |
| 89624 | 23 | 90225 | 64 | 90513 | 64 | 92863 | 66 |
| 89625 | 23 | 90226 | 64 | 90514 | 64 | 92867 | 49 |
| 89626 | 23 | 90227 | 64 | 90515 | 64 | 92868 | 49 |
| 89627 | 23 | 90228 | 64 | 90524 | 64 | 92869 | 49 |
| 89628 | 23 | 90229 | 64 | 90525 | 64 | 94170 | 73 |
| 89629 | 23 | 90230 | 64 | 90526 | 64 | 94175 | 73 |
| 90000 | 69 | 90231 | 64 | 90527 | 64 | 94180 | 72 |
| 90007 | 69 | 90232 | 64 | 90528 | 64 | 94184 | 51 |
| 90008 | 69 | 90233 | 64 | 90529 | 64 | A-11 | 22,23 |
| 90009 | 69 | 90234 | 64 | 90530 | 64 | A-14 | 22,23 |
| 90010 | 69 | 90235 | 64 | 90531 | 64 | A-3 | 22,23 |
| 90027 | 70 | 90236 | 64 | 90532 | 64 | A-32 | 22 |
| 90028 | 70 | 90237 | 64 | 90533 | 64 | A-5 | 22,23 |
| 90029 | 70 | 90238 | 64 | 90534 | 64 | A-8 | 5,9,22,23 |
| 90030 | 70 | 90239 | 64 | 90535 | 64 | ABB134 | 66 |
| 90031 | 70 | 90240 | 64 | 90536 | 64 | ABBRK | 66 |
| 90032 | 70 | 90241 | 64 | 90537 | 64 | AS-11 | 22,23 |
| 90033 | 70 | 90242 | 64 | 90538 | 64 | AS-14 | 22 |
| 90034 | 70 | 90243 | 64 | 9059 | 39 | AS-3 | 22,23 |
| 90035 | 70 | 90244 | 64 | 9059-2 | 39 | AS-32 | 22 |
| 90036 | 70 | 90245 | 64 | 90691 | 71 | AS-5 | 22,23 |
| 90037 | 70 | 90246 | 64 | 90750 | 69 | AS-8 | 22 |
| 90038 | 70 | 90247 | 64 | 90751 | 69 | ASQ21 | 25 |
| 90039 | 70 | 90248 | 64 | 90752 | 69 | ASQ22 | 25 |
| 90040 | 70 | 90249 | 64 | 90753 | 69 | ASQ23 | 25 |
| 90041 | 70 | 90250 | 64 | 91600 | 69 | ASQ24 | 25 |
| 90042 | 70 | 90251 | 64 | 91601 | 69 | ASQ25 | 25 |
| 90043 | 68,69,71 | 90252 | 64 | 91602 | 69 | ASQ26 | 25 |
| 90044 | 68,69,71 | 90253 | 64 | 91603 | 69 | ASQ27 | 25 |
| 90045 | 68,71 | 90254 | 64 | 91604 | 69 | AT2 | 24 |
| 90046 | 68,71 | 90255 | 64 | 91651 | 69 | AT3 | 24 |
| 90048 | 63 | 90256 | 64 | 91652 | 69 | AT4 | 24 |
| 90049 | 63 | 90257 | 64 | 91653 | 69 | ATQ2 | 24 |



PART NUMBER INDEX

| Part # | Page # | Part # | Page # | Part # | Page # | Part # | Page # |
|-----------|-------------------|----------|-------------------------------|----------|-------------|----------|----------|
| ATQ3 | 24 | EZM6B | 61 | G15D | 36,37,95 | G46D | 97 |
| ATQ4 | 24 | EZM6R | 61 | G178 | 97 | G46SD | 97 |
| AV25H | 51 | EZM6Y | 61 | G182 | 97 | G49D | 36,37,97 |
| B | 21,23,38,40,41,42 | F10X | 39 | G184 | 97 | G4D | 97 |
| B1KD9 | 99 | F11 | 14 | G185 | 97 | G4SD | 97 |
| BG1 | 74,75,77 | F13 | 5,9,14 | G19D | 36,37,95 | G51D | 96 |
| BG1ACA | 51 | F19YJ | 99 | G1D | 97 | G529D | 59 |
| BG1FA | 72 | F22X | 39 | G15D | 97 | G529LD | 55,59 |
| BV501FX | 73 | F24X | 39 | G20D | 97 | G529LD-5 | 59 |
| C42F1 | 99 | F25 | 39 | G21D | 97 | G529LD-6 | 59 |
| C42H1 | 99 | F27L | 39 | G215D | 97 | G529NBD | 58 |
| CA100 | 7,8,9,11,12,14,16 | F27R | 39 | G22D | 97 | G529ND | 58 |
| CA550 | 4,5,11,14,16,36 | F28 | 39 | G225D | 97 | G530D | 59 |
| CC61 | 43,67 | F28YF | 99 | G24D | 97 | G530LD | 55,59 |
| CF25 | 58,59 | F29L | 39 | G245D | 97 | G530LD-5 | 59 |
| CF80 | 58 | F29R | 39 | G25D | 97 | G530LD-6 | 59 |
| CH20 | 26 | F31 | 39 | G255D | 97 | G530NBD | 58 |
| CH32 | 26 | F32 | 39 | G26D | 97 | G530ND | 58 |
| CT100-00D | 16 | F33 | 39 | G265D | 97 | G54D | 96 |
| CT100-0D | 7,8,9,11,12,16 | F34 | 39 | G27D | 97 | G55D | 96 |
| CT100-1D | 16 | F35 | 39 | G275D | 97 | G56D | 36,37,97 |
| CT100-2D | 16 | F36 | 39,79 | G28D | 97 | G5D | 97 |
| DHW316 | 82 | F37 | 39 | G285D | 97 | G5S | 97 |
| E VX38 | 57 | F38 | 39 | G29D | 59 | G5SD | 97 |
| EZ100B | 61 | F41 | 39 | G29D-1 | 59 | G62D | 96 |
| EZ100R | 61 | F4CYG | 99 | G29D-5 | 59 | G63D | 96 |
| EZ100Y | 61 | F50 | 39 | G29LD | 56,59 | G6D | 97 |
| EZ25B | 61 | F58L | 39,44 | G29LD-1 | 59 | G6SD | 97 |
| EZ25R | 61 | F58R | 39,44 | G29LD-5 | 59 | G73-1D | 97 |
| EZ25Y | 61 | F59L | 39 | G29NBD | 58 | G73D | 97 |
| EZ353HS | 61 | F59R | 39 | G29NBD-1 | 58 | G74D | 97 |
| EZ3B | 61 | F60 | 39 | G29NBD-5 | 58 | G74S | 97 |
| EZ3HS | 61 | F61X | 39 | G29ND | 58 | G74SD | 97 |
| EZ3R | 61 | F6CYAK | 98 | G29ND-1 | 58 | G75D | 97 |
| EZ3Y | 61 | F6CYL | 98 | G29ND-5 | 58 | G75SD | 97 |
| EZ50B | 61 | FB12 | 45 | G2D | 97 | G76D | 96 |
| EZ50R | 61 | FG24A | 51 | G25D | 97 | G76SD | 96 |
| EZ50Y | 61 | FL34 | 4,5,6,7,8,9,10,11,12,13,43,67 | G30D | 59 | G77D | 96 |
| EZ5B | 61 | FL3437 | 43 | G30D-1 | 59 | G77SD | 96 |
| EZ5HDS | 61 | FL3437TC | 43 | G30D-5 | 59 | G78D | 97 |
| EZ5HS | 61 | FL34D | 43 | G30LD | 56,59 | G79-4D | 97 |
| EZ5R | 61 | FL35 | 43 | G30LD-1 | 59 | G79D | 97 |
| EZ5Y | 61 | FL36 | 43 | G30LD-5 | 59 | G7D | 97 |
| EZ6B | 61 | FL37 | 43 | G30NBD | 58 | G7SD | 79,97 |
| EZ6HS | 61 | FV600 | 36 | G30NBD-1 | 58 | G80D | 97 |
| EZ6R | 61 | FVX38 | 57 | G30NBD-5 | 58 | G82-1D | 97 |
| EZ6Y | 61 | FY10X | 39 | G30ND | 58 | G82D | 97 |
| EZAB | 61,66 | FY10XA | 39 | G30ND-1 | 58 | G83D | 36,78,97 |
| EZAB90 | 61,66 | FY10XAV | 39 | G30ND-5 | 58 | G84D | 78,97 |
| EZABM | 61,66 | FY10XV | 39 | G33D | 97 | G85-1D | 97 |
| EZABM90 | 61,66 | FY11X | 39 | G33SD | 97 | G85D | 97 |
| EZABR90 | 61,66 | FY11XA | 39 | G34D | 97 | G86D | 96 |
| EZHR | 61 | FY11XAV | 39 | G34SD | 79,97 | G86SD | 96 |
| EZHRK | 61,66 | FY11XV | 39 | G409NSAD | 58,70 | G87D | 96 |
| EZM3B | 61 | G101 | 97 | G410NSAD | 58,70 | G8D | 97 |
| EZM3R | 61 | G104 | 97 | G429ND | 52,53,54,58 | G8SD | 79,97 |
| EZM3Y | 61 | G105 | 97 | G429ND-5 | 58 | G9LAD | 59,70 |
| EZM5B | 61 | G106 | 97 | G430ND | 52,53,54,58 | G9LD-5 | 59 |
| EZM5R | 61 | G108 | 97 | G430ND-5 | 58 | GB15S | 37,97 |
| EZMSY | 61 | G10LD-5 | 59 | G44D | 97 | GB20S | 79,97 |
| | | G10LAD | 59,70 | G44SD | 97 | GB25S | 58,59 |



PART NUMBER INDEX

| Part # | Page # | Part # | Page # | Part # | Page # | Part # | Page # |
|---------|--------|---------|--------|-----------|--------|-----------|----------------|
| GB805 | 58 | GS152 | 95 | GS267 | 95 | GSL302-3 | 96 |
| GD308 | 94 | GS158 | 95 | GS268 | 95 | GSL303-3 | 96 |
| GD408IP | 94 | GS159 | 95 | GS269 | 95 | GSL308-3 | 96 |
| GP100 | 95 | GS160 | 95 | GS270 | 95 | GSL309-3 | 96 |
| GP110 | 95 | GS161 | 95 | GS271 | 95 | GSL311-3 | 96 |
| GP111 | 95 | GS162 | 95 | GS272 | 95 | GSL312-3 | 96 |
| GP112 | 95 | GS163 | 95 | GS273 | 95 | GSL313-3 | 96 |
| GP113 | 95 | GS164 | 95 | GS274 | 95 | GSL314-3 | 96 |
| GP114 | 95 | GS165 | 95 | GS275 | 95 | GSL315-3 | 96 |
| GP115 | 95 | GS166 | 95 | GS300 | 95 | GSL316-3 | 96 |
| GP116 | 95 | GS167 | 95 | GS301 | 95 | GSL317-3 | 96 |
| GP117 | 95 | GS168 | 95 | GS302 | 95 | GSL318-3 | 96 |
| GP150 | 95 | GS169 | 95 | GS303 | 95 | GSL319-3 | 96 |
| GP160 | 95 | GS170 | 95 | GS304 | 95 | GSL320-3 | 96 |
| GP161 | 95 | GS171 | 95 | GS305 | 95 | GSL321-3 | 96 |
| GP162 | 95 | GS172 | 95 | GS308 | 95 | GSL322-3 | 96 |
| GP163 | 95 | GS173 | 95 | GS309 | 95 | GSL324-3 | 96 |
| GP164 | 95 | GS174 | 95 | GS310 | 95 | GSL325-3 | 96 |
| GP165 | 95 | GS200 | 95 | GS311 | 95 | GSL327-3 | 96 |
| GP166 | 95 | GS201 | 95 | GS312 | 95 | GT512-2 | 93 |
| GP167 | 95 | GS202 | 95 | GS313 | 95 | GT562-2 | 93 |
| GP200 | 95 | GS205 | 95 | GS314 | 95 | GT565 | 93 |
| GP210 | 95 | GS208 | 95 | GS315 | 95 | GT566 | 93 |
| GP210-5 | 94,95 | GS209 | 95 | GS316 | 95 | GT568 | 93 |
| GP211 | 95 | GS210 | 95 | GS316-5 | 95 | GT570 | 93 |
| GP211-5 | 94,95 | GS210-5 | 95 | GS316-SDP | 95 | H012A400A | 65 |
| GP212 | 95 | GS211 | 95 | GS317 | 95 | H012A409A | 65 |
| GP212-5 | 94,95 | GS211-5 | 95 | GS318 | 95 | H012A410A | 65 |
| GP213 | 95 | GS212 | 95 | GS319 | 95 | H018A400A | 65 |
| GP213-5 | 94,95 | GS212-5 | 95 | GS320 | 95 | H018A409A | 65 |
| GP214 | 95 | GS213 | 95 | GS321 | 95 | H018A410A | 65 |
| GP215 | 95 | GS213-5 | 95 | GS322 | 95 | H02-3 | 26,67 |
| GP216 | 95 | GS214 | 95 | GS323 | 95 | H024A400A | 65 |
| GP217 | 95 | GS215 | 95 | GS324 | 95 | H024A409A | 65 |
| GP250 | 95 | GS216 | 95 | GS325 | 95 | H024A410A | 65 |
| GP264 | 95 | GS217 | 95 | GS350 | 95 | H030A400A | 65 |
| GP265 | 95 | GS218 | 95 | GS351 | 95 | H030A409A | 65 |
| GP266 | 95 | GS219 | 95 | GS352 | 95 | H030A410A | 65 |
| GP267 | 95 | GS220 | 95 | GS353 | 95 | H036A400A | 65 |
| GS100 | 95 | GS221 | 95 | GS354 | 95 | H036A409A | 65 |
| GS101 | 95 | GS222 | 95 | GS355 | 95 | H036A410A | 65 |
| GS102 | 95 | GS223 | 95 | GS358 | 95 | H048A400A | 65 |
| GS108 | 95 | GS224 | 95 | GS359 | 95 | H048A409A | 65 |
| GS109 | 95 | GS225 | 95 | GS360 | 95 | H048A410A | 65 |
| GS110 | 95 | GS241 | 95 | GS361 | 95 | H060A400A | 65 |
| GS111 | 95 | GS242 | 95 | GS362 | 95 | H060A409A | 65 |
| GS112 | 95 | GS243 | 95 | GS363 | 95 | H060A410A | 65 |
| GS113 | 95 | GS244 | 95 | GS364 | 95 | H06A404A | 49 |
| GS114 | 95 | GS250 | 95 | GS365 | 95 | H06SMBB | 60 |
| GS115 | 95 | GS251 | 95 | GS366 | 95 | H06SMBR | 60 |
| GS116 | 95 | GS252 | 95 | GS367 | 95 | H06SMBY | 60 |
| GS117 | 95 | GS255 | 95 | GS368 | 95 | H100SMBB | 60 |
| GS118 | 95 | GS258 | 95 | GS369 | 95 | H100SMBEB | 62 |
| GS119 | 95 | GS259 | 95 | GS370 | 95 | H100SMBER | 62 |
| GS120 | 95 | GS260 | 95 | GS371 | 95 | H100SMBEY | 62 |
| GS121 | 95 | GS261 | 95 | GS372 | 95 | H100SMBB | 60 |
| GS122 | 95 | GS262 | 95 | GS373 | 95 | H100SMBR | 60 |
| GS123 | 95 | GS263 | 95 | GS374 | 95 | H100SMBY | 60 |
| GS124 | 95 | GS264 | 95 | GS375 | 95 | H11 | 35 |
| GS150 | 95 | GS265 | 95 | GS410-SIP | 94 | H11B | 35 |
| GS151 | 95 | GS266 | 95 | GSL301-3 | 96 | H12 | 21,23,24,25,35 |



PART NUMBER INDEX

| Part # | Page # | Part # | Page # | Part # | Page # | Part # | Page # |
|----------|-------------------------------|------------|--------|------------|-------------|-------------|--------|
| H12B | 35 | H6SMBEB | 62 | HLP10 | 35 | K55CM | 39 |
| H13 | 35 | H6SMBER | 62 | HLP10B | 35 | K55CP | 39 |
| H13B | 35 | H6SMBEY | 62 | HLP10SS | 30,35 | K56C | 11 |
| H1476 | 60 | H6SMBR | 60 | HLP11 | 35 | K56C-T | 11 |
| H15MBB | 60 | H6SMBY | 60 | HLP11B | 35 | K80 | 30 |
| H15MBR | 60 | H76S-10 | 60,73 | HLP11BS | 35 | K83 | 30 |
| H15MBY | 60 | H8SMBB | 60 | HLP11BSS | 35 | KC100 | 12 |
| H25SMBB | 60 | H8SMBEB | 62 | HLP11S | 35 | KC100C | 12 |
| H25SMBEB | 62 | H8SMBER | 62 | HLP11SS | 31,35 | KC100CT | 12 |
| H25SMBEY | 62 | H8SMBEY | 62 | HLP13 | 35 | KC100FC | 12 |
| H25SMBR | 60 | H8SMBR | 60 | HLP13B | 35 | KC100P | 12 |
| H25SMBY | 60 | H8SMBY | 60 | HLP13BS | 35 | KC100PT | 12 |
| H2P100D | 72 | HC01 | 39 | HLP13BSS | 35 | KC122L | 12 |
| H2SMBB | 60 | HC02 | 39 | HLP13S | 35 | KC122P | 12 |
| H2SMBR | 60 | HC353SMB | 60 | HLP13SS | 35 | KCA110 | 31 |
| H2SMBY | 60 | HC353SMBE | 62 | HLP14 | 35 | KCA111 | 31 |
| H2SSM | 51,74,75,77 | HC3SMB | 60,61 | HLP14B | 27,28,29,35 | KL22 | 7 |
| H32A | 4,5,6,7,8,9,10,11,12,13,35,36 | HC3SMBE | 62 | HLP14BS | 35 | KL22C | 7 |
| H32AB | 35 | HC4SMB | 60,61 | HLP14BSS | 35 | KL22C-T | 7 |
| H32ABT | 35 | HC4SMBE | 62 | HLP14S | 35 | KL22P | 7 |
| H32AT | 12,35,36 | HC5SMBE | 62 | HLP14SS | 35 | KL22P-T | 7 |
| H32B | 35 | HC6SMBE | 62 | HN82A | 39 | KL550-4 | 4 |
| H32BT | 35 | HCC38 | 44 | HN83A | 39 | KL550-4C | 4 |
| H33A | 35 | HCC38-0 | 44 | HN83P | 39 | KL550-4C-T | 4 |
| H33AB | 35 | HCC39 | 29,44 | HN84 | 39 | KL550-4P | 4 |
| H33B | 35 | HCC39-0 | 44 | HN87 | 39 | KL550-4P-T | 4 |
| H34A | 35 | HCC40 | 39 | HR134N-10 | 70,73 | KL550-5 | 4 |
| H34B | 35 | HCC41 | 39 | HR134N-100 | 70 | KL550-TR | 4 |
| H3D25M | 64 | HCC46 | 39 | HS53 | 39 | KL555-TR | 4 |
| H3D3M | 64 | HCC47 | 39 | HS54 | 39 | KL71-4 | 8 |
| H3D4M | 64 | HCC78 | 39 | HS55 | 39 | KL71-4C | 8 |
| H3D50M | 64 | HCC79 | 39 | HT44 | 33 | KL71-4C-T | 8 |
| H3D5M | 64 | HD018A700A | 65 | HT44TE | 33 | KL71-4P | 8 |
| H3D6M | 64 | HD018A709A | 65 | HVP12 | 46,48 | KL71-4P-T | 8 |
| H3D8M | 64 | HD018A710A | 65 | HVP12RK | 48 | KL71-5 | 8 |
| H3SMBB | 60 | HD030A700A | 65 | HVP6 | 46,48 | KL71-5TR | 8 |
| H3SMBEB | 62 | HD030A709A | 65 | HVP6RK | 48 | KLC100 | 12 |
| H3SMBER | 62 | HD030A710A | 65 | HVP8 | 46,48 | KLC100C | 12 |
| H3SMBEY | 62 | HD1A700A | 65 | HVP8RK | 48 | KLC100CT | 12 |
| H3SMBR | 60 | HD1A709A | 65 | HX14N-10 | 60,61,73 | KLC100P | 12 |
| H3SMBY | 60 | HD1A710A | 65 | HX14N-100 | 60 | KLC100PT | 12 |
| H4SMBB | 60 | HD1X14N-10 | 65 | K22 | 6 | KLPT4 | 28 |
| H4SMBEB | 62 | HD2A700A | 65 | K22C | 6 | KLPTQ4 | 28 |
| H4SMBER | 62 | HD2A709A | 65 | K22C-T | 6 | KL7550-4 | 5 |
| H4SMBEY | 62 | HD2A710A | 65 | K22P | 6 | KL7550-4C | 5 |
| H4SMBR | 60 | HD3A700A | 65 | K22P-T | 6 | KL7550-4C-T | 5 |
| H4SMBY | 60 | HD3A709A | 65 | K23 | 10 | KL7550-4P | 5 |
| H50SMBB | 60 | HD3A710A | 65 | K23C | 10 | KL7550-4P-T | 5 |
| H50SMBEB | 62 | HD4A700A | 65 | K23C-T | 10 | KL7550-5 | 5 |
| H50SMBER | 62 | HD4A709A | 65 | K23P | 10 | KL7550-5TR | 5 |
| H50SMBEY | 62 | HD4A710A | 65 | K23P-T | 10 | KL771-4 | 9 |
| H50SMBR | 60 | HD5A700A | 65 | K24 | 10 | KL771-4C | 9 |
| H50SMBY | 60 | HD5A709A | 65 | K24TB | 10 | KL771-4C-T | 9 |
| H55SMBB | 60 | HD5A710A | 65 | K37 | 27,28,29,35 | KL771-4P | 9 |
| H55SMBEB | 62 | HDC5MB | 60 | K38 | 35 | KL771-4P-T | 9 |
| H55SMBER | 62 | HDC5MBA | 61 | K40 | 35 | KL771-5 | 9 |
| H55SMBEY | 62 | HDX14N-10 | 64 | K41 | 35 | KL771-5TR | 9 |
| H55SMBR | 60 | HFX12-10 | 64 | K45CM | 35 | KQ37 | 25 |
| H55SMBY | 60 | HFX14-10 | 65 | K45CP | 39 | KQ38 | 25 |
| H6SMBB | 60 | HFX38-10 | 64,65 | K46P | 39 | KT2A5 | 21 |
| | | HG4 | 45 | K46P-T | 39 | KT2A5MC | 21 |

PART NUMBER INDEX

| Part # | Page # | Part # | Page # | Part # | Page # | Part # | Page # |
|----------|--|-----------|-------------------------------|----------|------------------|----------|--------|
| KT2A5MCT | 21 | Q422A | 57 | RMC2 | 6,7,8,9,10,11,36 | ST07MP | 31 |
| KT2A5T | 21 | Q4N8 | 53 | RO | 6,7,8,9,10,11,36 | ST07RSM | 31 |
| KTA23 | 24 | Q4N85SM | 53 | RO100 | 12,13,37 | T-2 | 27 |
| KTA23MC | 24 | Q4N85SMEZ | 53 | ROB | 36 | T2A-12 | 20 |
| KTA3 | 24 | QA200A | 57 | RP3A | 11,12,30,31,36 | T2A-12TE | 20 |
| KTA34 | 24 | QAL | 56 | RP3B | 29,31 | T2A-3 | 20 |
| KTA3MC | 24 | QAL3SM | 56 | RP3E | 31,32 | T2A-3TE | 20 |
| KTAQ23 | 24 | QAL3SMEZ | 56 | RP3T2 | 32 | T2A-5 | 20,21 |
| KTAQ23MC | 24 | QAL5SM | 56 | RP3T3 | 32 | T2A-5TE | 20 |
| KTAQ3 | 24 | QAL5SMEZ | 56 | RP3T4 | 32 | T2A-8 | 20 |
| KTAQ34 | 24 | QAL6SM | 56 | RP3T5 | 32 | T2A-8TE | 20 |
| KTAQ3MC | 24 | QAL6SMEZ | 56 | RP3T6 | 33 | T-3 | 27 |
| KTS2 | 29 | QS4L | 55 | RSB2 | 4,5,37 | T-4 | 27 |
| KTSQ2 | 29 | QS4L3H | 55 | RSB2B | 37 | T-5 | 27 |
| LD32 | 26,67 | QS4L5HBV | 55 | RSDBIT1 | 81 | TCJD | 42 |
| LD7-1A | 67 | QS4L3HEZ | 55 | RSDBIT2 | 81 | TCLD | 42 |
| LDPLC | 67 | QS4L5H | 55 | RSDBIT3 | 81 | TCMD | 42 |
| LPT4 | 28,29 | QS4L5HBV | 55 | RSDBIT4 | 81 | TCPD | 42 |
| LPT5 | 28 | QS4L5HEZ | 55 | RSDBIT5 | 81 | TCSD | 42 |
| LPT6 | 28 | QS4L6H | 55 | RSDBIT6 | 81 | TCV10 | 44 |
| LPTQ4 | 28,29 | QS4L5HBV | 55 | RSDBIT7 | 81 | TCV100 | 44 |
| LPTQ5 | 28 | QS4L6HEZ | 55 | RSDBIT8 | 81 | TCV101 | 44 |
| LPTQ6 | 28 | QS8N | 54 | RSMC2 | 4,5,37 | TCV11 | 44 |
| MC | 4,5,6,7,8,9,10,11,12,13,21,23,36,38,40,41,42 | QS8N3SMEZ | 54 | RSMC2B | 37 | TCVA | 44 |
| †MDC | 40 | QS8N5SMEZ | 54 | RSO | 4,5,37 | TCVB | 44 |
| †MKT-4L | 32 | QS8N6SMEZ | 54 | RSOB | 37 | TFA100 | 44 |
| MTF-5 | 6,7,19 | QVK-2 | 57 | RTB118 | 90 | TFA101 | 44 |
| MTF-9 | 19 | R | 4,5,6,7,8,9,10,11,12,13,40,41 | RTBCA118 | 90 | TFAA | 44 |
| MTF-17 | 19 | R1346 | 79 | RTBCA58 | 90 | TFAB | 44 |
| MTFM-5 | 19 | R1349 | 79 | RTBCA78 | 90 | TFAM100 | 44 |
| MTFM-9 | 19 | R1358 | 79 | RTBM118 | 90 | TFAM101 | 44 |
| MTFM-17 | 19 | R1360 | 79 | RTBM12 | 90 | TGB | 94 |
| MTR | 18 | R1362 | 79 | RTBM34 | 90 | TGB1 | 94 |
| MTT | 12,18 | R1363 | 79 | RTBM38 | 90 | TGB100 | 94 |
| MTW-1 | 18 | R1546 | 79 | RTBM58 | 90 | TGB105 | 94 |
| MTW-2 | 12,18 | R1549 | 79 | RTBM78 | 90 | TGB106 | 94 |
| MW2 | 57 | R1558 | 79 | RTBR | 90 | TGB1100 | 94 |
| N20 | 40 | R1560 | 79 | RTBRC | 90 | TGB115 | 94 |
| N40 | 40 | R1562 | 79 | S21 | 25 | TGB130 | 94 |
| N60 | 40,41 | R1563 | 79 | S22 | 25,26 | TGB15 | 94 |
| NV1 | 78 | R40 | 40,41 | S23 | 25 | TGB160 | 94 |
| P3KH9 | 98 | R96K | 78 | S24 | 25 | TGB2 | 94 |
| P4KD9 | 98 | RB | 21,23,24,25,36,38 | S25 | 25 | TGB205 | 94 |
| P4KD9S | 98 | RB2 | 8,9,10,36 | S26 | 25 | TGB206 | 94 |
| PB29 | 26 | RB2B | 8,9,10 | S27 | 25 | TGB2100 | 94 |
| †PCLD33 | 67 | RCV100 | 44 | S28 | 26 | TGB215 | 94 |
| †PCLD33T | 67 | RCV101 | 44 | SC180 | 62 | TGB230 | 94 |
| PCV | 67 | RCVB | 44 | SC45 | 62 | TGB260 | 94 |
| PCV25 | 32 | RFA100 | 44 | SC90 | 62 | TGB30 | 94 |
| †PDC | 40 | RFA101 | 44 | SCFHB | 62 | TGB4115 | 94 |
| PL15 | 97 | RFAA | 44 | SCFHR | 62 | TGB415 | 94 |
| PL2 | 97 | RFAB | 44 | SCFHY | 62 | TGB4215 | 94 |
| PL25 | 58,59,97 | RFAM100 | 44 | SHLP | 30,31,35 | TGB5 | 94 |
| PLD33 | 67 | RFAM101 | 44 | SM36 | 30 | TGB6 | 94 |
| PLD33V | 67 | RHP400 | 75,79 | SM38 | 30 | TGB60 | 94 |
| PUA | 14 | RHP500 | 79 | SPR3A | 57 | TGCB | 40 |
| Q408A | 57 | RHP800 | 79 | SPR3K | 57 | TGCMC | 40 |
| Q414K | 57 | RLP | 36 | SS37 | 26 | TGCN | 40 |
| Q422-2A | 57 | RLPB | 27,28,36 | SS38 | 26 | TGCO | 40 |
| Q422-3A | 57 | RMC | 21,23,24,25,36,38 | ST06MP | 31 | TGH | 94 |
| Q422-4A | 57 | RMC100 | 12,13,37 | ST07A | 26,31 | TGH100 | 94 |



PART NUMBER INDEX

| Part # | Page # | Part # | Page # | Part # | Page # | Part # | Page # |
|------------|-------------|-------------|----------------------------|-----------|----------|------------|--|
| TGH15 | 94 | TYPE13E-8 | 17 | TYPE28E-2 | 17 | UTC701 | 86,87 |
| TGH30 | 94 | TYPE17-0 | 8,10,12,13,16 | TYPE28E-4 | 17 | UTC702 | 86,87 |
| TGH415 | 94 | TYPE17-00 | 16 | TYPE28E-6 | 17 | UTC703 | 86,87 |
| TGH5 | 94 | TYPE17-000 | 16 | TYPE28E-8 | 17 | UTC704 | 86,87 |
| TGH6 | 94 | TYPE17-1 | 8,16 | UM17-0 | 16 | UTC705 | 86,87 |
| TGH60 | 94 | TYPE17-15 | 4,5,17 | UM17-000 | 16 | UTC706 | 87 |
| TGV | 94 | TYPE17-2 | 4,5,6,7,8,9,10,11,12,13,16 | UM17-2 | 16 | UVP1.5-110 | 47,48 |
| TGW | 94 | TYPE17-3 | 11,12,16,36 | UM17-3 | 16 | UVP1.5-220 | 47,48 |
| TGW160 | 94 | TYPE17-30 | 17 | UM17-4 | 16 | UVP5 | 47,48 |
| TGW300 | 94 | TYPE17-4 | 16 | UM17-5 | 16,17,18 | UVP5-220 | 47,48 |
| TGW300DP | 94 | TYPE17-5 | 16 | UNF3 | 78 | VP87 | 48 |
| TH3 | 23,25,30,34 | TYPE17-6 | 16 | UNF93A | 78 | VP86 | 48 |
| TH3B | 27,34 | TYPE17-7 | 16 | UPA | 14 | VV1 | 51 |
| TH5 | 24,34 | TYPE17-9 | 17 | USAM | 52 | VV1A | 51 |
| TH5B | 28,29,34 | TYPE17E-0 | 16 | USAM3EZ | 52 | W05 | 4,5,6,7,8,9,10,11,12,13,21,23,24,25,42 |
| TH6 | 21,23,25,34 | TYPE17E-00 | 16 | USAM5EZ | 52 | W06 | 42 |
| TH6B | 27,34 | TYPE17E-000 | 16 | USAM6EZ | 52 | W10X | 42 |
| TH7 | 24,34 | TYPE17E-1 | 16 | USAM3BV | 52 | W94 | 42 |
| TH7B | 28,29,34 | TYPE17E-2 | 16 | USAM5BV | 52 | WB500 | 29 |
| TH8 | 34 | TYPE17E-3 | 16 | USAM6BV | 52 | WG52 | 42 |
| TH8B | 34 | TYPE17E-4 | 16 | USP8E | 15 | WG53 | 4,5,6,7,8,9,10,11,12,13,42 |
| TH9 | 25,30,31,34 | TYPE17E-5 | 16 | USP8F | 15 | WH550 | 4,5,14,17,18,19 |
| TH9B | 34 | TYPE17E-6 | 16 | USP8S | 15 | X09R | 38,71,73 |
| TS-2 | 27 | TYPE17E-7 | 16 | USP8A | 15 | X11R | 71,73 |
| TS-3 | 27 | TYPE17E-9 | 17 | UT2 | 31,32 | X15R | 73 |
| TS-4 | 27 | TYPE17TFT | 18 | UT3 | 31,32 | X25R | 16 |
| TS-5 | 27 | TYPE28-2 | 17 | UT4 | 31,32 | X26R | 16 |
| TUA | 34 | TYPE28-4 | 17 | UT5 | 31,32 | X40R | 73 |
| TXRK | 16 | TYPE28-6 | 17 | UT6 | 31,33 | | |
| TYPE13-8VM | 17 | TYPE28-8 | 17 | UTA | 34 | | |





Contact Information

WORLD HEADQUARTERS UNIWELD PRODUCTS, INC.

2850 Ravenswood Road
Fort Lauderdale, Florida 33312
954.584.2000 • FAX: 954.587.0109
800.323.2111 • www.uniweld.com
email: info@uniweld.com

HOUSTON WAREHOUSE UNIWELD PRODUCTS, INC.

South Loop Business Park
6121 Long Drive
Houston, TX 77087-2008
800.323.2111
FAX: 954.587.0109

CANADIAN WAREHOUSE METRO UNIWELD PRODUCTS, LTD.

Metro Uniweld
Eastern Canadian Warehouse
5150 Timberlea Blvd.
Mississauga, ON L4W 2S5
800-472-3129
FAX: 800-511-4940

Metro Uniweld
Western Canadian Warehouse
#11-3603 Millar Avenue
Saskatoon, SK S7P 0B2
800-472-3129
FAX: 800-511-4940

SOUTH AMERICAN OFFICE & FACTORY UNIWELD ANDINA

Porfirio Romero OE1-58
y Avda. 10 de Agosto
Quito Ecuador S.A.
TEL: 593 2 241 5446
FAX: 593 2 240 4494
email: cliente@uniweld.com.ec

MIDDLE EAST & AFRICA - REGIONAL OFFICE UNIWELD PRODUCTS, INC.

Dakkash Street
Palm Bldg. 8th Floor
P.O. Box 13/5601
Beirut, Lebanon
TEL: 00 961 3 732 961
FAX: 00 961 1 557 475
email: unimideast@uniweld.com





Flame Tools Safety Training



North American Technician Excellence (NATE), headquartered in Arlington, VA, was founded in 1997 and is the nation's largest non-profit certification organization for heating, ventilation, air conditioning and refrigeration technicians. NATE is the only technician certification organization governed, owned, operated, developed and supported by the HVACR industry.

COURSE NAME: FLAME TOOLS SAFETY TRAINING

NATE COURSE# 6111-0001

CONTINUING EDUCATION HOURS (CEH): 2 HOURS

COURSE OVERVIEW: A field training course that last approximately 2 hours with lecture/ discussion and demonstrations.

REQUIRED TOPICS:

- **Introduction Overview** of Uniweld Products, Inc.
- **Fire Triangle** - A review of the Fire Triangle and the basic elements of fire.
- **Fuel Gases and Cylinders** - General discussion on the different types of fuels used to braze and solder copper tubing. Working temperatures of the various fuels and their applications. Safety precautions when working with the various fuel gases and cylinders.
- **Flame Tools** - A review of oxyacetylene and air-fuel flame tools and their applications within the HVACR, Plumbing and Maintenance industries.
- **Flame Tool Set Up and Safety** - Step by step procedure on setting up an oxyacetylene outfit and the proper safety procedures to apply when in use. This will include a review on setting the regulator delivery pressures based on the tip size used, proper procedures on shutting down an oxyacetylene outfit and preparing it for storage.
- **Alloys** - Review of the various alloys used in soldering/brazing, including aluminum alloy.
- **Nitrogen Regulators and Flow Indicators** - Review the use of nitrogen when purging an AC or R system and the effective way to monitor nitrogen flow.
- **Brazing Demonstration** - Review capillary action of brazing alloy with proper brazing techniques and which flame tool to use in certain applications.

All attendees must sign a NATE Official Recognized Provider Attendance Record.

This course applies to the following NATE course outlines:

| SERVICE | | INSTALLER | |
|---------|------------------------------------|-----------|------------------------------------|
| ACSV | Air Conditioning – Air to Air | ACIN | Air Conditioning – Air to Air |
| HPSV | Heating – Reverse Cycle Air to Air | HPIN | Heating – Reverse Cycle Air to Air |
| RLSV | Light Commercial Refrigeration | RLIN | Light Commercial Refrigeration |
| RCSV | Commercial Refrigeration | | |

NATE is a registered trademark of the North American Technician Excellence, Inc.





Marketing / Sales Aids



English Safety Poster Part #USP8E

Spanish Safety Poster Part #USP8S



SAFETY POSTERS



French Safety Poster Part #USP8F

Arabic Safety Poster Part #USPA





Marketing / Sales Aids



AER

Vinyl Banner 38"x 27" with Grommets
Part # BANNER



STR TOR
EAS

English Part #L002E
Spanish Part #L002S

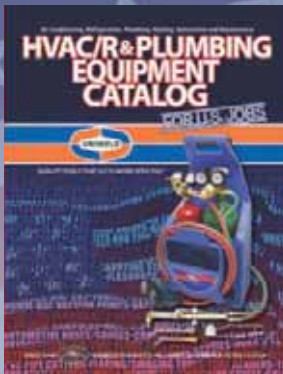

Digest Size
5.5" X 7"

Part #UGACATD

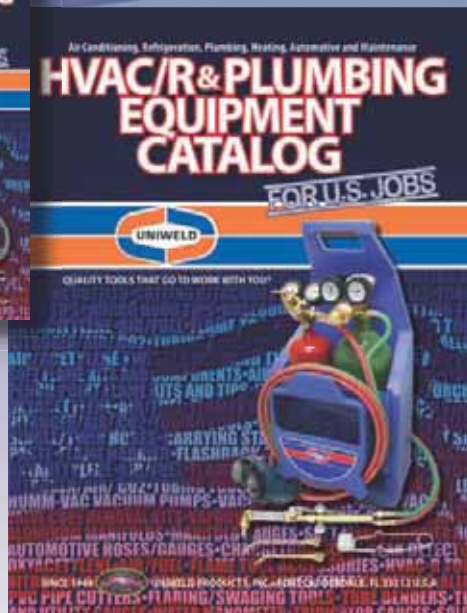

Standard Size
8.5" X 11"

Part #UGACAT

ATA OS



EAP

Part #UNIWELDCAP





Marketing / Sales Aids

Uniweld merchandising display materials help organize product selection to stimulate interest and entice technicians to make a purchase. The Uniweld headers, vinyl pegboard and slatwall covers can be applied to existing floor displays or wall mounted materials. Contact your local Uniweld representative to order and setup your merchandising display today!

S L A T W A L L C O V E R S

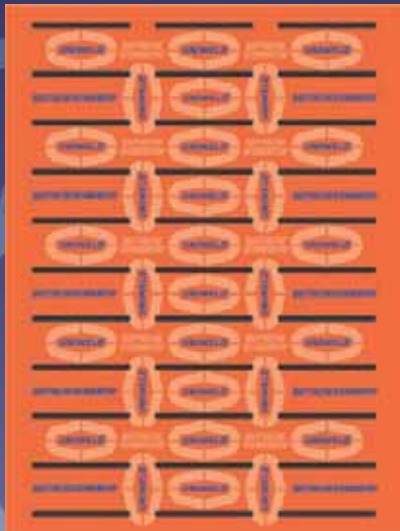

(24" x 32")

Part # UWVSWC Slatwall Vinyl Cover w/tape

P E G B O A R D C O V E R S



(24" x 47")

Part # UWVPBC Pegboard Vinyl Cover with Black Plastic Cover Pegs (6 per Cover)

Part # PHCH Black Plastic Cover Pegs

E A D E R S



(24.5" x 8.5")

Part # UWGH Gondola Header w/2-Self Stick Clips

Part # UWPH Pegboard Header w/Black Button Pegs

Part # UWSWH Slatwall Header w/Double Sided Tape

Part # UWSH Spinner Header

T

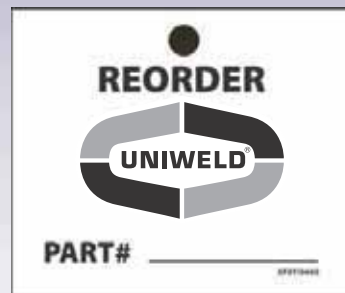

Part # XFST



Uniweld Products, Inc. Fort Lauderdale, FL 33312 U.S.A. Customer Service: 800.323.2111
info@uniweld.com • www.uniweld.com

111



Marketing / Sales Aids

SP^{ER}ER^ASP^SAY



Part # SPINNER

- Measuring 24" (W) x 61" (H), this display has three pegboard sides and fully rotates.
- Features attractive, durable orange and blue Uniweld logo vinyl pegboard covers and header sign.
- Includes: (25) 4" Pegboard Hooks, (10) 8" Pegboard Hooks, (50) Reorder Tags, Authorized Distributor Decals and instructions.
- Products sold separately
- Contact your local Uniweld representative and order your Merchandising Spinner display today!



112



Uniweld Products, Inc. Fort Lauderdale, FL 33312 U.S.A. Customer Service: 800.323.2111
info@uniweld.com • www.uniweld.com



Uniweld Products, Inc. Fort Lauderdale, FL 33312 U.S.A. Customer Service: 800.323.2111
info@uniweld.com • www.uniweld.com



Marketing / Sales Aids

MERCHANDISING GONDOLA DISPLAY



Part # GONDOLA

- Measuring 48" (L) x 54" (H) x 12" (W) display with base shelf.
- Features attractive, durable orange and blue Uniweld logo vinyl pegboard covers and header sign.
- Includes: (25) 4" Pegboard Hooks, (10) 8" Pegboard Hooks, (50) Reorder Tags, Authorized Distributor Decals and instructions.
- Products sold separately
- Contact your local Uniweld representative to order and setup your Merchandising Gondola display today!



Uniweld Products, Inc. Fort Lauderdale, FL 33312 U.S.A. Customer Service: 800.323.2111
info@uniweld.com • www.uniweld.com

HVAC/R&PLUMBING EQUIPMENT CATALOG

Since 1949, Uniweld, a U.S. Manufacturer, has employed over 300 workers who help design, manufacture, and distribute U.S. made products to be sold worldwide! As we celebrate 65 years of manufacturing excellence, our focus is ever set on the future to provide a superior product coupled with unmatched customer service. Uniweld's World Headquarters and manufacturing facility based in Ft. Lauderdale, FL has state of the art robotic CNC machines that produce quality flame tools, accessories, and pressure gauges for the air conditioning, refrigeration, plumbing, heating, automotive and maintenance industries. We thank you for supporting Uniweld Product.

FOR U.S. JOBS



QUALITY TOOLS THAT GO TO WORK WITH YOU®



FOLLOW US



UNIWELD PRODUCTS, INC.

2850 Ravenswood Road, Fort Lauderdale, FL 33312 U.S.A.

800.323.2111 • 954.584.2000 • Fax: 954.587.0109 • info@uniweld.com

www.uniweld.com

UGA/CAT 6/14