

### Features

- Includes face plate with handle, shower arm and flange.
- Single handle controls both on/off activation and temperature settings.
- Supplied with ADA compliant metal lever handle.
- For use with any KOHLER showerhead (sold separately).
- Complements the Purist faucet and accessory collections.

### Material

- Premium material construction with metal handle ensures reliability and durability.
- KOHLER finishes resist corrosion and tarnishing.

### Installation

- Trim only; requires valve to complete installation (sold separately).

### Required Products/Accessories

K-304/K-P304 Series Rite-Temp® Valves

or

K-8304/K-P8304 Series Rite-Temp® Valve & Cartridge Kits

or

K-8300/K-P8300 Series Rite-Temp® Valve Body Rough-ins

K-8305/K-P8305 Series Rite-Temp® Cartridges

or

K-2971-KS 3/4" Pressure-balancing Valve

### Recommended Products/Accessories

K-23723 Faucet cleaner

### Optional Products/Accessories

K-10350 Deep Rough-In Kit For K-8305 Cartridges

K-10351 Test cap for K-8300 Series valve bodies



### Codes/Standards







ASME A112.18.1/CSA B125.1

### KOHLER® Faucet Lifetime Limited Warranty

See website for detailed warranty information.

### Available Colors/Finishes

*Color tiles intended for reference only.*

Color	Code	Description
	CP	Polished Chrome
	SN	Vibrant® Polished Nickel
	BN	Vibrant® Brushed Nickel
	BV	Vibrant® Brushed Bronze
	BL	Matte Black
	2MB	Vibrant® Brushed Moderne Brass
	RGD	Vibrant Rose Gold

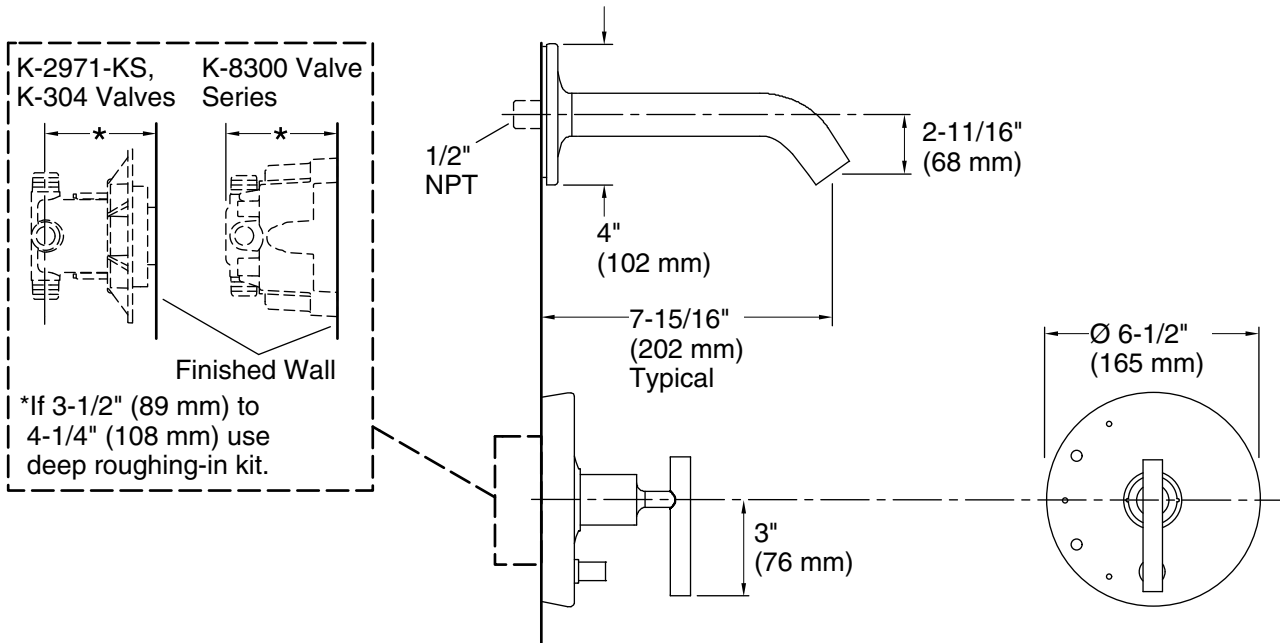

## Technical Information

All product dimensions are nominal.

## Notes

Install the product according to the installation guide.

**NOTICE:** Risk of product damage. Long screws for installing trim can damage the K-2971-KS valve. Consult the trim installation guide to verify if the thin wall installation kit (88526) is needed.