



MULTI FITTINGS
HIGHER STANDARDS™



Municipal Water and Sewer Systems

Technical Manual, 1st Edition



Multi Fittings

Corrosion-Proof Municipal

Water and Sewer Systems

Technical Manual, 1st Edition

© 2007 by Multi Fittings. All rights reserved. No part of this book may be used or reproduced in any manner whatsoever without prior written permission.

For information contact:

Multi Fittings, 1055 Wilton Grove Road, London, Ontario,
Canada, N6A 4K3

Telephone: 519-681-2140

Toll Free: 800-265-1815



ABOUT MULTI FITTINGS

Our well-being is dependent on the health of our municipal infrastructure. The public relies on pristine sources of potable water and the effective removal of sewage. Leaks that waste precious water or contaminate ground water must be avoided.

At Multi Fittings Corporation, we produce the broadest range of water and sewer fittings available in North America today. For over 50 years, Multi Fittings Corp. has led the field in injection molding and the production of fittings that are engineered tough, eliminating infiltration and exfiltration commonly associated with other pipe systems.

All fittings are made of noncorroding PVC, a material virtually immune to attack from aggressive soils. Our environmentally tight gasketed joints, developed by Multi's engineering group, keep potable water clean and sewage where it belongs – in the pipe system.





MULTI FITTINGS CORROSION-PROOF MUNICIPAL WATER AND SEWER SYSTEMS TECHNICAL MANUAL

| | |
|--|-----------|
| Overview | 1 |
| Products Detailed in this Design Guide | 3 |
| Section One: Product Information | 5 |
| Sewer Fittings | |
| Trench Tough Plus™ SDR35 Sewer Fittings | 6 |
| Trench Tough Plus™ Heavy Wall SDR26 Gasketed Sewer Fittings | 7 |
| Ultra-Rib® Open Profile Sewer Fittings | 9 |
| C900 - CIOD Sewer Fittings | 10 |
| Solvent Weld DWV and Sewer Fittings - Including Backwater Valves | 11 |
| Pressure Fittings | |
| Blue Brute® AWWA C907 Pressure Fittings | 13 |
| CycleTough® IPSOD Pressure Fittings | 14 |
| Specialty Products | |
| Stormwater Management – Inlet Control Devices | 15 |
| Section Two: Design Information | |
| General | 17 |
| Calculating Loads on PVC Sewer Pipes | 18 |
| The Modulus of Soil Reaction, E' | 19 |
| Predicting Long Term Deflection | 20 |
| Profile Wall vs Smooth Wall Pipe | 21 |
| Longevity & Durability of PVC Pipe Systems | 21 |
| Chemical and Abrasion Resistance | 22 |
| Chemical Attack | 22 |
| Abrasion | 22 |
| Infiltration and Exfiltration | 22 |
| Root Intrusion | 23 |
| Gravity Flow Systems | 23 |
| Installation of PVC Sewer Systems | 24 |
| Trench Zones | 24 |
| Embedment Materials | 24 |

| | |
|---|-----|
| Selection of Ebedment Materials | .25 |
| Preparation of Trench Bottom | .25 |
| Curved Sewers | .25 |
| Sewer Laterals | .26 |
| Riser Problems Demand Special Attention | .26 |
| Performance Testing of Sewer Laterals | .26 |
| Testing of Sewers | .27 |
| Deflection Testing | .28 |
| Videos | .29 |

Section Three: Appendices

| | |
|---|------------|
| Appendix A: References | .31 |
| Appendix B: Calculation Results | .32 |
| Appendix C: Reference Tables and Conversion Charts | .34 |
| Appendix D: Useful Formulas | .37 |
| Appendix E: Abbreviations | .40 |



OVERVIEW

The purpose of this technical manual is to provide engineers and designers with the most up-to-date technical information regarding the design of plastic piping systems. Fittings are an integral part of any piping system and are often located at the most critical and high stress areas. Careful design, combined with using the detailed information contained in this guide, will result in a leak-proof, problem free system that will provide many years of virtually maintenance free service.

For over 50 years, Multi Fittings has been an industry leader in offering the most comprehensively engineered and tested fittings for plastic pipe in North America. Multi Fittings produces the widest range of injection molded fittings for:

- Pressurized water mains and sewer forcemains
- Gravity flow sewers
- Drain, waste and vent applications



Engineering is the Key

Multi Fittings is the only manufacturer offering the unique “Trench Tough Plus” system. While other manufacturers have been indiscriminately adding material to their fittings in order to “strengthen” them, Multi Fittings embarked on a rigorous engineering analysis using cutting edge finite element modeling of every fitting in its offering. The results were persuasive:

- Adding material indiscriminately can actually make a fitting more likely to fail if the material is in the wrong place. Thickening the wrong area of a fitting can increase point loads and stresses and reduce flexibility.
- Carefully designing the shape of a fitting such that loads are properly distributed results in a fitting with increased strength that maintains its flexibility.
- For pressure fittings, a properly designed and reinforced fitting wall can eliminate cyclic failures in applications like golf course irrigation systems.

In addition to the advanced engineering design of the fitting wall, the Trench Tough Plus gasket design is significantly better than other less sophisticated offerings. The gasket is locked into the fitting using the sonic welding process. While this high-tech plastic fusion method has been used for years in the automotive industry, Multi Fittings is the first company to use it for making sewer fittings. The result is a permanently locked in gasket that has a much lower insertion force than other gasketed products, with a tighter joint.

Trench Tough Plus™ – Defined

The design of Trench Tough Plus fittings incorporates a number of engineering advances designed to increase system longevity and reliability:

- Advanced Compounding – A specifically designed polymer blend is used for the Trench Tough Plus System. This engineered high molecular weight formula increases the cracking resistance and impact strength of the fitting.
- Detailed Design – The high stress points on each fitting have been identified, analyzed using the

latest finite element methods and reinforced as required. For example, Trench Tough Plus SDR35 service fittings with 4" and 6" connections are supplied with standard SDR26 branches. SDR26 “Heavy Wall” fittings are actually manufactured to SDR24 – an “Extra Heavy” wall.

- Locked In Gasket – The Trench Tough Plus system uses the latest sonic welding technology to lock the gasket in place. Adapted from the automotive industry, this cutting edge technique ensures the gasket stays locked in, even under the most difficult installation conditions.
- Tight Joints that are Easier to Assemble – Trench Tough Plus joints are the tightest in the industry – able to withstand a minimum 15 psi hydrostatic pressure and 10.8 psi vacuum pressure while deflected 5° at the joint and at a 5% ring deflection. All this is achieved with an insertion force that is a fraction of that of competing fittings.

All this is backed up by the most comprehensive certification process in the industry. While other manufacturers comply only with self-policed ASTM standards, the Trench Tough Plus System is third party certified to CSA standards. This means that an independent agency checks the product for compliance to various standards and also conducts unannounced inspections of the manufacturing plant to ensure compliance.

Higher Standards™

Multi Fittings products are designed to exceed all the applicable standards. The requirements of the standards are seen only as a starting point for performance. Multi’s fittings are designed to withstand higher impact forces, higher loads and more jobsite abuse than other fittings. For example, the impact strength of fittings made under the Trench Tough Plus concept exceeds the requirements of ASTM F1336 by at least 25%. We understand that pressure and sewer fittings are not installed in a lab, and must be designed to take the punishment of real world jobsites. Only by manufacturing to Higher Standards can we make a fitting that will stand the test of time.



PRODUCTS DETAILED IN THIS DESIGN GUIDE



Sewer Applications:

Trench Tough Plus™ SDR35 Gasketed Sewer Fittings

Trench Tough Plus™ Heavy Wall SDR26 Sewer Fittings

Ultra-Rib® Open Profile Sewer Fittings

C900/ C907 CIOD Fittings for Sewer Applications

Solvent Weld DWV and Sewer fittings including Backwater Valves



Pressure Applications:

AWWA C900/C907 CIOD Pressure Fittings

CycleTough® 200 psi IPS Pressure Fittings



Specialty Products:

Inlet Control Devices for Stormwater Management

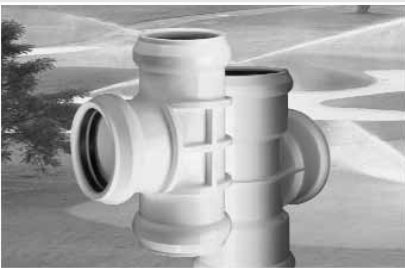

*This page intentionally
left blank*

The ultimate purpose of a sewer is to convey wastewater to a sewage treatment plant without any leaking out or allowing any groundwater to leak in. This can only be achieved by using pipes and fittings with tight joints and a high resistance to cracking. This is why PVC has supplanted every other material for sewer applications – it is dependable, does not corrode, and can be manufactured to extremely tight tolerances. The most crucial component of any piping system are the fittings. Fittings are typically where the highest stresses develop and where there are the most joints. When designing a sewer system, it is important to realize that not all PVC sewer fittings are created equal.

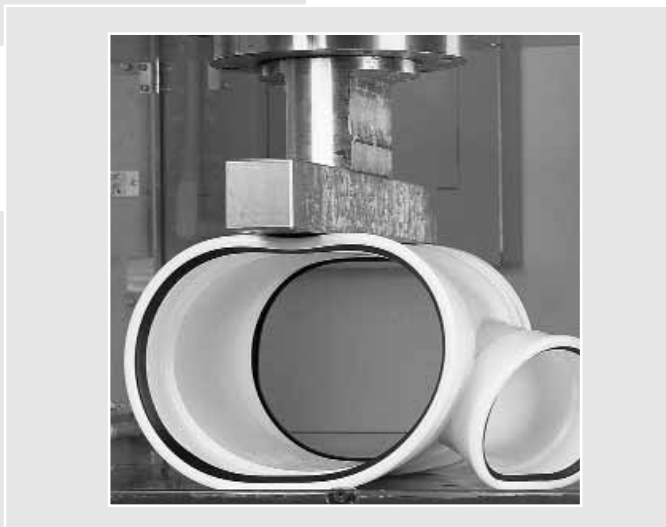
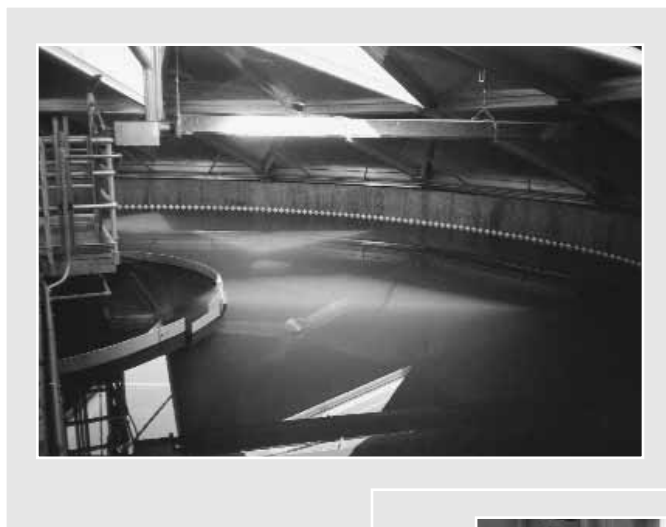

TRENCH TOUGH PLUS™ SDR35 SEWER FITTINGS

Description and Applications

Trench Tough Plus™ SDR35 sewer fittings are designed to be used with standard PVC SDR35 sewer pipe manufactured under ASTM D3034, F679 or F1760. They can be used for both wastewater and stormwater applications, as well as the conveyance of industrial wastes.

These fittings are reinforced to SDR26 thickness at strategic locations such as the branches of tees and wyes for optimal long-term performance.

Applicable Standards

- ASTM F1336
- ASTM F679
- ASTM D3034
- CSA B182.2
- CSA B181.2
- IAPMO File 2431



Joint Design

The Trench Tough Plus joint is third-party certified to withstand a 15 psi hydrostatic pressure, which is important in case sewer surcharges.

Joints are third-party certified to withstand a -10.8 psi vacuum pressure, which is necessary if the fitting is installed below the groundwater level.

Each of the above performance levels are tested with the joint deflected 5°, as well as a 5% ring deflection. This simulates a “worst case” installation scenario. While the joint forms an extremely tight seal, the insertion forces required to assemble the joint are significantly lower than for competing fittings. Multi Fittings joints easily meet the tough maximum infiltration/exfiltration limits set for PVC pipe of 25 U.S. gal./in.dia./mile/day.

Available Configurations

Multi Fittings has the widest range of molded fittings in North America. Any other configurations can be fabricated. For a complete list of the Multi Fittings product lineup, please refer to the Multi Fittings Price List or go to www.multifittings.com.

Short Form Specifications

All sewer fittings must comply with the ASTM D3034 and ASTM F1336 Standards. Fittings must be third party certified to CSA B182.2 or the above ASTM standards. Proof of third party verification must be supplied to the project engineer prior to approval.

Fitting joints must withstand a minimum 15 psi hydrostatic pressure and a -10.8 psi vacuum pressure for at least 10 minutes with no leakage while joint is deflected 5° and ring deflection is 5%. Proof of laboratory testing to this effect must be supplied with fittings.

Impact testing will be carried out both at 73°F and at 32°F with no cracking or splitting allowed. Proof of laboratory testing to this effect must be supplied with fittings.



TRENCH TOUGH PLUS™ HEAVY WALL SDR26 GASKETED SEWER FITTINGS

Description and Applications

Trench Tough Plus™ Heavy Wall SDR26 gasketed sewer fittings can be used with either SDR26 or SDR35 sewer pipe. They are designed for areas where the installation conditions are more challenging, such as deep burial applications or projects in poor soils. As with the standard wall fittings, they can be used for conveying sanitary or storm sewage, as well as industrial effluents.

In keeping with the Multi Fittings motto of “Higher Standards”, these fittings are actually made with an “extra heavy wall” SDR24 thickness. This provides increased insurance against problems in tough conditions.

Color Coded Gaskets

In addition to the extra weight and thickness of the fitting, all Multi Fittings heavy wall fittings can be identified by the grey gasket.

Applicable Standards

- ASTM F1336
- ASTM F679
- ASTM D3034
- CSA B182.2
- CSA B181.2

Joint Design

Joints are third-party certified to withstand a 15 psi hydrostatic pressure, which is important in case sewer surcharges.

Joints are third-party certified to withstand a -10.8 psi vacuum pressure, which is necessary if the fitting is installed below the groundwater level.

Each of the above performance levels are tested with the joint deflected 5°, as well as a 5% ring deflection. This simulates a “worst case” installation scenario. While the joint forms an extremely tight seal, the insertion forces required to assemble the joint are significantly lower than for competing fittings. Multi Fittings joints easily meet the tough maximum infiltration/exfiltration limits set for PVC pipe of 25 U.S. gal./in.dia./mile/day.

Available Configurations

Multi Fittings has the widest range of molded fittings in North America. Any other configurations can be fabricated. For a complete list of the Multi Fittings product lineup please refer to the Multi Fittings Price List or go to www.multifittings.com.

Short Form Specifications

All sewer fittings must comply with the ASTM D3034 and ASTM F1336 Standards. Fittings must be third party certified to CSA B182.2 or the above ASTM standards. Proof of third party verification must be supplied to the project engineer prior to approval. Heavy wall fittings must have a minimum thickness of SDR24.

Fitting joints must withstand a minimum 15 psi hydrostatic pressure and a -10.8 psi vacuum pressure for at least 10 minutes with no leakage while joint is deflected 5° and ring deflection is 5%. Proof of laboratory testing to this effect must be supplied with fittings.

Impact testing will be carried out both at 73°F and at 32°F with no cracking or splitting allowed. Proof of laboratory testing to this effect must be supplied with fittings.



TRENCH TOUGH PLUS™

Our fittings have been engineered to higher standards. They are the result of over 50 years of Multi Fittings know-how and experience. Different from the typical sewer fitting, every detail has been painstakingly researched, engineered, tested and manufactured to build a stronger, more durable product. It delivers a performance no conventional fitting can match and exceeds the industry's toughest standards such as flexibility and the ability to handle large loads better than any other on the market. Multi Fittings products are engineered to survive in the real world.

For more information on our Multi gasketed sewer fittings, order our multi-media presentation CD, or visit our website at www.multifittings.com.





ULTRA-RIB® OPEN PROFILE SEWER FITTINGS

Description and Applications

Multi Fittings open profile sewer fittings can be used with Ultra-Rib® open profile pipe manufactured both by IPEX and PW Eagle. They feature a thicker waterway wall than other profile pipe fittings and a unique breakaway rib that will prevent damage to the wall of the fitting. Ultra-Rib pipes and fittings can be used for sanitary and storm sewer applications as well as industrial lines.

Applicable Standards

- ASTM F794
- AASHTO M304
- CSA B182.4

Joint Design

The Ultra-Rib joint is different than a smooth wall SDR35 or SDR26 joint. The gasket is located between the second and third ribs on the spigot, rather than in the bell of the pipe. The joints are extremely tight, and if installed with IPEX Ultra-Rib pipe will withstand a 50 psi hydrostatic pressure.

Available Configurations

Ultra-Rib fittings are manufactured from 8" to 24" diameter. For tee connections for 4" and 6" sizes the outlets are gasketed bells that will accept smooth wall sewer pipes. For a complete listing of available Ultra-Rib fitting configurations, refer to the Multi Fittings Price List or go to www.multifittings.com.

Short Form Specifications

All open profile PVC sewer fittings must comply with the ASTM F794 Standard. Fittings must be third party certified to CSA B182.4 or ASTM F794. Proof of third party verification must be supplied to the project engineer prior to approval. Tee and wye branches that are 4" and 6" in diameter will be manufactured to ASTM D3034.

Fitting joints when assembled with Ultra-Rib pipe must withstand a minimum 15 psi hydrostatic pressure and a -10.8 psi vacuum pressure for at least 10 minutes with no leakage while joint is deflected 5° and ring deflection is 5%. Proof of laboratory testing to this effect must be supplied with fittings.

Impact testing will be carried out both at 73°F and at 32°F with no cracking or splitting allowed. Proof of laboratory testing to this effect must be supplied with fittings.



“C900” CIOD SEWER FITTINGS

Description and Applications

Some municipalities specify cast iron outside diameter (CIOD) pipe for sewer systems. These can be either SDR25, SDR18 or even SDR14 thickness. Multi Fittings offers a complete range of CIOD fittings for sewer applications. Some of these fittings are made for both pressure and sewer applications, and are certified as such, while others (such as wyes) are made specifically for sewer applications. Products designed solely for sewer use will be marked “For non-pressure use only”.

Applicable Standards

AWWA C900

AWWA C907

CSA B137.2

Joint Design

C900 or C907 fittings have been designed mainly for pressure applications. As a result they have extremely tight joints that far exceed anything required for sewer applications. For example, a 6" C907 fitting joint can routinely withstand internal pressures over 800 psi and external pressures over 100 psi. Note that the sewer sized branches of tee and wye fittings contain sewer gaskets that are not designed for pressure applications.



Available Configurations

Multi Fittings CIOD sewer fittings are molded in most configurations up to 8" in diameter, and fabricated in larger sizes. For a complete list of the available configurations, refer to the Multi Fittings price list or go to www.multifittings.com.

Short Form Specifications

All CIOD sewer fittings shall have a minimum standard dimension ratio (SDR) of 18. All fittings shall be equipped with removable gaskets in order to allow for use of oil resistant (nitrile) gaskets at the discretion of the project engineer.

CIOD fittings that are not suitable for pressure applications shall be marked “Not for Pressure Use”.





SOLVENT WELD DWV AND SEWER FITTINGS – INCLUDING BACKWATER VALVES

Description and Applications

Multi Fittings offers a wide variety of molded DWV fittings 4" in diameter and larger. Solvent welded DWV fittings are typically installed in indoor sanitary and drainage systems. Some solvent weld fittings are used underground as well. For example, backwater valves should be installed on all building drainage pipes connected to sanitary or storm sewers in order to prevent damage caused by sewer backups.

Applicable Standards

ASTM D2665 (6" & 8")

NSF 14 (6" & 8")

CSA B181.2 (6" & 8")

Solvent Weld vs. Gasketed Joints

Solvent welding is a process by which a joint is made by chemically fusing together a pipe and a fitting. A solvent is applied to the surface of a PVC pipe spigot, and the inside of a matching bell. In some cases a primer may be used to prepare the surfaces. The solvent dissolves some of the chemical bonds in the PVC material, effectively "melting" the material. Once the two surfaces are pushed together the material from the two surfaces begins to fuse together. As the joint cures the solvent evaporates and the joint becomes stronger, until it essentially becomes a continuous pipe.

Solvent welded joints are able to resist large tensile loads, and will not pull apart. In fact, it can be shown that the pipe itself will fail before the joint.

Gasketed joints are simply "push together" joints sealed by a special rubber gasket or O-ring. While a gasketed joint can provide an extremely tight hydrostatic pressure seal, it typically cannot resist significant end loads – in other words, it can pull apart. For this reason, gasketed joints are typically used for buried applications where they are confined. For above ground installations, measures must be taken (such as supporting the system with brackets) to ensure that joints are not subjected to significant end loads.

Available Configurations

Multi Fittings has one of the largest offerings of molded DWV fittings 4" and larger. For a complete list and for engineering lay lengths, please visit www.multifittings.com.

Backwater Valves

Backwater Valves are designed to protect buildings from sewer backups. They allow flow in only one direction – out of the house or building. They are an inexpensive way to



protect structures from the heavy damage that a sewer backup can inflict on a home or business. There are roughly 400,000 sewer backup incidents every year in North America. If more houses and buildings were equipped with backwater valves, the damage would be significantly reduced. They are normally located on the main building drain to the sanitary or storm sewer.

Available Sizes

Multi Fittings offers backwater valves both in PVC and ABS plastic in 3", 4" and 6" sizes. Backwater valves can be purchased either with or without a chimney.

Standards and Codes

IAPMO (3" & 4")

NSF-14

Southern Building Code (3" & 4")

CSA B181.2

Short Form Specifications

PVC DWV injection-molded 6" and 8" fittings shall conform to ASTM D2665 and be listed by NSF to Standard 14. They shall conform to the requirements of CSA B181.2.

All building drains to both sanitary and storm sewers will be equipped with backwater valves certified to CSA B181.2, and approved by IAPMO, approved in the Southern Building Code and will be listed to NSF-14.

Solvent cemented joints shall be assembled as shown in the Multi Fittings Installation Guide.

PRESSURE FITTINGS

Multi Fittings offers both cast iron outside diameter (CIOD) and iron pipe size (IPSOD) fittings for use in pressure systems. Plastic fittings are the only logical alternative when using PVC pipe. Iron fittings are an “Achilles heel” for many water, wastewater and irrigation systems as the fittings become the focal point for corrosion in the systems. Multi Fittings’ Blue Brute and CycleTough fittings have been specially designed to handle the most extreme conditions possible in a water or wastewater system.





BLUE BRUTE® AWWA C907 PRESSURE FITTINGS

Description and Applications

Blue Brute® (CIOD) fittings extend the corrosion-proof benefits of PVC pipe to fittings and allow the entire piping system to be constructed of non-corroding materials. While the initial cost of a Blue Brute fitting may be higher than a cast iron offering, it is important to consider the total cost of using corrodible fittings:

- Cast iron fittings require anodes made of zinc or magnesium to slow down the corrosion process.
- Installation can be complicated by the need for corrosion protection such as Denso tape.
- Bolts used for mechanical joints are particularly susceptible to corrosion and special “sac nuts” must be used.

Blue Brute fittings are made to match PVC pipe, with the same deep bells and thick gaskets. In addition, Blue Brute fittings have removable gaskets so that oil resistant nitrile gaskets can be substituted when installing in contaminated soils.

Applicable Standards

- AWWA C907 (Molded Fittings up to 12")
- CSA B137.2 (Molded Fittings)
- Factory Mutual (4" – 12")
- Underwriter’s Laboratories
- AWWA C900 and C905 (Fabricated Fittings)
- CSA B137.3 (Fabricated Fittings)
- NSF-61

Service Connections

Multi Fittings offers tapped couplings from 4" to 8" in diameter with factory made AWWA threaded taps up to 2" in diameter for a service connection. Double tapped connections are also available and provide a fast, reliable method of installing connections on a PVC pipeline while eliminating the need for metal saddles.

Short Form Specifications

PVC fittings shall be used on all PVC pipe. PVC fittings from 4" – 8" in diameter must comply with the requirements of AWWA C907 and be certified to CSA B137.2. All molded fittings will be made of PVC compound with a minimum hydrostatic design basis of 4000 psi. All fittings will be color coded blue. Molded fittings must be Factory Mutual approved and listed by Underwriter’s Laboratories International (ULI).

Fabricated fittings must be manufactured from pipe sections third party certified to CSA B137.3 and must meet the requirements of AWWA C900 or C905. Fabricated fittings must also be certified to CSA B137.3.

All fittings must be NSF-61 listed.



CYCLETOUGH® IPSOD PRESSURE FITTINGS

Description and Applications

Irrigation and sewage forcemain applications impose special demands on a fitting. Rather than a sustained pressure, the fitting must withstand the pounding from repeated pressure surges or cycles. Multi Fittings' specially engineered CycleTough® fittings have been reinforced at key areas to withstand all of the forces that act on a pipeline.

Applicable Standards

ASTM D1784, D3139, D1599, D2241, F477

CSA B137.3

NSF-61

Service Connections

Tapped couplings are available from 1-1/2" in diameter up to 6". Threaded connections range from 1/2" to 2" in NPT threads. Tapped couplings offer a method to eliminate metal saddles and provide a reliable, factory made tap with molded threads.

Short Form Specifications

IPSOD PVC fittings shall be used on all IPSOD PVC pipe. PVC fittings from 4" – 8" in diameter must comply with the requirements of ASTM D1784 and be third party certified to CSA B137.3. All molded fittings will be made of PVC compound with a minimum hydrostatic design basis of 4000 psi. Molded fittings must have a minimum pressure rating of 200 psi. Molded fitting joints must conform to ASTM D3139.

Fabricated fittings must be manufactured from pipe sections third party certified to CSA B137.3. The pressure rating of the pipe must match the pressure rating of the system.

All fittings must be NSF-61 listed.

While Multi Fittings built its reputation by offering the toughest PVC fittings in the industry, our real strength is our engineering. Therefore, we have created a number of products designed to tackle some of the most persistent issues facing the municipal engineering community.

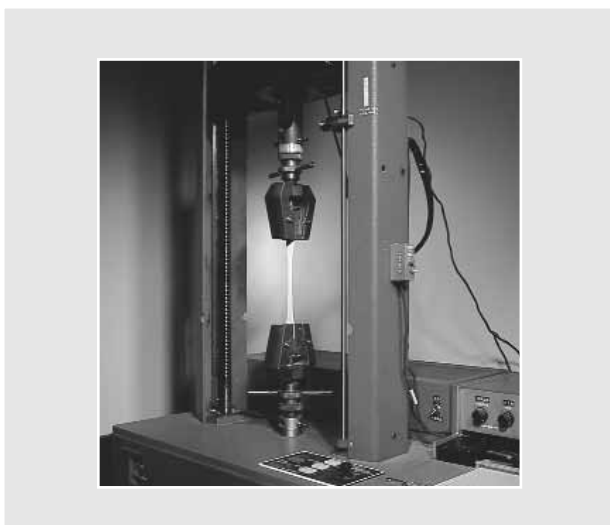



MULTI FITTINGS

SPECIALTY PRODUCTS - STORMWATER MANAGEMENT – INLET CONTROL DEVICES

The Multi Fittings Inlet Control Device (ICD) is used to control flow into storm sewers during peak flow events. It is designed to allow a specified flow volume out of a catchbasin at a specified head. This causes the excess stormwater to be temporarily stored above ground. This approach conserves pipe capacity so that catchbasins upstream do not become uncontrollably surcharged, which could lead to flooding.

Multi Fittings ICDs incorporate a special design that prevents clogging, which can be a problem for some orifice plates, particularly during low flow conditions.

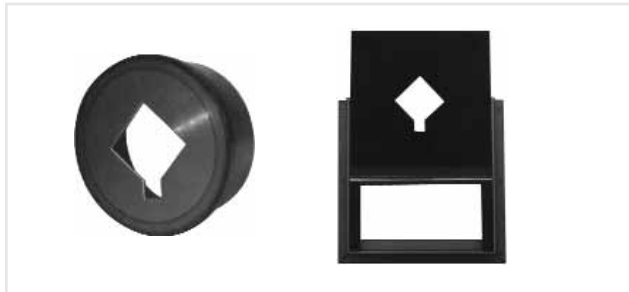

Applications

Stormwater flow control for parking lots, roads and other areas where main line storm sewer capacity must be managed.

Specifications

Multi Fittings Inlet Control Devices are manufactured from Polyvinyl Chloride (PVC) to be supplied according to the type (i.e. A, B, C, D, or F) as shown in the above graphs.

Multi Fittings Plug ICDs are to be machined to provide a friction fit into the outlet pipe.

Framed ICDs are to be bolted in position over appropriate outlet pipe in the catchbasin/maintenance hole.

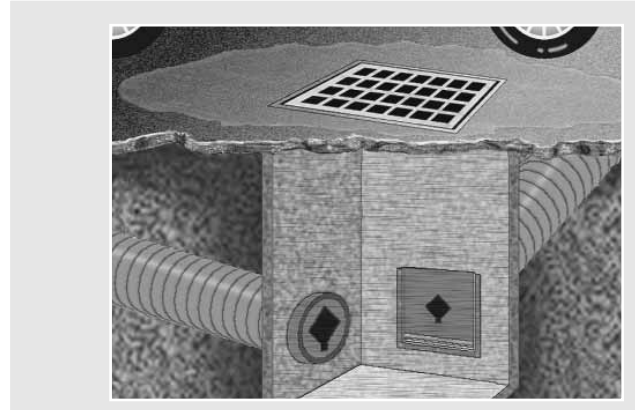

PRODUCT INFORMATION

Dimensions

ICDs are available both as standard (Types A, B, C, D, & F) and custom designed configurations. In addition, there are specific designs for different types of pipe, including smooth wall PVC, profile wall and concrete pipe.

The main advantage of specifying standard ICDs is that they are readily available and can be delivered immediately. However, there are definite advantages to specifying custom sized units as they allow tremendous design flexibility because the allowable flow can be matched directly to the topography of the pavement surface.

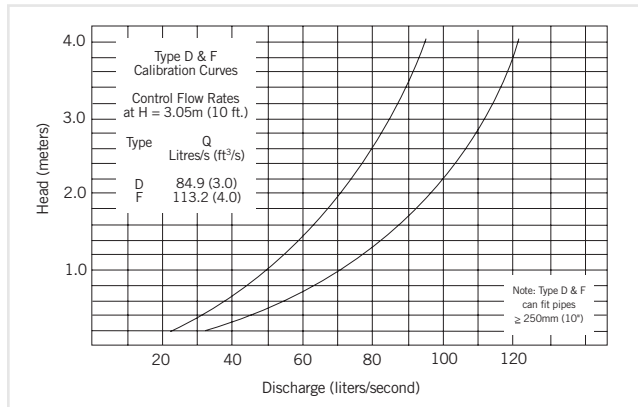
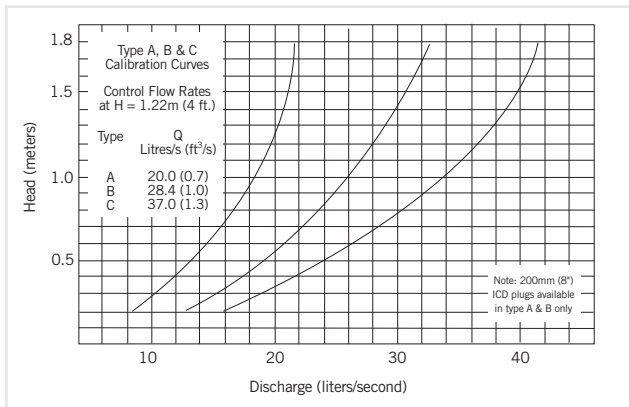
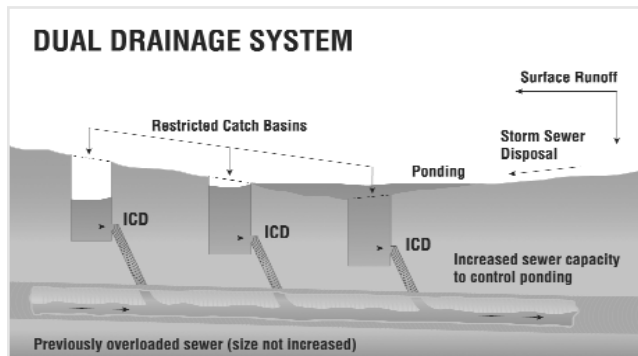

*This page intentionally
left blank*

GENERAL

Structural Design

PVC pipes are classified as flexible conduits, which means they are designed to transfer loads to the bedding envelope surrounding the pipe by deflecting. A flexible conduit is generally defined as one that can deflect more than 2% of its diameter without damage.

Perhaps the easiest way to visualize pipe-soil interaction is to consider the spring analogy that was used by Dr. A. Moser in his authoritative textbook "Buried Pipe Design".¹

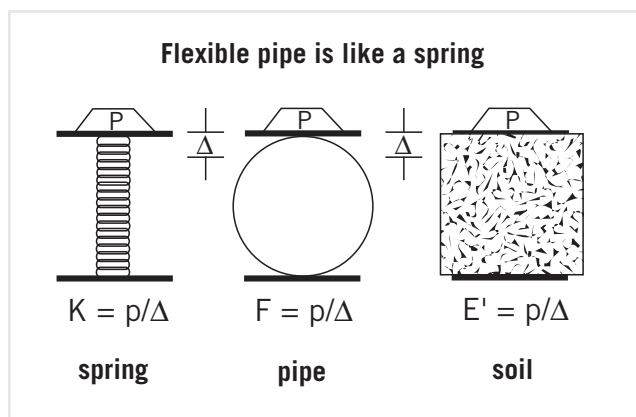

The ability to deflect away from vertical load is what gives PVC pipe its load carrying capability. The arching action of the soil over the pipe tends to reduce the load on the conduit, while the load that is applied is transferred to the surrounding bedding.

High Load Carrying Capabilities Even with Marginal Bedding

The pipe-soil system formed by PVC pipe is surprisingly strong. While PVC pipes are routinely installed with depths of bury exceeding 50 feet (particularly in landfill applications), experimental work has shown that Ultra-Rib pipe is capable of easily withstanding depths of bury up to 100 feet. Concrete pipe installed with identical bedding parameters collapsed. For a complete research report on this research completed at Utah State University, please contact your Multi Fittings representative.

Deflection is Not a Bad Thing

Flexible pipes have a different failure mode than rigid pipes. Rigid pipes crack and eventually collapse under excessive load, whereas flexible pipes simply continue to deflect. PVC sewer pipes can typically deflect up to 30% of their diameter before any leakage occurs at the joints or damage to the pipe. The deflection limit for a PVC pipe is typically set at between 5% and 7.5%, which means that there is a safety factor of between 4 and 6 for deflection.

Rigid pipe manufacturers often point to deflection as a drawback when using PVC pipe, however this simply reflects a lack of understanding of the pipe-soil mechanism. Rigid pipes must also deflect slightly to carry load, but they respond to this slight deflection by cracking. As a result, while the performance limit for flexible pipe is the allowable deflection, the performance limit for concrete pipe is an allowable crack width. While concrete pipe manufacturers claim that their product can "self heal" small cracks, it is advisable to check these installations with a low pressure air test to ensure that the cracked pipe is not leaking.

¹ Moser, A.P., "Buried Pipe Design, 2nd Edition, pp.22

Calculating Loads on PVC Sewer Pipes

Buried structures are subjected to dead loads from the soil above (and sometimes from structures or buildings) the pipe and to live loads, which are applied by vehicles or other bodies placed above the pipe temporarily.

The maximum possible soil load on a PVC pipe is known as the prism load, which is the pressure exerted by the full "block" of soil above the pipe. In reality, the actual load is somewhat less than this value, however, assuming prism load conditions contributes to a conservative design.

Example:

The prism load can be easily calculated if the soil density is known. For example, assume a soil density of 120 lb/ft³ and a depth of bury of 10 feet.

P = soil pressure, (lb/ft²)

w = soil density, (lb/ft³)

H = Depth of bury (ft.)

$$P = wH = (120 \text{ lb/ft}^3)(10 \text{ ft.}) = 1200 \text{ lb/ft}^2 = 8.3 \text{ lb/in}^2$$

Calculating live loads is more complicated and involves using the Boussinesq Solution for stresses in a semi-infinite elastic medium due to a point load applied at the surface^{2,3}. While relatively simple to solve, most designers opt to use standard loads that have been developed over the years.

The dead load and the live load is simply added together to get the total load on the pipe, which is then used to predict the long-term deflection in the pipe installation.

| Live Loads Transferred to Buried Pipe | | | | | | | |
|---------------------------------------|---|-------------|----------|---------------------|---|-------------|---------|
| Depth of Bury (ft.) | Live Load transferred to Pipe (lb/in ²) | | | Depth of Bury (ft.) | Live Load transferred to Pipe (lb/in ²) | | |
| | Highway - H ₂ O | Railway E80 | Airport | | Highway - H ₂ O | Railway E80 | Airport |
| 1 | 12.5 | Not Rec. | Not Rec. | 14 | * | 4.17 | 3.06 |
| 2 | 5.56 | 26.39 | 13.14 | 16 | * | 3.47 | 2.29 |
| 3 | 4.17 | 23.61 | 12.28 | 18 | * | 2.78 | 1.91 |
| 4 | 2.78 | 18.4 | 11.27 | 20 | * | 2.08 | 1.53 |
| 5 | 1.74 | 16.67 | 10.09 | 22 | * | 1.91 | 1.14 |
| 6 | 1.39 | 15.63 | 8.79 | 24 | * | 1.74 | 1.05 |
| 7 | 1.22 | 12.15 | 7.85 | 26 | * | 1.39 | * |
| 8 | 0.69 | 11.11 | 6.93 | 28 | * | 1.04 | * |
| 10 | * | 7.64 | 6.09 | 30 | * | 0.69 | * |
| 12 | * | 5.56 | 4.76 | 35 | * | * | * |

Notes:

1. Table taken from the Uni-Bell Handbook of PVC Pipe - 4th Edition, pp. 210
2. H₂O load simulates 20 ton truck traffic + impact (source ASTM A796)
3. E80 load simulates 80,000 lbs/ft railway load + impact (ASTM A796)
4. Aircraft load simulates 180,000 lb. dual tandem gear assembly, 26 inch spacing between tires and 66 inch centre spacing between fore and aft tires under a rigid pavement 12" thick + impact

^{2,3} More information on this calculation can be found in virtually any Soil Mechanics textbook. One of the best is "Soil Engineering" by M.F. Spangler. Information can also be found in Moser's "Buried Pipe Design" and the Uni-Bell Handbook of PVC Pipe.



The Modulus of Soil Reaction, E'

The modulus of soil reaction is basically a measure of the soil stiffness of the bedding surrounding the pipe. Since flexible pipe transfers load to the surrounding bedding, the E' (known as E prime) value used for calculations has a significant impact on the predicted deflection. Over the years, there have been many studies, done both in the laboratory and the field that have established reasonable design values for E'. Perhaps the most comprehensive work has been completed by Amster Howard of the U.S Bureau of Reclamation:

**TABLE 7.3
AVERAGE VALUES OF MODULUS OF SOIL REACTION, E'
(For Initial Flexible Pipe Deflection)**

| Soil type-pipe bedding material (Unified Classification System ^a) (1) | E' for Degree of Compaction of Bedding, in pounds per square inch | | | |
|--|--|---|---|---|
| | Dumped (2) | Slight, <85% Proctor, <40% relative density (3) | Moderate, 85%-95% Proctor, 40%-70% relative density (4) | High, >95% Proctor, >70% relative density (5) |
| Fine-grained Soils (LL > 50) ^b Soils with medium to high plasticity CH, MH, CH-MH | No data available; consult a competent soils engineer; Otherwise use E' = 0 | | | |
| Fine-grained Soils (LL < 50) Soils with medium to no plasticity, CL, ML, ML-CL, with less than 25% coarse- grained particles | 50 | 200 | 400 | 1,000 |
| Fine-grained Soils (LL < 50) Soils with medium to no plasticity, CL, ML, ML-CL, with more than 25% coarse-grained particles Coarse-grained Soils with Fines GM, GC, SM, SC ^c contains more than 12% Fines | 100 | 400 | 1,000 | 2,000 |
| Coarse-grained Soils with Little or no Fines GW, GP, SW, SP ^c contains less than 12% Fines | 200 | 1,000 | 2,000 | 3,000 |
| Crushed Rock | 1,000 | 3,000 | 3,000 | 3,000 |
| Accuracy in Terms of Percentage Deflection ^d | +2 | +2 | +1 | +0.5 |

^aASTM Designation D 2487, USBR Designation E-3.

^bLL = Liquid limit.

^cOr any borderline soil beginning with one of these symbols (i.e. GM-GC, GC-SC).

^dFor ±1% accuracy and predicted deflection of 3%, actual deflection would be between 2% and 4%.

Note: Values applicable only for fills less than 50 ft (15 m). Table does not include any safety factor. For use in predicting initial deflections only, appropriate Deflection Lag Factor must be applied for long-term deflections. If bedding falls on the borderline between two compaction categories, select lower E' value or average the two values. Percentage Proctor based on laboratory maximum dry density from test standards using about 12,500 ft-lbs/cu ft (598,000 J/m³) (ASTM D 698, AASHTO T-99, USBR Designation E-11). 1 psi = 6.9 kPa.

SOURCE: "Soil Reaction for Buried Flexible Pipe" by Amster K. Howard, U.S. Bureau of Reclamation, Denver, Colorado. Reprinted with permission from American Society of Civil Engineers.

Predicting Long Term Deflection using the Modified Iowa Formula

The Modified Iowa formula is an empirical equation that has been developed based on work originally done in the early 1900's and is the most commonly used expression to calculate deflection in any flexible conduit.

$$\frac{\% \Delta Y}{D} = \frac{(D_L K P + K W') (100)}{(0.149 \frac{F}{\Delta Y} + 0.061 E')}$$

Where:

ΔL = Deflection Lag Factor (1.0 for Prism loads)

K = Bedding Constant (0.1)

W' = Live load, lbs/in²

F/DY = Pipe Stiffness, lbs/in²

E' = Modulus of soil reaction, lbs/in²

Example: A 24" Ultra-Rib pipe is to be installed 35 feet under a railway track and bedded using highly compacted (>90% Proctor density), well graded granular material. The soil density is 120 lb/ft³.

Calculate the expected ring deflection

1 Calculate the Dead Load:

$$\text{Prism load} = wH = (35\text{ft})(120\text{lb/ft}^3) = 4200\text{lb/ft}^2 = 29 \text{ lb/in}^2$$

2 Calculate the Live Load:

From the Live Load table it can be seen that at 35 feet the effects of an E80 Railway load are negligible.

3 Choose the appropriate E' value

From Amster Howard's work shown in the previous table for compacted crushed rock the E' value is 3000lb/in²

4 Use the Modified Iowa Formula to Calculate the Deflection

$$\frac{\% \Delta Y}{D} = \frac{(D_L K P + K W') (100)}{(0.149 \frac{F}{\Delta Y} + 0.061 E')} = \frac{(1)(0.1)(29) + (0.1)(0)}{(0.149)(46) + 0.061(3000)} \times 100 = 1.5\%$$

Table 1 – Percent (%) Deflection for SDR35 and Ultra-Rib

| ASTM EMBEDMENT MATERIAL CLASSIFICATION | | DENSITY (PROCTOR) AASHTO T-99 | E' psi | HEIGHT OF COVER | | | | | | | | | | | | | |
|--|-----------|-------------------------------|--------|-----------------|-----|-----|-----|-----|-----|-----|-----|-----|-----|-----|-----|------|--|
| | | | | ft. 1 | 2 | 3 | 7 | 10 | 13 | 16 | 20 | 23 | 26 | 30 | 33 | 50 | |
| Manufactured Granular Angular | CLASS I | 90% | 3,000 | 0.7 | 0.5 | 0.3 | 0.4 | 0.4 | 0.6 | 0.7 | 0.9 | 1.0 | 1.2 | 1.3 | 1.4 | 2.2 | |
| Clean Sand & Gravel | CLASS II | 90% | 2,000 | 1.1 | 0.7 | 0.5 | 0.5 | 0.6 | 0.8 | 1.1 | 1.3 | 1.5 | 1.7 | 1.9 | 2.1 | 3.2 | |
| | | 80% | 1,000 | 2.0 | 1.4 | 1.0 | 1.0 | 1.2 | 1.6 | 2.0 | 2.4 | 2.8 | 3.2 | 3.6 | 4.0 | 6.0 | |
| Sand & Gravel with Fines | CLASS III | 85% | 500 | n/r | 2.5 | 1.7 | 1.8 | 2.2 | 2.9 | 3.7 | 4.4 | 5.1 | 5.9 | 6.6 | 7.3 | 11.0 | |
| Silt & Clay | CLASS IV | 85% | 400 | n/r | 3.0 | 2.1 | 2.2 | 2.6 | 3.5 | 4.4 | 5.3 | 6.1 | 7.0 | 7.9 | 8.8 | 13.1 | |

1. Deflection values shown include effect of H₂O live load and dead load.
2. External loading based upon a prism load of soil weight of 120 lbs. per cubic foot.
3. Bedding classifications correspond to ASTM D2321.
4. The deflection lag factor is 1.0 for a prism load.
5. Recommended maximum deflection of 7.5% provides a generous 4 to 1 factor of safety.
6. n/r = not recommended.



Profile wall vs. Smooth wall Pipe

The performance characteristics of SDR35 pipe and Ultra-Rib pipe are identical. They have similar internal diameters, identical ring stiffness of 46 psi and the same tight joints (50 psi). So, when should one specify Ultra-Rib and when should it be SDR35?

The secret to a successful specification is to specify as many products as possible that meet a certain performance standard. Since SDR35 and Ultra-Rib are identical from a performance perspective, both products can be specified for sanitary and storm sewer applications.

When specifying profile pipe, it is recommended that open profile pipe be specified as it is typically more durable than closed profile pipe. The difference between the two types lies in how they are manufactured. Open profile pipes are extruded as a solid wall pipe, then while it is still hot, mold blocks are used to re-shape the outside wall of the pipe into concentric ribs. This results in a monolithic pipe with no voids in the wall. A closed profile pipe is a thin inside wall with a second corrugated PVC pipe bonded to its outside surface. This encloses air voids within the pipe construction (hence the “closed profile” term).

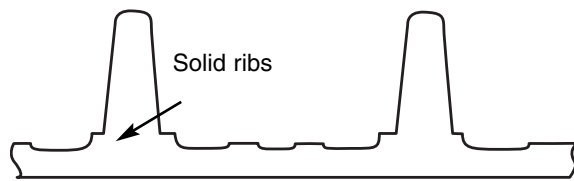

Ultra-Rib Open Profile

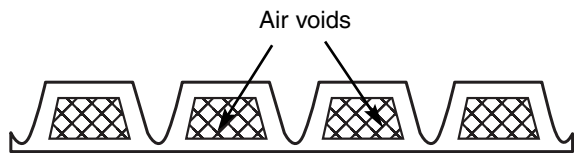

Double Wall Corrugated (DWC) Closed Profile

Longevity and Durability of PVC Pipe Systems

Studies undertaken in Europe and North America confirm that PVC has one of the longest life cycles of any sewer pipe material. These studies include:

Uni-Bell PVC Pipe Association – Examination of 15 Year Old Sewer Pipe

In this study a sewer pipe that had been in service for 15 years in Dallas, Texas was excavated and tested according to ASTM standards. The pipe met all current standards with the exception of the outside diameter, on which it outside the allowable tolerance by 0.002 of an inch.

Wavin International – The Result of 30 Years Research into the Life of Pipe Systems

This study consisted of the examination of over 26,000 metres of sewer pipe installed in some of the most difficult conditions in Europe over the last 30 years. Some of the conclusions of the study were:

- PVC piping systems can be expected to last for several hundred years.
- Good results are possible even when the pipes are installed under extremely difficult conditions, such as cohesive clay or peat.
- Even after up to 30 years service, there was no difference in the wall thickness between the “washed” portion of the pipes that carried wastewater and the “unwashed” portion near the crown of the pipes. This indicated abrasion wear was simply not an issue with these pipes.

Reinhard Nowack, Thomas Hulsman – 70 Years of Experience with PVC Pipes

The first PVC pipes for commercial use were produced in Germany in the mid-1930's. During this study a number of these pipes were excavated and tested. Although these pipes were pressure pipes, many of them were used in chemical transfer applications and have not had any decrease in service properties. Some of the conclusions of this study were:

- Even some of the earliest commercially produced pipes, which had a rated lifespan of only 50 years, were still performing well 70 years later.
- Better machinery available today and advanced compounding means that pipes produced today will have a longer lifespan than the pipes examined in this study.

The fact that PVC is not affected by the aggressive chemicals commonly found in sewage (sulphides, chlorides) means that it has a virtually unlimited lifespan in these applications. A minimum life cycle of 100 years is a conservative value to use when carrying out life-cycle costing calculations.

Chemical and Abrasion Resistance

Sanitary sewers, particularly in industrial areas, can be an extremely aggressive environment for piping materials. Hydrogen sulphide, chlorides from road salt as well as various substances in wastewater can attack concrete and metal components of sewer systems. Furthermore, abrasion caused by grit in wastewater can accelerate the decay process through abrasion and wearing action. Fortunately, PVC and other thermoplastics are virtually immune to attack from these chemicals and are highly resistant to abrasion.

Chemical Attack

Various studies have been undertaken with respect to the chemical resistance of PVC piping systems. Most of these studies have dealt with the issue of permeation by organic chemicals and the most common conclusion is that PVC pipe forms an effective barrier against organic contamination, with an effective permeation time in the order of many centuries even at extremely high levels of organic contamination.

With gravity sewer pipe the concern is typically whether gasoline, oil or other chemical spills could compromise the structural integrity of a PVC culvert or sewer pipe. Testing with various substances has shown conclusively that it is virtually impossible for PVC pipe to be affected by a spill. For example, PVC pipe has been exposed to pure gasoline for years with no effect⁴. While chemicals such as acetone can eventually damage PVC pipe, the effluent running through the pipe would have to be almost pure acetone and would have to run for hours for damage to occur.

Abrasion

Storm sewers and high velocity sanitary sewers can have a significant portion of grit in their flows that can potentially abrade a concrete sewer pipe. Testing carried out at California State University confirms that PVC pipe is considerably more durable than concrete pipe with respect to abrasion.

The results from California State clearly indicate that abrasion should be considered when designing sanitary or storm sewer systems. While it is true that very few concrete sewers have ever failed as a result of abrasion alone, abrasion tends to accelerate the corrosion process of both concrete and reinforcing steel.

When considering Ultra-Rib and SDR35 PVC pipes, abrasion can be virtually eliminated as an issue. Abrasion is only a concern with thin waterway wall closed profile pipes,

where even a small amount of abrasion could perforate their relatively thin waterway walls. With monolithically constructed Ultra-Rib and SDR35 pipes, there is no chance of perforation occurring due to abrasion.

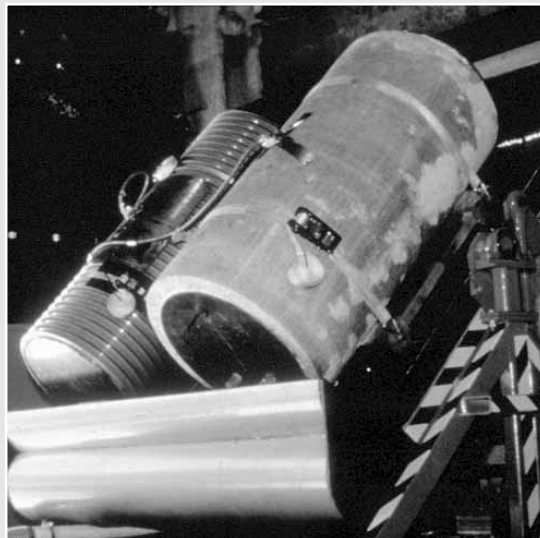

Infiltration and Exfiltration

The tight tolerances of Ring-Tite, Enviro-Tite and Ultra-Rib allow for extremely tight gasketed joints. The end result is a pipe joint that allows zero infiltration and exfiltration. In order to meet ASTM and CSA standards, all joints must withstand hydrostatic pressure levels of 15 psi as well as a vacuum pressure of -11 psi.

In fact, the joints of Ring-Tite, Enviro-Tite and Ultra-Rib can withstand pressures in excess of 50 psi. In many jurisdictions a 50 psi capable joint is required when installing a sewer within 8 feet of a water main.

While properly installed IPEX sewer pipes will have zero infiltration, the ASTM standard actually allows a maximum of 25 U.S. gal/in. dia/mile/day. This allowance recognizes that PVC sewer systems are often constructed with concrete manholes which generally allow a certain amount of infiltration.

⁴ Hoogensen Metallurgical Engineering Ltd., "Examination of Submitted PVC Pipe Section", Report to IPEX, December 1998



Root Intrusion

Root choked clay and concrete sewers cause millions of dollars worth of damage each year due to sewer backups. IPEX sewer pipe joints are immune to root penetration for two reasons:

- They are tight enough to resist even the thinnest root filaments penetrating.
- They do not provide a water source for the roots, so they do not attract root growth.

Each of these points has been proven both through field and laboratory testing.

Gravity Flow Systems: Manning's Equation

The most common procedure for calculating open channel or partially full pipe flow conditions is to use the Manning formula below:

$$V = \left(\frac{1.49}{n} \right) R^{2/3} S^{1/2}$$

Where: V = the average velocity at a cross section ft/sec

R = the hydraulic radius, ft

S = slope, ft/ft

n = the coefficient of roughness

The "n" factor varies both with the degree of roughness of the inside of the pipe, and the flow velocity. Higher flow velocities tend to reduce the "n" factor in sewers as solids deposition and slime build-up on the bottom of the pipe is reduced.

Designing with the PVC sewer pipe, an "n" factor of 0.009 is recommended.⁵ This is supported by a large number of scientific studies, many of which were carried out on "in service" pipes that had been operating for many years. The "n" values in these studies were found to range between 0.007 and 0.011. No published study has ever found an "n" value as high as 0.013 for a PVC system in any sewer operation even at minimum velocities of 2 ft/s (0.6 m/s).

Average Values of the Manning Roughness Factor

| Material | Manning n |
|-----------|-----------|
| PVC | .009 |
| Concrete | .013 |
| Cast iron | .015 |

Please contact us if you wish to review the results of these studies.

The relatively low "n" values associated with PVC pipe are a result of various factors:

- Smooth, nonporous inside surface of the pipe
- Longer laying lengths (i.e. fewer joints)
- Lower profile gap at the joints
- Chemical and abrasion resistance of the material

By designing PVC sewer systems with the scientifically appropriate Manning value of 0.009, sewers can be installed at tighter grades, thus reducing excavation costs and disturbance. In some cases, it may even be possible to downsize the pipe while maintaining a particular flow capacity.

⁵ Uni-Bell PVC Pipe Association; "Handbook of PVC Pipe" 4th Edition, August 2001, pp.359

Installation of PVC Sewer Systems

An understanding of flexible conduit terminology is essential for the installer. The soil class and density realized in the bedding, haunching and initial backfill zones are important factors in achieving a satisfactory installation of PVC pipe.

Much of the installation information can also be found in Canadian Standards Association (CSA) Standard B182.11, entitled, "Recommended Practice for the Installation of Thermoplastic Drain, Storm and Sewer Pipe and Fittings" or ASTM Standard D2321, entitled, "Underground Installation of Thermoplastic Pipe for Sewers and Other Gravity Flow Applications."

Trench Zones

The following figure has been prepared to illustrate the various zones used with flexible pipe terminology.

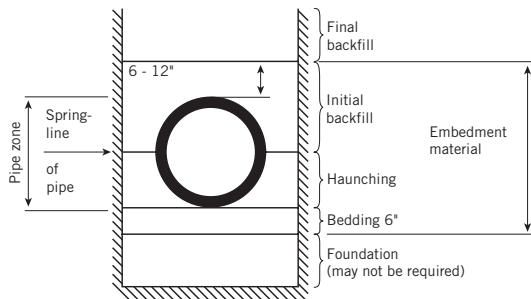

Foundation - A foundation is required when the trench bottom is unstable. Any foundation that will support a rigid pipe without causing loss of grade or structural breakage will be more than adequate for PVC pipes.

Bedding - The bedding directly underneath the pipe is required only to bring the trench bottom up to grade. It should not be so thick or soft that the pipe will settle and lose grade. The sole purpose of the bedding is to provide a firm, stable and uniform support of the pipe. A bedding thickness of 4" is most times sufficient. The engineer may wish to increase the bedding to 6" for ledge rock foundations.

Haunching - This area is the most important in terms of limiting the vertical deflection of the flexible pipe. Pipe support is obtained in the haunch zone by compacting soil in both directions away from the pipe to the undisturbed trench walls.

Initial Backfill - This zone begins above the springline to a level 6" to 12" above the top of the pipe. Compaction here

will give little additional side support to PVC pipe, but may be required to maintain stability of any above ground surfaces (i.e. roads or sidewalks).

Note: The particle size recommended for the three zones described above should not exceed 1.5" for Ring-Tite, Enviro-Tite and Ultra-Rib.

Final Backfill - The remainder of the trench fill above the initial backfill provides no support for a PVC pipe and should be free of stones 6" and larger. Compaction may be required for reasons other than support of the PVC pipe since this zone is very significant in supporting the above ground surfaces (i.e. roads or highways).

Embedment Materials

Some general rules about all soils to be used in a buried pipe-line trench include that they must be free of sharp objects, sticks, large clumps, frozen material, organic materials and boulders.

Most of the soils commonly found can be classified into one of the following categories, which are referenced from ASTM D2487.

Class 1

Angular, 1/4" - 1-1/2" graded stone, including a number of fill materials such as coral, slag, cinders, crushed stone or crushed shells.

Class 2

Coarse sands and gravels with a maximum particle size of 1-1/2", including various graded sands and gravels containing small percentages of fines, generally granular and non-cohesive.

Class 3

Fine sand and clayey gravels, including fine sands, sand-clay mixtures and gravel-clay mixtures.

Class 4

Silt, silty clays and clays including inorganic clays and silts of medium to high plasticity and liquid limits.

Class 5

Includes organic soils such as frozen earth, debris and other foreign materials. These materials are not recommended for use in the bedding, haunch or initial backfill zones.

Note: The performance of a flexible conduit does not depend only on the class of embedment materials used, but more importantly, on the density achieved in compaction of the haunching material.



Selection of Embedment Materials

Soil to be used in the pipe zone should be capable of maintaining the specified soil density. For example, if a coarse material such as Class 1 is used for bedding the pipe, it should also be used in the haunch zone to the springline of the pipe. Otherwise, side support may be lost due to migration of the Class 2, 3 or 4 material into the bedding.

When selecting the embedment materials, ensure that native soil migration from the trench walls cannot occur. A well-graded compacted granular material will prevent this condition from occurring. In trenches subject to inundation, the granular material should be compacted to a minimum of 85% Standard Proctor Density.

Preparation of Trench Bottom

Preparation of the trench bottom is the starting point for a satisfactory and safe sewer pipe installation. The trench bottom should be smooth and free from large stones, clumps of dirt and any frozen material as approved by the engineer. It is economical on most sewer installations to undercut the trench bottom by machine and bring it up to grade by use of granular material.

If the bedding material chosen is a loose granular such as sand, the pipe can be laid directly on it. If the bedding is a hard, compacted material, excavation for the bells (bell holes) should be provided so that the pipe is uniformly supported along the entire length.

Coarse sand, crushed stone or shell often is the most economical granular material because compaction is easily obtained. With all types of soil, voids should be eliminated under and around the lower half of the pipe by working in granular materials by shovel slicing.

Native backfill may be used for the trench bottom providing the soil is free of large stones, hard lumps and debris, and can be properly compacted by tamping. Ensure that the fill does not fit the Class 5 description.

In rocky trenches, place a minimum 4" layer of select bedding material to provide a cushion for the pipe. The rock foundation must first be excavated to at least 4" below the final grade of the pipe bottom. Any buried pipe, regardless of pipe material, that rests directly on rock may be subject to eventual breakage under the weight of soil and/or live loads.

When an unstable trench bottom is encountered and appears to be unable to support the pipe properly, the engineer may insist that the bottom be excavated and refilled to pipe grade with an approved foundation and bedding material. This layer should be compacted to a minimum 85% Standard Proctor Density.

Sewer Laterals

In general, service laterals should be taken off at an angle of no greater than 45 degrees from the horizontal. This will minimize the effects of side-soil friction imposing excessive downward loads on the service connection.

When connecting laterals, use a long sweep PVC bend wherever possible to facilitate changes in slope more gradually. Good compaction is imperative beneath the long sweep bends as well as below the branch of the service connection in order to maintain proper soil support. The PVC long sweep bends from Multi Fittings are made to a radius of curvature of six (6) times the nominal diameter of the bend.

Riser Problems Demand Special Attention

When vertical risers cannot be avoided, consult the design engineer as more special precautions may be required.

Service lines from the property to the street sewer demand special design considerations when the collection sewer is deeper than 13' regardless of the piping material used. Service risers from main sewers buried more than 13' should be taken off at an angle not less than 45° from the vertical. The service should then be moved to the vertical position by an appropriate elbow and vertical section of pipe. In sanitary sewer systems, drop laterals and drop manholes are the most common examples of areas requiring this special attention.

Drop laterals may create undue stresses on the buried pipe and fitting assembly. Horizontal portions of a lateral laid over disturbed uncompacted materials may experience a loss of bedding support if the foundation settles. This can lead to loss of grade and ultimately beam or shear failure in the pipe or fitting. As the soil adjacent to the pipe settles with the foundation, it attempts to drag the pipe with it, magnifying the load on the fittings.

Providing proper support beneath the mainline, service fitting, lateral, elevation fittings and their adjacent fill is critical. Since this is usually difficult, the best approach is to turn the lateral down immediately when entering the trench and keep it against the trench wall, thus eliminating any unsupported portion.

Keeping the drop portion (and the upper elbow) immediately adjacent to the trench wall can reduce drag down effects and control beam bending during backfill. Even then, the elbow at the bottom must be both strong enough and bedded on a sound foundation to react to the loads. As depths increase, settlement loads can ultimately fail the system or buckle the riser.

Designs employing sleeves or concrete encasement of the drop portion of the lateral are effective if the designer provides an adequate means of supporting the loads at the bottom.

Sleeving the lateral with a crushable sleeve such as corrugated polyethylene drainage tubing can also solve the problem. As the fill adjacent to the lateral settles, the sleeve folds up and moves down with it. This accordion-like effect displaces the load from the lateral. It should be noted that when this method is used, the annular space between the sleeve and the lateral should not be filled with backfill.

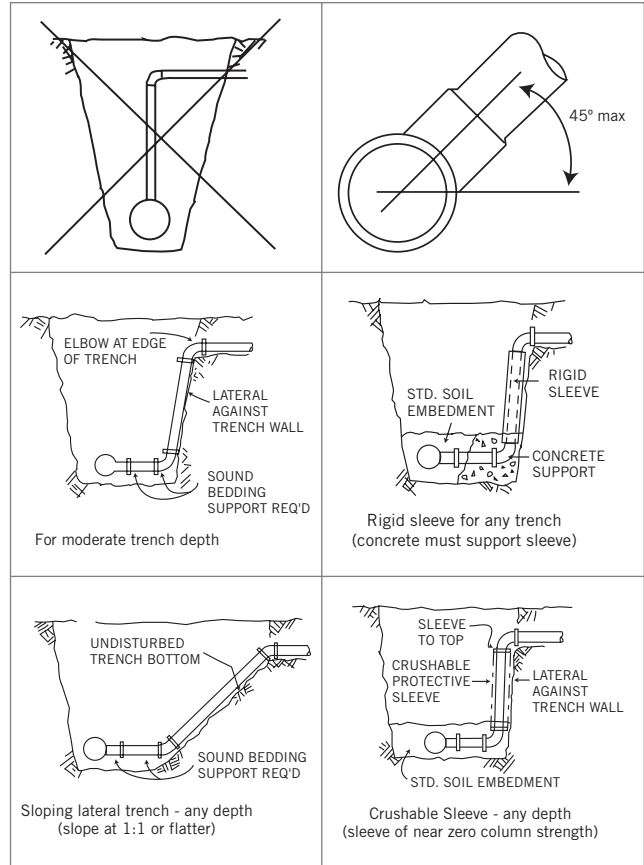

Performance Testing of Sewer Installations

When specifying performance testing for installed sewers it is important to ensure that the complete system is tested. While a video inspection 30 days after installation is usually sufficient to identify any defects in the installation, there are a number of other performance tests that can be carried out.

One of the most useful tests is the low pressure air test, which is used to check the integrity of installed joints both for rigid pipes like reinforced concrete as well as PVC systems. Multi Fittings recommends air testing for all installed sewer pipe, regardless of material, particularly when the pipe is installed in an area with a high water table.

Mandrel testing is generally only required when the video inspection shows significant defects with the installation and the pipe appears to be highly deflected (i.e. more than 7.5%).



Testing of Sewers

Joint Tightness Testing

To ensure the integrity of the assembled gasketed joints of a PVC sewer pipeline, often the designer will require testing after installation is complete. This testing is frequently a requirement for sanitary sewer lines and is a growing trend for storm sewer systems as well. In fact, IPEX has tested all of its sewer pipe at 50 psi.

There are 2 options that may be specified by the designer to test joint tightness – Air Testing or Water Testing. Air testing is preferable where possible because of its accuracy, simplicity and minimal time consumption. Water testing tends to be more expensive than with air, but is advantageous in some situations.

1. Air Testing

Here, the installer must plug both ends of a section of sewer to be tested before subjecting that section of pipe to low pressure air. The air must be maintained at a minimum pressure of 3.5 psi for the specified time period for each diameter shown in the table below. Duration times vary with changes in pipe size and length of test sections. A maximum pressure drop of 0.5 psi is permitted within the specified time duration. If a maximum pressure drop of 1.0 psi is specified, the time values in the table should be doubled.

Should the pressure drop be greater than 0.5 psi within the specified time duration, the installer must locate and repair any deficiencies at his own expense. Re-testing must be performed until a successful test is achieved. Sources of leaks may be dirt in an assembled gasketed joint, incorrectly tightened service saddles or improper plugging or capping of sewer lateral piping. If there is no leakage (i.e. zero pressure drop) after one hour of testing, the section should be passed and presumed free of defects.

If there is groundwater present at a level higher than the pipe invert during the air-test, the test pressure should be increased to a value of 3.5 psi greater than the water head at the bottom of the pipe [to a maximum air test pressure of 5.0 psi].

| Pipe Size in. | Minimum Time min:sec | Length for Minimum Time ft. | Time for Longer Feet Length sec |
|------------------|-------------------------|-----------------------------------|---------------------------------------|
| 4 | 1:53 | 600 | 0.190 F |
| 6 | 2:50 | 400 | 0.427 F |
| 8 | 3:47 | 300 | 0.760 F |
| 10 | 4:43 | 240 | 1.187 F |
| 12 | 5:40 | 200 | 1.709 F |
| 15 | 7:05 | 160 | 2.671 F |
| 18 | 8:30 | 133 | 3.846 F |
| 21 | 9:55 | 114 | 5.235 F |
| 24 | 11:20 | 100 | 6.837 F |
| 27 | 12:45 | 88 | 8.653 F |
| 30 | 14:10 | 80 | 10.683 F |
| 36 | 17:00 | 66 | 15.384 F |
| 42 | 19:54 | 57 | 20.942 F |
| 48 | 22:47 | 50 | 27.352 F |

where L = length of test section in metres
F = length of test section in feet

example - If there is 1.65 ft. of water above the invert of a buried PVC sewer line, what must the air-test pressure be?

solution - The static head of the groundwater at the pipe invert will be:

$$1.64 \text{ ft.} \times (.43 \text{ psi} / \text{ft.}) = .71 \text{ psi}$$

therefore, the total air-test pressure should be:

$$.71 \text{ psi} + 3.5 \text{ psi} = 4.21 \text{ psi}$$

Since this value is less than 5.0 psi, the installer may proceed with the air test using this start pressure.

Knowing the density of water to be 62.4 lb/ft³, the maximum head of groundwater permitted above the invert of a PVC sewer pipe for an air test is 3.3'.

2. Water Testing

Infiltration - The allowable infiltration for any pipe section should be measured by a weir or current meter placed in an appropriate manhole. This is an acceptable method of leakage testing only when the ground-water level is above the top of the pipe throughout the section of line being tested. It is especially useful when the water table is well above the top of the pipe. Usually the designer will give explicit instructions for conducting the test.

Exfiltration - This test is suitable for very dry areas, or where the water table is suitably low that test pressures can easily exceed the static head of the water table. Test pressures should be a minimum of 0.9 psi above the water table head. The test section of pipe shall be filled with water and the leakage rate measured.

For sizes 4" -15", the allowable leakage rate shall be 25 US gal./inch/mile/day. For sizes 18" and larger, the allowable rate for testing shall be 10 US gal./inch/mile/day. Should the allowable leakage rate be exceeded for either an infiltration or exfiltration test, the installer must locate and repair any deficiencies at his own expense until a successful test is conducted. Tests are typically conducted from manhole to manhole.

Deflection Testing

Deflection is the way a flexible pipe reacts to vertical soil loads when buried in a trench. It illustrates how the pipe and surrounding soil work together to easily withstand common and even extreme soil loads.

The maximum deflection of plastic pipe or fittings can be accurately predicted by the designer by knowing the pipe stiffness, soil stiffness and the height of cover. For the majority of underground PVC sewer pipe applications, with proper compaction, the deflection will be well within the recommended maximum allowable of 7.5%. However, if the designer has reason to believe that excessive deflection may be present, a deflection test may be necessary.

There are two commonly used methods of performing deflection tests on PVC sewer pipe:

1. Go-No-Go Device
2. Physical Measurement

1. Go-No-Go Device

The most popular method of the two is the rigid Go-No-Go mandrel. This gage can accurately determine whether the deflection is within specified limits. The test involves the pulling of a mandrel through an installed sewer line. The mandrel will simply get stuck if the actual deflection is beyond the specified limit (normally 7.5%). The mandrel must be designed to have dimensions which exactly match the clearance inside the pipe, at the deflection limit.

Below is a detailed drawing of a suggested mandrel design for 7.5% deflection, along with tables of appropriate dimensions for Ring-Tite, Enviro-Tite and Ultra-Rib Pipes.

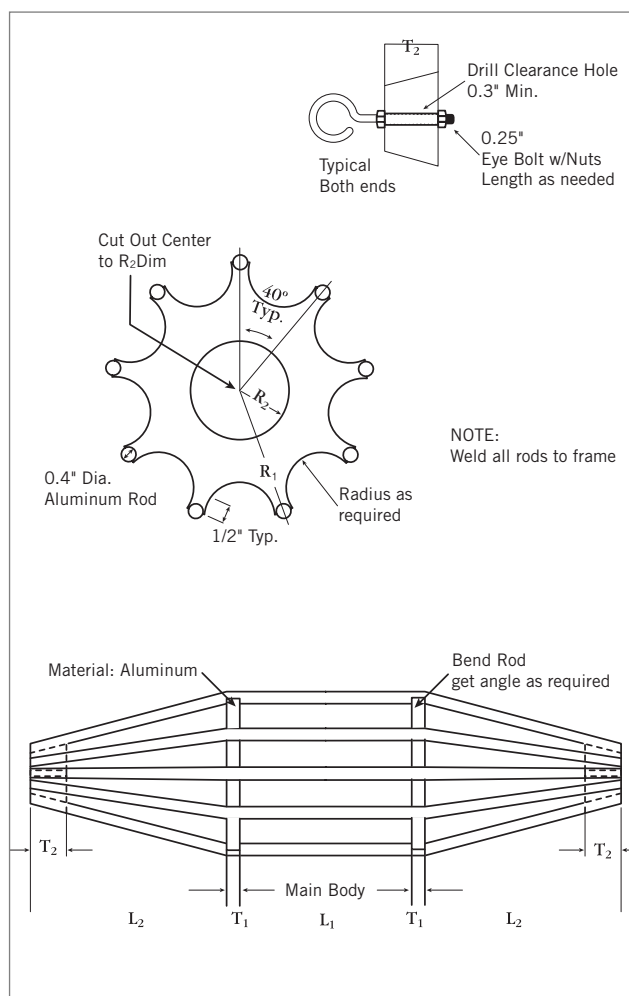



| PVC Sewer Pipe - Mandrel Dimensions | | | | |
|-------------------------------------|-----------|--------|-----|-------|
| Pipe Size | Base I.D. | L1, L2 | R2 | R1 |
| in. | in. | in. | in. | in. |
| 8 | 7.67 | 6 | 1.4 | 3.54 |
| 10 | 9.56 | 8 | 1.6 | 4.42 |
| 12 | 11.36 | 8 | 1.8 | 5.26 |
| 15 | 13.90 | 10 | 2.0 | 6.43 |
| 18 | 16.98 | 12 | 2.2 | 7.85 |
| 21 | 20.00 | 12 | 2.4 | 9.25 |
| 24 | 22.48 | 14 | 2.6 | 10.40 |
| 27 | 25.33 | 14 | 2.8 | 11.71 |
| Ribbed Pipe - Mandrel Dimensions | | | | |
| 8 | 7.7 | 6 | 1.4 | 3.6 |
| 10 | 9.7 | 8 | 1.6 | 4.5 |
| 12 | 11.5 | 8 | 1.8 | 5.3 |
| 15 | 14.1 | 10 | 2.0 | 6.5 |
| 18 | 17.3 | 12 | 2.2 | 8.0 |
| 21 | 20.3 | 12 | 2.4 | 9.4 |
| 24 | 23.0 | 14 | 2.6 | 10.7 |

Notes:

- T1 = 0.4" and T2 = 1" for all sizes of mandrels
- For pipes larger than 27", physical measurement is recommended.
- Two times dimension R1 is critical passing dimension for deflection mandrels.

2. Physical Measurement

To begin this process, one must measure the vertical inside diameter at a particular point in a PVC sewer pipe before it is installed (D1). Next, measure the inside diameter at that same point after the pipe has been installed and completely backfilled (D2). Now, the deflection at that point can be computed as follows:

$$\text{Deflection} = \frac{D1 - D2 \times 100\%}{D1}$$

For accurate results, a micrometer should be used.

Videos

The use of video cameras to inspect the interior of newly installed sewer pipe is very common today. The idea of videotaping the inside of sewer lines was first conceived to fulfill the need to evaluate the decaying condition of older sewers made from traditional pipeline materials such as clay, brick or concrete. The only practical benefit of videos with regard to newly installed PVC sewer pipe is in detecting glaring installation deficiencies such as leaking joints or excessive deflections. Although videos are able to pinpoint the location of a deficiency, they are unable to quantify the magnitude of a problem or whether the deficiency is within allowable limits.



PVC PIPE

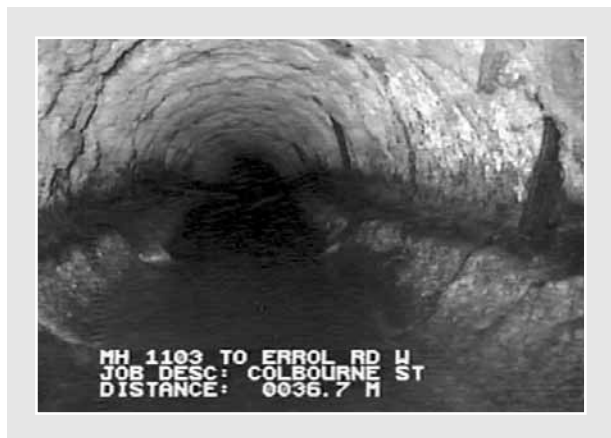

CORRODED CONCRETE PIPE

*This page intentionally
left blank*

APPENDIX A: REFERENCES

- 1 Moser, A.P., "Buried Pipe Design", 2nd Edition, 2001, pp.22
- 2 Spangler Handy, "Soil Engineering", 4th Edition, May 1982, pp.352
- 3 Uni-Bell PVC Pipe Association; "Handbook of PVC Pipe"
4th Edition, August 2001, pp.207
- 4 Hoogensen Metallurgical Engineering Ltd., "Examination of Submitted PVC Pipe Section",
Report to IPEX, December 1998
- 5 Uni-Bell PVC Pipe Association; "Handbook of PVC Pipe"
4th Edition, August 2001, pp.359

APPENDIX B: CALCULATION RESULTS

Sewer Pipe Flows - Imperial Measure

| Slope (ft/ft) | 4" PVC Sewer Pipe | | 6" PVC Sewer Pipe | | 8" Ribbed Pipe & PVC Sewer Pipe | | 10" Ribbed Pipe & PVC Sewer Pipe | | 12" Ribbed Pipe & PVC Sewer Pipe | | 15" Ribbed Pipe & PVC Sewer Pipe | |
|------------------|---------------------------|--|---------------------------|--|------------------------------------|--|-------------------------------------|--|-------------------------------------|--|-------------------------------------|--|
| | Full Velocity, ft/s | Full Flow Capacity, ft ³ /s | Full Velocity, ft/s | Full Flow Capacity, ft ³ /s | Full Velocity, ft/s | Full Flow Capacity, ft ³ /s | Full Velocity, ft/s | Full Flow Capacity, ft ³ /s | Full Velocity, ft/s | Full Flow Capacity, ft ³ /s | Full Velocity, ft/s | Full Flow Capacity, ft ³ /s |
| 0.001 | 1.0 | 0.1 | 1.3 | 0.2 | 1.6 | 0.5 | 1.8 | 1.0 | 2.1 | 1.6 | 2.3 | 2.7 |
| 0.002 | 1.4 | 0.1 | 1.8 | 0.4 | 2.2 | 0.8 | 2.6 | 1.4 | 2.9 | 2.2 | 3.3 | 3.7 |
| 0.003 | 1.7 | 0.1 | 2.2 | 0.4 | 2.7 | 0.9 | 3.2 | 1.7 | 3.5 | 2.7 | 4.1 | 4.6 |
| 0.004 | 2.0 | 0.2 | 2.6 | 0.5 | 3.1 | 1.1 | 3.6 | 1.9 | 4.1 | 3.1 | 4.7 | 5.3 |
| 0.005 | 2.2 | 0.2 | 2.9 | 0.6 | 3.5 | 1.2 | 4.1 | 2.2 | 4.6 | 3.4 | 5.2 | 5.9 |
| 0.006 | 2.4 | 0.2 | 3.2 | 0.6 | 3.8 | 1.3 | 4.5 | 2.4 | 5.0 | 3.8 | 5.7 | 6.5 |
| 0.007 | 2.6 | 0.2 | 3.4 | 0.7 | 4.2 | 1.4 | 4.8 | 2.6 | 5.4 | 4.1 | 6.2 | 7.0 |
| 0.008 | 2.8 | 0.2 | 3.7 | 0.7 | 4.4 | 1.5 | 5.2 | 2.7 | 5.8 | 4.4 | 6.6 | 7.5 |
| 0.009 | 3.0 | 0.3 | 3.9 | 0.7 | 4.7 | 1.6 | 5.5 | 2.9 | 6.1 | 4.6 | 7.0 | 7.9 |
| 0.010 | 3.1 | 0.3 | 4.1 | 0.8 | 5.0 | 1.7 | 5.8 | 3.1 | 6.5 | 4.9 | 7.4 | 8.3 |
| 0.020 | 4.4 | 0.4 | 5.8 | 1.1 | 7.0 | 2.4 | 8.2 | 4.3 | 9.2 | 6.9 | 10.5 | 11.8 |
| 0.030 | 5.4 | 0.5 | 7.1 | 1.4 | 8.6 | 2.9 | 10.0 | 5.3 | 11.2 | 8.4 | 12.8 | 14.5 |
| 0.040 | 6.3 | 0.5 | 8.2 | 1.6 | 9.9 | 3.4 | 11.5 | 6.1 | 12.9 | 9.7 | 14.8 | 16.7 |
| 0.050 | 7.0 | 0.6 | 9.2 | 1.8 | 11.1 | 3.8 | 12.9 | 6.8 | 14.5 | 10.9 | 16.6 | 18.7 |
| 0.060 | 7.7 | 0.7 | 10.0 | 1.9 | 12.2 | 4.1 | 14.1 | 7.5 | 15.9 | 11.9 | 18.1 | 20.4 |
| 0.070 | 8.3 | 0.7 | 10.9 | 2.1 | 13.1 | 4.5 | 15.2 | 8.1 | 17.1 | 12.9 | 19.6 | 22.1 |
| 0.080 | 8.9 | 0.8 | 11.6 | 2.2 | 14.1 | 4.8 | 16.3 | 8.6 | 18.3 | 13.8 | 21.0 | 23.6 |
| 0.090 | 9.4 | 0.8 | 12.3 | 2.4 | 14.9 | 5.1 | 17.3 | 9.2 | 19.4 | 14.6 | 22.2 | 25.0 |
| 0.100 | 9.9 | 0.9 | 13.0 | 2.5 | 15.7 | 5.3 | 18.2 | 9.7 | 20.5 | 15.4 | 23.4 | 26.4 |



MULTI FITTINGS

| Slope (ft/ft) | 18" Ribbed Pipe & PVC Sewer Pipe | | 21" Ribbed Pipe & PVC Sewer Pipe | | 24" Ribbed Pipe & PVC Sewer Pipe | | 27" PVC Sewer Pipe | | 30" PVC Sewer Pipe | | 36" PVC Sewer Pipe | | 42" PVC Sewer Pipe | |
|------------------|-------------------------------------|--|-------------------------------------|--|-------------------------------------|--|---------------------------|--|---------------------------|--|---------------------------|--|---------------------------|--|
| | Full Velocity, ft/s | Full Flow Capacity, ft ³ /s | Full Velocity, ft/s | Full Flow Capacity, ft ³ /s | Full Velocity, ft/s | Full Flow Capacity, ft ³ /s | Full Velocity, ft/s | Full Flow Capacity, ft ³ /s | Full Velocity, ft/s | Full Flow Capacity, ft ³ /s | Full Velocity, ft/s | Full Flow Capacity, ft ³ /s | Full Velocity, ft/s | Full Flow Capacity, ft ³ /s |
| 0.001 | 2.7 | 4.6 | 3.0 | 7.0 | 3.3 | 9.8 | 3.5 | 13.3 | 3.8 | 19.1 | 4.3 | 30.8 | 4.8 | 45.9 |
| 0.002 | 3.8 | 6.5 | 4.2 | 9.9 | 4.6 | 13.9 | 5.0 | 18.8 | 5.4 | 27.0 | 6.1 | 43.6 | 6.8 | 65.0 |
| 0.003 | 4.7 | 7.9 | 5.2 | 12.2 | 5.6 | 17.0 | 6.1 | 23.0 | 6.7 | 33.0 | 7.5 | 53.3 | 8.3 | 79.6 |
| 0.004 | 5.4 | 9.1 | 6.0 | 14.1 | 6.5 | 19.6 | 7.0 | 26.6 | 7.7 | 38.1 | 8.7 | 61.6 | 9.6 | 91.9 |
| 0.005 | 6.0 | 10.2 | 6.7 | 15.7 | 7.3 | 21.9 | 7.9 | 29.8 | 8.6 | 42.6 | 9.7 | 68.9 | 10.7 | 102.7 |
| 0.006 | 6.6 | 11.2 | 7.3 | 17.2 | 8.0 | 24.0 | 8.6 | 32.6 | 9.4 | 46.7 | 10.6 | 75.4 | 11.7 | 112.5 |
| 0.007 | 7.1 | 12.1 | 7.9 | 18.6 | 8.6 | 25.9 | 9.3 | 35.2 | 10.2 | 50.5 | 11.5 | 81.5 | 12.7 | 121.5 |
| 0.008 | 7.6 | 12.9 | 8.5 | 19.9 | 9.2 | 27.7 | 9.9 | 37.6 | 10.9 | 53.9 | 12.2 | 87.1 | 13.5 | 129.9 |
| 0.009 | 8.1 | 13.7 | 9.0 | 21.1 | 9.8 | 29.4 | 10.5 | 39.9 | 11.5 | 57.2 | 13.0 | 92.4 | 14.4 | 137.8 |
| 0.010 | 8.5 | 14.4 | 9.5 | 22.2 | 10.3 | 31.0 | 11.1 | 42.1 | 12.1 | 60.3 | 13.7 | 97.4 | 15.1 | 145.3 |
| 0.020 | 12.0 | 20.4 | 13.4 | 31.4 | 14.5 | 43.8 | 15.7 | 59.5 | 17.2 | 85.3 | 19.4 | 137.7 | 21.4 | 205.4 |
| 0.030 | 14.7 | 25.0 | 16.4 | 38.5 | 17.8 | 53.7 | 19.2 | 72.9 | 21.0 | 104.5 | 23.7 | 168.7 | 26.2 | 251.6 |
| 0.040 | 17.0 | 28.9 | 18.9 | 44.5 | 20.6 | 62.0 | 22.2 | 84.2 | 24.3 | 120.6 | 27.4 | 194.8 | 30.3 | 290.5 |
| 0.050 | 19.0 | 32.3 | 21.2 | 49.7 | 23.0 | 69.3 | 24.8 | 94.1 | 27.2 | 134.9 | 30.6 | 217.8 | 33.8 | 324.8 |
| 0.060 | 20.8 | 35.4 | 23.2 | 54.4 | 25.2 | 75.9 | 27.2 | 103.1 | 29.8 | 147.7 | 33.5 | 238.6 | 37.1 | 355.8 |
| 0.070 | 22.5 | 38.2 | 25.0 | 58.8 | 27.2 | 82.0 | 29.4 | 111.3 | 32.1 | 159.6 | 36.2 | 257.7 | 40.0 | 384.3 |
| 0.080 | 24.0 | 40.8 | 26.8 | 62.9 | 29.1 | 87.6 | 31.4 | 119.0 | 34.4 | 170.6 | 38.7 | 275.5 | 42.8 | 410.8 |
| 0.090 | 25.5 | 43.3 | 28.4 | 66.7 | 30.9 | 92.9 | 33.3 | 126.2 | 36.4 | 180.9 | 41.1 | 292.2 | 45.4 | 435.8 |
| 0.100 | 26.9 | 45.7 | 29.9 | 70.3 | 32.5 | 98.0 | 35.1 | 133.1 | 38.4 | 190.7 | 43.3 | 308.0 | 47.9 | 459.3 |

APPENDIX C: REFERENCE TABLES AND CONVERSION CHARTS

| | |
|-----------|---|
| Table C-1 | Weights of Water |
| Table C-2 | Length Conversion |
| Table C-3 | Decimal & Millimeter Equivalents of Fractions |
| Table C-4 | Volume Conversion |
| Table C-5 | Pressure Conversion |
| Table C-6 | Flow Conversion |

Table C-1 Weights of Water

| Units of Volume | Weight (lbs) |
|-----------------|--------------|
| 1 US Gallon | 8.350 |
| 1 cubic yard | 1,685.610 |
| 1 cubic foot | 62.430 |
| 1 cubic inch | 0.036 |

Table C-2 Length Conversion

| Units of Length | in. | ft. | yd. | mile |
|-----------------|-----|--------|--------|------|
| inch | 1 | 0.0833 | 0.0278 | - |
| foot | 12 | 1 | 0.333 | - |
| yard | 36 | 3 | 1 | - |
| mile | - | 5280 | 1760 | 1 |



Table C-3 Decimal Equivalentents of Fractions

| Fractions | Decimals | Fractions | Decimals |
|-----------|----------|-----------|----------|
| 1/64 | 0.515625 | 33/64 | 0.515625 |
| 1/32 | 0.03125 | 17/32 | 0.53125 |
| 3/64 | 0.046875 | 35/64 | 0.546875 |
| 1/16 | 0.0625 | 9/16 | 0.5625 |
| 5/64 | 0.078125 | 37/64 | 0.578125 |
| 3/32 | 0.09375 | 19/32 | 0.59375 |
| 7/64 | 0.109375 | 39/64 | 0.609375 |
| 1/8 | 0.125 | 5/8 | 0.625 |
| 9/64 | 0.140625 | 41/64 | 0.640625 |
| 5/32 | 0.15625 | 21/32 | 0.65625 |
| 11/64 | 0.171875 | 43/64 | 0.671875 |
| 3/16 | 0.1875 | 11/16 | 0.6875 |
| 13/64 | 0.203125 | 45/64 | 0.703125 |
| 7/32 | 0.21875 | 23/32 | 0.71875 |
| 15/64 | 0.23475 | 47/64 | 0.734375 |
| 1/4 | 0.250 | 3/4 | 0.750 |
| 17/64 | 0.265625 | 49/64 | 0.765625 |
| 9/32 | 0.28125 | 25/32 | 0.78125 |
| 19/64 | 0.296875 | 51/64 | 0.796875 |
| 5/16 | 0.3125 | 13/16 | 0.8125 |
| 21/64 | 0.328125 | 53/64 | 0.828125 |
| 11/32 | 0.34375 | 27/32 | 0.83475 |
| 23/64 | 0.359375 | 55/64 | 0.859375 |
| 3/8 | 0.375 | 7/8 | 0.875 |
| 25/64 | 0.390625 | 57/64 | 0.890625 |
| 13/32 | 0.40625 | 29/32 | 0.90625 |
| 27/64 | 0.421875 | 59/64 | 0.921875 |
| 7/16 | 0.4375 | 15/16 | 0.9375 |
| 29/64 | 0.453125 | 61/64 | 0.953125 |
| 15/32 | 0.46875 | 31/32 | 0.96875 |
| 31/64 | 0.484375 | 63/64 | 0.984375 |
| 1/2 | 0.500 | 1 | 1.000 |

Table C-4 Volume Conversion

| Units of Volume | in ³ | ft ³ | yd ³ | U.S. gal. |
|-----------------|-----------------|-----------------|-----------------|-----------|
| cubic inch | 1 | 0.00058 | - | 0.0043 |
| cubic foot | 1728 | 1 | 0.0370 | 7.481 |
| cubic yard | 46,656 | 27 | 1 | 201.97 |
| U.S. gallon | 231 | 0.1337 | 0.0050 | 1 |

Table C-5 Pressure Conversion

| Units of Pressure | atm | bar | lb/in ² | lb/ft ² | inch H ₂ O | inch Hg | inch air | ft H ₂ O | ft air | N/m ² |
|--|---------|---------|--------------------|--------------------|-----------------------|---------|----------|---------------------|--------|------------------|
| atmosphere (atm) | 1 | 0.987 | 0.068 | - | 0.002 | 0.033 | - | 0.029 | - | - |
| bar | 1.013 | 1 | 0.069 | - | 0.002 | 0.034 | - | 0.03 | - | - |
| pound per square inch (psi) | 14.7 | 14.5 | 1 | 0.007 | 0.036 | 0.491 | - | 0.434 | 0.001 | - |
| pound per square foot (psf) | 2,116 | 2,089 | 144 | 1 | 5.2 | 70.73 | 0.006 | 62.43 | 0.076 | 0.021 |
| inch of water (H ₂ O) (4°C) | 406.78 | 401.46 | 27.68 | 0.192 | 1 | 13.6 | 0.001 | 12 | 0.015 | 0.004 |
| inch of mercury (Hg) (0°C) | 29.921 | 29.53 | 2.036 | 0.014 | 0.074 | 1 | - | 0.883 | 0.001 | - |
| inch of air (15°C) | 332,005 | 327,664 | 22,592 | 148.7 | 816.2 | 11,096 | 1 | 9,794 | 12 | 3.106 |
| foot of water (4°C) | 33.9 | 33.46 | 2.307 | 0.016 | 0.083 | 1.133 | - | 1 | - | - |
| foot of air (15°C) | 27,677 | 27,305 | 1,883 | 13.07 | 0.006 | 924.7 | 0.083 | 816.2 | 1 | 0.273 |
| Newton per square meter | - | - | - | 0.021 | 0.004 | - | 3.277 | - | 0.273 | 1 |

Table C-6 Flow Conversion

| Units of Flow Rate | US gps | US gpm | US gph | US gpd | Imp gps | Imp gpm | Imp gph | Imp gpd |
|--------------------|--------|--------|--------|--------|---------|----------|---------|---------|
| US gal/sec (gps) | 1 | 0.017 | - | - | 1.2 | 0.02 | - | - |
| US gal/min (gpm) | 60 | 1 | 0.017 | 0.001 | 72.06 | 1.2 | 0.02 | 0.001 |
| US gal/hr (gph) | 3,600 | 60 | 1 | 0.042 | 4,323 | 72.06 | 1.2 | 0.05 |
| US gal/day (gpd) | 86,400 | 1,440 | 24 | 1 | 103,762 | 1,729.40 | 28.82 | 1.2 |
| Acre in/min | 0.002 | - | - | - | 0.003 | - | - | - |
| Acre in/hr | 0.133 | 0.002 | - | - | 0.159 | 0.003 | - | - |
| Acre in/day | 3.182 | 0.053 | 0.001 | - | 3.821 | 0.064 | 0.001 | - |

| Units of Flow Rate | ft ³ /sec | ft ³ /min | ft ³ /hr | ft ³ /day | Acre in/min | Acre in/hr | Acre in/day |
|--------------------|----------------------|----------------------|---------------------|----------------------|-------------|------------|-------------|
| US gal/sec (gps) | 7.48 | 0.125 | 0.002 | - | 452.6 | 7.54 | 0.31 |
| US gal/min (gpm) | 448.8 | 7.48 | 0.125 | 0.005 | 27,154 | 452.6 | 18.86 |
| US gal/hr (gph) | 26,930 | 448.83 | 7.481 | 0.312 | 1.629E+06 | 27,154 | 1,131 |
| US gal/day (gpd) | 646,317 | 10,772 | 179.53 | 7.481 | 3.910E+07 | 651,703 | 27,154 |
| Cubic ft/sec (cfs) | 1 | 0.017 | - | - | 60.5 | 1.008 | 0.042 |
| Cubic ft/min (cfm) | 60 | 1 | 0.017 | - | 3,630 | 60.5 | 2.52 |
| Cubic ft/hr (cfh) | 3,600 | 60 | 1 | 0.042 | 217,800 | 3,630 | 151.25 |
| Cubic ft/day (cfd) | 86,400 | 1,440 | 24 | 1 | 5.227E+06 | 87,120 | 3,630 |
| Acre in/min | 0.017 | - | - | - | 1 | 0.017 | 0.001 |
| Acre in/hr | 0.992 | 0.001 | - | - | 60 | 1 | 0.042 |
| Acre in/day | 23.8 | 0.033 | 0.006 | - | 1,440 | 24 | 1 |



APPENDIX D: USEFUL FORMULAS

- Area of a Circle
- Circumference of a Circle
- Length of Circular Arc
- Area of Circle Sector
- Equation of a Circle (cartesian coordinates)
- Equation of a Line (quadratic formula)
- Basic Trigonometric Functions
- Area of an Ellipse
- Circumference of an Ellipse
- Area of a Triangle
- Area of a Trapezoid
- Area of a Parallelogram
- Surface Area of a Sphere
- Volume of a Sphere
- Surface Area of a Cylinder
- Volume of a Cylinder
- Surface Area of an Elliptical Tank
- Volume of an Elliptical Tank
- Surface Area of a Cone
- Volume of a Cone
- Surface Area of a Rectangular Solid
- Volume of a Rectangular Solid

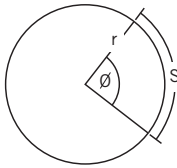

Circle

Diameter = $2R$
 Circumference = $\pi D = 2\pi R$
 Area = πR^2

Length of Circular Arc

$$S = \theta \times \left(\frac{\pi}{180}\right) \times r \quad \theta \text{ in degrees}$$

$$S = \theta \times r \quad \theta \text{ in radians}$$

Area of Circle Sector

$$A = \theta \times \left(\frac{\theta}{360}\right) \times \pi \times r^2 \quad \theta \text{ in degrees}$$

$$A = \theta \times \left(\frac{\theta}{2}\right) \times r^2 \quad \theta \text{ in radians}$$

Equation of a Circle (cartesian co-ordinates)
 - for a circle with center (j, k) and radius (r)

$$(x - j)^2 + (y - k)^2 = r^2$$

Equation of a line (quadratic formula)

$$ax + by + c = 0$$

or

$$ax^2 + bx + c = 0$$

$$x = \frac{-b \pm \sqrt{b^2 - 4ac}}{2a}$$

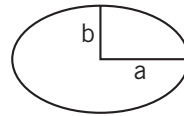

Ellipse

Area = $\pi \times a \times b$
 Circumference = $\frac{1 + 4(a-b)^2}{((3a + 5b)(5a + 3b))}$

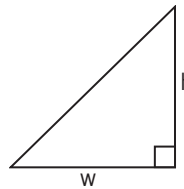

Triangle

$$\text{Area} = \frac{w \times h}{2}$$

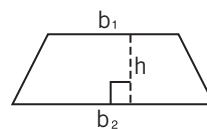

Trapezoid

$$\text{Area} = \frac{1}{2} (b_1 + b_2) \times h$$

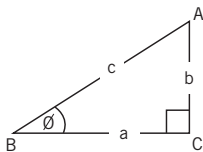

Trigonometry

$$\sin \theta = \frac{b}{c}$$

$$\cos \theta = \frac{a}{c}$$

$$\tan \theta = \frac{b}{a}$$

Sine Law

$$\frac{a}{\sin A} = \frac{b}{\sin B} = \frac{c}{\sin C} = 2R$$

Cosine Law

$$C^2 = a^2 + b^2 - 2ab \cos C$$

$$b^2 = a^2 + c^2 - 2ac \cos B$$

$$a^2 = b^2 + c^2 - 2bc \cos A$$

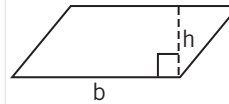

Parallelogram

$$\text{Area} = b \times h$$

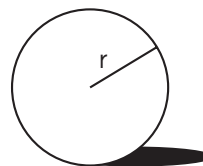

Sphere

$$\text{Surface Area} = 4 \pi r^2$$

$$\text{Volume} = \frac{4}{3} \pi r^3$$

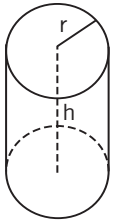

Cylinder

$$\text{Surface Area} = (2 \pi r^2) + (2 \pi r h)$$

$$\text{Volume} = \pi r^2 h$$

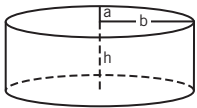

Elliptical Tank

$$\text{Surface Area} = 2 \pi \left(\frac{\sqrt{a^2 + b^2}}{2} \right) h + (2\pi ab)$$

$$\text{Volume} = \pi abh$$

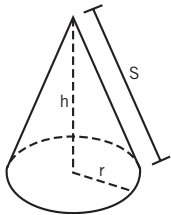

Cone

$$\text{Surface Area} = \pi r S$$

$$\text{Volume} = \pi r^2 \times \frac{h}{3}$$

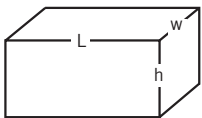

Rectangular Solid

$$\text{Surface Area} = 2 (Lw + Lh + wh)$$

$$\text{Volume} = L \times w \times h$$

APPENDIX E: ABBREVIATIONS

| | |
|-------|---|
| AGA | - American Gas Association |
| ANSI | - American National Standards Institute |
| API | - American Petroleum Institute |
| ASME | - American Society of Mechanical Engineers |
| ASTM | - American Society for Testing and Materials |
| AWWA | - American Water Works Association |
| BNQ | - Bureau de Normalization du Quebec |
| BOCA | - Building Officials and Code Administrators |
| BS | - British Standards Institution |
| CPVC | - Chlorinated poly (vinyl chloride) plastic or resin |
| CS | - Commercial Standard, see Product Standard |
| CSA | - Canadian Standards Association |
| DR | - Dimension Ratio |
| DIN | - German Industrial Norms |
| FHA | - Federal Housing Administration or Farmers Home Administration |
| HDB | - Hydrostatic design basis |
| HDS | - Hydrostatic design stress |
| IAPD | - International Association of Plastics Distributors |
| IAPMO | - International Association of Plumbing and Mechanical Officials |
| IPC | - International Plumbing Code |
| ISO | - International Standards Organization |
| JIS | - Japanese Industrial Standards |
| NSF | - National Sanitation Foundation International |
| PPI | - Plastics Pipe Institute |
| PS | - Product Standard when in reference to a specification for plastic pipe and fittings. These specifications are promulgated by the U.S. Department of Commerce and were formerly known as Commercial Standards. |
| PSI | - Pounds per square inch |
| PSIG | - Gage pressure in pounds per square inch |
| PVC | - Poly (vinyl chloride) plastic or resin |
| RVCM | - Residual Vinyl Chloride Monomer |
| SCS | - Soil Conservation Service |
| SDR | - Standard Dimension Ratio |
| SI | - International System of Units |
| SPI | - Society of the Plastics Industry, Inc. |
| UPC | - Uniform Plumbing Code |
| USASI | - United States of America Standards Institute (formerly American Standards Association) |
| WOG | - Water, Oil, Gas |

MULTI FITTINGS LITERATURE

Our comprehensive documentation will provide useful information for you from product information to product installation.



Multi Fittings Overview



Multi Fittings Technical Manual



Multi Fittings Product Info Bulletins



Multi Fittings Installation Guide



Trench Tough Plus Multimedia CD

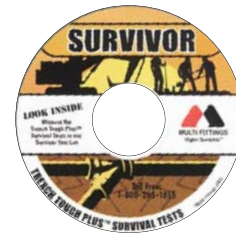

Survivor Multimedia CD



COMPLETE and **FAX** the attached form for more information about our products.

Or **EMAIL** us at marketing@multifittings.com

fax to Us

For more information about our products and new products offering, complete this card and fax it back to us at (519) 661-2156

Name _____ Title _____
 Company _____ Address _____
 City _____ Province/State _____ Postal Code/Zip _____
 Phone (____) _____ Fax (____) _____ E-mail _____

find out more

Company Classification:
 Architect/Design Firm
 Builder/Contractor
 Contractor
 Distributor/Wholesaler
 Engineering Firm
 Government
 Other _____

I am primarily interested in the following (check all that apply):
 Trench Tough Plus® PVC
 Solvent Weld PVC
 Blue Sinter® PVC
 Cycle Tough® PVC
 Ultra RAP® PVC
 Backwater valves

MULTI FITTINGS
 www.multifittings.com

Multi Fittings Corp.
1055 Wilton Grove Road
London, Ontario N6A 4K3

Telephone: 519 681-2140
Toll Free: 800 265-1815
Fax: 519 681-2156



www.multifittings.com

WARRANTY: All of the company's Products are guaranteed against defects resulting from faulty workmanship or materials. The Company will replace, free of charge, including shipping charges for the replacement Products, any Products which are found to be defective in workmanship or material, provided that the following conditions are met:

- a) the Company is promptly notified in writing of such defect immediately upon discovery of same, and the defective Product is promptly returned to the Company;
- b) the defect is not due, without limitation, to faulty installation, misalignment of Products, vibration, ordinary wear and tear, corrosion, erosion, U.V. degradation, incompatible lubricants, pastes and thread sealants, unusual pressure surges or pulsation, water hammer, temperature shocking, or fouling; and
- c) the Products have not been altered or modified after leaving the Company's premises.

The warranty period can be specifically limited for certain Products as stated in writing in the Company's literature. The Company will not allow claims for labor, materials and/or other expenses required to replace the defective Product, or to repair any damage resulting from the use thereof. The Company disclaims any responsibility for the Purchaser's calculations, product drawings or engineering design specifications. The Company's liability is limited to the purchase price applicable to the product.

It is agreed and understood that the Company's liability in respect to the sale is strictly limited to the replacement of Products as hereinbefore specified and that the Company shall not, in any event, be liable for any damages whether for the loss of use or business interruption or any other claim for incidental, consequential, special or punitive damages. There is no warranty, condition or representation of any nature whatsoever, expressed or implied, by statute or otherwise, except as herein contained, and the Company disclaims any implied warranties of merchantability and/or fitness of its Products for a special purpose.

This literature is published in good faith and is believed to be reliable. However Multi Fittings does not represent and/or warrant in any manner the information and suggestions contained in this brochure. Data presented is the result of laboratory tests and field experience.

Multi Fittings maintains a policy of ongoing product improvement. This may result in modifications of features and/or specifications without notice.



MULTI FITTINGS
HIGHER STANDARDS™