

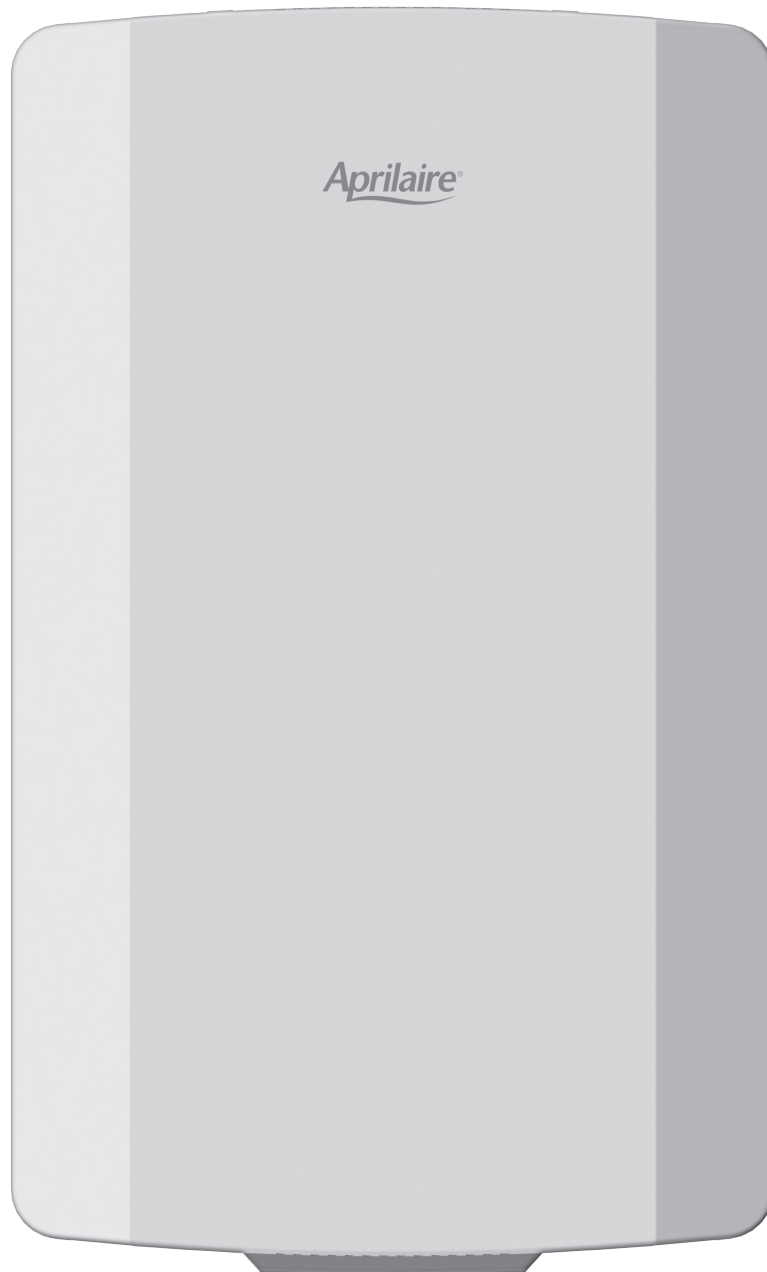

Model 6404 & 6403 Zoned Comfort Control®

Safety & Installation Instructions



READ AND SAVE THESE INSTRUCTIONS

TABLE OF CONTENTS

SAFETY INSTRUCTIONS	2
SPECIFICATIONS	3
APPLICATION & ACCESSORIES	3
ZONE PANEL LAYOUT	4
INSTALLATION	5
Mounting	5
Installation Location Recommendations	5
WIRING	6
Select and Wire the Transformer to the Control Panel	7
Zone Damper Wiring	8
Discharge Air Temperature Sensor (Included)	9
Outdoor Temperature Sensor (Optional)	9
Expansion Panels (Optional – Model 6404 Only)	10
Thermostat Terminal Definitions	11
HVAC Terminal Definitions	11
Two-Stage Furnace and A/C	12
Two-Stage Heat Pump	12
Boiler and A/C	12
Radiant Floor First-Stage Heat, Furnace Second-Stage Heat and A/C	12
INSTALLER SETUP	13
How to Configure	13
LCD Installer Screen Settings & Descriptions	14
Sequence of Operation	15
LCD Home Screen Display & Descriptions	17
INSTALLER CHECKOUT	18
LIMITED WARRANTY	19

SAFETY INSTRUCTIONS

Read this installation manual before beginning installation of the Aprilaire® Zoned Comfort Control® system. For questions call Aprilaire customer support at (800) 334-6011 or visit AprilairePartners.com.

WARNING

1. 120 Volts may cause serious injury from electrical shock. Leave power disconnected until installation is complete.
2. The zone panel is designed for indoor use only. Do not expose any of the components to moisture.

CAUTION

1. Turn off the system power before removing or installing any wires into the terminals of any component on the system. Wiring with a live circuit can lead to electrical shorts that can damage components.
2. Installation must be done in accordance with all applicable codes.
3. Installer should touch a grounded metal object before handling the zone panel. This will prevent any static discharge that may cause damage.
4. A zone panel may not control temperature properly unless the heating and cooling system is properly sized and balanced.
5. Insufficient air flow or excessive temperatures through the heating and cooling system could result in equipment damage. Refer to the manufacturer's recommendations for minimum safe airflow and temperature requirements.
6. Install an outdoor control to prevent non-seasonal equipment starts if using auto changeover thermostats.
7. Do not mount the zone panel on any exterior wall or equipment supply ductwork.
8. Do not install the zone panel where temperatures exceed 158°F (70°C) or are below 32°F (0°C), non-condensing.
9. Improper system installation could cause water damage from frozen pipes. Check system operation after installation.

SPECIFICATIONS

INPUT RATINGS

Voltage: 18-30VAC 50/60 Hz

MAXIMUM CURRENT

Damper output per zone (fused): 18VA at 158°F, 30VA at 90°F

Zone panel and thermostats (fused): 18VA at 158°F, 30VA at 90°F

Zone panel consumption: 4VA max

NOTE: Use 18 or 20 AWG solid (**non-stranded**) wire

ENVIRONMENT

Temperature (operating): 32°F – 158°F

Temperature (shipping): -40°F – 165°F

Humidity: 5% – 90%, non-condensing

DIMENSIONS

See **FIGURE 1**.

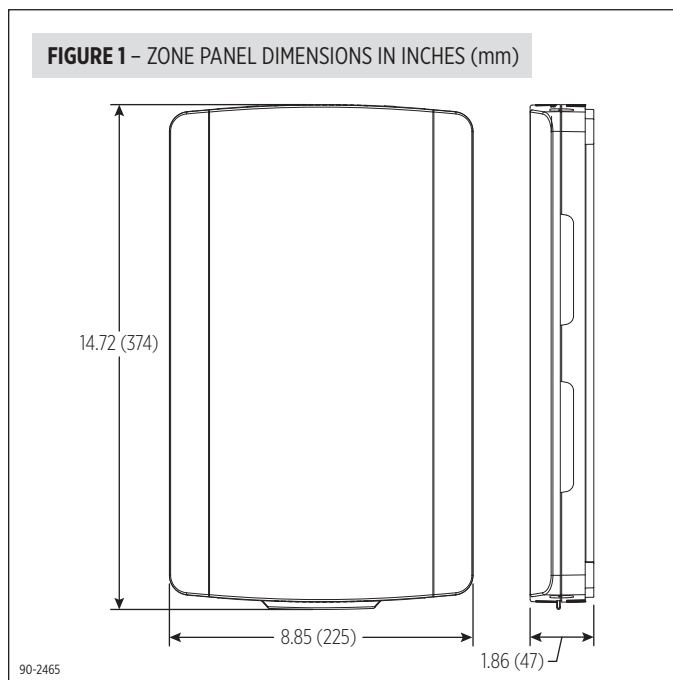

APPLICATION & ACCESSORIES

APPLICATION

The Model 6404 or 6403 Zone Panel can be configured to control heat pump or conventional applications. The Model 6403 can control up to 3 zones. The 6404 can control up to 4 zones and is expandable up to 12 with the use of the Model 6401 2-zone expansion panel. The features include:

- 2 heating and two 2 cooling stages (conventional)
- 4 heating and 2 cooling stages (heat pump)
- Integrated balance point control
- Equipment protection

ACCESSORIES

- **Discharge Air Temperature Sensor (DAT):**
Model 8052 (included)
- **Outdoor Temperature Sensor (ODT):**
Model 8052 (optional)
- **Two Zone Expansion Panel:**
Model 6401 (optional)

ZONE PANEL LAYOUT

TERMINALS

1. HVAC – HVAC connection
2. ZONE 1 THERMOSTAT – Thermostat connection
3. ZONE 2 THERMOSTAT – Thermostat connection
4. ZONE 3 THERMOSTAT – Thermostat connection
5. ZONE 4 THERMOSTAT (6404 only) – Thermostat connection
6. DAMPER 1 – Zone 1 damper connection
7. DAMPER 2 – Zone 2 damper connection
8. DAMPER 3 – Zone 3 damper connection
9. DAMPER 4 (6404 only) – Zone 4 damper connection
10. REMOTE SENSORS DAT (Discharge Air Temperature)
11. REMOTE SENSORS ODT (Outdoor Air Temperature)
12. EXPANSION (6404 only) – Expansion port (Model 6401)
13. DAMPER POWER – Damper power (dedicated 24VAC)
14. POWER – Zone panel and thermostat power (dedicated 24VAC)

LEDs

15. POWER – Green: 24VAC is present. Flashing: TDO button is pressed.
16. HEATING – Green: Heating is active. Flashing: DAT high temperature limit reached.
17. COOLING – Green: Cooling is active. Flashing: DAT low temperature limit reached.
18. FAN – Green: Fan output is active.
19. ZONE 1 – Green: Damper is open. Red: Damper is closed.
20. ZONE 2 – Green: Damper is open. Red: Damper is closed.
21. ZONE 3 – Green: Damper is open. Red: Damper is closed.
22. ZONE 4 – Green: Damper is open. Red: Damper is closed.
23. EM HEAT – Amber: Emergency Heat mode is enabled using the EM Heat button or an Emergency Heat call is active based on a thermostat Emergency Heat call.
24. VACATION – Green: Vacation mode is enabled.

BUTTONS

25. EM HEAT – Used to enable/disable Emergency Heat mode. In Emergency Heat mode the compressor will be locked out and only auxiliary heat will be used to satisfy heating calls. **NOTE:** The EM Heat button does not function when the zone panel is configured to control conventional equipment.
26. VACATION – Used to enable/disable Vacation mode. In Vacation mode all zones will be controlled by the thermostat in Zone 1.
27. Navigation buttons – Used for installer setup and checkout.
28. TDO (Time Delay Override) – Accelerates timing (6 seconds = 1 minute). Used to speed up equipment protection minimum on and off timers.

LCD

29. In normal operation, displays zone panel status. In installer setup, used to configure the zone panel. In installer checkout, used to step through the installer test.

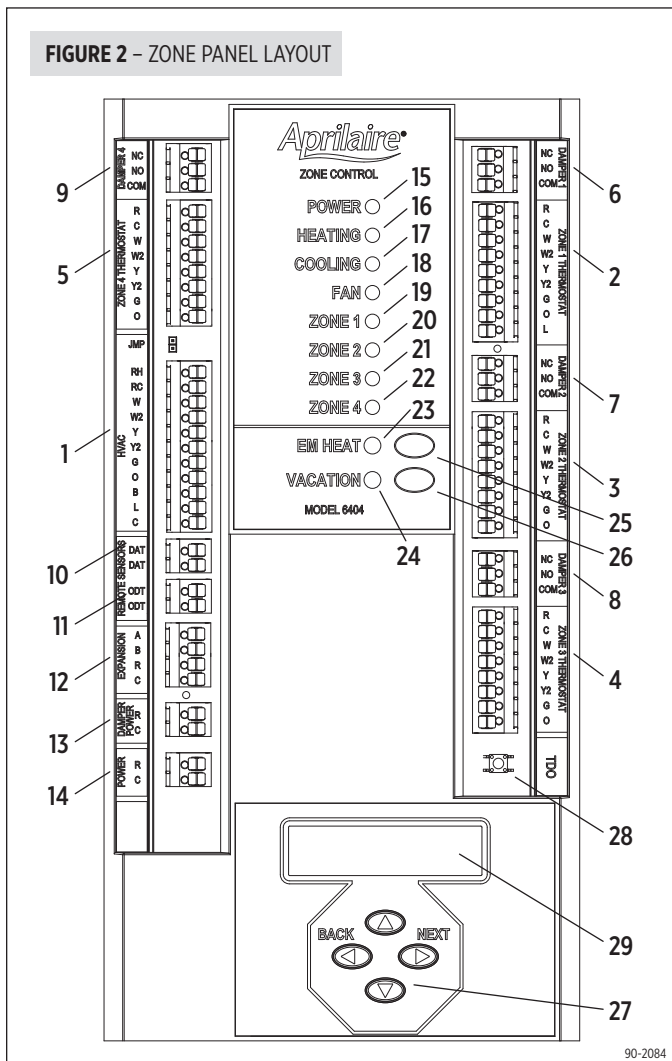

INSTALLATION

MOUNTING

1. Separate the zone panel cover from the base. See **FIGURE 3**.
2. Use the base as a template to drill mounting holes. See **FIGURE 4** for mounting hole locations.
3. Attach the base to an interior wall, stud or return duct.

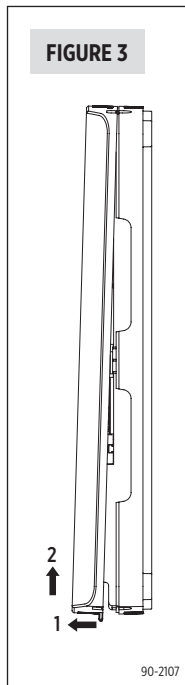
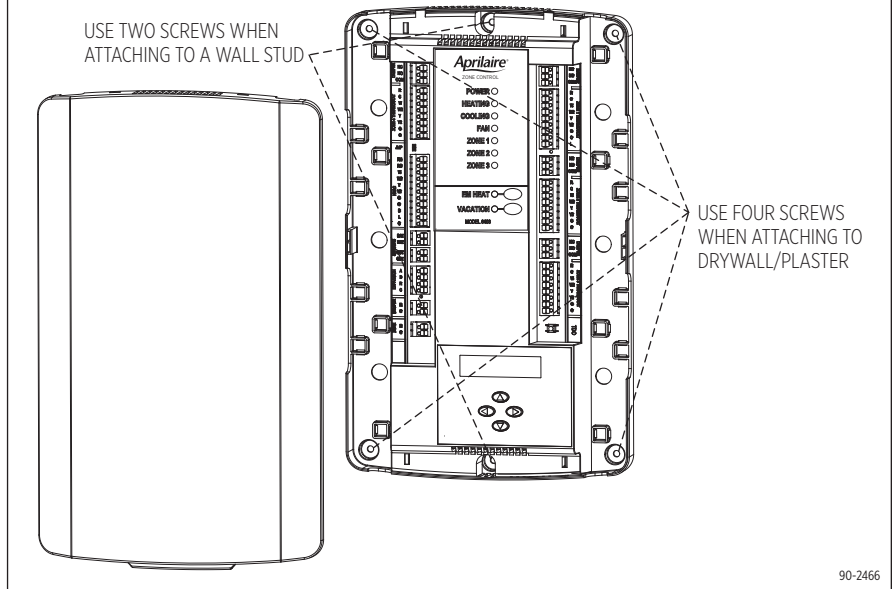

FIGURE 4 – MOUNTING HOLE LOCATIONS



INSTALLATION LOCATION RECOMMENDATIONS

1. Mount the zone panel near the HVAC equipment. Locate the panel on an interior wall, stud or return duct. See **FIGURE 5**.
2. Locate the Discharge Air Temperature (DAT) in the supply trunk, downstream of the heat exchanger and cooling coils, and before the zone dampers (refer to the shaded areas of **FIGURE 5**). **NOTE:** Do not mount the sensor in direct line-of-sight of the heat exchanger, cooling coils or UV lights as this may cause the sensor to report false temperature readings. Do not route wires along 120VAC lines.
3. Before wiring the sensor to the control panel, measure the resistance across the sensor. The resistance corresponds (approximately) to the sensed temperature according to the following table:

Temperature (°F)	30	40	50	60	70	80	90	100
Resistance (kΩ)	34.6	26.1	19.9	15.3	11.9	9.4	7.4	5.9

FIGURE 5 – LOCATION RECOMMENDATIONS

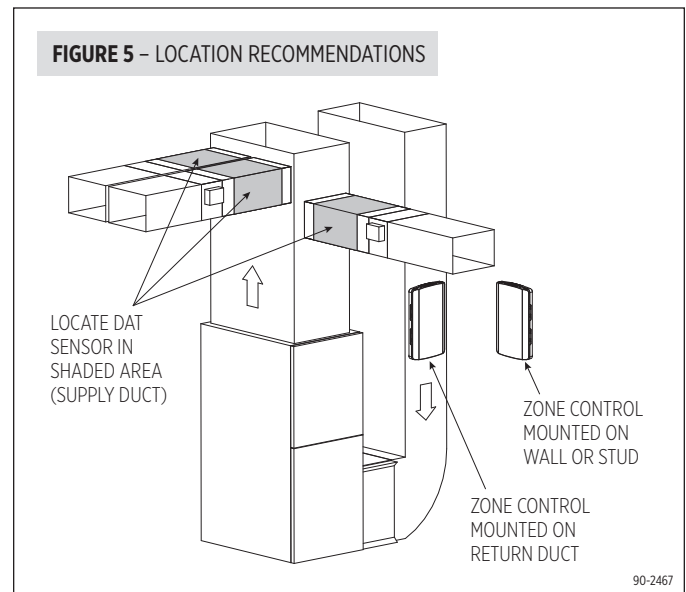

WIRING

WARNING

120 volts may cause serious injury from electrical shock. Sudden operation may cause serious injury from moving parts. Leave power disconnected until installation is complete.

Follow these steps for all system connections. Wiring will vary depending on equipment.

See page 12 for complete wiring diagram examples.

Wiring of the zone panel must comply with applicable codes, ordinances and regulations.

- Use only 18 or 20 gauge solid (**non-stranded**) wire.
- Strip off 7/16" of insulation from the wire.
- Push wire into the terminal of the zone panel.
- To release the wire, press down on the top of the terminal and pull the wire out.
- The zone panel supports multiple options to route and anchor wires to the housing. See **FIGURE 6**.

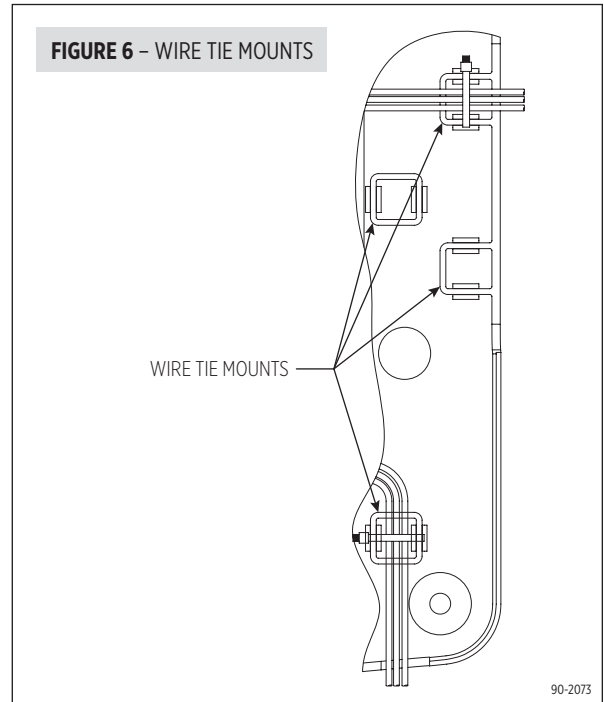

SELECT AND WIRE THE TRANSFORMER TO THE CONTROL PANEL

1. Two separate 24-volt transformers are required for the system. The HVAC Equipment transformer cannot be used for power. Transformer #1 is used to power the zone panel and thermostats. Transformer #2 is used to power the zone dampers.
2. Wire 24VAC from Transformer #1 to the POWER, R & C terminals (see **FIGURE 7**). Use a 20VA transformer for Transformer #1.
3. Wire 24VAC from Transformer #2 to the DAMPER POWER, R & C terminals (see **FIGURE 8**).
4. Sizing Transformer #2:
 - a. Select your damper type.

OPTION 1: Normally Open/Power Close Dampers (2-Wire)

- i. Add up all the zone dampers that are in the system.
- ii. Subtract the number of dampers in the zone with the least number of dampers. This is the greatest number of dampers that could be energized at one time.
- iii. Multiply this number by 10 to determine the damper VA requirement.

Example: If you have a 4-zone system, and there are two dampers per zone, then the total number of dampers that could be energized at one time is,

8 - 2 = 6 dampers

6 dampers x 10VA per damper = 60VA required

OPTION 2: Power Open/Power Close Dampers (3-Wire)

- i. Add up all the zone dampers that are in the system.
- ii. Multiply this number by 2.5 to determine the transformer size.

Example: If you have a 4-zone system, and there are two dampers per zone, then the total number of dampers that could be energized at one time is,

8 dampers x 2.5VA per damper = 20VA required

- b. Select a transformer that meets or exceeds the value calculated.

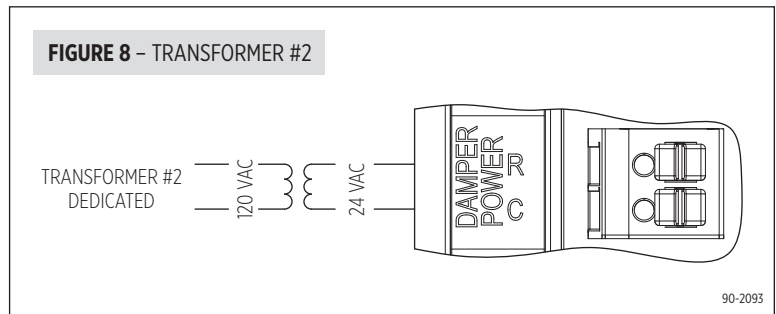
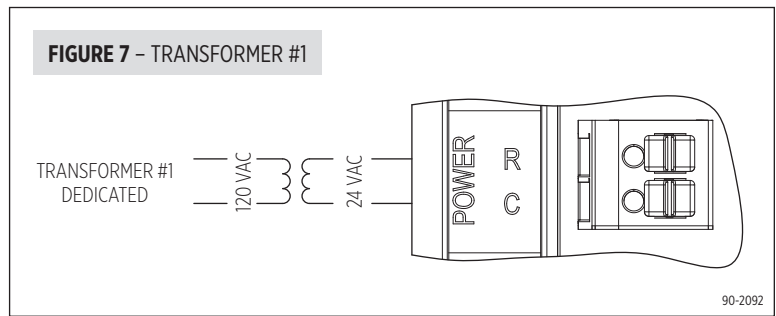

ZONE DAMPER WIRING

- Run 2-conductor thermostat wire for spring return dampers (normally open or normally closed).
- Run 3-conductor thermostat wire for power open/power close dampers.
- Multiple dampers for the same zone can be wired in parallel as shown in **FIGURES 9 & 10**.
- Wire the dampers to the zone panel:
 - **NC** – This terminal is used to power open a normally closed damper. For power open and power close dampers this terminal is used to power open the damper.
 - **NO** – This terminal is used to power close a normally open damper. For power open and power close dampers this terminal is used to power close the damper.
 - **COM** – This terminal provides a common connection for the NC and NO terminals.
- If multiple transformers will be required, wire them in parallel as shown. Before wiring the transformers together, ensure that they are connected in phase by observing polarity marks or terminal orientation on each transformer. See **FIGURE 11**.

FIGURE 9 – NORMALLY OPEN / POWER CLOSE DAMPERS

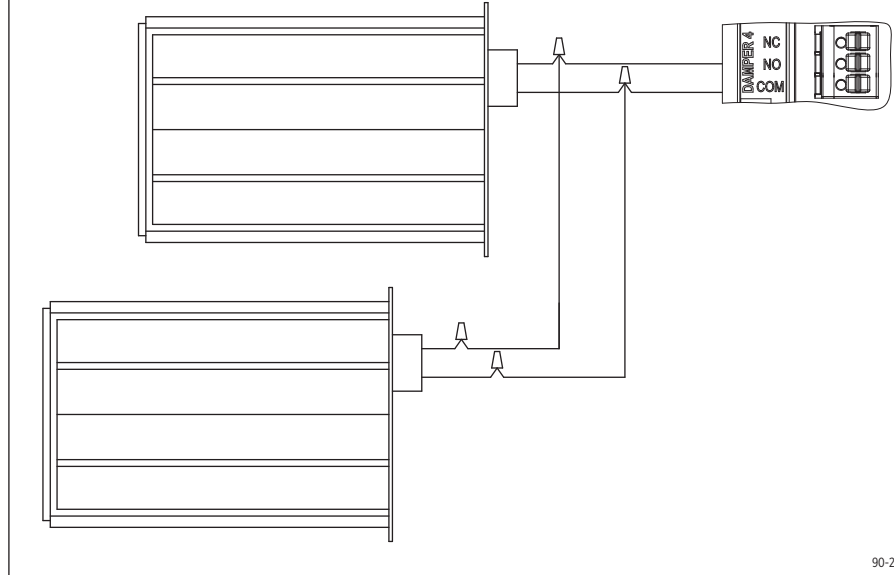

90-2090

FIGURE 10 – POWER OPEN / POWER CLOSE DAMPERS

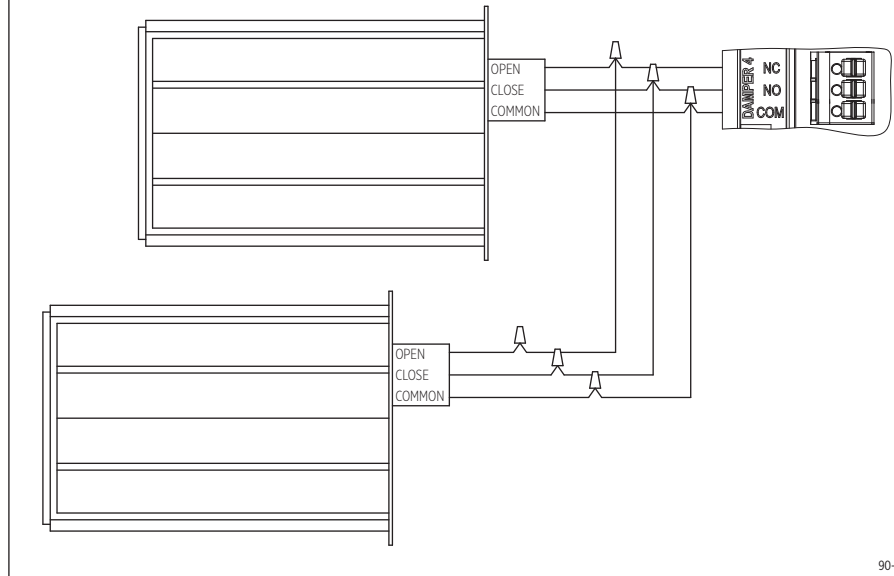

90-2141

FIGURE 11 – MULTIPLE TRANSFORMERS

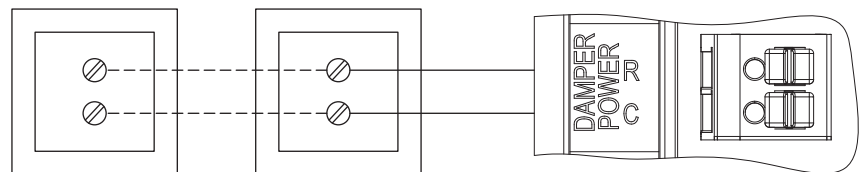

----- **IMPORTANT:** CHECK PHASE OF TRANSFORMERS BEFORE WIRING TOGETHER

90-2091

DISCHARGE AIR TEMPERATURE SENSOR (INCLUDED)

- Wire the discharge air temperature sensor Model 8052 to the “DAT” terminals as shown. See **FIGURE 12**.
- Maximum distance of the sensor from the zone panel is 300 feet.
- Do not wire along 120VAC lines.
- Refer to **FIGURE 5** on page 5 for the proper mounting location of the discharge air temperature sensor.

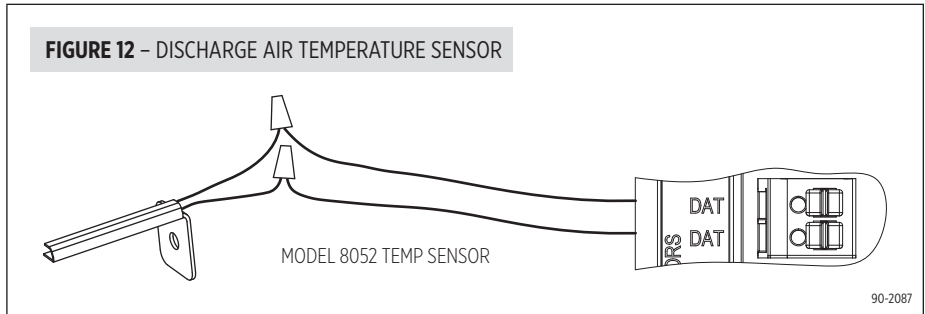

OUTDOOR TEMPERATURE SENSOR (OPTIONAL)

- Wire the outdoor temperature sensor Model 8052 to the “ODT” terminals as shown. See **FIGURE 13**.
- Maximum distance of the sensor from the zone panel is 300 feet.
- Do not wire along 120VAC lines.
- Outdoor temperature sensor should be mounted:
 - On side of building out of direct sunlight.
 - Above snow line.
 - At least 3 feet away from exhaust vents and condensing lines.

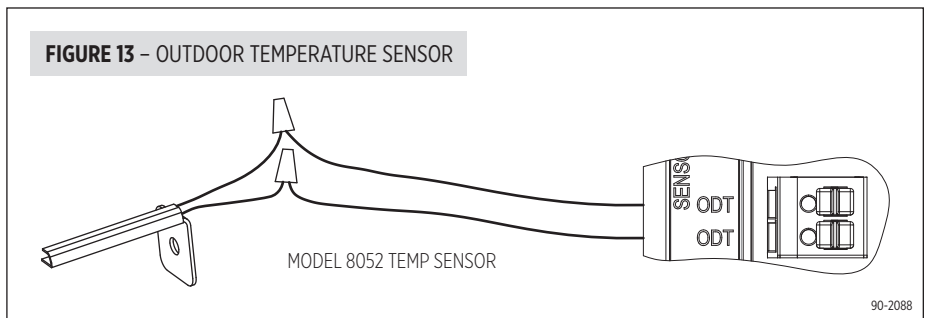

EXPANSION PANELS (OPTIONAL – MODEL 6404 ONLY)

Up to four expansion panels, each with 2 zones, can be added to the zone panel if additional zones are required.

To add Model 6401 expansion panels, follow these steps:

1. Disconnect the Power and Damper Power on the zone panel until installation is complete.
2. Mount the expansion panels using four #8 screws (supplied) in location where temperature will not exceed 158°F and will not drop below freezing 32°F. Do not mount on foundation walls, or on the supply of the HVAC equipment.
3. Connect the R, C, A and B terminals labeled **EXPANSION** on the zone panel to the R, C, A and B terminals labeled **EP_IN** on the first 6401 expansion panels, connect the R, C, A and B terminals labeled **EP_OUT** on the first expansion panel to the terminals labeled **EP_IN** on the next expansion panel. See **FIGURE 14**. Polarity is important. If wired incorrectly control panel power and/or communications will be affected. Use wire color as a means to ensure the terminals are connected correctly.
4. Connect a dedicated transformer to the **DAMPER POWER** terminals on the first 6401 expansion panel. For additional panels, damper power can be daisy chained as shown in **FIGURE 14**.
5. Wire dampers to the 6401 expansion panel(s) as previously described in the ZONE DAMPER WIRING section.
6. Wire the thermostats to the 6401 expansion panel(s). Use the same thermostats as were selected for zones 1-4 on the zone panel.
7. Address each 6401 expansion panel. Each expansion panel must have its own unique address, 1 through 4, or communications cannot be established between the zone panel and the expansion panel.
8. Maximum distance of the expansion panel from the zone panel is 50 feet.

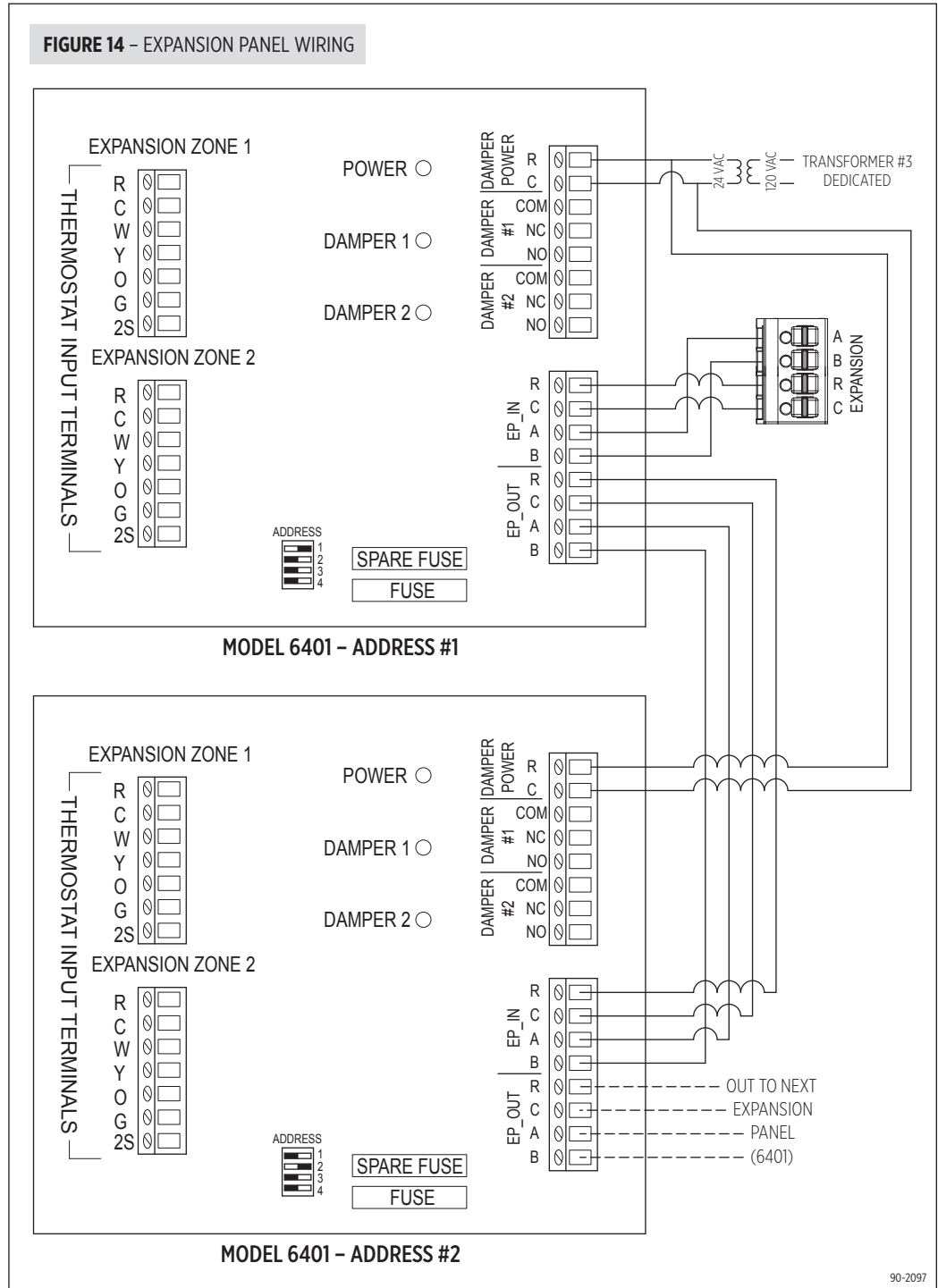

90-2097

THERMOSTAT TERMINAL DEFINITIONS

R – 24VAC power to thermostat

C – 24VAC power to thermostat

W – First stage heat (conventional) / First stage auxiliary (heat pump)

W2 – Second stage heat (conventional) / Second stage auxiliary (heat pump)

Y – First stage cooling (conventional) / First stage compressor (heat pump)

Y2 – Second stage cooling (conventional) / Second stage compressor (heat pump)

G – Fan

O – Reversing valve (heat pump)

L – System fault indicator (heat pump) (optional)

NOTE:

The **L** output to the thermostat is derived from the **L** system fault indicator input to the zone panel from the HVAC equipment. The **L** output to the thermostat is only available in Zone 1. If using the system fault indicator choose Zone 1 to be a thermostat that is in a frequently occupied space.

HVAC TERMINAL DEFINITIONS

RH – 24VAC from heating or auxiliary heat equipment

RC – 24VAC from cooling equipment or compressor

W – First stage heat (conventional) / First stage auxiliary (heat pump)

W2 – Second stage heat (conventional) / Second stage auxiliary (heat pump)

Y – First stage cooling (conventional) / First stage compressor (heat pump)

Y2 – Second stage cooling (conventional) / Second stage compressor (heat pump)

G – Fan

B – Reversing valve – heating (heat pump)

O – Reversing valve – cooling (heat pump)

L – System fault indicator (heat pump)

C – 24VAC common from RC transformer (only required if **L** input is used)

NOTE:

For two transformer systems, remove the jumper next to the **RH** and **RC** terminals labeled **JMP**.

TWO-STAGE FURNACE AND A/C

HVAC TERMINAL DEFINITIONS

- Y1** – First stage cooling
- Y2** – Second stage cooling
- W1** – First stage heating
- W2** – Second stage heating
- G** – Fan

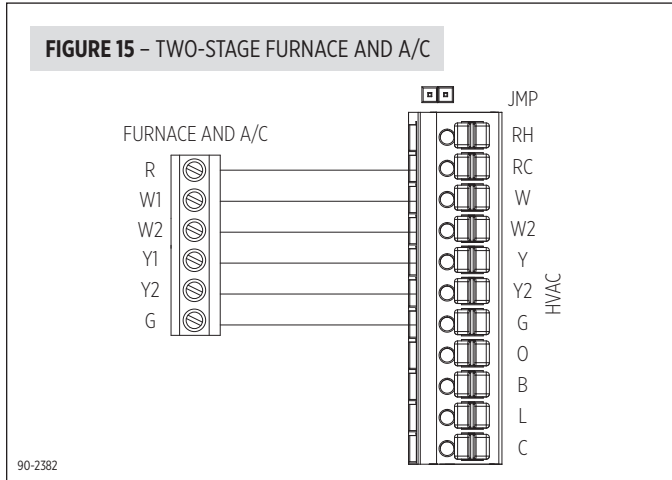

TWO-STAGE HEAT PUMP

HVAC TERMINAL DEFINITIONS

- Y1** – First stage compressor
- Y2** – Second stage compressor
- W1** – First stage auxiliary heat
- W2** – Second stage auxiliary heat
- G** – Fan
- O** – Reversing valve (cooling)

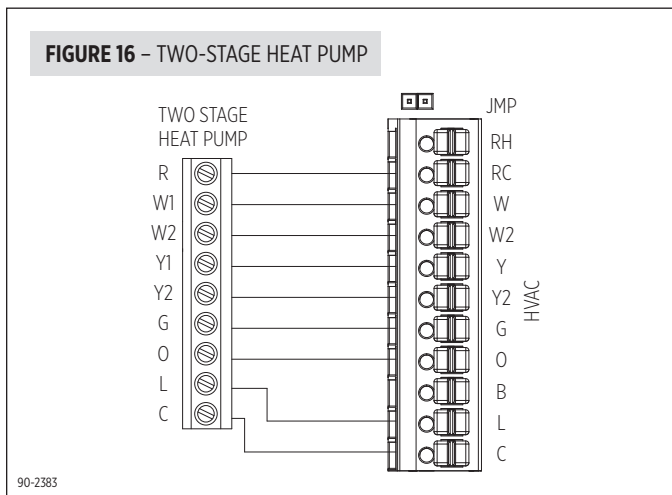

BOILER AND A/C

HVAC TERMINAL DEFINITIONS

- Y1** – First stage cooling
- W1** – First stage boiler heat
- G** – Fan

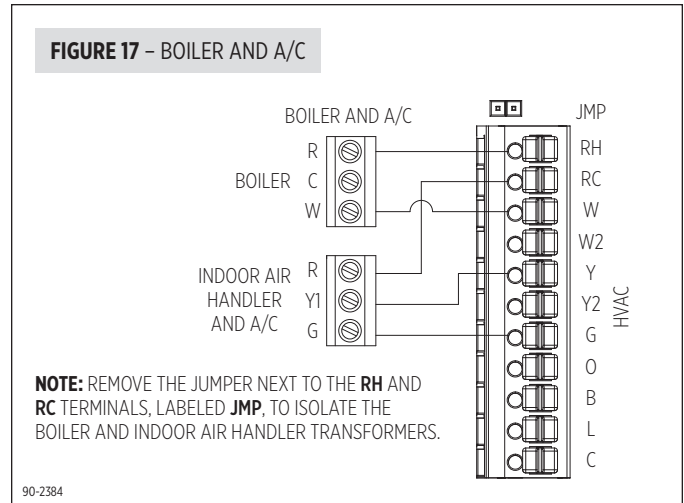

RADIANT FLOOR FIRST-STAGE HEAT, FURNACE SECOND-STAGE HEAT AND A/C

HVAC TERMINAL DEFINITIONS

- Y1** – First stage cooling
- W1** – First stage radiant floor heat
- W2** – Second stage furnace heat
- G** – Fan

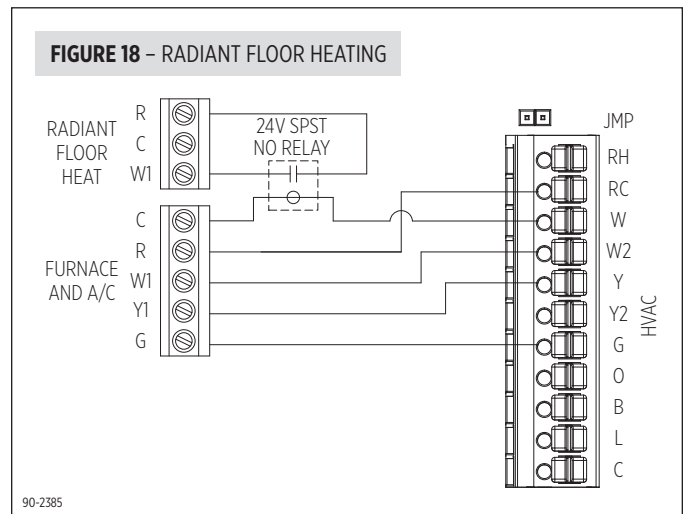

INSTALLER SETUP

HOW TO CONFIGURE

- Press the **BACK** ◀ and **NEXT** ▶ buttons for 7 seconds continuously.
 - The message **INSTALLER SETUP ENABLED** will be displayed for 2 seconds and then transition to the first system setting.
 - Use the ▲ or ▼ buttons to select HVAC, STAGING, or DAT (Discharge Air Temperature) LIMITS setup, then press **NEXT** ▶ to enter the setup menu. Selecting EXIT and then pressing **NEXT** ▶ will save installer settings and exit the installer setup.
 - Within each sub-menu use the ▲ or ▼ buttons to adjust the setting.
 - The **NEXT** ▶ button will accept the current setting and navigate to the next setting unless the last sub-menu setting is displayed. If the last sub-menu setting is displayed, pressing **NEXT** ▶ will return to the main menu.
- NOTE:** If no buttons are pressed for 60 seconds during the installer setup. The installer setup will exit automatically and save any changes.
- The flow chart below shows the steps of the installer setup. Default settings are show in **bold**. For more detailed information about each of the system settings, refer to **TABLE 1** on the following page.

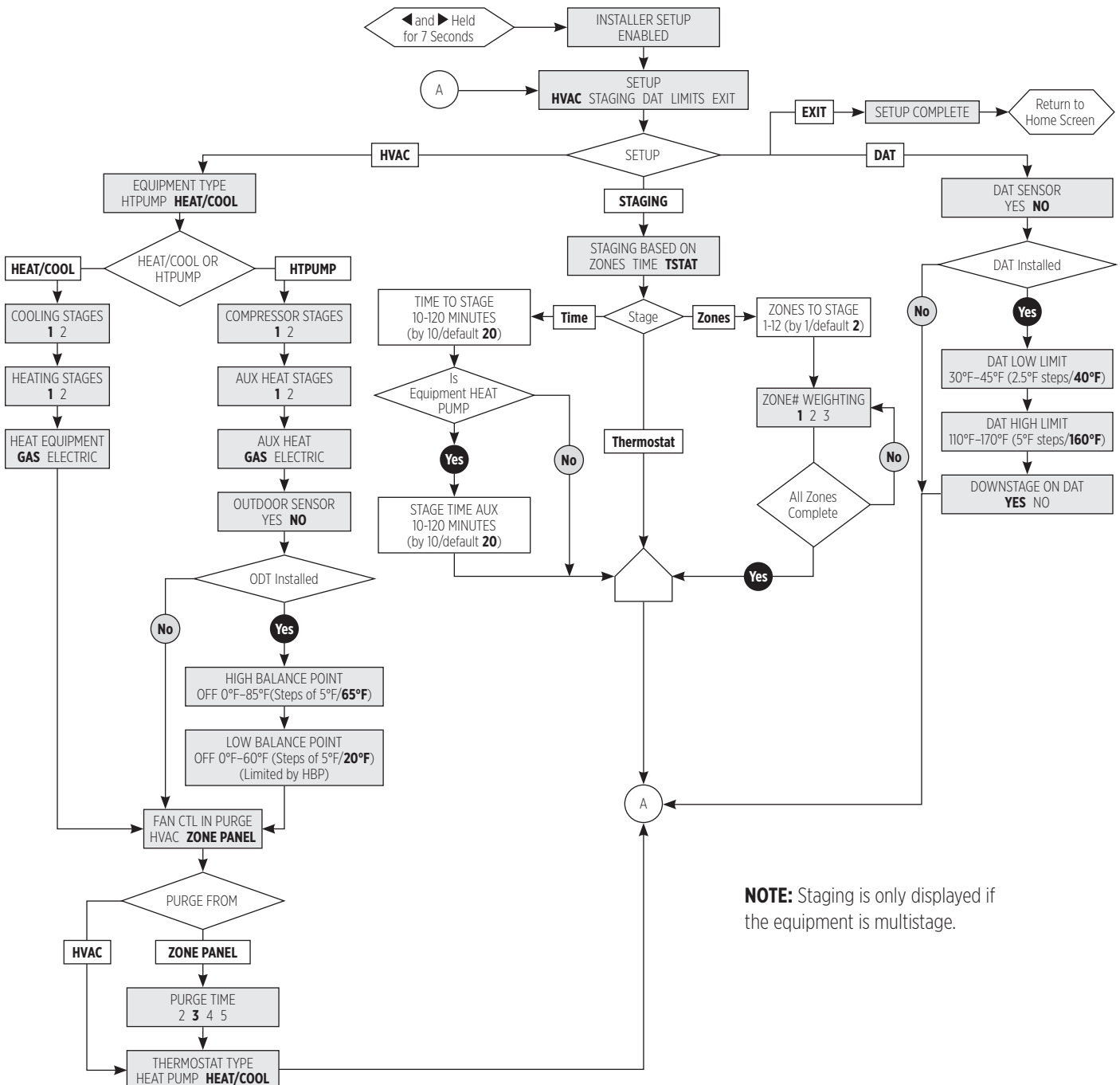

NOTE: Staging is only displayed if the equipment is multistage.

LCD INSTALLER SCREEN SETTINGS & DESCRIPTIONS

TABLE 1 – INSTALLER SETUP		
Menu Title	Description	Factory default setting (bold) and setting range
HVAC Setup		
EQUIPMENT TYPE	Selects if zone panel is controlling a Heat/Cool or Heat Pump system.	HEAT/COOL HTPUMP
COOLING STAGES	Number of cooling stages. NOTE: Only displayed if EQUIPMENT TYPE is set to HEAT/COOL.	1 2
COMPRESSOR STAGES	Number of compressor stages. NOTE: Only displayed if EQUIPMENT TYPE is set to HTPUMP.	1 2
HEATING STAGES	Number of heating stages. NOTE: Only displayed if EQUIPMENT TYPE is set to HEAT/COOL.	1 2
AUX HEAT STAGES	Number of auxiliary heating stages. NOTE: Only displayed if EQUIPMENT TYPE is set to HTPUMP.	1 2
HEAT EQUIPMENT	Determines if the zone panel or equipment controls the fan in heating. NOTE: Only displayed if EQUIPMENT TYPE is set to HEAT/COOL.	GAS ELECTRIC
AUX HEAT	Auxiliary heat type. NOTE: Only displayed if EQUIPMENT TYPE is set to HTPUMP.	GAS ELECTRIC
OUTDOOR SENSOR	Determines if an outdoor sensor is installed for balance point control. NOTE: Only displayed if EQUIPMENT TYPE is set to HTPUMP.	YES NO
HIGH BALANCE PNT	Selects the temperature at which the auxiliary heating equipment will be locked out and only the compressor will be used for heating. Set to Off to disable. NOTE: Only displayed if EQUIPMENT TYPE is set to HTPUMP and OUTDOOR SENSOR is set to YES.	OFF 0°F–85°F (Steps of 5°F/ 65°F)
LOW BALANCE PNT	Selects the temperature at which the compressor will be locked out and only the auxiliary heat will be used for heating. Set to Off to disable. NOTE: Only displayed if EQUIPMENT TYPE is set to HTPUMP and OUTDOOR SENSOR is set to YES.	OFF 0°F–60°F (Steps of 5°F/ 20°F)
FAN CTL IN PURGE	Determines if the fan is controlled by the HVAC equipment or zone panel during purge.	HVAC ZONE PANEL
PURGE TIME	Selects the number of minutes the fan will run during purge. NOTE: Only displayed if FAN CTL IN PURGE is set to ZONE PANEL.	3 minutes 2 to 5 minutes
THERMOSTAT TYPE	Selects what type of thermostat is being used. NOTE: All thermostats used must be the same type.	HEAT PUMP HEAT/COOL
Staging Setup		
STAGING BASED ON	Determines if staging of multi-stage equipment is based on the thermostat inputs, the duration (time) of an active call, or the number of zones that are calling for heating or cooling.	ZONES TIME TSTAT
TIME TO STAGE	Number of minutes to delay before engaging second stage NOTE: Only displayed if STAGING BASED ON is set to TIME.	10-120 Minutes (by 10/default 20)
STAGE TIME AUX	Number of minutes to delay before engaging auxiliary heating, or second stage auxiliary heating. NOTE: Only displayed if EQUIPMENT TYPE is set to HTPUMP and STAGING BASED ON is set to TIME.	10-120 Minutes (by 10/default 20)
ZONES TO STAGE	Determines how many zones must be calling for the zone panel to go to the next available stage of heating or cooling. NOTE: Only displayed if STAGING BASED ON is set to ZONES.	1-12 (Default 2)
ZONE # WEIGHTING	Determines the weighting of each zone. For example, setting ZONE 2 WEIGHTING to 3 means that when Zone 2 has an active heating or cooling call, it would count as 3 zones calling for heating or cooling. NOTE: Only displayed when STAGING BASED ON is set to ZONES.	1 , 2, 3 (Default 1)
DAT Setup		
DAT SENSOR	Determines if a discharge air temperature sensor is installed.	YES NO
DAT LOW LIMIT	Determines the discharge temperature at which the HVAC equipment will turn off to prevent freezing the indoor coil. NOTE: Only displayed if DAT SENSOR is set to YES.	30°F–60°F (2.5°F steps/ 40°F)
DAT HIGH LIMIT	Determines the discharge temperature at which the HVAC equipment will turn off to prevent overheating. NOTE: Only displayed if DAT SENSOR is set to YES.	110°F–170°F (5°F steps/ 160°F)
DOWNSTAGE ON DAT	Allows the zone panel to downstage multistage equipment when discharge air temperature comes within 5°F of the DAT LOW LIMIT or DAT HIGH LIMIT. NOTE: Only displayed if DAT SENSOR is set to YES.	YES NO

SEQUENCE OF OPERATION

The 6404/6403 zone panel is a heat call priority system with automatic heating/cooling changeover after 20 minutes of operation. If two opposing (heating/cooling) thermostat calls exist while the system is idle, the heating call will be satisfied first. The zone panel can be configured to control either a conventional heat/cool system or heat pump system based on the EQUIPMENT TYPE setting. For heat/cool systems, the COOLING STAGES, HEATING STAGES, and HEAT EQUIPMENT settings are used to configure the zone panel for the appropriate number of stages and type of heating equipment. For heat pump systems the COMPRESSOR STAGES, AUX HEAT STAGES, and AUX HEAT settings are used to configure the zone panel for the appropriate number of stages and type of auxiliary heating equipment. For heat pump applications either heat/cool or heat pump thermostats can be used and the zone panel will translate the thermostat call to the appropriate equipment call. The THERMOSTAT TYPE setting is used to configure the zone panel for the type of thermostat used in the application.

Note that immediately after the board is powered, there is a four minute minimum off delay where only the fan output will respond.

HEAT/COOL CHANGEOVER

When a call for heating/cooling exists and an opposing call is made from another zone, a changeover time limit of 20 minutes begins at the time that the opposing call is made. If the original call is not satisfied within that 20-minute time period, the call will be interrupted, and the zone panel will turn the equipment off and complete the normal fan purge cycle and minimum equipment off time. The opposing call will then be answered. After 20 minutes, if the original call still exists, the opposing call will be interrupted and the original call can once again be recognized.

DISCHARGE AIR TEMPERATURE (DAT) SENSOR HIGH/LOW TEMPERATURE LIMIT

The high/low temperature limit settings are designed to prevent the heat exchanger from overheating or the cooling coil from freezing. An 8052 Sensor mounted in the supply duct senses the discharge air temperature and can either downstage or interrupt the heating/cooling equipment before overheating/freezing occurs.

When DOWNSTAGE ON DAT is set to YES, if the discharge air temperature comes within 5°F of the HIGH DAT LIMIT or LOW DAT LIMIT setting the zone panel will go to the next lowest equipment stage, if it is not already in first stage heating or cooling. The zone panel will remain in this lower stage until the discharge air temperature is 10°F from the HIGH DAT LIMIT or LOW DAT LIMIT setting. The LCD will display the DOWNSTAGED ON HIGH TEMP LIMIT or DOWNSTAGED ON LOW TEMP LIMIT message while the zone panel is in a lower stage based on the discharge air temperature.

When the discharge air temperature reaches the HIGH DAT LIMIT or LOW DAT LIMIT the zone panel will interrupt the heating/cooling call. When the interrupt occurs the zone panel ends the heating/cooling call and energizes the fan terminal (if not already energized). The Heating/Cooling LED on the zone panel will flash during a high/low limit temperature interrupt and the LCD will display DISCHARGE HIGH TEMP EXCEEDED or DISCHARGE LOW TEMP EXCEEDED. Once the temperature drops/rises 10°F, the high/low temperature interrupt will end and the heating/cooling call to the equipment can resume.

VACATION MODE

The Vacation mode button allows the homeowner to switch from normal operation to Vacation mode. When Vacation mode is enabled the thermostat in Zone 1 becomes the only zone from which a call for heating or cooling is recognized. Additionally, when in Vacation mode, all dampers remain in the open position. This feature allows the homeowner to create a setback from a single thermostat and control the whole home based on that thermostat. The Vacation LED will illuminate when Vacation mode is enabled.

EMERGENCY HEAT MODE

This feature can only be used with heat pump systems. The EM Heat button can be used to enable Emergency Heat mode. When Emergency Heat mode is enabled, any call for heat will be answered with auxiliary heat equipment and the heat pump will be locked out. This feature allows the homeowner to activate Emergency Heat mode at the zone panel. The EM Heat LED will illuminate whenever Emergency Heat mode is enabled or there is an Emergency Heat call from a thermostat.

FAN OPERATION

A call for Fan from any zone will initiate the G equipment output terminal. The dampers for all zones not calling for a continuous fan will be closed during the fan call.

HEATING OPERATION

When a thermostat makes a call to the zone panel for heating, the zone panel will initiate a heating call to the equipment and close the damper for all zones that are not calling for heat. Following a 2-minute (heat/cool or auxiliary) or 4-minute (heat pump) minimum on time, the heating call will end when (1) all zones stop calling for heating, (2) the call has exceeded the 20 minute heating/cooling changeover time limit while a cooling call exists or (3) the call is interrupted because the discharge air temperature sensor reaches the DAT HIGH LIMIT setting. When the heating call ends, if FAN CTL IN PURGE is set to ZONE PANEL, the fan output will remain on and the dampers will hold their position for 2 to 5 minutes based on the PURGE TIME setting. After the fan output turns off the dampers will hold their position for an additional minute before completing purge. If FAN CTL IN PURGE is set to HVAC, when a heating call ends the fan output will turn off immediately and the dampers will hold their position for 3-1/2 minutes before completing the purge. When a heating call ends, a minimum off time delay of 4 minutes must elapse before another heating/cooling call can begin.

COOLING OPERATION

When a thermostat makes a call to the zone panel for cooling, the zone panel will initiate a cooling call to the equipment and close the damper for all zones that are not calling for cooling. Following a 4-minute minimum on time, the cooling call will end when (1) all zones stop calling for cooling, (2) the call has exceeded the 20 minute heating/cooling changeover time limit while a heat call exists or (3) the call is interrupted because the discharge air temperature sensor has reached the DAT LOW LIMIT setting. When the cooling call ends, if FAN CTL IN PURGE is set to ZONE PANEL, the fan output will remain on and the dampers will hold their position for 2 to 5 minutes based on the PURGE TIME setting. After the fan output turns off the Dampers will hold their position for an additional minute before completing purge. If FAN CTL IN PURGE is set to HVAC, when a cooling call ends the fan output will turn off immediately and the dampers will hold their position for 3-1/2 minutes before completing the purge. When a cooling call ends, a minimum off time delay of 4 minutes must elapse before another heating/cooling call can begin.

MULTISTAGE EQUIPMENT STAGING

The zone panel can be configured to control staging of multi-stage HVAC equipment multiple ways based on the STAGING BASED ON setting.

Staging Based on the Zone Thermostat

When STAGING BASED ON is set to TSTAT, the zone panel will stage the HVAC equipment to the highest stage thermostat call.

For example if the thermostat in Zone 1 is calling for first stage heating, and the thermostat in Zone 2 is calling for second stage heating, the zone panel will create a second stage heating call to the equipment, open the dampers for Zone 1 and Zone 2 and close the dampers for all other zones.

NOTE: This setting should only be used when multi-stage thermostats are installed.

Staging Based on Time

When STAGING BASED ON is set to TIME, the zone panel will stage the HVAC equipment based on the time (duration) of the active call and the TIME TO STAGE and STAGE TIME TO AUX settings. This is useful when single stage thermostats are installed in applications with multi-stage equipment.

Example:

EQUIPMENT TYPE = HTPUMP
COMPRESSOR STAGES = 2
AUX HEAT STAGES = 1
AUX HEAT = ELECTRIC
TIME TO STAGE = 20 MINUTES
STAGE TIME TO AUX = 10 MINUTES

When a heating call occurs from a thermostat the zone panel will initiate a first stage heating call to the heat pump. If that call persists for 20 minutes the zone panel will stage up to a second stage heating call to the heat pump. If the second stage heating call persists for 10 minutes the zone panel will add electric auxiliary heat to the heating call.

Staging Based on Zones Calling

When STAGING BASED ON is set to ZONES, the zone panel will stage the HVAC equipment based on the number of zones calling and the ZONES TO STAGE setting. Note that each zone can be counted as more than one zone calling based on the ZONE WEIGHTING setting for that zone. This is useful if the zones are not equally sized. Additionally, this can be used when single stage thermostats are installed in applications with multi-stage equipment.

Example:

EQUIPMENT TYPE = HTPUMP
COMPRESSOR STAGES = 2
ZONES TO STAGE = 3
ZONE 1 WEIGHTING = 3
ZONE 2 WEIGHTING = 1
ZONE 3 WEIGHTING = 1
ZONE 4 WEIGHTING = 1

When a cooling call occurs from the thermostats in Zone 2 and Zone 3, the zone panel will initiate a first stage cooling call to the heat pump, because the total number of zones calling is 2 which does not meet the ZONES TO STAGE setting of 3. If the thermostat in Zone 4 then initiates a call for cooling the zone panel would stage up to a second stage cooling call to the heat pump, because the number of zones calling is now 3. With the same set-up as above if only the thermostat in Zone 1 were to call for cooling the zone panel would answer that call with a second stage cooling call to the heat pump because Zone 1 would meet the ZONES TO STAGE setting of 3.

DUAL FUEL OPERATION

For heat pump applications, an outdoor temperature sensor can be installed to efficiently utilize an air source heat pump. When the OUTDOOR SENSOR setting is set to YES, The HIGH BALANCE POINT and LOW BALANCE POINT settings will determine the temperatures at which the heat pump and auxiliary heat will be locked out. When the outdoor temperature is less than the LOW BALANCE POINT setting, the heat pump will be locked out and only auxiliary heating will be used when the zone panel initiates a heating call. When the outdoor temperature is greater than the HIGH BALANCE POINT setting the auxiliary heating will be locked out and only the heat pump will be used when the zone panel initiates a heating call. Refer to the Outdoor Temperature Sensor installation instructions on page 9 for instructions on installing an outdoor temperature sensor.

TIME DELAY OVERRIDE

A Time Delay Override (TDO) button is available on the zone panel to speed up the internal timer for system checkout.

LCD HOME SCREEN DISPLAY & DESCRIPTIONS

The LCD will display the zone panel status during normal operation. The table below shows the available messages and a corresponding description.

Message Type	Display Context	Message Text		
Normal Operation	The outdoor temperature will be displayed if OUTDOOR SENSOR is set to YES.	OUTDOOR SENSOR <value>F		
	The discharge air temperature will be displayed if DAT SENSOR is set to YES.	DAT SENSOR <value>F		
	Vacation mode is enabled with the Vacation button.	VACATION ENABLED ZONE1 CONTROLS		
	Emergency Heat mode is enabled at the zone panel with the EM Heat button.	EMERGENCY HEAT ENABLED		
Error	Wired outdoor sensor failure (open or short).	CHECK WIRED OUTDOOR SENSOR		
	Discharge air temperature sensor failure (open or short).	CHECK DISCHARGE AIR TEMP SENSOR		
	The thermostat inputs are not a recognized combination.	CHECK ZONE# THERMOSTAT		
Equipment Status	HVAC equipment output held off by minimum off timers.	EQUIPMENT WAIT		
	FAN ON is only displayed when there is a continuous fan call to the HVAC equipment, and that call is caused by a continuous fan call (G only) from one or more thermostats.	FAN ON		
	Equipment Type	Aux Heat Type	Active Stage	Message Text
	Heat/Cool	N/A	1	STAGE 1
			2	STAGE 1 AND 2
	Heat Pump	Don't care	1 Compressor	COMPRESSOR 1
			2 Compressor	COMPRESSOR 1 AND 2
		Electric	1 Auxiliary	ELECTRIC HEAT 1
			2 Auxiliary	ELECTRIC HEAT 2
		Gas	1 Auxiliary	AUX HEAT 1
2 Auxiliary			AUX HEAT 2	
Discharge Air Temperature Sensor Limits	Discharge high temperature limit exceeded and has not recovered 10°F below the limit.	DISCHARGE HIGH TEMP EXCEEDED		
	Equipment has staged down based on the high temperature limit.	DOWNSTAGED ON HIGH TEMP LIMIT		
	Discharge low temperature limit exceeded and has not recovered 10°F below the limit.	DISCHARGE LOW TEMP EXCEEDED		
	Equipment has staged down based on the low temperature limit.	DOWNSTAGED ON LOW TEMP LIMIT		
Purge	Damper purge is active.	PURGE ACTIVE		
Idle	No other message is being displayed.	IDLE		
Time Delay Override	Time Delay Override is active.	TIME DELAY OVERRIDE ACTIVE		

INSTALLER CHECKOUT

- Installer checkout is entered by holding the ▲ and ▼ buttons for 7 seconds continuously. Upon entering installer checkout all outputs will turn off and thermostat inputs will be ignored. The **SYSTEM CHECKOUT** message will be displayed for 2 seconds and then transition to the first step of installer checkout as shown in the diagram on this page.
- In installer checkout, the zone panel can only step forward through the test steps so the **BACK** ◀ button will have effect.
- The **NEXT** ▶ button will navigate to the next step.
- **Minimum on time:** The minimum on and off times for heating and cooling apply to installer test. The Time Delay Override button can be used to speed up the minimum on and off timers.
- **Timeout:** If no button is pressed installer checkout will transition to the next step once the associated timeout for that step has expired.

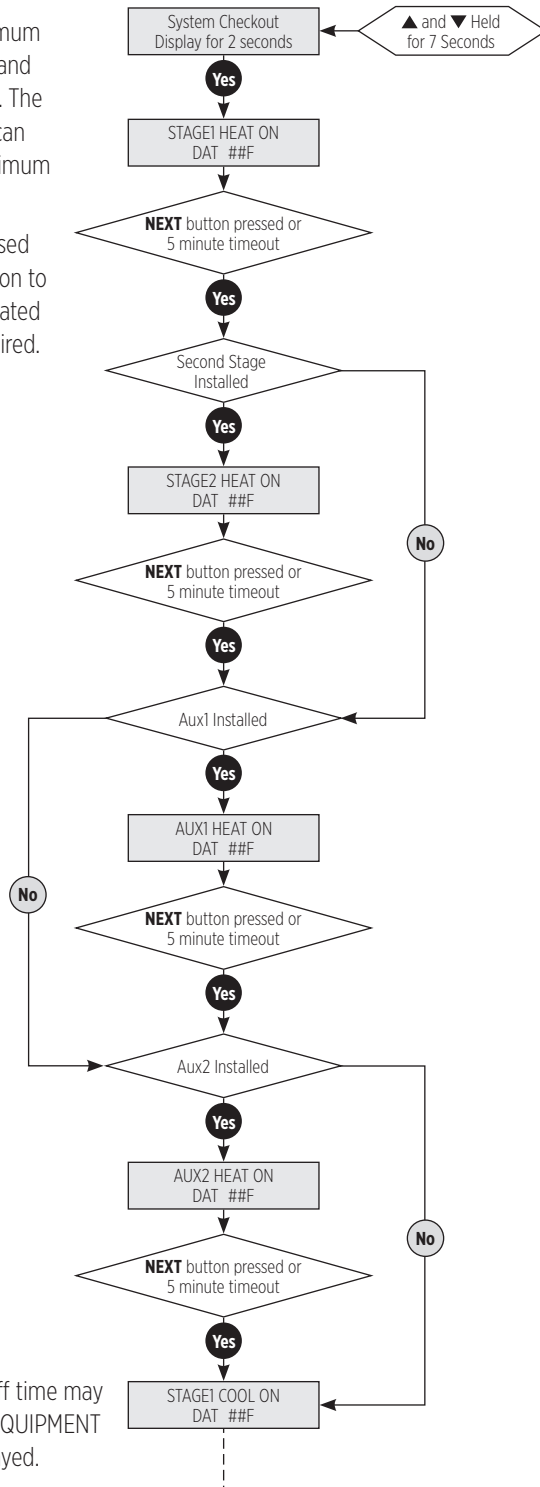

NOTE: A minimum off time may be enforced and an EQUIPMENT WAIT message displayed.

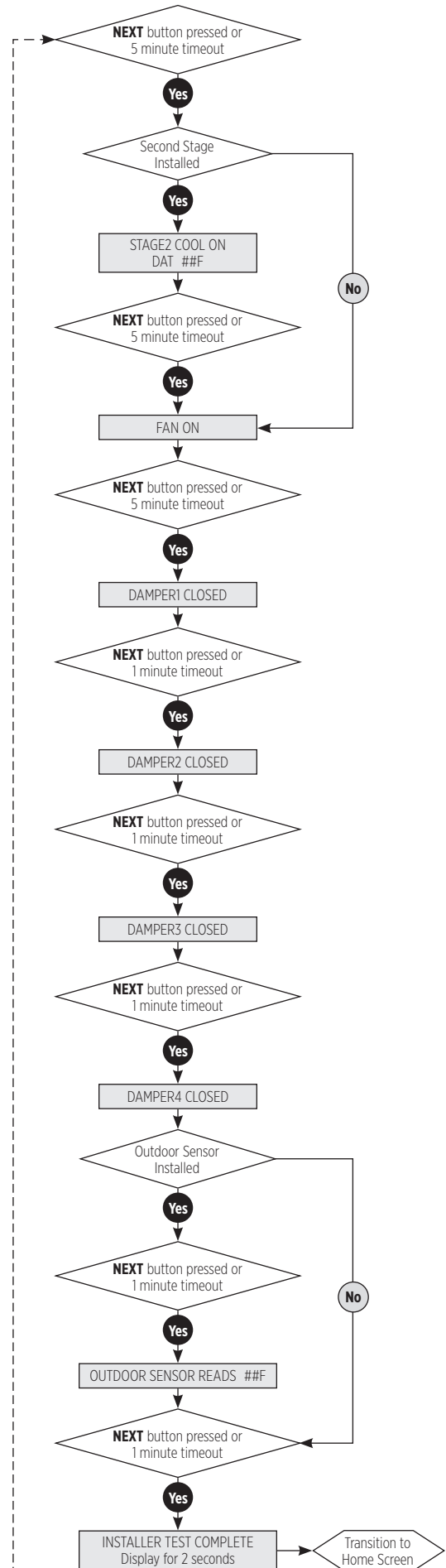

LIMITED WARRANTY

Your Research Products Corporation Aprilaire® Zoned Comfort Control® is expressly warranted for five (5) years from date of installation to be free from defects in materials or workmanship. Any modifications to the product voids the warranty.

Research Products Corporation's exclusive obligation under this warranty shall be to supply, without charge, a replacement for any component which is found to be defective within such five (5) year period and which is returned not later than thirty (30) days after said five (5) year period by you to either your original supplier or to Research Products Corporation, Madison, Wisconsin 53701, together with the model number and installation date of the zone control.

THIS WARRANTY SHALL NOT OBLIGATE RESEARCH PRODUCTS CORPORATION FOR ANY LABOR COSTS AND SHALL NOT APPLY TO DEFECTS IN WORKMANSHIP OR MATERIALS FURNISHED BY YOUR INSTALLER AS CONTRASTED TO DEFECTS IN THE ZONE CONTROL ITSELF.

IMPLIED WARRANTIES OF MERCHANTABILITY OR FITNESS FOR A PARTICULAR PURPOSE SHALL BE LIMITED IN DURATION TO THE AFORESAID FIVE YEAR PERIOD. RESEARCH PRODUCTS CORPORATION'S LIABILITY FOR INCIDENTAL OR CONSEQUENTIAL DAMAGES, OTHER THAN DAMAGES FOR PERSONAL INJURIES, RESULTING FROM ANY BREACH OF THE AFORESAID IMPLIED WARRANTIES OR THE ABOVE LIMITED WARRANTY IS EXPRESSLY EXCLUDED. THIS LIMITED WARRANTY IS VOID IF DEFECTS(S) RESULT FROM FAILURE TO HAVE THIS UNIT INSTALLED BY A QUALIFIED HEATING AND AIR CONDITIONING CONTRACTOR. IF THE LIMITED WARRANTY IS VOID DUE TO FAILURE TO USE A QUALIFIED CONTRACTOR, ALL DISCLAIMERS OF IMPLIED WARRANTIES SHALL BE EFFECTIVE UPON INSTALLATION.

Some states do not allow limitations on how long an implied warranty lasts or the exclusion or limitation of incidental or consequential damages so the above exclusion or limitations may not apply to you.

This warranty gives you specific legal rights and you may also have other rights which vary from state to state.

This equipment if installed in strict accordance with the manufacturer's instructions, complies with the limits for a Class B computing device pursuant to Subpart J of Part 15 of FCC Rules.

WARRANTY REGISTRATION

Visit us online at www.aprilaire.com to register your Aprilaire product. If you do not have online access, please mail a postcard with your name, address, phone number, email address, product purchased, model number, date of purchase, and dealer name and address to: Research Products Corporation, P.O. Box 1467, Madison, WI 53701.

Your warranty registration information will not be sold or shared outside of this company.

AprilairePartners.com
P.O. Box 1467
Madison, WI 53701-1467
800.334.6011 F: 608.257.4357
©2019 Aprilaire – Division of Research Products Corporation

Aprilaire®