

**2007  
Part Catalog**



*Specializing in automated metal fabrications*

**New address  
3850 West Hwy 13  
Burnsville, MN 55337**

**Ph 952-736-1086  
Fax 952-736-1082**

**[www.universal4mations.com](http://www.universal4mations.com)**



*Specializing in automated metal fabrications*

## Shipping and Freight

All items are sold and shipped in full cartons only. Please, no orders for broken cartons.

Please check with your local sales representative for required minimum quantities for free freight. Orders that do not meet the minimum requirement for free freight will be shipped FOB Universal Formations via the best means (unless otherwise noted by the customer). A \$10 handling fee will be applied to all orders that do not meet the minimum allowance for free freight. If an order is to be shipped UPS or other expediting service, an additional \$1.50 per package will be added to the invoice in addition to the flat \$10 handling fee.

Your minimum order necessary for free freight is \_\_\_\_\_

**Surcharges:** it is our general policy to attempt to increase minimum order quantities before enacting surcharges of any kind. Please call if you have any questions or concerns regarding our shipping or freight policies.

## INDEX

## PAGE

### **Duct Hangers and Misc HVAC items**

-Gas Pipe Hangers

**2**

-Furnace Legs

-Mini Duct Hanger

-8", 9", 10" Square Duct Hangers

### **FHA Strips / Nail Strips**

**3**

### **Round Duct Hangers**

-Universal "I" Hangers

**4-5**

-Wedge Hangers

### **Stud Guards and Angles**

**6**

### **Plumbers Positioning Bars**

**7**

## Furnace Accessories

Part Number	Part Description	Price
GPH-1-S	Singel Hole Gas Pipe Hanger-Short	
GPH-1-L	Single Hole Gas Pipe Hanger-Long	
GPH-2	Double hole Gas Pipe Hanger	

Boxed in Quantities of 250

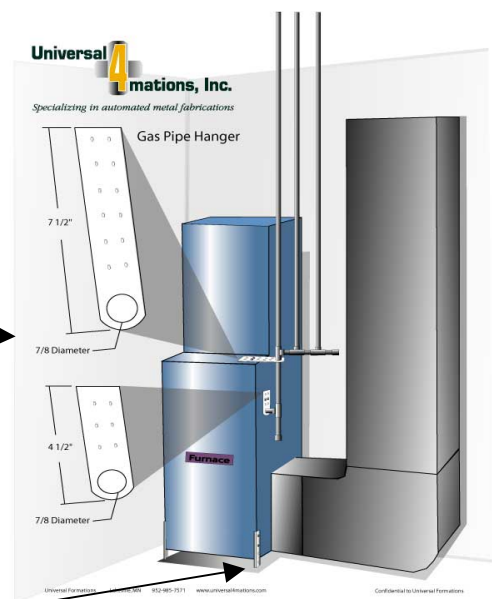
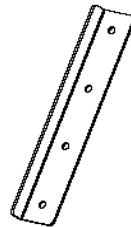
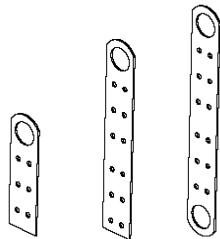

Part Number	Part Description	Price
FUR-LEG	Furnace Leg	

Boxed in Quantities of 250

## Duct Hangers

Part Number	Part Description	Price
DH-MINI	Mini Duct Hanger	
Boxed in Quantities of 1000		
SDH-8	8" Square Duct Hanger	
SDH-9	9" Square Duct Hanger	
SDH-10	10" Square Duct Hanger	
SDH-11	11" Square Duct Hanger	

Boxed in Quantities of 100



**DH-MINI**

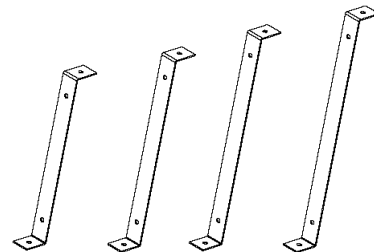

**SDH-8,9,10,11**

# FHA PLATES and NAIL STRIPS



Part Number	Gauge	Width / Length	Price Ea.
FHA-1618	16	1 1/2" x 18"	
FHA-1624	16	1 1/2" x 24"	
FHA-1648	16	1 1/2" x 48"	
FHA-1818	18	1 1/2" x 18"	
FHA-1824	18	1 1/2" x 24"	
FHA-1848	18	1 1/2" x 48"	

Shrink wrapped in quantities of 25

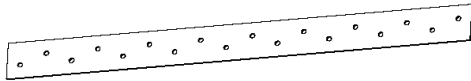

Part Number	Gauge	Width / Length	Price Ea.
NS-1618	16	1 1/2" x 18"	
NS-1624	16	1 1/2" x 24"	
NS-1648	16	1 1/2" x 48"	
NS-1818	18	1 1/2" x 18"	
NS-1824	18	1 1/2" x 24"	
NS-1848	18	1 1/2" x 48"	

Shrink wrapped in quantities of 25

## Span one, two, or three stud cavities with just one plate!

**3" \***

Part Number	Gauge	Width / Length	Price Ea.
FHA8-1618-3	16	3" x 18"	
FHA8-1634-3	16	3" x 34"	
FHA8-1650-3	16	3" x 50"	

Shrink wrapped in quantities of 25

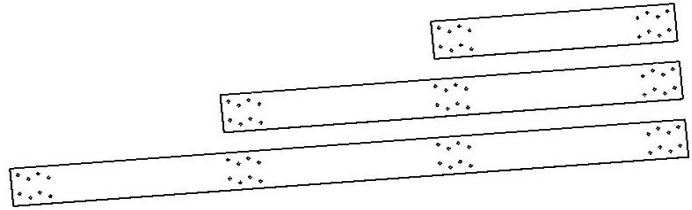

**5" \***

Part Number	Gauge	Width / Length	Price Ea.
FHA8-1618-5	16	5" x 18"	
FHA8-1634-5	16	5" x 34"	
FHA8-1650-5	16	5" x 50"	

Shrink wrapped in quantities of 25

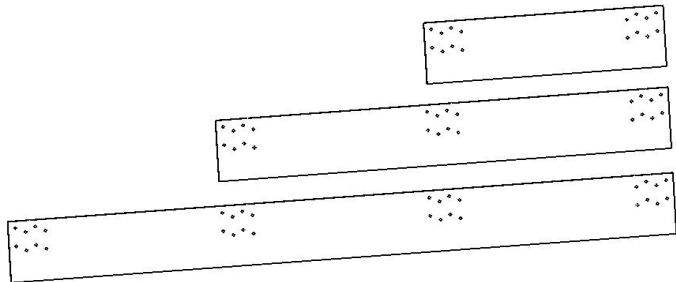

\* 8 hole pattern w/ 16 ga. material meets requirements for 2003 International Residential Code R602.6.1

# Round Telescoping Duct Hangers



## TABBED WITH CAPTIVATED SCREW

Part Number	Part Description	Box Qty	Price Ea.
HNGR-SCRW	Universal "I" Hanger, W/Screw (11"-19")	50	
HNGR-SCRW-L	Universal "I" Hanger, W/Screw (18"-33")	50	
HNGR-SCRW-25	Universal "I" Hanger, W/Screw (11"-19")	25	
HNGR-SCRW-L25	Universal "I" Hanger, W/Screw (18"-33")	25	

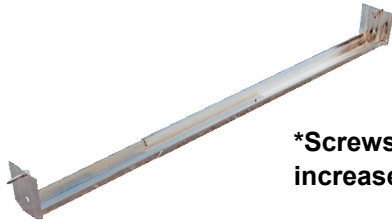

**\*Screws are captivated in the bracket to greatly increase the efficiency of installation.**

**\*Screw or pound into the hardest of surfaces, including TGI Joists.**

## PRO-POUNDER

Part Number	Part Description	Box Qty	Price Ea.
HNGR-PRO	Universal "I" Hanger, Pro Pounder (11"-19")	50	
HNGR-PRO-L	Universal "I" Hanger, Pro Pounder (18"-33")	50	
HNGR-PRO-25	Universal "I" Hanger, Pro Pounder (11"-19")	25	
HNGR-PRO-L25	Universal "I" Hanger, Pro Pounder (18"-33")	25	

**\*Heavy gage barb penetrates harder joist material.**

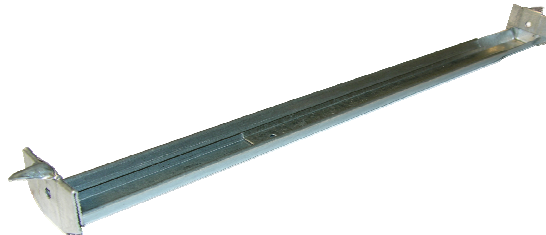

## Round Telescoping Duct Hangers cont.

### POUNDER

Part Number	Part Description	Box Qty	Price Ea.
HNGR-PNDR	Universal "I" Hanger, Pounder (11"-19")	50	
HNGR-PNDR-L	Universal "I" Hanger, Pounder (18"-33")	50	
HNGR-PNDR-25	Universal "I" Hanger, Pounder (11"-19")	25	
HNGR-PNDR-L25	Universal "I" Hanger, Pounder (18"-33")	25	

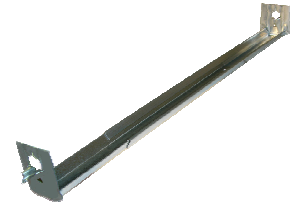

### TABBED

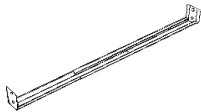

Part Number	Part Description	Box Qty	Price Ea.
HNGR-TAB	Universal "I" Hanger, Tabbed (11"-19")	50	
HNGR-TAB-L	Universal "I" Hanger, Tabbed (18"-33")	50	
HNGR-TAB-25	Universal "I" Hanger, Tabbed (11"-19")	25	
HNGR-TAB-L25	Universal "I" Hanger, Tabbed (18"-33")	25	

## Round Duct Hangers

### WEDGE HANGER

Part Number	Part Description	Pkg Qty	Price Ea.
WDG-2015	Wedge Hanger 20 ga. x 15" Long	50	
WDG-1623	Wedge Hanger 16 ga. x 23" Long	25	

Shrink Wrapped On Ends

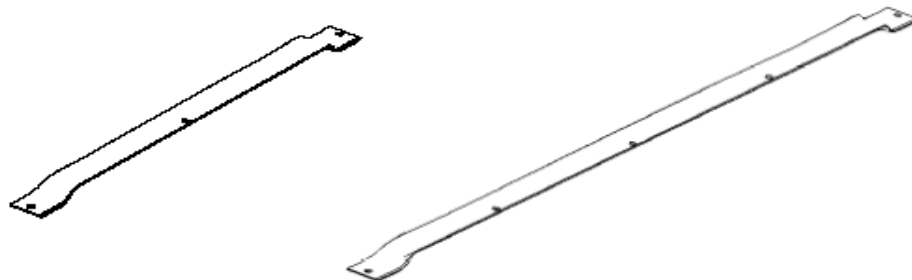

## Stud Guards

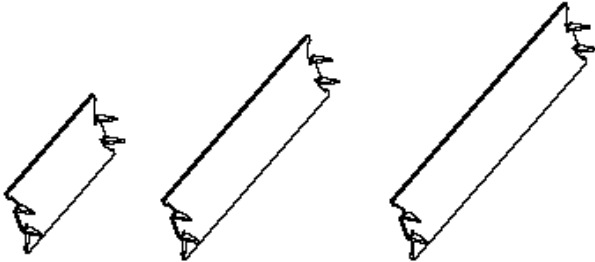

### 1 1/2" Wide Stud Guards

Part Number	Gauge	Width / Length	Price Ea.
SG-183	18	1 1/2" x 3"	
SG-185	18	1 1/2" x 5"	
SG-186	18	1 1/2" x 6"	
SG-163	16	1 1/2" x 3"	
SG-165	16	1 1/2" x 5"	
SG-166	16	1 1/2" x 6"	

Boxed in quantities of 100

## Angles

### 1" x 2" Angles

Part Number	Gauge	Width / Length	Price Ea.
ANG18-1X2	24	1" x 2" x 18"	
ANG24-1X2	24	1" x 2" x 24"	
ANG36-1X2	24	1" x 2" x 36"	
ANG48-1X2	24	1" x 2" x 48"	

Shrink wrapped in quantities of 25

### 1" x 3" Angles

Part Number	Gauge	Width / Length	Price Ea.
ANG18-1X3	24	1" x 3" x 18"	
ANG24-1X3	24	1" x 3" x 24"	
ANG36-1X3	24	1" x 3" x 36"	
ANG48-1X3	24	1" x 3" x 48"	

Shrink wrapped in quantities of 25

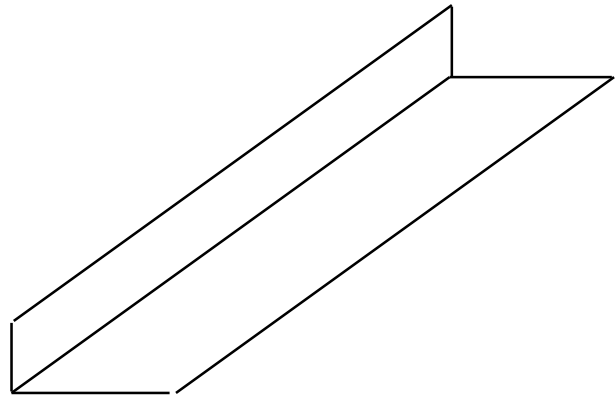

Custom sizes and gauges available - call for pricing



# Plumbers Positioning Bars

## Pro-Span-1620

Part #	Description	Price ea.
PRO-SPAN-1620	Copper Plated Positioning Bar, 20" long, 16 ga.	

**Shrink wrapped in quantities of 25**

### Specifications:

- \* 16 ga. Copper plated steel.
- \* Holes 2" on center for 1/2" diameter pipe.
- \* Repetitive hole pattern for flexibility in placement.

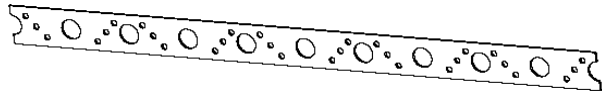

## Pro Span

Part #	Description	Price ea.
PRO-SPAN-20	Copper Plated Positioning Bar, 20" long	
PRO-SPAN-28	Copper Plated Positioning Bar, 28" long	

**Shrink wrapped in quantities of 25**

### Specifications:

- \* Roll formed for rigidity.
- \* Holes 2" on center for 1/2" diameter pipe.
- \* Extruded holes. Greater surface area for solder.
- \* Repetitive hole pattern for flexibility in placement. Easily snipped to maximize yield.
- \* Also available in solid copper. Call for market price.



# Notes

