

# Product Catalog and Dimensional Data

Spring 2018



Centrotherm



**InnoFlue<sup>®</sup>** is the first polymeric vent system tested and listed to ULC-S636 and UL-1738 in North America



# About Centrotherm



Centrotherm  
solutions beyond

## Worldwide

Established in 2009 for the purpose of introducing Polypropylene Vent Systems to the North American market, **Centrotherm Eco Systems** is a member of the Ubbink Centrotherm Group.

Ubbink was founded in the Netherlands in 1896. In 1976, Centrotherm Systemtechnik was established in Brilon, Germany, and in 1998, CENTROTEC Sustainable AG was formed as its parent holding company. Ubbink was acquired by Centrotec Sustainable AG in 2000 and combined with Centrotherm to form the Ubbink-Centrotherm Group. The UCG is the building products division of CENTROTEC, one of Europe's leading manufacturers of a variety of sustainable building solutions. <http://centrotec.de> Today, the UCG has subsidiaries in UK, FR, IT, CN, NE, DE, BE

Now, **Centrotherm Eco Systems** produces its **InnoFlue**<sup>®</sup> Vent Systems, **BlitzFlex**<sup>®</sup> air-intake systems, and accessories based on a wealth of technical know-how and experience accumulated over time. Field

proven for over 20 years, **InnoFlue**<sup>®</sup> has been installed and is performing successfully in millions of homes in the North American and European markets today.

**Centrotherm Eco Systems** supplies its **InnoFlue**<sup>®</sup> Vent Systems, **BlitzFlex**<sup>®</sup> air-intake systems, and accessories to heating professionals through heating and plumbing wholesalers, as well as commercial spec, representatives, and OEMs.

**Centrotherm Eco Systems** also designs, produces, and delivers internal equipment components to many OEMs of high efficiency boilers, tankless water heaters, and furnaces.

The following catalog pages describe our standard products available today.

We are looking forward to your feedback and input to help keep our products on the cutting edge of technology, simplicity, and ease of installation.



**InnoFlue**<sup>®</sup> is the first polymeric vent system tested and listed to UL-C-5636 and UL-1738 in North America



Centrotherm Eco Systems Albany, New York



Centrotherm Systemtechnik GmbH Brilon, Germany

Since 2009, a customer focused approach has positioned **Centrotherm** as the most trusted name in vent manufacturing.

This relentless attention to customer needs has driven **Centrotherm** to be the innovation and safety leader in air intake and flue gas vent systems.

**InnoFlue**<sup>®</sup> polypropylene vent systems and the recent addition of the **BlitzFlex**<sup>®</sup> air-intake system create a complete solution for residential and commercial applications.

**Centrotherm** is committed to venting safely through the expansion of education, adoption, and regulation.

**Centrotherm** has set a tradition of groundbreaking industry firsts:

- ULC-S636 and UL-1738 listed vent system
- Earned and maintains ISO 9001:2015
- Produces polypropylene vent systems in North America
- Dedicated air-intake system
- 1/4" per foot pitch
- 10' effective vent lengths
- Commercial diameter vent products

**Centrotherm** is the right choice for wholesale distributors, engineers, OEMs, and installers.

For more information about **Centrotherm Eco Systems**, visit [www.centrotherm.us.com](http://www.centrotherm.us.com)

## Centrotherm: Solutions Beyond



# Table of contents

<b>About</b>		
<b>Centrotherm</b>		<b>2</b>
<b>Worldwide</b>		<b>2</b>
<b>InnoFlue®</b>		<b>6</b>
<b>The intelligent alternative to PVC &amp; CPVC</b>		<b>6</b>
<b>Why InnoFlue®?</b>		<b>7</b>
<b>Applications and Limitations</b>		<b>8</b>
<b>BlitzFlex® Air-Intake System</b>		<b>9</b>
<b>Typical configurations</b>		<b>10</b>
<b>BlitzFlex®</b>		<b>11</b>
<b>BlitzKits</b>		<b>11</b>
<b>Residential Single Wall</b>		<b>12</b>
<b>Typical configurations</b>		<b>13</b>
<b>Appliance Adaptors</b>		<b>14</b>
Appliance Adaptor for Coupler Style Flue Collars		14
Appliance Adaptor for Flue Collar with Hose Clamp		14
Appliance Adaptor Tapered SS to InnoFlue®		14
Appliance Adaptor Straight SS to InnoFlue®		14
Appliance Adaptors 101mm to PPs		15
Custom Appliance Adaptors		15
<b>Increasesers &amp; Reducers</b>		<b>15</b>
Eccentric Increaser		15
Centric Increaser		15
3 1/2" Reducer		16
Reducers		16
<b>Test Ports</b>		<b>16</b>
Test Ports		16
<b>Vent Lengths</b>		<b>17</b>
Rigid Vent Length		17
<b>Base Supports</b>		<b>17</b>
Base Support		17
B-Vent Base Support Bracket		18
<b>Elbows and Tees</b>		<b>18</b>
15° Elbow		18
30° Elbow		18
45° Elbow		18
45° Elbow Long		19
87° Elbow Long		19
87° Elbow		19
Tee		19
Tee Cap		20
<b>Condensate Management</b>		<b>20</b>
Horizontal Drain Tee		20
Tee Cap with Drain		20
Universal Ball Valve Siphon		21
<b>Residential Single Wall Vent Kits</b>		<b>21</b>
Horizontal Vent Kit		21
<b>Terminations</b>		<b>22</b>
Chimney Cover PPs-UV		22
Chimney Cover SS W/PPs-UV End Pipe		22
Low Profile Wall Termination		22
Universal B-Vent Cap		23
Termination Tee		23
End Pipe PPs-UV		23
Vent Lengths PPs-UV		24
45° Elbow Long PPs-UV		24
45° Elbow PPs-UV		24
87° Elbow Long PPs-UV		24
87° Elbow PPs-UV		24
PPs to PVC Termination Kit		25
<b>Accessories</b>		<b>25</b>
Bird Screen PPs-UV		25
Bird Screen SS		25
2", 3", 4" and 5" Spacers		25
Flue Clamp		26
Support Clamp		26
Wall Plate Square (Plastic)		26
Connector Ring		26
EPDM Gaskets		27
B-Vent Gasket		27
Centrocerin		27
<b>Flex</b>		<b>28</b>
<b>Typical configurations</b>		<b>29</b>
<b>Flex Vent Lengths</b>		<b>30</b>
2" Flex		30
3" and 4" Flex		30
<b>Base Supports</b>		<b>31</b>
Base Support		31
B-Vent Base Support Bracket		31
<b>Couplers and Accessories</b>		<b>31</b>
2", 3", and 4" Spacers		31
SW to Flex Coupler		31
2" Flex to SW Coupler		32
3" and 4" Flex to SW Coupler		32
2" Flex to Flex Coupler		32
3" and 4" Flex to Flex Coupler		32
<b>B-Vent Flex and Component Kits</b>		<b>33</b>
2" B-Vent Kit		33
3" and 4" B-Vent Kit		33
2" Flex Component B-Vent Kit		33
3" and 4" Flex Component B-Vent Kit		34
<b>Chimney Flex and Component Kits</b>		<b>34</b>
2" Chimney Kit		34
3" and 4" Chimney Kit		35
2" Flex Component Chimney Kit		35
3" and 4" Flex Component Chimney Kit		35

<b>Terminations</b>	<b>35</b>	<b>Increases &amp; Reducers</b>	<b>49</b>
Chimney Cover PPs-UV	35	Centric Increaser	49
Custom Chimney Cover PPs-UV	35	Eccentric Increaser	49
2' Flex End Pipe	36	Reducer	50
3' and 4' Flex End Pipe	36	Tapered Reducer	49
Universal B-Vent Cap	36	<b>Test Ports</b>	<b>49</b>
		Test Port	49
<b>Concentric</b>	<b>37</b>	<b>Vent Lengths</b>	<b>50</b>
<b>Typical Configurations</b>	<b>38</b>	Rigid Vent Length	50
<b>Concentric Adaptors</b>	<b>39</b>	<b>Elbows and Tees</b>	<b>50</b>
Concentric Centric Increaser	39	15° Elbow	50
2' / 4 & 3' / 5' Twin Pipe/Concentric Reversible Adaptor	39	Zero Radius 8' 15° Elbow	50
Concentric to Twin Pipe Adaptor	39	30° Elbow	51
Twin Pipe to Concentric Adaptor	39	Zero Radius 8' 30° Elbow	50
<b>Condensate Management</b>	<b>40</b>	45° Elbow	51
Concentric Horizontal Drain Tee	40	Zero Radius 8' 45° Elbow	51
Universal Ball Valve Siphon	40	87° Elbow	51
<b>Concentric Test Ports</b>	<b>40</b>	Zero Radius 8' 87° Elbow	52
Concentric Test Port	40	Tee	52
<b>Concentric Vent Lengths</b>	<b>41</b>	Tee Cap	52
Concentric Vent Lengths	41	<b>Base Supports</b>	<b>52</b>
<b>Elbows</b>	<b>41</b>	Base Support	52
Concentric 45° Elbow	41	<b>Common Venting and Condensate Management</b>	<b>53</b>
Concentric 87° Elbow	41	Branch Tees	53
<b>Roof Flashing</b>	<b>42</b>	Custom Branch Tees	53
Concentric Roof Flashing	42	Cascade Component Kits	54
<b>Terminations</b>	<b>42</b>	Horizontal Drain Tee	54
Concentric Roof Termination	42	Horizontal Drain Fitting	55
Concentric Wall Termination	42	Tee Cap with Drain	55
<b>Concentric Kits</b>	<b>43</b>	Universal Ball Valve Siphon	55
Concentric Kit Horizontal	43	<b>Terminations</b>	<b>56</b>
Concentric Kit Vertical	43	Pitched Roof Flashing	56
<b>Accessories</b>	<b>43</b>	Flat Roof Flashing	56
Wall Plate	43	Chimney Cover SS with PPs-Gray End Pipe	56
Support Clamp	43	End Pipe PPs-Gray	56
		Termination Tee (long)	57
<b>Commercial Single Wall</b>	<b>44</b>	Velocity Cone	57
<b>Typical configurations</b>	<b>45</b>	PPs to PVC Termination Kit	57
<b>Appliance Adaptors</b>	<b>46</b>	<b>Accessories</b>	<b>57</b>
Commercial Appliance Adaptor for Coupler Style		Bird Screen PPs-UV	57
Flue Collar	46	Bird Screen SS	58
Commercial Appliance Adaptor for Flue Collar with		Spacers	58
Hose Clamp	46	Flue Clamp	58
Commercial Appliance Adaptor w/ Condensate		Connector Ring	58
Drain and Vibration Isolation Boot OEM to InnoFlue®	46	Wall Plates	59
Commercial Flanged Adaptor OEM to InnoFlue®	47	Connector Double Hose Clamp	59
Commercial Appliance Adaptor OEM to InnoFlue®	47	Support Clamp	59
Commercial Appliance Adaptor SS to InnoFlue®	47	EPDM Gaskets	59
Vibration Isolation Boot with Clamps	47	Centrocerin	59
Custom Appliance Adaptors	48		

# InnoFlue®

## The intelligent alternative to PVC & CPVC

Across North America, home owners, maintenance professionals, contractors, distributors, engineers and heating equipment manufacturers are recognizing the unmatched value InnoFlue® delivers to the HVAC industry.

Manufactured from environmentally friendly polypropylene, InnoFlue® has been tested and is listed to all relevant American, Canadian and European Safety Standards. It is listed and warranted for sustained flue gas temperatures up to 230°F (110°C), thus providing enhanced performance properties and significant safety margins. Centrotherm offers a comprehensive product line including test/inspection ports, condensate drains, siphons, flue collar adaptors, as well as excellent technical, sales and marketing support.

InnoFlue® Vent Systems are professional, reliable, environmentally sustainable and offer substantial labor savings due to reduced installation times.



## Why InnoFlue®?

### Ease of Installation

- Integrated gasket system allows for:
  - Faster, cleaner, V.O.C.-free installation
  - Immediate use of appliances upon installation
  - Post-installation adjustments
- No fit up, couplers, primers or adhesives needed
- Light weight makes for easy handling and rapid installation
- New 1/4" pitch for 2', 3' and 4' Single Wall vent systems

### Health and Safety

ETL Listed: UL 1738, ULC-S636  
Listed: CE EN 14471

- Performs at sustained flue temperatures up to 230°F (110°C)
- Listed at zero clearance to combustibles for all systems configurations
- Environmentally-friendly polypropylene is 100% recyclable
- Industry leading wall thickness enhances structural durability
- Chloride free

### Warranty & Reliability

- Manufacturer-supported and guaranteed with an unprecedented 10-year limited warranty
- Enhanced corrosion resistance allows for use with oil, propane, and natural gas fired appliances
- Over 20 years of field service history

## Listings



Centrotherm made the commitment and investment to have its Single Wall, Flexible and Concentric Vent Systems tested to the industry relevant UL-1738, ULC-S636 and CE EN 14471 safety standards. Thus InnoFlue® is approved for use in the United States, Canada and most European Countries.

As of this printing, InnoFlue® is the only polypropylene vent system to be listed by an accredited third party to the rigorous safety standards, UL 1738, ULC-S636 and CE EN 14471.

For information about Centrotherm's product testing and listings, visit:

**UL 1738 - Intertek**  
**ULC-S636 - Intertek**  
**CE EN 14471 - TÜV**



## Product Approvals

Since 2010, Centrotherm's InnoFlue® has been accepted and approved by over 50 North American manufacturers of boilers, water heaters and furnaces. For a complete listing of the approvals, visit

<http://www.centrotherm.us.com/Tools/OEM-Approval-Matrix.aspx>

Our appliance approvals increase regularly.

For any questions, please contact your manufacturer's representative or [Centrotherm Eco Systems](#).

## Applications and Limitations

- In order to maintain relevant listings and Centrotherm's warranty, **InnoFlue**<sup>®</sup> vent systems may not be combined with any polymeric or stainless steel vent components that are not part of Centrotherm's published offerings.
- **InnoFlue**<sup>®</sup> SW, **InnoFlue**<sup>®</sup> Flex, **InnoFlue**<sup>®</sup> Concentric, and **BlitzFlex**<sup>®</sup> must be installed following Centrotherm's published installation instructions.
- **InnoFlue**<sup>®</sup> SW, **InnoFlue**<sup>®</sup> Flex, and **InnoFlue**<sup>®</sup> Concentric are ETL listed to UL and ULC standards for use with natural gas or propane fired, Cat. II or Cat. IV appliances (US) or BH Gas Class II A, B and C gas or propane fired appliances (Canada).
- **InnoFlue**<sup>®</sup> SW, **InnoFlue**<sup>®</sup> Flex, and **InnoFlue**<sup>®</sup> Concentric can also be used for oil fired, condensing appliances with a maximum flue gas temperature that does not exceed 230°F (110°C).
- **InnoFlue**<sup>®</sup> SW, **InnoFlue**<sup>®</sup> Flex, and **InnoFlue**<sup>®</sup> Concentric are ETL listed to UL 1738 and ULC-S636 at zero clearance to combustibles.
- **InnoFlue**<sup>®</sup> SW, **InnoFlue**<sup>®</sup> Flex, and **InnoFlue**<sup>®</sup> Concentric may be installed inside a masonry or sheet rocked chase, through an existing structurally intact metal flue, between floor joists, directly through a wall or if properly supported, can even be left exposed along the interior of a structure.
- **InnoFlue**<sup>®</sup> Flex is available in 2", 3" and 4" diameters and offers all necessary components for combining it with **InnoFlue**<sup>®</sup> SW and **InnoFlue**<sup>®</sup> Concentric to meet specific job requirements.
- **InnoFlue**<sup>®</sup> Flex may be used in offsets or bends not to exceed 45° from vertical.
- **InnoFlue**<sup>®</sup> Flex must be installed inside a masonry chimney or sheet rocked chase, or through an existing, structurally intact metal flue.
- Single or multiple **InnoFlue**<sup>®</sup> Flex exhausts may be installed into an existing masonry chimney or structurally intact metal flue or chase.
- When the outside temperature is less than 32°F (0°C), install **InnoFlue**<sup>®</sup> Flex and **BlitzFlex**<sup>®</sup> from the bottom of a chase from inside the building.
- When using **InnoFlue**<sup>®</sup> Flex, reduce maximum vent length per equipment manufacturer's instruction manual.
- **InnoFlue**<sup>®</sup> Concentric is available in 2'4", 3'5" and 4'6" diameters and offers all necessary components for combining it with **InnoFlue**<sup>®</sup> SW and **InnoFlue**<sup>®</sup> Flex to meet specific job requirements.
- Do not install where ambient air temperature can exceed 300°F.





**BlitzFlex®**

**BLITZ**  **FLEX**®  
THE FASTEST AIR INTAKE SOLUTION

**Note: For air-intake only. Do not use with flue gas.**

## Typical configurations

- 2 ISEL: Elbow
- 3 ISVL: Vent Length
- 4 IASCM: Support Clamp
- 12 Appliance Adaptor
- 25 IASP: Spacer
- 28 ISCP: Chimney Cover PPs-UV
- 40 BlitzFlex® Air-Intake Component

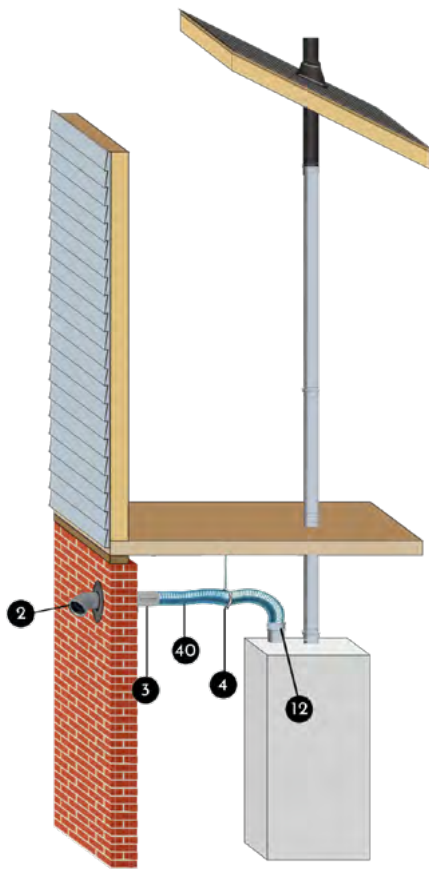

**BlitzFlex®** Sidewall Termination, where **BlitzFlex®** provides one continuous air-intake from appliance adaptor to termination, and terminates horizontally with a **Centrotherm BlitzKit**.

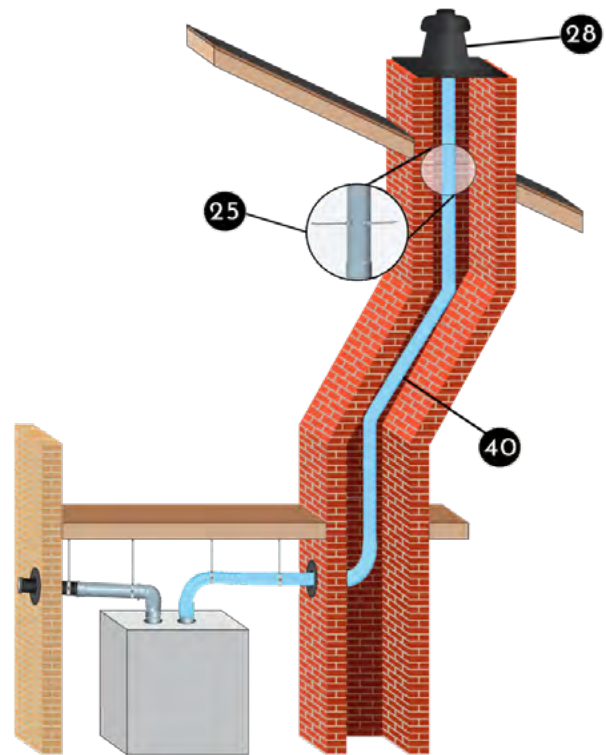

**BlitzFlex®** is designed to handle offsets for the air-intake run, and reduces necessary components thus saving time and money on every job. Pull **BlitzFlex®** from the box, cut it to length, and install a continuous in-take system in minutes.

**Note:** Additional supports may be required on longer runs.

**Note:** BlitzFlex® can be terminated using the same configurations as InnoFlue® Flex. Please refer to the layouts on page 29 for additional vertical termination options.

**FOR AIR INTAKE USE ONLY. DO NOT USE WITH FLUE GAS.**

**Contact Centrotherm with any questions.**

# BlitzFlex® Air-Intake System



### BlitzFlex® Air-Intake Component

Is manufactured from corrugated polymer. **BlitzFlex®** can be field cut to desired length. Use with BlitzKit to create a complete air intake system in a single continuous run.

Nominal Diameter	Part	Coil Length	Box Height	Box Length	Box Width
2" (60)	BFVL02050	50'	12.5"	26.5"	26.5"
3" (80)	BFVL03050	50'	16.75"	30.5"	30.75"
4" (110)	BFVL04050	50'	35.5"	37"	20.5"



### Horizontal BlitzKits

Are manufactured from polypropylene for use with **BlitzFlex®**. Contains **InnoFlue®** appliance adaptor (QTY 1), support clamps (QTY 2), 45° elbow (QTY 1), and 2' vent length (QTY 1). Additional supports may be required on longer runs.

Note: 2' BlitzKits come with Rigid to Flex Couplers (QTY 2)

Nominal Diameter	Part	Height	Length	Width
2" (60)	BFCK02	17.5"	7.25"	7.25"
3" (80)	BFCK03	30.8"	7.25"	7.25"
4" (110)	BFCK04	30.8"	7.25"	7.25"



BlitzFlex®

# Residential SW

Residential SW

# Typical configurations

- 2 ISEL87: 87° Elbow
- 3 ISVL: Vent Length
- 4 IASCM: Support Clamp
- 5 IANS: Connector Ring
- 6 IAWP: Wall Plate
- 7 ISEP: End Pipe PPs-UV
- 8 ISTT: Termination Tee PPs-UV
- 9 IASPP: Bird Screen PPs-UV
- 11 ISELLUV: 87° Elbow Long PPs-UV
- 12 ISAGL or ISAAL: Appliance Adaptor
- 13 ISLPT: Low Profile Wall Termination
- 14 ICTC: Twin Pipe to Concentric Adaptor
- 15 ICRT: Concentric Roof Termination
- 16 ISVLUV: Vent Length PPs-UV Black

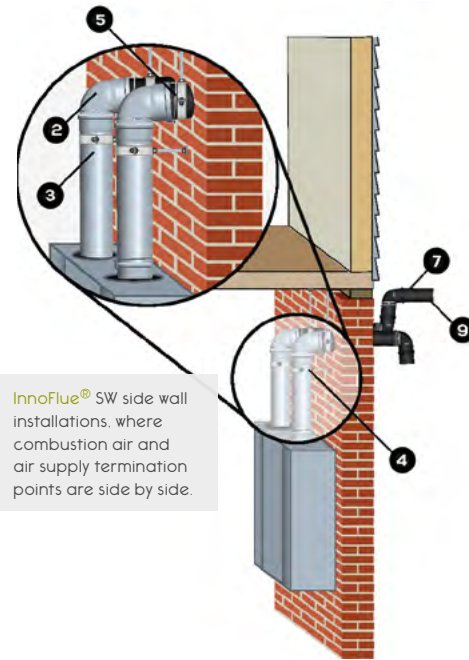

InnoFlue® SW side wall installations, where combustion air and air supply termination points are side by side.

InnoFlue® SW side wall installations where combustion air and supply termination points can be significantly separated.

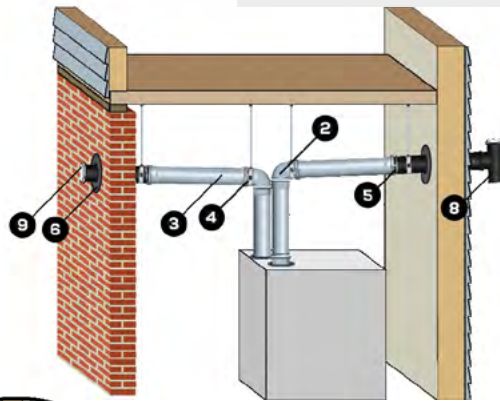

InnoFlue® SW side wall installations, where exhaust and air supply remain separated through the Low Profile Wall Termination.

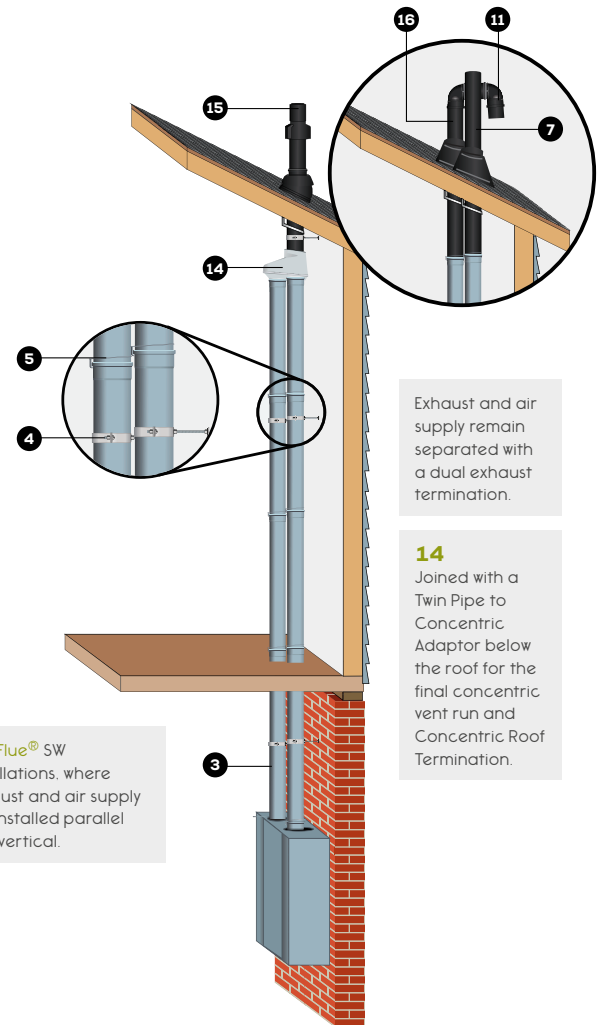
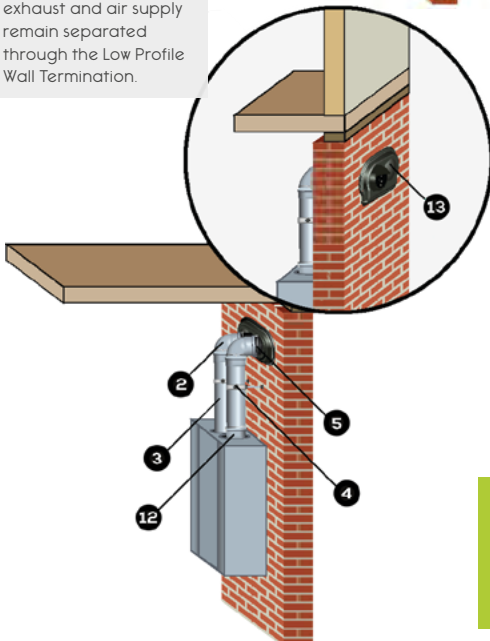

Exhaust and air supply remain separated with a dual exhaust termination.

**14** Joined with a Twin Pipe to Concentric Adaptor below the roof for the final concentric vent run and Concentric Roof Termination.

InnoFlue® SW installations, where exhaust and air supply are installed parallel and vertical.

For each configuration, see installation instructions and specific code requirements.

# Appliance Adaptors

Check adaptor matrix at [www.centrotherm.us.com/Tools/OEM-Approval-Matrix.aspx](http://www.centrotherm.us.com/Tools/OEM-Approval-Matrix.aspx)

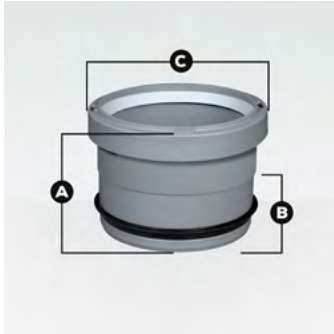

## Appliance Adaptor for Coupler Style Flue Collars

Adapts a female PVC / CPVC coupler or appliance flue exhaust to InnoFlue® SW diameters.

Nominal Diameter PVC to PP	Part	Overall Length A	Effective Length B	Max O.D. C
2"/2" (60/60)	ISAGL0202	3.3 (83)	1.0 (26)	3.0 (76)
3"/3" (89/80)	ISAGL0303	3.0 (75)	0.8 (21)	3.8 (97)
4"/4" (114/110)	ISAGL0404	3.4 (87)	0.8 (21)	5.1 (129)
5"/5" (140/125)	ISAGL0505	5.7 (144)	0.8 (21)	5.8 (146)

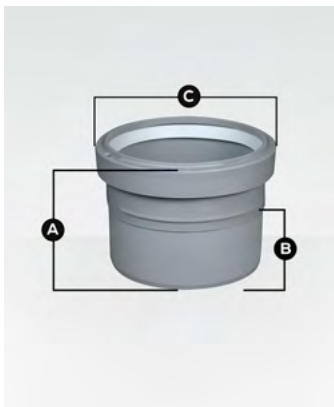

## Appliance Adaptor for Flue Collar with Hose Clamp

Adapts a female PVC / CPVC sized appliance collar (with integrated gasket) to InnoFlue® SW diameters.

Nominal Diameter PVC to PP	Part	Overall Length A	Effective Length B	Max O.D. C
2"/2" (60/60)	ISAAL0202	3.3 (83)	1.0 (26)	3.0 (76)
3"/3" (89/80)	ISAAL0303	3.0 (75)	0.8 (21)	3.8 (97)
4"/4" (114/110)	ISAAL0404	3.4 (87)	0.8 (21)	5.1 (129)
5"/5" (140/125)	ISAAL0505	5.7 (144)	0.8 (21)	5.8 (146)



## Appliance Adaptor Tapered SS to InnoFlue®

Adapts a tapered female stainless steel appliance flue exhaust with tabs to InnoFlue®.

Nominal Diameter	Part	Overall Length A	Effective Length B	Max O.D. C
3" (80)	ISAAS0303	4.5 (115)	0.8 (21)	3.8 (97)
4" (110)	ISAAS0404	4.8 (122)	0.8 (21)	5.1 (129)

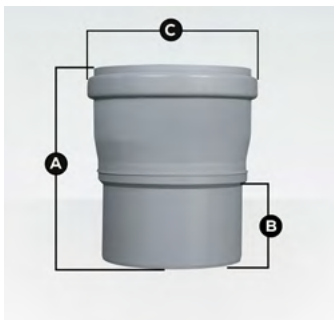

## Appliance Adaptor Straight SS to InnoFlue®

Adapts a stainless steel appliance flue exhaust with gasket and clamp to InnoFlue®.

Nominal Diameter	Part	Overall Length A	Effective Length B	Max O.D. C
3"/3" (76/80)	ISSA0303	6.0 (153)	3.1 (78)	3.8 (97)
4"/4" (102/110)	ISSA0404	6.0 (153)	3.6 (91)	5.1 (129)
5"/5" (127/125)	ISSA0505	6.5 (166)	3.9 (99)	5.8 (146)

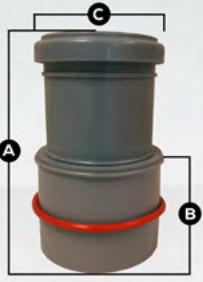

### Appliance Adaptors 101mm to PPs

Adapts 101mm diameter flue exhaust to InnoFlue® Adaptors include replacement o-ring for flue collar.

Nominal Diameter PVC to PP	Part	Overall Length <b>A</b>	Effective Length <b>B</b>	Max O.D. <b>C</b>
4" (100/101)/3" (80)	ISAO10103	6.5 (165)	3.3 (84)	3.8 (97)
4" (100/101)/4" (110)	ISAO10104	6.4 (163)	4.0 (102)	5.1 (129)

Available

### Custom Appliance Adaptors

Available to fit most residential and commercial heating appliances. Call for pricing.

## Increase & Reducers



### Eccentric In creaser

Transitions vent system to a larger diameter. Install in horizontal or vertical orientation. Other size combinations available upon request.

Nominal Diameter	Part	Overall Length <b>A</b>	Effective Length <b>B</b>	Max O.D. <b>C</b>
2"/3" (60/80)	ISEI0203	5.3 (135)	3.1 (79)	3.8 (97)
3"/4" (80/110)	ISEI0304	6.1 (156)	3.6 (91)	5.1 (129)
4"/5" (110/125)	ISEI0405	6.7 (170)	4.2 (106)	5.8 (146)



### Centric In creaser

Transitions vent system to a larger diameter. Install in vertical orientation only. Additional configurations available upon request.

Nominal Diameter	Part	Overall Length <b>A</b>	Effective Length <b>B</b>	Max O.D. <b>C</b>
2"/3" (60/80)	ISIA0203	5.9 (150)	3.5 (89)	3.8 (97)
3"/4" (80/110)	ISIA0304	5.7 (145)	3.2 (81)	5.1 (129)
4"/4" (100/110)	ISIA10004	6.4 (163)	4.2 (105)	5.1 (129)
4"/5" (110/125)	ISIA0405	6.8 (173)	4.3 (110)	5.8 (146)



**3/2 Reducer**

Transitions vent system to a smaller diameter.

Nominal Diameter	Part	Overall Length <b>A</b>	Effective Length <b>B</b>	Max O.D. <b>C</b>
3"/2" (80/60)	ISRD0302	60 (153)	3.5 (89)	3.2 (80)



**Reducers**

Transitions vent system to a smaller diameter.

Nominal Diameter	Part	Overall Length <b>A</b>	Effective Length <b>B</b>	Max O.D. <b>C</b>
4"/3" (110/80)	ISRD0403	6.0 (153)	3.5 (89)	4.3 (110)
5"/4" (125/110)	ISRD0504	6.5 (166)	4.0 (102)	4.9 (125)
6"/4" (160/110)	ISRD0604	6.5 (166)	4.0 (102)	6.3 (160)
6"/5" (160/125)	ISRD0605	6.5 (166)	4.0 (102)	6.3 (160)
5"/5" (130/125)	ISRD13005	5.0 (127)	4.7 (120)	5.1 (130)
6"/4" (150/110)	ISRD15004	8.8 (223)	6.5 (165)	5.9 (150)
6"/5" (150/125)	ISRD15005	9.1 (230)	6.7 (170)	5.9 (150)

## Test Ports

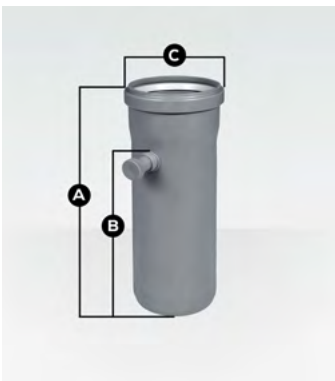

**Test Ports**

Installed immediately above the appliance, the test port allows plumbing and heating professionals to sample flue gases and ensure the appliance is operating at optimum efficiency.

Nominal Diameter	Part	Overall Length <b>A</b>	Effective Length <b>B</b>	Max O.D. <b>C</b>
2" (60)	ISTP02	7.0 (170)	4.3 (110)	3.0 (76)
3" (80)	ISTP03	7.0 (170)	4.5 (115)	3.8 (97)
4" (110)	ISTP04	12.4 (314)	9.8 (250)	5.1 (129)
5" (125)	ISTP05	12.6 (320)	9.8 (250)	5.8 (146)



## Vent Lengths

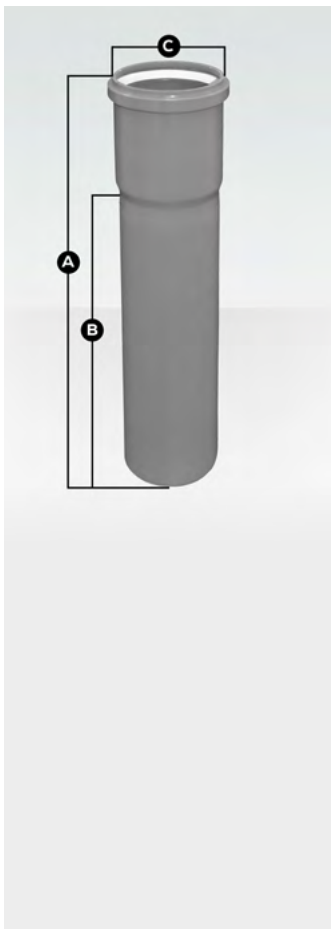

### Rigid Vent Length

Rigid polypropylene vent lengths with dedicated male and female ends. Female ends contain internal gasket and male ends can be field cut and chamfered to desired length.

Nominal Diameter	Part	Overall Length A	Effective Length B	Max O.D. C
2" (60)	ISVL021	16.4 (411)	12 (305)	3.0 (76)
2" (60)	ISVL022	28.4 (716)	24 (610)	3.0 (76)
2" (60)	ISVL023	40.4 (1021)	36 (914)	3.0 (76)
2" (60)	ISVL026	76.4 (1935)	72 (1829)	3.0 (76)
2" (60)	ISVL0210	124.2 (3155)	120 (3048)	3.0 (76)
3" (80)	ISVL031	16.4 (411)	12 (305)	3.8 (97)
3" (80)	ISVL032	28.4 (716)	24 (610)	3.8 (97)
3" (80)	ISVL033	40.2 (1021)	36 (914)	3.8 (97)
3" (80)	ISVL036	76.4 (1935)	72 (1829)	3.8 (97)
3" (80)	ISVL0310	124.2 (3155)	120 (3048)	3.8 (97)
4" (110)	ISVL041	16.0 (406)	12 (305)	5.1 (129)
4" (110)	ISVL042	28.0 (711)	24 (610)	5.1 (129)
4" (110)	ISVL043	40.2 (1016)	36 (914)	5.1 (129)
4" (110)	ISVL046	76.2 (1930)	72 (1829)	5.1 (129)
4" (110)	ISVL0410	124.2 (3155)	120 (3048)	5.1 (129)
5" (125)	ISVL051	15.9 (404)	12 (305)	5.8 (146)
5" (125)	ISVL052	27.9 (709)	24 (610)	5.8 (146)
5" (125)	ISVL053	39.9 (1013)	36 (914)	5.8 (146)
5" (125)	ISVL056	75.9 (1928)	72 (1829)	5.8 (146)

## Base Supports

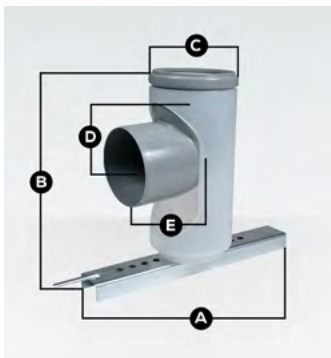

### Base Support

Supports vertical sections of rigid (up to 164') and flexible (up to 98' with Flex end pipe) vent lengths installed in chimneys and chases.

Nominal Diameter	Part	Base Length A	Height B	Max O.D. C	Effective D	Effective E
2" (60)	ISBS0287	15.8 (400)	9.4 (238)	3.0 (76)	2.7 (69)	4.6 (118)
3" (80)	ISBS0387	15.8 (400)	10.6 (269)	3.8 (97)	3.4 (86)	4.9 (125)
4" (110)	ISBS0487	15.8 (400)	11.5 (291)	5.1 (129)	2.6 (65)	4.5 (115)
5" (125)	ISBS0587	15.8 (400)	13.4 (341)	5.8 (146)	2.9 (74)	5.4 (136)

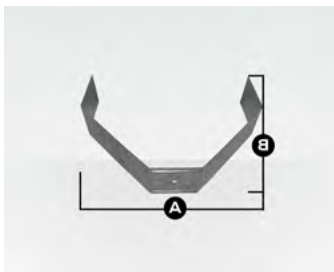

### Base Support Bracket

B-Vent Support Bracket (IABVSB) replaces metal channel on base support to support vertical sections of rigid and flexible vent lengths installed inside a B-Vent. Fastens to floor joists.

Part	Width A	Height B
IABVSB	17.5 (446)	11.8 (298)

## Elbows and Tees

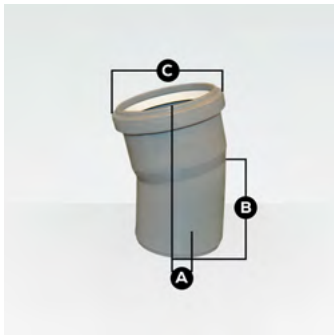

### 15° Elbow

For offsets or changes in the direction of the vent system.

Nominal Diameter	Part	Centerline Offset A	Effective Length B	Max O.D. C
2" (60)	ISEL0215	0.7 (18)	3.3 (84)	3.0 (76)
3" (80)	ISEL0315	0.7 (18)	3.1 (79)	3.8 (97)
4" (110)	ISEL0415	0.8 (20)	3.6 (91)	5.1 (129)
5" (125)	ISEL0515	0.9 (23)	4.6 (117)	5.8 (146)

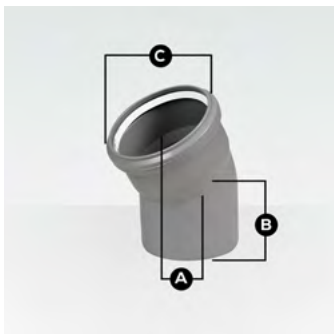

### 30° Elbow

For offsets or changes in the direction of the vent system.

Nominal Diameter	Part	Centerline Offset A	Effective Length B	Max O.D. C
2" (60)	ISEL0230	1.5 (38)	3.6 (91)	3.0 (76)
3" (80)	ISEL0330	1.4 (36)	3.4 (86)	3.8 (97)
4" (110)	ISEL0430	1.7 (43)	4.1 (104)	5.1 (129)
5" (125)	ISEL0530	1.8 (46)	5.1 (130)	5.8 (146)

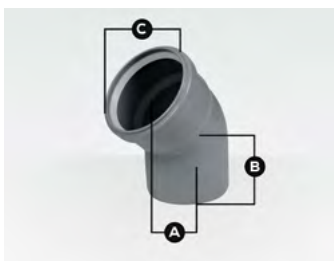

### 45° Elbow

For offsets or changes in the direction of the vent system.

Nominal Diameter	Part	Centerline Offset A	Effective Length B	Max O.D. C
3" (80)	ISEL0345	2.2 (56)	3.6 (92)	3.8 (97)
5" (125)	ISEL0545	2.7 (68)	4.8 (122)	5.8 (146)

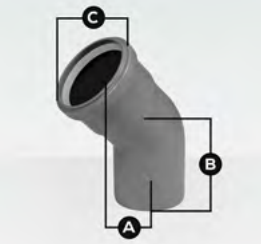

45° Elbow Long				
Longer 45° Elbow allows for greater offsets or changes in the direction of the vent system.				
Nominal Diameter	Part	Centerline Offset <b>A</b>	Effective Length <b>B</b>	Max O.D. <b>C</b>
2" (60)	ISELL0245	2.2 (56)	3.8 (96)	3.0 (76)
4" (110)	ISELL0445	1.5 (39)	5.2 (133)	5.1 (129)



87° Elbow Long				
For offsets or changes in the direction of the vent system.				
Nominal Diameter	Part	Centerline Offset <b>A</b>	Effective Length <b>B</b>	Max O.D. <b>C</b>
2" (60)	ISELL0287	2.5 (63)	4.8 (121)	3.0 (76)
4" (110)	ISELL0487	4.4 (111)	6.5 (165)	5.1 (129)

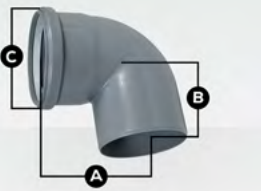

87° Elbow				
For offsets or changes in the direction of the vent system.				
Nominal Diameter	Part	Centerline Offset <b>A</b>	Effective Length <b>B</b>	Max O.D. <b>C</b>
3" (80)	ISEL0387	5.3 (133)	5.0 (127)	3.7 (97)
5" (125)	ISEL0587	2.7 (68)	5.5 (139)	5.8 (146)

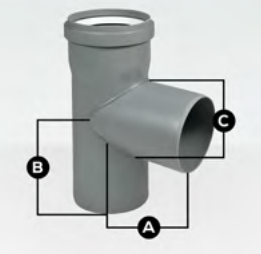

Tee				
Use to change the direction of the vent system, combine multiple appliances, and capture condensates at base of long vertical runs.				
Nominal Diameter	Part	Effective Length <b>A</b>	Effective Length <b>B</b>	Effective Length <b>C</b>
2" (60)	IST02	6.3 (160)	8.7 (221)	2.6 (66)
3" (80)	IST03	6.3 (160)	8.7 (221)	2.7 (69)
4" (110)	IST04	5.6 (142)	8.4 (214)	3.0 (76)
5" (125)	IST05	5.9 (149)	10.1 (256)	3.7 (94)

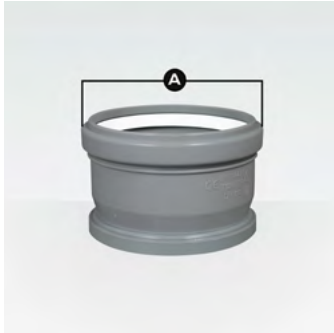

Tee Cap		
Seals non-utilized tees and branch tees.		
Nominal Diameter	Part	Max O.D. A
2" (60)	ISTC02	3.0 (76)
3" (80)	ISTC03	3.8 (97)
4" (110)	ISTC04	5.1 (129)
5" (125)	ISTC05	5.8 (146)

## Condensate Management

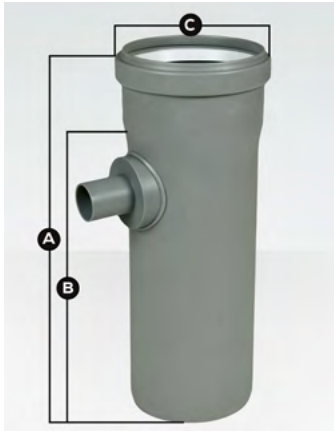

Horizontal Drain Tee				
Use with any InnoFlue® siphon to drain condensate from the vent system. Install in horizontal section closest to appliance. 1.26" (32mm) O.D. drain.				
Nominal Diameter	Part	Overall Length A	Effective Length B	Max O.D. C
2" (60)	ISHDT02	9.8 (250)	7.3 (186)	3.0 (76)
3" (80)	ISHDT03	9.8 (250)	7.3 (186)	3.7 (94)
4" (110)	ISHDT04	12.4 (315)	9.8 (250)	4.1 (129)
5" (125)	ISHDT05	12.4 (315)	9.8 (250)	5.8 (146)

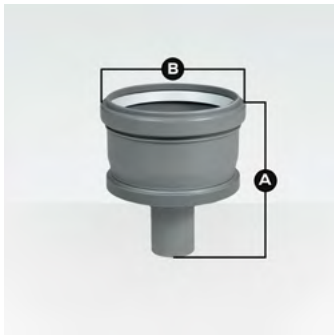

Tee Cap with Drain				
Use with any InnoFlue® siphon to drain condensate from the vent system.				
Nominal Diameter	Part	Overall Length A	Max O.D. B	Drain O.D. C
2" (60)	ISTCD02	6.1 (155)	3.0 (75)	1.3 (32)
3" (80)	ISTCD03	5.3 (135)	3.7 (95)	1.3 (32)
4" (110)	ISTCD04	5.9 (150)	5.0 (126)	1.3 (32)
5" (125)	ISTCD05	6.4 (163)	5.8 (146)	1.3 (32)

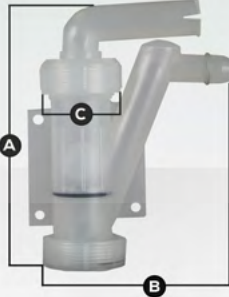

### Universal Ball Valve Siphon

Attaches to any InnoFlue® drain. Allows condensates to flow while unique ball valve assures combustion gases remain contained at higher temperatures. Comes with and can be installed with a barbed or compression fitting. See configuration options below.

Part	Overall Height A	Width B	Length C
IASJBVS	6.5	4.5	1.9



**Standard**



**Barbed**



**NRV**

## Horizontal Vent Kits



### Horizontal Vent Kit

Includes all fittings and accessories required for short sidewall termination vent runs.

Nominal Diameter	Part
2" (60)	ISVKH02
3" (80)	ISVKH03
4" (110)	ISVKH04
5" (125)	ISVKH05

## Terminations



### Chimney Cover PPs-UV

This termination incorporates a combustion air intake and flue gas termination in a single assembly. Cover seals top of the chimney or chase. Use with End Pipe or Flex End Pipe. End Pipes sold separately.

Nominal Diameter	Part	Length A	Height B
2" (60)	ISCP02	15.8 (400)	9.6 (245)
3" (80)	ISCP03	15.8 (400)	9.6 (245)
4" (110)	ISCP04	15.8 (400)	9.6 (245)

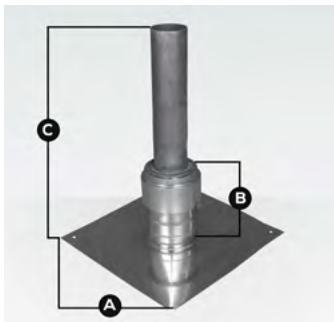

### Chimney Cover SS W/PPs-UV End Pipe

Stainless steel termination with polypropylene end pipe incorporates a combustion air intake and flue gas termination in a single assembly.

Nominal Diameter	Part	Length A	Height B	Height C
3" (80)	ISCM03	16.5 (419.1)	7.9 (200)	13.75 (349.3)
4" (110)	ISCM04	16.5 (419.1)	7.9 (200)	13.75 (349.3)
5" (125)	ISCM05	16.5 (419.1)	7.9 (200)	13.75 (349.3)



### Low Profile Wall Termination (2" and 3")

Low Profile Wall Termination incorporates air intake and exhaust into a single aesthetically pleasing termination. Part is paintable to match exterior of structure. Comes with interior wall plate and bird screen. Exhaust can be extended or re-directed with elbows or vent lengths. Vent lengths and elbows sold separately.

Nominal Diameter	Part	Overall Width A	Overall Height B
2" (60)	ISLPT0202	13 (330)	9.1 (231)
3" (80)	ISLPT0303	13 (330)	9.1 (231)



### Low Profile Wall Termination (4")

Low Profile Wall Termination incorporates air intake and exhaust into a single aesthetically pleasing termination. Part is paintable to match exterior of structure. Comes with interior wall plate and bird screen. Exhaust can be extended or re-directed with elbows or vent lengths. Vent lengths and elbows sold separately.

Nominal Diameter	Part	Overall Width A	Overall Height B
4" (60)	ISLPT0404	23 (584)	15 (305)



### Universal B-Vent Cap

Allows for multiple flue configurations. Utilize existing B-Vent as a chase. Clean, professional and aesthetically pleasing. Installs quickly and easily.

Part	Length	Height	Width
IAUBVC	10"	10"	10"



One Part Multiple Configurations

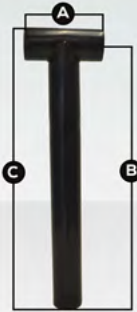

### Termination Tee

Made from black U.V. stabilized polypropylene. Use where termination is exposed to excessive sunlight, wind or prone to freeze ups.

Nominal Diameter	Part	Overall Width A	Effective Length B	Max Length C
2" (60)	ISTT0220	7.6 (193)	27.6	28.8
3" (80)	ISTT0320	7.6 (193)	27.6	29.2
4" (110)	ISTT0420	7.6 (193)	27.6	29.8
5" (125)	ISTT0520	8.0 (203)	27.6	30.1



### End Pipe PPs-UV

Made from black U.V. stabilized polypropylene. Use where termination is exposed to excessive sunlight.

Nominal Diameter	Part	Overall Length A	Max O.D. B
2" (60)	ISEP02	19.7 (500)	2.4 (60)
2" (60)	ISEP0239	39.4 (1000)	2.4 (60)
3" (80)	ISEP03	19.7 (500)	3.2 (80)
3" (80)	ISEP0339	39.4 (1000)	3.2 (80)
4" (110)	ISEP04	19.7 (500)	4.3 (110)
4" (110)	ISEP0439	39.4 (1000)	4.3 (110)



Vent Lengths PPs-UV				
Allows for the exterior extension of the vent system.				
Nominal Diameter	Part	Overall Length <b>A</b>	Effective Length <b>B</b>	Max O.D. <b>C</b>
2" (60)	ISVL022UV	28.4 (721)	24 (610)	3.0 (75)
3" (80)	ISVL032UV	28.4 (721)	24 (610)	3.8 (97)
4" (110)	ISVL042UV	28.2 (716)	24 (610)	5.1 (129)
5" (125)	ISVL052UV	26.5 (673)	24 (610)	5.8 (146)



45° Elbow Long PPS-UV				
For exterior offsets or changes in the direction of the vent system.				
Nominal Diameter	Part	Centerline Offset <b>A</b>	Effective Length <b>B</b>	Max O.D. <b>C</b>
2" (60)	ISELL0245UV	2.2 (56)	3.8 (96)	3.0 (76)
3" (80)	ISELL0345UV	2.9 (73)	4.6 (117)	3.8 (97)
4" (110)	ISELL0445UV	1.5 (39)	5.2 (133)	5.1 (129)

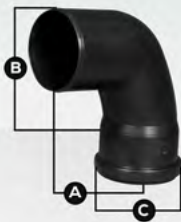

87° Elbow Long PPS-UV				
For exterior offsets or changes in the direction of the vent system.				
Nominal Diameter	Part	Centerline Offset <b>A</b>	Effective Length <b>B</b>	Max O.D. <b>C</b>
2" (60)	ISELL0287UV	2.5 (63)	4.8 (121)	3.0 (76)
3" (80)	ISELL0387UV	5.3 (133)	5.1 (129)	3.8 (97)
4" (110)	ISELL0487UV	4.4 (111)	6.5 (165)	5.1 (129)



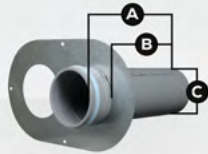

### PPs to PVC Termination Kit

Adapts PPs to PVC Twin Pipe Termination. Comes with replacement wall plate and termination adaptor.

Nominal Diameter	Part	Overall Length <b>A</b>	Effective Length <b>B</b>	End O.D. <b>C</b>
2" (60)	ISLTK02	12.3 (313)	11.0 (280)	2.4 (61)
3" (80)	ISLTK03	13.0 (330)	11.0 (280)	3.5 (89)
4" (110)	ISLTK04	13.2 (336)	11.0 (280)	4.5 (115)

## Accessories



### Bird Screen PPs-UV

Fits inside InnoFlue® SW and Flex end-pipes at terminations.

Nominal Diameter	Part
2" (60)	IASPP02
3" (80)	IASPP03
4" (110)	IASPP04



### Bird Screen SS

Fits inside InnoFlue® SW and Flex end-pipes at terminations.

Nominal Diameter	Part
5" (125)	IASSS05



### 2", 3", 4" and 5" Spacers

Self positioning spacers center InnoFlue® SW or Flex in a chase/chimney/B-vent.

Nominal Diameter	Part	Max Width <b>A</b>	Min Width
2" (60)	IASP02	23.5 (596)	3.3 (85)
3" (80)	IASP03	22.8 (580)	4.2 (106)
4" (110)	IASP04	23.9 (606)	5.4 (138)
5" (125)	IASP05	24.6 (625)	6 (151)

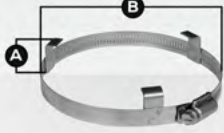

### Flue Clamp

Secures ISAGL appliance adaptors to appliance flue collar.

Nominal Diameter	Part	Height A	Max. I.D. B
2" (60)	IAFC02	1.0 (26)	3.0 (77)
3" (80)	IAFC03	1.0 (26)	4.3 (110)
4" (110)	IAFC04	1.0 (26)	5.0 (127)



### Support Clamp

Used as vertical or horizontal support. Space 78" in vertical and 39" in horizontal installations. **Uses 3/8" threaded rod.**

Nominal Diameter	Part	Overall Length A	Height B
2" (60)	IASCM02	3 (76.2)	1.1(28)
3" (80)	IASCM03	3.8 (96.5)	1.1 (28)
4" (110)	IASCM04	5.3 (134.6)	1.1 (28)
5" (125)	IASCM05	5.8 (147.3)	1.1 (28)

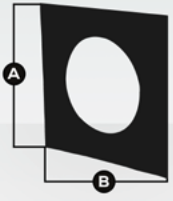

### Wall Plate Square (Plastic)

Used to improve aesthetics and reduce drafts at chimney openings or wall penetrations.

Nominal Diameter	Part	Length A	Length B
2" (60)	IAWP02BP	6 (150)	6 (150)
3" (80)	IAWP03BP	6 (150)	6 (150)
4" (110)	IAWP04BP	6 (150)	6 (150)



### Connector Ring

Provides reinforcement at joints to support loads of up to 99 lbs (45kg).

Nominal Diameter	Part	O.D. A
2" (60)	IANS02	3.2 (81)
3" (80)	IANS03	4.1 (103)
4" (110)	IANS04	5.3 (134)
5" (125)	IANS05	5.8 (148)



### EPDM Gaskets

Standard gasket for 2" through 5" diameter InnoFlue® SW. Inserted into the female end of each part, the gaskets keep flue gases and condensates within the vent system.

Nominal Diameter	Part
2" (60)	ISGE02
3" (80)	ISGE03
4" (110)	ISGE04
5" (125)	ISGE05



### B-Vent Gasket

Rubber gasket for converting existing B-Vent into a combustion air chase. Nominal

Diameter	Part	Flange I.D. A	Max O.D. B	Groove Thickness C
2" (60)	IACGE02	2.8 (72)	3.5 (88)	0.1 (2.5)
3" (80)	IACGE03	3.6 (92)	4.3 (108)	0.1 (2.5)
4" (110)	IACGE04	4.8 (122)	5.4 (137)	0.1 (2.5)



### Centrocerin

A water based lubricant used to ease the assembly of InnoFlue® SW & Flex. Sparingly applied to the gasket or male end.

Package Size	Part
50 ml	IACE50

Flex

# Flex

# Typical configurations

- 2 ISEL87: 87° Elbow
- 3 ISVL: Vent Length
- 4 IASCM: Support Clamp
- 5 IANS: Connector Ring
- 6 IAWP: Wall Plate
- 7 ISEP: End Pipe PPs-UV
- 8 ISTT: Termination Tee PPs-UV
- 9 IASPP: Bird Screen PPs-UV
- 12 ISAGL or ISAAL: Appliance Adaptor
- 24 ISBS: Base Support
- 25 IASP: Spacer
- 27 IFVL: Flexible Vent Length
- 28 ISCP: Chimney Cover PPs-UV
- 29 IFEP: Flex End Pipe
- 30 IFFSC: Flex to SW Coupler
- 36 IAUBV: Universal B-Vent Cap
- 37 IFPT: Custom Chimney Cover

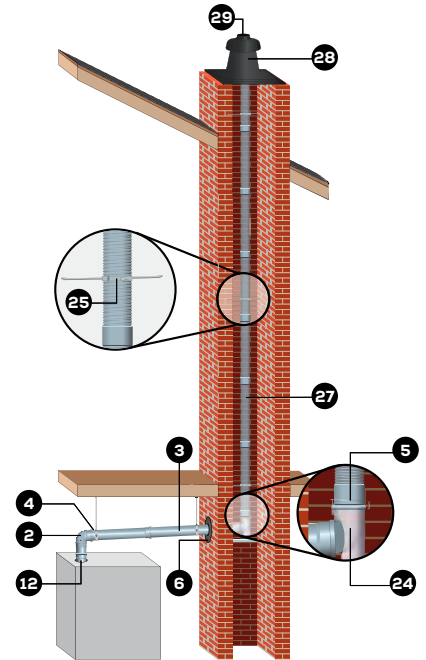
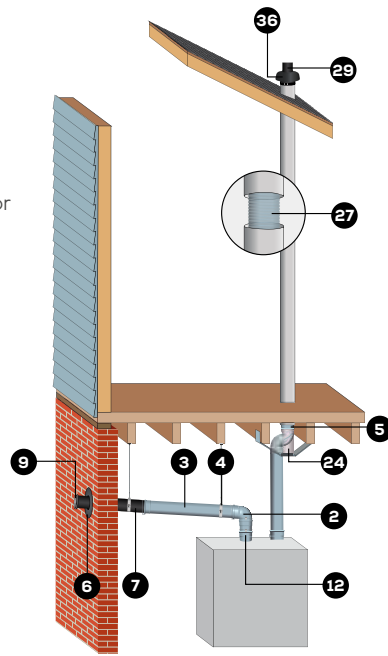

InnoFlue® SW and Flex installations, where InnoFlue® SW is used to pass flue gases to the base of a structurally intact metal chase, then InnoFlue® Flex to get them to the termination at the top. Combustion air is not supplied through the metal flue.

InnoFlue® SW and Flex installations, where InnoFlue® SW is used to pass flue gases to the base of the chimney, then InnoFlue® Flex to get them to the termination at the top.

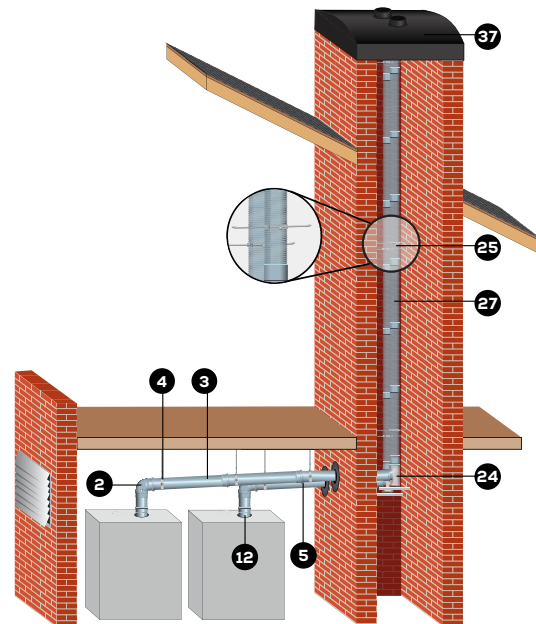
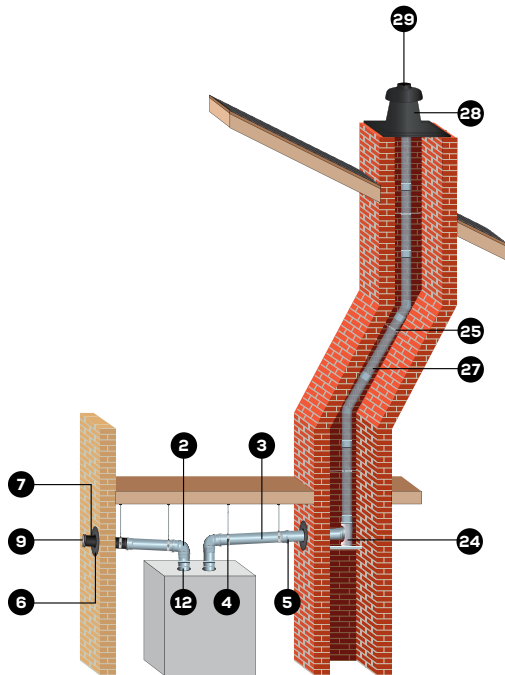

InnoFlue® SW and Flex installations, where InnoFlue® SW is used to pass flue gases to the base of the chimney, then InnoFlue® Flex to get them to the termination at the top. Combustion air is not supplied through the masonry chimney.

InnoFlue® SW and Flex installations, where InnoFlue® is used to pass flue gases of multiple appliances to the base of a structurally intact masonry chimney or metal flue, then InnoFlue® SW or Flex to get them to the Custom Chimney Cover at top.

Flex

## Flex Vent Lengths

Flex

		2" Flex			
		Is manufactured from polypropylene. 2" Flex can be field cut and is ideal for use in chimneys with offsets. With couplers, 2" Flex can be connected to 2" Flex or InnoFlue® SW.			
Nominal Diameter	Part	Overall Height A	Max O.D. B		
2" (60)	IFVL02025	25' (7.6m)	2.3 (58)		
2" (60)	IFVL02035	35' (10.7m)	2.3 (58)		
2" (60)	IFVL02050	50' (15.2m)	2.3 (58)		
2" (60)	IFVL02150	150' (45.7m)	2.3 (58)		

		3" and 4" Flex			
		Are manufactured from polypropylene and feature rigid sections every 2'. 3" and 4" Flex can be field cut and are ideal for use in chimneys with offsets. The base of your 3" and 4" Flex can be connected to InnoFlue® SW at any rigid section without coupler. Flex to Flex couplers available for extended flex runs.			
Nominal Diameter	Part	Overall Height A	Max O.D. B		
3" (80)	IFVL03025	25' (7.6m)	3.3 (84)		
3" (80)	IFVL03035	35' (10.7m)	3.3 (84)		
3" (80)	IFVL03040	40' (12.2m)	3.3 (84)		
3" (80)	IFVL03050	50' (15.2m)	3.3 (84)		
3" (80)	IFVL03150	150' (45.7m)	3.3 (84)		
4" (110)	IFVL04025	25' (7.6m)	4.3 (110)		
4" (110)	IFVL04035	35' (10.7m)	4.3 (110)		
4" (110)	IFVL04040	40' (12.2m)	4.3 (110)		
4" (110)	IFVL04050	50' (15.2m)	4.3 (110)		
4" (110)	IFVL04080	80' (24.4m)	4.3 (110)		

## Base Supports

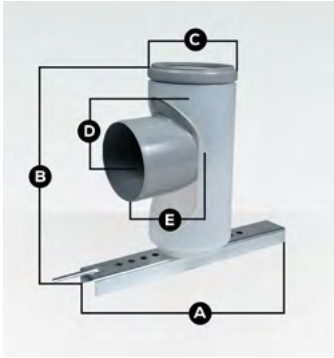

### Base Support

Supports vertical sections of rigid (up to 164') and flexible (up to 98' with Flex end pipe) vent lengths installed in chimneys and chases.

Nominal Diameter	Part	Base Length A	Height B	Max O.D. C	Effective D	Effective E
2" (60)	ISBS0287	15.8 (400)	9.4 (238)	3.0 (76)	2.7 (69)	4.6 (118)
3" (80)	ISBS0387	15.8 (400)	10.6 (269)	3.8 (97)	3.4 (86)	4.9 (125)
4" (110)	ISBS0487	15.8 (400)	11.5 (291)	5.1 (129)	2.6 (65)	4.5 (115)
5" (125)	ISBS0587	15.8 (400)	13.4 (341)	5.8 (146)	2.9 (74)	5.4 (136)

Flex

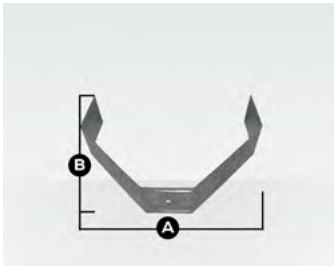

### Base Support Bracket

B-Vent Support Bracket (IABVSB) replaces metal channel on base support to support vertical sections of rigid and flexible vent lengths installed inside a B-Vent. Fastens to floor joists.

Part	Width A	Height B
IABVSB	17.5 (446)	11.8 (298)

## Couplers and Accessories

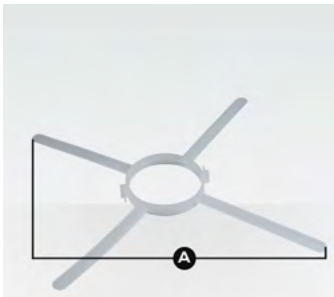

### 2", 3", 4" and 5" Spacers

Self positioning spacers center InnoFlue® SW or Flex in a chase/chimney/B-vent.

Nominal Diameter	Part	Max Width A	Min Width
2" (60)	IASP02	23.5 (596)	3.3 (85)
3" (80)	IASP03	22.8 (580)	4.2 (106)
4" (110)	IASP04	23.9 (606)	5.4 (138)



### SW to Flex Coupler

Transitions 2" InnoFlue® Single Wall Rigid to 2" InnoFlue® Flex.

Nominal Diameter	Part	Overall Length A	Effective Length B	Max O.D. C
2" (60)	IFSFC02	4.2 (107)	3.2 (81)	2.6 (65)



2" Flex to SW Coupler				
Transitions 2" InnoFlue® Flex to 2" InnoFlue® Single Wall Rigid.				
Nominal Diameter	Part	Overall Length A	Effective Length B	Max O.D. C
2" (60)	IFFSC02	3.9 (99)	1.1 (28)	3.0 (76)



3" and 4" Flex to SW Coupler				
Transitions InnoFlue® Flex to InnoFlue® Single Wall Rigid.				
Nominal Diameter	Part	Overall Length A	Effective Length B	Max O.D. C
3" (80)	IFFSC03	5.5 (138)	4.3 (60)	3.9 (100)
4" (110)	IFFSC04	6.5 (171)	2.64 (67)	5.1 (128)



2" Flex to Flex Coupler				
Connects 2" InnoFlue® Flex to 2" InnoFlue® Flex.				
Nominal Diameter	Part	Overall Length A	Effective Length B	Max O.D. C
2" (60)	IFFFC02	3.4 (87)	1.4 (35)	2.6 (65)



3" and 4" Flex to Flex Coupler				
Connects 3" and 4" InnoFlue® Flex to 3" and 4" InnoFlue® Flex.				
Nominal Diameter	Part	Overall Length A	Effective Length B	Max O.D. C
3" (80)	IFFFC03	5.5 (141)	4.3 (60)	3.9 (100)
4" (110)	IFFFC04	6.7 (166)	4.5 (114)	5.1 (128)

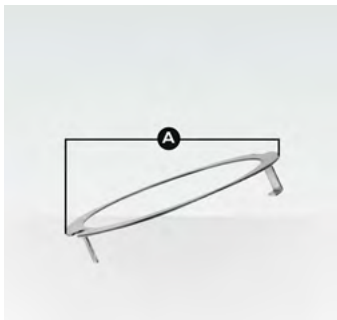

Connector Ring		
Provides reinforcement at joints to support loads of up to 99 lbs (45Kg).		
Nominal Diameter	Part	O.D. A
2" (60)	IANS02	3.2 (81)
3" (80)	IANS03	4.1 (103)
4" (110)	IANS04	5.3 (134)



## B-Vent Kits



### 2" B-Vent Kit

Includes all components necessary to line a B-Vent from base to termination. Rigid vent lengths, elbows and adaptors required to connect B-Vent base support to appliance are sold separately.

Nominal Diameter	Part	Flex Vent Length
2" (60)	IFBK0225	25' (7.6m)
2" (60)	IFBK0235	35' (10.6m)
2" (60)	IFBK0250	50' (15.25m)

Kit contains B-Vent Support Bracket, Base Support, Single Wall-To-Flex Coupler, 2" Flex, Flex End Pipe, Universal B-Vent Cap, Connector Ring, Spacers and Centrocerin®.



### 3" and 4" B-Vent Kit

Includes all components necessary to line a B-Vent from base to termination. Rigid vent lengths, elbows and adaptors required to connect B-Vent base support to appliance are sold separately.

Nominal Diameter	Part	Flex Vent Length	B-Vent Diameter
3" (80)	IFBK0325	25' (7.6m)	4", 5", 6"
3" (80)	IFBK0335	35' (10.6m)	4", 5", 6"
3" (80)	IFBK0350	50' (15.25m)	4", 5", 6"
4" (110)	IFBK0425	25' (7.6m)	5", 6"
4" (110)	IFBK0435	35' (10.6m)	5", 6"
4" (110)	IFBK0440	40' (12.1m)	5", 6"

Kit contains B-Vent Support Bracket, Base Support, Flex End Pipe, Universal B-Vent Cap, Connector Ring, Spacers and Centrocerin®.

## Flex Component B-Vent Kits



### 2" Flex Component B-Vent Kit

Includes all fittings and accessories required to line a B-Vent excluding 2" flex. 2" flex and rigid vent length, elbows, adaptors required to connect B-Vent Base Support to appliance, and termination are sold separately.

Nominal Diameter	Part	B-Vent Diameter
2" (60)	IFBKC02	4"

Kit includes B-Vent Support Bracket, Base Support, Single Wall-To-Flex Coupler, Flex End Pipe, Universal B-Vent Cap, Connector Ring, Spacers and Centrocerin®.



### 3" and 4" Flex Component B-Vent Kit

Includes all fittings and accessories required to line a B-Vent excluding 3" or 4" Flex. 3" or 4" flex and rigid vent length, elbows, adaptors required to connect B-Vent Base Support to appliance, and termination are sold separately.

Nominal Diameter	Part	B-Vent Diameter
3" (80)	IFBKC03	4"
4" (110)	IFBKC04	5"

Kit includes B-Vent Support Bracket, Base Support, Flex End Pipe, Universal B-Vent Cap, Connector Ring, Spacers and Centrocerin.

## Chimney Kits



### 2" Chimney Kit

Includes all components necessary to line a chimney from chimney termination to Base Support. Rigid vent lengths, elbows and adaptors required to connect chimney kit base support to appliance are sold separately. Custom flex lengths are available.

Nominal Diameter	Part	Flex Vent Length
2" (60)	IFCK0225	25' (7.6m)
2" (60)	IFCK0235	35' (10.7m)
2" (60)	IFCK0250	50' (15.2m)

Kit contains Base Support, Single Wall to Flex Coupler, Flex Vent Length, Flex End Pipe, Chimney Cover, Connector Rings, Spacers and Centrocerin.



### 3" and 4" Chimney Kit

Includes all components necessary to line a chimney from chimney termination to Base Support. Rigid vent lengths, elbows and adaptors required to connect chimney kit base support to appliance are sold separately. Custom flex lengths are available.

Nominal Diameter	Part	Flex Vent Length
3" (80)	IFCK0325	25' (7.6m)
3" (80)	IFCK0335	35' (10.7m)
3" (80)	IFCK0350	50' (15.2m)
4" (110)	IFCK0425	25' (7.6m)
4" (110)	IFCK0435	35' (10.7m)
4" (110)	IFCK0440	40' (12.2m)
4" (110)	IFCK0450	50' (15.2m)

Kit contains Base Support, Flex Vent Length, Flex End Pipe, Chimney Cover, Connector Rings, Spacers and Centrocerin.



**2" Flex Component Chimney Kit**

Includes all components necessary to line a chimney from chimney termination to Base Support excluding 2' flex, 2' flex and rigid vent lengths, elbows, adaptors required to connect Base Support to appliance, and termination are sold separately.

Nominal Diameter	Part
2" (60)	IFCKC02

Kit contains Base Support, Single Wall to Flex Coupler, Chimney Cover, Flex End Pipe, Connector Ring, Spacers and Centrocerin.



**3" and 4" Flex Component Chimney Kit**

Includes all components necessary to line a chimney from chimney termination to Base Support excluding 3' or 4' flex, 3' or 4' flex, and rigid vent lengths, elbows, adaptors required to connect Base Support to appliance, and termination are sold separately.

Nominal Diameter	Part
3" (80)	IFCKC03
4" (110)	IFCKC04

Kit contains Base Support, Chimney Cover, Flex End Pipe, Connector Rings, Spacers and Centrocerin.

## Terminations



**Chimney Cover PP-UV**

This termination incorporates a combustion air intake and flue gas termination in a single assembly. Cover seals top of the chimney or chase. Use with End Pipe or Flex End Pipe. End Pipes sold separately.

Nominal Diameter	Part	Length A	Height B
2" (60)	ISCP02	15.8 (400)	9.6 (245)
3" (80)	ISCP03	15.8 (400)	9.6 (245)
4" (110)	ISCP04	15.8 (400)	9.6 (245)

**Available**

**Custom Chimney Cover PP-UV**

Custom Chimney Cover sizes available, including multiple flue versions. Call with size requirements for pricing.



### 2" Flex End Pipe

Terminates InnoFlue® Flex at top of chimney. Used in combination with Chimney Cover PPs-UV or B-Vent Cap

Nominal Diameter	Part	Overall Length A	Effective Length B	Max O.D. C
2" (60)	IFEP02	5.3 (135)	4.1 (105)	3.9 (99)



### 3" and 4" Flex End Pipe

Terminates InnoFlue® Flex at top of chimney. Used in combination with Chimney Cover PPs-UV or B-Vent Cap

Nominal Diameter	Part	Overall Length A	Effective Length B	Max O.D. C
3" (80)	IFEP03	7.1 (180)	3.3 (84)	3.9 (100)
4" (110)	IFEP04	10.0 (253)	3.5 (89)	5.2 (132)



### Universal B-Vent Cap

Allows for multiple flue configurations. Utilize existing B-Vent as a chase. Clean, professional and aesthetically pleasing. Installs quickly and easily.

Part	Length	Height	Width
IAUBVC	10"	10"	10"



One Part Multiple Configurations

Concentric

# Concentric

## Typical configurations

- 4 IASCM: Support Clamp
- 6 IAWP: Wall Plate
- 15 ICRT: Concentric Roof Termination
- 31 ICTP: Concentric Test Port
- 32 ICEL45: Concentric 45° Elbow
- 33 ICVL: Concentric Vent Length
- 34 ICEL87: Concentric 87° Elbow
- 35 ICWT: Concentric Wall Termination PP

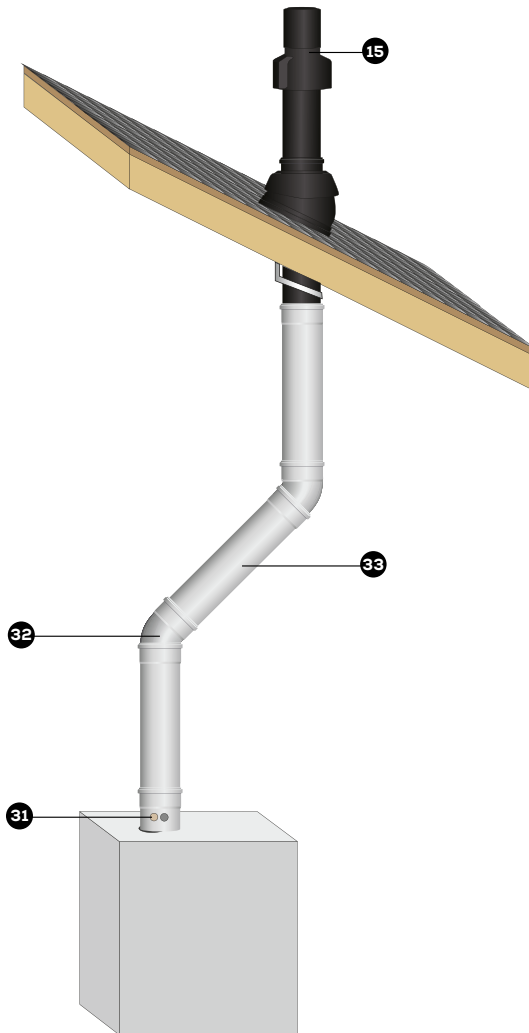

InnoFlue® Concentric installations where combustion air and air intake points are co-located above the roof line.

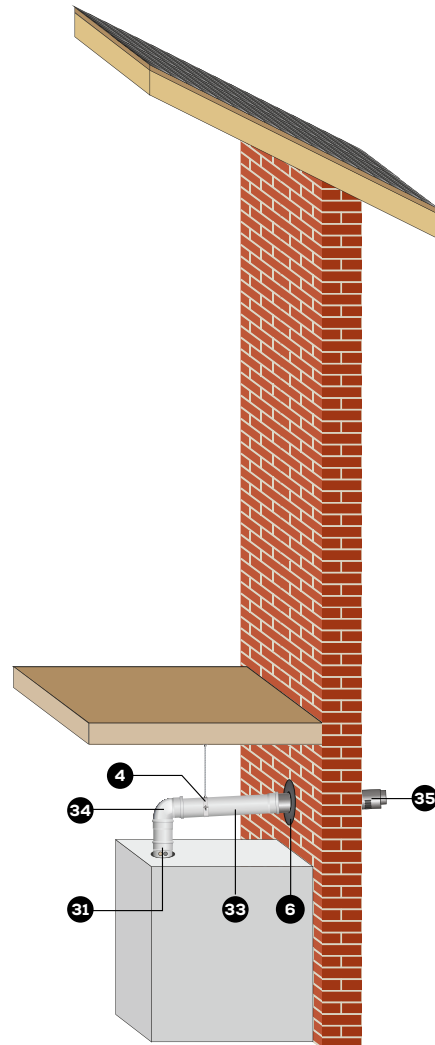

InnoFlue® Concentric installations where combustion air and air intake points are co-located.

# Concentric Adaptors



## Concentric Centric In increaser

Transitions from one diameter to a larger diameter. Install in vertical orientation only.

Nominal Diameter	Part	Overall Length A	Effective Length B	Max O.D. C
4"/6" (100/150mm)	ICIA10015046	6.0 (163)	4.1 (105)	6.8 (173)
4"/6" (110/150mm)	ICIA11015046	6.0 (163)	4.1 (105)	6.8 (173)

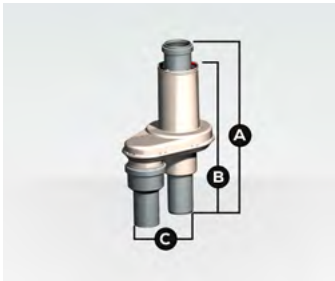

## Twin Pipe/Concentric Reversible Adaptor

Reversible adaptor transitions between InnoFlue® Single Wall and Concentric. Reducer and vent length included.

Nominal Diameter	Part	Overall Length A	Effective Length B	Offset C
2"/4" (60/100)	ICTCR24	16.4 (411)	12 (305)	4.76 (120)



## Reversible Concentric / Twin Pipe Adaptor

Transitions Concentric to twin pipe Single Wall.

Nominal Diameter	Part	Overall Length A	Effective Length B	Offset C
3"/5" (80/125)	ICCT3503	9.8 (250)	5.9 (150)	4.8 (121)

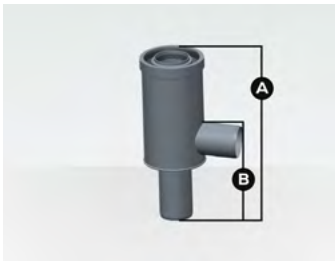

## Twin Pipe to Concentric Adaptor

Transitions twin pipe Single Wall to Concentric.

Nominal Diameter	Part	Overall Length A	Effective Length B
4"/6" (110/160)	ICTC0446	14.5 (316)	10.0 (25.3)

## Condensate Management

Concentric

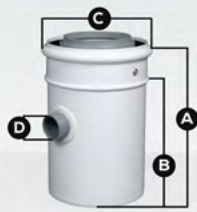

**Concentric Horizontal Drain Tee**

Use to drain condensate from the vent system. Install in horizontal section closest to appliance.

Nominal Diameter	Part	Overall Length A	Effective Length B	Max O.D. C	Drain O.D. D
2"/4" (60/100)	ICHDT24	7.9 (200)	5.9 (150)	4.4 (112)	1.4 (32)
3"/5" (80/125)	ICHDT35	7.9 (200)	5.9 (150)	5.5 (139)	1.4 (32)
4"/6" (110/160)	ICHDT46	7.9 (200)	5.9 (150)	6.8 (173)	1.4 (32)



**Universal Ball Valve Siphon**

Attaches to any InnoFlue® drain. Allows condensates to flow while unique ball valve assures combustion gases remain contained at higher temperatures. Comes with and can be installed with a barbed or compression fitting. See configuration options below.

Part	Overall Height A	Width B	Length C
IASJBVS	6.5	4.5	1.9



**Standard**



**Barbed**



**NRV**

## Concentric Test Ports



**Concentric Test Port**

Installed immediately above the appliance, the test port allows plumbing and heating professionals to sample flue gases and ensure the appliance is operating at optimum efficiency.

Nominal Diameter	Part	Overall Length A	Effective Length B	Max O.D. C
2"/4" (60/100)	ICTP24	6.7 (170)	4.3 (110)	4.4 (112)
3"/5" (80/125)	ICTP35	6.7 (170)	4.3 (110)	5.5 (139)
4"/6" (110/160)	ICTP46	8.1 (207)	5.6 (143)	6.8 (173)



# Concentric Vent Lengths

Concentric

Concentric Vent Lengths				
Rigid polypropylene vent lengths with metal outer and dedicated male and female ends. Female end contains internal gasket and male ends can be field cut and chamfered to desired length.				
Nominal Diameter	Part	Overall Length A	Effective Length B	Max O.D. C
2"/4" (60/100)	ICVL241	14.5 (368)	12 (305)	4.4 (112)
2"/4" (60/100)	ICVL242	26.5 (673)	24 (610)	4.4 (112)
2"/4" (60/100)	ICVL243	38.5 (978)	36 (914)	4.4 (112)
3"/5" (80/125)	ICVL351	14.5 (368)	12 (305)	5.5 (139)
3"/5" (80/125)	ICVL352	26.5 (673)	24 (610)	5.5 (139)
3"/5" (80/125)	ICVL353	38.5 (978)	36 (914)	5.5 (139)
4"/6" (110/160)	ICVL461	14.5 (368)	12 (305)	6.8 (173)
4"/6" (110/160)	ICVL462	26.5 (673)	24 (610)	6.8 (173)
4"/6" (110/160)	ICVL463	38.5 (978)	36 (914)	6.8 (173)

# Elbows

Concentric 45° Elbow				
For offsets or changes in the direction of the vent system.				
Nominal Diameter	Part	Centerline Offset A	Effective Length B	Max O.D. C
2"/4" (60/100)	ICEL2445	.7 (18)	3.3 (85)	4.4 (112)
3"/5" (80/125)	ICEL3545	1.3 (34)	4.6 (117)	5.5 (139)
4"/6" (110/160)	ICEL4645	1.5 (39)	5.2 (133)	6.8 (173)

Concentric 87° Elbow				
For offsets or changes in the direction of the vent system.				
Nominal Diameter	Part	Centerline Offset A	Effective Length B	Max O.D. C
2"/4" (60/100)	ICEL2487	2.0 (50)	4.8 (123)	4.4 (112)
3"/5" (80/125)	ICEL3587	3.1 (79)	5.1 (129)	5.5 (139)
4"/6" (110/160)	ICEL4687	4.4 (111)	6.5 (165)	6.8 (173)

## Roof Flashing

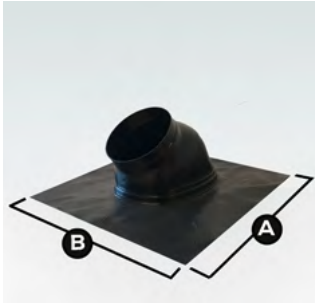

### Concentric Roof Flashing

Concentric PPs roof flashing creates water-tight roof penetration when using InnoFlue® Concentric.

Nominal Diameter	Part	Overall Length A	Overall Length B
2"/4" (60/100) / 3"/5" (80/125)	ICRF2435	22.00	19.5
4"/6" (110/160)	ICRF46	22.00	19.5

## Terminations

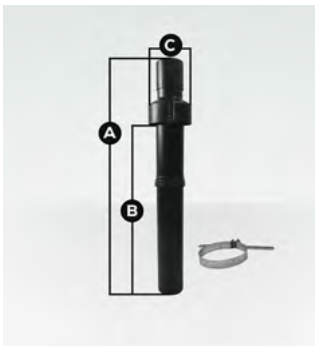

### Concentric Roof Termination

Roof Termination combines flue gas termination and combustion air intake. Use with InnoFlue® Concentric or with InnoFlue® SW by adding an ICTC Adapter. Includes support clamp.

Nominal Diameter	Part	Overall Length A	Roof Line B	Max O.D. C
2"/4" (60/100)	ICRT2439	39.4 (1000)	20.5 (520)	6.5 (166)
3"/5" (80/125)	ICRT3539	39.4 (1000)	20.5 (520)	6.5 (166)
4"/6" (110/160)	ICRT4679	78.7 (2000)	23.6 (600)	6.5 (166)



### Concentric Wall Termination

Made from PPs-UV outer and PPs-UV inner, the Concentric Wall termination incorporates flue gas termination and combustion air intake. Use with InnoFlue® Concentric or with InnoFlue® SW by adding an ICTC Adapter. Includes support clamp and wall plates.

Nominal Diameter	Part	Overall Length A	O.D. B
2"/4" (60/100)	ICWT242	21.2 (538)	5.54 (141)
3"/5" (80/125)	ICWT352	28.3 (719)	5 (125)

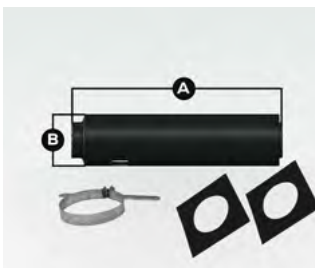

### Concentric Wall Termination

Made from PPs-UV outer and PPs-UV inner, the Concentric Wall termination incorporates flue gas termination and combustion air intake. Use with InnoFlue® Concentric or with InnoFlue® SW by adding an ICTC Adapter. Includes support clamp and wall plates.

Nominal Diameter	Part	Overall Length A	O.D. B
4"/6" (110/160)	ICWT462	32.0 (813)	6.3 (160)

## Concentric Kits



### Concentric Kit Horizontal

Concentric Side Wall Venting Kit contains components needed to vent wall mounted appliance to wall termination. Additional components may be required for longer runs and are sold separately.

Nominal Diameter	Part
2"/4" (60/100)	ICVKH24
3"/5" (80/125)	ICVKH35
4"/6" (110/160)	ICVKH46

Kit includes one 3' Concentric Vent Length, Concentric Elbow, Concentric Wall Termination, Wall Plates and Support Clamp.



### Concentric Kit Vertical

Concentric Vertical Venting Kit contains components needed to vent vertically through roof. Additional components may be required for longer runs and are sold separately.

Nominal Diameter	Part
2"/4" (60/100)	ICVKV24
3"/5" (80/125)	ICVKV35
4"/6" (110/160)	ICVKV46

Kit includes one 2' and one 3' Concentric Vent Length, Concentric Roof Termination, one Wall Plate and Support Clamp.

## Accessories



### Wall Plate

Provides an aesthetically pleasing and water tight finish at wall penetrations when sealed with field-supplied silicone.

Nominal Diameter	Part	Overall Diameter A	Width of Opening B
4" (100)	IAWP100B	5.6 (142)	4" (100)
5" (125)	IAWP05B	8.9 (226)	5" (125)

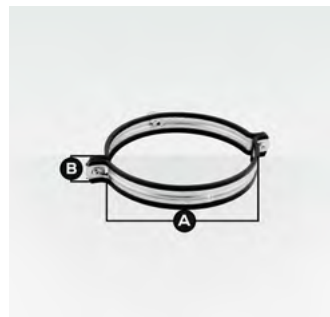

### Support Clamp

Used as vertical or horizontal support. Space 78" in vertical and 39" in horizontal installations. Uses 3/8" threaded rod.

Nominal Diameter	Part#	Overall Length A	Height B
4" (100)	IASCM100	5.3 (134.6)	1.1 (28)
5" (125)	IASCM05	5.8 (147.3)	1.1 (28)
6" (160)	IASCM06	6.8 (172.7)	1.1 (28)

Commercial SW

# Commercial SW

## Typical configurations

- 2 ISEL87: 87° Elbow
- 3 ISVL: Vent Length
- 4 IASCM: Support Clamp
- 5 IANS: Connector Ring\*
- 6 IAWP: Wall Plate
- 7 ISEP: End Pipe PPs-UV
- 9 IASPP: Bird Screen PPs-UV
- 12 ISAGL or ISAAL: Appliance Adaptor
- 19 ISTP: Test Port
- 20 ISHDF: Horizontal Drain Fitting
- 21 IALJS: Siphon
- 22 ISBT: Branch Tee
- 23 ISELO430: 30° Elbow
- 24 ISBS: Base Support
- 25 IASP: Spacer
- 26 ISCM: Chimney Cover SS w/PPs-UV End Pipe

\*where required

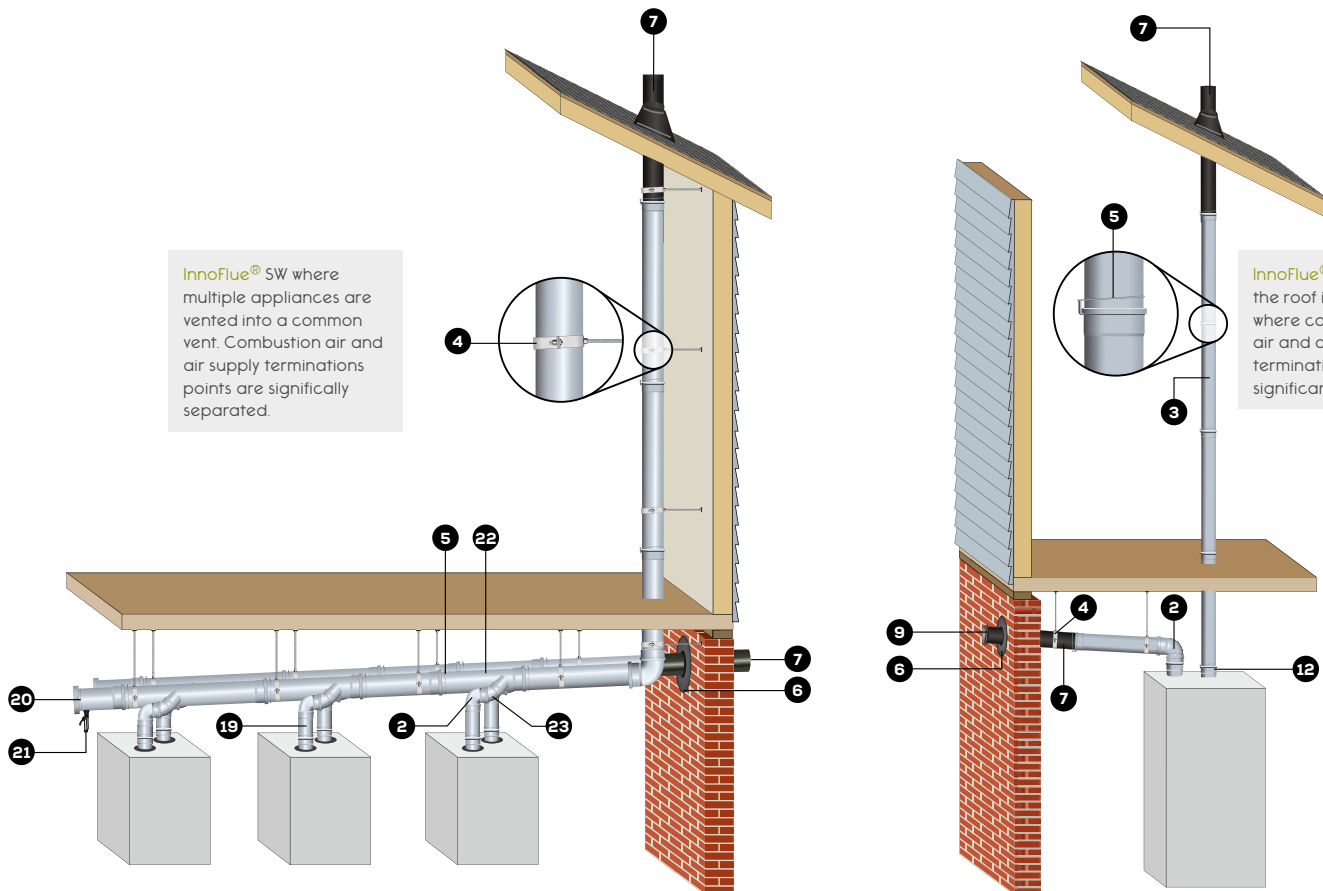
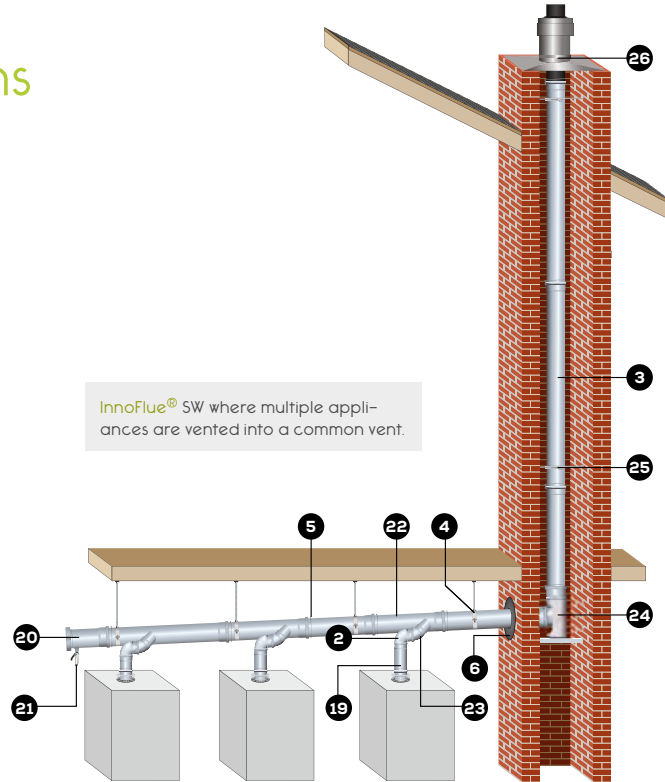

# Appliance Adaptors

Commercial appliance adaptors are made to order. Adaptors can be manufactured to fit any appliance. Call Centrotherm or visit [www.centrotherm.us.com](http://www.centrotherm.us.com) for a complete list of approved appliances.

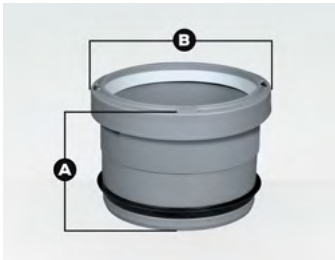

## Commercial Appliance Adaptor for Coupler Style Flue Collar

Adapts a female PVC / CPVC coupler or appliance flue exhaust to InnoFlue® SW diameters.

Nominal Diameter PVC to PP	Part	Overall Length <b>A</b>	Max O.D. <b>B</b>
6"/6" (168/160)	ISAGL0606	7.6 (194)	7.0 (178)

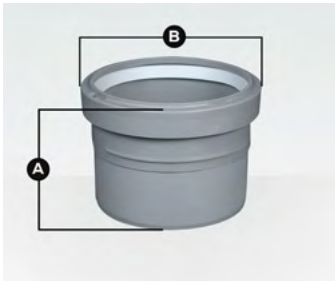

## Commercial Appliance Adaptor for Flue Collar with Hose Clamp

Adapts a female PVC / CPVC diameter appliance flue exhaust (with integrated gasket) to InnoFlue® SW diameters.

Nominal Diameter PVC to PP	Part	Overall Length <b>A</b>	Max O.D. <b>B</b>
6"/6" (168/160)	ISAAL0606	7.6 (194)	7.0 (178)



## Commercial Appliance Adaptor w/ Condensate Drain and Vibration Isolation Boot OEM to InnoFlue®

Adapts boilers to InnoFlue® Other increasing size combinations available upon request.

Nominal Diameter	Part	Overall Length <b>A</b>	Maximum OD <b>B</b>	Effective Length <b>C</b>
4" (110)	ISAACD0404	10.3 (262)	5.9 (150)	3.4 (86)
5" (125)	ISAACD0505	13.6 (345)	6.5 (165)	8.5 (216)
6" (160)	ISAACD0606	12.0 (305)	7.9 (201)	5.4 (137)
7" (180) to 8" (200)	ISAACD0708	16.5 (419)	9.5 (241)	9.7 (246)
8" (200)	ISAACD0808	16.5 (419)	9.5 (241)	9.7 (246)
9" (230) to 10" (250)	ISAACD0910	16.9 (429)	11.4 (290)	10.0 (254)
10" (250)	ISAACD1010	16.9 (429)	11.4 (290)	10.0 (254)
12" (315)	ISAACD1212	23.3 (542)	14.7 (373)	7.6 (191)

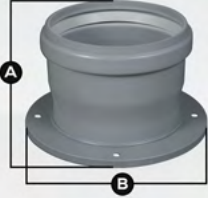

**Commercial Flanged Appliance Adaptor OEM to InnoFlue®**

Adapts InnoFlue® with bolt down flanged adaptor.  
Available for purchase through Centrotherm.

Nominal Diameter	Part	Overall Length A	Maximum OD B
3" (80)	ISAFLG03	3.7 (94)	8.8 (224)
4" (110)	ISAFLG04	4.7 (119)	8.8 (224)
6" (160)	ISAFLG06	4.3 (109)	8.8 (224)
8" (200)	ISAFLG08	6.2 (158)	11.3 (287)
10" (250)	ISAFLG10	6.2 (157)	15.0 (381)
12" (315)	ISAFLG12	13.2 (335)	15.0 (381)

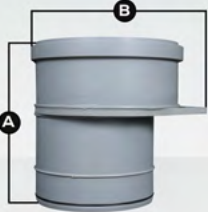

**Commercial Appliance Adaptor OEM to InnoFlue®**

Adapts boilers to InnoFlue®.

Nominal Diameter	Part	Overall Length A	Max O.D. B
7" (180) to 8" (200)	ISAF0708	9.0 (229)	8.8 (224)
8" (200)	ISAF0808	8.0 (204)	8.8 (224)
10" (250)	ISAF1010	8.0 (204)	10.8 (27)

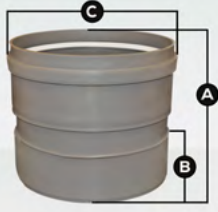

**Commercial Appliance Adaptor SS to InnoFlue®**

Adapts stainless steel flue outlets to InnoFlue®. May require Vibration Isolation Boot.

Nominal Diameter SS to PP	Part	Overall Length A	Effective Length B	Max O.D. C
6"/6" (152/160)	ISSA0606	7.3 (185)	4.2 (107)	7.8 (183)
7" (180) to 8" (200)	ISSA0708	8.7 (221)	6.1 (155)	8.8 (224)
8"/8" 203/200	ISSA0808	8.9 (226)	5.0 (127)	8.8 (224)
10"/10" (254/250)	ISSA1010	8.9 (226)	5.0 (127)	10.7 (272)
12"/12" (305/315)	ISSA1212	16.9 (429)	4.2 (107)	13.8 (350)



**Vibration Isolation Boot with Clamps**

High temperature silicone boot seals InnoFlue® SW Vent Lengths and Fittings to appliance flue outlet.

Nominal Diameter PVC to PP	Part	Width	ID
6" (160)	ISVIB06	2.4 (60)	6.3 (160)
8" (200)	ISVIB08	2.4 (60)	7.9 (200)
10" (250)	ISVIB10	2.4 (60)	9.8 (250)
12" (315)	ISVIB12	2.4 (60)	12.4 (315)

Available	Custom Appliance Adaptors
	Appliance Adaptors are built to order. Contact your sales representative for pricing and availability. <a href="http://www.centrotherm.us.com">www.centrotherm.us.com</a>

## Increasers & Reducers



Centric Increaser				
Transitions vent system to a larger diameter. Install in vertical orientation only. Additional configurations available upon request.				
Nominal Diameter	Part	Overall Length A	Effective Length B	Max O.D. C
4"/6" (110/160)	ISIA0406	7.6 (193)	4.8 (122)	7.2 (183)
5"/6" (125/160)	ISIA0506	7.2 (185)	4.3 (110)	7.2 (185)
6"/6" (150/160)	ISIA15006	7.7 (196)	4.9 (124)	7.2 (183)
6"/8" (160/200)	ISIA0608	10.4 (265)	6.5 (165)	8.8 (224)
6"/12" (160/315)	ISIA0612	18.1 (460)	5.4 (137)	13.8 (351)
8"/10" (200/250)	ISIA0810	11.6 (295)	7.7 (195)	10.7 (272)
10"/12" (250/315)	ISIA1012	18.2 (463)	5.5 (141)	13.8 (350)
300mm/12" (300/315)	ISIA30012			

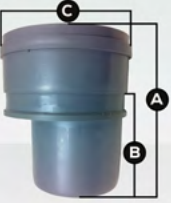

Eccentric Increaser				
Transitions vent system to a larger diameter. Install in horizontal or vertical orientation. Other size combinations available upon request.				
Nominal Diameter	Part	Overall Length A	Effective Length B	Max O.D. C
4"/6" (110/160)	ISEI0406	9.2 (234)	6.4 (163)	7.2 (183)
5"/6" (125/160)	ISEI0506	7.2 (185)	4.3 (108)	7.2 (183)
6"/8" (160/200)	ISEI0608	10.4 (265)	6.5 (165)	8.8 (224)
6"/12" (160/315)	ISEI0612	18.1 (460)	5.4 (137)	13.8 (350)
8"/10" (200/250)	ISEI0810	11.8 (300)	7.8 (200)	10.7 (272)
8"/12" (200/315)	ISEI0812	16.9 (429)	4.2 (107)	13.8 (350)
10"/12" (250/315)	ISEI1012	20.2 (514)	7.8 (200)	13.8 (350)



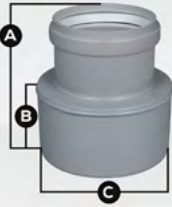

Reducer				
Transitions vent system to a smaller diameter.				
Nominal Diameter	Part	Overall Length A	Effective Length B	Max O.D. C
8"/6" (200/160)	ISRD0806	8.0 (204)	5.2 (133)	7.9 (201)
10"/8" (250/200)	ISRD1008	9.2 (234)	5.2 (133)	9.9 (252)
12"/10" (315/250)	ISRD1210	17.9 (455)	14.0 (356)	12.5 (318)

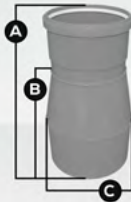

Tapered Reducer				
Transitions vent system to a smaller diameter with minimal back pressure. Other sizes available. Please contact Centrotherm.				
Nominal Diameter	Part	Overall Length A	Effective Length B	Max O.D. C
8"/6" (200/160)	ISTR0806	13.5 (343)	10.7 (272)	7.9 (200)
10"/6" (250/160)	ISTR1006	18.5 (409)	16.3 (414)	9.9 (250)
10"/8" (250/200)	ISTR1008	16.6 (422)	12.6 (320)	9.9 (250)

## Test Port

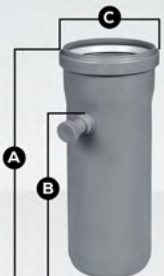

Test Port				
Installed immediately above the appliance, the test port allows plumbing and heating professionals to sample flue gases and ensure the appliance is operating at optimum efficiency.				
Nominal Diameter	Part	Overall Length A	Effective Length B	Max O.D. C
6" (160)	ISTP06	12.7 (323)	9.8 (250)	7.2 (183)
8" (200)	ISTP08	15.9 (405)	12.0 (305)	8.8 (224)
10" (250)	ISTP10	15.9 (405)	12.0 (305)	10.7 (272)
12" (315)	ISTP12	36.7 (932)	24 (610)	13.8 (350)

## Vent Lengths

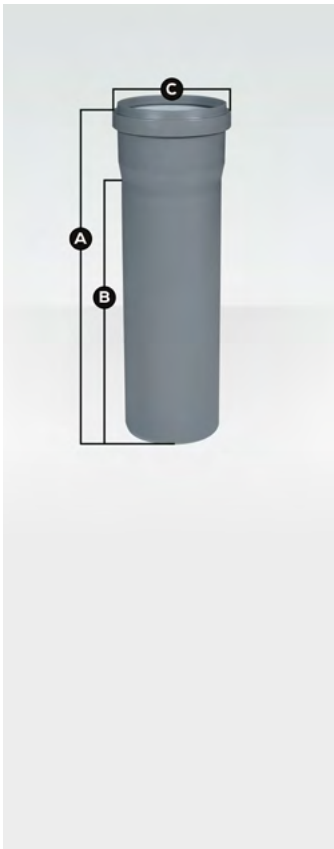

### Rigid Vent Length

Rigid polypropylene vent lengths with dedicated male and female ends. Female ends contain internal gasket and male ends can be field cut and chamfered to desired length.

Nominal Diameter	Part	Overall Length A	Effective Length B	Max O.D. C
6" (160)	ISVL061	15.5 (345)	12 (305)	7.2 (183)
6" (160)	ISVL062	27.5 (700)	24 (610)	7.2 (183)
6" (160)	ISVL063	39.5 (1004)	36 (914)	7.2 (183)
6" (160)	ISVL066	75.5 (1919)	72 (1829)	7.2 (183)
6" (160)	ISVL0610	124.25 (3162)	120 (3048)	7.2 (183)
8" (200)	ISVL081	16.2 (412)	12 (305)	8.8 (224)
8" (200)	ISVL082	28.2 (716)	24 (610)	8.8 (224)
8" (200)	ISVL083	40.2 (1021)	36 (914)	8.8 (224)
8" (200)	ISVL086	76.2 (1935)	72 (1829)	8.8 (224)
8" (200)	ISVL0810	124.5 (3162)	120 (3048)	8.8 (224)
10" (250)	ISVL101	16.1 (410)	12 (305)	10.7 (272)
10" (250)	ISVL102	28.1 (715)	24 (610)	10.7 (272)
10" (250)	ISVL103	40.1 (1019)	36 (914)	10.7 (272)
10" (250)	ISVL106	76.1 (1934)	72 (1829)	10.7 (272)
12" (315)	ISVL122	36.7 (932)	24 (610)	13.8 (350)
12" (315)	ISVL123	48.7 (1236)	36 (914)	13.8 (350)
12" (315)	ISVL126	84.7 (2151)	72 (1829)	13.8 (350)

## Elbows and Tees



### 15° Elbow

For offsets or changes the direction of the vent system.

Nominal Diameter	Part	Centerline Offset A	Effective Length B	Max O.D. C
6" (160)	ISEL0615	1.0 (25)	5.1 (130)	7.2 (183)
10" (250)	ISEL1015	1.9 (48)	10.6 (269)	10.7 (272)
12" (315)	ISEL1215	4.4 (112)	18.7 (475)	13.8 (350)

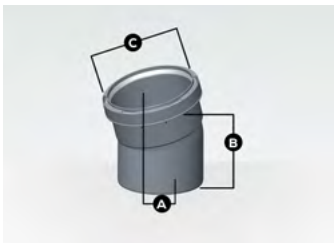

### 8" Zero Radius 15° Elbow

For offsets or changes in the direction of the vent system.

Nominal Diameter	Part	Centerline Offset A	Effective Length B	Max O.D. C	Zeta Value
8" (160)	ISELS0815	1.18 (30)	5.55 (232)	9.1 (232)	.10



**30° Elbow**

For offsets or changes in the direction of the vent system.

Nominal Diameter	Part	Centerline Offset <b>A</b>	Effective Length <b>B</b>	Max O.D. <b>C</b>
6" (160)	ISEL0630	2.1 (53)	5.8 (147)	7.2 (183)
10" (250)	ISEL1030	4.3 (109)	12.6 (320)	10.7 (272)
12" (315)	ISEL1230	9.3 (21.4)	21.4 (544)	13.8 (350)



**8° Zero Radius 30° Elbow**

For offsets or changes in the direction of the vent system.

Nominal Diameter	Part	Centerline Offset <b>A</b>	Effective Length <b>B</b>	Max O.D. <b>C</b>	Zeta Value
8" (160)	ISELS0830	2.6 (67)	6.46 (164)	9.1 (232)	.20

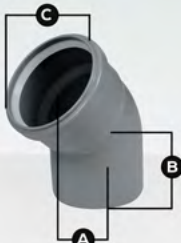

**45° Elbow**

For offsets or changes in the direction of the vent system.

Nominal Diameter	Part	Centerline Offset <b>A</b>	Effective Length <b>B</b>	Max O.D. <b>C</b>
6" (160)	ISEL0645	3.2 (81)	5.5 (138)	7.2 (183)
10" (250)	ISEL1045	4.1 (105)	14.3 (364)	10.7 (272)
12" (315)	ISEL1245	5.5 (139)	23.6 (599)	13.8 (350)



**8° Zero Radius 45° Elbow**

For offsets or changes in the direction of the vent system.

Nominal Diameter	Part	Centerline Offset <b>A</b>	Effective Length <b>B</b>	Max O.D. <b>C</b>	Zeta Value
8" (200)	ISELS0845	4.3 (115)	7.22 (183)	9.1 (232)	.40

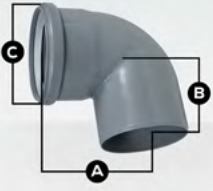

**87° Elbow**

For offsets or changes in the direction of the vent system.

Nominal Diameter	Part	Centerline Offset <b>A</b>	Effective Length <b>B</b>	Max O.D. <b>C</b>
6" (160)	ISEL0687	3.4 (86)	6.3 (160)	7.2 (183)
10" (250)	ISEL1087	11.3 (287)	15.7 (399)	10.7 (272)
12" (315)	ISEL1287	14.3 (364)	25.7 (653)	13.8 (350)

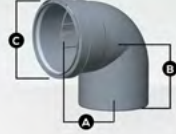

### 8° Zero Radius 87° Elbow

For offsets or changes in the direction of the vent system.

Nominal Diameter	Part	Centerline Offset A	Effective Length B	Max O.D. C	Zeta Value
8" (200)	ISELS0887	12.4 (316)	8.3 (212)	9.1 (232)	.96



### Tee Cap

Seals non-utilized tees and branch tees.

Nominal Diameter	Part	Max O.D. A
6" (160)	ISTC06	7.3 (185)
8" (200)	ISTC08	8.8 (224)
10" (250)	ISTC10	10.7 (272)
12" (315)	ISTC12	13.8 (350)

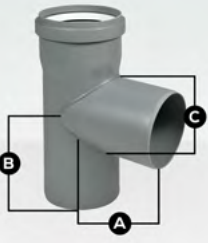

### Tee

Use to change the direction of the vent system, combine multiple appliances, and capture condensates at base of long vertical runs.

Nominal Diameter	Part	Effective Length A	Effective Length B	Effective Length C
6" (160)	IST06	6.6 (168)	11.2 (284)	4.1 (105)
8" (200)	IST08	8.5 (215)	15.2 (387)	6.5 (165)
10" (250)	IST10	16.5 (419)	16.5 (420)	7.0 (179)
12" (315)	IST12	19.7 (500)	28.7 (728)	7.5 (189.5)

## Base Supports

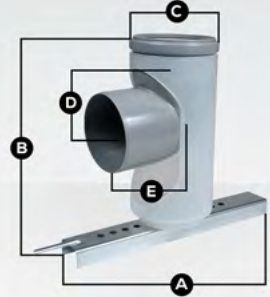

### Base Support

Supports vertical sections of rigid (up to 164') vent lengths installed in chimneys and chases.

Nominal Diameter	Part	Base Length A	Height B	Max O.D. C	Effective D	Effective E
6" (160)	ISBS0687	15.8 (400)	13.2 (335)	7.2 (183)	3.7 (93)	6.1 (156)
8" (200)	ISBS0887	15.8 (400)	22.7 (577)	8.8 (224)	10.2 (260)	13.5 (342)
10" (250)	ISBS1087	27.6 (700)	29.5 (750)	10.7 (272)	12.1 (307)	15.1 (383)
12" (315)	ISBS1287	27.6 (700)	46.9 (1191)	13.8 (350)	15.7 (398)	24.9 (633)

# Common Venting and Condensate Management

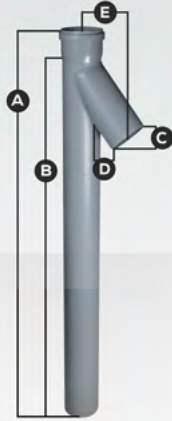

## Branch Tees

42° Y allows for the cascading or common venting of appliances.  
Other size configuration available upon request.

Nominal Diameter	Part	Overall Length A	Effective Length B	Feeder Diameter C	Feeder Length D	Offset E
3" (80)	ISBT030236	40.4 (1026)	36 (914)	2" (60)	6 (152)	6.5 (165)
4" (110)	ISBT040236	38.8 (986)	36 (914)	2" (60)	6 (152)	7.3 (185)
4" (110)	ISBT040336	38.8 (986)	36 (914)	3" (80)	6 (152)	7.5 (191)
5" (125)	ISBT050236	39.1 (993)	36 (914)	2" (60)	6 (152)	7.6 (193)
5" (125)	ISBT050336	39.1 (993)	36 (914)	3" (80)	6 (152)	7.9 (201)
5" (125)	ISBT050436	39.1 (993)	36 (914)	4" (110)	6 (152)	8.3 (211)
6" (160)	ISBT060236	40 (1016)	36 (914)	2" (60)	6 (152)	8.3 (211)
6" (160)	ISBT060336	40 (1016)	36 (914)	3" (80)	6 (152)	8.6 (218)
6" (160)	ISBT060436	40 (1016)	36 (914)	4" (110)	6 (152)	9 (229)
6" (160)	ISBT060536	40 (1016)	36 (914)	5" (125)	6 (152)	9.2 (234)
8" (200)	ISBT080236	40 (1016)	36 (914)	2" (60)	6 (152)	9.1 (231)
8" (200)	ISBT080336	40 (1016)	36 (914)	3" (80)	6 (152)	9.4 (239)
8" (200)	ISBT080436	40 (1016)	36 (914)	4" (110)	6 (152)	9.8 (249)
8" (200)	ISBT080536	40 (1016)	36 (914)	5" (125)	6 (152)	10 (254)
8" (200)	ISBT080636	40 (1016)	36 (914)	6" (160)	6 (152)	10.6 (269)
10" (250)	ISBT100236	39.9 (1013)	36 (914)	2" (60)	6 (152)	10.1 (257)
10" (250)	ISBT100336	39.9 (1013)	36 (914)	3" (80)	6 (152)	10.3 (262)
10" (250)	ISBT100436	39.9 (1013)	36 (914)	4" (110)	6 (152)	10.8 (274)
10" (250)	ISBT100536	39.9 (1013)	36 (914)	5" (125)	6 (152)	11 (279)
10" (250)	ISBT100636	39.9 (1013)	36 (914)	6" (160)	6 (152)	11.7 (297)
10" (250)	ISBT100836	39.9 (1013)	36 (914)	8" (200)	6 (152)	12.1 (307)
12" (315)	ISBT120236	49 (1245)	36 (914)	2" (60)	6 (152)	11.1 (282)
12" (315)	ISBT120336	49 (1245)	36 (914)	3" (80)	6 (152)	11.3 (287)
12" (315)	ISBT120436	49 (1245)	36 (914)	4" (110)	6 (152)	11.7 (297)
12" (315)	ISBT120536	49 (1245)	36 (914)	5" (125)	6 (152)	11.8 (300)
12" (315)	ISBT120636	49 (1245)	36 (914)	6" (160)	6 (152)	12.2 (310)
12" (315)	ISBT120836	49 (1245)	36 (914)	8" (200)	6 (152)	12.6 (320)
12" (315)	ISBT121036	49 (1245)	36 (914)	10" (250)	6 (152)	13.1 (333)

Available

## Custom Branch Tees

Branch Tees can be made to order using a variety of diameter manifolds and feeders.

## Available

### Cascade Component Kits

Available in various sizes and configurations.  
Contact your sales representative for more information.

### Common Vent Kit Example:

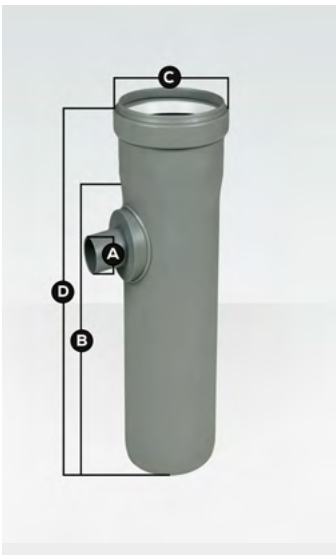

### Horizontal Drain Tee

Use to drain condensate from the vent system. Install in horizontal section closest to appliance.  
1.26" (32mm) O.D. drain. Use with any InnoFlue® Siphon.

Nominal Diameter	Part	Drain O.D. A	Effective Length B	Max O.D. C	Overall Length D
2" (60)	ISHDT02	1.3 (32)	7.3 (186)	3 (76)	9.8 (250)
3" (80)	ISHDT03	1.3 (32)	7.3 (186)	3.7 (94)	9.8 (250)
4" (110)	ISHDT04	1.3 (32)	9.8 (250)	4.1 (129)	12.4 (315)
5" (125)	ISHDT05	1.3 (32)	9.8 (250)	5.8 (146)	12.4 (315)
6" (160)	ISHDT06	1.3 (32)	9.8 (250)	7.2 (183)	12.4 (315)
8" (200)	ISHDT08	1.3 (32)	12.0 (305)	8.8 (224)	16.0 (405)
10" (250)	ISHDT10	1.3 (32)	12.0 (305)	10.7 (272)	16.0 (405)
12" (315)	ISHDT12	1.3 (32)	24.0 (1610)	13.8 (350)	36.7 (1932)

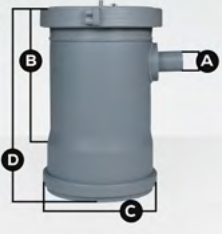

### Horizontal Drain Fitting

Use with any InnoFlue® siphon. Placed at the end of the last Branch Tee in a cascade configuration, the Horizontal Drain Fitting removes condensate from the system and allows for inspections and system clean out. 32mm O.D. drain.

Nominal Diameter	Part	Drain O.D. <b>A</b>	Effective Length <b>B</b>	Max O.D. <b>C</b>	Overall Length <b>D</b>
4" (110)	ISHDF04	1.3 (32)	7.2 (182)	5.1 (129)	9.7
5" (125)	ISHDF05	1.3 (32)	7.4 (187)	5.8 (146)	11.3
6" (160)	ISHDF06	1.3 (32)	8.1 (209)	7.2 (183)	12.1
8" (200)	ISHDF08	1.3 (32)	8.5 (215)	8.8 (224)	12.7
10" (250)	ISHDF10	1.3 (32)	13.8 (350)	10.7 (272)	18.0
12" (315)	ISHDF12	1.3 (32)	6.3 (160)	13.8 (350)	19.0

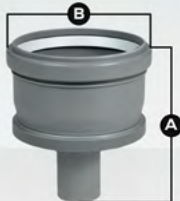

### Tee Cap with Drain

Use with any InnoFlue® siphon to drain condensate from the vent system.

Nominal Diameter	Part	Overall Length <b>A</b>	Max O.D. <b>B</b>
6" (160)	ISTCD06	6.9 (175)	7.2 (185)
8" (200)	ISTCD08	8.9 (225)	8.8 (224)
10" (250)	ISTCD10	8.9 (225)	10.7 (273)
12" (315)	ISTCD12	16.0 (407)	13.8 (351)

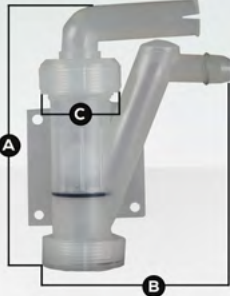

### Universal Ball Valve Siphon

Attaches to any InnoFlue® drain. Allows condensates to flow while unique ball valve assures combustion gases remain contained at higher temperatures. Comes with and can be installed with a barbed or compression fitting. See configuration options below.

Part	Overall Height <b>A</b>	Overall Length <b>B</b>	Overall Width <b>C</b>
IASJBVS	6.5	4.5	1.9



**Standard**



**Barbed**



**NRV**

# Terminations

**NOTE: Roof Flashings Require a 10 Day Lead Time**

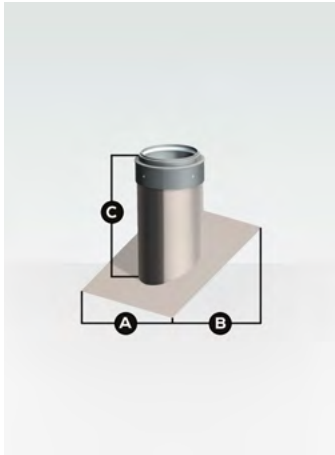

## Pitched Roof Flashing

With field supplied sealant, stainless steel flashing creates water-tight roof penetration when using InnoFlue commercial on a pitched roof.

Nominal Diameter	Part	Length A	Width B	Height C
6"	IAPRF06	18"	*	*
8"	IAPRF08	20"	*	*
10"	IAPRF10	22"	*	*
12"	IAPRF12	24"	*	*
*Dimensions vary based on pitch.				

Indicate required pitch at time of order

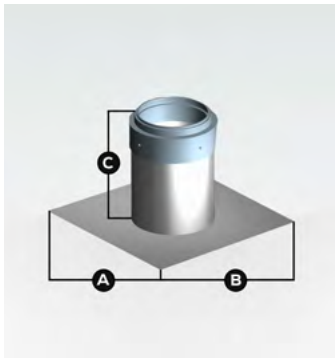

## Flat Roof Flashing

With field supplied sealant, stainless steel flashing creates water-tight roof penetration when using InnoFlue commercial on a flat roof.

Nominal Diameter	Part	Length A	Width B	Height C
6"	IAFRF06	18"	18"	13.3"
8"	IAFRF08	20"	20"	13.3"
10"	IAFRF10	22"	22"	13.8"
12"	IAFRF12	24"	24"	14.3"

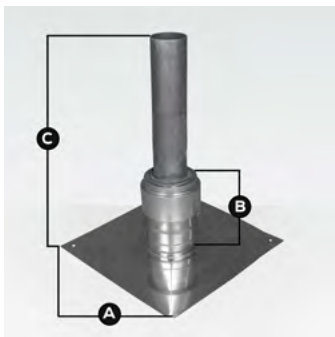

## Chimney Cover SS with PPs-Gray End Pipe

Stainless steel termination with polypropylene end pipe seals top of the chimney or chase.

Nominal Diameter	Part	Length A	Width B	Height C
6"	ISCM06	15.8	15.9	16.7
8"	ISCM08	19.7	19.7	19.7
10"	ISCM10	20	20	20
12"	ISCM12	20	20	39.4

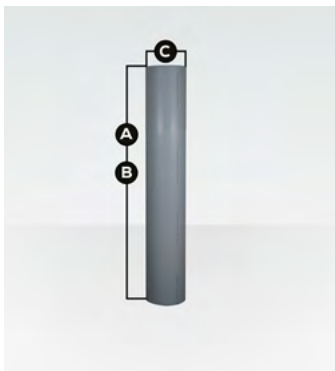

## End Pipe PPs-Gray

PPs End Pipes allow for termination of the vent system through the wall or roof.

Nominal Diameter	Part	Overall Length A	Effective Length B	Max O.D. C
6" (160)	ISEP0620	20 (508)	20 (508)	6 (160)
6" (160)	ISEP0639	39 (991)	39 (991)	6 (160)
8" (200)	ISEP086	70 (1778)	70 (1778)	8 (200)
10" (250)	ISEP106	70 (1778)	70 (1778)	10 (250)
12" (315)	ISEP126	72 (1829)	72 (1829)	12 (315)



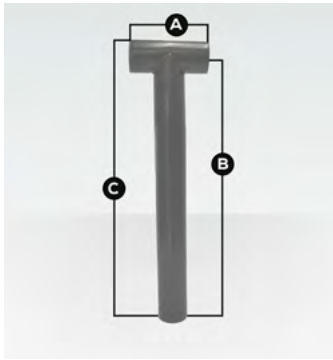

### Termination Tee (long)

Made from polypropylene. Use where termination is exposed to excessive sunlight, wind or prone to freeze ups.

Nominal Diameter	Part	Length A	Width B	Height C
6"	ISTT0620	9	6.5	30.8
8"	ISTT0820	16	7.9	32
10"	ISTT1020	20.5	9.9	32.3
12"	ISTT1220	22	12.4	41.5



### Velocity Cone

Made to order. Call for more information.

Nominal Diameter	Part
3" to 2"	ISVC0302
4" to 3"	ISVC0403
5" to 4"	ISVC0504
6" to 4"	ISVC0604
6" to 5"	ISVC0605
8" to 6"	ISVC0806
10" to 6"	ISVC1006
10" to 8"	ISVC1008

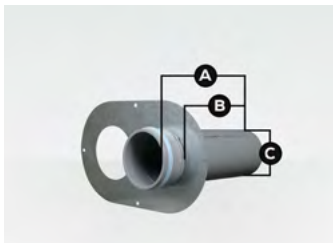

### PPs to PVC Termination Kit

Adapts PPs to PVC Twin Pipe Termination. Comes with replacement wall plate and termination adaptor.

Nominal Diameter	Part	Overall Length A	Effective Length B	End O.D. C
6" (160)	ISLTK06	14.4 (366)	11.0 (280)	6.5 (166)

## Accessories



### Bird Screen PP5-UV

Fits inside InnoFlue® SW end pipes at terminations.

Nominal Diameter	Part
6" (160)	IASPP06



Bird Screen SS	
Fits inside InnoFlue® SW end pipes at terminations.	
Nominal Diameter	Part
8" (200)	IASSS08
10" (250)	IASSS10
12" (315)	IASSS12

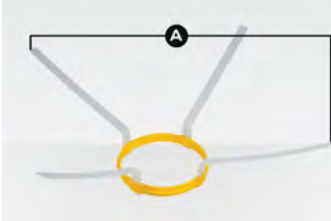

6" Spacers			
Self positioning spacers centers InnoFlue® SW in a chase/chimney/B-vent.			
Nominal Diameter	Part	Max Width A	Min Width
6" (160)	IASP06	25.0 (635)	7 (186)

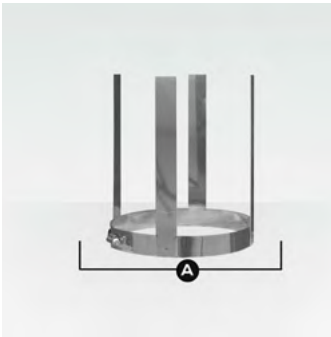

8", 10" and 12" Spacers			
Self positioning spacers centers InnoFlue® SW in a chase/chimney/B-vent.			
Nominal Diameter	Part	Max Width A*	Min Width
8" (200)	IASP08	27.6 (700)	9 (228)
10" (250)	IASP10	29.5 (750)	11 (276)
12" (315)	IASP12	32.1 (815)	13 (341)
		* When bent into place	

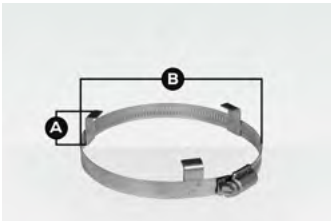

Flue Clamp			
Secures ISAG and ISAGL appliance adaptors to appliance flue exhaust.			
Nominal Diameter	Part	Height A	Max. I.D. B
6" (160)	IAFC06	1.0 (26)	8.3 (211)

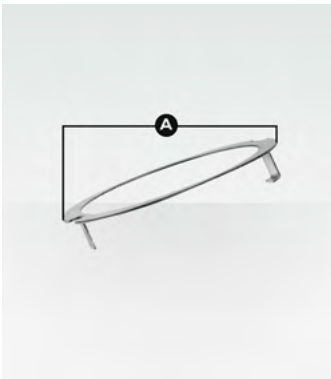

Connector Ring		
Provides reinforcement at joints to support loads of up to 99 lbs (45Kg). 6" through 12" connector rings are available but not required per UL 1738 and ULC-5636.		
Nominal Diameter	Part	O.D. A
6" (160)	IANS06	7.5 (191)
8" (200)	IANS08	9.4 (239)
10" (250)	IANS10	10.7 (271)
12" (315)	IANS12	14.9 (378.5)

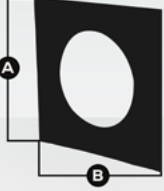

**Wall Plate Square (Plastic)**

Used to improve aesthetics and reduce drafts at chimney openings or wall penetrations.

Nominal Diameter	Part	Length A	Length B
6" (160)	IAWP06BP	9" (228)	9" (228)
8" (200)	IAWPP08	15.8" (401)	15.8" (401)



**Connector Double Hose Clamp**

Connection clamps provide mechanical connection as required by O.E.M.

Nominal Diameter	Part
5" (125)	IADHC0505
6" (160)	IADHC0606
8" (200)	IADHC0808
10" (250)	IADHC1010
12" (315)	IADHC1212



**Support Clamp**

Used as vertical or horizontal support. Space 78" in vertical and 39" in horizontal installations. **Uses 3/8" threaded rod.**

Nominal Diameter	Part	Overall Length A	Height B
6" (160)	IASCM06	6.8 (172.7)	1.1 (28)
8" (200)	IASCM08	8.4 (213.3)	1.1 (28)
10" (250)	IASCM10	10.3 (261.6)	1.1 (28)
12" (315)	IASCM12	12.8 (325.1)	1.1 (28)



**EPDM Gaskets**

Standard gasket for 6" through 12" diameter InnoFlue® SW. Inserted into the female end of each part, the gaskets keep flue gases and condensates within the vent system.

Nominal Diameter	Part
6" (160)	ISGE06
8" (200)	ISGE08
10" (250)	ISGE10
12" (315)	ISGE12



**Centrocerin**

A water based lubricant used to ease the assembly of InnoFlue® SW & Flex. Sparingly applied to the gasket or male end.

Package Size	Part
50 ml	IACE50



solutions beyond

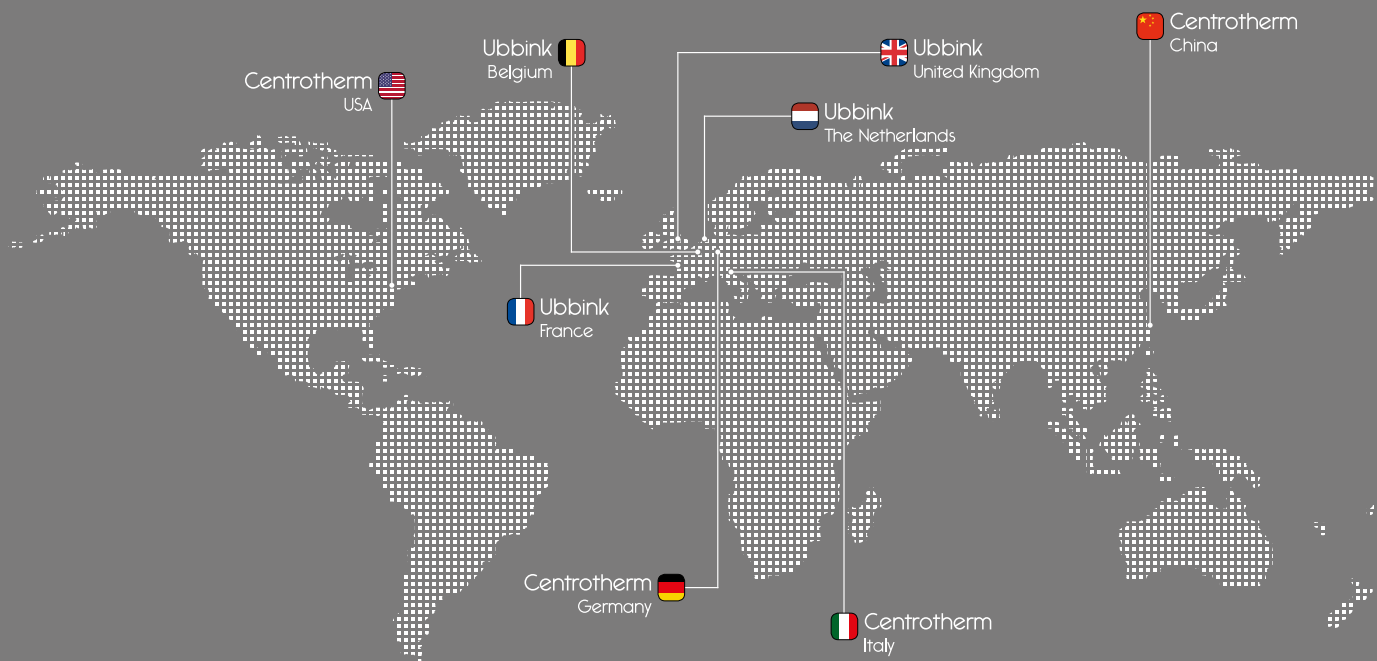

Ubbink Netherlands [www.ubbink.nl](http://www.ubbink.nl)

Ubbink Belgium [www.ubbink.be](http://www.ubbink.be)

Ubbink France [www.ubbink.fr](http://www.ubbink.fr)

Ubbink United Kingdom [www.ubbink.co.uk](http://www.ubbink.co.uk)

Ubbink International [www.ubbink.com](http://www.ubbink.com)

Centrotherm Germany [www.centrotherm.com](http://www.centrotherm.com)

Centrotherm Italy [www.centrotherm.it](http://www.centrotherm.it)

Centrotherm U.S.A. [www.centrotherm.us.com](http://www.centrotherm.us.com)

Centrotherm China [www.centrotherm-china.com](http://www.centrotherm-china.com)

[www.ubbink-centrotherm.com](http://www.ubbink-centrotherm.com)

#### NORTH AMERICA

Centrotherm

Toll Free: 877 434 3432

Fax: 518 618 3166

[info@centrotherm.us.com](mailto:info@centrotherm.us.com)

[www.centrotherm.us.com](http://www.centrotherm.us.com)



IMCS2018.01