

Features

- Solid brass construction ensures durability and reliability.
- KOHLER finishes resist corrosion and tarnishing, exceeding industry durability standards over two times.
- Without overflow.
- For use in non-overflow applications.



Codes/Standards













ASME A112.18.2/CSA B125.2

KOHLER® One-Year Limited Warranty

See website for detailed warranty information.

Available Color/Finishes

Color tiles intended for reference only.

| Color | Code | Description |
|--|------|--------------------------|
|  | CP | Polished Chrome |
|  | SN | Vibrant® Polished Nickel |
|  | AF | Vibrant® French Gold |
|  | PB | Vibrant® Polished Brass |
|  | G | Brushed Chrome |
|  | BN | Vibrant® Brushed Nickel |
|  | VS | Vibrant® Stainless |
|  | BV | Vibrant® Brushed Bronze |
|  | 2BZ | Oil-Rubbed Bronze |
|  | BL | Matte Black |
|  | TT | Titanium |
|  | VNT | Vintage Nickel |

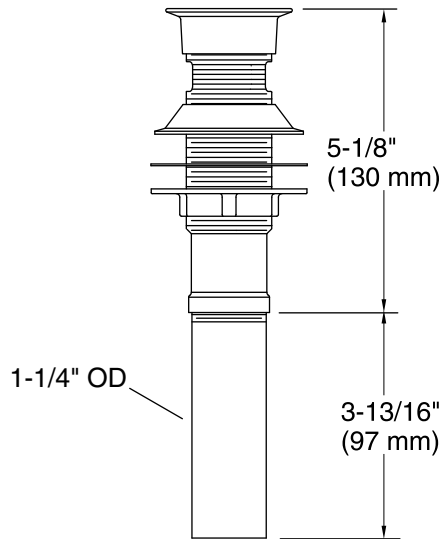
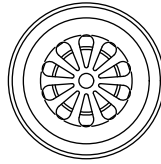

Technical Information

All product dimensions are nominal.

Notes

Install this product according to the installation guide.