

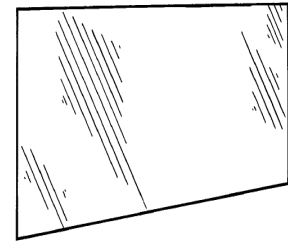

MEDICINE CABINETS

SPECIFICATION SHEET

**WM3648PEBP3
Wall Mirror**



FEATURES/TYPICAL SPECIFICATIONS

- Surface Mount Installation
- 5/32" thick float glass mirror with polished edge, 4 sides
- Silver mirror with IR cured, protective paint backing
- Overall Weight: 23.9lbs
- Manufactured in accordance with ASTM C 1036 and C 1503
- Point of Origin: USA
- Individually packaged
- Shipped as part of a 3 mirror bulk pack
- Mounting hardware available for purchase separately

Finishes:

- Housing: N/A
- Mirror: Polished Edge
- Frame: Frameless

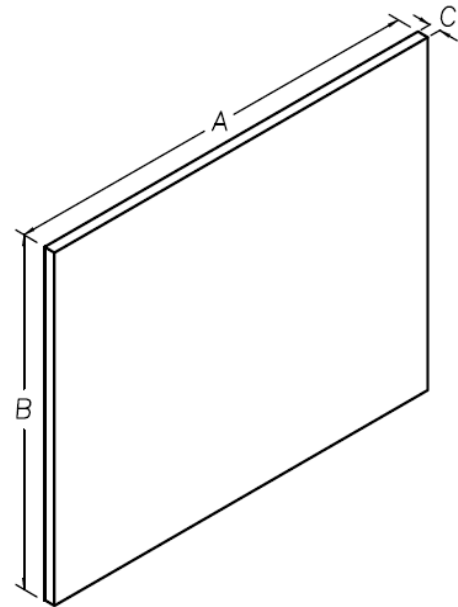

		Dimensions In Inches		
Model #	Description	A	B	C
WM3648PEBP3	WALL MIRROR 36X48 PE	47.875	35.875	0.156

REFERENCE	QTY.	REMARKS	Project
			Location
			Architect
			Engineer
			Contractor
			Submitted by Date

* All models and material specifications are subject to change or withdrawal without notice.

SWM3648PEBP3_A00