

# 87A-200 SERIES

STAINLESS STEEL ASME CLASS 150 FLANGED FULL PORT BALL VALVE  
1/2" THRU 1"



FOR STANDARDS COMPLIANCE AND STANDARD FEATURES REFER TO PAGE D-3.

## STANDARD MATERIAL LIST

	PART	MATERIAL
1	Body	ASTM A351 CF8M
2	Retainer	ASTM A276 Type 316
3	Ball	ASTM A276 Type 316
4	Stem	ASTM A276 Type 316
5	Packing Gland	ASTM A276 Type 316
6	Stem Seals	PTFE
7	Seats	TFM 1700
8	Gland Screws	ASTM A193 B8 Class 1
9	Gland Plate	302 or 304 Stainless Steel
10	Stem Nut	316 Stainless Steel
11	Lever	302 or 304 with Vinyl Grip
12	Stem Bearing	RPTFE
13	Stop	ASTM A276 Type 316
14	Stop Screw	18-8 Stainless Steel
15	Lock Plate	302 or 304 Stainless Steel
16	Body Seal	RPTFE
17	Lockwasher	302 or 304 Stainless Steel
18	Grounding Spring	Stainless Steel

## VARIATIONS AVAILABLE

- 87H - Hastelloy
- 87M - Monel
- 87N - Nickel
- 87S - 304L Stainless Steel

## OPTIONS AVAILABLE

(MORE INFORMATION IN SECTION J)

- Minimum quantities apply.
- To specify an option, replace the "01" standard suffix with the suffix of the option.
- To specify multiple options, replace the "01" suffix with the desired suffixes in the numerical order shown below. NOTE: Not all suffixes can be combined together.

(SUFFIX)	OPTION
-01	Standard Configuration
-04-	2-1/4" Stem Extension (Carbon Steel, Zinc Plated)
-14-	Side Vented Ball (Uni-Directional)
-15-	Wheel Handle, Steel
-21-	UHMWPE Seats
-24-	Graphite Packing, Spiral Wound Graphite Body Seal, RPTFE Bearing (API 607, 6th Edition, ISO 10497:2010)
-35-	PTFE Seats and Seals
-38-	PEEK Seats and Graphite Packing
-49-	No Lubrication. Assembled Dry
-57-	Oxygen Cleaned
-65-	MPTFE Seats and Graphite Packing (Fire Safe)
-69-	Drilled and Tapped Purge Port with Plugs
-70-	4" Extended Bonnet
-73-	316 Stainless Steel Spiral Wound Gaskets with PTFE Filler
-76-	Live Loaded (Lever)
-77-	Live Loaded (Gear, Actuator)
-80-	TFM 1600 Seats, PTFE Chevron Packing, Spiral Wound PTFE Body Seal, PEEK Bearing
-82-	Flat Face Flanges
-90-	Double Packed 4" Extended Bonnet
-9P-	Double Packed 4" Extended Bonnet with Monitoring Port
-CE-	CE Marking. See Page D-3 "Product Approvals" for Availability
-EF-	Graphite Packing (API 641 Compliant) (Not Available on 1/2" Size)
-EP-	Garlock EVSP Stem Packing with Spiral Wound Graphite Gasket (Fire Safe by Design)
-KF-	PCTFE Stem Bearing
-MP-	Positive Material Identification
-TC-	With Test Certificate
-TD-	Tested to API Spec 6D
-UA-	AIS (American Iron & Steel) Compliant
-UL-	UL & CSA Listed (with Markings)
-ZP1-	Fugitive Emissions Packing (Viton)
-ZP2-	Fugitive Emissions Packing (Buna-N)
-ZP3-	Fugitive Emissions Packing (Kalrez)

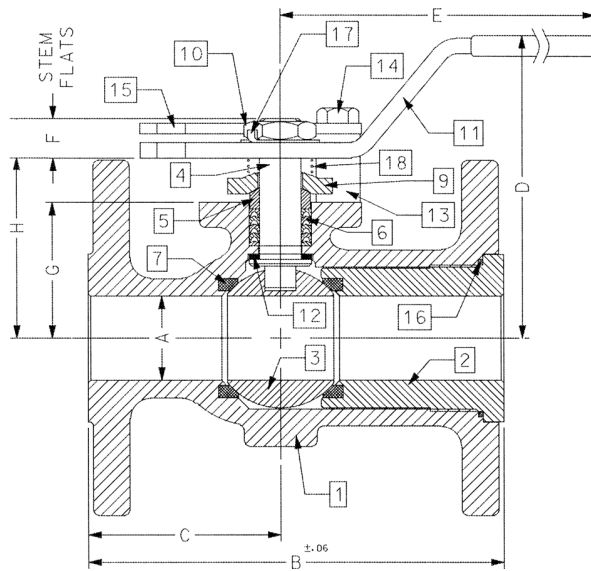

## ACTUATOR MOUNTING

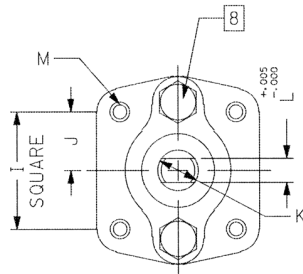

**Pressure/Temperature Ratings - Page M-9, Graph No. 2**

## DIMENSIONS

PART NO.	SIZE	A	B	C	D	E	F	G	H	I	J	K	L	M	WT.
87A-203-01A	1/2"	0.50	4.25	2.06	2.74	5.12	0.24	1.09	1.44	1.00	0.500	0.375	0.245	10-24	5
87A-204-01A	3/4"	0.75	4.62	2.18	3.43	5.54	0.22	1.65	2.13	1.392	0.696	0.500	0.312	1/4-20	6
87A-205-01	1"	1.00	5.00	2.32	4.62	6.53	0.47	1.62	2.15	1.392	0.696	0.500	0.287	1/4-20	7

REV. 10SEP19

# 87A-200 SERIES

STAINLESS STEEL ASME CLASS 150 FLANGED FULL PORT BALL VALVE  
1-1/2" THRU 2-1/2"



FOR STANDARDS COMPLIANCE AND STANDARD FEATURES REFER TO PAGE D-3.

## STANDARD MATERIAL LIST

	PART	MATERIAL
1	Body	ASTM A351 CF8M
2	Retainer	ASTM A351 CF8M
3	Ball	ASTM A276 Type 316 or A351 CF8M
4	Stem	ASTM A276 Type 316
5	Packing Gland	ASTM A276 Type 316
6	Stem Seals	PTFE
7	Seats	TFM 1700
8	Gland Screws	ASTM A193 B8 Class 1
9	Gland Plate	316 Stainless Steel
10	Adapter Screw	18-8 Stainless Steel
11	Lever	316 Stainless Steel
12	Stem Bearing	RPTFE
13	Stop	ASTM A276 Type 316
14	Stop Screw	316 Stainless Steel
15	Lock Plate	302 or 304 Stainless Steel
16	Body Seal	RPTFE
17	Grounding Spring	Stainless Steel
18	Body Joint Stud	ASTM A193 Grade B8M
19	Body Joint Nut	ASTM A194 Grade 8
20	Lockwasher	302 or 304 Stainless Steel

## VARIATIONS AVAILABLE

- 87H - Hastelloy
- 87M - Monel
- 87N - Nickel
- 87S - 304L Stainless Steel

## OPTIONS AVAILABLE

(MORE INFORMATION IN SECTION J)

- Minimum quantities apply.
- To specify an option, replace the "01" standard suffix with the suffix of the option.
- To specify multiple options, replace the "01" suffix with the desired suffixes in the numerical order shown below. NOTE: Not all suffixes can be combined together.

(SUFFIX)	OPTION
-01	Standard Configuration
-04-	2-1/4" Stem Extension (Carbon Steel, Zinc Plated) (up to 2-1/2")
-14-	Side Vented Ball (Uni-Directional)
-21-	UHMWPE Seats
-24-	Graphite Packing, Spiral Wound Graphite Body Seal, RPTFE Bearing (API 607, 6th Edition, ISO 10497:2010)
-35-	PTFE Seats and Seals
-38-	PEEK Seats and Graphite Packing
-49-	No Lubrication. Assembled Dry
-57-	Oxygen Cleaned
-65-	MPTFE Seats and Graphite Packing (Fire Safe)
-69-	Drilled and Tapped Purge Ports with Plugs
-70-	4" Extended Bonnet
-73-	316 Stainless Steel Spiral Wound Gaskets with PTFE Filler
-76-	Live Loaded (Lever)
-77-	Live Loaded (Gear, Actuator)
-80-	TFM 1600 Seats, PTFE Chevron Packing, Spiral Wound PTFE Body Seal, PEEK Bearing
-82-	Flat Face Flanges
-MG-	Gear Operator with Standard Handwheel
-90-	Double Packed 4" Extended Bonnet
-9P-	Double Packed 4" Extended Bonnet with Monitoring Port
-CE-	CE Marking. See Page D-3 "Product Approvals" for Availability
-EF-	Graphite Packing (API 641 Compliant)
-EP-	Garlock EVSP Stem Packing with Spiral Wound Graphite Gasket (Fire Safe by Design)
-KF-	PCTFE Stem Bearing
-MH-	Gear Operator with Standard Handwheel & Locking Device
-MJ-	Gear Operator with Oversize Handwheel
-MK-	Gear Operator with Oversize Handwheel & Locking Device
-MP-	Positive Material Identification
-TC-	With Test Certificate
-TD-	Tested to API Spec 6D
-UA-	AIS (American Iron & Steel) Compliant
-UL-	UL & CSA Listed (with Markings)
-ZP1-	Fugitive Emissions Packing (Viton)
-ZP2-	Fugitive Emissions Packing (Buna-N)
-ZP3-	Fugitive Emissions Packing (Kalrez)

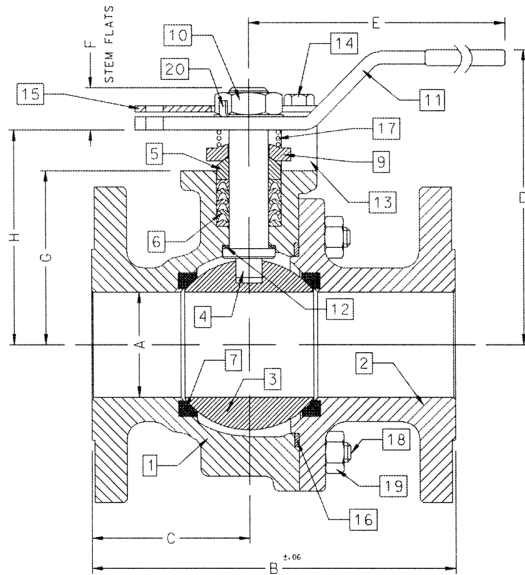

## ACTUATOR MOUNTING

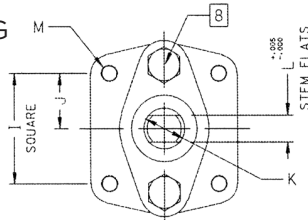

## DIMENSIONS

PART NO.	SIZE	A	B	C	D	E	F	G	H	I	J	K	L	M	WT.
87A-207-01	1-1/2"	1.50	6.50	3.00	4.62	6.65	0.72	2.41	3.09	1.949	0.974	0.625	0.412	5/16-18	14
87A-208-01	2"	2.00	7.00	3.04	5.61	8.41	0.80	3.31	4.08	1.949	0.974	0.750	0.477	5/16-18	25
87A-209-01	2-1/2"	2.50	7.50	3.34	6.24	8.41	0.80	3.94	4.71	1.949	0.974	0.750	0.477	5/16-18	30

**Pressure/Temperature Ratings - Page M-9, Graph No. 2**

REV. 18JUL19

# 87A-200 SERIES

STAINLESS STEEL ASME CLASS 150 FLANGED FULL PORT BALL VALVE  
3" THRU 6"



FOR STANDARDS COMPLIANCE AND STANDARD FEATURES REFER TO PAGE D-3.

## STANDARD MATERIAL LIST

	PART	MATERIAL
1	Body	ASTM A351 CF8M
2	Retainer	ASTM A351 CF8M
3	Ball	ASTM A276 Type 316 or A351 CF8M
4	Stem	ASTM A276 Type 316
5	Packing Gland	ASTM A276 Type 316
6	Stem Seals	PTFE
7	Seats	TFM 1700
8	Gland Screws	ASTM A193 B8 Class 1
9	Gland Plate	316 Stainless Steel
10	Adapter Screw	18-8 Stainless Steel
11	Handle Adapter	316 with Vinyl Grip
12	Stem Bearing	RPTFE
13	Stop	ASTM A276 Type 316
14	Stop Screw	316 Stainless Steel
15	Lock Plate	302 or 304 Stainless Steel
16	Body Seal	RPTFE
17	Grounding Spring	Stainless Steel
18	Body Joint Stud	ASTM A193 Grade B8M
19	Body Joint Nut	ASTM A194 Grade 8
20	Pipe Handle	Galvanized Steel (not shown)

## VARIATIONS AVAILABLE

- 87H - Hastelloy
- 87N - Nickel
- 87S - 304L Stainless Steel

## OPTIONS AVAILABLE

(MORE INFORMATION IN SECTION J)

- Minimum quantities apply.
- To specify an option, replace the "01" standard suffix with the suffix of the option
- To specify multiple options, replace the "01" suffix with the desired suffixes in the numerical order shown below. NOTE: Not all suffixes can be combined together.

(SUFFIX)	OPTION
-01	Standard Configuration
-14-	Side Vented Ball (Uni-Directional)
-21-	UHMWPE Seats
-24-	Graphite Packing, Spiral Wound Graphite Body Seal, RPTFE Bearing (API 607, 6th Edition, ISO 10497:2010)
-35-	PTFE Seats and Seals
-38-	PEEK Seats and Graphite Packing
-49-	No Lubrication. Assembled Dry
-57-	Oxygen Cleaned
-65-	MPTFE Seats and Graphite Packing (Fire Safe)
-69-	Drilled and Tapped Purge Ports with Plugs
-70-	4" Extended Bonnet
-73-	316 Stainless Steel Spiral Wound Gaskets with PTFE Filler
-76-	Live Loaded (Lever)
-77-	Live Loaded (Gear, Actuator)
-80-	TFM 1600 Seats, PTFE Chevron Packing, Spiral Wound PTFE Body Seal, PEEK Bearing
-82-	Flat Face Flanges
-90-	Double Packed 4" Extended Bonnet
-9P-	Double Packed 4" Extended Bonnet with Monitoring Port
-CE-	CE Marking. See Page D-3 "Product Approvals" for Availability
-EF-	Graphite Packing (API 641 Compliant)
-EP-	Garlock EVSP Stem Packing with Spiral Wound Graphite Gasket (Fire Safe by Design)
-KF-	PCTFE Stem Bearing
-MG-	Gear Operator with Standard Handwheel
-MH-	Gear Operator with Standard Handwheel & Locking Device
-MJ-	Gear Operator with Oversize Handwheel
-MK-	Gear Operator with Oversize Handwheel & Locking Device
-MP-	Positive Material Identification
-TC-	With Test Certificate
-TD-	Tested to API Spec 6D
-UA-	AIS (American Iron & Steel) Compliant
-UL-	UL & CSA Listed (with Markings)
-ZP1-	Fugitive Emissions Packing (Viton)
-ZP2-	Fugitive Emissions Packing (Buna-N)
-ZP3-	Fugitive Emissions Packing (Kalrez)

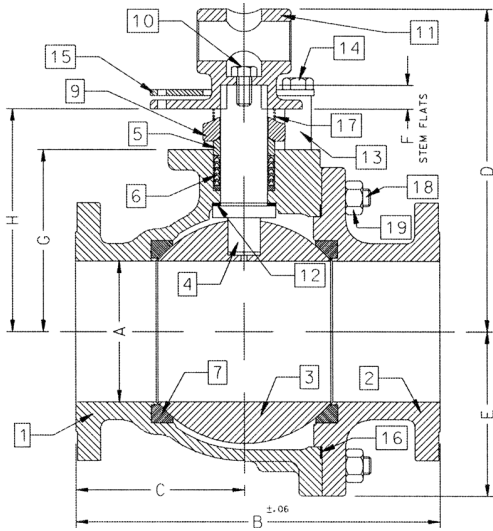

## ACTUATOR MOUNTING

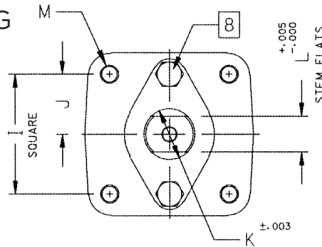

## DIMENSIONS

PART NO.	SIZE	A	B	C	D	E	F	G	H	I	J	K	L	M	WT.
87A-200-01	3"	3.00	8.00	3.68	8.80	3.88	0.50	4.75	5.95	2.840	1.420	1.250	0.725	3/8-16	60
87A-20A-01	4"	4.00	9.00	3.94	9.99	5.13	0.50	5.94	7.13	2.840	1.420	1.250	0.725	3/8-16	91
87A-20C-01	6"	6.00	15.50	7.19	13.73	7.00	1.00	7.75	9.48	4.596	2.298	2.000	1.375	3/4-10	248

**Pressure/Temperature Ratings - Page M-9, Graph No. 2**

# 87A-200 SERIES

STAINLESS STEEL ASME CLASS 150 FLANGED FULL PORT BALL VALVE  
8" THRU 12"



FOR STANDARDS COMPLIANCE AND STANDARD FEATURES REFER TO PAGE D-3.

## STANDARD MATERIAL LIST

	PART	MATERIAL
1	Body	ASTM A351 CF8M
2	Retainer	ASTM A351 CF8M
3	Ball	ASTM A276 Type 316 or A351 CF8M
4	Stem	ASTM A276 Type 316
5	Packing Gland	ASTM A276 Type 316
6	Stem Seals	PTFE
7	Seats	TFM 1700
8	Gland Screws	ASTM A193 B8 Class 1
9	Gland Plate	316 Stainless Steel
10	Stem Bearing	RPTFE
11	Body Seal	RPTFE
12	Body Joint Stud	ASTM A193 Grade B8M
13	Body Joint Nut	ASTM A194 Grade 8

## VARIATIONS AVAILABLE

- 87H - Hastelloy
- 87N - Nickel
- 87S - 304L Stainless Steel

## OPTIONS AVAILABLE

(MORE INFORMATION IN SECTION J)

- Minimum quantities apply.
- To specify an option, replace the "01" standard suffix with the suffix of the option.
- To specify multiple options, replace the "01" suffix with the desired suffixes in the numerical order shown below. NOTE: Not all suffixes can be combined together.

(SUFFIX)	OPTION
-01	Standard Configuration
-14-	Side Vented Ball (Uni-Directional)
-21-	UHMWPE Seats
-24-	Graphite Packing, Spiral Wound Graphite Body Seal, RPTFE Bearing (API 607, 6th Edition, ISO 10497:2010)
-35-	PTFE Seats and Seals
-49-	No Lubrication. Assembled Dry
-57-	Oxygen Cleaned
-65-	MPTFE Seats and Graphite Packing (Fire Safe)
-69-	Drilled and Tapped Purge Ports with Plugs
-70-	4" Extended Bonnet (8" Only)
-77-	Live Loaded (Gear, Actuator)
-80-	TFM 1600 Seats, PTFE Chevron Packing, Spiral Wound PTFE Body Seal, PEEK Bearing
-82-	Flat Face Flanges
-90-	Double Packed 4" Extended Bonnet
-9P-	Double Packed 4" Extended Bonnet with Monitoring Port
-CE-	CE Marking. See Page D-3 "Product Approvals" for Availability
-EF-	Graphite Packing (API 641 Compliant)
-EP-	Garlock EVSP Stem Packing with Spiral Wound Graphite Gasket (Fire Safe by Design)
-KF-	PCTFE Stem Bearing
-MG-	Gear Operator with Standard Handwheel
-MH-	Gear Operator with Standard Handwheel & Locking Device
-MJ-	Gear Operator with Oversize Handwheel
-MK-	Gear Operator with Oversize Handwheel & Locking Device
-MP-	Positive Material Identification
-TC-	With Test Certificate
-TD-	Tested to API Spec 6D
-UA-	AIS (American Iron & Steel) Compliant
-UL-	UL & CSA Listed (with Markings)
-ZP1-	Fugitive Emissions Packing (Viton)
-ZP2-	Fugitive Emissions Packing (Buna-N)
-ZP3-	Fugitive Emissions Packing (Kalrez)

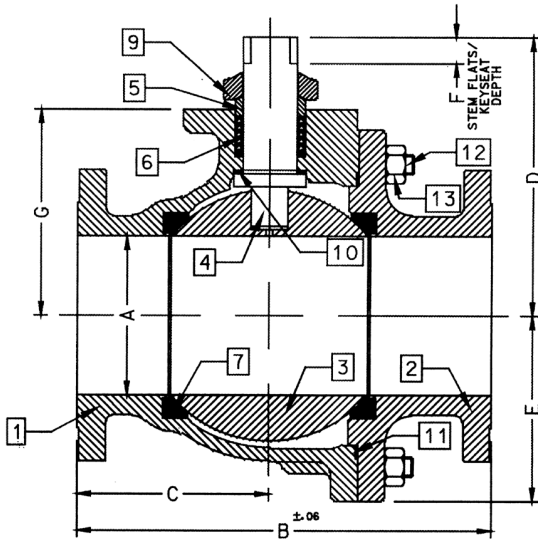

## ACTUATOR MOUNTING

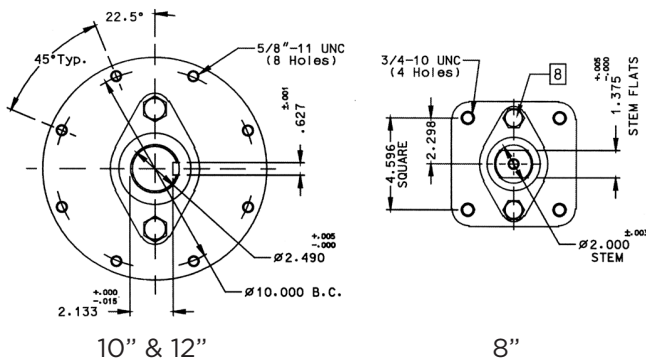

**Pressure/Temperature Ratings - Page M-9, Graph No. 2**

## DIMENSIONS

PART NO.	SIZE	A	B	C	D	E	F	G
87A-20E-01	8"	8.00	18.00	8.88	12.83	9.18	1.00	10.22
87A-20G-01	10"	10.00	21.00	10.26	18.57	11.33	2.31	12.80
87A-20H-01	12"	12.00	24.00	12.09	20.31	13.40	2.31	14.92

REV. 18JUL19

The listed  $C_v$  “factors” are derived from actual flow testing, at Apollo’s Pageland, South Carolina factory. These tests were completed using standard “off the shelf” valves with no special preparation and utilizing standard schedule 40 pipe. It should be understood that these factors are for the valve only and also include the connection configuration. The flow testing is done utilizing water as a fluid media and is a direct statement of the gallons of water flowed per minute with a 1psig pressure differential across the valve/connection unit. Line pressure is not a factor. Because the  $C_v$  is a factor, the formula can be used to estimate flow of most media for valve sizing.

### FLOW OF LIQUID

$$Q = C_v \sqrt{\frac{\Delta P}{SpGr}}$$

$$\text{or } \Delta P = \frac{(Q)^2 (SpGr)}{(C_v)^2}$$

#### WHERE:

- Q = Flow in US gpm
- ΔP = Pressure drop (psig)
- SpGr = Specific gravity at flowing temperature
- $C_v$  = Valve constant

### FLOW OF GAS

$$Q = 1360 C_v \sqrt{\frac{(\Delta P) (P_2)}{(SpGr) (T)}}$$

$$\text{or } \Delta P = \frac{5.4 \times 10^{-7} (SpGr) (T) (Q)^2}{(C_v)^2 (P_2)}$$

#### WHERE:

- Q = Flow in SCFH
- ΔP = Pressure drop (psig)
- SpGr = Specific gravity (based on air = 1.0)
- P2 = Outlet pressure-psia (psig + 14.7)
- T = (temp. °F + 460)
- $C_v$  = Valve constant

**CAUTION: The gas equation shown, is valid at very low pressure drop ratios. The gas equation is NOT valid when the ratio of pressure drop (ΔP) to inlet pressure (P1) exceeds 0.02.**

**NOTE: Only use the gas equation shown if (P1-P2)/P1 is less than 0.02.**

### CV FACTORS FOR APOLLO VALVES (CONTINUED ON M-4)

VALVE	SIZE (IN.)														
	1/4	3/8	1/2	3/4	1	1.25	1.5	2	2.5	3	4	6	8	10	12
70B-140 Series	8.4	7.2	15	30	43	48	84	108	190	370	670	--	--	--	--
70-100/200 Series	8.4	7.2	15	30	43	48	84	108	190	370	670	--	--	--	--
70-300/400 Series	--	--	15	30	43	48	84	108	--	--	--	--	--	--	--
70-600 Series	2.3	4.5	5.4	12	14	21	34	47	--	--	--	--	--	--	--
70-800 Series	8.4	7.2	15	30	43	48	84	--	--	--	--	--	--	--	--
71-AR Series	--	--	--	30	43	48	84	108	190	370	--	--	--	--	--
71-100/200 Series	--	--	--	30	43	48	84	108	190	370	--	--	--	--	--
72-100/900 Series	--	--	26	48	65	125	170	216	--	--	--	--	--	--	--
72-1xx-A/72-9xx-A Series	--	--	26	48	65	125	170	245	--	--	--	--	--	--	--
73A-100 Series	8.4	7.2	15	30	43	48	84	108	--	--	--	--	--	--	--
73-300/400 Series	--	--	26	48	65	125	170	216	--	--	--	--	--	--	--
74-100 Series	8.4	7.2	15	30	43	48	84	108	190	370	670	--	--	--	--
75-100 Series	8.4	7.2	15	30	43	48	84	108	190	370	670	--	--	--	--
76-AR Series	8.4	7.2	15	30	43	48	84	108	190	370	670	--	--	--	--
76F-100 Series	8.1	15	15	51	68	125	177	389	--	--	--	--	--	--	--
76FJ-100 Series	8.1	15	15	51	68	125	177	389	--	--	--	--	--	--	--
76FK-100 Series	8.1	15	15	51	68	125	177	389	--	--	--	--	--	--	--
76-100 Series	8.4	7.2	15	30	43	48	84	108	190	370	--	--	--	--	--
76-300/400 Series	--	--	26	48	65	125	170	216	--	--	--	--	--	--	--
76-600 Series	2.3	4.5	5.4	12	14	21	34	47	--	--	--	--	--	--	--
76J-100 Series	8.4	7.2	15	30	43	48	84	108	190	370	--	--	--	--	--
76J-AR Series	8.4	7.2	15	30	43	48	84	108	190	370	670	--	--	--	--
76K-100 Series	8.4	7.2	15	30	43	48	84	108	190	370	--	--	--	--	--
76K-AR Series	8.4	7.2	15	30	43	48	84	108	190	370	670	--	--	--	--
7K-100 Series	--	--	15	51	68	125	177	389	503	--	--	--	--	--	--
77-AR Series	8.1	15	15	51	68	--	177	389	--	--	--	--	--	--	--

REV. 21APR17

## CV FACTORS FOR APOLLO VALVES (CONTINUED FROM M-3)

VALVE	SIZE (IN.)														
	1/4	3/8	1/2	3/4	1	1.25	1.5	2	2.5	3	4	6	8	10	12
77C-100/200 Series	4.5	7.2	16	36	68	125	177	389	503	--	--	--	--	--	--
77D-140 Series	4.5	7.2	16	36	68	125	177	389	--	--	--	--	--	--	--
77D-640 Series	--	--	--	11	24	35	--	--	--	--	--	--	--	--	--
77G-UL Series	4.5	7.2	16	36	68	125	177	389	503	--	--	--	--	--	--
77W Series	--	--	16	36	68	125	177	389	--	--	--	--	--	--	--
77-100/200 Series	8.1	15	15	51	68	125	177	389	503	--	--	--	--	--	--
79 Series	8.5	8.5	9.8	32	44	66	148	218	440	390	--	--	--	--	--
80 Series	8.4	7.2	15	30	43	48	84	108	190	370	--	--	--	--	--
82-100/200 Series	8.1	14	26	51	68	120	170	376	510	996	1893	--	--	--	--
83A/83B Series	8.1	14	26	51	68	120	170	376	--	--	--	--	--	--	--
83R-100/200 Series	--	--	--	--	--	--	170	376	--	996	1893	--	--	--	--
86A/86B Series	8.1	14	26	51	68	120	170	376	--	--	--	--	--	--	--
86R-100/200 Series	--	--	--	--	--	--	170	376	--	996	1893	--	--	--	--
87A-100 Series	--	--	--	--	--	--	86	104	234	375	673	1099	1902	3890	--
87A-200 Series	--	--	15	19	75	--	195	410	545	1021	2016	4837	9250	15170	22390
87A-700 Series	--	--	--	--	--	--	86	104	234	375	673	1099	1902	3890	--
87A-900 Series	--	--	15	19	75	--	195	410	545	1021	2016	4837	9250	15170	22390
87A-F00 Series	--	--	--	--	75	--	195	410	545	1021	2016	4837	--	--	--
87B-100 Series	--	--	--	--	--	--	--	--	--	375	673	1099	1902	3890	--
87J-100 Series	--	--	--	--	--	--	86	104	234	375	673	1099	1902	3890	--
87J-200 Series	--	--	15	19	75	--	195	410	545	1021	2016	4837	9250	15170	22390
87J-700 Series	--	--	--	--	--	--	86	104	234	375	673	1099	1902	3890	--
87J-900 Series	--	--	15	19	75	--	195	410	545	1021	2016	4837	9250	15170	22390
87K-100 Series	--	--	--	--	--	--	86	104	234	375	673	1099	1902	3890	--
87K-200 Series	--	--	15	19	75	--	195	410	545	1021	2016	4837	9250	15170	22390
87K-700 Series	--	--	--	--	--	--	86	104	234	375	673	1099	1902	3890	--
87K-900 Series	--	--	15	19	75	--	195	410	545	1021	2016	4837	9250	15170	22390
88A-100 Series	--	--	--	--	--	--	86	104	234	375	673	1099	1902	3890	--
88A-200 Series	--	--	15	19	75	--	195	410	545	1021	2016	4837	9250	15170	22390
88A-700 Series	--	--	--	--	--	--	86	104	234	375	673	1099	1902	3890	--
88A-900 Series	--	--	15	19	75	--	195	410	545	1021	2016	4837	9250	15170	22390
88A-F00 Series	--	--	--	--	75	--	195	410	545	1021	2016	4837	--	--	--
88B-100 Series	--	--	--	--	--	--	--	--	--	375	673	1099	1902	3890	--
89-100 Series	8.4	7.2	15	30	43	48	84	108	190	370	--	--	--	--	--
9A-100 Series	8.3	6.7	5.7	10	16	25	40	62	--	--	--	--	--	--	--
90-100 Series	8.3	6.7	5.7	10	16	25	40	62	--	--	--	--	--	--	--
92-100 Series	8.3	6.7	5.7	10	16	25	40	62	--	--	--	--	--	--	--
93-100 Series	8.3	6.7	5.7	10	16	25	40	62	--	--	--	--	--	--	--
94A-100/200 Series	6	7	19	34	50	104	268	309	629	1018	1622	--	--	--	--
96-100 Series	8.3	6.7	5.7	10	16	25	40	62	--	--	--	--	--	--	--
399-100 Series	8.4	7.2	15	30	43	48	84	108	190	370	--	--	--	--	--
489-100 Series	8.4	7.2	15	30	43	48	84	108	190	370	--	--	--	--	--



**CLASS 150**

**(CS) ASTM A216-WCB**

**GRAPH 1**

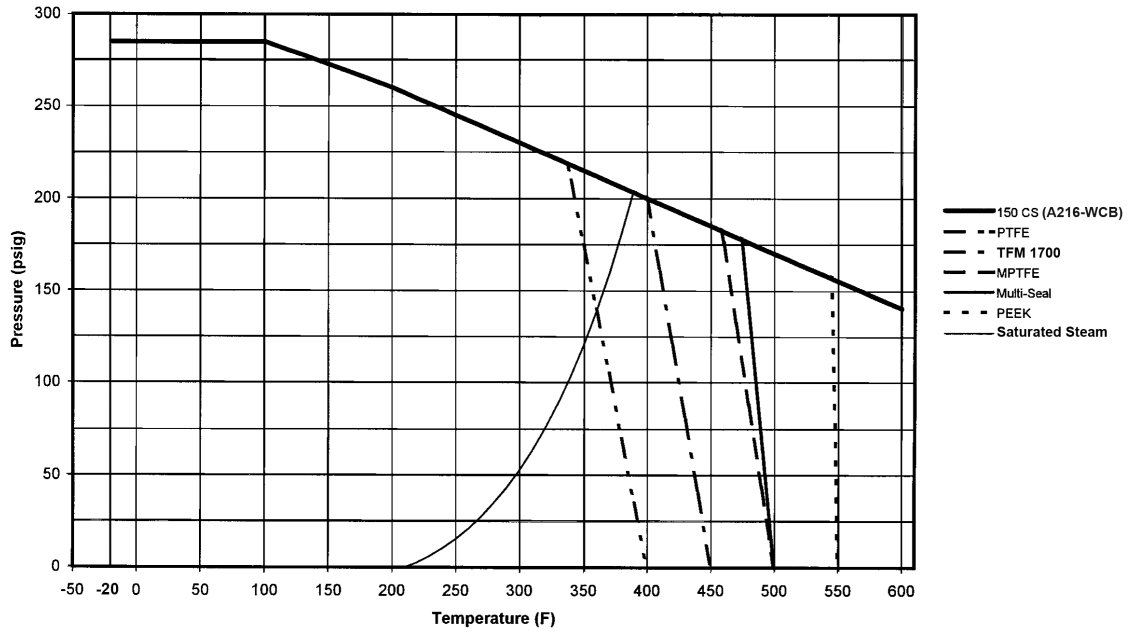

**CLASS 150**

**(SS) ASTM A351-CF8M**

**GRAPH 2**

