

⚠ WARNING:

RECOGNIZE THIS SYMBOL AS AN INDICATION OF IMPORTANT SAFETY INFORMATION

⚠ WARNING

THESE INSTRUCTIONS ARE INTENDED AS AN AID TO QUALIFIED, LICENSED SERVICE PERSONNEL FOR PROPER INSTALLATION, ADJUSTMENT, AND OPERATION OF THIS UNIT. READ THESE INSTRUCTIONS THOROUGHLY BEFORE ATTEMPTING INSTALLATION OR OPERATION. FAILURE TO FOLLOW THESE INSTRUCTIONS MAY RESULT IN IMPROPER INSTALLATION, ADJUSTMENT, SERVICE, OR MAINTENANCE POSSIBLY RESULTING IN FIRE, ELECTRICAL SHOCK, PROPERTY DAMAGE, PERSONAL INJURY, OR DEATH.

Do not destroy this manual. Please read carefully and keep in a safe place for future reference by a serviceman.

[] indicates metric conversions.

92-105074-09-01 (5/16) Printed in USA

VARIABLE SPEED R-410A HEAT PUMP OUTDOOR UNITS



INSTALLATION INSTRUCTIONS

**(-)P20 (20 SEER) EQUIPPED WITH
ECONET™ COMMUNICATIONS**

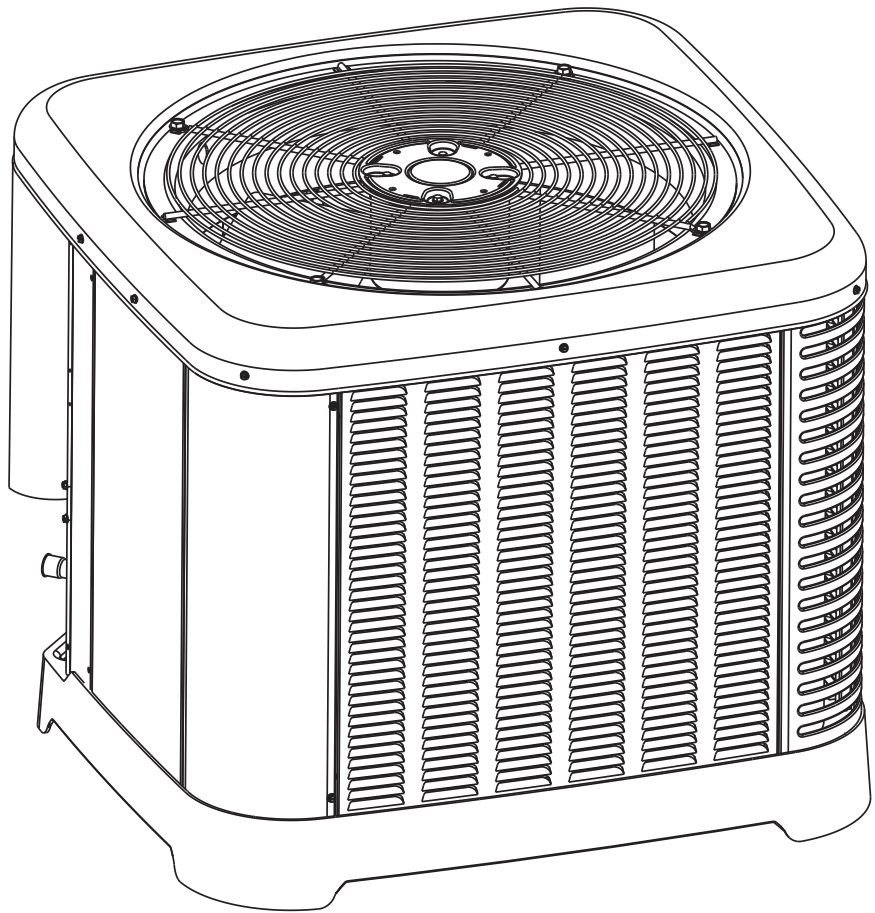

CONTENTS

Important	
Safety Information	3
Efficiency Testing Notice	3
General Information	4-7
Checking Product Received	4
Application	4
Electrical and Physical Data.....	5-6
Specifications	6-7
Proper Installation	7
Installation	8-22
Choosing a Location	8-10
Operational Issues.....	8
Corrosive Environment.....	8
For Units With	
Space Limitations.....	9
Customer Satisfaction Issues	9
Unit Mounting.....	9
Factory-Preferred	
Tie-Down Method.....	9
Snow Depth Table.....	10
Tools and Refrigerant	11
Tools Required for Installing and	
Servicing R-410A Models	11
Specifications of R-410A	11
Quick-Reference	
Guide for R-410A	11
Replacement Units	12
Indoor Coil	12
Location.....	12
Interconnecting Tubing	12-26
Refrigerant Level Adjustment.....	12
Maximum Length of Lines.....	12
Interconnecting Tubing and	
Fitting Losses	13
Liquid Line Selection.....	13
Long Line Set Applications	14
Oil Level Adjustments for Long Line.....	14
Suction Line Selection	15
Refrigerant Migration During Off Cycle.....	15
Tubing Installation	20
Tubing Connections	21
Leak Testing	22
Wiring	23-26
EcoNet™ Control Communications.....	23
Control Wiring	23
EcoNet™ Control Board	
Communication Wiring.....	23
Conventional 24VAC Thermostat Control Wiring.....	24
Conventional 24VAC Mode of Operation.....	24
Typical Noncommunicating Thermostat	
Wiring Diagrams	25
Power Wiring	25
Grounding.....	26
Start-Up	27-32
Start-Up.....	27
Checking Airflow	27
Evacuation Procedure.....	28
Final Leak Testing.....	28
Checking Refrigerant Charge	29-32
Charging Units	
With R-410A Refrigerant	29
Confirm ID Airflow and Coils Are Clean.....	29
Measurement Device Setup.....	29
Charging by Weight.....	29
Setting Compressor Speed.....	30
Gross Charging by Pressures	30
Final Charge by Subcooling.....	31
Finishing Up Installation.....	31
Components and Controls	33-54
Compressor Stator Heat (CSH)	33
Stator Heat Operation	33
High- and Low-Pressure	
Controls (HPC and SPT)	33
Accumulator	34
Outdoor Fan Motors	34
Outdoor Fan Blades	34
Electronic Expansion	34
Alternate Suction Line Thermistor	35
Coil Thermistor	35
Compressor Sump Thermistor	35
Suction Pressure Transducer (SPT)	36
Discharge Line Thermistor	36
Power Inverter Compressor Controls	36
Choke/Inductor	37
Filter & Ferrite Rings	37
EcoNet™ Variable Speed	
Unitary Control	38
Test and SW2 Buttons	38
Memory Card	39
Factory Programmed Superheat.....	39
Superheat Offset Dip Switch Settings	39
Compressor Operation.....	41
Demand Defrost	42
Active Compressor Protection Mode.....	44
Default Operations Upon Component Failure.....	51
Test and Fault Recall Modes.....	51
Agency Test Mode Instructions.....	52
Accessories	55
Heat Pump Thermostat Warning Light Kit.....	55
Diagnostics	56-77
Replacement of EcoNet™ Variable Speed	
Unitary Control Board	56
ICC Diagnostic Codes.....	57-60
Electrical, Mechanical Checks Flowcharts	61-64
General Troubleshooting Chart	65
Service Analyzer Charts	66-71
Cooling and Heating Mode Troubleshooting Tips	72
Wiring Diagram.....	73

IMPORTANT SAFETY INFORMATION

⚠️ WARNINGS:

- These instructions are intended as an aid to qualified, licensed service personnel for proper installation, adjustment, and operation of this unit. Read these instructions thoroughly before attempting installation or operation. **Failure to follow these instructions may result in improper installation, adjustment, service, or maintenance possibly resulting in fire, electrical shock, property damage, personal injury, or death.**
- **The unit must be permanently grounded. Failure to do so can cause electrical shock resulting in severe personal injury or death.**
- **Turn off electric power at the fuse box or service panel before making any electrical connections.**
- **Complete the ground connection before making line voltage connections. Failure to do so can result in electrical shock, severe personal injury, or death.**
- **Disconnect all power to unit before starting maintenance. Failure to do so can cause electrical shock resulting in severe personal injury or death.**
- **Never assume the unit is properly wired and/or grounded. Always test the unit cabinet with a noncontact voltage detector available at most electrical supply houses or home centers before removing access panels or coming into contact with the unit cabinet.**
- **Do not use oxygen to purge lines or pressurize system for leak test. Oxygen reacts violently with oil, which can cause an explosion resulting in severe personal injury or death.**
- The top of the scroll compressor shell is hot. Touching the compressor top may result in serious personal injury.
- The manufacturer's warranty does not cover any damage or defect to the unit caused by the attachment or use of any components, accessories, or devices (other than those authorized by the manufacturer) into, onto, or in conjunction with the heat pump. **You should be aware that the use of unauthorized components, accessories, or devices may adversely affect the operation of the heat pump and may also endanger life and property.** The manufacturer disclaims any responsibility for such loss or injury resulting from the use of such unauthorized components, accessories, or devices.

⚠️ CAUTIONS:

- R-410A systems operate at approximately 60% higher pressures (1.6 times) than R-22 systems. Do not use R-22 service equipment or components on R-410A equipment. Use appropriate care when using this refrigerant. Failure to exercise care may result in equipment damage or personal injury.
- Only match this outdoor unit with a matched indoor coil or air handler approved for use with this outdoor unit per the unit manufacturer's specification sheet. The use of unmatched coils or air handler will likely result in a charge imbalance between the cooling and heating modes which can cause unsatisfactory operation including a high-pressure switch lockout condition.
- Only use indoor coils approved for use on R-410A systems. An R-22 coil will have a TXV or fixed restrictor device that is not designed to operate properly in an R-410A system and will result in serious operational issues. The R-22 coil could also contain mineral oil which is incompatible with the POE oil used in R-410A systems and could result in reliability issues with the compressor and TXVs.
- When coil is installed over a finished ceiling and/or living area, it is required that a secondary sheet metal condensate pan be constructed and installed under the entire unit. Failure to do so can result in property damage.
- The compressor has an internal overload protector. Under some conditions, it can take up to 2 hours for this overload to reset. Make sure overload has had time to reset before condemning the compressor.
- **UNIT MAY START SUDDENLY AND WITHOUT WARNING.** A flashing red light on the heat pump/defrost control indicates a call for unit operation is present at the heat pump/defrost control. The heat pump/defrost control will attempt to start unit after the anti-short cycle time expires, when a high or low pressure control automatically resets, or when the heat pump/defrost control exits the lockout mode as the temperature rises above 5°F.

Efficiency Testing Notice:

For purposes of verifying or testing efficiency ratings, the test procedure in Title 10 APPENDIX M to Subpart B of Part 430 (Uniform Test Method for Measuring the Energy Consumption of Central Air Conditioners and Heat Pumps) and the clarifying provisions provided in the AHRI Operations Manual 210/240 that were applicable at the date of manufacture should be used for test set up and performance.

GENERAL INFORMATION

⚠WARNING:

Improper installation, or installation not made in accordance with these instructions, can result in unsatisfactory operation and/or dangerous conditions and can cause the related warranty not to apply.

The RP series of heat pumps are designed to operate with standard 24 VAC thermostats and air handlers or gas furnaces.

This installation instruction manual contains complete instructions for installation and setup using conventional 24 VAC controls. Please refer to the manufacturer's specification sheets for complete performance data, thermostat, and accessory listings.

The information contained in this manual has been prepared to assist in the proper installation, operation, and maintenance of the air conditioning system.

Read this manual and any instructions packaged with separate equipment required to make up the system prior to installation. Homeowner should retain this manual for future reference.

To achieve optimum efficiency and capacity, the matching indoor cooling coils listed in the manufacturer's specification sheet must be used for this model heat pump.

Checking Product Received

Upon receiving unit, inspect it for any shipping damage. Claims for damage, either apparent or concealed, should be filed immediately with the shipping company. Check model number, electrical characteristics, and accessories to determine if they are correct. Check system components (indoor coil, outdoor unit, air handler/furnace, etc.) to make sure they are properly matched.

Application

Before specifying any heat pump equipment, a survey of the structure and a heat loss and heat gain calculation must be made. A heat loss calculation involves identifying all surfaces and openings that lose heat to the surrounding air and quantifying that heat loss. A cooling heat gain calculation makes similar measurements and determines the amount of heat needed to be removed. A heat gain calculation also calculates the extra heat load caused by sunlight and by humidity removal. These factors must be considered before selecting a heat pump system to provide year-round comfort. The Air Conditioning Contractors of America (ACCA) J Manual method of load calculation is one recognized procedure for determining the heating and cooling load.

After the proper equipment combination has been selected, satisfying both sensible and latent requirements, the system must be properly installed. Only then can the unit provide the comfort it was designed to provide.

There are several factors that installers must consider.

- Outdoor unit location
- Indoor unit blower speed and airflow
- Proper equipment evacuation
- Supply and return air duct design and sizing
- Refrigerant charge
- System air balancing
- Diffuser and return air grille location and sizing

GENERAL INFORMATION



Electrical and Physical Data

Rev. 03/16	ELECTRICAL						
Model Number (-)P20	Phase Frequency (Hz) Voltage (Volts)	Compressor		Fan Motor Full Load Amperes (FLA)	Minimum Circuit Ampacity Amperes	Fuse or HACR Circuit Breaker	
		Rated Load Amperes (RLA)	Locked Rotor Amperes (LRA)			Minimum Amperes	Maximum Amperes
24	1-60-208/230	20.7/20.7	35	1.4	28/28	35/35	45/45
36	1-60-208/230	21.9/21.9	35	5.3	33/33	40/40	50/50
48	1-60-208/230	21.6/21.6	50	5.3	46/46	60/60	70/70
60	1-60-208/230	31.7/31.7	50	5.3	45	60/60	70/70

Rev. 03/16	PHYSICAL					
Model Number (-)P20	Outdoor Coil			Refrig. Per Circuit Oz. [g]	Weight	
	Face Area Sq. Ft. [m ²]	No. Rows	CFM [L*s]		Net Lbs. [kg]	Shipping Lbs. [kg]
24	21.53 [2]	1	4375 [2065], 2770 [1307], 2078 [981]	135.2 [3832]	223 [101]	231 [104]
36	22.34 [2.1]	1	4251 [2006] 4094 [1932] 1919 [906]	169 [4791]	273 [124]	280 [127]
48	28.24 [2.6]	1	4994 [2357], 2618 [1236], 2057 [971]	215.2 [6100]	293 [133]	301 [137]
60	61.43 [5.7]	2	6242 [2946] 2947 [1391] 1775 [838]	321 [9100]	355 [161]	362 [164]

GENERAL INFORMATION

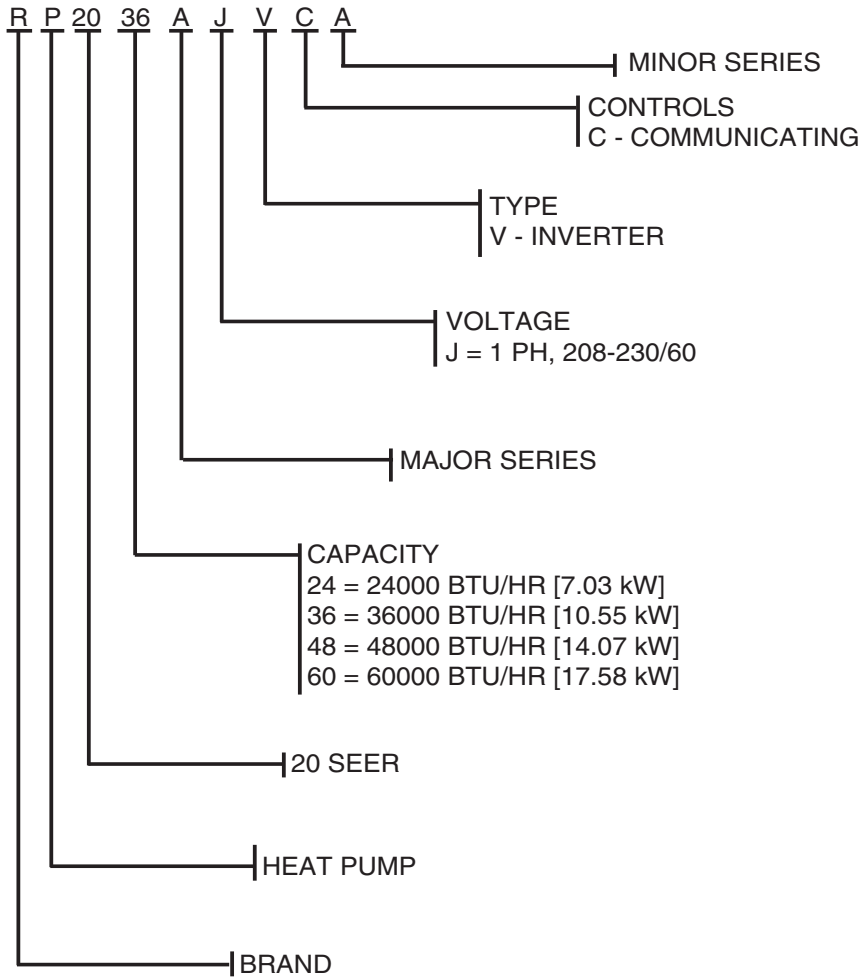

General Information

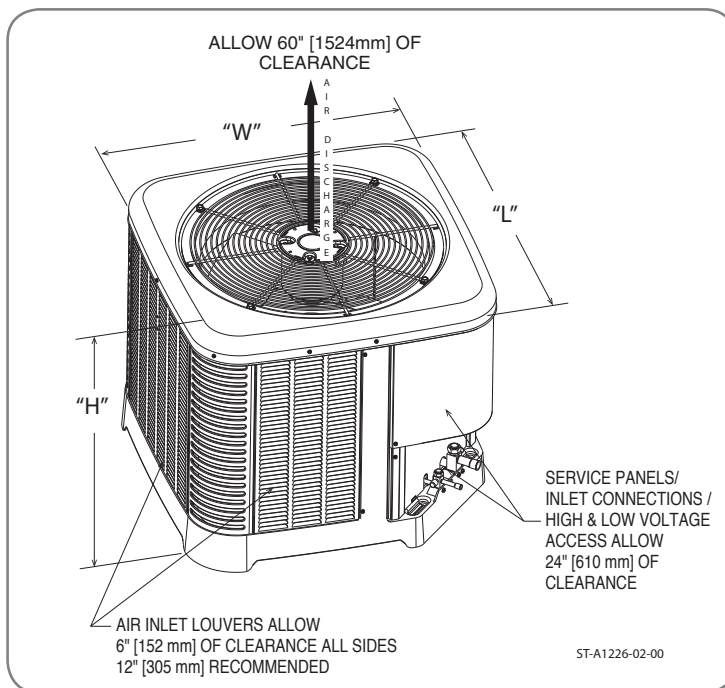



Specifications

DIMENSIONAL DATA

(-)P20	24	36	48	60
Height "H" inches (mm)	35 (889)	45 (1143)	51 (1295)	51 (1295)
Length "L" inches (mm)	35.75 (908)	35.75 (908)	35.75 (908)	35.75 (908)
Width "W" inches (mm)	35.75 (908)	35.75 (908)	35.75 (908)	35.75 (908)

Proper Installation

Proper sizing and installation of this equipment is critical to achieve optimal performance. Use the information in this Installation Instruction Manual and reference the applicable manufacturer's specification sheet when installing this product.

IMPORTANT: This product has been designed and manufactured to meet ENERGY STAR criteria for energy efficiency when matched with appropriate indoor components. However, proper refrigerant charge and proper airflow are critical to achieve rated capacity and efficiency. Installation of this product should follow the manufacturer's refrigerant charging and airflow instructions. **Failure to confirm proper charge and airflow may reduce energy efficiency and shorten equipment life.**

MATCH ALL COMPONENTS:

- OUTDOOR UNIT
- INDOOR COIL
- INDOOR AIR HANDLER/FURNACE
- REFRIGERANT LINES
- INDOOR THERMOSTAT

INSTALLATION



Choosing a Location

IMPORTANT: Consult local and national building codes and ordinances for special installation requirements. Following location information will provide longer life and simplified servicing of the outdoor heat pump.

NOTICE: These units must be installed outdoors. No ductwork can be attached, or other modifications made, to the discharge grille. Modifications will affect performance or operation.

Operational Issues

IMPORTANT: Locate the unit in a manner that will not prevent, impair, or compromise the performance of other equipment installed in proximity to the unit. Maintain all required minimum distances to gas and electric meters, dryer vents, and exhaust and inlet openings. In the absence of national codes or manufacturers' recommendations, local code recommendations and requirements will take precedence.

- Refrigerant piping and wiring should be properly sized and kept as short as possible to avoid capacity losses and increased operating costs.
- Locate the unit where water runoff will not create a problem with the equipment. Position the unit away from the drip edge of the roof whenever possible. Units are weatherized, but can be affected by the following:
 - Water pouring into the unit from the junction of rooflines, without protective guttering. Large volumes of water entering the heat pump while in operation can impact fan blade or motor life, and coil damage may occur to a heat pump if moisture cannot drain from the unit under freezing conditions.
 - Freezing moisture or sleeting conditions can cause the cabinet to ice-over prematurely and prevent heat pump operation, requiring backup heat, which generally results in less economical operation.
- Closely follow the clearance recommendations on page 8.
 - 24" [61.0 cm] to the service panel access
 - 60" [152.4 cm] above heat pump fan discharge (unit top) to prevent recirculation
 - 6" [15.2 cm] to heat pump coil grille air inlets with 12" [30.5 cm] minimum recommended

Corrosive Environment

The metal parts of this unit may be subject to rust or deterioration if exposed to a corrosive environment. This oxidation could shorten the equipment's useful life.

Corrosive elements include, but are not limited to, salt spray, fog or mist in seacoast areas, sulphur or chlorine from lawn watering systems, and various chemical contaminants from industries such as paper mills and petroleum refineries.

If the unit is to be installed in an area where contaminants are likely to be a problem, special attention should be given to the equipment location and exposure.

- Avoid having lawn sprinkler heads spray directly on the unit cabinet.
- In coastal areas, locate the unit on the side of the building away from the waterfront.
- Shielding provided by a fence or shrubs may give some protection, but cannot violate minimum airflow and service access clearances.
- Elevating the unit off its slab or base enough to allow air circulation will help avoid holding water against the base pan.

⚠ WARNING: Disconnect all power to unit before starting maintenance. Failure to do so can cause electrical shock resulting in severe personal injury or death.

Regular maintenance will reduce the buildup of contaminants and help to protect the unit's finish.

- Frequent washing of the cabinet, fan blade, and coil with fresh water will remove most of the salt or other contaminants that build up on the unit.
- Regular cleaning and waxing of the cabinet with a good automobile polish will provide some protection.
- A good liquid cleaner may be used several times a year to remove matter that will not wash off with water.



Choosing a Location (cont.)

For Units With Space Limitations

In the event that a space limitation exists, we will permit the following clearances:

Single-Unit Applications: Clearances below 6" [15.2 cm] will reduce unit capacity and efficiency. Do not reduce the 60" [152.4 cm] discharge or the 24" [61.0 cm] service clearances.

Multiple-Unit Applications: When multiple condenser grille sides are aligned, a 6" [15.2 cm] clearance is recommended for 1.5 and 2 ton models and 9" [22.9 cm] for 2.5 ton to 5 ton models. Two combined clearances below the minimum will reduce capacity and efficiency. Do not reduce the 60" [152.4 cm] discharge or 24" [61.0 cm] service clearances.

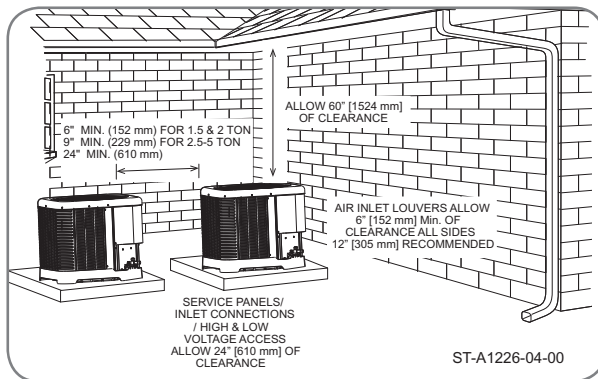

Customer Satisfaction Issues

- The heat pump should be located away from the living, sleeping, and recreational spaces of the owner and those spaces on adjoining property.
- To prevent noise transmission, the mounting pad for the outdoor unit should not be connected to the structure and should be located a sufficient distance above grade to prevent ground water from entering the unit.

Unit Mounting

⚠ WARNING: Secure an elevated unit and its elevating stand in order to prevent tipping. Failure to do so may result in severe personal injury or death.

Elevation of Unit

If elevating the heat pump, either on a flat roof or on a slab, observe the following guidelines.

- If elevating a unit on a flat roof, use 4" x 4" [10.2 cm x 10.2 cm] or equivalent stringers positioned to distribute unit weight evenly and prevent noise and vibration.
- Where snowfall is anticipated, raise the unit above the base pad to prevent ice buildup and coil damage. Mount the unit high enough to be above the average accumulated area snowfall. See "Ground Snow Depth" chart on page 10 for representative snow depths.

NOTICE: Do not block drain openings on bottom of unit.

- If unit must be elevated because of anticipated snowfall, secure unit and elevating stand such that unit and/or stand will not tip over or fall off. Keep in mind that someone may try to climb on unit.

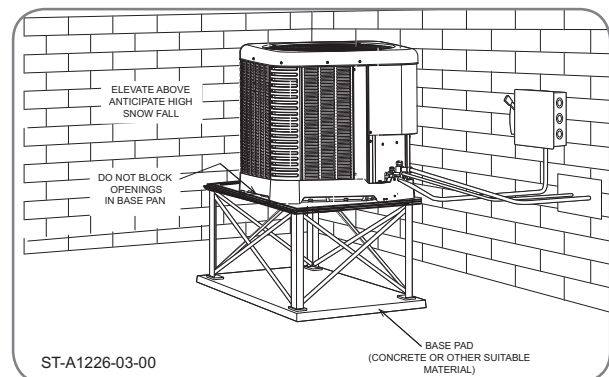

Factory-Preferred Tie-Down Method for High Wind or Seismic Loads

IMPORTANT: The manufacturer-approved/recommended method is a guide to securing equipment for wind and seismic loads. Other methods might provide the same result, but the manufacturer method is the only one endorsed by the manufacturer for securing equipment where wind or earthquake damage can occur. Additional information is available in the PTS (Product Technical Support) section of the manufacturer's Web sites MyRheem.com, or MyRuud.com and can be found as a listing under each outdoor model. If you do not have access to this site, your distributor can offer assistance.

INSTALLATION



Choosing a Location (cont.)

GROUND SNOW DEPTH – INCHES

ALABAMA	INDIANA	MINNESOTA	NEW MEXICO	PENNSYLVANIA	VIRGINIA						
Huntsville	7	Evansville	12	Duluth	64	Albuquerque	4	Allentown	23	Dulles Airport	19
ARIZONA	Fort Wayne	17	International Falls	43	Clayton	10	Erie	19	Lynchburg	16	
Flagstaff	48	Indianapolis	21	Minneapolis/St. Paul	50	Roswell	8	Harrisburg	23	National Airport	18
Prescott	3	South Bend	44	Rochester	50	NEW YORK	Philadelphia	16	Norfolk	9	
Winslow	7	IOWA	St. Cloud	53	Albany	25	Pittsburgh	22	Richmond	12	
ARKANSAS	Burlington	17	MISSISSIPPI	Binghamton	35	Scranton	16	Roanoke	17		
Ft. Smith	5	Des Moines	22	Jackson	3	Buffalo	42	Williamsport	20	WASHINGTON	
Little Rock	6	Dubuque	38	MISSOURI	NYC – Kennedy Airport	18	RHODE ISLAND	Olympia	24		
CALIFORNIA	Sioux City	33	Columbia	21	NYC – LaGuardia Airport	18	Providence	21	Quillayute	24	
Blue Canyon	25	Waterloo	36	Kansas City	18	Rochester	38	SOUTH CAROLINA	Seattle-Tacoma	14	
Mt. Shasta	69	KANSAS	St. Louis	16	Syracuse	35	Columbia	12	Spokane	41	
COLORADO	Concordia	23	Springfield	14	NORTH CAROLINA	Greenville	4	Stampede Pass	51		
Alamosa	15	Dodge City	12	MONTANA	Asheville	12	SOUTH DAKOTA	Yakima	25		
Colorado Springs	14	Goodland	14	Billings	17	Cape Hattaras	5	Aberdeen	42	WEST VIRGINIA	
Denver	15	Topeka	19	Glasgow	17	Charlotte	10	Huron	43	Beckley	51
Grand Junction	16	Wichita	11	Great Falls	16	Greensboro	11	Rapid City	14	Charleston	20
Pueblo	7	KENTUCKY	Havre	24	Raleigh-Durham	10	Sioux Falls	38	Elkins	21	
CONNECTICUT	Covington	12	Helena	18	Wilmington	9	TENNESSEE	Huntington	15		
Bridgeport	23	Lexington	12	Kalispell	53	Winston-Salem	17	Bristol	8	WISCONSIN	
Hartford	29	Louisville	11	Missoula	23	NORTH DAKOTA	Chattanooga	6	Green Bay	36	
New Haven	15	MAINE	NEBRASKA	Bismarck	25	Knoxville	8	La Crosse	32		
DELAWARE	Caribou	100	Grand Island	30	Fargo	34	Memphis	5	Madison	32	
Wilmington	13	Portland	62	Lincoln	20	Williston	25	Nashville	8	Milwaukee	32
GEORGIA	MARYLAND	Norfolk	29	OHIO	TEXAS	WYOMING					
Athens	5	Baltimore	17	North Platte	15	Akron-Canton	15	Abilene	6	Casper	10
Macon	8	MASSACHUSETTS	Omaha	20	Cleveland	16	Amarillo	10	Cheyenne	15	
IDAHO	Boston	30	Scottsbluff	11	Columbus	10	Dallas	3	Lander	20	
Boise	6	Nantucket	18	Valentine	22	Dayton	11	El Paso	5	Sheridan	25
Lewiston	9	Worcester	35	NEVADA	Mansfield	17	Fort Worth	6			
0 Pocatello	7	MICHIGAN	Elko	20	Toledo Express	8	Lubbock	10			
ILLINOIS	Alpena	53	Ely	9	Youngstown	12	Midland	2			
Chicago O'Hare	18	Detroit City	9	Reno	11	OKLAHOMA	San Antonio	3			
Chicago	22	Detroit Airport	17	Winnemucca	6	Oklahoma City	5	Wichita Falls	5		
Moline	17	Detroit – Willow Run	21	NEW HAMPSHIRE	Tulsa	8	UTAH				
Peoria	16	Flint	28	Concord	66	OREGON	Milford	16			
Rockford	25	Grand Rapids	37	NEW JERSEY	Burns City	24	Salt Lake City	8			
Springfield	23	Houghton Lake	56	Atlantic City	11	Eugene	17	Wendover	3		
		Lansing	42	Newark	15	Medford	8	VERMONT			
		Marquette	53			Pendleton	11	Burlington	37		
		Muskegon	43			Portland	10				
		Sault Ste. Marie	80			Salem	7				

NOTICE: Local records and experience must be considered when establishing the unit installation height. There is a 2% probability that the ground snow depth shown in this table will be exceeded annually. Drifts have not been considered. This data represents 184 National Weather Service locations at which measurements are made and assumes a nationwide snow density of 12 lb./ft.³

INSTALLATION



Tools and Refrigerant

Tools Required for Installing and Servicing R-410A Models

Manifold Sets:

- Up to 800 PSIG High-Side
- Up to 250 PSIG Low-Side
- 550 PSIG Low-Side Retard

Manifold Hoses:

- Service Pressure Rating of 800 PSIG

Recovery Cylinders:

- 400 PSIG Pressure Rating
- Dept. of Transportation 4BA400 or BW400

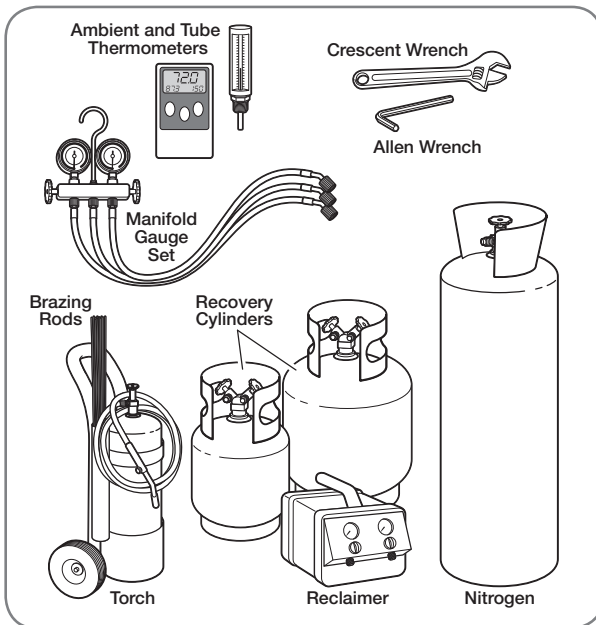

CAUTION: R-410A systems operate at higher pressures than R-22 systems. Do not use R-22 service equipment or components on R-410A equipment.

Specifications of R-410A

Application: R-410A is not a drop-in replacement for R-22. Equipment designs must accommodate its higher pressures. It cannot be retrofitted into R-22 heat pumps.

Physical Properties: R-410A has an atmospheric boiling point of -62.9°F [-52.7°C] and its saturation pressure at 77°F [25°C] is 224.5 psig.

Composition: R-410A is a near-azeotropic mixture of 50% by weight difluoromethane (HFC-32) and 50% by weight pentafluoroethane (HFC-125).

Pressure: The pressure of R-410A is approximately 60% (1.6 times) greater than R-22. Recovery and recycle equipment, pumps, hoses, and the like must have design pressure ratings appropriate for R-410A. *Manifold sets need to range up to 800 psig high-side and 250 psig low-side with a 550 psig low-side retard. Hoses need to have a service pressure rating of 800 psig. Recovery cylinders need to have a 400 psig service pressure rating, DOT 4BA400 or DOT BW400.*

Combustibility: At pressures above 1 atmosphere, a mixture of R-410A and air can become combustible. **R-410A and air should never be mixed in tanks or supply lines or be allowed to accumulate in storage tanks. Leak checking should never be done with a mixture of R-410A and air.** Leak-checking can be performed safely with nitrogen or a mixture of R-410A and nitrogen.

Quick-Reference Guide For R-410A

- R-410A refrigerant operates at approximately 60% higher pressure (1.6 times) than R-22. Ensure that servicing equipment is designed to operate with R-410A.
- R-410A refrigerant cylinders are light rose in color.
- R-410A, as with other HFCs, is only compatible with POE oils.
- Vacuum pumps will not remove moisture from POE oil used in R-410A systems.
- R-410A systems are to be charged with liquid refrigerants. Prior to March 1999, R-410A refrigerant cylinders had a dip tube. These cylinders should be kept upright for equipment charging. Post-March 1999 cylinders do not have a dip tube and should be inverted to ensure liquid charging of the equipment.
- Do not install a suction line filter drier in the liquid line.
- A factory-approved biflow liquid line filter drier is shipped with every unit and must be installed in the liquid line at the time of installation. Only manufacturer-approved liquid line filter driers can be used. These are Sporlan (CW083S) and Alco (80K083S) driers. These filter driers are rated for minimum working pressure of 600 psig. The filter drier will only have adequate moisture-holding capacity if the system is properly evacuated.
- Desiccant (drying agent) must be compatible for POE oils and R-410A refrigerant.

INSTALLATION



Replacement Units

To prevent failure of a new unit, the existing line set must be correctly sized and cleaned or replaced. Care must be exercised that the expansion device is not plugged. For new and replacement units, a liquid line filter drier must be installed and refrigerant tubing must be properly sized. Test the oil for acid. If positive, a suction line filter drier is mandatory.

IMPORTANT: When replacing an R-22 unit with an R-410A unit, either replace the line set or ensure that residual mineral oil is drained from existing lines including oil trapped in low spots.



Indoor Coil

CAUTION: Only use evaporators approved for use on R-410A systems that are specifically matched with the outdoor unit per the manufacturer's specification sheets. Use of existing R-22 evaporators can introduce mineral oil to the R-410A refrigerant, forming two different liquids and decreasing oil return to the compressor. This can result in compressor failure.

REFER TO INDOOR COIL MANUFACTURER'S INSTALLATION INSTRUCTIONS.

IMPORTANT: The manufacturer is not responsible for the performance and operation of a mismatched system or for a match listed with another manufacturer's coil.

NOTICE: All outdoor units must be installed with a matched TXV indoor coil. Refer to manufacturer's outdoor unit specification sheet for approved indoor coils.

The thermostatic expansion valve in the matching coil is specifically designed to operate with R-410A. **DO NOT use an R-22 TXV or evaporator. The existing evaporator must be replaced with the factory-specified EXV evaporator specifically designed for R-410A.**

Location

Do not install the indoor coil in the return duct system of a gas or oil furnace. Provide a service inlet to the coil for inspection and cleaning. Keep the coil pitched toward the drain connection.

CAUTION: When coil is installed over a finished ceiling and/or living area, it is required that a secondary condensate pan be installed under entire unit. Failure to do so can result in property damage.



Interconnecting Tubing

The purpose of this section is to specify the best construction/sizing practices for installing interconnection tubing between the indoor and outdoor unit.

Refrigerant Level Adjustment

All units are factory-charged with R-410A refrigerant to cover 15 feet of standard size interconnecting liquid and vapor lines, not including the required liquid line filter drier. Refrigerant must be added for the filter/drier. Adjustment of charge may be necessary even if the application has exactly 15 feet of line set due to other installation variables such as pressure drop, vertical lift, and indoor coil size. For different lengths, adjust the charge as indicated below.

- 1/4" ± .3 oz./foot [6.4 mm ± 8.5 g/.30 m]
- 5/16" ± .4 oz./foot [7.9 mm ± 11.3 g/.30 m]
- 3/8" ± .6 oz./foot [9.5 mm ± 17.0 g/.30 m]
- 1/2" ± 1.2 oz./foot [12.7 mm ± 34.0 g/.30 m]
- 6 oz. required factory supplied field-installed filter drier.

Charge Adjustment = (Line Set (oz./ft.) x Total Length) – Factory Charge for Line Set

Example: A three ton heat pump unit with factory installed 3/8" liquid service valve requires 75 ft. of line set with a liquid line diameter of 1/2".

Factory Charge for Line Set = 15 ft. x .6 oz. = 9 oz.
Charge Adjustment = (1.2 oz. x 75 ft.) – 9 oz. = + 81 oz.



Interconnecting Tubing (cont.)

Interconnecting Tubing and Fitting Losses

Refrigerant tubing is measured in terms of actual length and equivalent length. Actual length is used for refrigerant charge applications. Equivalent length takes into account pressure losses from

tubing length, fittings, vertical separation, accessories, and filter dryers. The table below references different commonly used equivalent lengths.

Table 1

Equivalent Length for Fittings (ft)							
Line Size (in)	90° Short Radius Elbow	90° Long Radius Elbow	45° Elbow	Solenoid Valve	Check Valve	Site Glass	Filter Dryer
3/8	1.3	0.8	0.3	6	4	0.4	6
1/2	1.4	0.9	0.4	9	5	0.6	6
5/8	1.5	1	0.5	12	6	0.8	6
3/4	1.9	1.3	0.6	14	7	0.9	6
7/8	2.3	1.5	0.7	15	8	1	6
1-1/8	2.7	1.8	0.9	22	12	1.5	6

Liquid Line Selection

The purpose of the liquid line is to transport warm sub-cooled liquid refrigerant from the outdoor unit to the indoor unit in cooling mode. In heating mode the liquid line returns sub-cooled liquid from the indoor unit to the outdoor unit. It is important not to allow the refrigerant to flash any superheated vapor prior to the expansion device of the indoor coil. The flashing of refrigerant can occur for the following reasons:

- Low refrigerant charge
- Improperly selected liquid line size
- Absorption of heat prior to expansion device
- Excessive vertical rise between the condenser and evaporator

Table 2 lists the equivalent length per 25' of liquid

line at various diameters up to 300'. The total pressure drop allowed for the liquid line is 50 PSI. The procedure for selecting the proper liquid line is as follows:

- Measure the total amount of vertical rise
- Measure the total amount of liquid line needed
- Add all of the equivalent lengths associated with any fittings or accessories using the table above.
- Add the total length and fitting pressure drop. This will equal your total equivalent length.
- Round-down the total equivalent length to the closest value in Table 2.
- Reference Table 2 to verify the rounded-down value of the calculated equivalent length is compatible with the required vertical rise and diameter of liquid line.



INSTALLATION



Interconnecting Tubing (cont.)

Example: A 3-Ton heat pump unit is installed 50' below the ID unit, requires a 75' of 1/2" diameter liquid line, and 4 90° LR elbows.

- Fitting Equivalent Length (ft.) = 4 x .9 = 3.6'
- Total Equivalent Length (ft.) = 75' + 3.6' = 78.6'
- Rounded-down value (ft.) = 75'

This application is acceptable because the 50' vertical rise is less than the maximum rise of 75' for this application. The application is also considered to have a long line set. Reference the long line set section of the I&O for detail.

R-410A System Capacity Model	Liquid Line Size Connection Size (Inch I.D.) [mm]	Liquid Line Size												
		Elevation (Above or Below) Indoor Coil												
		Total Equivalent Length - Feet [m]												
		25 [7.62]	50 [15.24]	75 [22.86]	100 [30.48]	125 [45.72]	150 [45.72]	175 [53.34]	200 [60.96]	225 [68.58]	250 [76.20]	275 [83.82]	300 [91.44]	
		Maximum Vertical Separation - Feet [m]												
		25 [7.62]	N/R	N/R	N/R	N/R	N/R	N/R	N/R	N/R	N/R	N/R	N/R	
37	3/8" [9.53]	1/4 [6.35]	25 [7.62]	N/R	N/R	N/R	N/R	N/R	N/R	N/R	N/R	N/R	N/R	
		5/16 [7.94]	25 [7.62]	50 [15.24]	60 [18.29]	45 [13.72]	35 [10.67]	20 [6.1]	5 [1.52]	N/R	N/R	N/R	N/R	
		3/8 [9.53]	25 [7.62]	50 [15.24]	75 [22.86]	80 [24.38]	80 [24.38]	75 [22.86]	70 [21.34]	65 [19.81]	60 [18.29]	55 [16.76]	50 [15.24]	45 [13.72]
		7/16 [11.12]	25 [7.62]	50 [15.24]	75 [22.86]	95 [28.96]	90 [27.43]	90 [27.43]	85 [25.91]	85 [25.91]	85 [25.91]	80 [24.38]	80 [24.38]	80 [24.38]
		1/2 [12.71]	25 [7.62]	50 [15.24]	75 [22.86]	95 [28.96]	95 [28.96]	95 [28.96]	95 [28.96]	95 [28.96]	95 [28.96]	90 [27.43]	90 [27.43]	

(Excerpt from Table 2, page 17)

Long Line Set Applications

Long line set applications are defined as applications that require accessories or alternate construction methods. The following are special considerations that need to be addressed when installing a long line set application:

- Additional refrigerant charge
- Fitting losses and maximum equivalent length considerations
- Refrigerant migration during the off cycle
- Oil return to the compressor
- Capacity losses
- System oil level adjustment

Table 2 is used to determine if the application is considered to have a long line set. **The region of the chart that is shaded grey is considered to be a long line set application.**

Oil Level Adjustments for Long Line Set Applications

Additional oil will need to be added for long line set applications. (Ref. Table 2). Below is the equation for the oil level adjustment and the compressor nameplate oil charge for the different od units.

Oil to be Added = [(Charge Adjustment + OD Unit Name Plate Charge (oz.)) x (0.022) – [(0.10) x (Compressor Name Plate Oil Charge (oz.))]

Example: An application requires 125ft of line set with a liquid line diameter of 3/8", Charge Adjustment = 52.4 oz., Name Plate Charge = 107 oz., Name Plate Oil Charge = 25 oz., Oil to be Added = ((52.4 oz. +107 oz.) x .022) – (.10 x 25 oz.) = 1.0 oz.

OD Model	Compressor	Nameplate Oil Charge (oz)
(-)P2024	ZPV0212E-ZE9-130	40
(-)P2036		
(-)P2048	ZPV0342E-ZE9-130	40
(-)P2060	ZPV038CE-2E9-130	40



Interconnecting Tubing (cont.)

Suction Line Selection

Purpose of the suction line is to return superheated vapor to the condensing unit from the evaporator in cooling mode. While in heating mode the suction line transports discharge vapor to the indoor unit from the outdoor unit. Proper suction line sizing is important because it plays an important role in returning oil to the compressor to prevent potential damage to the bearings, valves, and scroll sets. Also, an improperly sized suction line can dramatically reduce capacity and performance of the system. The procedure for selecting the proper suction line is as follows:

- The total amount of suction line needed
- Add all of the equivalent lengths associated with any fittings or accessories using the table on previous page.
- Add the total length and fitting pressure drop. This will equal your total equivalent length.
- Reference Table 2 to verify that the calculated equivalent length falls within the compatibility region of the chart.
- Verify Table 3 to verify the capacity difference is compatible with the application.

Refrigerant Migration During Off Cycle

Long line set applications can require a considerable amount of additional refrigerant. This additional refrigerant needs to be managed throughout the entire ambient operating envelope that the system will go through during its life cycle. Off-Cycle migration is where excess refrigerant condenses and migrates to the lowest part of the system. Excessive build-up of refrigerant at the compressor will result in poor reliability and noisy operation during startup. This section demonstrates the required accessories and unit configuration for different applications.

Outdoor Unit Level or Near Level to Indoor Section Line Set

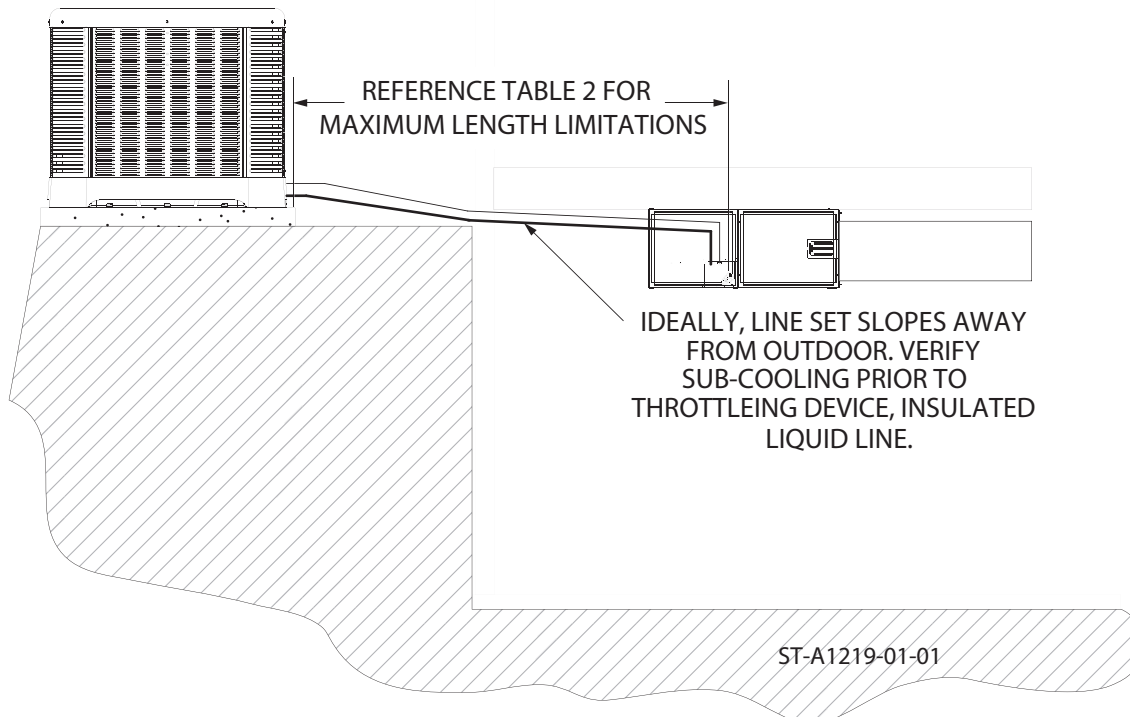

INSTALLATION



Interconnecting Tubing (cont.)

For applications that are considered to have a long line set with the outdoor unit and indoor unit on the same level the following is required:

- EXV on the indoor unit (standard equipment)
- Insulated liquid and suction line in unconditioned space only.
- Vapor line should slope toward the indoor unit
- Follow the proper line sizing, equivalent length, charging requirements, and oil level adjustments spelled out in this document
- Verify at least 5°F sub-cooling at the ID unit prior to throttling device

Outdoor Unit Below Indoor Section Line Set

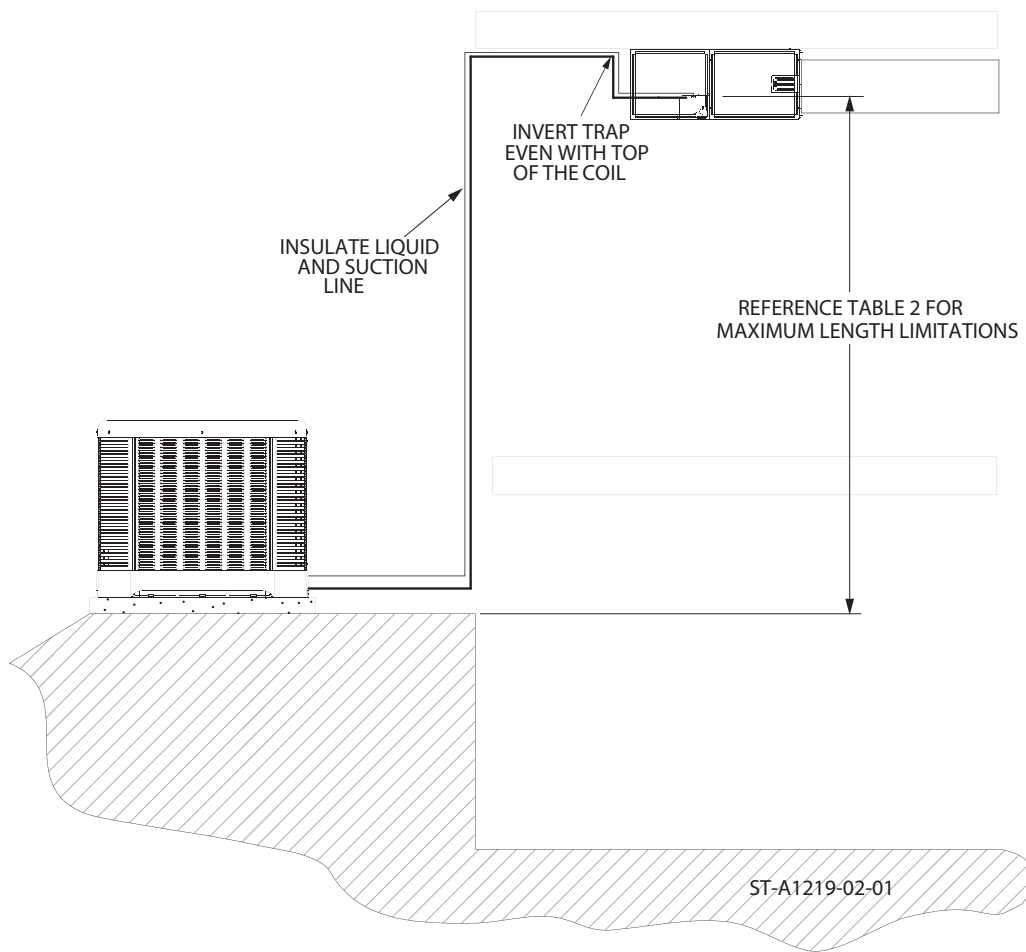

Figure 4

For applications that are considered to have a long line set with the outdoor unit below the indoor unit the following is required:

- EXV at the IDunit (standard equipment)
- Inverted vapor-line trap (Reference Figure 3)
- Insulated liquid and suction line in unconditioned space only.
- Follow the proper line sizing, equivalent length, charging requirements, and oil level adjustments spelled out in this document
- Measure pressure at the liquid line service valve and prior to expansion device. Verify that it is not greater than 50 PSI
- For elevations greater than 25' can expect a lower sub-cooling



Interconnecting Tubing (cont.)

Outdoor Unit Above Indoor Unit

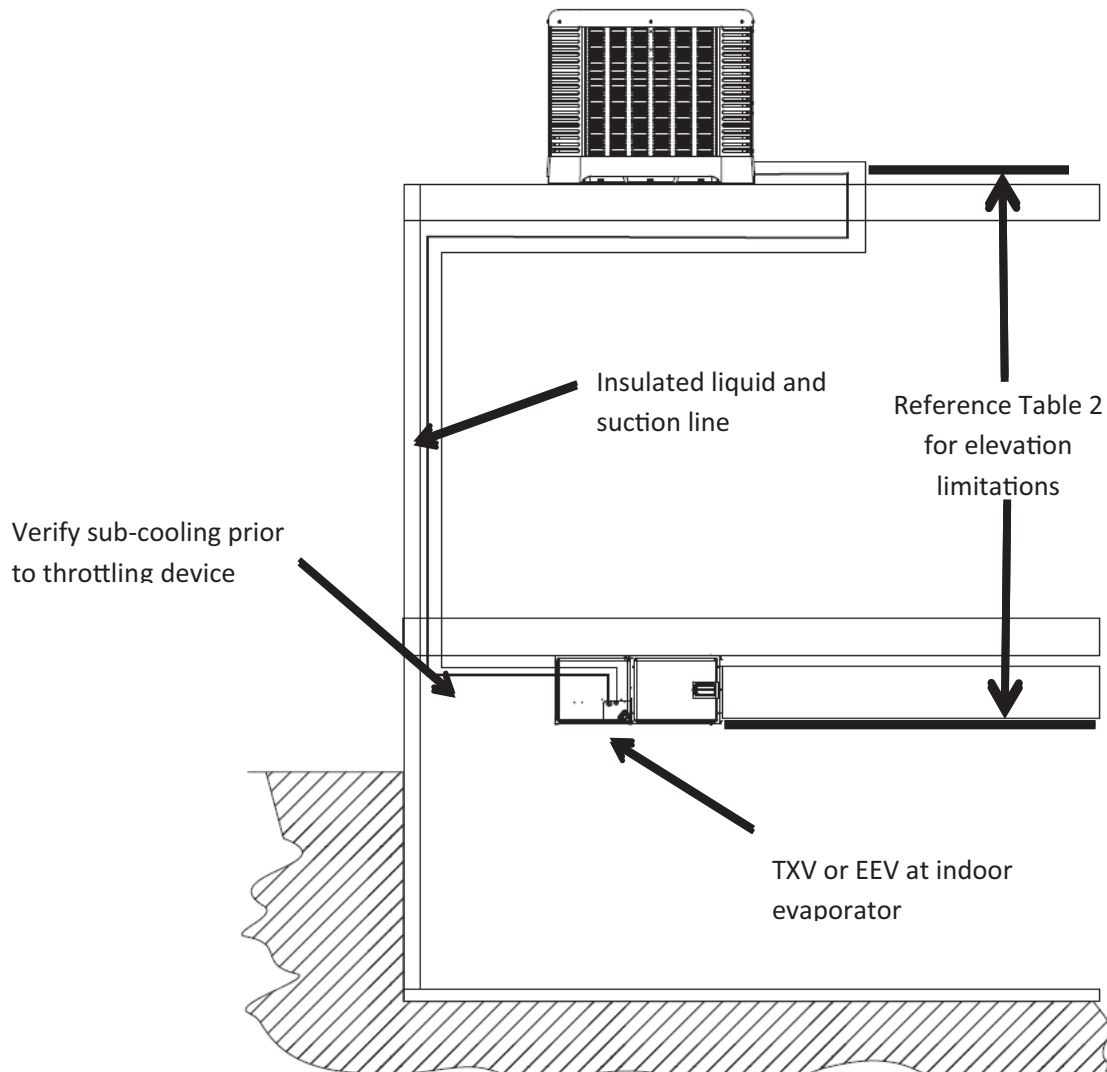

Figure 5

For applications that are considered to have a long line set with the outdoor unit above the indoor unit the following is required:

- EXV at the indoor unit (standard equipment)
- Insulated liquid and suction line in unconditioned space only.

- Follow the proper line sizing, equivalent length, charging requirements, and oil level adjustments spelled out in this document
- Verify at least 5°F sub-cooling at the ID unit prior to throttling device

INSTALLATION

Interconnecting Tubing

R-410A System Capacity Model	Liquid Line Connection Size (Inch I.D.) [mm]	Liquid Line Size (Inch O.D.) [mm]	Liquid Line Size Elevation Above or Below Indoor Coil																				
			Total Equivalent Length - Feet [m]																				
			Maximum Vertical Separation - Feet [m]																				
RP2024A	3/8" [9.53]	1/4 [6.35]	25 [7.62]	50 [15.24]	75 [22.86]	100 [30.48]	125 [45.72]	150 [45.72]	175 [53.34]	200 [60.96]	225 [68.58]	250 [76.20]	275 [83.82]	300 [91.44]	N/R	N/R	N/R	N/R	N/R	N/R			
			25 [7.62]	50 [15.24]	75 [22.86]	100 [30.48]	125 [45.72]	150 [45.72]	175 [53.34]	200 [60.96]	225 [68.58]	250 [76.20]	275 [83.82]	300 [91.44]	N/R	N/R	N/R	N/R	N/R	N/R	N/R		
		3/8 [9.53]	25 [7.62]	50 [15.24]	75 [22.86]	95 [28.96]	100 [30.48]	100 [30.48]	95 [28.96]	90 [27.43]	85 [25.91]	80 [24.38]	75 [22.86]	70 [21.34]	65 [19.81]	60 [18.29]	55 [16.76]	50 [15.24]	45 [13.72]	40 [12.19]	35 [10.67]		
		7/16 [11.12]	25 [7.62]	50 [15.24]	75 [22.86]	100 [30.48]	100 [30.48]	95 [28.96]	95 [28.96]	90 [27.43]	85 [25.91]	80 [24.38]	75 [22.86]	70 [21.34]	65 [19.81]	60 [18.29]	55 [16.76]	50 [15.24]	45 [13.72]	40 [12.19]	35 [10.67]		
		1/2 [12.71]	25 [7.62]	50 [15.24]	75 [22.86]	100 [30.48]	100 [30.48]	100 [30.48]	100 [30.48]	100 [30.48]	100 [30.48]	100 [30.48]	100 [30.48]	100 [30.48]	100 [30.48]	100 [30.48]	100 [30.48]	100 [30.48]	100 [30.48]	100 [30.48]	100 [30.48]	100 [30.48]	
		1/4 [6.35]	25 [7.62]	N/R	N/R	N/R	N/R	N/R	N/R	N/R	N/R	N/R	N/R	N/R	N/R	N/R	N/R	N/R	N/R	N/R	N/R	N/R	
	RP2036A	3/8" [9.53]	5/16 [7.94]	25 [7.62]	50 [15.24]	50 [15.24]	75 [22.86]	70 [21.34]	65 [19.81]	60 [18.29]	55 [16.76]	50 [15.24]	45 [13.72]	40 [12.19]	35 [10.67]	30 [9.14]	25 [7.62]	20 [6.10]	15 [4.57]	10 [3.05]	5 [1.52]		
				25 [7.62]	50 [15.24]	50 [15.24]	75 [22.86]	70 [21.34]	65 [19.81]	60 [18.29]	55 [16.76]	50 [15.24]	45 [13.72]	40 [12.19]	35 [10.67]	30 [9.14]	25 [7.62]	20 [6.10]	15 [4.57]	10 [3.05]	5 [1.52]	0 [0.00]	
			3/8 [9.53]	25 [7.62]	50 [15.24]	75 [22.86]	80 [24.38]	80 [24.38]	75 [22.86]	70 [21.34]	65 [19.81]	60 [18.29]	55 [16.76]	50 [15.24]	45 [13.72]	40 [12.19]	35 [10.67]	30 [9.14]	25 [7.62]	20 [6.10]	15 [4.57]	10 [3.05]	
			7/16 [11.12]	25 [7.62]	50 [15.24]	75 [22.86]	85 [25.91]	85 [25.91]	80 [24.38]	75 [22.86]	70 [21.34]	65 [19.81]	60 [18.29]	55 [16.76]	50 [15.24]	45 [13.72]	40 [12.19]	35 [10.67]	30 [9.14]	25 [7.62]	20 [6.10]	15 [4.57]	
			1/2 [12.71]	25 [7.62]	50 [15.24]	75 [22.86]	85 [25.91]	85 [25.91]	80 [24.38]	75 [22.86]	70 [21.34]	65 [19.81]	60 [18.29]	55 [16.76]	50 [15.24]	45 [13.72]	40 [12.19]	35 [10.67]	30 [9.14]	25 [7.62]	20 [6.10]	15 [4.57]	10 [3.05]
			1/4 [6.35]	10 [3.05]	N/R	N/R	N/R	N/R	N/R	N/R	N/R	N/R	N/R	N/R	N/R	N/R	N/R	N/R	N/R	N/R	N/R	N/R	N/R
RP2048A	3/8" [9.53]	5/16 [7.94]	25 [7.62]	50 [15.24]	70 [21.34]	65 [19.81]	60 [18.29]	55 [16.76]	50 [15.24]	45 [13.72]	40 [12.19]	35 [10.67]	30 [9.14]	25 [7.62]	20 [6.10]	15 [4.57]	10 [3.05]	5 [1.52]	0 [0.00]	0 [0.00]	0 [0.00]		
			25 [7.62]	50 [15.24]	70 [21.34]	65 [19.81]	60 [18.29]	55 [16.76]	50 [15.24]	45 [13.72]	40 [12.19]	35 [10.67]	30 [9.14]	25 [7.62]	20 [6.10]	15 [4.57]	10 [3.05]	5 [1.52]	0 [0.00]	0 [0.00]	0 [0.00]	0 [0.00]	
		3/8 [9.53]	25 [7.62]	50 [15.24]	75 [22.86]	80 [24.38]	75 [22.86]	70 [21.34]	65 [19.81]	60 [18.29]	55 [16.76]	50 [15.24]	45 [13.72]	40 [12.19]	35 [10.67]	30 [9.14]	25 [7.62]	20 [6.10]	15 [4.57]	10 [3.05]	5 [1.52]		
		7/16 [11.12]	25 [7.62]	50 [15.24]	75 [22.86]	85 [25.91]	85 [25.91]	80 [24.38]	75 [22.86]	70 [21.34]	65 [19.81]	60 [18.29]	55 [16.76]	50 [15.24]	45 [13.72]	40 [12.19]	35 [10.67]	30 [9.14]	25 [7.62]	20 [6.10]	15 [4.57]	10 [3.05]	
		1/2 [12.71]	25 [7.62]	50 [15.24]	75 [22.86]	85 [25.91]	85 [25.91]	80 [24.38]	75 [22.86]	70 [21.34]	65 [19.81]	60 [18.29]	55 [16.76]	50 [15.24]	45 [13.72]	40 [12.19]	35 [10.67]	30 [9.14]	25 [7.62]	20 [6.10]	15 [4.57]	10 [3.05]	
		1/4 [6.35]	N/R	N/R	N/R	N/R	N/R	N/R	N/R	N/R	N/R	N/R	N/R	N/R	N/R	N/R	N/R	N/R	N/R	N/R	N/R	N/R	
RP2060A	3/8" [9.53]	5/16 [7.94]	25 [7.62]	35 [10.67]	10 [3.05]	N/R	N/R	N/R	N/R	N/R	N/R	N/R	N/R	N/R	N/R	N/R	N/R	N/R	N/R	N/R	N/R		
			25 [7.62]	35 [10.67]	10 [3.05]	N/R	N/R	N/R	N/R	N/R	N/R	N/R	N/R	N/R	N/R	N/R	N/R	N/R	N/R	N/R	N/R	N/R	N/R
		3/8 [9.53]	25 [7.62]	50 [15.24]	60 [18.29]	50 [15.24]	40 [12.19]	30 [9.14]	25 [7.62]	20 [6.10]	15 [4.57]	10 [3.05]	5 [1.52]	0 [0.00]	0 [0.00]	0 [0.00]	0 [0.00]	0 [0.00]	0 [0.00]	0 [0.00]	0 [0.00]	0 [0.00]	
		7/16 [11.12]	25 [7.62]	50 [15.24]	75 [22.86]	70 [21.34]	65 [19.81]	60 [18.29]	55 [16.76]	50 [15.24]	45 [13.72]	40 [12.19]	35 [10.67]	30 [9.14]	25 [7.62]	20 [6.10]	15 [4.57]	10 [3.05]	5 [1.52]	0 [0.00]	0 [0.00]	0 [0.00]	
		1/2 [12.71]	25 [7.62]	50 [15.24]	75 [22.86]	80 [24.38]	75 [22.86]	70 [21.34]	65 [19.81]	60 [18.29]	55 [16.76]	50 [15.24]	45 [13.72]	40 [12.19]	35 [10.67]	30 [9.14]	25 [7.62]	20 [6.10]	15 [4.57]	10 [3.05]	5 [1.52]	0 [0.00]	
		1/4 [6.35]	N/R	N/R	N/R	N/R	N/R	N/R	N/R	N/R	N/R	N/R	N/R	N/R	N/R	N/R	N/R	N/R	N/R	N/R	N/R	N/R	N/R

NOTES:
 N/R = Application not recommended.
 Grey = This application is acceptable, but the long line guidelines must be followed. Reference Long Line Set section in the I&O.

INSTALLATION

Interconnecting Tubing (cont.)

R-410A System Capacity Model	Vapor Line Connection Size (Inch I.D.) [mm]	Vapor Line Size (Inch O.D.) [mm]	Vapor Line Selection Chart Capacity Multiplier Table														
			Total Equivalent Length - Feet [m]														
			25 [7.62]	50 [15.24]	75 [22.86]	100 [30.48]	125 [45.72]	150 [45.72]	175 [53.34]	200 [60.96]	225 [68.58]	250 [76.20]	275 [83.82]	300 [91.44]			
RP2024A	3/4" [19.06]	5/8 [15.88]	0.99	0.99	0.97	0.96	0.95	0.94	0.93	0.92	0.91	0.91	0.89	0.89	0.88	0.84	
			1.00	1.00	0.99	0.99	0.99	0.98	0.97	0.97	0.96	0.96	0.96	0.96	0.95	0.95	0.93
			N/R	N/R	N/R	N/R	N/R	N/R	N/R	N/R	N/R	N/R	N/R	N/R	N/R	N/R	N/R
		1 [25.4]	N/R	N/R	N/R	N/R	N/R	N/R	N/R	N/R	N/R	N/R	N/R	N/R	N/R	N/R	N/R
			N/R	N/R	N/R	N/R	N/R	N/R	N/R	N/R	N/R	N/R	N/R	N/R	N/R	N/R	N/R
			N/R	N/R	N/R	N/R	N/R	N/R	N/R	N/R	N/R	N/R	N/R	N/R	N/R	N/R	N/R
RP2036A	3/4" [19.06]	5/8 [15.88]	0.98	0.97	0.95	0.93	0.92	0.9	0.89	0.87	0.86	0.85	0.85	0.84	0.84	0.84	
			1.00	0.99	0.98	0.98	0.97	0.97	0.96	0.96	0.95	0.95	0.94	0.94	0.93	0.93	0.93
			N/R	N/R	N/R	N/R	N/R	N/R	N/R	N/R	N/R	N/R	N/R	N/R	N/R	N/R	N/R
		1 [25.4]	N/R	N/R	N/R	N/R	N/R	N/R	N/R	N/R	N/R	N/R	N/R	N/R	N/R	N/R	N/R
			N/R	N/R	N/R	N/R	N/R	N/R	N/R	N/R	N/R	N/R	N/R	N/R	N/R	N/R	N/R
			N/R	N/R	N/R	N/R	N/R	N/R	N/R	N/R	N/R	N/R	N/R	N/R	N/R	N/R	N/R
RP2048A	3/4" [19.06]	5/8 [15.88]	0.99	0.97	0.97	0.96	0.95	0.93	0.93	0.92	0.91	0.9	0.89	0.88	0.88	0.88	
			1.00	0.99	0.98	0.98	0.97	0.97	0.96	0.96	0.95	0.95	0.94	0.94	0.93	0.93	0.93
			N/R	N/R	N/R	N/R	N/R	N/R	N/R	N/R	N/R	N/R	N/R	N/R	N/R	N/R	N/R
		1 [25.4]	N/R	N/R	N/R	N/R	N/R	N/R	N/R	N/R	N/R	N/R	N/R	N/R	N/R	N/R	N/R
			N/R	N/R	N/R	N/R	N/R	N/R	N/R	N/R	N/R	N/R	N/R	N/R	N/R	N/R	N/R
			N/R	N/R	N/R	N/R	N/R	N/R	N/R	N/R	N/R	N/R	N/R	N/R	N/R	N/R	N/R
RP2060A	3/4" [19.06]	5/8 [15.88]	0.99	0.98	0.96	0.95	0.94	0.92	0.91	0.9	0.89	0.89	0.88	0.88	0.88	0.88	
			1.00	0.99	0.98	0.98	0.97	0.97	0.96	0.96	0.95	0.95	0.94	0.94	0.93	0.93	0.93
			N/R	N/R	N/R	N/R	N/R	N/R	N/R	N/R	N/R	N/R	N/R	N/R	N/R	N/R	N/R
		1 [25.4]	N/R	N/R	N/R	N/R	N/R	N/R	N/R	N/R	N/R	N/R	N/R	N/R	N/R	N/R	N/R
			N/R	N/R	N/R	N/R	N/R	N/R	N/R	N/R	N/R	N/R	N/R	N/R	N/R	N/R	N/R
			N/R	N/R	N/R	N/R	N/R	N/R	N/R	N/R	N/R	N/R	N/R	N/R	N/R	N/R	N/R

NOTES:
 N/R = Application not recommended.
 All calculations assume a 3/8" liquid line

Table 2 cont.

INSTALLATION



Interconnecting Tubing (cont.)

Tubing Installation

Observe the following when installing correctly sized type “L” refrigerant tubing between the condensing unit and evaporator coil:

- Check the tables on pages 18 and 19 for the correct suction line size and liquid line size.
 - **If a portion of the liquid line passes through a very hot area where liquid refrigerant can be heated to form vapor, insulating the liquid line is required.**
 - Use clean, dehydrated, sealed refrigeration-grade tubing.
 - Always keep tubing sealed until tubing is in place and connections are to be made.
 - A high-quality biflow filter drier is included with all R-410A heat pump units and must be installed in the liquid line upon unit installation.
 - When replacing an R-22 system with an R-410A system and the line set is not replaced, use a flush kit available through aftermarket stores such as Prostock.
- If tubing has been cut, make sure ends are deburred while holding in a position to prevent chips from falling into tubing. Burrs such as those caused by tubing cutters can affect performance dramatically, particularly on small liquid line sizes.
 - For best operation, keep tubing run as short as possible with a minimum number of elbows or bends.
 - Locations where the tubing will be exposed to mechanical damage should be avoided. If it is necessary to use such locations, the copper tubing should be housed to prevent damage.

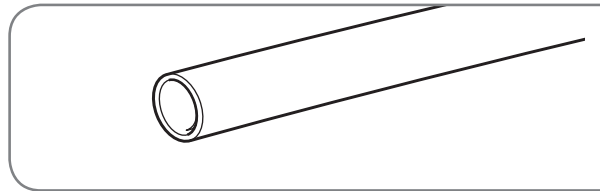



Interconnecting Tubing (cont.)

- If tubing is to be run underground, it must be run in a sealed watertight chase.
- Use care in routing tubing and do not kink or twist. Use a good tubing bender on the vapor line to prevent kinking.

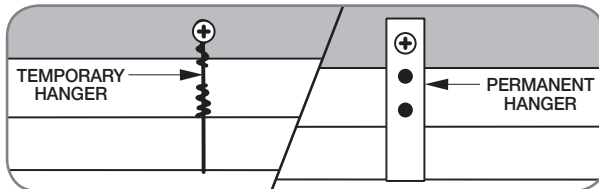

- Route the tubing using temporary hangers; then straighten the tubing and install permanent hangers. Line must be adequately supported.
- If the vapor line comes in contact with inside walls, ceiling, or flooring, the vibration of the vapor line in the heating mode will result in noise inside the structure.

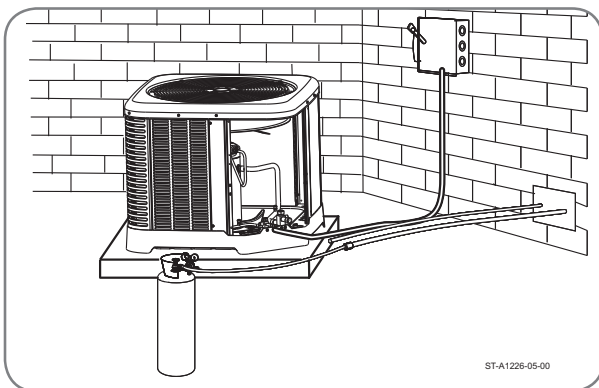

- Blow out the liquid and vapor lines with dry nitrogen before connecting to the outdoor unit and indoor coil. Any debris in the line set will end up plugging the expansion device.

Tubing Connections

Indoor coils have only a holding charge of dry nitrogen. Keep all tube ends sealed until connections are to be made.

- Use type “L” copper refrigeration tubing. Braze the connections with the following alloys:
 - copper to copper, 5% silver minimum
 - copper to steel or brass, 15% silver minimum

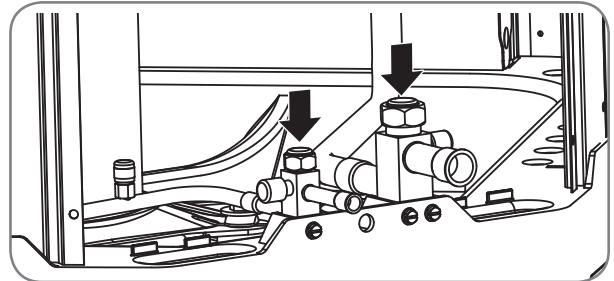

- Be certain both refrigerant shutoff valves at the outdoor unit are closed.

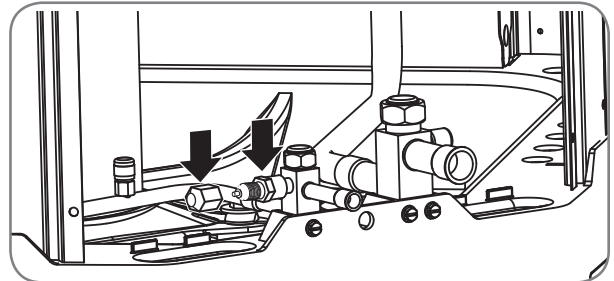

- Remove the caps and Schrader cores from the pressure ports to protect seals from heat damage. Both the Schrader valves and the service valves have seals that may be damaged by excessive heat.

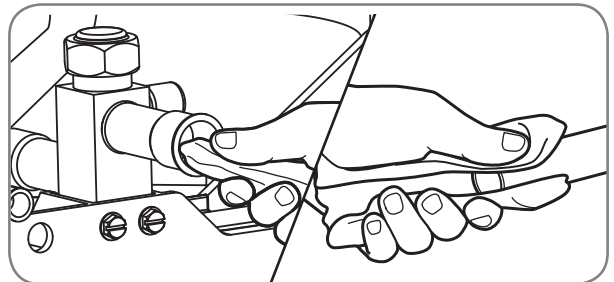

- Clean the inside of the fittings and outside of the tubing with a clean, dry cloth before soldering. Clean out debris, chips, dirt, etc., that enters tubing or service valve connections.

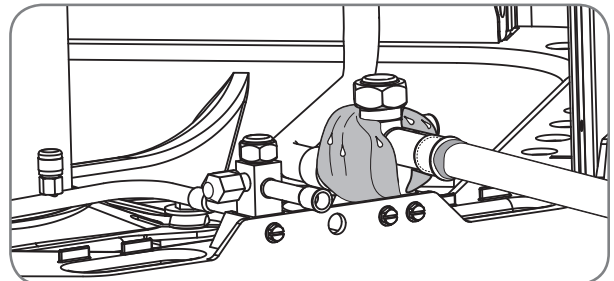

- Wrap valves with a wet rag or thermal barrier compound before applying heat.

INSTALLATION



Interconnecting Tubing (cont.)

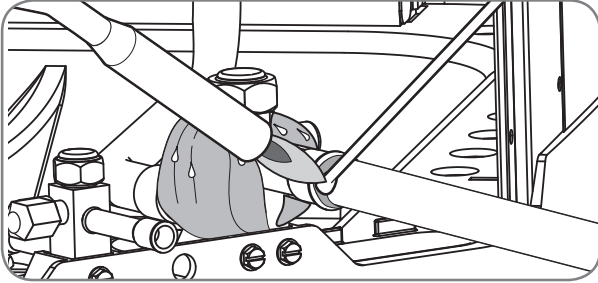

- Braze the tubing between the outdoor unit and indoor coil. Flow dry nitrogen into a pressure port and through the tubing while brazing, but do not allow pressure inside tubing which can result in leaks. Once the system is full of nitrogen, the nitrogen regulator should be turned off to avoid pressuring the system.

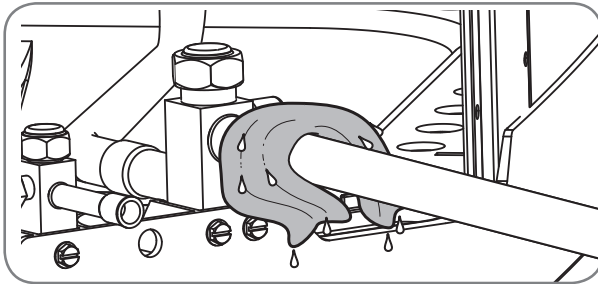

- After brazing, use an appropriate heatsink material to cool the joint.
- Reinstall the Schrader cores into both pressure ports.

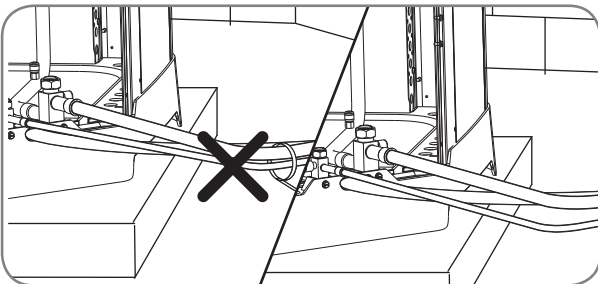

- Do not allow the vapor line and liquid line to be in contact with each other. This causes an undesirable heat transfer resulting in capacity loss and increased power consumption.

Leak Testing

Indoor coils have only a holding charge of dry nitrogen. Keep all tube ends sealed until connections are to be made.

⚠WARNING: Do not use oxygen to purge lines or pressurize system for leak test. Oxygen reacts violently with oil, which can cause an explosion resulting in severe personal injury or death.

The variable speed inverter driven heat pumps are equipped with OD EXVs and matched to ID units that are also equipped with EXVs. During shipment, vibration has been found to move the EXV stem valve to a near closed position despite being set to a fully open position in the factory. Prior to leak testing it is recommended to apply 24VAC low voltage power to the ID and outdoor units making sure there is no call for operation by disconnecting the EcoNet™ control center or two stage legacy thermostat. By doing this, each control will immediately close their respective EXVs followed immediately by opening them to the wide open position, therefore, permitting free flow of nitrogen through the system.

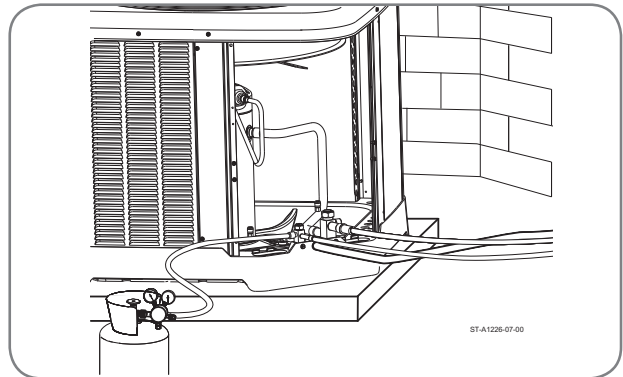

- Pressurize line set and coil through service fittings with dry nitrogen to 150 PSIG maximum. Close nitrogen tank valve, let system sit for at least 15 minutes, and check to see if the pressure has dropped. If the pressure has dropped, check for leaks at the line set braze joints with soap bubbles and repair leak as necessary. Repeat pressure test. If line set and coil hold pressure, proceed with line set and coil evacuation (see page 21).

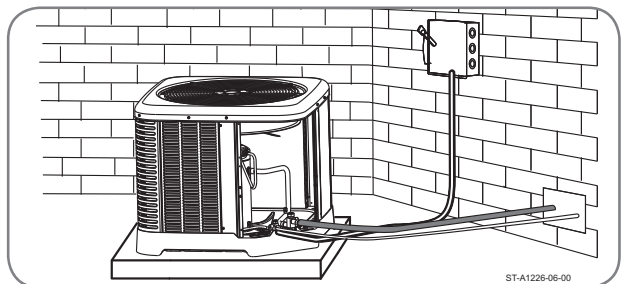

- The vapor line must be insulated for its entire length to prevent dripping (sweating) and prevent performance losses. Closed-cell foam insulation such as Armaflex and Rubatex® are satisfactory insulations for this purpose. Use 1/2" [12.7 mm] minimum insulation thickness. Additional insulation may be required for long runs.



Control Wiring

⚠WARNING: Turn off electric power at the fuse box or service panel before making any electrical connections. Also, the ground connection must be completed before making line voltage connections. Failure to do so can result in electrical shock, severe personal injury, or death.

EcoNet™ Control Communications

The EcoNet™ enabled (-)P20 series of heat pumps are designed to operate with conventional 24VAC Thermostat or an EcoNet™ communicating control center. If the (-)P20 outdoor unit is installed with a conventional 24VAC Thermostat some features and comfort settings will not be available.

Control Wiring

Running low-voltage wires in conduit with line voltage power wires is not recommended. Low-voltage wiring may be run through the insulated bushing provided in the 7/8" [19 mm] hole in the base panel, up to and attached to the pigtails from the bottom of the control box. Conduit can be run to the base panel if desired by removing the insulated bushing.

A thermostat and a 24-volt, 40 VA minimum transformer are required for the control circuit of the system. The furnace or the air handler transformer may be used if sufficient. See the wiring diagram for reference. Use "Wire Size" table on page 23 to size the 24-volt control wiring.

FIELD WIRE SIZE FOR 24-VOLT THERMOSTAT CIRCUITS

Thermostat Load (amps)	SOLID COPPER WIRE – AWG					
	3.0	16	14	12	10	10
2.5	16	14	12	10	10	10
2.0	16	14	12	10	10	10
	50	100	150	200	250	300
	[15]	[30]	[46]	[61]	[76]	[91]
	Length of Run – Feet [m] (1)					

(1) Wire length equals twice the run distance.
 NOTICE: Do not use control wiring smaller than No. 18 AWG between thermostat and outdoor unit.

EcoNet™ Control Board Communication Wiring

The four 18 AWG low-voltage control wires must be installed from the control center to the indoor unit and from the indoor unit to the outdoor unit. The wire length between the control center and indoor unit should not be greater than 100 feet [30.5 m].

The wire length between the indoor unit and outdoor unit should not be greater than 125 feet [38.1 m].

An EcoNet™ communicating HVAC system consists of these matched components:

- EcoNet™ communicating heat pump or EcoNet™ communicating condensing unit.
- EcoNet™ communicating air handler or EcoNet™ communicating furnace.
- EcoNet™ control center.

IMPORTANT: If the installed system does not meet these requirements, the system must be wired using traditional control wiring. See "Conventional 24 VAC Thermostat Control Wiring" on page 24.

Do not use phone cord to connect indoor and outdoor units. This will damage the controls.

IMPORTANT: EcoNet™ require systems continuous 18 AWG thermostat wire. The EcoNet™ Control requires four (4) control wires for unit operation:

- R 24 VAC
- C 24 VAC common
- Data wire E1 Communications
- Data wire E2 Communications

Control Center	Air Handler or Furnace Indoor	Air Conditioner or Heat Pump Outdoor
E1 -----	E1-----	E1
E2 -----	E2 -----	E2
R -----	R -----	R
C -----	C -----	C

These wires need to be connected to each device control center, indoor air handler or furnace, and outdoor unit (heat pump or AC).
 Once all devices are connected, apply the line and low voltage to the system.

When all devices are powered, the control center should detect the indoor and outdoor units within 45 seconds.

Once the system is powered, the airflow settings will be configured for all devices.

WIRING



Control Wiring (cont.)

All adjustments for airflow are made at the control center from this point. Items that can be changed are airflow trim adjustment, dehumidification set point, cooling and heating airflow by tonnage and electric heat airflow. The control center also has a wide range of fault and history information. To access any of the control center menus press the settings, status, or service icons at the bottom of the touch screen. Refer to the air handler or furnace installation manual and the communicating control center installation manual for further details on setting up the system and available adjustment options.

The communicating air handler or communicating furnace is equipped with a 24-volt, 50 VA transformer for proper system operation. See the wiring diagram below for reference.

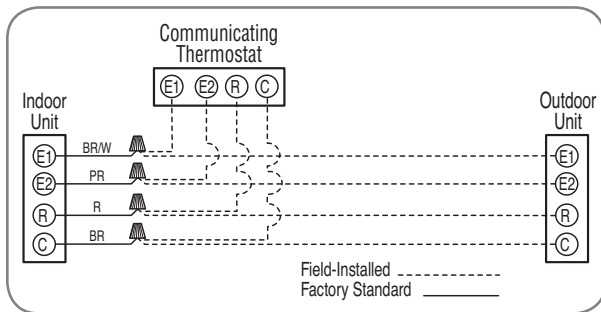

Conventional 24 VAC Thermostat Control Wiring

The (-)P20 series of heat pumps allow the installer to use conventional 24 VAC control wiring and a conventional thermostat for limited unit operation.

IMPORTANT: The preferred method of unit installation and operation is by the *EcoNet™ Communicating System*, which allows access to the fault history of the system. This diagnostic information is not available at the thermostat when the (-)P20 unit is using a conventional thermostat. See “EcoNet™ Control Board Communicating Wiring” on page 23.

Thermostat control wiring requires a minimum of six (6) wires for proper unit operation:

- R – 24 VAC
- C – 24 VAC common
- Y – First-stage operation
- Y2 – Second-stage operation
- B – Heat pump operation
- W – Defrost

Conventional 24VAC mode of Operation

When the variable speed (-)P20 outdoor unit is paired with a legacy thermostat, the unitary control will control the compressor speed based on the following logic:

If both Y2 + Y terminals are energized the compressor will operate at the maximum speed permitted by the model data at the currently operating outdoor ambient temperature.

If the Y terminal ONLY is energized the compressor will run at the lowest compressor speed for 15 minutes. After this time, if the Y terminal ONLY is energized the compressor will be commanded to an intermediate compressor speed. (NOTICE: There will be no change in ID airflow at this time.)

When the outdoor ambient temperature drops below freezing (32°F) the unitary control has a function that will allow the compressor to be driven to a higher speed than when the outdoor ambient is above freezing. This allows the unit to maintain more comfortable space conditions.

Typical Noncommunicating Thermostat Wiring Diagrams

The following figures show the typical wiring diagrams with (-)HVM air handler and (-)P20 heat pump. Cooling and heat pump airflows may need to be adjusted for homeowner comfort once the system is operational.

WIRE COLOR CODE		
BK – BLACK	GY – GRAY	W – WHITE
BR – BROWN	O – ORANGE	Y – YELLOW
BL – BLUE	PR – PURPLE	
G – GREEN	R – RED	

TYPICAL 2-STAGE THERMOSTAT: (-)P20 HEAT PUMP WITH ELECTRIC HEAT USING A TWO-STAGE THERMOSTAT WITH DEHUMIDIFICATION

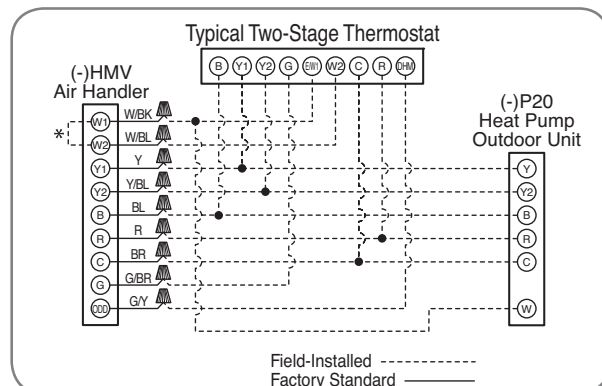



Control Wiring (cont.)

TYPICAL 2-STAGE THERMOSTAT: HEAT PUMP WITH ELECTRIC HEAT

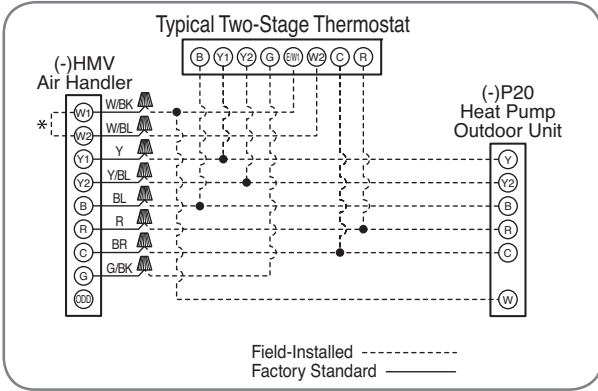

TYPICAL 2-STAGE THERMOSTAT AND DUAL-FUEL APPLICATION

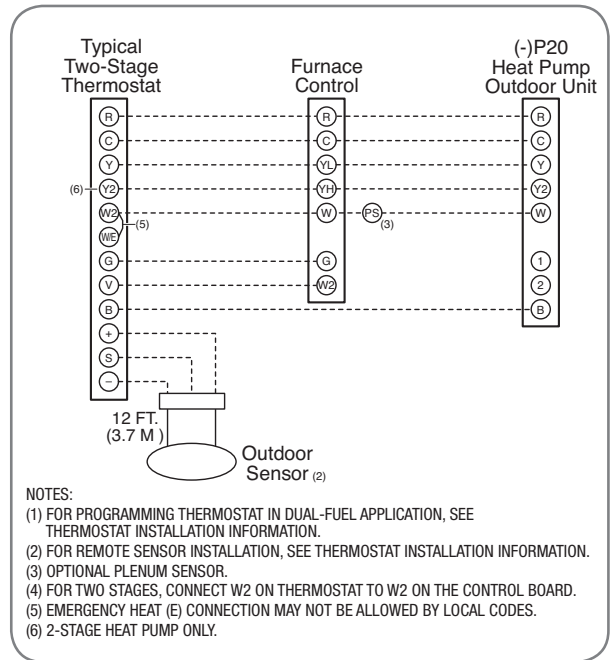

TYPICAL 2-STAGE THERMOSTAT: (-)P20 HEAT PUMP WITH ELECTRIC HEAT USING A HUMIDISTAT FOR HUMIDIFICATION

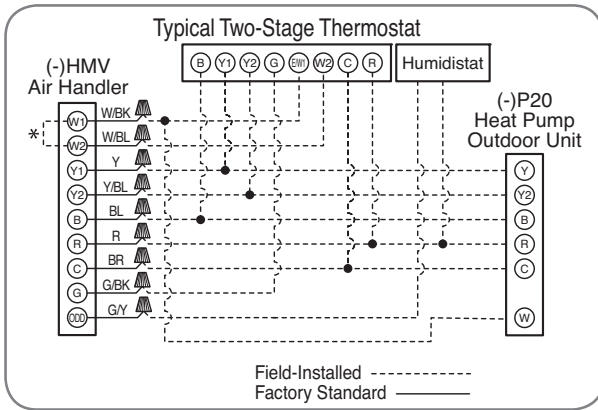

All wires are field installed.
*Add jumper between W1 and W2 for maximum temperature rise if desired.

Field wiring must comply with the National Electric Code (C.E.C. in Canada) and any applicable local code.

Power Wiring

It is important that proper electrical power from a commercial utility is available at the heat pump terminal block. Voltage ranges for operation are shown below.

VOLTAGE RANGES (60 HZ)

Nameplate Voltage	Operating Voltage Range at Copeland Maximum Load Design Conditions for Compressors
208/230 (1 Phase)	197-253

Install a branch circuit disconnect within sight of the unit and of adequate size to handle the starting current (see "Electrical Data" on page 5.)

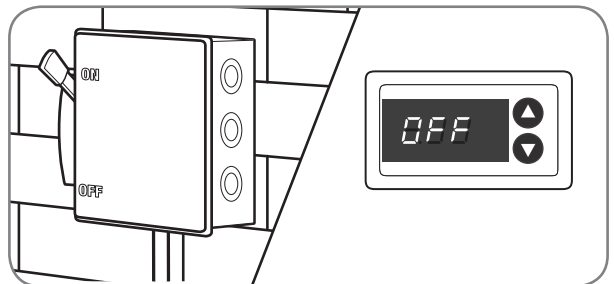

WIRING



Control Wiring (cont.)

Power wiring must be run in a rain-tight conduit. Conduit must be run through the connector panel below the access cover (see page 6) and attached to the bottom of the control box.

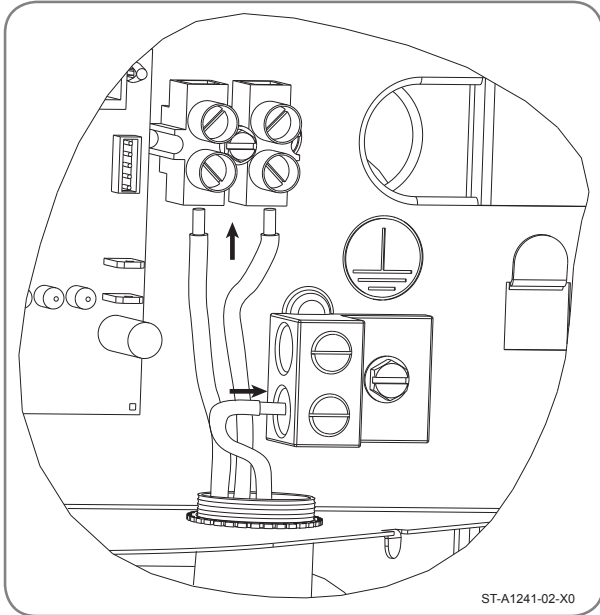

Connect power wiring to line-voltage lugs located in the outdoor heat pump unit electrical box. (See wiring diagram attached to unit access panel.)

Check all electrical connections, including factory wiring within the unit and make sure all connections are tight.

DO NOT connect aluminum field wire to the (-)P20 terminal block.

Grounding

⚠WARNING: The unit must be permanently grounded. Failure to do so can cause electrical shock resulting in severe personal injury or death.

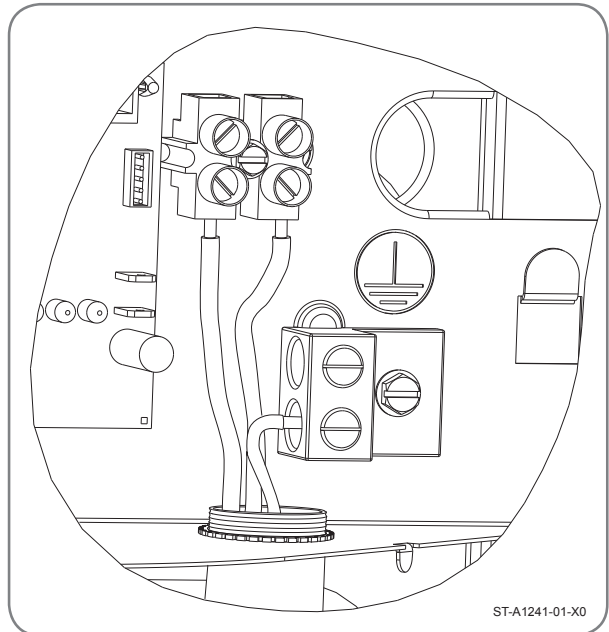

A grounding lug is provided near the line-voltage power entrance for a ground wire.



Start-Up

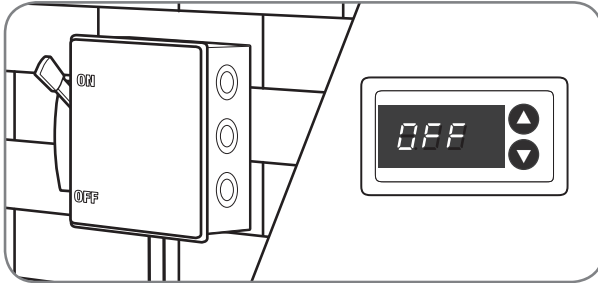

At initial start-up or after extended shutdown periods, make sure the stator heat is energized for at least 12 hours before the compressor is started. (Disconnect switch is on and wall thermostat is off.)

Connect the communicating system according to the wiring diagram on pages 24 or 25. Once all devices are connected, power up the line and low voltage to the system. When all devices are powered, the thermostat should detect the indoor and outdoor units within 45 seconds.

Even though the unit is factory-charged with Refrigerant-410A, the charge must be checked to the charge table attached to the service panel and adjusted, if required. Allow a minimum of 15 minutes of run time before analyzing charge.



Checking Airflow

The air distribution system has the greatest effect on airflow. The duct system is totally controlled by the contractor. For this reason, the contractor should use only industry-recognized procedures.

The correct air quantity is critical to air conditioning systems. Proper operation, efficiency, compressor life, and humidity control depend on the correct balance between indoor load and outdoor unit capacity. Excessive indoor airflow increases the possibility of high humidity problems. Low indoor airflow reduces total capacity and causes coil icing. Serious harm can be done to the compressor by low airflow, such as that caused by refrigerant flooding.

Heat pump systems require a specified airflow. Each ton of cooling requires between 320 and 450 cubic feet of air per minute (CFM). See the manufacturer's spec sheet for rated airflow for the system being installed.

Duct design and construction should be carefully done. System performance can be lowered dramatically through bad planning or workmanship.

The fully variable speed inverter driven systems have a dramatic variation between maximum and minimum airflow. For this reason only certain indoor air handlers and furnaces are approved as air moving matches to this product. When designing duct work this variation must be considered for optimal air delivery to all conditioned spaces. If the duct work is not adequately designed low stage airflow may not reach certain registers within the conditioned area.

Air supply diffusers must be selected and located carefully. They must be sized and positioned to deliver treated air along the perimeter of the space. If they are too small for their intended airflow, they become noisy. If they are not located properly, they cause drafts. Return air grilles must be properly sized to carry air back to the blower. If they are too small, they also cause noise.

The installers should balance the air distribution system to ensure proper quiet airflow to all rooms in the home. This ensures a comfortable living space.

These simple mathematical formulas can be used to determine the CFM in a residential or light commercial system.

Electric resistance heaters can use:

$$\text{CFM} = \frac{\text{volts} \times \text{amps} \times 3.413}{\text{SHC} \times \text{temp rise}}$$

Gas furnaces can use:

$$\text{CFM} = \frac{\text{Output Capacity in BTUH}^*}{\text{SHC} \times \text{temp rise}}$$

*Refer to furnace data plate for furnace output capacity. SHC = Sensible Heat Constant (see table below)

An air velocity meter or airflow hood can give a more accurate reading of the system CFM.

The measurement for temperature rise should be performed at the indoor coil inlet and near the outlet, but out of direct line of sight of the heater element or heat exchanger. For best results, measure air temperature at multiple points and average the measurements to obtain coil inlet and outlet temperatures.

START-UP



Evacuation and Leak Testing

ALTITUDE (FEET)	SENSIBLE HEAT CONSTANT (SHC)	ALTITUDE (FEET)	SENSIBLE HEAT CONSTANT (SHC)
Sea Level	1.08	6000	0.87
500	1.07	7000	0.84
1000	1.05	8000	0.81
2000	1.01	9000	0.78
3000	0.97	10000	0.75
4000	0.94	15000	0.61
5000	0.90	20000	0.50

Evacuation Procedure

Evacuation is the most important part of the entire service procedure. The life and efficiency of the equipment is dependent upon the thoroughness exercised by the serviceman when evacuating air and moisture from the system.

Air or nitrogen in the system causes high condensing temperatures and pressure, resulting in increased power input and nonverifiable performance.

Moisture chemically reacts with the refrigerant and oil to form corrosive hydrofluoric acid. This attacks motor windings and parts, causing breakdown.

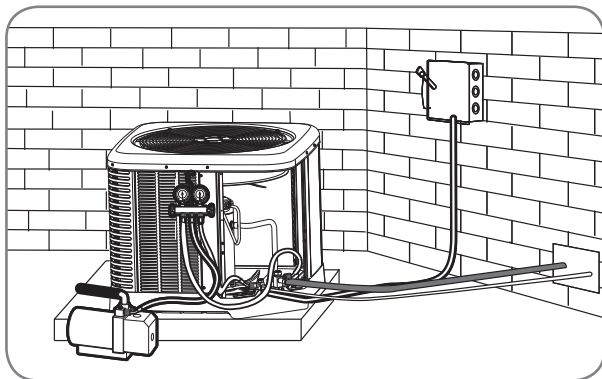

- After the system has been leak-checked and proven sealed, connect the vacuum pump and evacuate system to 500 microns and hold 500 microns or less for at least 15 minutes. The vacuum pump must be connected to both the high and low sides of the system by connecting to the two pressure ports. Use the largest size connections available since restrictive service connections may lead to false readings because of pressure drop through the fittings.

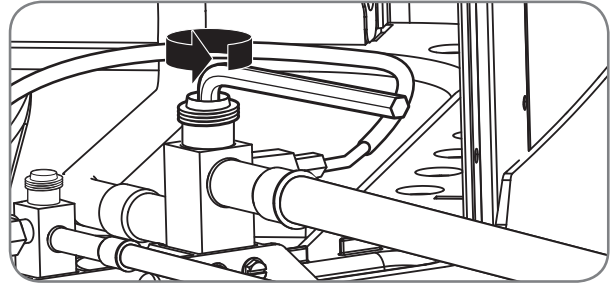

- After adequate evacuation, open both service valves by removing both brass service valve caps with an adjustable wrench. Insert a 3/16" [5 mm] or 5/16" [8 mm] hex wrench into the stem and turn counterclockwise until the wrench stops.

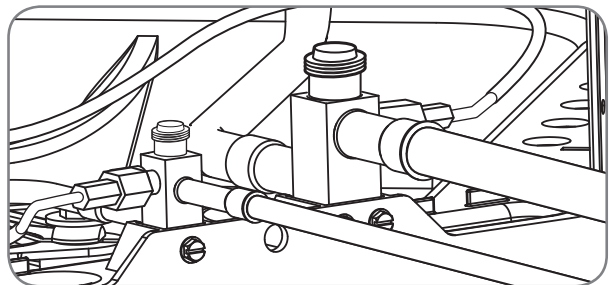

- Gauges must be connected at this point to check and adjust charge. Do not replace caps yet.

IMPORTANT: Compressors (especially scroll type) should never be used to evacuate the air conditioning system because internal electrical arcing may result in a damaged or failed compressor. Never run a scroll compressor while the system is in a vacuum or compressor failure will occur.

Final Leak Testing

After the unit has been properly evacuated and service valves opened, a halogen leak detector should be used to detect leaks in the system. All piping within the heat pump, evaporator, and interconnecting tubing should be checked for leaks. If a leak is detected, the refrigerant should be recovered before repairing the leak. The Clean Air Act prohibits releasing refrigerant into the atmosphere.



Checking Refrigerant Charge

Charge for all systems should be checked against the Charging Chart inside the access panel cover.

⚠WARNING: The top of the scroll compressor shell is hot. Touching the compressor top may result in serious personal injury.

IMPORTANT: Use factory-approved charging method as outlined on the next page to ensure proper system charge.

NOTICE: The optimum refrigerant charge for any outdoor unit matched with an indoor coil/air handler is affected by the application. Therefore, charging data has been developed to assist the field technician in optimizing the charge for all mounting configurations (UF – Upflow, DF – Downflow, LH – Left-Hand Discharge, and RH – Right-Hand Discharge). Refer to the charging chart inside the access panel cover on the unit and choose the appropriate column for the specific application being installed or serviced. New installations utilizing either an RCF indoor coil installed on a gas furnace or an RH series air handler in the downflow or horizontal right-hand discharge may require removal of refrigerant since the factory charge could result in an overcharge condition.

Charging Units With R-410A Refrigerant

⚠CAUTION: R-410A pressures are approximately 60% higher (1.6 times) than R-22 pressures. Use appropriate care when using this refrigerant. Failure to exercise care may result in equipment damage or personal injury.

Charge for all systems should be checked against the Charging Chart inside the access panel cover.

IMPORTANT: Do not operate the compressor without charge in the system.

Addition of R-410A will raise high-side pressures (liquid and discharge).

NOTICE: System maintenance is to be performed by a qualified and certified technician. The following method is used for charging systems in the cooling and heating mode. All steps listed should be performed to ensure proper charge has been set. For measuring pressures, the service valve port on the liquid valve (small valve) and the service port on the suction line between the reversing valve and compressor are to be used.

Confirm ID Airflow and Coils Are Clean

Confirm adequate indoor supply airflow prior to starting the system. See the Technical Specification Sheet for rated airflow for each ID/OD unit match. Air filter(s) and coils (indoor and outdoor) are to be clean and free of frost prior to starting the system. Supply airflow must be between 320 and 450 cfm per rated cooling ton prior to adjusting system charge. If a humidification system is installed, disengage it from operation prior to charge adjustment. *Verify that the outdoor unit is operating in high stage and the indoor air mover is delivering the high-stage airflow for this system size.* Refer to the “Checking Airflow” section of this manual for further instruction.

NOTICE: Verify system components are matched according to the outdoor unit Specification Sheet.

Measurement Device Setup

1. With an R-410A gauge set, attach the high-pressure hose to the access fitting on the liquid line (small) service valve at the OD unit.
2. Attach the low-pressure hose to the common suction port connected to the common suction line between the reversing valve and compressor.
3. Attach a temperature probe within 6" [15.2 cm] outside of the unit on the copper liquid line (small line). For more accurate measurements, clean the copper line prior to measurement and use a calibrated clamp-on temperature probe or an insulated surface thermocouple.

Charging by Weight

NOTICE: Adjust the system charge by weight for the straight length of the refrigerant line set.

For a new installation, evacuation of interconnecting tubing and indoor coil is adequate; otherwise, evacuate the entire system. Use the factory charge shown in “Electrical and Physical Data” on page 5 of these instructions or on the unit data plate. Note that the charge value includes charge required for 15 ft. [4.6 m] of standard-size interconnecting liquid line without a filter drier.

Calculate actual charge required with installed liquid line size and length using:

1/4" [6.4 mm] O.D. = .3 oz./ft. [8.5 g/.30 m]

5/16" [7.9 mm] O.D. = .4 oz./ft. [11.3 g/.30 m]

3/8" [9.5 mm] O.D. = .6 oz./ft. [17.0 g/.30 m]

1/2" [12.7 mm] O.D. = 1.2 oz./ft. [34.0 g/.30 m]

Add 6 oz. for field-installed filter drier.

START-UP



Checking Refrigerant Charge (cont.)

With an accurate scale (+/- 1 oz. [28.3 g]) or volumetric charging device, adjust charge difference between that shown on the unit data plate and that calculated for the new system installation. If the entire system has been evacuated, add the total calculated charge.

IMPORTANT: Charging by weight is not always accurate since the application can affect the optimum refrigerant charge. Charging by weight is considered a starting point ONLY. Always check the charge by using the Charging Chart and adjust as necessary. CHARGING BY LIQUID SUBCOOLING MUST BE USED FOR FINAL CHARGE ADJUSTMENT.

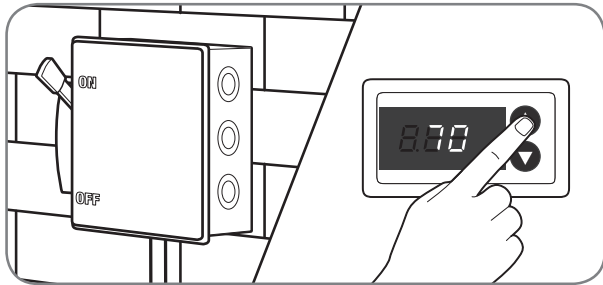

With thermostat in the “Off” position, turn on the power to the furnace or air handler and the heat pump. Start the heat pump and the furnace or air handler with the thermostat. Verify that the outdoor unit is operating in high stage and the indoor air mover is delivering the correct airflow for the system size.

IMPORTANT: R-410A is a blended refrigerant of R-32 and R-125 (50/50). These two refrigerants have different saturation curves and therefore change state at different pressures and temperatures. If charge is added to the system in the vapor state, it is possible to have a disproportionate amount of each part of the R-410A blend which will cause unstable and inefficient operation. Therefore, it is critical to add R-410A in the liquid form only!

Setting Compressor Speed for Charge Adjustment

When operating the Three Stage Variable speed system in legacy mode, it is necessary to set the compressor speed by using the push buttons located on the control board in the outdoor unit. In order to set proper charge level the compressor speed must be operating at high speed/high stage. Use the following process to set the compressor speed for charge mode:

IMPORTANT: It is necessary to make sure the ID unit is receiving a high stage operation call (Y + Y2) from the thermostat before entering this mode. Failure to do so can cause operating envelope, low pressure, or overcurrent faults causing the system to automatically shut down.

1. Depress the TEST & SW2 buttons at the same time for 5 – 8 seconds.
2. After this time the dual seven segment LEDs will show the first menu option (FC).
3. Depress the TEST button one time and the dual seven segment LEDs will show CS, which represents Compressor Speed.
4. Depress the SW2 button to enter the Compressor Speed menu.
5. After entering the Compressor Speed menu the dual seven segment will show a value of 3.

Note: If the dual seven segment LEDs show a value of 1, the VS ODU does not have a Y+Y2 signal. Check the wiring and thermostat requested stage of operation before proceeding.

6. At this point the control will send the compressor to high stage based on the outdoor dry bulb temperature and model data programed for the specific model being installed.

NOTICE: After Charge analysis is complete the Test button must be pushed to exit the Compressor Speed menu and allow the thermostat to regain control of the outdoor unit. If this is not performed the unit will respond to operational calls from the thermostat, but will not reduce compressor speed for 24 hours. This will result in reduced efficiency for the three stage system and may induce nuisance operating envelope, low pressure, or overcurrent faults.

Gross Charging by Pressures

1. Following airflow verification and charge weigh-in, run the unit for a minimum of 15 minutes prior to noting pressures and temperature.

IMPORTANT: Indoor conditions as measured at the indoor coil must be within 2°F [1.1°C] of the following during gross charge (pressure) evaluation:

Cooling Mode: 80°F [26.7°C] Dry Bulb

Heating Mode: 70°F [21.1°C] Dry Bulb

NOTICE: If the Indoor temperature is above or below this range, run the system to bring the



Checking Refrigerant Charge (cont.)

temperature down or run the electric heat/furnace to bring the temperature within this range. System pressure values provided in the Charging Chart for outdoor dry bulbs corresponding to conditions outside of these ranges are provided as reference ONLY.

- Note the Outdoor Dry Bulb Temperature, ODBB° = ____°F [____°C]. Unit charging is recommended under the following outdoor conditions ONLY:

Cooling Mode ONLY: 55°F [12.8°C] outdoor dry bulb and above

Heating Mode ONLY: Between 40°F [4.4°C] and 60°F [15.6°C] outdoor dry bulb

- Locate and note the design pressures. The correct liquid and vapor pressures are found at the intersection of the installed system and the outdoor ambient temperature on the Charging Chart located inside the access panel cover.

Liquid Pressure: = ____psig; Vapor Pressure = ____psig

NOTICE: The refrigerant pressures provided are for gross charge check ONLY. These pressure values are typical, but may vary due to application. Evaporator load (indoor coil in cooling mode/outdoor coil in heating mode) will cause pressures to deviate. Note that all systems have unique pressure curves. The variation in the slope and value is determined by the component selection for that indoor/outdoor matched system. The variation from system to system seen in the table is normal. The values listed are for the applicable indoor coil match ONLY!

- If the measured liquid pressure is below the listed requirement for the given outdoor and indoor conditions, add charge. If the measured liquid pressure is above the listed requirement for the given outdoor and indoor conditions, remove charge.

Final Charge by Subcooling

- After gross charging, note the designed subcooling value. The correct subcooling value is found at the intersection of the installed system and the outdoor ambient temperature on the Charging Chart located inside the access panel cover.

SC° from Charging Chart = ____°F [____°C].

IMPORTANT: Indoor conditions as measured at the indoor coil are required to be between 70°F [21.1°C] and 80°F [26.7°C] dry

bulb for fine-tuned unit charge adjustment. Unit charging is recommended under the following outdoor conditions ONLY:

Cooling Mode ONLY: 55°F [12.8°C] outdoor dry bulb and above

Heating Mode ONLY: Between 40°F [4.4°C] and 60°F [15.6°C] outdoor dry bulb

NOTICE: If the indoor temperature is above or below the recommended range, run the system to bring the temperature down or run the electric heat/furnace to bring the temperature up. System subcooling values provided in the Charging Chart for outdoor dry bulbs corresponding to conditions outside of the above range are provided as reference ONLY.

- Note the measured Liquid Pressure, Pliq = ____psig, as measured from the liquid (small) service valve. Use the Temperature Pressure Chart below to note the corresponding saturation temperature for R-410A at the measured liquid pressure.

Liquid Saturation Temperature, SAT° = ____°F [____°C].

- Note the liquid line temperature, Liq° = ____°F [____°C], as measured from a temperature probe located within 6" [15.2 cm] outside of the unit on the copper liquid line (small line). It is recommended to use a calibrated clamp-on temperature probe or an insulated surface thermocouple.

- Subtract the liquid line temperature from the saturation temperature to calculate subcooling. SAT° ____°F [____°C] - Liq° ____°F [____°C] = SC° ____°F [____°C]

- Adjust charge to obtain the specified subcooling value. If the measured subcool is below the listed requirement for the given outdoor and indoor conditions, add charge. If the measured subcool is above the listed requirement for the given outdoor and indoor conditions, remove charge.

Finishing Up Installation

- Disconnect pressure gauges from pressure ports; then replace the pressure port caps and tighten adequately to seal caps. **Do not overtighten.**
- Replace the service valve caps finger-tight and then tighten with an open-end wrench adequately to seal caps. **Do not overtighten.**

START-UP



Checking Refrigerant Charge (cont.)

- Replace control box cover and service panel and install screws to secure service panel.
- Restore power to unit at disconnect if required.
- Configure indoor thermostat per the thermostat installation instructions and set thermostat to desired mode and temperature.

NOTICE: Systems should not be fine-tune charged below 40°F [4.4°C] outdoor dry bulb.

IMPORTANT: Excessive use of elbows in the refrigerant line set can produce excessive pressure drop. Follow industry best practices for installation. Installation and commissioning of this equipment is to be performed by trained and qualified HVAC professionals. For technical assistance, contact your Distributor Service Coordinator.

TEMPERATURE PRESSURE CHART							
SATURATION TEMP (Deg. F) [Deg. C]	R-410A PSIG	SATURATION TEMP (Deg. F) [Deg. C]	R-410A PSIG	SATURATION TEMP (Deg. F) [Deg. C]	R-410A PSIG	SATURATION TEMP (Deg. F) [Deg. C]	R-410A PSIG
-150 [-101]	–	-30 [-34]	17.9	35 [2]	107.5	100 [38]	317.4
-140 [-96]	–	-25 [-32]	22.0	40 [4]	118.5	105 [41]	340.6
-130 [-90]	–	-20 [-29]	26.4	45 [7]	130.2	110 [43]	365.1
-120 [-84]	–	-15 [-26]	31.3	50 [10]	142.7	115 [46]	390.9
-110 [-79]	–	-10 [-23]	36.5	55 [13]	156.0	120 [49]	418.0
-100 [-73]	–	-5 [-21]	42.2	60 [16]	170.1	125 [52]	446.5
-90 [-68]	–	0 [-18]	48.4	65 [18]	185.1	130 [54]	476.5
-80 [-62]	–	5 [-15]	55.1	70 [21]	201.0	135 [57]	508.0
-70 [-57]	–	10 [-12]	62.4	75 [24]	217.8	140 [60]	541.2
-60 [-51]	0.4	15 [-9]	70.2	80 [27]	235.6	145 [63]	576.0
-50 [-46]	5.1	20 [-7]	78.5	85 [29]	254.5	150 [66]	612.8
-40 [-40]	10.9	25 [-4]	87.5	90 [32]	274.3		
-35 [-37]	14.2	30 [-1]	97.2	95 [35]	295.3		

COMPONENTS AND CONTROLS



Compressor Stator Heat (CSH)

CSH is standard on these models due to refrigerant migration during the off cycle that can result in a noisy start-up and compressor damage.

Stator Heat Operation:

Supplemental stator heat is required to prevent refrigerant migration in systems with relatively high system refrigerant charges.

Summary of operation:

- Stator heat is off whenever the compressor is running.

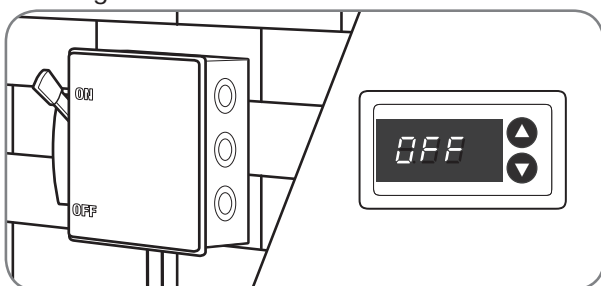

At initial start-up or after extended shutdown periods the control board will automatically keep the system from operating if a flooded compressor condition is sensed.

Under specific conditions, the refrigerant in the system can condense to a liquid and collect in the sump of the compressor when the unit is not running. This will result in the compressor pumping liquid instead of gas on the next startup. Noisy startup and potential compressor damage can occur. To prevent this condition, an internal heat source is used to keep the compressor temperature elevated. The compressor temperature shall be checked in the OFF cycle for the proper temperature range.

If heat is required the control will energize the internal heater. Once predetermined temperature has been reached the control will de-energize the heater.

Note: Compressor stator heat may only operate when the outdoor ambient temperature is less than 45°F. Upon initial install at temperatures less than this, the stator heat will keep the compressor from operating until the compressor shell is greater than 50°F.



High- and Low-Pressure Controls (HPC and LPC)

These controls keep the compressor from operating in pressure ranges which can cause damage to the compressor. Both controls are in the low-voltage control circuit.

The high-pressure control (HPC) is an automatic-reset which opens near 610 PSIG and closes near 420 PSIG.

The (-)P20 EcoNet™ enabled three stage variable speed heat pumps are equipped with a pressure transducer for low pressure control, diagnostic, and refrigerant charging purposes. Algorithms exist to detect low/high refrigerant levels, and detect/prevent unreliable compressor operation.

The control will only indicate a low pressure condition when a call for heat or cool is made.

A low pressure condition will be declared per the following table:

Cooling Low Pressure (No Operation)	Cooling Low Pressure (Operation)	Heating Low Pressure (No Operation)	Heating Low Pressure (Operation)
< 50psig	≥ 95psig	< 15psig	≥ 40psig

In heating mode, during the first 2 minutes of operation for each call for space heating the low pressure value will be ignored.

The control will respond when the pressure is beyond the NO OPERATION levels as follows:

- Command the compressor to zero (0) RPM.
- EXV to follow the shutdown control sequence by completely closing for 5 minutes or until the call for compressor operation returns whichever comes first, before opening to a wide open position.
- The outdoor fan will remain operating for the compressor off delay (5min).
- Display the appropriate error code on the dual seven segment LED and send an error status to the control center when operating with the EcoNet™ control center.
- If a demand persists after the delay and the pressure has reached the operation level, then operation will be resumed. The seven segment display error code will be cleared and the unitary control will communicate the cleared error to the control center when operating in communicating mode.

COMPONENTS AND CONTROLS



High- and Low-Pressure Controls (HPC and LPC) (cont.)

- If a demand persists after the delay but the suction pressure has not recovered, the outdoor fan will be turned off. If the pressure recovers any time after the delay then compressor operation will resume.
- If a pressure drops below the NO-operation level 3 consecutive times during a single call for operation, the unitary control will keep the system from conditioning the space, and the appropriate error code will be displayed at the outdoor unit. The unitary control will also communicate the lockout fault to the EcoNet™ control center when used in communicating mode.
- The suction pressure transducer (SPT) faults will be recorded in historical data.
- During defrost the LP fault will be ignored. After the system has returned to heating mode LP monitoring will commence.

NOTICE: HPC and LPC are monitored by the EcoNet™ System.



Accumulator

All (-)P20 EcoNet™ enabled variable speed heat pumps are equipped with accumulators for the purpose of managing possible refrigerant

flood back issues that may occur at abnormal environmental conditions.



Outdoor Fan Motors

All (-)P20 heat pumps are equipped with fully variable outdoor fans controlled with a pulse width modulated signal (PWM) provided by the variable

speed unitary control. The fan speed is selected to optimize the heat pump performance based on compressor speed.



Outdoor Fan Blades

All (-)P20 heat pumps are equipped with swept fan blade designs. These fan blades allow for a reduced amount of vortex shedding over that of a standard paddle blade. The design also provides optimal scfm/watt efficiency which permit the (-)P20 models to operate at a low sound level while delivering exceptional performance.

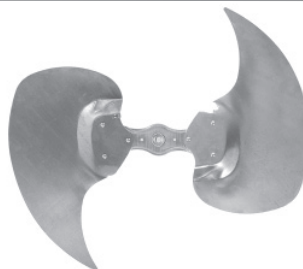

Electronic Expansion

Electronic Expansion

The (-)P20 EcoNet™ enabled variable speed heat pumps are equipped with an electronic refrigerant expansion device otherwise known as EXVs. One of the biggest advantages of an EXV is the control can intelligently change the EXV position based on system demands other than just suction line temperature. By the measurement of the suction pressure via the vapor line pressure transducer and the alternate suction line thermistor, the EcoNet™ enabled (-)P20 unitary control calculates the suction superheat at the outdoor coil. This calculation permits the unitary control to make decisions for when to open and close the electronic expansion valve for the purpose of maintaining a predetermined suction superheat. The electronic valve is equipped with a 4-pole

removable external stator for optimal serviceability. These valves also have an internal check valve to provide cooling mode compatibility. When operating in cooling mode, the unitary control will open the electronic valve completely to permit the check valve to operate and maximize reverse refrigerant flow.



COMPONENTS AND CONTROLS



Alternate Section Line Thermistor (OST)

The EcoNet™ enabled (-)P20 variable speed heat pumps are equipped with an alternate suction line thermistor for the purposes of measuring suction gas temperature during heating mode. The measured temperature is paired with the saturated suction temperature and used by the unitary control to calculate superheat and adjust the outdoor EXV.

IMPORTANT: The clamp on the vapor line thermistor securely attaches to the alternate suction line at the 10 to 2 o'clock position with a corrosion resistant stainless steel clip. Insulation is factory installed over the alternate suction line thermistor and alternate suction line. This thermistor is provided with the coil thermistor as a single harness.

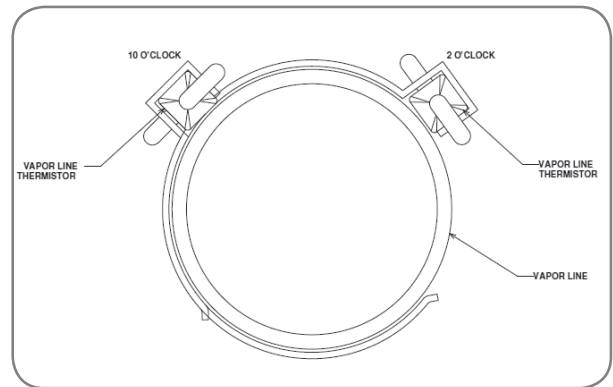

Coil Thermistor (EVAPIN)

The EcoNet™ enabled (-)P20 variable speed heat pumps are equipped with a coil sensor that is used for the purposes of identifying defrost parameters and low ambient cooling operational conditions. This thermistor is provided with the alternate suction line thermistor as a single harness.

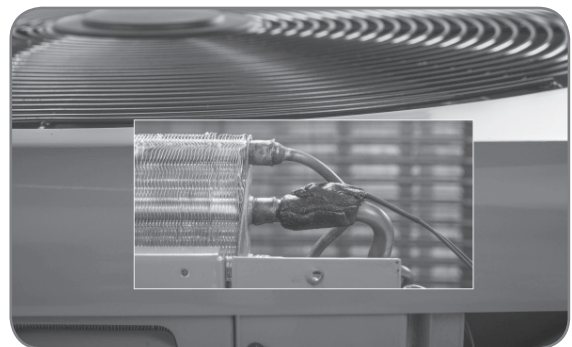

Compressor Sump Thermistor (CPT)

The EcoNet™ enabled (-)P20 variable speed heat pumps utilize a sump thermistor to monitor the condition of the lower bearing in the compressor sump. As environmental variables change it is possible to have liquid refrigerant flood back to the compressor. Although the (-)P20 designs have been specified to minimize this from happening, occasions will occur where this may happen. During these times the EcoNet™ unitary control has been programmed with algorithms to slow the compressor speed until the liquid refrigerant exits the compressor shell.

The sump thermistor is also used to identify when compressor stator heat is needed during off cycles. See the compressor stator heat section for more details on this operation.



COMPONENTS AND CONTROLS



Suction Pressure Transducer (SPT)

The EcoNet™ enabled (-)P20 variable speed heat pumps are equipped with a 5vdc powered suction line pressure transducer. This device has an internal diaphragm that changes the resistance in line with the input voltage to return a modified voltage that is scaled from 0.5 to 4.5vdc. This range is linearly proportional to an absolute pressure range of 0 to 300psia.

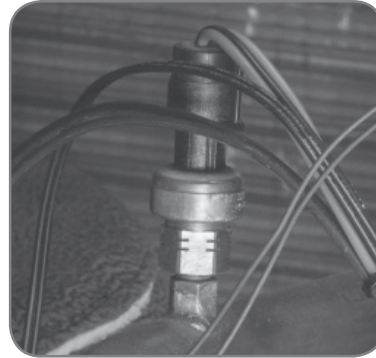

Discharge Line Thermistor

The EcoNet™ enabled (-)P20 variable speed heat pumps are equipped with a discharge line thermistor. This thermistor is used to measure the discharge temperature at the compressor for the purposes of consistently operating the compressor within its designated operating envelope. At extreme environmental conditions the discharge temperature can rise to temperatures that may be unsafe for compressor operation. At these times the unitary control will automatically slow the compressor speed until a more reliable operating condition is obtained. Once this is done the unitary control will continually attempt to raise the compressor speed to maximize performance and conditioned space comfort.



NOTICE: This sensor is connected directly to the power inverter.



Power Inverter Compressor Controls

The EcoNet™ enabled (-)P20 variable speed heat pumps are equipped with power inverter technology to vary the compressor speeds from 900RPM up to 7000RPM for maximum conditioned space comfort. Each inverter takes high voltage single phase incoming power and converts it to high voltage DC power. The output of each inverter is a simulated 3 phase AC signal that switches at just over 6500hz between each leg of the 3 phase compressor motor. There are 4 different power inverters (3.7kW, 5.5kW, 8.0kW max rating and 8.0kW with back spin protection) that have been selected, designed, and qualified to meet the most extreme of conditions to insure continuous and reliable system operation. Each inverter is programmed to monitor compressor power consumption, motor torque, input current, input voltage, discharge pressure, and discharge temperature. When the inverter identifies a specific condition that may create a possible reliability risk it will automatically reduce the compressor speed until a more reliable operating condition is

obtained. Once this is done

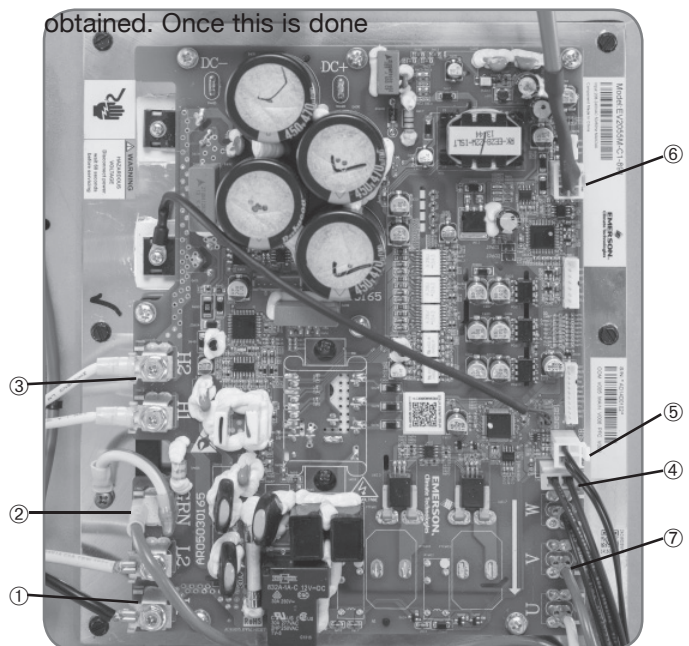

COMPONENTS AND CONTROLS



Power Inverter Compressor Controls (cont.)

the power inverter will continually attempt to raise the compressor speed to maximize performance and conditioned space comfort.

1. High voltage input (L1 – Black; L2 – Yellow)
2. Ground connection
3. Choke Connection
4. High Pressure control connection (HPS) – with automatic reset
5. Discharge line thermistor connection (Sensor)
6. Modbus communication connections (RS485)
7. Compressor connections (W-Black; V-Red; U-Yellow)



Choke/Inductor

For each power inverter used in the (-)P20 system there is a paired choke/inductor. The choke is designed as a low pass filter and increase inductance. By doing this the input power can be more efficiently used by the inverter and compressor.

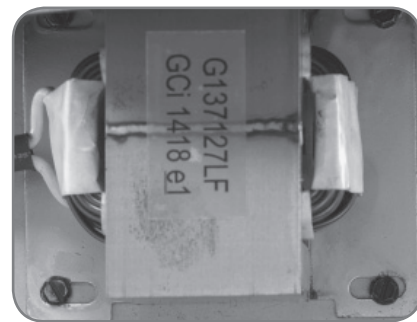

Filter & Ferrite Rings

For the (-)P20 model line there are 3 ferrite rings and one filter applied on all models. The ferrite rings are similar in purpose to the choke, whereas they create an inductive field around the assembled wires, but they do not filter the signals. The ferrite rings are applied only for the purpose of keeping the high voltage lines from cross contaminating one another and thereby creating

unexpected operation and electromagnetic interference. The single filter has been applied to eliminate high frequency “noise” from the incoming power line thereby making it more efficient for the inverter to convert the incoming high voltage single phase AC power into high voltage 3 phase DC power.

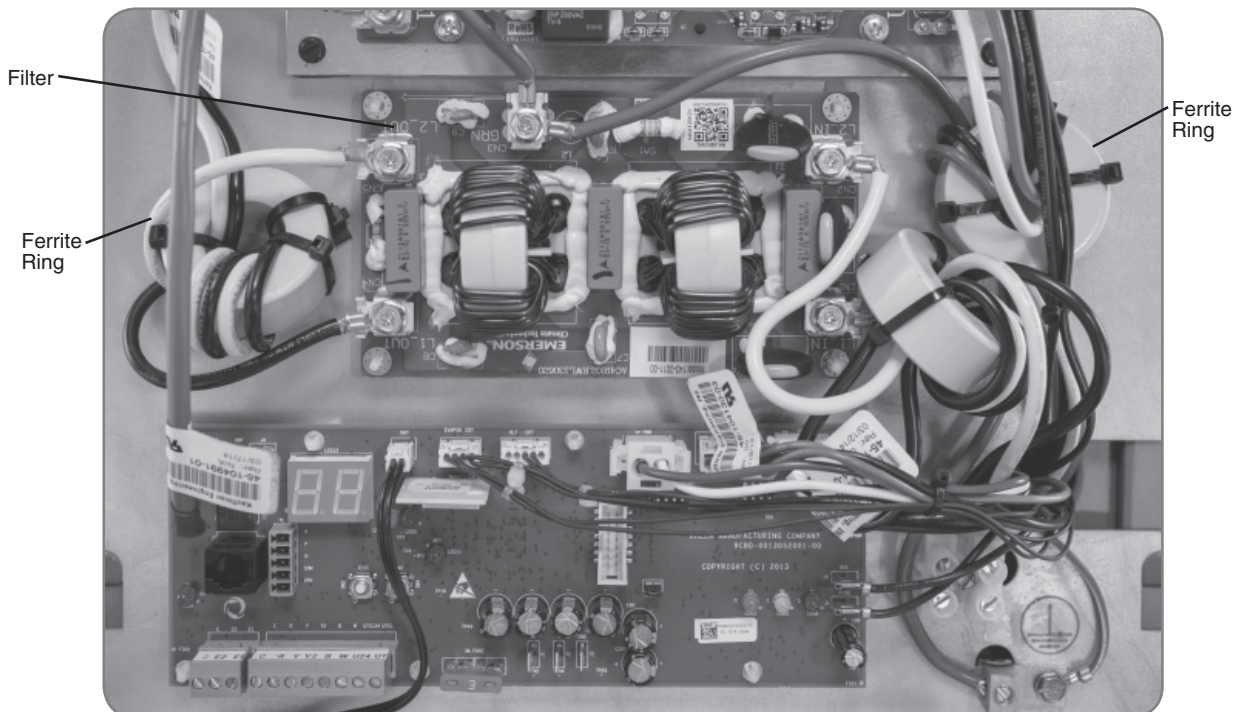

COMPONENTS AND CONTROLS



EcoNet™ Variable Speed Unitary Control

The EcoNet™ system is the next generation of the integrated compressor control (ICC) and is an integral part of the EcoNet™ communication network

1. Thermostat Terminals
2. Communication wire terminals
3. Modbus unitary inverter communication connection
4. Outdoor PSC Fan relay connections
5. Outdoor ambient thermistor connection
6. Coil Sensor (EVAPIN) and Alternate Suction (OST) thermistor connections
7. Liquid line (OLT – for future use) and compressor sump (CPT) connections
8. Outdoor ECM fan PWM output connection
9. Suction pressure transducer (SPT) connection
10. Liquid pressure transducer (LPT) connection
11. Electronic expansion valve connection
12. Reversing Valve Connections
13. 3 Amp fuse
14. Test and SW2 Button
15. Communications LEDs (ET – EcoNet™ communication is transmitting; RT – EcoNet™ communication is receiving)
16. Memory card connection
17. Dual seven segment LED – Displays status, diagnostic codes, fault recall, compressor speed, superheat, and defrost menus
18. Dip Switches (Defrost [DFST] and EXV [EXV] offset)
19. Dip Switches (EXV [1600/500] selection)
20. EXV Operational Lights (Green – EXV is opening; Amber - EXV is closing)

17. Dual seven segment LED – Displays status, diagnostic codes, fault recall, compressor speed, superheat, and defrost menus
18. Dip Switches (Defrost [DFST] and EXV [EXV] offset)
19. Dip Switches (EXV [1600/500] selection)
20. EXV Operational Lights (Green – EXV is opening; Amber - EXV is closing)

CAUTION: UNIT MAY START SUDDENLY AND WITHOUT WARNING.

TEST and SW2 Buttons

TEST and SW2 buttons are used to enter the following menus and modes:

- Test mode
- Forced Defrost
- Fault Code Recall Menu
- Compressor Speed Menu
- Superheat Menu
- Forced 6 hour defrost menu

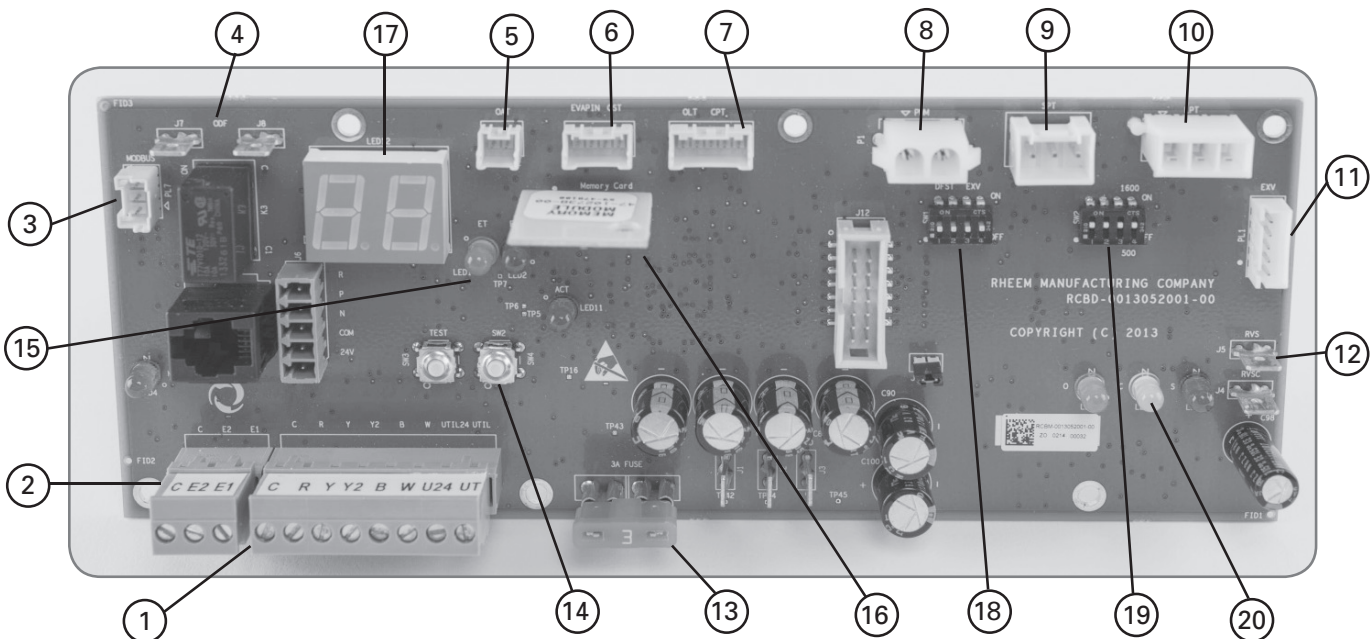
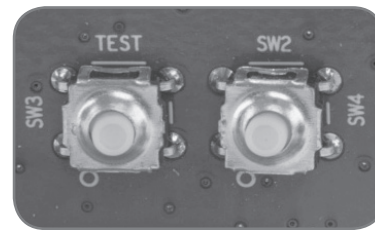

COMPONENTS AND CONTROLS



EcoNet™ Variable Speed Unitary Control (cont.)



Memory Card

- The memory card stores all unit information.
- The unit information is called model data.
- The model data is all the information needed for proper unit operation.

Factory Programmed Superheat

The EcoNet™ unitary control is pre-programmed with the optimum superheat setting for each outdoor unit. The following settings will be assigned from the factory and active at time of install.

Outdoor Unit	Superheat (°F)	Dipswitch Settings	
		1	2
(-)P2024	6	Off	Off
(-)P2036	6	Off	Off
(-)P2048	6	Off	Off
(-)P2060	6	Off	Off

Superheat offset DIP Switch Settings

Although the factory programmed superheat set point is considered to be the most efficient set point for each unit, installation conditions can drastically effect the measurement of superheat by the unitary control. For this reason the following dip switch settings have been provided to enable flexibility for various installation conditions.

Superheat Offset Selection Profile	Off Set from Programmed Setting (°F)
A	0
B	-4
C	-2
D	+2

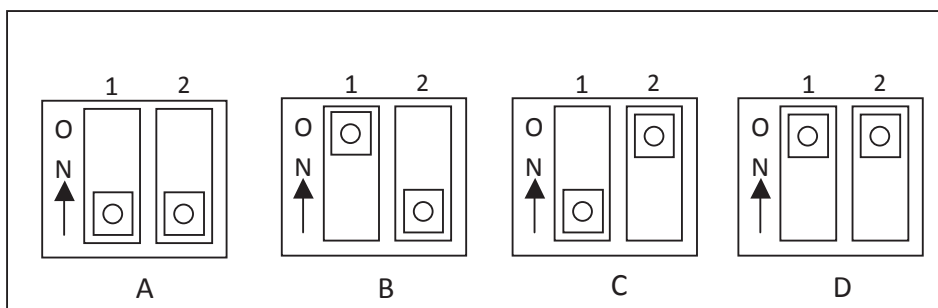

COMPONENTS AND CONTROLS



EcoNet™ Variable Speed Unitary Control

Installation Verification

- 24 VAC power on R and C must be present at the ICC for it to operate.
- Line voltage must be present at the ICC for the compressor and the outdoor fan to operate.
- The ICC displays a “0” for standby mode. Standby mode indicates line voltage and 24 VAC are present at the ICC and there is not a call for unit operation from the serial communicating thermostat.



Zero (0) displayed. The unit is in standby.

Call for Compressor Operation

- If a call for compressor operation is received by the ICC (high-stage/low-stage cooling or high-stage/low-stage heating).
- The ICC has an on/off fan delay of one (1) second for each stage of heating or cooling.
- The ICC ignores the low-pressure control for the first 90 seconds of compressor operation.
- On heat pumps, the ICC ignores the LPC during the defrost cycle.
- The dual 7-segment LEDs display five (5) operational status codes:

- 1) **Low-Stage Cooling Operation** – When the ICC receives a call for first-stage cooling operation, a lower-case “c” is displayed on the dual 7-segment LEDs.



Lower-case “c” indicates Low-stage cooling operation.

- 2) **High-Stage Cooling Operation** – When the ICC receives a call for second-stage cooling operation, an upper-case “C” is displayed on the dual 7-segment LEDs.



Upper-case “C” indicates high-stage cooling operation.

- 3) **Low-Stage Heating Operation** – When the ICC receives a call for first-stage heating operation, “h” is displayed on the dual 7-segment LEDs.



Lower-case “h” indicates Low-stage heating operation.

- 4) **High-Stage Heating Operation** – When the ICC receives a call for second-stage heating operation, an upper-case “H” is displayed on the dual 7-segment LEDs.



Upper-case “H” indicates high-stage heating operation.

- 5) **Defrost Operation** – When the ICC starts a defrost cycle, a lower-case “d” is displayed on the dual 7-segment LEDs.



Lower-case “d” indicates defrost operation (in heating mode).

4-Minute Anti-Short-Cycle Timer

- The ICC has a built-in 4-minute time delay between compressor operations to protect the compressor against short cycling. The dual 7-segment LEDs will flash “c,” “C,” “h,” or “H” while the short-cycle timer is active and a call for unit operation is received.



Flashing lower-case “c”
A call for low-stage cooling has been received.



Flashing high-case “C”
A call for low-stage cooling has been received.



Flashing lower-case “h”
A call for low-stage heating has been received.



Flashing upper-case “H”
A call for high-stage heating has been received.

When a call for compressor operation is present, the 4-minute time delay can be bypassed by pressing the TEST button for 1 second and releasing. The compressor will begin operation and the dual 7-segment LEDs will stop flashing.

30-Second Minimum Run Timer

- The ICC has a built-in 30-second minimum unit run time. If a call for compressor operation is received by the ICC and the call is removed, the compressor will continue to operate for 30 seconds. The dual 7-segment LEDs will flash “c,” “C,” “h,” or “H” while the minimum run timer is active.

COMPONENTS AND CONTROLS



EcoNet™ Variable Speed Unitary Control (cont.)

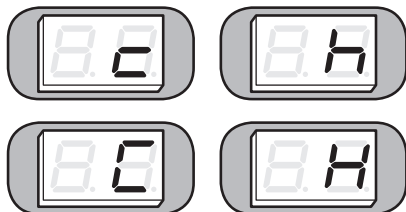

1-Second Compressor/Fan Delay

- The ICC starts/stops the outdoor fan one (1) second after the start/stop of the compressor upon a call for compressor operation to minimize current inrush and/or voltage drop.

Compressor Operation

The (-)P20 series of EcoNet™ compatible outdoor heat pumps are equipped with legacy and communicating modes of operation. To maximize the performance and efficiency of these systems it is highly recommended to operate the (-)P20 systems in communicating mode. It is possible where communication signals are corrupted resulting in an application that may only utilize 24VAC legacy thermostat control. In these situations a 2 stage legacy thermostat is required.

Communicating Mode: Compressor Operation

When the (-)P20 series of outdoor heat pumps are installed with the EcoNet™ communicating control center the ICC will respond to building capacity demand. This demand is converted by the ICC into compressor RPMs which can vary in 1 RPM increments from a minimum speed to a maximum speed as defined by the outdoor unit model data. The magnitude of instantaneous compressor speed change will depend on the change in building load measured by the control center. Through this process the (-)P20 heat pumps only provide to the building the required amount of conditioning for optimal comfort and efficiency.

Legacy Mode: Low/Intermediate Speed Compressor Operation

When the (-)P20 series of outdoor heat pumps are installed in legacy mode with a 2 stage thermostat the low and intermediate compressor speed operation defaults to a time based logic. In this situation when a Y ONLY 24VAC signal is present the ICC requests the inverter to run the minimum speed as defined by the model data for 15 minutes. After this time has passed and the Y ONLY 24VAC signal remains present the ICC will automatically increase the compressor speed to the intermediate speed as set by the model data. The ICC will keep the compressor at this speed until the call for compressor operation is removed or a Y + Y2 signal is received from the legacy 2 stage thermostat.

IMPORTANT: This logic only occurs for legacy installs. All compressor speeds will be requested discretely when the (-)P20 heat pump is operating in communicating mode with the Rheem Control Center.

Indoor Airflow

Similar to the compressor operation outlined in the prior section, the Indoor airflow will be set by the control center based on the building load percentage. While operating in communicating mode after the ICC set the compressor speed it will transmit the necessary indoor airflow as identified by the outdoor unit model data to the control center where it will relay the information to the indoor air mover. When the (-)P20 heat pump is matched with a constant CFM indoor air handler or furnace, the ICC will request discrete airflow for each compressor speed. Prior to the control center sending the requested air flow to the indoor air mover it will apply any offset or corrections as identified in the control center installer menu.

Outdoor Fan Control

The ICC can accommodate electronically commutated (ECM) or permanent start capacitor (PSC) outdoor fan motors. If the outdoor unit is equipped with a PSC motor, the model data will set the ICC firmware to energize the PSC fan relay when the outdoor fan motor is required to operate. If the outdoor unit is enabled with an ECM outdoor fan motor, the model data will set the ICC firmware to utilize a pulse width modulated signal from the PWM terminal to control the outdoor fan motor. This output is a 80Hz pulse-width-modulated signal that can be varied from 0 to 100% duty cycle in 1% increments.

Secondary parameters such as rpm blocking ranges, startup mandatory ranges, shutdown ranges, fault induced rpm reduction, and low ambient cooling ranges can also impact the final calculated RPM value.

Oil Circulation

During operation it is possible that an excess of refrigerant could be returned to the compressor causing a flooded compressor sump condition. If this event occurs the compressor reliability and/or life could be drastically reduced. For this reason the (-)P20 heat pumps are equipped with a sump thermistor (CPT) to monitor the sump temperature of the compressor. The ICC will evaluate the differential between the compressor sump temperature and the saturated suction temperature (aka sump superheat). If the ICC concludes that

COMPONENTS AND CONTROLS



EcoNet™ Variable Speed Unitary Control (cont.)

the sump superheat is below the design limit, the ICC will request for the inverter to reduce the compressor RPM incrementally until the differential value has sufficiently increased. After the minimum sump superheat is obtained the ICC will request for the inverter to raise the compressor RPM a rate of no greater than 2000RPM per minute. During the ramp up period the ICC will continuously evaluate the sump superheat temperature and hold the compressor speed to a limit resulting in acceptable sump superheat.

Discharge Temperature (DLT) Fold back Protection

If the discharge line temperature, as read from the Modbus communication between the ICC and the inverter, reaches 235°F the ICC will request the inverter to reduce the compressor RPM incrementally until the discharge line temperature (DLT) reduces to 200°F. After the DLT reaches this level, the compressor RPM will be set to rise at a rate of no greater than 500RPM per minute until the compressor equals the requested speed from the requested capacity. During the ramp period the discharge line temperature will continue to be monitored.

Low Ambient Cooling

In some installations, a requirement exists for cooling a space when the outdoor ambient is below the normal range (<55°F), such as a computer room or other enclosed areas where a large heat load exists that must be kept cool. Low ambient cooling is a special cooling mode that allows the unit to provide cooling when the outdoor temperature is below 55°F. When necessary, the outdoor fan is cycled off to maintain condensing pressure and temperature in the system at an acceptable level.

Menu Structure

The (-)P20 product line is equipped with a dual 7-segment LED display and two push buttons (SW2 and TEST). The display and push buttons work together to allow the technician access to fault recall, compressor speed locking, and current SH measurement (heating only).

The following process can be used to access any of these menus:

- Press the SW2 and TEST buttons for 5-8 seconds.
- After this time the dual seven segment LEDs will show the first menu option (FC).
- To enter a menu, depress the SW2 button
- To toggle to the next menu depress the test button.

- No action for 5 seconds in the root menu structure will return the control to normal operation.

Menu Definition:

FC (Fault Codes)

CS (Compressor Speeds)

- 3 (MAXIMUM Speed)
- 2 (INTSPEED Speed)
- 1 (MINIMUM Speed)

SH (Superheat Measurement)

- The display is to show the following options:
- HI = Superheat is $\geq +5^\circ\text{F}$ away from SH_SP
- hl = Superheat is between $+5^\circ$ and 1.5°F away from SH_SP
- 00 = Superheat is between $+1.5^\circ\text{F}$ and -1.5°F away from SH_SP
- lo = Superheat is between -1.5°F and -5°F away from SH_SP
- LO = Superheat is $\leq -5^\circ\text{F}$ away from SH_SP.

dF (Defrost Mode)

- 6 – Forced 6 hour defrost. When this mode is selected the ICC will begin a 9 hour timer. During this time defrosts will be limited to 6 hour intervals between occurrences.

Key:

FC = Fault Codes – by selecting this menu the control will list the stored numerical fault codes in order of sequence by which they were stored. Depressing the SW2 button while a fault code is shown will increment to the next fault. Depressing the TEST button will force the control back to the main menu.

CS = Compressor Speed – For this selection menu to initiate the requested compressor speed, there must be an active call for compressor operation, the compressor must be operating, and the selection must be static for 5 seconds. The Compressor Start and Run, and Compressor Shut down algorithms will be used to obtain the requested compressor speed.

IMPORTANT: This mode should be manually exited. If this menu is not exited manually the ICC will wait 24 hours before returning to normal operation. During this time the ICC will only request the selected compressor speed.

Demand Defrost

The integrated compressor control (ICC) has a demand defrost algorithm so a separate defrost control is not needed. The ICC monitors the Outdoor Ambient Temperature (OAT) and Outdoor

COMPONENTS AND CONTROLS



EcoNet™ Variable Speed Unitary Control (cont.)

Coil Temperature (EVAPIN) to determine when a defrost cycle is required.

Defrost Initiation

A defrost will be initiated when these three conditions are satisfied:

- 1) The outdoor coil temperature is below 35°F [1.7°C].
- 2) The compressor has operated for at least 34 minutes with the outdoor coil temperature below 35°F [1.7°C].
- 3) The defrost algorithm determines a defrost is required.

When all the defrost initiation conditions have been met, the following sequence will occur:

- The ICC will request for the inverter to change the compressor speed to the predetermined reversing valve switching speed.
- The compressor will hold the reversing valve switching speed for a noise abatement period (30 sec).
- When the noise abatement period is concluded the reversing valve will be de-energized.
- The outdoor EXV will be opened to the maximum step permissible based on the unit model data.
- The ICC will energize the auxiliary heat (W).
- Send the status of defrost initiate to the UI when in communicating mode. The system user interface will energize the auxiliary heat.
- The outdoor fan will be de-energized.
- The ICC will request for the inverter to ramp the compressor speed to the defrost speed and remain there for the duration of the Defrost cycle.

Defrost Termination

Once a defrost is initiated, the defrost will continue until 14 minutes have elapsed or the coil temperature has reached the termination temperature. The termination temperature is factory-set at 60°F [15.6°C], although the temperature can be changed to 50°F [10°C], 60°F [15.6°C], 70°F [21.1°C], or 80°F [26.7°C] by relocating dip switches on the ICC. When all the defrost termination conditions have been met, the following sequence will occur:

- The ICC will request for the inverter to change the compressor speed to the predetermined reversing valve switching speed.
- The compressor will hold the reversing valve switching speed for a noise abatement period (30 sec.).

- When the noise abatement period is concluded the reversing valve will be energized.
- The ICC will re-energize the outdoor fan output.
- The compressor will change speed to oil circulation speed and run for a period of 6 minutes.
- The EXV algorithm will go into the control mode.
- In a communicating system, the ICC will advise the control center that the defrost cycle has concluded.
- After the reversing valve is changed, the ICC will de-energize the auxiliary heat (W) if in a non-communicating system. (The system user interface will de-energize the auxiliary heat in a communication system.)
- The ICC will return to heating operation per the control center or thermostat demand.

Defrost Termination Dip Switches

Defrost Termination Dip Switch Setting		
Switch 1	Switch 2	Off Set from Programmed Setting (°F)
Off	Off	60
On	Off	50
Off	On	40
On	On	70

Temperature Sensors

The coil sensor is clipped to the top tube on the outdoor coil at the point fed by the distribution tubes from the expansion device (short 3/8" [8.3 mm] diameter tube).

If the ambient sensor fails, the defrost control will initiate a defrost every 34 minutes in heat mode with the coil temperature below 35°F [1.7°C].

Defrost Test Mode

The Defrost Test Mode is initiated by pressing pushbutton TEST for 1 second with the unit running in HP mode. Upon release of pushbutton test, the unit will go into defrost until termination temperature is achieved or 14 minutes have expired. Pressing TEST while in Defrost Test Mode will terminate the test mode.

Troubleshooting Demand Defrost

- Set the indoor thermostat select switch to heat and initiate a call for heat.
- Press TEST to put the unit into defrost. If the unit goes into defrost and comes back out of defrost, the indication is that the control is working properly.

COMPONENTS AND CONTROLS



EcoNet™ Variable Speed Unitary Control (cont.)

Field Defrost Testing

- To test the defrost control, the coil temperature must be below 70°F [21.1°C].
- Run the unit in the heating mode for 1 minute to bypass any minimum run timers.
- Press the TEST button for 1 second.



- The control will display a “d” and initiate a 30-second delay on the compressor.
- When the coil temperature reaches termination temperature, the control will exit defrost mode and go through the second noise abatement delay.
- Pressing the TEST button will also end the defrost call.

Forced Defrost

The control can be forced into defrost mode by holding down the TEST button for 5 seconds.

The control will stay in defrost mode until the TEST button is pressed again.

If left in this mode for too long, the control will trip on high pressure.

If the defrost operation is tested multiple times, a “3” fault may occur. A “3” fault occurs because the compressor did not run for 3 minutes for 3 consecutive calls. To reset the “3” fault, remove the low-voltage power from the outdoor control board.

Active Compressor Protection Mode

Active Compressor Protection Mode

The Active Envelope Management will be used to maintain the compressor within the specified operating envelope parameters. There are several boundaries of operation that must be recognized and respected for reliable compressor operation. Excursion beyond the specified boundaries will result in shortened compressor life or failure. These boundaries are over current, over/under voltages, over temperature, lubrication, and oil circulation. System and/or environmental conditions can force the compressor outside the safe operation area. Adjustments to the EXV, compressor speed, outdoor air flow, and indoor air flow can be used to modify operation and keep the compressor within limits while maintaining the highest possible capacity and efficiency. Operational algorithms for these adjustments are defined in the following sections.

L8 – Compressor Model Unknown – A900_O Inverter Identity Fault

If the inverter compressor model is not set, the inverter will keep the compressor from operation. The ICC will lock out the compressor to keep it from operating and flash an “L” on the dual 7-segment LEDs followed by a 8.

IMPORTANT: This mode of active protection must be manually reset

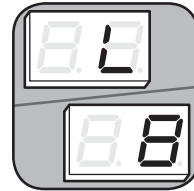

Active Protection – Code L8 – Open high-pressure control

15- Compressor Overcurrent– T901_O Inverter Fault

If the inverter detects an output overcurrent condition to the compressor greater than the compressor/inverter envelope permits, the inverter will automatically begin to slow the compressor operation and reduce the output current. When operating with an ECM outdoor fan motor and in cooling mode the ICC will increase the OD fan speed. When operating in communicating and heating modes the ICC will request the indoor airflow to be increased to the maximum level permissible for the outdoor unit. If this fold back is not successful in bringing the compressor back into the designed operating envelope then the compressor will be kept from operating.

During either of the above conditions where the compressor has been stopped from operating the ICC will flash a “15” on the dual 7-segment LED.



L15 -Power Factor Correction Circuit Overcurrent – T903_O Inverter Fault

If the inverter detects an overcurrent condition in the power factor correction circuit the inverter will automatically shut the compressor off and keep it from operation. There is a 5 minute delay after this fault occurs before ICC will restart the compressor. If this fault occurs 3 times during a single call for operation the ICC will lock out the compressor to keep it from continuing to operate and flash an “L” on the dual 7-segment LEDs followed by a 15.

COMPONENTS AND CONTROLS



EcoNet™ Variable Speed Unitary Control (cont.)

IMPORTANT: This mode of active protection must be manually reset



L15 - DC Bus Over Voltage – A904_O Inverter Fault

If the inverter detects an overvoltage condition in the DC bus circuit the inverter will automatically shut the compressor off and keep it from operation. The ICC will leave the compressor off until the DC bus voltage drops below 380Vdc. At this time the ICC will restart the compressor. If this fault occurs 3 times in one hour the ICC will lock out the compressor to keep it from continuing to operate for one hour and flash an "L" on the dual 7-segment LEDs followed by a 15.

IMPORTANT: This mode of active protection must be manually reset.

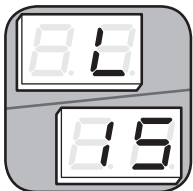

L15 – DC Bus Under Voltage - A905_O Inverter Fault

If the inverter detects an under voltage condition in the DC bus circuit the inverter will automatically shut the compressor off and keep it from operation. The ICC will leave the compressor off until the DC bus voltage rises above 300Vdc. At this time the ICC will restart the compressor. If this fault occurs 3 times in one hour the ICC will lock out the compressor to keep it from continuing to operate for one hour and flash an "L" on the dual 7-segment LEDs followed by a 15.

IMPORTANT: This mode of active protection must be manually reset.

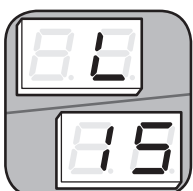

L15 – PIM Over-temp – T908_O Inverter Fault

If the inverter detects an over temperature condition in the **Power Module** circuit the inverter will automatically shut the compressor off and keep it from operation. The ICC will leave the compressor off until the circuit temperature is reduced to acceptable levels. At this time the ICC will restart the compressor. If this fault occurs 3 times during one call for operation the ICC will lock out the compressor to keep it from continuing to operate for one hour and flash an "L" on the dual 7-segment LEDs followed by a 15

IMPORTANT: This mode of active protection must be manually reset.

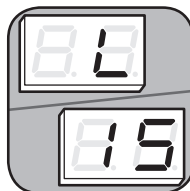

L15 – PFC Over-temp – T909_O Inverter Fault

If the inverter detects an over temperature condition in the **Power Factor Correction** circuit the inverter will automatically shut the compressor off and keep it from operation. The ICC will leave the compressor off until the circuit temperature is reduced to acceptable levels. At this time the ICC will restart the compressor. If this fault occurs 3 times during one call for operation the ICC will lock out the compressor to keep it from continuing to operate for one hour and flash an "L" on the dual 7-segment LEDs followed by a 15.

IMPORTANT: This mode of active protection must be manually reset.

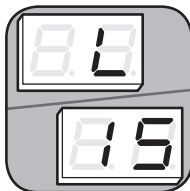

L15 – Lost Rotor Position- A910_O Inverter Fault

If the inverter loses the rotor position in the compressor the inverter will automatically shut the compressor off and keep it from operation. There is a 5 minute delay after this fault occurs before ICC will restart the compressor. If this fault occurs 3 times during a single call for operation the ICC will lock out the compressor to keep it from continuing to operate and flash an "L" on the dual 7-segment LEDs followed by a 15.

COMPONENTS AND CONTROLS



EcoNet™ Variable Speed Unitary Control (cont.)

IMPORTANT: This mode of active protection must be manually reset.

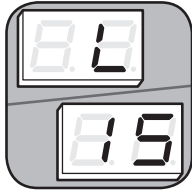

L15- Current Imbalance – T911_O Inverter Fault

If the inverter identifies an imbalanced current draw between the compressor 3 phase windings, the inverter will automatically shut the compressor off and keep it from operation. There is a 5 minute delay after this fault occurs before ICC will restart the compressor. If this fault occurs 3 times during a single call for operation the ICC will lock out the compressor to keep it from continuing to operate and flash an "L" on the dual 7-segment LEDs followed by a 15.

IMPORTANT: This mode of active protection must be manually reset.

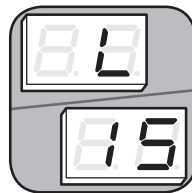

L15 – DC Voltage Low – T914_O Inverter Fault

If the inverter detects an sustained low voltage condition in the DC bus circuit the inverter will automatically shut the compressor off and keep it from operation. The ICC will immediately restart the compressor. If this fault occurs 3 times during one call for operation the ICC will lock out the compressor to keep it from continuing to operate and flash an "L" on the dual 7-segment LEDs followed by a 15.

IMPORTANT: This mode of active protection must be manually reset.

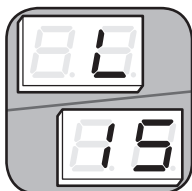

L15- PIM Temperature High – T917_O Inverter Fault

If the inverter identifies a high Power Module temperature thermistor reading the inverter will

automatically shut the compressor off and keep it from operation. If this fault occurs 3 times during one call for operation the ICC will lock out the compressor to keep it from continuing to operate and flash an "L" on the dual 7-segment LEDs followed by a 15.

IMPORTANT: This mode of active protection must be manually reset.

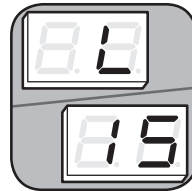

L15 – PFC & IGBT Temperature High – T918_O Inverter Fault

If the inverter identifies a high insulated-gate bipolar transistor (IGBT) temperature or power factor correction (PFC) circuit temperature reading the inverter will automatically shut the compressor off and keep it from operation. If this fault occurs 3 times during one call for operation the ICC will lock out the compressor to keep it from continuing to operate and flash an "L" on the dual 7-segment LEDs followed by a 15.

IMPORTANT: This mode of active protection must be manually reset.

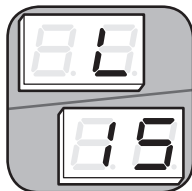

L15- PIM Temperature Fold back – T922_O Inverter Fault

If the inverter detects a high Power Module temperature the inverter will automatically begin to slow the compressor operation. If this fold back is not successful in bringing the PIM temperature into the acceptable range then the compressor will be kept from operating. If this fault occurs 3 times during one call for operation ICC will lock out the compressor to keep it from continuing to operate and flash an "L" on the dual 7-segment LEDs followed by a 15.

IMPORTANT: This mode of active protection must be manually reset.

COMPONENTS AND CONTROLS



EcoNet™ Variable Speed Unitary Control (cont.)

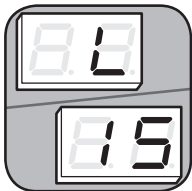

L16- Microprocessor Fault – A912_O Inverter Fault

If the inverter identifies faulty microprocessor the inverter will automatically shut the compressor off and keep it from operation. The ICC will lock out the compressor to keep it from continuing to operate and flash an "L" on the dual 7-segment LEDs followed by a 16.

IMPORTANT: This mode of active protection must be manually reset.



L16 – PIM Temp Sensor Open – A913_O Inverter Fault

If the inverter identifies an open power module temperature thermistor the inverter will automatically shut the compressor off and keep it from operation. The ICC will lock out the compressor to keep it from continuing to operate and flash an "L" on the dual 7-segment LEDs followed by a 16.

IMPORTANT: This mode of active protection must be manually reset.

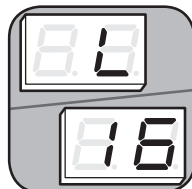

L16 – PFC MCU/DSP Communication Fault – A919_O Inverter Fault

If the inverter identifies a communication fault between the MCU (motor control unit) or DSP (digital signal processor), the inverter will automatically shut the compressor off and keep it from operation. If this fault occurs 3 times during one call for operation the ICC will lock out the compressor to keep it from continuing to operate and flash an "L" on the dual 7-segment LEDs followed by a 16.

IMPORTANT: This mode of active protection must be manually reset.

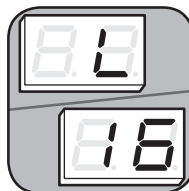

L16 – Com/DSP Comm Fault – A920_O Inverter Fault

If the inverter identifies a communication with the DSP (digital signal processor), the inverter will automatically shut the compressor off and keep it from operation. If this fault occurs 3 times during one call for operation the ICC will lock out the compressor to keep it from continuing to operate and flash an "L" on the dual 7-segment LEDs followed by a 16.

IMPORTANT: This mode of active protection must be manually reset.

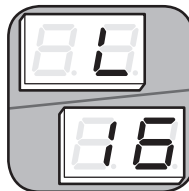

L16 – PFC Temperature Sensor Open – A921_O Inverter Fault

If the inverter identifies an open power factor correction (PFC) temperature thermistor the inverter will automatically shut the compressor off and keep it from operation. The ICC will lock out the compressor to keep it from continuing to operate and flash an "L" on the dual 7-segment LEDs followed by a 16.

IMPORTANT: This mode of active protection must be manually reset.

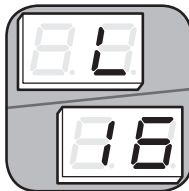

L16 – Discharge Line Temperature Fault – A927_O Inverter Fault

If the inverter identifies a faulty discharge line temperature thermistor the inverter will automatically shut the compressor off and keep it from operation. The ICC will lock out the

COMPONENTS AND CONTROLS



EcoNet™ Variable Speed Unitary Control (cont.)

compressor to keep it from continuing to operate and flash an "L" on the dual 7-segment LEDs followed by a 16.

IMPORTANT: This mode of active protection must be automatic reset once the discharge line thermistor fault is corrected.



L16 – Discharge Temperature – T916_O Inverter Fault

If the ICC detects the compressor discharge temperature is greater 235°F the ICC will automatically begin to slow the compressor operation until the temperature is $\leq 200^\circ\text{F}$. If this fold back is not successful in bringing the compressor discharge temperature below 200°F prior to reaching the minimum compressor speed then the compressor will be kept from operating. After the compressor off delay is complete the ICC will return the compressor to operation. If this fault occurs 3 times during one call for operation the ICC will lock out the compressor to keep it from continuing to operate and flash an "L" on the dual 7-segment LEDs followed by a 16.

IMPORTANT: This mode of active protection must be manually reset.

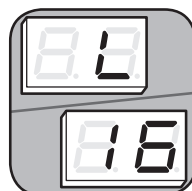

L16 – Communication Failure – A929_O Inverter Fault

If the inverter identifies a communication error with the ICC, the inverter will automatically shut the compressor off and keep it from operation. When this fault occurs the ICC will lock out the compressor to keep it from operating and flash an "L" on the dual 7-segment LEDs followed by a 16.

IMPORTANT: This mode of active protection must be manually reset.

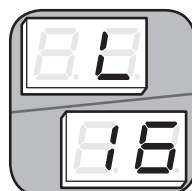

16 – HP Sensor Not Configured – T926_O

If the inverter is not configured or does not hold the configuration for the high pressure switch in the Modbus register, the inverter will provide this fault.



L16 – Brown Out Fault – A959_O Brown Out Fault

If the inverter detects input AC voltage $< 155\text{VAC}$ for 4 seconds the ICC will automatically shut the compressor off and keep it from operation. The ICC will leave the compressor off until the input AC voltage increases to $> 175\text{VAC}$ for 4 seconds. At this time the ICC will restart the compressor. While the compressor is off the ICC will display a 16 on the dual 7-segment LEDs.

IMPORTANT: This mode of active protection is automatically reset.

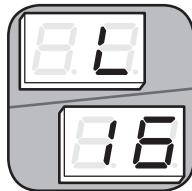

L21 – Low Pressure Refrigerant – A/T 021_0 Low Refrigerant Pressure

- The ICC will display a flashing "21" followed by a flashing "L" when a low-pressure control lockout occurs.

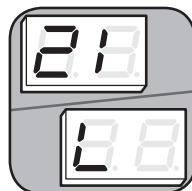

Active Protection – Code
21L – Open low-pressure control

IMPORTANT: This mode of active protection must be manually reset.

- The ICC addresses low-pressure control faults differently depending on the mode of unit operation (cooling or heating mode).

Cooling Mode

- If the LPC opens three (3) times during the same call for cooling operation, the ICC will lock out the compressor to keep it from continuing to operate and flash a "21" on the dual 7-segment LEDs followed by an "L."

COMPONENTS AND CONTROLS



EcoNet™ Variable Speed Unitary Control (cont.)



Active Protection – Code 21L – Open low-pressure control

IMPORTANT: This mode of active protection must be manually reset.

Heating Mode

- There are two scenarios that will cause active protection during an LPC trip when the unit is in the heating mode:

Active Protection With Hard Lockout:

- If the LPC opens three (3) times within 120 minutes for the same call for heating operation, the ICC will lock out the compressor to keep it from continuing to operate and flash an “21” on the dual 7-segment LEDs followed by a “L.”



Active Protection – Code 21L – Open low-pressure control

IMPORTANT: This mode of active protection must be manually reset.

Active Protection With Soft Lockout:

- If the LPC opens three (3) times for the same call for heating and the outdoor ambient temperature is below -10°F [-23°C], the ICC will lock out the compressor to keep it from continuing to operate and flash a “21” on the dual 7-segment LEDs followed by an “L.” Once the outdoor ambient rises above -10°F [-23°C], the ICC will clear active protection automatically.

IMPORTANT: This mode of active protection will automatically deactivate once the outdoor temperature rises above -10°F [-23°C]. Wait until the outdoor ambient temperature rises above -10°F [-23°C] before performing further diagnostics.

27- AC Input Under Voltage – A907_O_Inverter Fault

If the inverter detects input AC under voltage the ICC will automatically shut the compressor off and keep it from operation. The ICC will leave the compressor off until the input AC voltage

increases to $\geq 187\text{VAC}$. At this time the ICC will restart the compressor. While the compressor is off the ICC will display a 27 on the dual 7-segment LEDs.

IMPORTANT: This mode of active protection is automatically reset.



28 – AC Input Over Voltage – A906_O Inverter Fault

If the inverter detects input AC over voltage the ICC will automatically shut the compressor off and keep it from operation. The ICC will leave the compressor off until the input AC voltage reduces to $\leq 252\text{VAC}$. At this time the ICC will restart the compressor. While the compressor is off the ICC will display a 28 on the dual 7-segment LEDs.

IMPORTANT: This mode of active protection is automatically reset.



L29 – High Refrigerant Pressure – A/T 923_O High Refrigerant Pressure

- If the HPC opens three (3) times during the same call for unit operation, the ICC will lock out the compressor to keep it from continuing to operate and flash a “29” on the dual 7-segment LEDs followed by an “L” control

IMPORTANT: This mode of active protection must be manually reset.

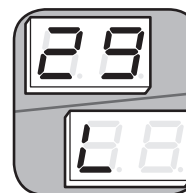

31 - Compressor Envelope Protection- T902_O Inverter Fault – Envelope Protection

If the inverter detects the calculated compressor torque is greater than the designed operating envelope permits the inverter will automatically begin to slow the compressor operation. If this fold back is not successful in bringing the compressor back into the designed operating envelope then the compressor will be kept from operating.

COMPONENTS AND CONTROLS



EcoNet™ Variable Speed Unitary Control (cont.)

IMPORTANT: For a single stage or two stage system it is very common during startup and shutdown for the compressor to venture outside the designed operating envelope. It is possible this fault can be seen on an installation when there is nothing globally wrong with the installation. For this reason the ICC will auto reset and return the system to operational condition after the compressor delay is complete.

Prior to restarting the compressor the ICC 7-segment display will flash a “31”.

35- Suction Temperature Thermistor Failure – A102_O

If the ICC identifies an issue with Outdoor Suction Thermistor (OST) sensor the ICC will flash a 35 on the dual 7-segment LEDs.

IMPORTANT: This mode of active protection is automatically reset once the OAT sensor failure is corrected.



36 – Suction Pressure Sensor Failure – A956_O

If the ICC identifies an issue with the Suction Pressure Transducer (SPT) sensor the ICC will flash a 36 on the dual 7-segment LEDs.

IMPORTANT: This mode of active protection is automatically reset once the OAT sensor failure is corrected.

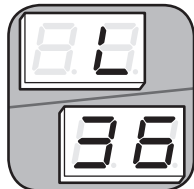

42- Compressor Temperature Thermistor Failure – T955_O

If the ICC identifies an issue with the Compressor Sump Thermistor (CPT) the ICC will flash a 42 on the dual 7-segment LEDs.

IMPORTANT: This mode of active protection is automatically reset once the CPT sensor failure is corrected.

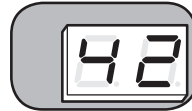

83 – Evaporator Temperature Thermistor Failure – T953_O

If the ICC identifies an issue with the Evaporator Temperature Thermistor (EVAPIN) sensor the ICC will flash an 83 on the dual 7-segment LEDs.

IMPORTANT: This mode of active protection is automatically reset once the OAT sensor failure is corrected.

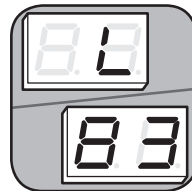

84 – Outside Ambient Thermistor Failure - T952

If the ICC identifies an issue with the Outdoor Ambient Thermistor (OAT) sensor the ICC will flash an 84 on the dual 7-segment LEDs.

IMPORTANT: This mode of active protection is automatically reset once the OAT sensor failure is corrected.

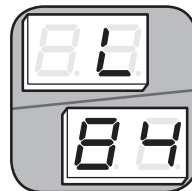

93 – Configuration Data Restore Failure – A950_O

If the ICC identifies issue(s) reading the model data from the memory card, the ICC will automatically shut the compressor off and keep it from operation. When this fault occurs the ICC will lock out the compressor to keep it from operating and flash an “L” on the dual 7-segment LEDs followed by a 93.

IMPORTANT: This mode of active protection must be manually reset.

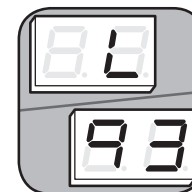

COMPONENTS AND CONTROLS



EcoNet™ Variable Speed Unitary Control (cont.)

D1 – Memory Card Configuration Data Write Failure – A951_O

If the ICC identifies issue(s) writing the model data from the memory card, the ICC will automatically shut the compressor off and keep it from operation. When this fault occurs the ICC will lock out the compressor to keep it from operating and flash an "D1" on the dual 7-segment LEDs.

IMPORTANT: This mode of active protection must be manually reset.

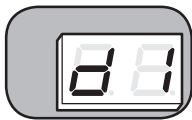

Exiting Active Compressor Protection Lockout

There are three methods to reset the ICC after an active protection lockout:

- 1) Cycle the line voltage to the unit.
- 2) Cycle 24 VAC to the ICC (remove the R or C connection to the ICC).

Default Operations Upon Component Failure

If any of the following components on the (-)P20 heat pump fail, there are multiple fail safe logic routines to keep the system conditioning the space while service is being sought. The table below outlines the effect for each of these routines.

Test and Fault Recall Modes

Test Mode (Test Button on the ICC)

- Enter TEST mode by pressing the TEST button with an insulated probe for one (1) second and release.
- The TEST mode causes the ICC to do the following:
 - 1) Resets the 4-minute anti-short-cycle timer.
 - 2) Energizes the unit without a call for unit operation.
- If the 4-minute anti-short-cycle timer or 30-second minimum run timer is active (a

FAILED COMPONENT	FUNCTION	DEFAULT OPERATION
Outdoor Sensor (OAT)	Low Ambient Cooling	No Low Ambient function
	Defrost	Defrost will be initiated based on coil temperature and time
	One minute fan off delay on COOL mode	No delay functions if failure is open or short. Continue function for a thermistor range error.
	PWM Shift above 104° F	Shift will not occur
Coil Sensor (EVAPIN)	Defrost Initiate and Terminate	Defrost will occur at each time interval, but will terminate after 5 minutes
	Low Ambient Cooling	No function
Suction Sensor (OST)	EXV Operation	The EXV will be held in the last stored position
EXV Inlet Sensor (LIQ)	Charge Verification	No Charge Verification function
	Sub-cooling verification	No Sub-Cooling verification function
Compressor Sump Sensor (CPT)	AEM Lubrication Protection, Oil Circulating Ration Protection, Compressor Stator Heat	The compressor operation outlined in the applicable sections will be performed once an hour. The compressor stator heat will be kept from operating.

COMPONENTS AND CONTROLS



EcoNet™ Variable Speed Unitary Control (cont.)

flashing “c,” “C,” “h,” or “H” is displayed on the dual 7-segment LEDs) and a call for unit operation is present, the TEST mode causes:

- 1) A “t” to display momentarily on the dual 7-segment display.



- 2) The compressor will start and the outdoor fan will operate.
- 3) The display will change to a steady “c,” “C,” “h,” or “H” to show the current demand for unit operation.

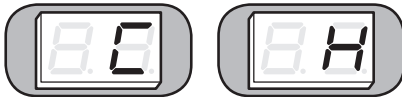
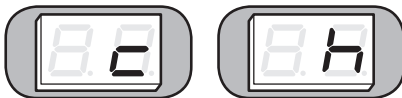

NOTICE: If a call for unit operation is present at the end of the TEST mode, the unit will continue to operate.

- If no call for unit operation is present, the TEST mode causes:

- 1) A steady “C” to appear on the dual 7-segment LEDs.



- 2) The compressor will start.
- 3) The compressor will turn off after 5 seconds.

NOTICE: Entering TEST mode without a call for unit operation will cause the compressor to run for 5 seconds.

Agency Test Mode Instructions

The (-)P20 variable speed system by nature varies the compressor speed based on building load and thermostat call for operation. Therefore the following set of special instructions is necessary for agency testing ONLY. These modes should not be used for field installation use.

Low Compressor Speed Test Mode

To enter low compressor speed test mode where the ICC will keep the compressor speed at the minimum possible speed for the given/tested outdoor ambient temperature use the following procedure:

1. Supply a Y ONLY signal to the ICC. (**NOTE:** for heating also supply a 24VAC signal to the “B” terminal)
2. Allow the 5min delay to expire and for the compressor to start.
3. Once the compressor has started depress the SW2 and TEST buttons together for 5-8 seconds.
4. After this time the dual seven segment LEDs will show the “FC” menu option.
5. Press the TEST button one time. The dual 7-segment display will show a “CS”, which refers to compressor speed.
6. To enter this menu, depress the SW2 button once.
7. The LED display should now show a value of “1”. This refers to 1st stage or low stage operation.

IMPORTANT: When testing in this mode with an RHMV air handler, it is required to short the WIT or P12 pins to keep the ID blower supplying the rated low stage airflow. If this is not completed, the indoor airflow will move to intermediate stage cfm.

IMPORTANT: When operating in this mode the ICC will stop compressor operation if the Y signal is removed for the purposes of completing the optional cycle tests. Upon the return of the Y signal the ICC will continue to operate in low compressor speed.

To exit this mode and return to standard thermostat signal control mode, depress the TEST button once and wait 5-10 seconds or provide the ICC with a Y+Y2 24VAC signal. The dual 7-segment display will display the current thermostat requested stage of operation.

Intermediate Compressor Speed Mode

To enter intermediate compressor speed test mode where the ICC will keep the compressor speed at the intermediate compressor speed for the given/tested outdoor ambient temperature use the following procedure:

1. Supply a Y ONLY signal to the ICC. (**NOTE:** for heating also supply a 24VAC signal to the “B” terminal)
2. Allow the 5min delay to expire and for the compressor to start.
3. Once the compressor has started depress the SW2 and TEST buttons together for 5-8 seconds.
4. After this time, the dual seven segment LEDs will show the “FC” menu option.
5. Press the TEST button one time. The dual 7-segment display will show a “CS”, which refers to compressor speed.

COMPONENTS AND CONTROLS



EcoNet™ Variable Speed Unitary Control (cont.)

6. To enter this menu, depress the SW2 button once.
7. The LED display should now show a value of “1”. This refers to 1st stage or low compressor speed operation.
8. To toggle to the next compressor speed by depressing the SW2 button once.
9. The LED display should now show a value of “2”. This refers to the intermediate compressor speed operating stage.

IMPORTANT: When testing in this mode with an RHMV air handler provide a Y2 thermostat signal only and the intermediate airflow will be provided immediately.

IMPORTANT: When operating in this mode the ICC will stop compressor operation if the Y signal is removed. Upon the return of the Y signal the ICC will continue to operate in intermediate compressor speed.

To exit this mode and return to standard thermostat signal control mode, depress the TEST button once and wait 5-10 seconds. The dual 7-segment display will display the current thermostat requested stage of operation.

High/Maximum Compressor Speed Mode

To enter high/maximum compressor speed test mode where the ICC will keep the compressor speed at the intermediate compressor speed for the given/tested outdoor ambient temperature use the following procedure:

1. Supply a Y+Y2 signal to the ICC. (**NOTE:** for heating also supply a 24VAC signal to the “B” terminal)
2. Allow the 5min delay to expire and for the compressor to start.
3. Once the compressor has started depress the SW2 and TEST buttons together for 5-8 seconds.
4. After this time, the dual seven segment LEDs will show the “FC” menu option.
5. Press the TEST button one time. The dual 7-segment display will show a “CS”, which refers to compressor speed.
6. To enter this menu, depress the SW2 button once.
7. The LED display should now show a value of “3”. This refers to the high/maximum compressor speed operating stage.

IMPORTANT: When testing in this mode with an air handler or furnace provide a Y1+Y2 thermostat signal only and the high/maximum airflow will be provided immediately.

IMPORTANT: When operating in this mode the ICC will stop compressor operation if the Y+Y2 signal is removed. Upon the return of the Y+Y2 signal the ICC will continue to operate in low compressor speed. To exit this mode and return to standard thermostat signal control mode, depress the TEST button once and wait 5-10 seconds. The dual 7-segment display will display the current thermostat requested stage of operation.

Control Center Ratings Test Mode

When testing a (-)P20 variable speed heat pump with a rated combination requiring a control center (according to the AHRI rating database) as an accessory to obtain the rated performance utilize the following instructions to properly operate the system during ratings tests.

1. Install the rated system in alignment with this I&O and ASHRAE 37.
2. Leak check and charge the rated system per the instructions found in this I&O.
3. Wire the outdoor unit, indoor air mover/furnace, indoor coil EXV control (when necessary), and control center according to the following wiring diagrams.

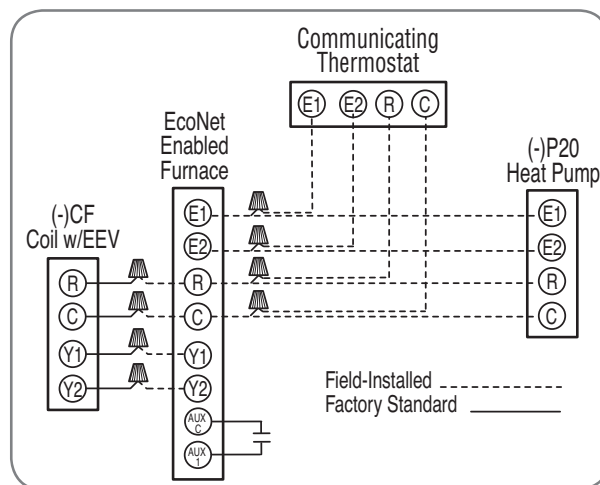
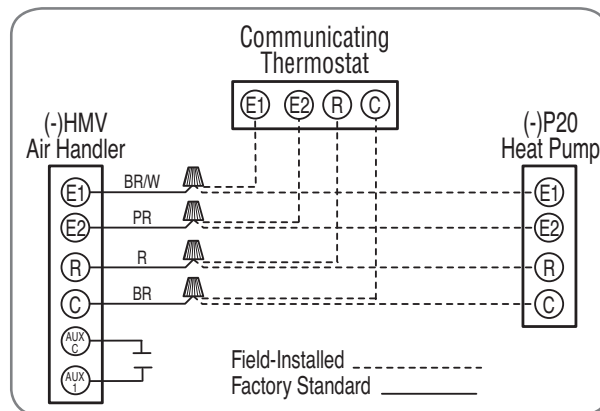

COMPONENTS AND CONTROLS



EcoNet™ Variable Speed Unitary Control (cont.)

4. Supply high and low voltage to the system.
5. Once each control is powered turn off the Dehumidification feature:
 - a. Pressing the “Settings” button on the home screen followed by pressing the “humidity” button.
 - b. Once in the “humidity” screen, select “Yes” next to the “Enable Dehumidification ?” label.
 - c. To turn dehumidification off press the orange up or blue down arrows once.
 - d. The “Yes” should turn to a value of “No.”
6. Once the dehumidification feature is turned off, the Aux 1 configuration needs to be set to normally closed (N.C.) as to permit a closed switch attached to the Aux 1 contacts to keep the system operating. Thereby an open switch would indicate to the system to shut down:
 - a. Press the back arrow in the bottom left of the dehumidification screen to return to the “settings” screen.
 - b. Press the “installer” button in the bottom right corner of the “settings” screen.
 - c. Press the “air handler” or “furnace” button.
 - d. Once in the “air handler settings” or “furnace settings” screen select “N.C.” next to the “Aux Input #1 Config” label.
 - e. Change the “Aux #1 Config” type to “N.C.” by pressing the orange up or blue down arrows at the bottom of the screen twice.
 - f. Select “Off” next to the “Aux Input #1 Config” label.
 - g. Change the “Aux #1 Config” value from “Off” to “Shutdown” by pressing the orange up button at the bottom of the screen two times. After each press of the orange up button the value next to the “Aux #1 Config” label should change.

7. Entering the Test Mode

- a. Press the back arrow in the bottom left of the screen 3 times to return to the home screen showing the inside temperature.
- b. Press the “Service” button on the home screen.
- c. Press the “installer” button in the bottom right corner of the “service” screen to enter the “installer checkout” screen.
- d. Select the desired mode of operation by pressing “Off” next to the “Var Speed ODU Test” label and then the orange up arrow or blue down arrow at the bottom of the “installer checkout” screen.

NOTE: Any faults must be resolved before the system will start. See the troubleshooting guide in this manual for assistance.

NOTE: If the unit does not start when the “start” button is pushed verify the switch attached to the Aux 1 input on the air handler or furnace control board is closed and no alarms are active.

NOTE: In order to change from heating mode to cooling mode or vice versa the system must first be turned off by pressing the blue down button until “stop test” appears at the bottom of the “installer checkout” screen. Then press the “Stop” button.

8. Cycle Testing

- a. The Aux #1 configuration performed above permits a N.C. set of contacts to be connected to these terminals on the air handler or the furnace controls.
- b. When performing the optional AHRI cycle tests, the Aux #1 terminals should be used to turn the unit on and off.
- c. When the system is desired to be operating the air handler or furnace control should sense continuity between the Aux #1 and Aux C terminals. This continuity will tell the system to turn on and the Test Mode selection outlined in step 7 above identifies the mode and stage of operation.
- d. When the unit is desired to be off/not operating the air handler or furnace control should sense an open state between the Aux #1 and the Aux C terminals.

9. Exiting the Test Mode

NOTE: While the test mode is active the thermostat will not permit return to the home screen.

- a. To turn the unit off either press the blue down button until “stop test” appears at the bottom of the screen and then press “stop test” on the “installer checkout” screen or open the normally closed switch attached to the air handler or furnace Aux 1 inputs.

NOTE: Once the unit is requested to shut down there is a 4 min. delay during which the test mode cannot be changed.

IMPORTANT: The minimum run and minimum off timers built into the ICC will be active while operating in the test mode.

- b. Opening the N.C. contact will not exit the test mode, but will permit the system to perform a soft shutdown.
- c. In order for the system to return to normal operating mode press the “Stop” button on the “installer checkout” screen and then press the back arrow in the bottom left hand side of the screen two times. This will return the thermostat to the home screen.

⚠WARNING: Turn off electric power at the fuse box or service panel for at least 1 minute before making any electrical connections. Also, the ground connection must be completed before making line voltage connections. Failure to do so can result in electrical shock, severe personal injury, or death.

Heat Pump Thermostat Warning Light Kit RXPX-D01

This component senses a compressor lock out and tells the thermostat service light to come on. This will let the homeowner know that service is needed on the system.

NOTE: Warning light on thermostat will come on during a 5 minute compressor time delay and for 5 seconds during defrost while the compressor is off. Homeowner should only be concerned if light stays on for more than 5 minutes.

DIAGNOSTICS

IMPORTANT: The (-)P20 series units with the ICC (Integrated Compressor Control) provide status and diagnostic information that greatly enhances the ability to quickly diagnose system faults. Use the following troubleshooting guides as another tool in system diagnostics.

NOTICE: In diagnosing common faults in the cooling system, develop a logical thought pattern as used by experienced technicians. The charts which follow are not intended to be an answer to all problems but only to guide the technician's troubleshooting. Through a series of yes and no answers, follow the logical path to a likely conclusion.

A novice technician should use these charts like a road map. Remember that the chart should clarify a logical path to the solution.

Replacement of EcoNet™ Variable Speed Unitary Control Board

Each control board in the *EcoNet™ Communication Network* needs information specific to the unit the control is installed in. This information is called model data because it is model specific information required for the HVAC network to operate properly for the specific model installed. The data for a unit contains information that allows the unit to operate correctly.

When a control board requires replacement, it is important that the replacement board gets the model data from the old control. The primary way the replacement control gets this information is by the memory card that should be installed on the old control. Remove the memory card from the old control, replace the control, and reinstall the memory card on the new control.

The memory card from a different unit should never be used.

NOTE: See links to training and service manuals at MyRheem.com or MyRuud.com, or contact the wholesale distributor selling this unit.









ICC Diagnostic Codes

Descriptions of the ICC diagnostic codes are provided below:



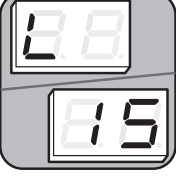

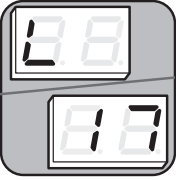
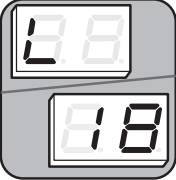

NOTE: Codes must be read from correct side to avoid an error in reading codes.

Dual 7-Segment LEDs Display Code	Diagnostic Description	Status/Possible Cause – Troubleshooting Information
	c – First-Stage Cooling Unit has received a command for first-stage cooling.	Normal operation
 FLASHING	c – Anti-short-cycle timer (3 minutes) or minimum run timer (30 seconds) active	<ul style="list-style-type: none"> The unit has received a command for first-stage cooling during an active anti-short-cycle timer or minimum run timer. Wait until unit timer has expired or press the TEST button to defeat short-cycle delay.
	C – Second-Stage Cooling Unit has received a command for second-stage cooling.	Normal operation
 FLASHING	C – Anti-short-cycle timer (3 minutes) or minimum run timer (30 seconds) active.	<ul style="list-style-type: none"> The unit has received a command for second-stage cooling during an active anti-short-cycle timer or minimum run timer. Wait until timer has expired or press the TEST button to defeat short-cycle delay.
	d – Defrost Active The unit is undergoing a defrost cycle.	Normal operation
	d1 – No Model Data	<ul style="list-style-type: none"> Replace memory card with correct system information.
	h – First-Stage Heat Pump Unit has received a command for first-stage heat pump.	Normal operation
 FLASHING	h – Anti-short-cycle timer (3 minutes) or minimum run timer (30 seconds) active.	<ul style="list-style-type: none"> The unit has received a command for first-stage heat pump during an active anti-short-cycle timer or minimum run timer. Wait unit timer has expired or press the TEST button to defeat short-cycle delay.
	H – Second-Stage Heat Pump Unit has received a command for second-stage heat pump.	Normal operation
 FLASHING	H – Anti-short-cycle timer (3 minutes) or minimum run timer (30 seconds) active.	<ul style="list-style-type: none"> The unit has received a command for second-stage heat pump during an active anti-short-cycle timer or minimum run timer. Wait unit timer has expired or press the TEST button to defeat short-cycle delay.
	0 – Standby No command for unit operation	Normal operation



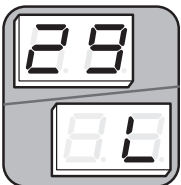

DIAGNOSTICS

Dual 7-Segment LEDs Display Code	Diagnostic Description	Status/Possible Cause – Troubleshooting Information
	L8 – Compressor Model Unknown A900–O Inverter Identity Fault	<ul style="list-style-type: none"> • Check model data card is properly connected • Cycle power – remove power until all the lights on the inverter have gone out. Then restore power to inverter then ICC. • Replace model data card
	09 – Low Secondary Volts The secondary voltage at R and C is below 18VAC.	<ul style="list-style-type: none"> • Control transformer overloaded. • Low line voltage
	L15 – T901, A903, A904, A905, A908, A909, A910, T911, T914, T917, T918 & T922 Inverter Fault	<ul style="list-style-type: none"> • Verify high voltage connections at the terminal block, filter and inverter are all tight. • Verify communication cable connection between the inverter and ICC is complete. • Check the U/V/W output wires are correct. • Verify there is not a short in the filter or choke. • Verify input voltage is within 187VAC and 252VAC. • Check outdoor airflow and verify OD fan is operating. • Check the power inverter heat sync for debris. • Replace model data card • If none of the above corrects the issue, replace drive.
	L16 – A912, A913, A919, A920, A921, & A929 Inverter Fault	<ul style="list-style-type: none"> • Power cycle the system. Verify all lights on the inverter are out prior to returning power to the drive. • Check the U/V/W output wires are correct. • Check charge level. Reduce charge. • Check continuity of discharge line thermistor and connection at the drive. If issue persists, replace the thermistor. • If none of the above corrects the issue, replace the drive.
	L17 – Discharge line temperature – T916 Inverter Fault	<ul style="list-style-type: none"> • Outdoor ambient is above 125°F. Allow unit to cool and condensing pressure to reduce before restarting. • Outdoor ambient is below 0°F. Allow unit to heat up and evaporating pressure to increase before restarting. • Check charge level. Reduce charge. • Check thermistor continuity. The discharge thermistor is a 10k thermistor. See the 10k thermistor chart for correct resistance value.
	L18 – Communication failure – T915 Inverter Fault	<ul style="list-style-type: none"> • Verify communication cable connection between the inverter and ICC is complete. • Verify shielding on communication cable is adequately connected to the connector. • Verify crimp terminals in the ICC to inverter communication cable are fully inserted and making good contact with the receptacle.
	21 – Low Pressure Control Open The ICC detects the LPC is open. Notice: The low-pressure control is ignored for the first 90 seconds of compressor operation.	<ul style="list-style-type: none"> • Unit has low refrigerant charge. • Indoor coil is frozen (cooling mode). • Indoor coil or filter is dirty (cooling mode). • Indoor blower is not running (cooling mode). • Outdoor coil is frozen (heating mode). • Expansion valve is not operating correctly.

DIAGNOSTICS

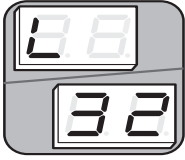
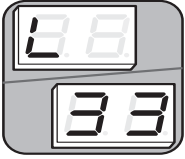
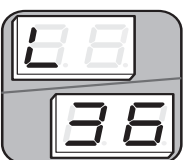
Dual 7-Segment LEDs Display Code	Diagnostic Description	Status/Possible Cause – Troubleshooting Information
 <p>FLASHING</p>	<p>21L – Active Protection Low-Pressure Control Trip</p>	<ul style="list-style-type: none"> LPC has opened 3 times in the same cooling operation, the ICC has locked out the compressor to protect it. ICC alternately flashes L and 21.
	<p>27 – AC Input Under Voltage – A907 Inverter Fault</p>	<ul style="list-style-type: none"> Check incoming line voltage to the disconnect and unit. Check wiring connections.
	<p>28 – AC Input Over Voltage – A906 Inverter Fault</p>	<ul style="list-style-type: none"> Check line voltage.
	<p>29 – High-Pressure Control Open – T923 Inverter Fault The ICC detects the HPC is open.</p>	<ul style="list-style-type: none"> Outdoor coil is dirty (cooling mode). Outdoor fan is not running (cooling mode). Indoor coil or filter is dirty (heating mode). Indoor blower is not running (heating mode). Liquid line restriction Excessive refrigerant charge
 <p>FLASHING</p>	<p>29L – Active Protection High-Pressure Control Trip A923 Inverter Fault</p>	<ul style="list-style-type: none"> HPC has opened 3 times in the same cooling operation; the ICC has locked out the compressor to protect it. ICC alternately flashes L and 29.
	<p>31 – Compressor Envelope Protection – T902 Inverter Fault Inverter has recognized the compressor is operating outside the envelope</p>	<ul style="list-style-type: none"> Check charge level. Reduce charge. Charge migration could have occurred resulting in high compressor ratio. If ambient above 110°F or below 0°F compression ratio could be too high for low speed operation. ICC will clear this fault and restart independently

DIAGNOSTICS

Dual 7-Segment LEDs Display Code	Diagnostic Description	Status/Possible Cause – Troubleshooting Information
	L32 – Compressor Temperature Thermister Failure – A902 Inverter Fault	<ul style="list-style-type: none"> Check thermister continuity. The compressor thermister is a 10k thermister. See the 10k thermister chart for correct resistance value.
	L32 – Compressor Temperature Thermister Failure – A902 Inverter Fault	<ul style="list-style-type: none"> Check thermister continuity. The compressor thermister is a 10k thermister. See the 10k thermister chart for correct resistance value.
	L36 – Suction Pressure Sensor Failure – A956	<ul style="list-style-type: none"> Check pressure transducer wiring harness for continuity while attached to sensor. Check 5Vdc is constant between black and red at the sensor. Check return voltage between Black and Green terminals on back of control board. Calculate the gauge pressure from the voltage readings: PSIG = (375 * (Vout/Vin) - 22.8) - 14.7 On a legacy controlled system verify that the voltage readings convert to the servicer gauge readings. On a communicating system verify that the voltage readings convert to the displayed pressure listed on the control center. If all voltage measurements convert to a similar pressure as displayed by the control center or manual gauges replace the control. If not replace the harness and/or pressure transducer.
	L42 – Compressor Temperature Thermistor Failure – T955	<ul style="list-style-type: none"> Check thermistor continuity. The compressor thermistor is a 10k thermistor. See the 10k thermistor chart for correct resistance value.
	83 – Condenser Coil Temperature Fault The sensor detects an abnormally low or high coil temperature.	<ul style="list-style-type: none"> Replace the sensor. Check sensor is installed correctly on control.
	84 – Outdoor Ambient Temperature Fault The sensor detects an abnormally low or high outdoor ambient temperature. T952	<ul style="list-style-type: none"> Check unit placement. If the outdoor unit is in a high-temperature area, wait until the ambient temperature drops and check sensor reading. Replace the sensor. Check sensor is installed correctly on control.
	93 – Configuration Data Restore Failure A950 The control is not functioning properly.	<ul style="list-style-type: none"> Check control for proper system operation. Replace control.

Electrical Checks Flowchart

THERMOSTAT CALL FOR COOLING, NO COOLING

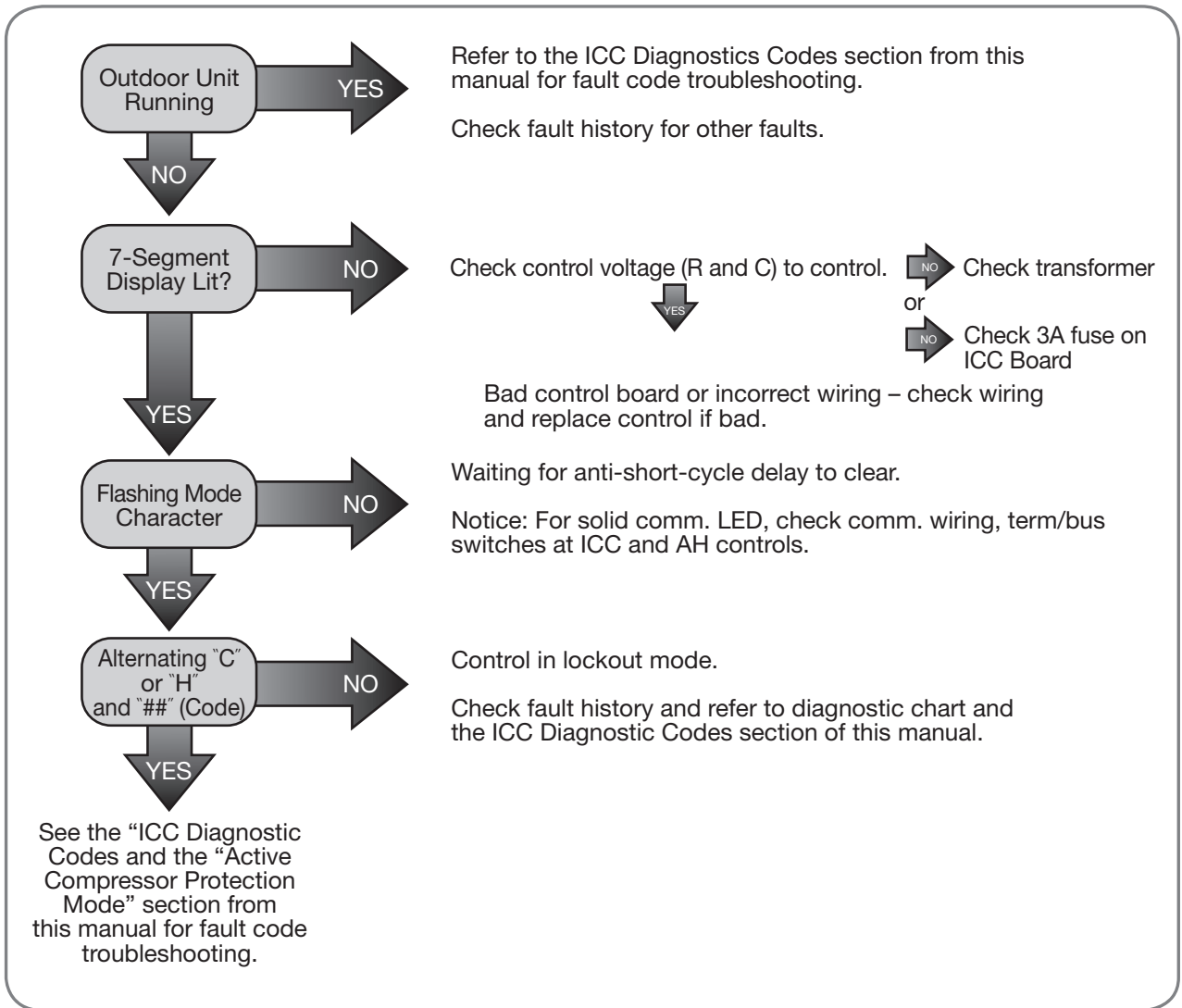

DIAGNOSTICS

Cooling Mechanical Checks Flowchart

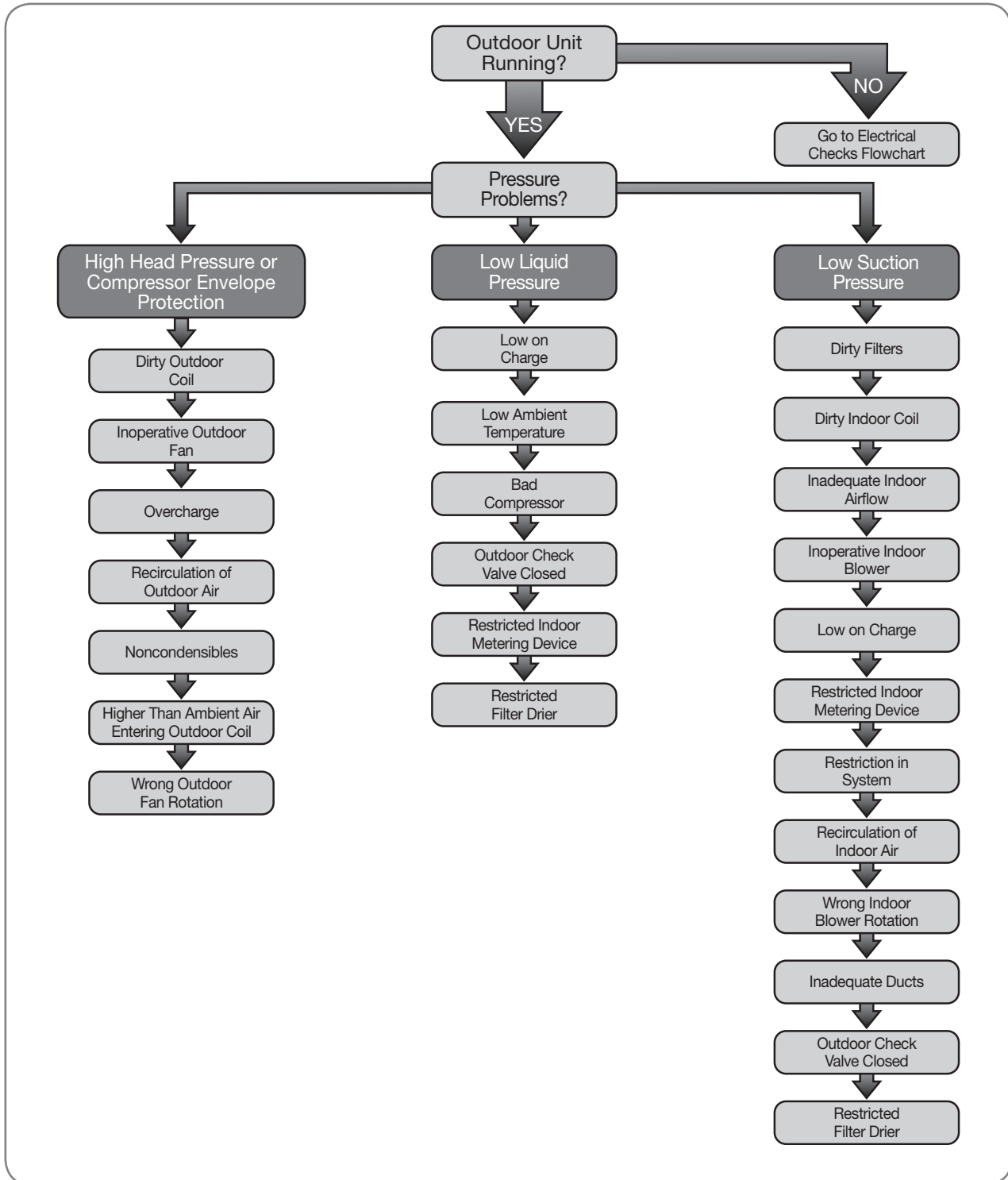

Heating Mechanical Checks Flowchart

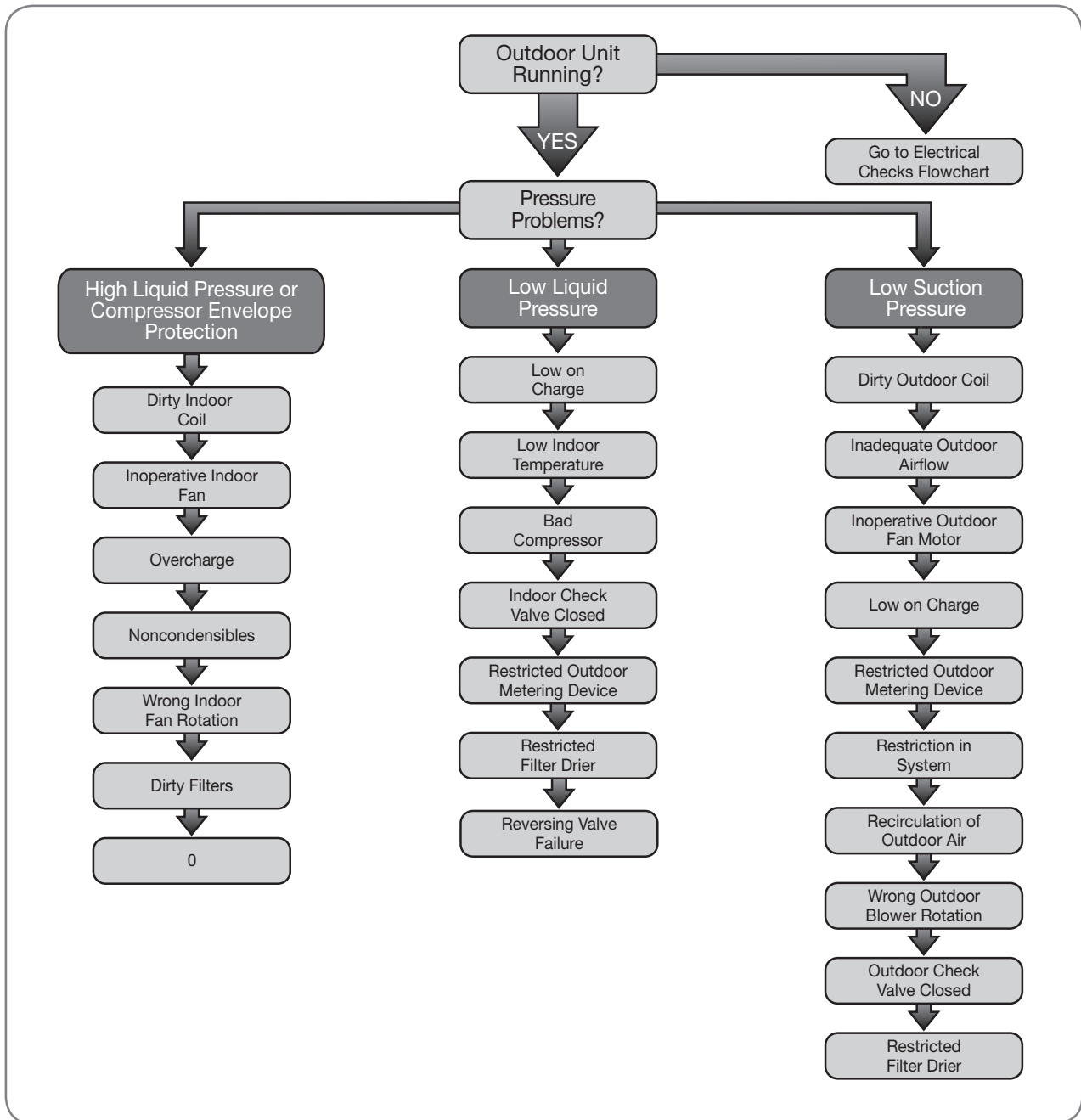

DIAGNOSTICS

Defrost Mechanical Checks Flowchart

Diagnosics

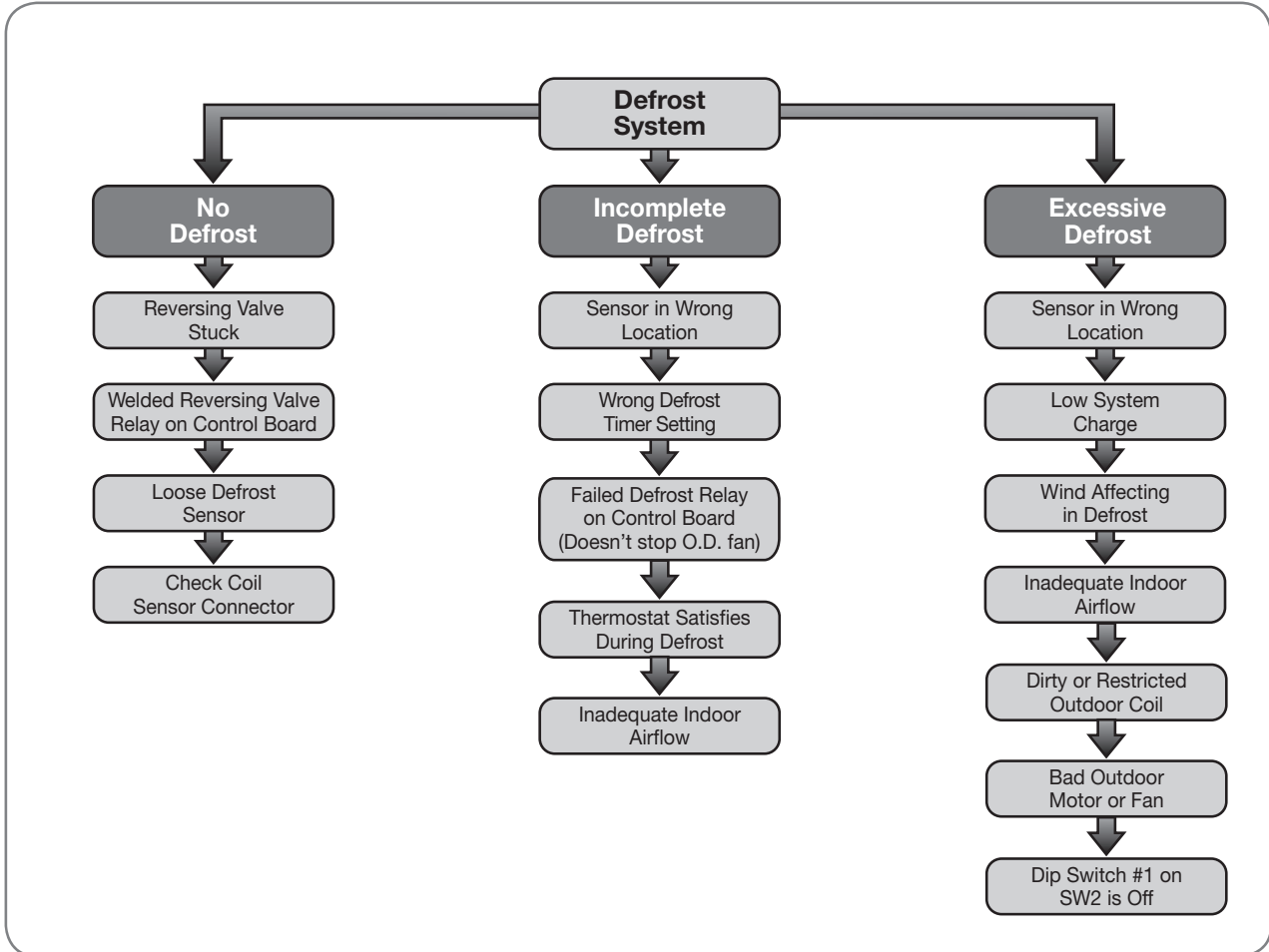

DIAGNOSTICS

General Troubleshooting Chart

⚠️ WARNING: Disconnect all power to unit before servicing. Contactor may break only one

side. Failure to shut off power can cause electrical shock resulting in personal injury or death.

SYMPTOM	POSSIBLE CAUSE	REMEDY
Unit will not run	<ul style="list-style-type: none"> Power off or loose electrical connection Thermostat out of calibration – set too high. Unit in active compressor protection lockout mode Defective control board Blown fuses/tripped breaker Transformer defective High-pressure control open Miswiring of communications (communication light on continuously) 	<ul style="list-style-type: none"> Check for correct voltage at line voltage connections in condensing unit. Reset – Power cycle high and low voltage to outdoor unit Check control board diagnostic codes. Replace fuses/reset breaker. Check wiring. Replace transformer. Reset. Also see high head pressure remedy. The high-pressure control opens at 610 PSIG. Check communication wiring.
Outdoor fan runs, compressor doesn't	<ul style="list-style-type: none"> Loose connection Communication cable disconnected or failed Compressor stuck, grounded or open motor winding, open internal overload. Low-voltage condition 	<ul style="list-style-type: none"> Check for correct voltage at filter and inverter. Check and tighten all connections. Check control board diagnostic codes. Replace
Insufficient cooling	<ul style="list-style-type: none"> Improperly sized unit Improper indoor airflow Incorrect refrigerant charge Air, noncondensibles, or moisture in system 	<ul style="list-style-type: none"> Recalculate load. Check airflow. Should be approximately 400 CFM per ton. Charge per procedure attached to unit service panel. Recover refrigerant. Evacuate and recharge. Replace filter drier.
Compressor short cycles	<ul style="list-style-type: none"> Incorrect voltage Improperly sized unit Refrigerant undercharge 	<ul style="list-style-type: none"> At inverter input terminals, voltage must be between 187-252VAC when unit is operating. Add refrigerant.
Registers sweat	<ul style="list-style-type: none"> Low indoor airflow 	<ul style="list-style-type: none"> Increase speed of blower or reduce restriction. Replace air filter.
High head, low vapor pressures	<ul style="list-style-type: none"> Restriction in liquid line, expansion device, or filter drier Stuck EXV 	<ul style="list-style-type: none"> Remove or replace defective component. Verify EXV operation.
High head, high or normal vapor pressure – Cooling mode	<ul style="list-style-type: none"> Dirty outdoor coil Refrigerant overcharge Outdoor fan not running Air or noncondensibles in system 	<ul style="list-style-type: none"> Clean coil. Correct system charge. Repair or replace. Recover refrigerant. Evacuate and recharge.
Low head, high vapor pressures	<ul style="list-style-type: none"> EXV in bypass mode Bad compressor 	<ul style="list-style-type: none"> Verify thermostat connections at EXV control Verify thermister and pressure transducer connection and operation Replace compressor.
Low vapor, cool compressor, iced indoor coil	<ul style="list-style-type: none"> Low indoor airflow Operating below 55°F outdoors Moisture in system Low ambient cooling not operating (coil or ambient thermister failure) 	<ul style="list-style-type: none"> Increase speed of blower or reduce restriction. Replace air filter. Recover refrigerant. Evacuate and recharge. Replace filter drier.
High vapor pressure	<ul style="list-style-type: none"> Excessive load Defective compressor 	<ul style="list-style-type: none"> Recheck load calculation. Replace compressor.
Fluctuating head and vapor pressures	<ul style="list-style-type: none"> EXV hunting Air or noncondensibles in system 	<ul style="list-style-type: none"> Check thermistor to vapor line connection. Check air distribution on coil. Check suction thermistor and pressure transducer operation Recover refrigerant. Evacuate and recharge. Remove & confirm EXV movement. Clean EXV inside with nitrogen to remove any debris then reinstall
Gurgle or pulsing noise at expansion device or liquid line	<ul style="list-style-type: none"> Air or noncondensibles in system 	<ul style="list-style-type: none"> Recover refrigerant. Evacuate and recharge.

DIAGNOSTICS

Service Analyzer Charts

COMPRESSOR OVERHEATING – HIGH DISCHARGE TEMP			
SYMPTOM	POSSIBLE CAUSE	CHECK/REMEDY	
High superheat (greater than 15°F [-9°C] at coil)	Low charge	Check system charge.	
	Verify suction thermistor operation (10k thermistor)	Replace thermistor.	
	Verify pressure transducer operation input and output voltage	Replace thermistor and/or harness and/or control board.	
	Faulty metering device, inadequate suction thermistor or pressure transducer operation.	Restricted cap tube, EXV	
		Foreign matter stopping flow	
	High internal load	Hot air (attic) entering return	
		Heat source on; miswired or faulty control	
	Restriction in liquid line	Drier plugged.	
		Line kinked.	
	Low head pressure	Low charge	
Operating in low ambient temperatures			
Suction or liquid line subjected to high heat source	Hot attic		
	Hot water line		
Low line voltage	Loose wire connections	Check wiring.	
	Power company problem, transformer	Have problem corrected before diagnosis continues.	
	Undersized wire feeding unit	Correct and complete diagnosis.	
High line voltage	Power company problem	Have problem corrected.	
High head pressure	Overcharge	Check system charge.	
	Dirty heat pump coil	Clean coil.	
	Faulty or wrong size heat pump fan motor	Replace fan motor.	
	Faulty fan blade or wrong rotation	Replace fan blade.	
		Replace with correct rotation motor.	
	Recirculation of air	Correct installation.	
	Additional heat source	Check for dryer vent near unit.	
		Check for recirculation from other equipment.	
Noncondensibles	Recover refrigerant. Evacuate and recharge system.		
Equipment not matched	Correct mismatch.		
Short cycling of compressor	Faulty pressure control	Replace pressure control.	
	Loose wiring	Check unit wiring.	
	Thermostat	Located in supply air stream	
		Differential setting too close	
		Customer misuse	
	EXV	Internal foreign matter	
		Pressure transducer failure	
		Suction thermistor failure	
		EXV control failure	
		EXV coil failure	
		Distributor tube/tubes restricted	
	Distributor tube	Restricted with foreign matter	
		Kinked	
I.D. reduced from previous compressor failure			

Service Analyzer Charts

COMPRESSOR OVERHEATING – HIGH DISCHARGE TEMP (cont.)		
SYMPTOM	POSSIBLE CAUSE	CHECK OR REMEDIES
Short cycling of compressor (cont.)	Low charge	Check system charge.
	Low evaporator airflow	Dirty coil
		Dirty filter
		Duct too small or restricted
	Faulty run capacitor	Replace.
Faulty internal overload	Replace compressor.	
ELECTRICAL		
SYMPTOM	POSSIBLE CAUSE	CHECK OR REMEDIES
Voltage present on load side of inverter and compressor won't run	Communication failure from ICC to inverter.	Check communication harness connectors and wire continuity.
	Compressor windings	Check for correct ohms.
187 – 252VAC present at input to inverter	Thermostat	Check for control voltage to contactor coil.
	Compressor control circuit	High-pressure switch
		Low-pressure cut-out
		Ambient thermostat
		Stater heat is active
Compressor timed off/on control or interlock		
No voltage at input to inverter	Blown fuses or tripped circuit breaker	Check for short in wiring or unit.
	Improper wiring	Recheck wiring diagram.
Improper voltage	High voltage	Wrong unit
		Power supply problem
	Low voltage	Wrong unit
		Power supply problem
		Wiring undersized
		Loose connections
FLOODED STARTS		
SYMPTOM	POSSIBLE CAUSE	CHECK OR REMEDIES
Liquid in the compressor shell	Faulty stator heat circuit (compressor thermistor or single leg output to compressor)	Replace compressor thermistor
		Check inverter for single leg output power and correct wiring.
Too much liquid in system	Incorrect piping	Check piping guidelines.
	Overcharge	Check and adjust charge.

DIAGNOSTICS

Service Analyzer Charts

CONTAMINATION		
SYMPTOM	POSSIBLE CAUSE	REMEDY
Moisture	Poor evacuation on installation or during service	In each case, the cure is the same. Recover refrigerant. Add filter drier, evacuate, and recharge.
High head pressure	Noncondensibles air	
Unusual head and suction readings	Wrong refrigerant or mixed refrigerants	
Foreign matter – copper filings	Copper tubing cuttings	
Copper oxide	Dirty copper piping or nitrogen not used when brazing	
Welding scale	Nitrogen not used during brazing	
Soldering flux	Adding flux before seating copper partway	
Excess soft solder	Wrong solder material	
LOSS OF LUBRICATION		
SYMPTOM	POSSIBLE CAUSE	REMEDY
Compressor failures	Line tubing too large	Reduce pipe size to improve oil return.
Low suction pressure	Low charge	Check system charge.
	Refrigerant leaks	Repair and recharge.
Cold, noisy compressor – Slugging	Dilution of oil with refrigerant	Observe piping guidelines.
Noisy compressor	Migration	Check stater heat and compressor thermistor.
Cold, sweating compressor	Flooding	Check system charge.
Low load	Reduced airflow	Dirty filter
		Dirty coil
		Wrong duct size
		Restricted duct
	Thermostat setting	Advise customer.
Short cycling of compressor	Faulty high- or low-pressure control	Replace control.
	Loose wiring	Check all control wires.
	Thermostat	In supply air stream, out of calibration
		Customer misuse
SLUGGING		
SYMPTOM	POSSIBLE CAUSE	REMEDY
On start-up	Incorrect piping	Review pipe size guidelines.
EXV hunting when running	Faulty EXV components	Check EXV, suction pressure transducer, and suction thermistor for operation.

Service Analyzer Charts

FLOODING			
SYMPTOM	POSSIBLE CAUSE	REMEDY	
Poor system control using an EXV	Bad pressure reading	Check transducer wiring.	
	Suction thermistor in wrong location	Relocate thermistor.	
	Bad suction thermistor	Replace thermistor.	
	Improper superheat setting (less than 5°F [-15°C])	Adjust EXV SH setpoint dipswitches and validate valve operation.	
ELECTRONIC EXPANSION VALVES			
SYMPTOM	POSSIBLE CAUSE	REMEDY	
High Superheat, Low Suction Pressure (superheat over 15°F [9°C])	Moisture freezing and blocking valve	Recover charge, replace filter-drier, evacuate system, recharge.	
	Dirt or foreign material blocking valve	Recover charge, replace filter-drier, evacuate system, recharge	
	Low refrigerant charge	Correct the charge.	
	Vapor bubbles in liquid line		Remove restriction in liquid line. Correct the refrigerant charge.
			Remove noncondensable gases.
			Size liquid line correctly.
	Undersized EXV	Replace with correct valve.	
	Incorrectly sensing vapor line temperature	Verify suction thermistor resistance is correct and properly attached and insulated to the vapor line.	
	Suction thermistor incorrectly calibrated.	Replace suction thermistor assembly.	
	Vapor pressure measured incorrectly.		After verifying lack of connectivity, replace the pressure transducer or harness.
			If harness has a short, replace harness
			If gauge pressure measurement and the converted voltage readings at the control are different replace pressure transducer
			If gauge pressure measurement and the converted voltage readings at the control are the same, replace the control.
	EXV is stuck		Remove EXV from the system and purge with nitrogen, replace filter drier, and recharge.
If EXV will not open, validate EXV wiring harness and rotor resistance between the black wire and the other 4 wires.			
If none of the above rectifies the issue, replace EXV and filter drier and recharge.			
ICC dc circuit failed	Verify 5Vdc to pressure transducer is present. If not, replace ICC.		
High superheat adjustment	Change the superheat offset dip switches to increase superheat.		

DIAGNOSTICS

Service Analyzer Charts

ELECTRONIC EXPANSION VALVES (cont.)		
SYMPTOM	POSSIBLE CAUSE	REMEDY
Valve feeds too much refrigerant, with low superheat, with low superheat and higher than normal suction pressure.	Moisture causing valve to stick open.	Recover refrigerant, replace filter-drier, evacuate system, and recharge.
	Dirt or foreign material causing valve to stick open	Recover refrigerant, replace filter-drier, remove EXV and purge with nitrogen, evacuate system, and recharge.
		If EXV is completely clogged use the ICC to open the EXV, and purge with nitrogen, replace filter drier, and recharge.
	Oversized EXV	Install correct EXV
	Incorrect suction thermistor location	Install suction thermistor with the provided stainless steel strap and an additional zip tie at the 10:00 or 2:00 position on suction line, with insulation.
	Low superheat adjustment	Change the superheat offset dip switches to increase superheat.
	Incorrectly sensing vapor line temperature	Verify suction thermistor resistance is correct and properly attached and insulated to the vapor line.
	Suction thermistor incorrectly calibrated.	Replace suction thermistor assembly.
	Vapor pressure measured incorrectly.	After verifying lack of connectivity, replace the pressure transducer or harness.
If harness has a short, replace harness		
If gauge pressure measurement and the converted voltage readings at the control are different replace pressure transducer		
If gauge pressure measurement and the converted voltage readings at the control are the same, replace the control.		
Compressor flood back upon start-up	Refrigerant drainage from flooded evaporator	Install trap riser to the top of the evaporator coil.
	Inoperable stator heat	Verify compressor thermistor (OST). Replace if needed.
	Any of the causes listed under Symptoms of Electrical Problems on page 60.	Any of the solutions listed under Solutions of Electrical Problems on page 60.

Service Analyzer Charts

ELECTRONIC EXPANSION VALVES (cont.)		
SYMPTOM	POSSIBLE CAUSE	REMEDY
Superheat is low to normal with low suction pressure	Unequal evaporator circuit loading	Ensure airflow is equally distributed through evaporator.
		Check for blocked distributor tubes.
	Low load or airflow entering evaporator coil	Ensure blower is moving proper air CFM.
		Remove/Correct any airflow restriction.
Superheat and suction pressure fluctuate (valve is hunting)	Expansion valve is oversized.	Install correct EXV
	Section thermister is affected by liquid refrigerant or refrigerant oil flowing through suction line	Relocate sensing bulb in another position around the circumference of the suction line.
	Unequal refrigerant flow through evaporator circuit	Ensure sensing bulb is located properly.
		Check for blocked distributor tubes.
Moisture freezing and partially blocking EXV	Recover refrigerant, change filter-drier, evacuate system, and recharge.	
Valve does not regulate at all	Pressure transducer not connected or plugged	Connect pressure transducer in proper location, or remove any blockage.
	Suction line thermistor not connected, or installed on heat effected zone.	Install suction line thermistor in correct horizontal clean section of copper pipe.
	Suction line thermistor failed (continuity to control, wire damaged, resistance values incorrect)	Replace suction line thermistor.

DIAGNOSTICS

COOLING MODE TROUBLESHOOTING TIPS					
SYSTEM PROBLEM	INDICATORS				
	DISCHARGE PRESSURE	SUCTION PRESSURE	SUPERHEAT Normal: 5°–15°F [-15° – -9°C]	SUBCOOLING Normal: See Charging Chart	COMPRESSOR AMPS
Overcharge	High	High	Low	High	High
Undercharge	Low	Low	High	Low	Low
Liquid Restriction (Drier)	Low	Low	High	High	Low
Low Indoor Airflow	Low	Low	Low	Low	Low
Dirty Outdoor Coil	High	High	Low	Low	High
Low Outdoor Ambient Temperature	Low	Low	High	High	Low
Inefficient Compressor	Low	High	High	High	Low
Indoor Suction Pressure Transducer Faulty Measurement	Low	Low	High	High	Low
Poorly Insulated Indoor Vapor Line Thermistor	High	High	Low	Low	High

HEATING MODE TROUBLESHOOTING TIPS					
SYSTEM PROBLEM	INDICATORS				
	DISCHARGE PRESSURE	SUCTION PRESSURE	SUPERHEAT Normal: 5°–15°F [-15° – -9°C]	SUBCOOLING Normal: See Charging Chart	COMPRESSOR AMPS
Overcharge	High	High	OK	High	High
Undercharge	Low	Low	OK or High	Low	Low
Liquid Restriction (Drier)	Low	Low	High	High	Low
Low Outdoor Airflow	Low	Low	Low	Low	Low
Dirty Indoor Coil	High	High	Low	Low	High
Low Indoor Ambient Temperature	Low	Low	OK	High	Low
Inefficient Compressor	Low	High	High	High	Low
Outdoor Suction Pressure Transducer Faulty Measurement	Low	Low	High	High	Low
Poorly Insulated Outdoor Suction Line Thermistor	High	High	Low	Low	High

WIRING DIAGRAM

