



Ruud Ultra™ Series Variable Speed Heat Pumps



UP20 Series

Efficiencies up to 20 SEER/14 EER/11.5 HSPF
Nominal Sizes 2, 3, 4 & 5 Ton
[7.03, 10.6, 14.06 & 17.6 kW]
Cooling Capacities 17.3 to 60.5 kBTU
[5.7 to 17.7 kW]



"Proper sizing and installation of equipment is critical to achieve optimal performance. Split system air conditioners and heat pumps must be matched with appropriate coil components to meet Energy Star. Ask your Contractor for details or visit www.energystar.gov."



- **PlusOne® Energy Efficiency** offers a minimum of 20 SEER and 11.5 HSPF system performance across all capacities. The UP20 achieves these performance measurements with RHMV variable speed air handlers, U802V two-stage, variable-speed 80% furnaces, U96V two-stage, variable-speed 96% furnaces and U97V and U98V modulating furnaces.
- **PlusOne® Expanded Valve Space** – 3"-4"-5" service valve space – provides a minimum working area of 27-square inches for easier access
- **PlusOne® Triple Service Access** – 15" wide, industry leading corner service access – makes repairs easier and faster. The three fastener removable corner allows optimal access to internal unit components. Individual louver panels come out once fastener is removed, for faster coil cleaning and easier cabinet reassembly
- **EcoNet® Enabled product.** The EcoNet Smart Home System provides advanced air & water control for maximum energy savings and ideal comfort.
- New composite base pan – dampens sound, captures louver panels, eliminates corrosion and reduces number of fasteners needed
- Powder coat paint system – for a long lasting professional finish
- The Copeland Scroll™ Variable Speed Compressor has a modulating technology which provides more precise temperature control, lower humidity and greater efficiency.
- Modern cabinet aesthetics – increased curb appeal with visually appealing design
- Equipped with electronic expansion valve to precisely control variable refrigerant flow.
- Improved tubing design – reduces vibration and stress, making unit quieter and reducing opportunity for leaks
- Optimized defrost characteristics - decrease defrosting and provide better home comfort
- Optimized reversing valve sizing – improves shifting performance for quieter unit operation and increased life of the system
- Enhanced mufflers – help to dissipate vibration energy for quieter unit operation
- Integrated heat pump lift receptacle – allows standard CPVC stands to be inserted into the base
- Curved louver panels – provide ultimate coil protection, enhance cabinet strength, and increased cabinet rigidity
- Optimized fan orifice – optimizes airflow and reduces unit sound
- Rust resistant screws – confirmed through 1500-hour salt spray testing
- Diagnostic service window with two-fastener opening – provides access to the high and low pressure.
- External gauge port access – allows easy connection of "low-loss" gauge ports
- Single-row condenser coil – makes unit lighter and allows thorough coil cleaning to maintain "out of the box" performance
- 35% fewer cabinet fasteners and fastener-free base – allow for faster access to internal components and hassle-free panel removal
- Service trays – hold fasteners or caps during service calls
- QR code – provides technical information on demand for faster service calls
- Fan motor harness with extra long wires allows unit top to be removed without disconnecting fan wire.
- High and low pressure transducers standard on all models.

TABLE OF CONTENTS

Standard Feature	3
Available SKUs	3
Features & Benefits	4-8
Model Number Identification	9-10
General Data/Electrical Data	11
Accessories	12
Weighted Sound Power	12
Smart Home Systems	13
Unit Dimensions.....	14
Clearances.....	15
Wiring Diagrams	16
Refrigerant Line Size Information	17-18
Capacity Ranges	19-22
Performance Data	23-25
Guide Specifications	26
Limited Warranty	27

Standard Feature Table

Feature	STANDARD FEATURES			
	24	36	48	60
R-410A Refrigerant	✓	✓	✓	✓
Maximum SEER	20	20	19.5	19.5
Maximum EER	14	14	12.5	12.5
Maximum HSPF	11.5	11.5	11	11
EcoNet Enabled	✓	✓	✓	✓
Copeland Scroll™ Variable Speed Compressor	✓	✓	✓	✓
Compressor Sound Blanket	✓	✓	✓	✓
Variable speed outdoor fan motor	✓	✓	✓	✓
Swept wing fan blade	✓	✓	✓	✓
Field Installed Filter Drier	✓	✓	✓	✓
Front Seating Service Valves	✓	✓	✓	✓
Internal Pressure Relief Valve	✓	✓	✓	✓
Internal Thermal Overload	✓	✓	✓	✓
Low Ambient capability	✓	✓	✓	✓
3-4-5 Expanded Valve Space	✓	✓	✓	✓
Composite Basepan	✓	✓	✓	✓
1" Screw Control Box Access	✓	✓	✓	✓
15" Access to Internal Components	✓	✓	✓	✓
Quick release louver panel design	✓	✓	✓	✓
No fasteners to remove along bottom	✓	✓	✓	✓
Optimized Venturi Airflow	✓	✓	✓	✓
Single row condenser coil	✓	✓	✓	✓
Powder coated paint	✓	✓	✓	✓
Rust resistant screws	✓	✓	✓	✓
QR code	✓	✓	✓	✓
External gauge ports	✓	✓	✓	✓
Service trays	✓	✓	✓	✓

✓ = Standard

Available SKUs

Available Models	Description
UP2024BJVCA	2 ton EcoNet® Enabled inverter driven Ruud <i>Ultra</i> ™ Series Variable Speed Heat Pump-208/230/1/60
UP2036BJVCA	3 ton EcoNet® Enabled inverter driven Ruud <i>Ultra</i> ™ Series Variable Speed Heat Pump-208/230/1/60
UP2048BJVCA	4 ton EcoNet® Enabled inverter driven Ruud <i>Ultra</i> ™ Series Variable Speed Heat Pump-208/230/1/60
UP2060BJVCA	5 ton EcoNet® Enabled inverter driven Ruud <i>Ultra</i> ™ Series Variable Speed Heat Pump-208/230/1/60

Introduction to UP20 Heat Pump

The UP20 is our EcoNet® Enabled, Inverter Driven *Ultra™* Series Variable Speed Heat Pump and is part of the Ruud Heat Pump product line that extends from 13 to 20 SEER. This highly featured and reliable heat pump is designed for years of dependable, efficient operation when matched with Ruud indoor aluminum evaporator coils and furnaces or air handlers.

The *Ultra™* Series UP20 is part of a new line of Ruud smart heating, cooling and water heating products. Using the latest in sensor technology and a powerful EcoNet® monitoring system, Ruud provides homeowners with a new level of protection, control and energy savings. Ruud smart heating, cooling and water heating products will alert the homeowner if there is ever an issue via the EcoNet Smart Thermostat (1) and the EcoNet Mobile app. The EcoNet Mobile App makes it easy for homeowners to manage their home comfort environment at home or on-the-go*, while enjoying the convenience and savings benefits of a highly efficient system.

Along with the EcoNet Smart Home System the UP20 is matched with the RHMV Constant CFM Variable Speed EcoNet Enabled Air Handler (2) or can be applied in a Furnace application with the EcoNet Enabled Two-Stage Variable Speed U802V or U96V Gas Furnaces or the fully modulating U97V and U98V and RCF Aluminum Cased Furnace Coils with EEV (3). See individual specification documents for more details of the indoor products.

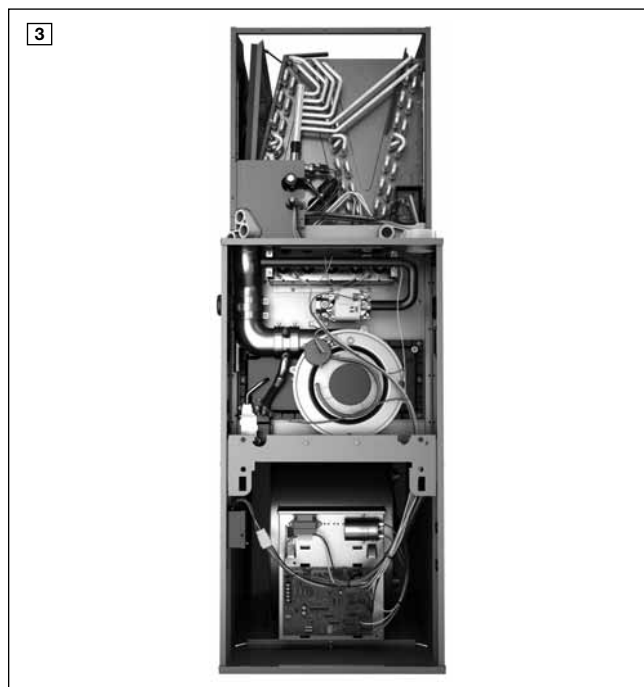
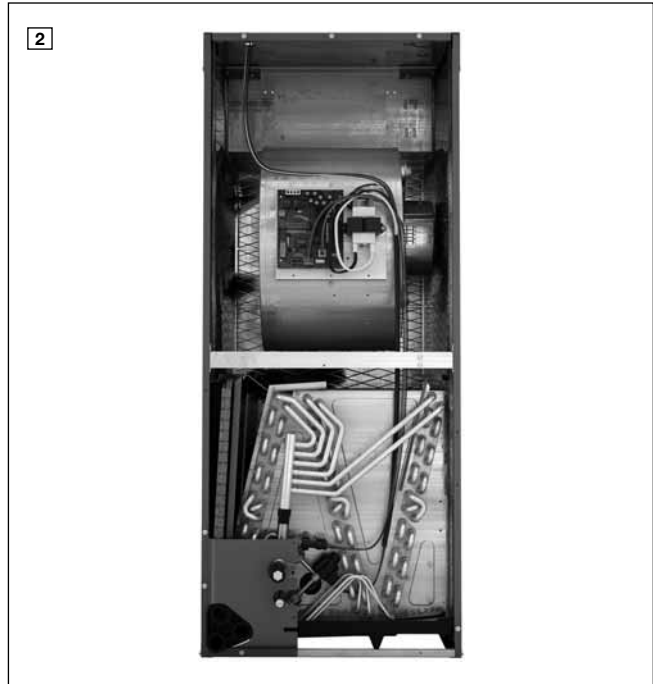

*WiFi broadband internet connection required. Download the EcoNet App from the App Store or Google Play to set up your EcoNet Smart Thermostat. Receipt of notifications depend on home WiFi set up. WiFi broadband internet connection required.



How It Works

The EcoNet® Enabled, Inverter Driven Ruud® *Ultra*™ Series Variable Speed Heat Pump's (1) variable speed outdoor unit control (VSODU) (2) continuously monitors the EcoNet control temperature and humidity set point, suction pressure (3), suction temperature (4), outdoor coil temperature (5) and outdoor temperature (6) and feeds this information to the Copeland Inverter Control Motor Drive (7). The Copeland Inverter Control Motor Drive converts AC to DC power, sends it to the Copeland Scroll™ variable speed compressor (8) Brushless Permanent Magnet motor (BPM), dynamically adjusting its speed. Simultaneously the VSODU provides input to the ECM outdoor fan motor (9) which is equipped with the latest

swept wing fan technology (10) and the Electronic Expansion Valve (EEV) (11) which syncs up with the compressor speed to deliver the exact capacity the home needs to meet its comfort requirements. The result of this advanced technology is significantly optimized energy efficiency and comfort. Energy efficiency is improved by precise load matching, less cycling on and off and low amp gradual compressor, outdoor and indoor motor operation. Comfort is improved by precise temperature control, precise humidity control and extra capacity during extreme summer and cold weather conditions.

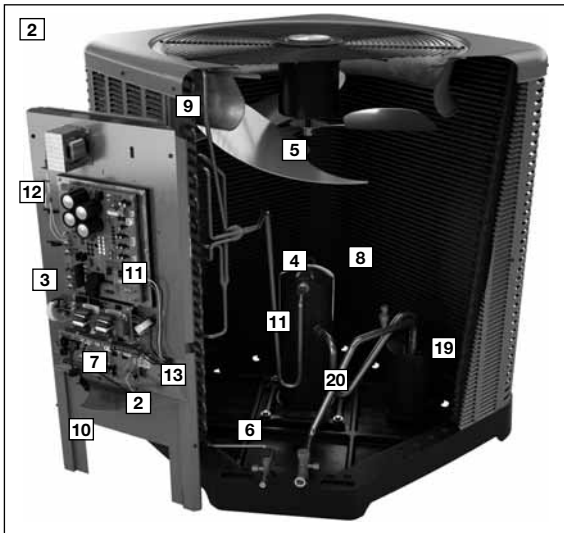

System Component Descriptions

EcoNet Smart Thermostat – (1): The EcoNet Smart Thermostat serves as the hub of communication for a home’s Heating, Cooling and Water Heating systems and is required to operate an EcoNet Enabled Heating and Cooling system in a fully communicating mode. The EcoNet Smart Thermostat displays detail diagnostic from outdoor and indoor connected units.

Variable Speed Outdoor Unit Control (VSODU) – (2) is where control wiring is hooked to the UP20. The VSODU control takes input from the EcoNet Control Center, outdoor suction temperature and pressure sensors, outdoor air and coil temperatures and communicates to the Copeland Inverter Control Motor Drive, EEV, reversing valve, outdoor fan and indoor blower to precisely control system capacity output of the heat pump in heating and cooling modes. It also is equipped with Dual Seven-Segment Display for technician interface, operation status and fault code communication. Two momentary buttons allow technician to initiate various operating modes. Various LED’s communicate active EcoNet communication, microprocessor activity and EEV operation. See I&O for more details.

The Copeland Inverter Control Motor Drive – (3) converts incoming single-phase AC power to 3 phase DC simulated sine wave power. Once power is converted the Copeland Inverter Control Motor Drive varies frequency of the power to the compressor varying the compressor speed. The Copeland Inverter Control Motor Drive has active protection algorithms that keep the compressor safely inside its operating envelope.

The Copeland Scroll™ Variable Speed compressor – (4) utilizes a Brushless Permanent Magnet Motor (BPM) that varies the Scroll speed, thus, varying the refrigerant flow. The robust scroll design has proven reliability over competing compressor technologies.

Swept Wing Fan Blade – (5) is the latest technology in outdoor fans that increase efficiency and reduces air noise.

The Electronic Expansion Valve (EEV) – (6) is an electronically driven refrigerant control valve. A small stepper motor is used to open and close valve to precisely control refrigerant

flow. It is controlled by the VSODU, which receives input from the pressure transducer and suction line temperature sensor to control the UP20 in the heating mode. The VSODU drives it fully open in the cooling mode. The EEV is superior to a TXV (thermostatic expansion valve) because the EEV controls superheat at the evaporator coil under varying load and refrigerant flow conditions, more precisely than traditional TXV’s.

The Filter – (7) is an electrical device that “cleans” the AC power component. This low pass filter only permits the passage of 60-Hertz signal to the inverter drive.

The Pressure Transducer – (8) is used to measure suction pressure in the outdoor heat pump. The VSODU takes this input to operate the EEV and make decisions on system operation such as low ambient cooling.

Various temperature sensors – are located on the Heat Pump. There is an outdoor air sensor (10), an outdoor coil sensor (9), a discharge line temperature sensor (not shown, located on discharge line), a suction line temperature sensor (11) and a compressor sump temperature sensor (not shown, located bottom of compressor). The VSODU uses these temperature measurements to operate the system.

The Choke – (12) is provided to absorb power spikes that might occur on the DC line.

Ferrite Rings – (13) are iron cores through which AC power is looped keeping any electrical noise contained. They also reduce the induction of electrical transient into the DC drive.

The Suction Accumulator – (14) prevents liquid refrigerant from entering the compressor.

The Reversing Valve – (15) reverses the flow of refrigerant in cooling versus heating.

Features

In addition all UP20 *Ultra*™ Series Inverter Driven Variable Speed Heat Pumps have the following features:

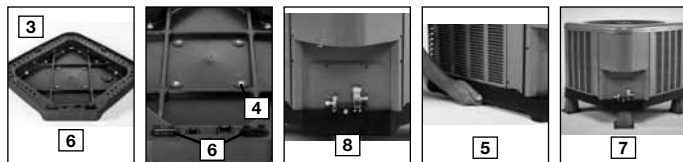

Our unique composite base (3) reduces sound emission, eliminates rattles, significantly reduces fasteners, eliminates corrosion and has integrated brass compressor attachment inserts (4). Furthermore it has incorporated into the design, water management features, means for hand placement (5) for unit maneuvering, screw trays (6) and inserts for lifting off unit pad. (7)

Service Valves (8) are rigidly mounted in the composite base with 3" between suction and discharge valves, 4" clearance below service valves and a minimum of 5" above the service valves, creating industry leading ease of installation. The minimum

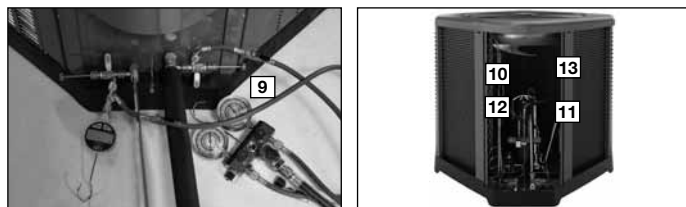

27 square-inches around the service valves allows ample room to remove service valve schrader prior to brazing, plenty of clearance for easy brazing of the suction and discharge lines to service valve outlets, easy access and hookup of low loss refrigerant gauges (9), and access to the service valve caps for opening.

Controls are accessed from the corner of the unit by removing only one fastener from the control access cover, revealing the industry's largest 15" wide and 22" tall control area (10). With all this room in the control area the high voltage electrical whip (11) can easily be inserted through the right size opening in the bottom of the control area. Routing it leads directly to lugs for connection. The low voltage control wires (12) are easily connected to the units VSODU terminal strip. The service window (14) can be removed by removing two screws, to access the EEV and view interior of unit. (15) (High and low pressure is standard on UP20 models).

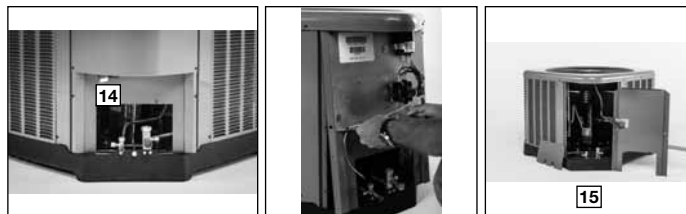

If in the rare event, greater access is needed to internal components, such as the compressor, the entire corner of the unit can be removed along with the top cover assembly to have unprecedented access to interior of the unit (16). Extra wire length is incorporated into each outdoor fan and compressor so top cover and control panel can be positioned next to the unit. Or with minimal effort the plug can be removed from the compressor and the outdoor fan wires can be removed from the VSODU to allow even more uncluttered access to the interior of the unit

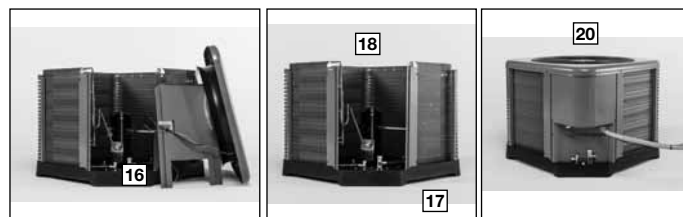

(17). Outdoor coil heights range from as short as 35" to 48". Disassembly to this degree and complete reassembly only takes a first time service technician less than 10 minutes. (17)

All units utilize formed louver panels which provide industry leading coil protection. Louver removal for coil cleaning is accomplished by removing one screw and lifting the panel out of the composite base pan. (19) All UP20 units utilize single row coils (18) making cleaning easy and complete, restoring the performance of the air conditioner back to out of the box performance levels year after year.

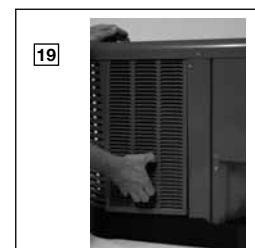

The outdoor fan motor has sleeve bearings and is inherently protected. The motor is totally enclosed for maximum protection from weather, dust and corrosion. (20) Access to the outdoor fan is made by removing four fasteners from the fan grille. The outdoor fan can be removed from the fan grille by removing 4 fasteners in the rare case outdoor fan motor fails.

Each cabinet has optimized composite (21) fan orifice assuring efficient and quiet airflow.



The entire cabinet has post powder paint (22) achieving 1000 hour salt spray rating, allowing the cabinet to retain its aesthetics throughout its life.

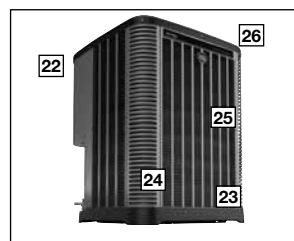

The Copeland Scroll™ Variable Speed compressors (28) with standard internal pressure relief and internal thermal overload are used on all capacities assuring longevity of high efficient and quiet operation for the life of the product. All UP20 Heat Pump come standard with high and low pressure transducers reinforced vinyl compressor sound covers containing a 1 1/2 inch thick batt of fiberglass insulation and open edges are sealed with a 1 inch wide hook and loop fastening tape for superior sound quality.

Features (con't.)

Each unit is shipped with filter drier for field installation and will trap any moisture or dirt that could contaminate the refrigerant system.

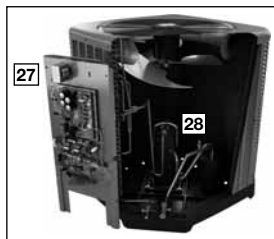

All cabinets have industry leading structural strength due to the composite base pan (23), interlocking corner post (24), formed curved louver panels (25) and drawn top cover (26) making it the most durable cabinet on the market today.

Each UP20 capacity has undergone rigorous psychometric testing to assure performance ratings of capacity, SEER and EER per AHRI Standard 210/240 rating conditions. Also each unit bears the UL mark and each unit is certified to UL 1995 safety standards.



Each unit has undergone specific strain and modal testing to assure tubing (27) is outside the units natural frequency and that the suction and discharge lines connected to the compressor withstand any starting, steady state operation, or shut down forces imposed by the compressor.

All units have been sound tested in sound chamber to AHRI 270 rating conditions, and A-weighted Sound Power Level tables produced, assuring units have acceptable noise qualities (see page 12). Each unit has been ran in cooling operation at 95°F and sound ratings for the UP20 range from as low as 56 dBA at low speed and as high as 76 dBA at 95°F rated conditions.

All units have been ship tested to assure units meet stringent "over the road" shipping conditions.

As manufactured, all units in the UP20 family have cooling capability to 0°F without the addition of an ambient control. Factory testing is performed on each unit. All component parts meet well defined specification and continually go through receiving inspections. Each component installed on a unit is scanned, assuring correct component utilization for a given unit capacity and voltage. All condenser coils are leak tested with pressurization test to 550#s and once installed and assembled, each units' complete refrigerant system is helium leak tested. All units are fully charged from the factory for up to 15 feet of piping. All units are factory run tested. The UP20 has a 10-year conditional unit replacement warranty (registration required) and a 10 year limited parts warranty.

Required Control EcoNet Smart Thermostat



UETST700SYS

The EcoNet Smart Thermostat serves as the hub of communication for a home's Heating, Cooling and Water Heating systems, and is required to operate an EcoNet Enabled Heating & Cooling system in a fully communicating mode.

Optional Accessories

(Refer to accessory chart for model #)

3"/6"/12"

- Gray high density polyethylene feet are available to raise unit off of mounting surface away from moisture
- Thermistor Kit – RXHT-A02

Heat Pumps (For Reference)**

<u>U</u>	<u>P</u>	<u>20</u>	<u>24</u>	<u>A</u>	<u>J</u>	<u>V</u>	<u>C</u>	<u>A</u>	<u>*</u>
Brand	Product Category	SEER	Capacity† BTU/HR	Major Series*	Voltage	Type	Controls	Minor Series**	Option Code
Ruud	P - Heat Pump	13 - 13 SEER 14 - 14 SEER 15 - 15 SEER 16 - 16 SEER 17 - 17 SEER 20 - 20 SEER	18 - 18,000 [5.28 kW] 24 - 24,000 [7.03 kW] 30 - 30,000 [8.79 kW] 36 - 36,000 [10.55 kW] 42 - 42,000 [12.31 kW] 48 - 48,000 [14.07 kW] 60 - 60,000 [17.58 kW]	A - 1st Design B - 2nd Design	J - 1ph, 208-230/60 C - 3ph, 208-230/60 D - 3ph, 460/60	1 - Single-stage 2 - Two-stage V - Inverter P - Piston	C - Communicating N - Non-Communicating	A - 1st Design	N/A

*See page 3 for available SKU's.

†Two-stage and inverter available in whole capacities only.

Air Conditioners*

<u>U</u>	<u>A</u>	<u>20</u>	<u>24</u>	<u>A</u>	<u>J</u>	<u>V</u>	<u>C</u>	<u>B</u>	<u>*</u>
Brand	Product Category	SEER	Capacity† BTU/HR	Major Series*	Voltage	Type	Controls	Minor Series**	Option Code
Ruud	A - Air Conditioners	13 - 13 SEER 14 - 14 SEER 16 - 16 SEER 17 - 17 SEER 20 - 20 SEER	18 - 18,000 [5.28 kW] 24 - 24,000 [7.03 kW] 30 - 30,000 [8.79 kW] 36 - 36,000 [10.55 kW] 42 - 42,000 [12.31 kW] 48 - 48,000 [14.07 kW] 60 - 60,000 [17.58 kW]	A - 1st Design B - 2nd Design	J - 1ph, 208-230/60 C - 3ph, 208-230/60	1 - Single-stage 2 - Two-stage V - Inverter	C - Communicating N - Non-Communicating	B - High and low pressure control	N/A

*See page 3 for available SKU's.

†Two-stage and inverter available in whole capacities only.

Furnace Coils (For Reference)**

<u>R</u>	<u>C</u>	<u>F</u>	<u>24</u>	<u>17</u>	<u>S</u>	<u>E</u>	<u>A</u>	<u>M</u>	<u>C</u>	<u>A</u>	<u>*</u>
Brand	Product Category	Type	Capacity BTU/HR	Width	Efficiency	Metering Device	Major Series*	Orientation	Casing	Minor Series**	Option Code
Ruud	C - Evap Coil	F - Furn Coil H - Air-Handler Coil	24 - 24,000 [7.03 kW] 36 - 36,000 [10.55 kW] 48 - 48,000 [14.07 kW] 60 - 60,000 [17.58 kW]	14 - 14" 17 - 17.5" 21 - 21" 24 - 24.5"	S - Standard Eff. M - Mid Eff. H - High Eff. U - Ultra Eff.	T-TXV E-EEV P-Piston	A - 1st Design	M - Multipoise V - Vertical only/ convertible H - Ded. Horizontal only	C - Cased U - Uncased	A - 1st Design	N/A

NOTE: The above Model Number ID's are for reference only. Available SKU's are listed on the standard features/available SKU page of model spec sheet.

[] Designates Metric Conversions

90%+ AFUE Gas Furnaces (For Reference)**

U	96	V	A	70	2	3	17	M	S	A
Brand	Series	Motor	Major Rev	Input BTU/HR	Stages	Air Flow	Cabinet Width	Configuration	Nox	Minor Rev
Ruud	90 - 90 AFUE	V - Variable speed	A - 1st Design	040 - 42,000 [12.31 kW]	1 - Single-stage	3 - up to 3 ton	14 - 14"	M - Multi	X - Low Nox	A - 1st Design
	92 - 92 AFUE	T - Constant Torque		060 - 56,000 [16.41 kW]	2 - Two-stage	5 - 3 1/2 up to 5 ton	17 - 17.5"		S - Standard	
	95 - 95 AFUE	(X-13)		070 - 70,000 [20.51 kW]	M - Modulating		21 - 21"			
	96 - 96 AFUE	P - PSC		085 - 84,000 [24.62 kW]			24 - 24.5"			
	97 - 97 AFUE			100 - 98,000 [28.72 kW]						
				115 - 112,000 [32.82 kW]						

80% AFUE Gas Furnaces (For Reference)**

U	80	2	V	A	075	3	17	M	S	A
Brand	Series	Stages	Motor	Major Rev	Input BTU/HR	Air Flow	Cabinet Width	Configuration	Nox	Minor Rev
Ruud	80 - 80+ AFUE	1 - Single-stage	V - Variable speed	A - 1st Design	050 - 50,000 [15 kW]	3 - up to 3 ton	14 - 14"	M - Multi	X - Low Nox	A - 1st Design
		2 - Two-stage	T - Constant Torque (X-13)		075 - 75,000 [22 kW]	4 - 2 1/2 up to 4 ton	17 - 17.5"	D - Down	S - Standard	
			P - PSC premium		100 - 100,000 [29 kW]	5 - 3 1/2 up to 5 ton	21 - 21"	Z - Down & zero clearance		
			S - PSC standard		125 - 125,000 [37 kW]		24 - 24.5"	down flow		
					150 - 150,000 [44 kW]					

Air Handlers (For Reference)**

R	H	M	V	36	17	S	E	A	C	J	A	000	*
Brand	Product Category	Stages of Airflow	Motor Type	Capacity BTU/HR	Width	Coil Size	Metering Device	Major Series*	Controls	Voltage	Minor Series**	Factory Heat Cap	Option Code
Ruud	H - Air Handler	1 - Single-Stage	V - Variable Speed	24 - 24,000 [7.03 kW]	14 - 14"	S - Standard Eff.	T - TEV	A - 1st Design	C - Communicating	J - 1ph, 208-240/60	A - 1st Design	00 - no factory heat with option code	*TBD
		2 - Two-Stage	T - Constant Torque	36 - 36,000 [10.55 kW]	17 - 17.5"	M - Mid Eff.	E - EEV		N - Non-comm				
		M - Modulating	P - PSC	48 - 48,000 [14.07 kW]	21 - 21"	H - High Eff.	P - Piston						
				60 - 60,000 [17.58 kW]	24 - 24.5"								

NOTE: The above Model Number ID's are for reference only. Available SKU's are listed on the standard features/available SKU page of model spec sheet.

[] Designates Metric Conversions

Physical Data				
Model No.	UP2024B	UP2036B	UP2048B	UP2060B
Nominal Tonnage	2.0	3.0	4.0	5.0
Valve Connections				
Liquid Line O.D. – in.	3/8	3/8	3/8	3/8
Suction Line O.D. – in.	3/4	3/4	7/8	1-1/8
Refrigerant (R-410A) furnished oz. ¹	210	212	222	252
Compressor Type	Scroll			
Outdoor Coil				
Net face area – Outer Coil	28.3	28.3	32.5	32.5
Tube diameter – in.	0.375	0.375	0.375	0.375
Number of rows	1	1	1	1
Fins per inch	20	20	20	20
Outdoor Fan				
Diameter – in.	26	26	26	26
Number of blades	3	3	3	3
Motor hp	1/2	1/2	1/2	1/2
Shipping weight – lbs.	278	298	298	301
Operating weight – lbs.	282	306	306	309

Electrical Data				
Line Voltage Data (Volts-Phase-Hz)	208/230-1-60	208/230-1-60	208/230-1-60	208/230-1-60
Maximum overcurrent protection (amps) ²	30	50	60	60
Minimum overcurrent protection	25	40	50	50
Minimum circuit ampacity ³	22	32	37	42
Compressor				
Rated load amps	15.4	24	28.1	31.7
Locked rotor amps	35	50	50	50
Condenser Fan Motor				
Full load amps	1.9	1.8	1.2	2
Locked rotor amps	N/A	N/A	N/A	N/A

¹Refrigerant charge sufficient for 15 ft. length of refrigerant lines. For longer line set requirements see the installation instructions for information about set length and additional refrigerant charge required.

²HACR type circuit breaker or fuse.

³Refer to National Electrical Code manual to determine wire, fuse and disconnect size requirements.

Accessories

Model No.	UP2024	UP2036	UP2048	UP2060
EcoNet Smart Thermostat	UETST700SYS	UETST700SYS	UETST700SYS	UETST700SYS
Heat pump Riser 6 in.	686020	686020	686020	686020
Supply Return Sensor	RXHT-A02	RXHT-A02	RXHT-A02	RXHT-A02
Rheem Show Unit Shell	RXHD-CU4	RXHD-CU4	RXHD-CU4	RXHD-CU4

Weighted Sound Power Level (dBA)

UP20 Sound Power Level										
Model	Sound Power Level [dB(A)] Low Speed/ High Speed	Full Octave Linear Sound Power Level dB - Center Frequency - Hz								Sound Power Level [dB(A)] with Sound Blanket
		125	250	500	1000	2000	4000	6300	8000	
UP2024B	59	34.8	39.7	50.8	48.4	42.5	40.2	34.6	34.5	Sound Blankets - Standard
	69	45.0	50.6	59.5	57.9	56.6	49.5	45.7	44.8	
UP2036B	60	33.6	38.3	57.6	48.2	43.6	39.7	43.0	39.3	
	70	44.8	51.1	60.8	60.1	56.2	50.3	49.9	48.3	
UP2048B	59	34.0	38.9	52.3	48.0	43.5	39.8	42.2	37.3	
	73	48.5	54.4	65.4	63.1	58.0	55.0	53.3	51.6	
UP2060B	58	36.0	39.3	51.4	46.2	43.8	43.0	41.3	40.2	
	73	49.8	54.0	68.0	59.2	55.9	53.7	50.7	49.3	

NOTE: Tested in accordance with AHRI Standard 270-08 (not listed in AHRI)



THE ECONET® SMART THERMOSTAT

BUILT-IN WIFI

4.3" LCD TOUCH SCREEN

LOCAL WEATHER – Current conditions plus 6-day forecast

5 OPERATING MODES – Heat, Cool, Auto, Emergency Heat and Fan Only

7-DAY PROGRAMMABLE SCHEDULE – Offers comfort without thought

ONE-TOUCH AWAY – Quickly switch to your energy-saving away preferences

VACATION SCHEDULING – Allows you to save while you're away and come home to comfort

MOTION SENSOR – Automatically wakes the screen as you approach

STANDBY SCREEN – Displays indoor temperature and current weather



UETST700SYS

OPERATIONAL FEATURES

AUTOMATIC CHANGEOVER – Transitions between heating and cooling automatically to keep the house comfortable

INTEGRATED WATER CONTROL – Enables easy water heater management

SMOOTH ARRIVAL – Prompts the system to start ahead of schedule to ensure the home is at the desired temperature at the scheduled time

HUMIDITY CONTROL – Supports humidifier accessories or over-cool based dehumidification

DETAILED OPERATING STATUS – View pertinent equipment status information and run times

CONTINUOUS FAN – Offers 5 speeds (Low, Medium Low, Medium, Medium High, High)

SHORT-CYCLE PROTECTION – Avoids damage to equipment from short run cycles

MONITORING & REMOTE CONTROL FEATURES

ACTIVE MONITORING – Alerts to problems that need immediate attention

REMOTE CONTROL – Allows adjusting of comfort and settings from anywhere using a mobile device

SERVICE ALERTS – Sends routine maintenance reminders

AIR FILTER MONITORING – Detects when it's time to replace the air filter

ALARM HISTORY – Displays time-stamped alarm codes with clear descriptions

ECONET SMART THERMOSTAT COMPATIBILITY

Models	Heating & Cooling									
	Gas Furnaces				Air Handlers		Air Conditioners		Heat Pumps	
	U802V	U96V	U97V	U98V	RHMV	RH2T	UA20	UA17*	UP20	UP17
UETST700SYS	✓	✓	✓	✓	✓	✓	✓	✓	✓	✓

*Models not EcoNet Enabled: RA1724AJ2NB, RA1736AJ2NB, RA1748AJ2NB, RA1760AJ2NB

Unit Dimensions

MODEL NO.	OPERATING						SHIPPING					
	H (Height)		L (Length)		W (Width)		H (Height)		L (Length)		W (Width)	
	INCHES	mm	INCHES	mm	INCHES	mm	INCHES	mm	INCHES	mm	INCHES	mm
UP2024	39	990	35.75	908	35.75	908	41.56	1056	39.37	999	39.64	1006
UP2036	39	990	35.75	908	35.75	908	53.56	1360	39.37	999	39.64	1006
UP2048	51	1295	35.75	908	35.75	908	53.56	1360	39.37	999	39.64	1006
UP2060	51	1295	35.75	908	35.75	908	53.56	1360	39.37	999	39.64	1006

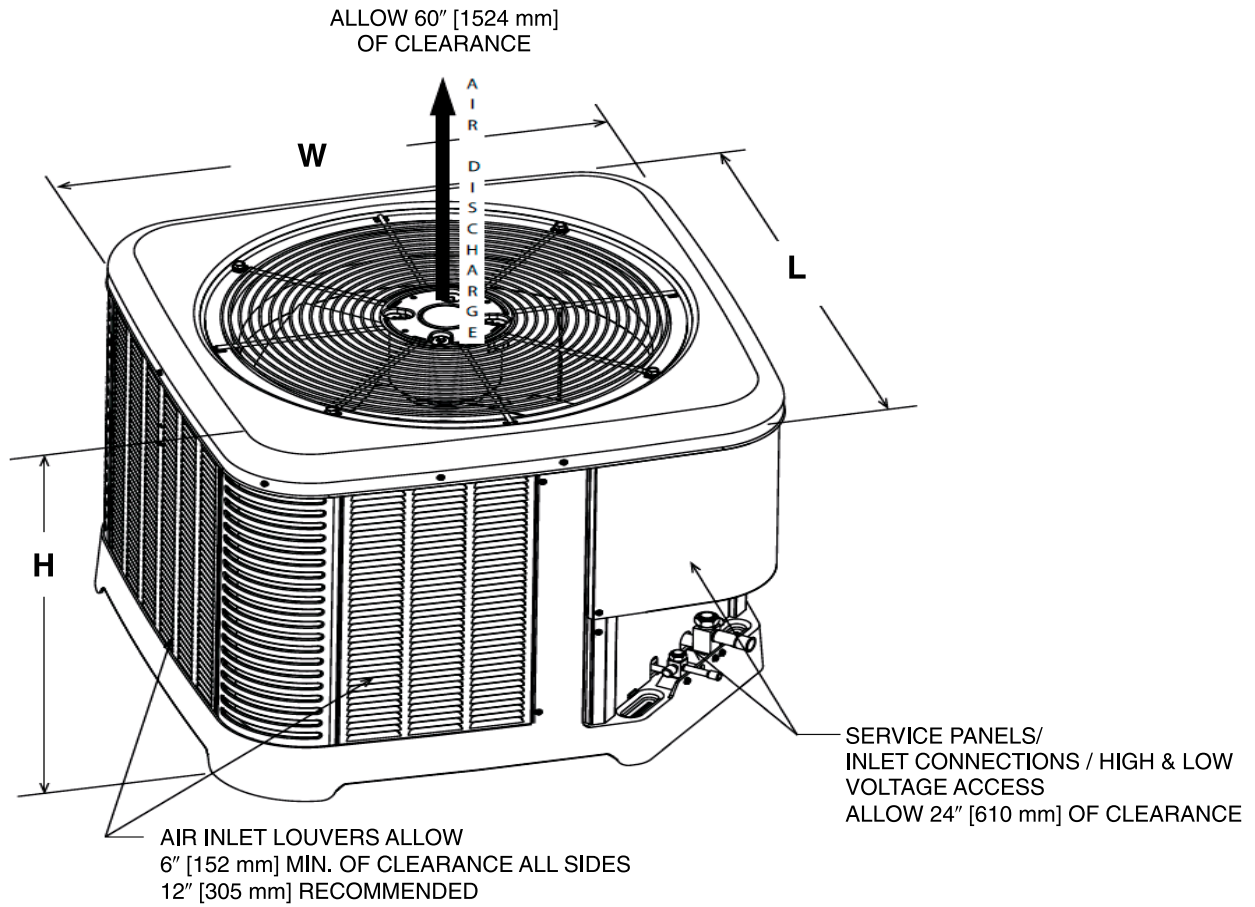

[] Designates Metric Conversions

ST-A1226-02-00

CLEARANCES

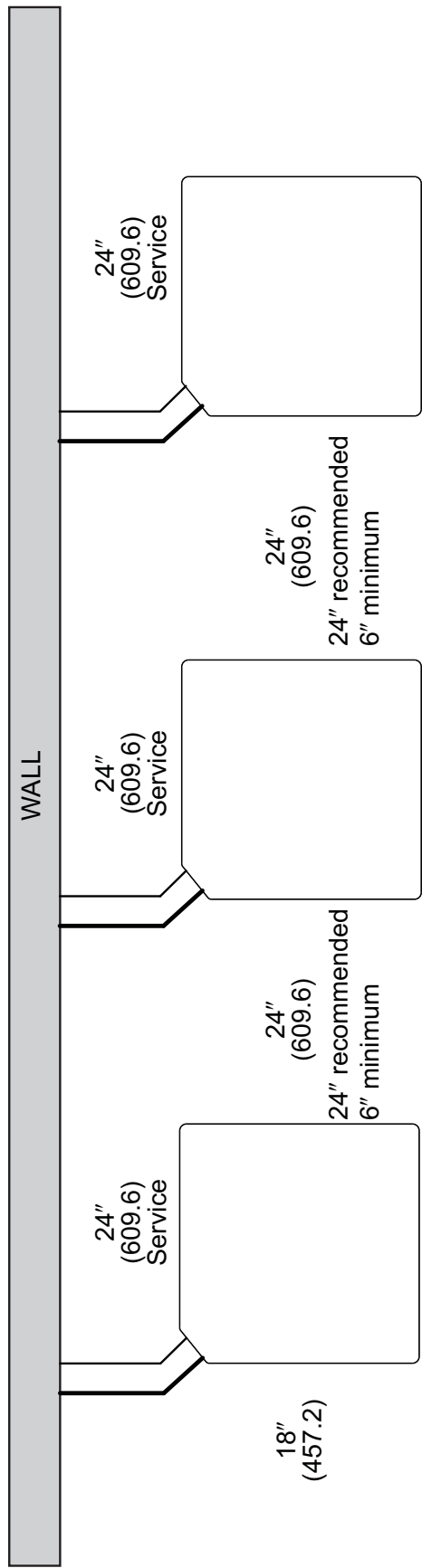
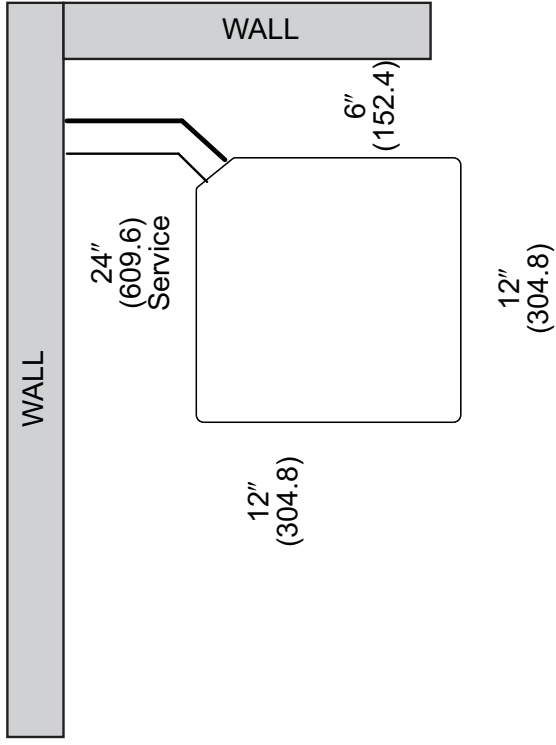
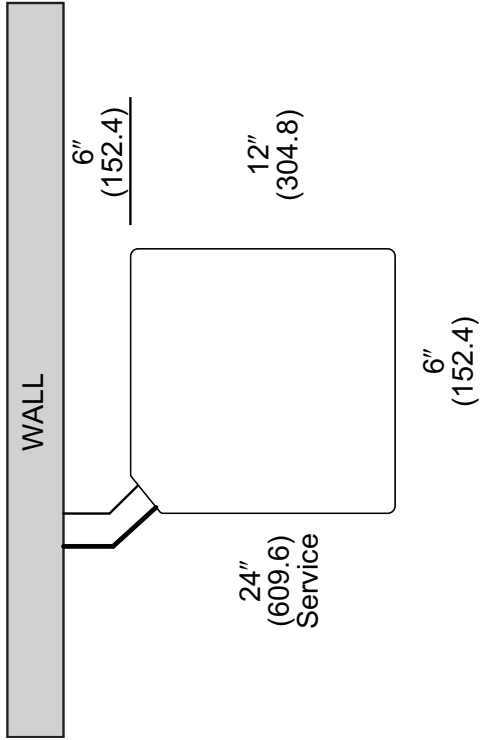

NOTE: NUMBERS IN () = mm

IMPORTANT: When installing multiple units in an alcove, roof well or partially enclosed area, ensure there is adequate ventilation to prevent re-circulation of discharge air.

Control Wiring

TYPICAL 1-STAGE THERMOSTAT: (-)P20 HEAT PUMP WITH ELECTRIC HEAT USING A SINGLE STAGE THERMOSTAT WITH DEHUMIDIFICATION

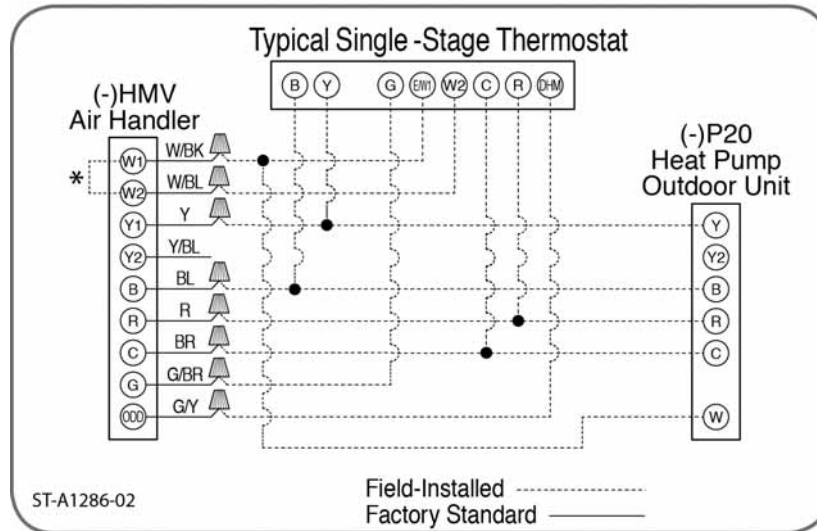

Application Guidelines

1. Intended for outdoor installation with free air inlet and outlet. Outdoor fan external static pressure available is less than 0.01 -in. wc.
2. Minimum outdoor operating air temperature for cooling mode 0°F.
3. Maximum outdoor operating air temperature is 125°F (51.7°C).
4. For reliable operation, unit should be level in all horizontal planes.
5. Use only copper wire for electric connections at unit. Aluminum and clad aluminum are not acceptable for the type of connector provided.
6. Only apply factory recommended indoor coils to these units.
7. Factory – supplied filter drier must be installed.

Refrigerant Line Sizing Chart (English Units)

20 SEER Variable Speed Heat Pumps								
Unit Size	Allowable Liquid Line Size	Allowable Vapor Line Size	Outdoor Unit ABOVE or BELOW Indoor Unit Equivalent Length (Feet)					
			< 25	26-50	51-75	76-100	101-125	126-150
			Maximum Vertical Separation/Capacity Multiplier					
2.0 Ton *SEE NOTE 3	1/4"	5/8"	25/1.00	50/0.99	33/0.98	60/0.97	NR	NR
	5/16"	5/8"	25/1.00	50/0.99	50/0.98	50/0.97	50/0.96	50/0.95
	3/8"	5/8"	25/1.00	50/0.99	50/0.98	50/0.97	50/0.96	50/0.95
	1/4"	3/4"	25/1.00	50/1.00	33/0.99	60/0.99	NR	NR
	5/16"	3/4"	25/1.00	50/1.00	50/0.99	50/0.99	50/0.99	50/0.98
	3/8"	3/4"	25/1.00	50/1.00	50/0.99	50/0.99	50/0.99	50/0.98
3 Ton	5/16"	5/8"	25/0.99	50/0.97	50/0.95	50/0.93	36/0.91	NR
	3/8"	5/8"	25/0.99	50/0.97	50/0.95	50/0.93	50/0.91	NR
	5/16"	3/4"	25/1.00	50/0.99	50/0.99	50/0.98	36/0.97	20/0.96
	3/8"	3/4"	25/1.00	50/0.99	50/0.99	50/0.98	50/0.97	50/0.96
	1/2"	3/4"	25/1.00	50/0.99	50/0.99	50/0.98	50/0.97	50/0.96
4 Ton	3/8"	3/4"	25/0.99	50/0.98	50/0.96	50/0.95	50/0.93	50/0.92
	1/2"	3/4"	25/0.99	50/0.98	50/0.96	50/0.95	50/0.93	50/0.92
	3/8"	7/8"	25/1.00	50/0.99	50/0.99	50/0.98	50/0.98	50/0.97
	1/2"	7/8"	25/1.00	50/0.99	50/0.99	50/0.98	50/0.98	50/0.97
5 Ton	3/8"	3/4"	25/0.98	50/0.97	50/0.95	50/0.93	46/0.91	NR
	1/2"	3/4"	25/0.98	50/0.97	50/0.95	50/0.93	50/0.91	NR
	3/8"	7/8"	25/0.99	50/0.99	50/0.98	50/0.97	50/0.96	38/0.95
	1/2"	7/8"	25/0.99	50/0.99	50/0.98	50/0.97	50/0.96	50/0.95
	3/8"	1-1/8"	25/1.00	50/1.00	50/1.00	50/0.99	50/0.99	38/0.99
	1/2"	1-1/8"	25/1.00	50/1.00	50/1.00	50/0.99	50/0.99	50/0.99

NOTES:

1. Do not exceed 150 ft linear line length.
2. Do not exceed 50 ft vertical separation between indoor and outdoor units.
3. *3/4" vapor line should only be used for 2 ton systems if outdoor unit is below or at same level as indoor unit to assure proper oil return.
4. **1-1/8" vapor line should only be used for 5 ton systems if outdoor unit is below or at same level as indoor unit to assure proper oil return.
5. Always use the smallest liquid line allowable to minimize refrigerant charge.
6. Applications shaded in light gray indicate capacity multipliers between 0.90 and 0.96 which are not recommended, but are allowed.
7. Applications shaded in dark gray are not recommended due to excessive liquid or suction pressure drop.

Refrigerant Line Sizing Chart (Metric Units)

20 SEER Variable Speed Heat Pumps								
Unit Size	Allowable Liquid Line Size	Allowable Vapor Line Size	Outdoor Unit ABOVE or BELOW Indoor Unit Equivalent Length (Meters)					
			< 8	8-15	16-23	24-30	31-38	39-46
			Maximum Vertical Separation/Capacity Multiplier					
7.0 kW [2.0 Ton] *SEE NOTE 3	6.35 [1/4]	15.88 [5/8]	8/1.00	15/0.99	10/0.98	20/0.97	NR	NR
	7.94 [5/16]	15.88 [5/8]	8/1.00	15/0.99	15/0.98	15/0.97	15/0.96	15/0.95
	9.53 [3/8]	15.88 [5/8]	8/1.00	15/0.99	15/0.98	15/0.97	15/0.96	15/0.95
	6.35 [1/4]	19.05 [3/4]	8/1.00	15/0.99	10/0.99	20/0.99	NR	NR
	7.94 [5/16]	19.05 [3/4]	8/1.00	15/0.99	15/0.99	15/0.99	15/0.99	15/0.98
	9.53 [3/8]	19.05 [3/4]	8/1.00	15/0.99	15/0.99	15/0.99	15/0.99	15/0.98
10.6 kW [3 Ton]	7.94 [5/16]	15.88 [5/8]	8/0.99	15/0.97	15/0.95	15/0.93	11/0.91	NR
	9.53 [3/8]	15.88 [5/8]	8/0.99	15/0.97	15/0.95	15/0.93	15/0.91	NR
	7.94 [5/16]	19.05 [3/4]	8/1.00	15/0.99	15/0.99	15/0.98	11/0.97	6/0.96
	9.53 [3/8]	19.05 [3/4]	8/1.00	15/0.99	15/0.99	15/0.98	15/0.97	15/0.96
	12.7 [1/2]	19.05 [3/4]	8/1.00	15/0.99	15/0.99	15/0.98	15/0.97	15/0.96
14.1 kW [4 Ton]	9.53 [3/8]	19.05 [3/4]	8/0.99	15/0.98	15/0.96	15/0.95	15/0.93	15/0.92
	12.7 [1/2]	19.05 [3/4]	8/0.99	15/0.98	15/0.96	15/0.95	15/0.93	15/0.92
	9.53 [3/8]	22.23 [7/8]	8/1.00	15/0.99	15/0.99	15/0.98	15/0.98	15/0.97
	12.7 [1/2]	22.23 [7/8]	8/1.00	15/0.99	15/0.99	15/0.98	15/0.98	15/0.97
17.6 kW [5 Ton]	9.53 [3/8]	19.05 [3/4]	8/0.98	15/0.97	15/0.95	15/0.93	14/0.91	NR
	12.7 [1/2]	19.05 [3/4]	8/0.98	15/0.97	15/0.95	15/0.93	15/0.91	NR
	9.53 [3/8]	22.23 [7/8]	8/0.99	15/0.99	15/0.98	15/0.97	15/0.96	12/0.95
	12.7 [1/2]	22.23 [7/8]	8/0.99	15/0.99	15/0.98	15/0.97	15/0.96	15/0.95
	9.53 [3/8]	28.58 [1-1/8]**	8/1.00	15/1.00	15/1.00	15/0.99	15/0.99	12/0.99
	12.7 [1/2]	28.58 [1-1/8]**	8/1.00	15/1.00	15/1.00	15/0.99	15/0.99	15/0.99

NOTES:

1. Do not exceed 46 meters linear line length.
2. Do not exceed 15 meters vertical separation between indoor and outdoor units.
3. *19.05mm [3/4 in.] vapor line should only be used for 2 ton systems if outdoor unit is below or at same level as indoor unit to assure proper oil return.
4. **28.58mm [1-1/8 in.] vapor line should only be used for 5 ton systems if outdoor unit is below or at same level as indoor unit to assure proper oil return.
5. Always use the smallest liquid line allowable to minimize refrigerant charge.
6. Applications shaded in light gray indicate capacity multipliers between 0.90 and 0.96 which are not recommended, but are allowed.
7. Applications shaded in dark gray are not recommended due to excessive liquid or suction pressure drop.

(-)P2024B Cooling Capacity Ranges

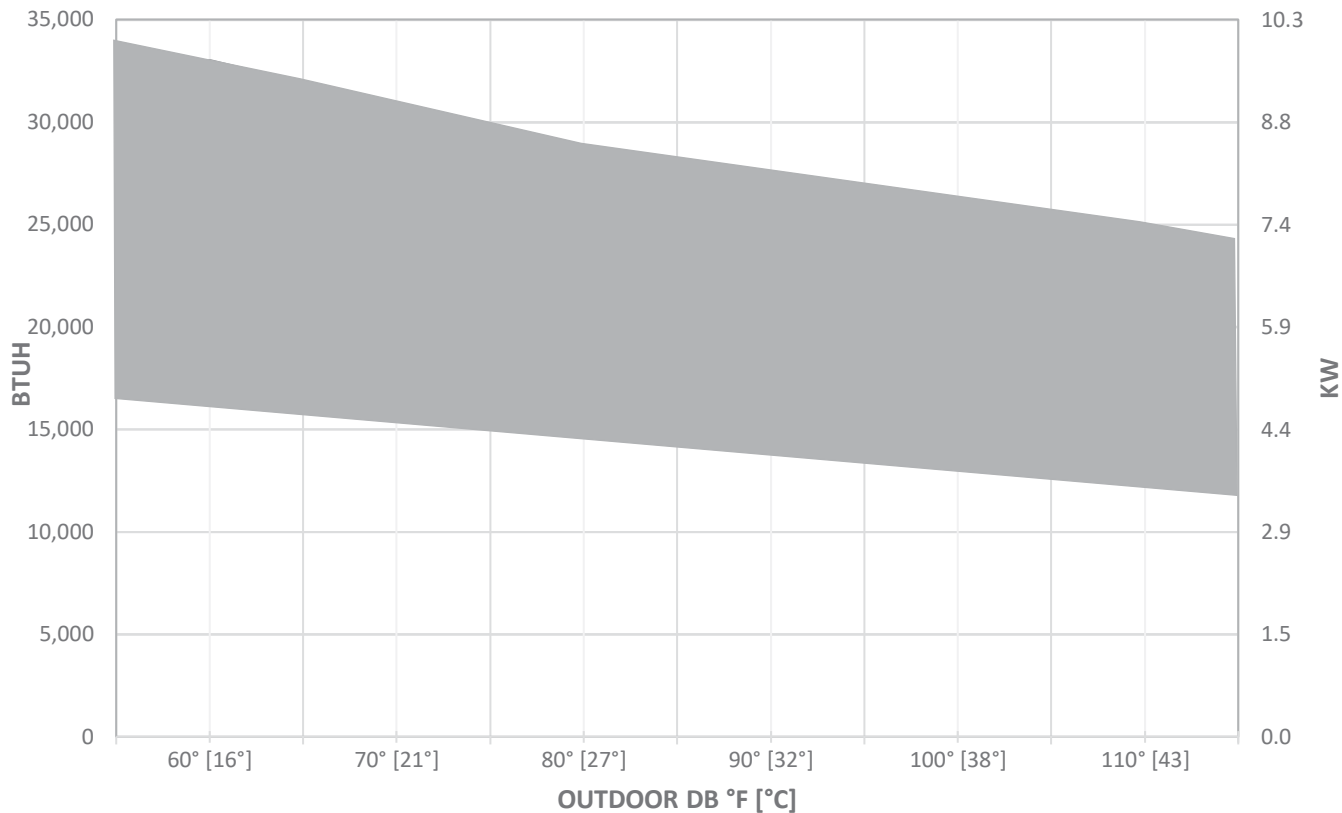

(-)P2024B Heating Capacity Ranges

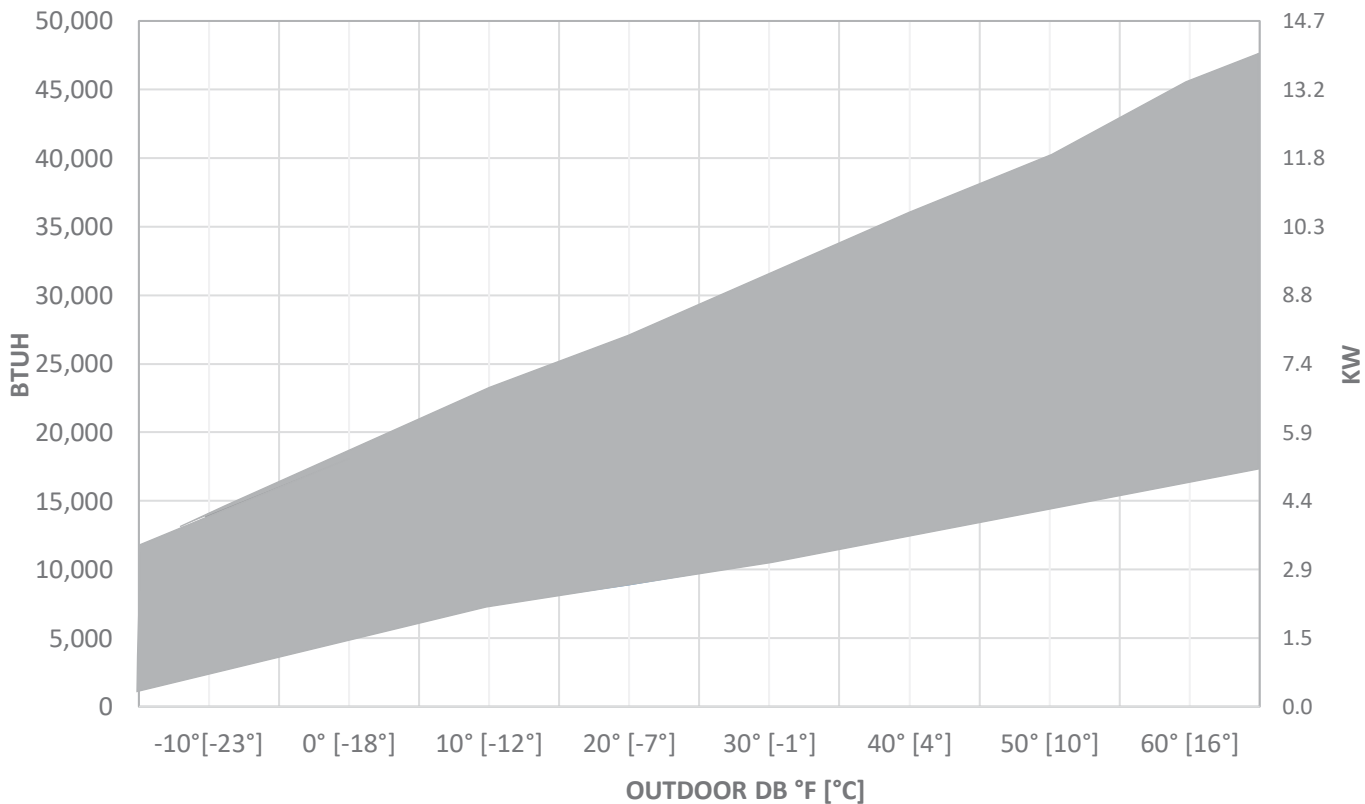

(-)P2036B Cooling Capacity Ranges

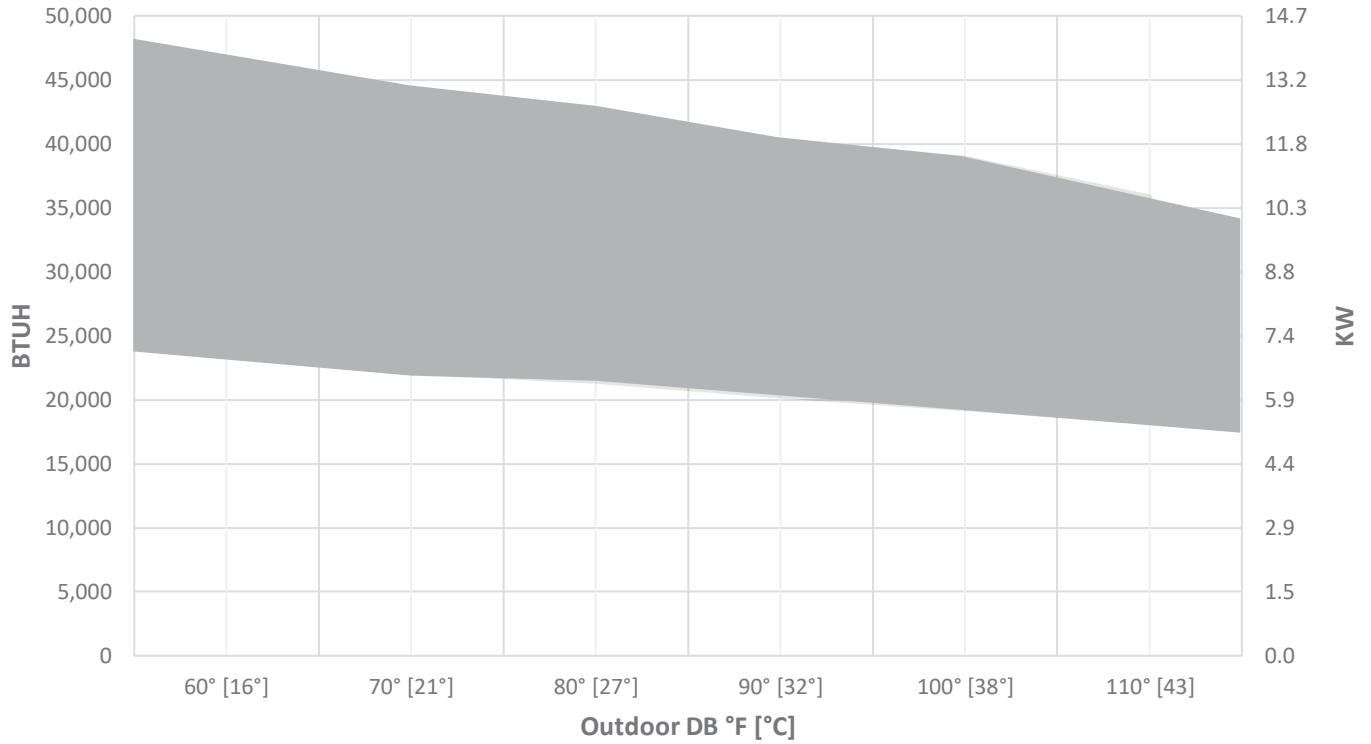

(-)P2036B Heating Capacity Ranges

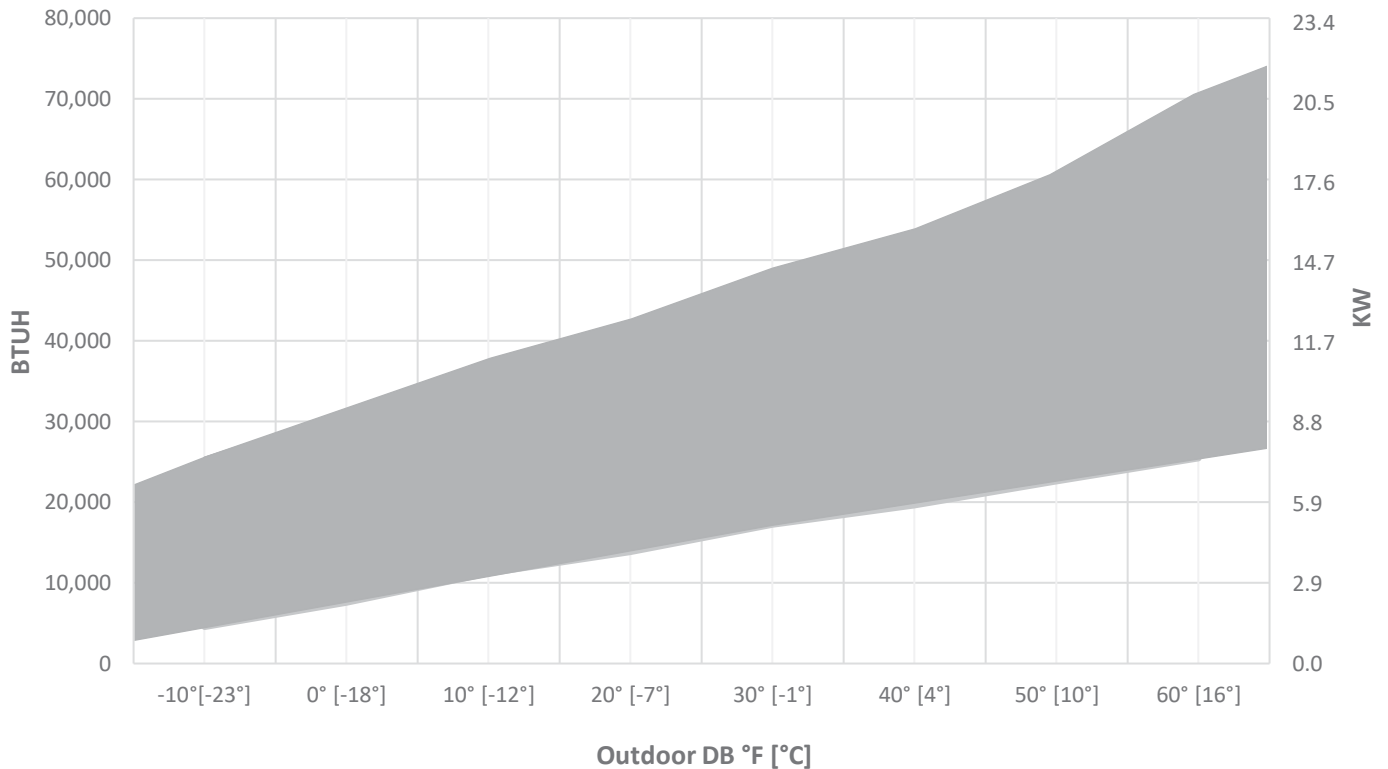

(-)P2048B Cooling Capacity Ranges

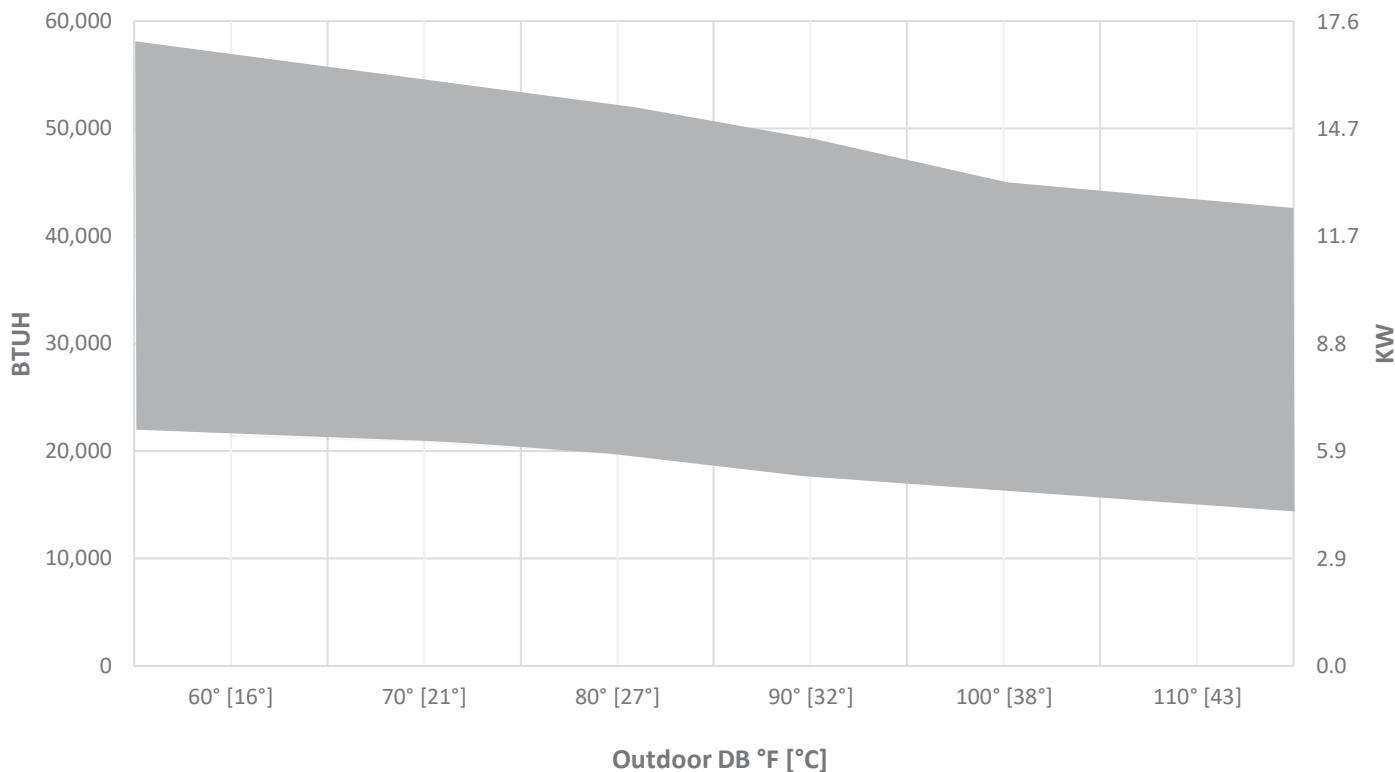

(-)2048B Heating Capacity Ranges

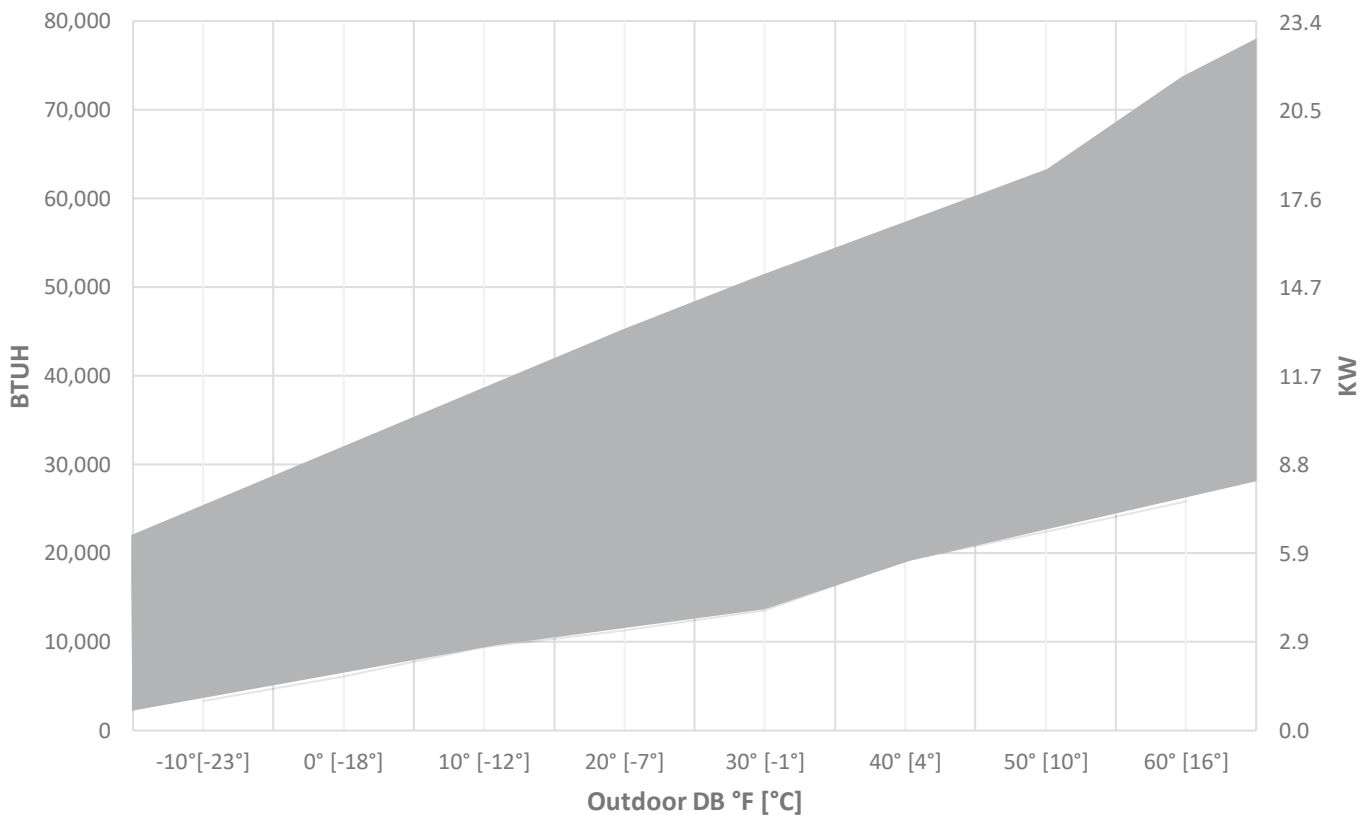

(-)P2060B Cooling Capacity Ranges

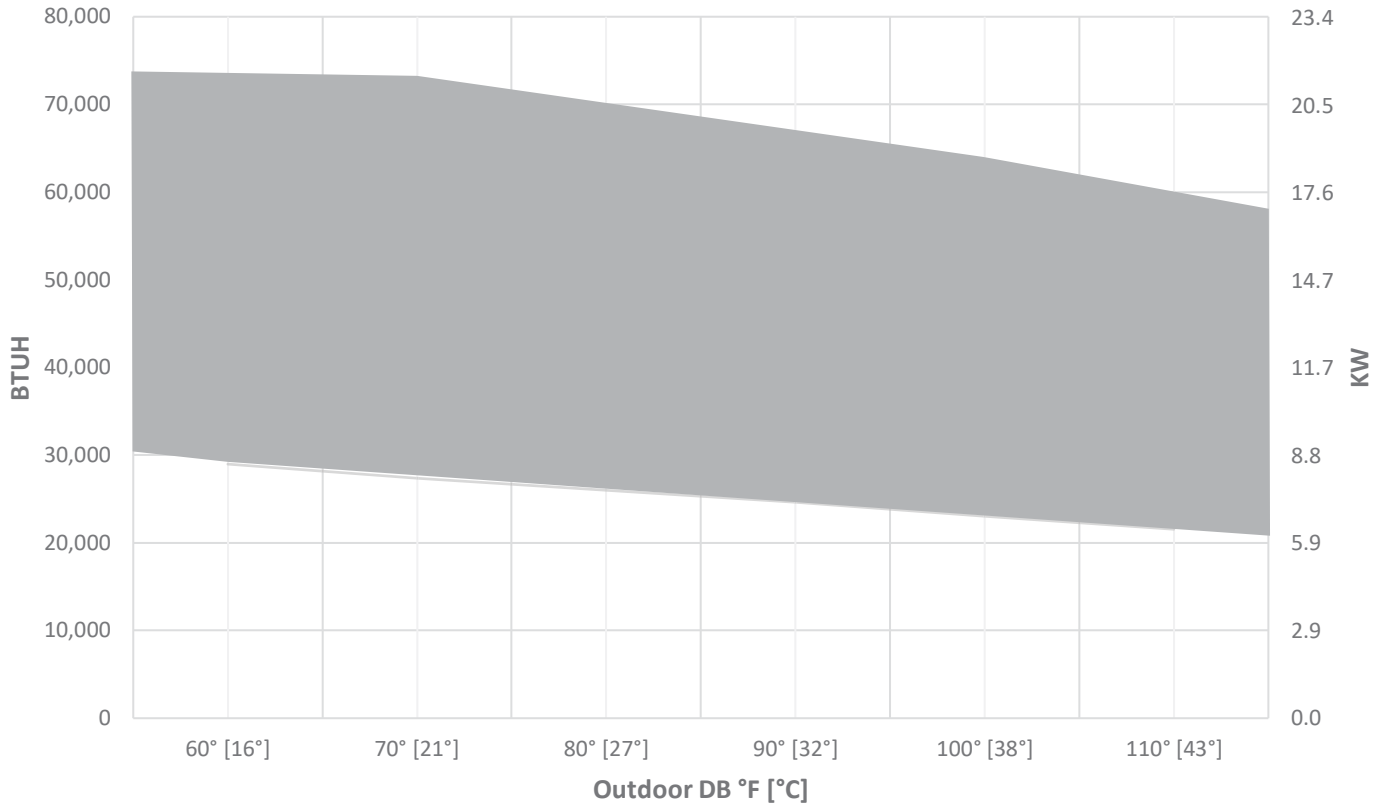

(-)P2060B Heating Capacity Ranges

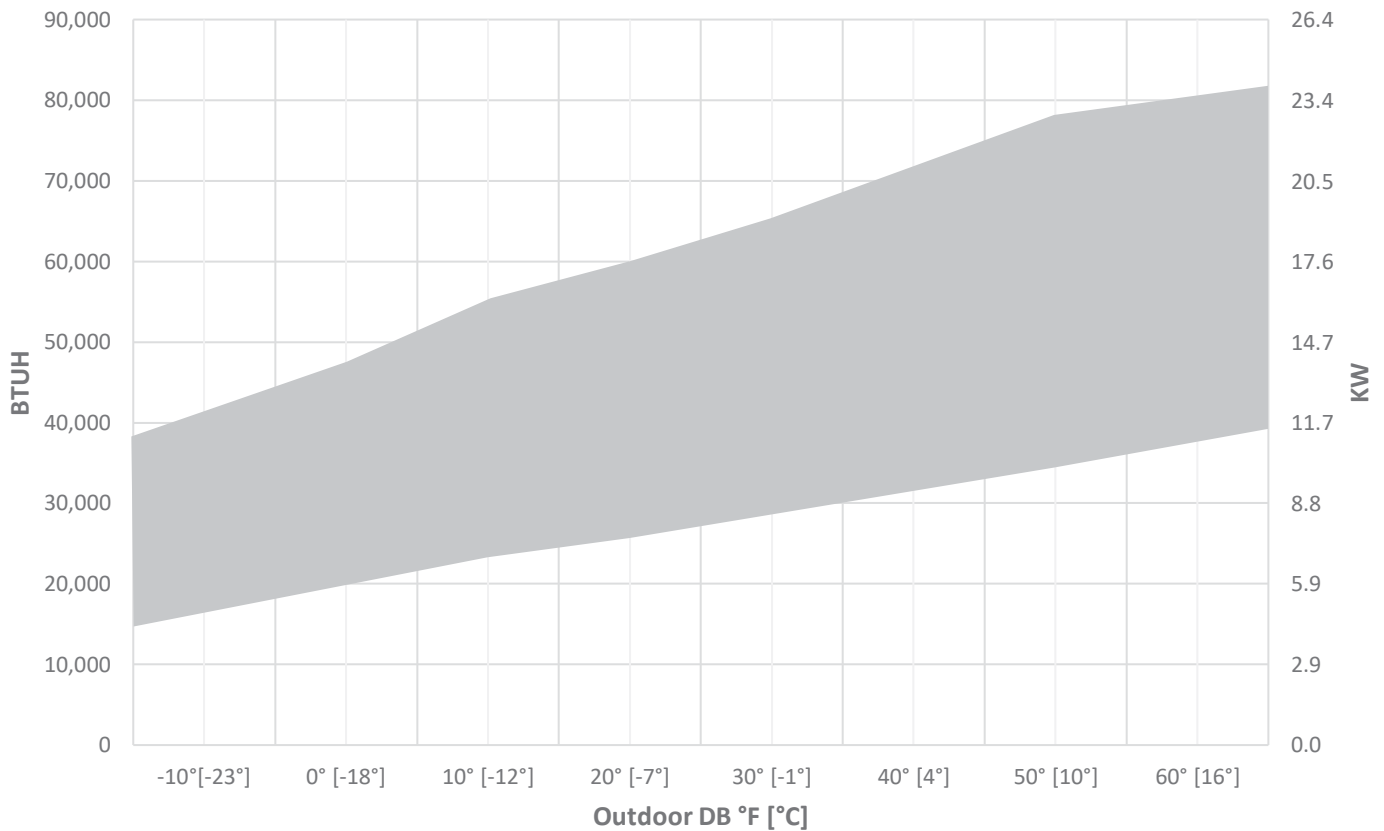

Performance Data @ AHRI Standard Conditions – Heat Pump

Note: Ratings contained in this document are subject to change. For up-to-date and expanded ratings, please visit the AHRI web site (www.ahridirectory.org).
EcoNet Smart Thermostat required to reach posted ratings.

High Sales Volume Tested Combination (HSVTC)												
Outdoor Unit	Air Handler	Total Capacity BTU/H [kW]	Net Sensible BTU/H [kW]	Net Latent BTU/H [kW]	SEER	EER	Indoor CFM [L/s]	47 Degree Heating Capacity BTU/H [kW]	47 Degree COP	17 Degree Heating Capacity BTU/H [kW]	17 Degree COP	Region IV HSPF
UP2024B JVCA	RHMV2421UEAC	22800 [6.7]	16600 [4.9]	6200 [1.8]	20.0	14.00	800 [377.6]	22400 [6.6]	3.0	22800 [6.7]	2.0	11.0
UP2036B JVCA	RHMV6021SEAC	35000 [10.3]	27400 [8.0]	7600 [2.2]	20.0	14.00	1225 [578.1]	33000 [9.7]	3.0	37400 [11.0]	2.0	11.5
UP2048B JVCA	RHMV6021SEAC	45500 [13.3]	34200 [10.0]	11300 [3.3]	19.5	12.50	1575 [743.3]	42000 [12.3]	2.5	41000 [12.0]	2.0	11.0
UP2060B JVCA	RHMV6021SEAC	54000 [15.8]	39000 [11.4]	15000 [4.4]	19.5	11.50	1700 [802.3]	51000 [14.9]	2.5	47000 [13.8]	1.5	11.0

U802V: 80% AFUE 2-Stage Variable Speed Gas Furnace Ratings

Outdoor Unit	Furnace	Indoor Coil	Total Capacity BTU/H [kW]	Net Sensible BTU/H [kW]	Net Latent BTU/H [kW]	SEER	EER	Indoor CFM [L/s]	47 Degree Heating Capacity BTU/H [kW]	47 Degree COP	17 Degree Heating Capacity BTU/H [kW]	17 Degree COP	Region IV HSPF
UP2024B JVCA	U802VA050317M	RCF2421UEA	22600 [6.6]	16400 [4.8]	6200 [1.8]	19.5	13.0	800 [377.6]	22000 [6.4]	3.0	22800 [6.7]	2.0	10.5
UP2024B JVCA	U802VA075317M	RCF2421UEA	22800 [6.7]	16600 [4.9]	6200 [1.8]	20.0	14.0	800 [377.6]	22000 [6.4]	3.0	22600 [6.6]	2.0	10.5
UP2024B JVCA	U802VA075421Z	RCF2421UEA	22800 [6.7]	16600 [4.9]	6200 [1.8]	20.0	14.0	800 [377.6]	22000 [6.4]	3.0	22600 [6.6]	2.0	10.5
UP2024B JVCA	U802VA100521M	RCF2421UEA	22800 [6.7]	16600 [4.9]	6200 [1.8]	20.0	14.0	800 [377.6]	21800 [6.4]	3.0	22600 [6.6]	2.0	10.5
UP2024B JVCA	U802VA100521Z	RCF2421UEA	22800 [6.7]	16600 [4.9]	6200 [1.8]	20.0	14.0	800 [377.6]	22000 [6.4]	3.0	22600 [6.6]	2.0	10.5
UP2036B JVCA	U802VA050317M	RCF6021SEA	34600 [10.1]	27200 [8.0]	7400 [2.2]	19.5	13.0	1225 [578.1]	33000 [9.7]	2.5	37400 [11.0]	2.0	10.5
UP2036B JVCA	U802VA075317M	RCF6021SEA	34800 [10.2]	27200 [8.0]	7600 [2.2]	19.5	13.0	1225 [578.1]	32600 [9.6]	2.5	36800 [10.8]	2.0	11.0
UP2036B JVCA	U802VA075421Z	RCF6021SEA	35000 [10.3]	27400 [8.0]	7600 [2.2]	19.5	13.0	1225 [578.1]	32800 [9.6]	2.5	37000 [10.8]	2.0	11.0
UP2036B JVCA	U802VA100521M	RCF6021SEA	35000 [10.3]	27400 [8.0]	7600 [2.2]	20.0	14.0	1225 [578.1]	32200 [9.4]	3.0	36600 [10.7]	2.0	11.0
UP2036B JVCA	U802VA100521Z	RCF6021SEA	35000 [10.3]	27400 [8.0]	7600 [2.2]	19.5	13.0	1225 [578.1]	32600 [9.6]	2.5	36800 [10.8]	2.0	11.0
UP2036B JVCA	U802VA125524M	RCF6021SEA	35000 [10.3]	27400 [8.0]	7600 [2.2]	19.5	13.0	1225 [578.1]	32400 [9.5]	3.0	36600 [10.7]	2.0	11.0
UP2048B JVCA	U802VA075421M	RCF6021SEA	45500 [13.3]	34200 [10.0]	11300 [3.3]	19.0	12.0	1575 [743.3]	41500 [12.2]	2.5	40500 [11.9]	1.5	11.0
UP2048B JVCA	U802VA075421Z	RCF6021SEA	45500 [13.3]	34200 [10.0]	11300 [3.3]	18.5	11.5	1575 [743.3]	41500 [12.2]	2.5	40500 [11.9]	1.5	11.0
UP2048B JVCA	U802VA100521M	RCF6021SEA	45500 [13.3]	34200 [10.0]	11300 [3.3]	19.5	12.5	1575 [743.3]	41000 [12.0]	2.5	40000 [11.7]	1.5	11.0
UP2048B JVCA	U802VA100521Z	RCF6021SEA	45500 [13.3]	34200 [10.0]	11300 [3.3]	18.5	12.0	1575 [743.3]	41000 [12.0]	2.5	40500 [11.9]	1.5	11.0
UP2048B JVCA	U802VA125524M	RCF6021SEA	45500 [13.3]	34200 [10.0]	11300 [3.3]	19.0	12.5	1575 [743.3]	41000 [12.0]	2.5	40000 [11.7]	1.5	11.0
UP2060B JVCA	U802VA100521Z	RCF6021SEA	54000 [15.8]	39000 [11.4]	15000 [4.4]	18.5	11.5	1700 [802.3]	50000 [14.6]	2.5	47000 [13.8]	1.5	11.0
UP2060B JVCA	U802VA125524Z	RCF6021SEA	54000 [15.8]	39000 [11.4]	15000 [4.4]	18.5	11.5	1700 [802.3]	50000 [14.6]	2.5	47000 [13.8]	1.5	11.0

[] Designates Metric Conversions

Performance Data @ AHRI Standard Conditions – Heat Pump (con't.)

Note: Ratings contained in this document are subject to change. For up-to-date and expanded ratings, please visit the AHRI web site (www.ahriridirectory.org). EcoNet Smart Thermostat required to reach posted ratings.

U96V: 96% AFUE 2-Stage Variable Speed Multiphase Gas Furnace Ratings													
Outdoor Unit	Furnace	Indoor Coil	Total Capacity BTU/H [kW]	Net Sensible BTU/H [kW]	Net Latent BTU/H [kW]	SEER	EER	Indoor CFM [L/s]	47 Degree Heating Capacity BTU/H [kW]	47 Degree COP	17 Degree Heating Capacity BTU/H [kW]	17 Degree COP	Region IV HSPF
UP2024BJVCA	U96VA0602317M	RCF2421UEA	22600 [6.6]	16400 [4.8]	6200 [1.8]	19.5	13.0	800 [377.6]	22000 [6.4]	3.0	22800 [6.7]	2.0	10.5
UP2036BJVCA	U96VA0852521M	RCF6021SEA	35000 [10.3]	27400 [8.0]	7600 [2.2]	19.5	13.0	1225 [578.1]	32800 [9.6]	2.5	37000 [10.8]	2.0	11.0
UP2036BJVCA	U96VA1002521M	RCF6021SEA	35000 [10.3]	27400 [8.0]	7600 [2.2]	20.0	14.0	1225 [578.1]	32600 [9.6]	2.5	37000 [10.8]	2.0	11.0
UP2036BJVCA	U96VA1152524M	RCF6021SEA	35000 [10.3]	27400 [8.0]	7600 [2.2]	19.5	13.0	1225 [578.1]	32600 [9.6]	2.5	37000 [10.8]	2.0	11.0
UP2048BJVCA	U96VA0852521M	RCF6021SEA	45500 [13.3]	34200 [10.0]	11300 [3.3]	18.5	11.5	1575 [743.3]	41500 [12.2]	2.5	40500 [11.9]	1.5	11.0
UP2048BJVCA	U96VA1002521M	RCF6021SEA	45500 [13.3]	34200 [10.0]	11300 [3.3]	19.0	12.0	1575 [743.3]	41500 [12.2]	2.5	40500 [11.9]	1.5	11.0
UP2048BJVCA	U96VA1152524M	RCF6021SEA	45500 [13.3]	34200 [10.0]	11300 [3.3]	18.5	12.0	1575 [743.3]	41000 [12.0]	2.5	40500 [11.9]	1.5	11.0
UP2060BJVCA	U96VA1002521M	RCF6021SEA	53500 [15.7]	38500 [11.3]	15000 [4.4]	18.5	11.0	1700 [802.3]	50500 [14.8]	2.5	47500 [13.9]	1.5	11.0

U97V: 97% AFUE Modulating Variable Speed Multiphase Gas Furnace Ratings													
Outdoor Unit	Furnace	Indoor Coil	Total Capacity BTU/H [kW]	Net Sensible BTU/H [kW]	Net Latent BTU/H [kW]	SEER	EER	Indoor CFM [L/s]	47 Degree Heating Capacity BTU/H [kW]	47 Degree COP	17 Degree Heating Capacity BTU/H [kW]	17 Degree COP	Region IV HSPF
UP2024BJVCA	U97VA060M317K	RCF2421UEA	22600 [6.6]	16400 [4.8]	6200 [1.8]	19.5	13.0	800 [377.6]	22000 [6.4]	3.0	22800 [6.7]	2.0	10.5
UP2024BJVCA	U97VA070M317K	RCF2421UEA	22800 [6.7]	16600 [4.9]	6200 [1.8]	19.5	13.0	800 [377.6]	22000 [6.4]	3.0	22800 [6.7]	2.0	10.5
UP2036BJVCA	U97VA085M521K	RCF6021SEA	35000 [10.3]	27400 [8.0]	7600 [2.2]	19.5	13.0	1225 [578.1]	32800 [9.6]	2.5	37000 [10.8]	2.0	11.0
UP2036BJVCA	U97VA100M521K	RCF6021SEA	35000 [10.3]	27400 [8.0]	7600 [2.2]	19.5	13.0	1225 [578.1]	32600 [9.6]	2.5	37000 [10.8]	2.0	11.0
UP2036BJVCA	U97VA115M524K	RCF6021SEA	35000 [10.3]	27400 [8.0]	7600 [2.2]	19.5	13.0	1225 [578.1]	32600 [9.6]	2.5	37000 [10.8]	2.0	11.0
UP2048BJVCA	U97VA085M521K	RCF6021SEA	45500 [13.3]	34200 [10.0]	11300 [3.3]	18.5	11.5	1575 [743.3]	41500 [12.2]	2.5	40500 [11.9]	1.5	11.0
UP2048BJVCA	U97VA100M521K	RCF6021SEA	45500 [13.3]	34200 [10.0]	11300 [3.3]	19.0	12.0	1575 [743.3]	41500 [12.2]	2.5	40500 [11.9]	1.5	11.0
UP2060BJVCA	U97VA100M521K	RCF6021SEA	53500 [15.7]	38500 [11.3]	15000 [4.4]	18.5	11.0	1700 [802.3]	50500 [14.8]	2.5	47500 [13.9]	1.5	11.0

[] Designates Metric Conversions

Performance Data @ OD Unit Overdrive (Max. Speed) Conditions – Heat Pump

Note: Ratings contained in this document are subject to change. For up-to-date and expanded ratings, please visit the AHRI web site (www.ahrirectory.org). EcoNet Smart Thermostat required to reach posted ratings.

U98V: 98% AFUE Modulating Upflow Gas Furnace Ratings													
Outdoor Unit	Furnace	Indoor Coil	Total Capacity BTU/H [kW]	Net Sensible BTU/H [kW]	Net Latent BTU/H [kW]	SEER	EER	Indoor CFM [L/s]	47 Degree Heating Capacity BTU/H [kW]	47 Degree COP	17 Degree Heating Capacity BTU/H [kW]	17 Degree COP	Region IV HSPF
UP2024BJVCA	U98VB060M317U	RCF2421UEA	22600 [6.6]	16400 [4.8]	6200 [1.8]	19.5	13.0	800 [377.6]	22000 [6.4]	3.0	22800 [6.7]	2.0	10.5
UP2024BJVCA	U98VB070M317U	RCF2421UEA	22800 [6.7]	16600 [4.9]	6200 [1.8]	19.5	13.0	800 [377.6]	22000 [6.4]	3.0	22800 [6.7]	2.0	10.5
UP2036BJVCA	U98VB085M521U	RCF6021SEA	35000 [10.3]	27400 [8.0]	7600 [2.2]	19.5	13.0	1225 [578.1]	32800 [9.6]	2.5	37000 [10.8]	2.0	11.0
UP2036BJVCA	U98VB100M521U	RCF6021SEA	35000 [10.3]	27400 [8.0]	7600 [2.2]	20.0	14.0	1225 [578.1]	32600 [9.6]	2.5	37000 [10.8]	2.0	11.0
UP2036BJVCA	U98VB115M524U	RCF6021SEA	35000 [10.3]	27400 [8.0]	7600 [2.2]	19.5	13.0	1225 [578.1]	32600 [9.6]	2.5	37000 [10.8]	2.0	11.0
UP2048BJVCA	U98VB085M521U	RCF6021SEA	45500 [13.3]	34200 [10.0]	11300 [3.3]	18.5	11.5	1575 [743.3]	41500 [12.2]	2.5	40500 [11.9]	1.5	11.0
UP2048BJVCA	U98VB100M521U	RCF6021SEA	45500 [13.3]	34200 [10.0]	11300 [3.3]	19.0	12.0	1575 [743.3]	41500 [12.2]	2.5	40500 [11.9]	1.5	11.0
UP2048BJVCA	U98VB115M524U	RCF6021SEA	45500 [13.3]	34200 [10.0]	11300 [3.3]	18.5	12.0	1575 [743.3]	41000 [12.0]	2.5	40500 [11.9]	1.5	11.0
UP2060BJVCA	U98VB100M521U	RCF6021SEA	53500 [15.7]	38500 [11.3]	15000 [4.4]	18.5	11.0	1700 [802.3]	50500 [14.8]	2.5	47500 [13.9]	1.5	11.0

[] Designates Metric Conversions

GUIDE SPECIFICATIONS

General

System Description

Outdoor-mounted, air-cooled, split-system heat pump unit suitable for ground or rooftop installation. Unit consists of a hermetic compressor, composite basepan, an air-cooled coil, propeller-type condenser fan, suction and liquid line service valve, and a control box. Unit will discharge supply air upward as shown on contract drawings. Unit will be used in a refrigeration circuit to match up to a coil unit.

Quality Assurance

- Unit will be rated in accordance with the latest edition of AHRI Standard 210.
- Unit will be certified for capacity and efficiency, and listed in the latest AHRI directory.
- Unit construction will comply with latest edition of ANSI/ASHRAE and with NEC.
- Unit will be constructed in accordance with UL standards and will carry the UL label of approval. Unit will have c-UL-us approval.
- Unit cabinet will be capable of withstanding ASTM B117 1000-hr salt spray test.
- Air-cooled condenser coils will be leak tested at 150 psig and pressure tested at 550 psig.
- Unit constructed in ISO9001 approved facility.

Delivery, Storage, and Handling

- Unit will be shipped as single package only and is stored and handled per unit manufacturer's recommendations.

Warranty (for inclusion by specifying engineer) – U.S. and Canada only.

Products

Equipment

Factory assembled, single piece, air-cooled heat pump unit. Contained within the unit enclosure is all factory wiring, piping, controls, compressor, refrigerant charge R-410A, and special features required prior to field start-up.

Unit Cabinet

- Unit cabinet will be constructed of galvanized steel, bonderized, and coated with a powder coat paint.
- All units constructed with louver coil protection and corner post. Louver can be removed by removing one fastener per louver panel.

AIR-COOLED, SPLIT-SYSTEM HEAT PUMP UP20

2 TO 5 NOMINAL TONS

Fans

- Condenser fan will be direct-drive propeller type, discharging air upward.
- Condenser fan motors will be totally enclosed, 1-phase type with class B insulation and permanently lubricated bearings. Shafts will be corrosion resistant.
- Fan blades will be statically and dynamically balanced.
- Condenser fan openings will be equipped with coated steel wire safety guards.

Compressor

- Compressor will be hermetically sealed.
- Compressor will be mounted on rubber vibration isolators.
- Compressor will be Copeland fully variable speed.

Condenser Coil

- Condenser coil will be air cooled.
- Coil will be constructed of aluminum fins mechanically bonded to copper tubes.

Refrigeration Components

- Refrigeration circuit components will include liquid-line shutoff valve with sweat connections, vapor-line shutoff valve with sweat connections, system charge of R-410A refrigerant, and compressor oil.
- Unit will be equipped with filter drier for R-410A refrigerant for field installation.

Operating Characteristics

- The capacity of the unit will meet or exceed _____ Btuh at a suction temperature of _____ °F/°C. The power consumption at full load will not exceed _____ kW.
- Combination of the unit and the evaporator or fan coil unit will have a total net cooling capacity of _____ Btuh or greater at conditions of _____ CFM entering air temperature at the evaporator at _____ °F/°C wet bulb and _____ °F/°C dry bulb, and air entering the unit at _____ °F/°C.
- The system will have a SEER of _____ Btuh/watt or greater at DOE conditions.

Electrical Requirements

- Nominal unit electrical characteristics will be _____ v, single phase, 60 hz. The unit will be capable of satisfactory operation within voltage limits of _____ v to _____ v.
- Nominal unit electrical characteristics will be _____ v, three phase, 60 hz. The unit will be capable of satisfactory operation within voltage limits of _____ v to _____ v.
- Unit electrical power will be single point connection.
- Control circuit will be 24v.

Special Features

- Refer to section of this literature identifying accessories and descriptions for specific features and available enhancements.

GENERAL TERMS OF LIMITED WARRANTY*

Ruud will furnish a replacement for any part of this product which fails in normal use and service within the applicable period stated, in accordance with the terms of the limited warranty.

***For complete details of the Limited and Conditional Warranties, including applicable terms and conditions, contact your local contractor or the Manufacturer for a copy of the product warranty certificate.**

Conditional Unit Replacement
(Registration Required) Ten (10) Years
Parts Ten (10) Years



In keeping with its policy of continuous progress and product improvement, Ruud reserves the right to make changes without notice.

Ruud Heating, Cooling & Water Heating • P.O. Box 17010
Fort Smith, Arkansas 72917 • www.ruud.com

Ruud Canada • 125 Edgeware Road, Unit 1
Brampton, Ontario • L6Y 0P5

RELY ON RUUD.™