



**LMI**<sup>®</sup>

*an Accudyne Industries brand*



# PD Series

Electronic Metering Pumps  
Installation & Operation Manual

Manual No.: 55777  
Revision : 01  
Rev. Date: 03/2018



**LMI**<sup>®</sup>

*an Accudyne Industries brand*

# PD Series Model Table

Model PD 7 5 1 - 8 3 2 S I

Model Code Configuration	
Drive	<b>Control Code</b> <b>0- Manual Control:</b> Speed (stroking frequency) manually adjustable  <b>7- Pulse Input / Manual Control:</b> External control capability through pulse input and low level float switch plus manual control adjustments of control code 0
	<b>Output / Size Code</b> See Most Recent Price List for Flow and Pressure Ratings
	<b>Power Code</b> 1 – 110-120V US Plug 2 – 220-240V US Plug 3 – 220-240V DIN Plug 5 – 220-240V UK Plug 6 – 220-240V Aust/NZ Plug NOTE: Power Code selects the connector only. All configurations operate over the full voltage range.
Liquid End	<b>Liquid End Code*</b> 7 – Molded Head, Single Ball Check Valves 8 – Molded Head, Double Ball Check Valves 9 – Machined Head, Double Ball Check Valves A – AutoPrime Degas, Double Ball Check Valves
	<b>LIQUIFRAM™ Size Code</b> 0 – 0.2 in <sup>2</sup> 2 – 0.4 in <sup>2</sup> 3 – 0.8 in <sup>2</sup> 4 – 1.6 in <sup>2</sup>
	<b>Wetted Material Code</b> See Most Recent Price List for Material Options
	<b>Valve Code</b> S – Includes 4-Function Valve (4FV) N – Does not include 4-Function Valve (4FV)
	<b>Connection Code</b> I – Inch Tubing M – Metric Tubing P – 1/2" NPT - 1/2" BSP Pipe (316SS Only)

\*NOTE: Not all configurations are available. Please see your local distributor or price list for available options

# Table of Contents

<b>1.0</b>	<b>Precautions</b>	<b>5</b>
<b>2.0</b>	<b>Introduction</b>	<b>8</b>
2.1	Electronic Metering Pump Specifications	8
2.2	Unpacking Check List	9
<b>3.0</b>	<b>Installation</b>	<b>10</b>
3.1	Pump Location and Installation	10
3.2	Pump Mounting	10
3.2.1	<i>Flooded Suction</i>	12
3.2.2	<i>Suction Lift – Wall Bracket Mount</i>	13
3.2.3	<i>Suction Lift - Tank Mount</i>	13
3.2.4	<i>Suction Lift - Shelf Mount</i>	13
3.3	Tubing Connections	13
3.4	Four – Function Valve (4-FV)	16
3.5	Four – Function Valve Installation	17
3.6	FastPrime™	17
3.7	AUTOPRIME™	18
3.8	Foot Valve / Suction Tubing Installation	18
3.9	Injection Check Valve and Discharge Tubing Installation	20
<b>4.0</b>	<b>Operation</b>	<b>21</b>
4.1	Controls, Inputs and Outputs	21
4.2	Icons (PD7XX Pumps)	24
4.3	START-UP AND ADJUSTMENT	26
4.3.1	<i>Start-Up/Priming for FastPrime™ Heads (LE-XXXNX)</i>	26
4.3.2	<i>Start-Up/Priming for Pump Supplied with 4-FV (LE-XXXSX)</i>	27
4.3.3	<i>Start-Up/Priming for AutoPrime™ Heads (LE-XXXAX)</i>	27
4.4	Output Adjustment	28
4.4.1	<i>Manual Mode</i>	28
4.4.2	<i>External Pulse Mode (PD7XX Pumps)</i>	29
4.5	Remote Start/Stop	31
4.6	Low Level / Tank Empty	31
4.7	Calibration	32
4.8	Totalizer	35
4.9	StayPrime™ Degassing Technology	36
4.10	Units	37
4.11	System Information	38
<b>5.0</b>	<b>Spare Parts Replacement and Routine Maintenance</b>	<b>38</b>
5.1	Depressurizing the Discharge Line	38
5.2	LIQUIFRAM™ (Diaphragm) Replacement	39

5.3	Cartridge Valve and O-ring Replacement .....	40
5.4	Injection Check Valve Parts Replacement .....	41
5.5	FastPrime™ Valve O-Ring Replacement .....	43
5.6	Liquid End Parts List .....	44
5.7	Drive Assembly Parts List .....	48
<b>6.0</b>	<b>Troubleshooting .....</b>	<b>50</b>

## Table of Figures

Figure 1:	Mounting Footprint Dimensions.....	11
Figure 2:	Flooded Suction Pump Mount.....	12
Figure 3:	Suction Lift Mounts.....	13
Figure 4:	1/4" OD Tubing Connections.....	14
Figure 5:	3/8" or 1/2" OD Tubing Connection .....	15
Figure 6:	Typical Installations Requiring the Anti-Syphon Feature of a Four-Function Valve .....	16
Figure 7:	Four – Function Valve Tubing Connection .....	17
Figure 8:	FastPrime™ Head .....	18
Figure 9:	AutoPrime™ .....	18
Figure 10:	Foot Valve / Suction Tubing Installation .....	19
Figure 11:	Typical Injection Check Valve Installation .....	20
Figure 12:	PD0XX Adjustment Controls .....	21
Figure 13:	PD7XX Adjustment Controls .....	21
Figure 14:	Methods of Externally Triggering the Pump .....	23
Figure 15:	Hall Effect Flowmeter Input Connection Reference.....	23
Figure 16:	PD7XX Manual Mode Home Screen.....	29
Figure 17:	External Pulse Settings .....	30
Figure 18:	PD7XX External Pulse Home Screen .....	31
Figure 19:	Pump Calibration (Set Flow Rate).....	33
Figure 20:	Graduated Cylinder .....	34
Figure 21:	Calibration Volume Adjustment.....	34
Figure 22:	Calibration Confirmation Screen .....	35
Figure 23:	Pump Totalizer Screen.....	35
Figure 24:	User Totalizer Screen .....	36
Figure 25:	StayPrime™ Degassing Technology Configuration Screen .....	37
Figure 26:	Units Screen.....	37
Figure 27:	System Information Screen .....	38
Figure 28:	LIQUIFRAM™ (Diaphragm) Replacement .....	39
Figure 29:	Injection Check Valve Assembly .....	42
Figure 30:	FastPrime™ Valve O-Ring Position.....	43
Figure 31:	FastPrime™ Valve O-Ring Replacement .....	44
Figure 32:	FastPrime™ Liquid End Assembly .....	45
Figure 33:	AutoPrime™ Liquid End Assembly .....	46
Figure 34:	Stainless Steel Liquid End Assembly .....	47
Figure 35:	PD0XX Manual Drive Assembly .....	48
Figure 36:	PD7XX Enhanced Drive Assembly .....	49

## 1.0 Precautions

The following precautions should be taken when working with LMI® metering pumps. Please read this section carefully prior to installation.

---

### Protective Clothing



**ALWAYS** wear protective clothing, face shield, safety glasses and gloves when working on or near your metering pump. Additional precautions should be taken depending on the solution being pumped. Refer to Safety Data Sheets (SDS) precautions from your solution supplier.

---

### Water Pre-Prime



All LMI® pumps are pre-primed with water when shipped from the factory. If your solution is not compatible with water, disassemble the Pump Head Assembly. Thoroughly dry the pump head, valves, O-rings, balls and diaphragm. Reassemble head assembly tightening screws in a crisscross pattern. Refill the pump head with the solution to be pumped before priming the pump. (This will aid in priming.)

---

### Liquid Compatibility



Determine if the materials of construction included in the liquid handling portion of your pump are adequate for the solution (chemical) to be pumped. Always refer to the solution supplier and the LMI® Chemical Resistance Chart for compatibility of your specific LMI® metering pump. Contact your local LMI® distributor for further information.

---

### NSF 61 Certified Chemicals



The pump has been certified for compliance with NSF/ANSI STANDARD 61, Drinking Water System Components - Health Effects. Always refer to the solution supplier and the LMI® NSF 61 Addendum for a list of certified chemicals for your specific LMI® metering pump. Contact your local LMI® distributor for further information.

---

### Tubing Connections



Inlet and outlet tubing or pipe sizes must not be reduced. Outlet tubing size must not be increased. Make certain that all tubing is **SECURELY ATTACHED** to fittings prior to start-up (see section 3.3 Tubing Connections). **ALWAYS** use LMI® supplied tubing with your pump, as the tubing is specifically designed for use with the pump fittings. It is recommended that all tubing be shielded and secure to prevent possible injury in case of rupture or accidental damage. If tubing is exposed to sunlight, black UV resistant tubing should be installed. Check tubing frequently for cracks and replace as necessary.

---

### Vinyl Tubing



Your carton may contain a roll of clear vinyl tubing; this is only for connection to the return line of the FASTPRIME™ Head and must not be used as discharge tubing.

---

## Section 1.0 - Precautions

---

### Fittings and Machine Threads



All fittings should be hand-tightened. An additional 1/8 - 1/4 turn after the fitting is snug may be necessary to provide a leak-proof seal. Excessive overtightening or use of a pipe wrench can cause damage to the fittings, seals, or pump head.

Most LMI® pumps have straight screw machine threads on the head and fittings and are sealed by the O-rings. **DO NOT** use PTFE tape or pipe dope to seal these threads. PTFE Tape may only be used on NPT threads.

---

### Plumbing



Always adhere to your local plumbing codes and requirements. Be sure installation does not constitute a cross connection. Check local plumbing codes for guidelines. LMI® is not responsible for improper installations.

---

### Back Pressure/Anti-Syphon Valve



If you are pumping downhill or into low or no system pressure, a backpressure /anti-syphon device should be installed to prevent over pumping or syphoning. Contact your LMI® distributor for further information.

---

### Electrical Connections



**WARNING:** To reduce the risk of electrical shock, the metering pump must be plugged into a properly grounded grounding-type receptacle with ratings conforming to the data on the pump control panel. The pump must be connected to a good ground. **DO NOT USE ADAPTERS!** All wiring must conform to local electrical codes. If the supply cord is damaged, it must be replaced by the manufacturer, stocking distributor, or authorized repair center in order to avoid a hazard.

---

### Flooding



**WARNING:** Install this pump in a location where flooding cannot occur.

---

### Ground Fault Circuit Interrupter



**WARNING:** To reduce the risk of electric shock, install only on a circuit protected by a Ground Fault Circuit Interrupter (GFCI).

---

### Line Depressurization



To reduce the risk of chemical splash during disassembly or maintenance, all installations should be equipped with line depressurization capability.

---

### Over Pressure Protection



To ensure safe operation of the pump it is recommended that some type of safety / pressure-relief valve be installed to protect the piping and other system components from failing due to excessive pressure.

### Chemical Concentration



There is a potential for elevated chemical concentration during periods of no flow, for example, during backwash in the system. Steps, such as turning the pump off, should be taken during operation or installation to prevent this.

See your distributor about other external control options to help mitigate this risk.

### Retightening Components



Plastic materials will typically exhibit creep characteristics when under pressure over a period of time and to insure a proper fit it may be necessary to retighten the head bolts periodically. To insure proper operation, we recommend tightening the bolts to 25 inch-pounds after the first week of operation and on a monthly basis thereafter.

### Flow Display



The accuracy of the flow value as shown on the pump display is highly dependent on the specific application. Calibration is necessary in order to display an accurate measure of the flow.

### Spills



**CAUTION:** Spills of Dangerous chemicals should be cleaned up immediately.

## 2.0 Introduction

LMI® manufactures an extensive line of Chemical Metering Pumps, pH / ORP controllers and related accessories for water and waste water treatment industries. This manual addresses the installation, maintenance and troubleshooting procedures for manually and externally controlled pumps. LMI® has a worldwide network of stocking representatives and authorized repair centers to give you prompt and efficient service.



**Please review this manual carefully. Pay particular attention to warnings and precautions.**



**Always follow good safety procedures, including the use of proper clothing, eye and face protection.**

This manual is for LMI® PD Series ELECTRONIC METERING PUMP.

## 2.1 Electronic Metering Pump Specifications

**Table 1:** General Specifications

Ingress protection	IP65 / NEMA 4X
Voltage / Frequency	110-240 V / 50-60 Hz
Max. Current / Wattage	36W @ 115V / 50W @ 230V
Operation environment	Indoor / Outdoor
Process fluid temperature	-10°C to +50°C (14F to 122F)
Operating ambient temperature	-10°C to +50°C (14F to 122F)
Storage temperature	-40°C to +70°C (-40F to 160F)
Operating humidity range:	0-95% RH (Non-condensing)
Repeatability accuracy	+/- 3%
Turndown	200:1
Max Suction Lift	5 ft / 1.5m
Max Stroke Speed	160 SPM



**Table 2: Liquid End Specifications**

Output Code	Stroke Length [in]	fl. Oz. per Stroke	mL per Stroke	PSI	GPH	BAR	LPH
PDx1	0.038	0.0033	0.099	450	0.1	30.6	0.38
				300	0.2	20.4	0.76
				150	0.25	10.2	0.95
PDx4	0.051	0.0067	0.197	250	0.35	17.0	1.32
				150	0.52	10.2	1.97
				50	0.68	3.4	2.57
PDx5	0.045	0.0133	0.394	150	0.80	10.2	3.03
				110	1	7.5	3.79
				30	1.1	2	4.2
PDx6	0.042	0.0267	0.789	70	1.7	4.8	6.44
				60	1.85	4.1	7
				50	2	3.4	7.57

(1) Maximum flow rate measured with water and flooded suction.

## 2.2 Unpacking Check List

Your carton will contain many or all of the following items. Please notify the carrier immediately if there are any signs of damage to the pump or its parts.



Metering Pump



Foot Valve

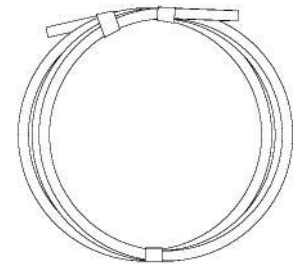

Tubing (0 or 3 Rolls)



Ceramic Foot Valve Weight



Injection Check Valve



Four – Function Valve  
(Optional)



Low Level Sensor (Optional)



External Control Cable  
(Optional)



Tube Connection Hardware

## 3.0 Installation

### 3.1 Pump Location and Installation

Locate pump in an area convenient to solution tank and electrical supply.

The pump should be accessible for routine maintenance, and should not be operated in ambient temperatures above 122°F (50°C). If the pump will be exposed to direct sunlight, LMI® black, UV resistant tubing should be installed.

This pump is cord connected and not intended for permanent mounting to a building. However, temporary mounting to stabilize the pump during operation may be necessary as long as tools are not required for the installation or removal of the pump.

### 3.2 Pump Mounting

The PD Pump provides six mounting holes.

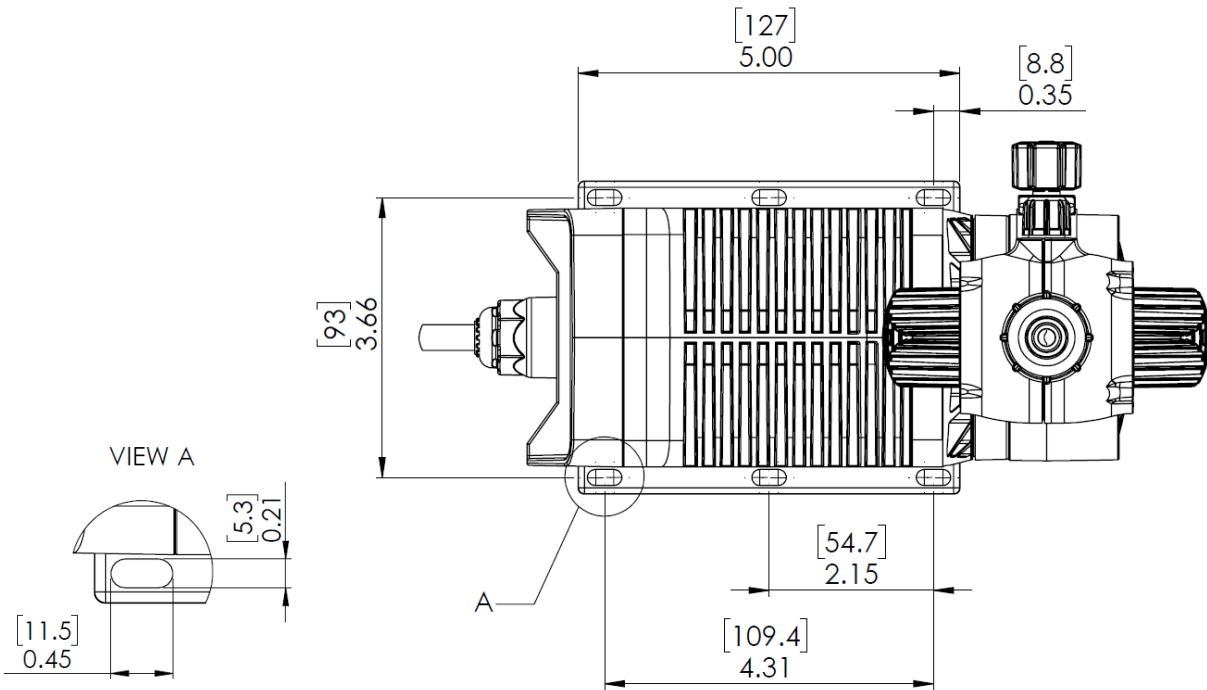

**Figure 1: Mounting Footprint Dimensions**

The pump can be mounted in one of two ways:

- **Flooded Suction** (ideal installation); or
- **Suction Lift** - when suction lift is less than specified in

## Section 3.0 - Installation

- Table 2: Liquid End **Specifications** and the fluid has a specific gravity of water and viscosity of less than 50 cPs (centipoise). For denser or more viscous solutions, consult distributor.

Note that suction conditions can affect the performance of the pump. This effect is more pronounced with lower pressure pumps. Consult your distributor for additional information.

Your LMI® metering pump must be mounted so that the suction and discharge valves are vertical.



***NEVER position pump head and fittings horizontally.***

### 3.2.1 Flooded Suction

For flooded suction, the pump is mounted at the base of the storage tank. This installation is the most trouble-free, and is recommended for very low outputs, solutions that gasify, and high-viscosity solutions. Since the suction tubing is filled with solution, priming is accomplished quickly and the chance of losing prime is reduced. A foot valve is not necessary in a flooded suction installation.



**When pumping downhill or into a low or no pressure system, a backpressure / anti-syphon device should be installed to prevent over pumping or syphoning.**

Although popular for all solutions, LMI® recommends flooded suction installations for all high-viscosity fluid applications.



**INCORRECT**

Avoid this type of false flooded suction

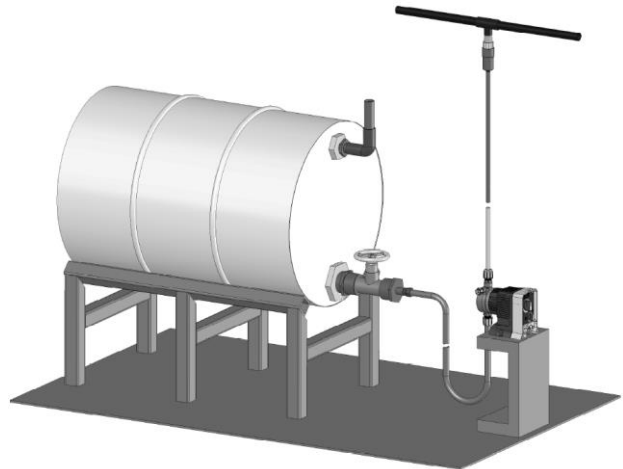

**CORRECT**

**Figure 2: Flooded Suction Pump Mount**

### 3.2.2 Suction Lift – Wall Bracket Mount

The pump may be mounted using an LMI® Wall Mount Bracket Assembly (part no. 34643) directly above the solution tank. A pump mounted in this manner allows for easy changing of solution tanks or drums.

### 3.2.3 Suction Lift - Tank Mount

The pump may be mounted on a molded tank provided there is a recess to keep the pump stationary. LMI® 10-gallon tank (part no. 27421), 35-gallon tank (part no. 27400) and 50-gallon tank (part no. 26350) have molded recesses for pump mounting.

### 3.2.4 Suction Lift - Shelf Mount

The pump may be mounted on a shelf (customer supplied) maintaining a suction lift of less than 5 ft (1.5 m). An LMI® mounting kit (part no. 10461) is available for securing the pump to a shelf.

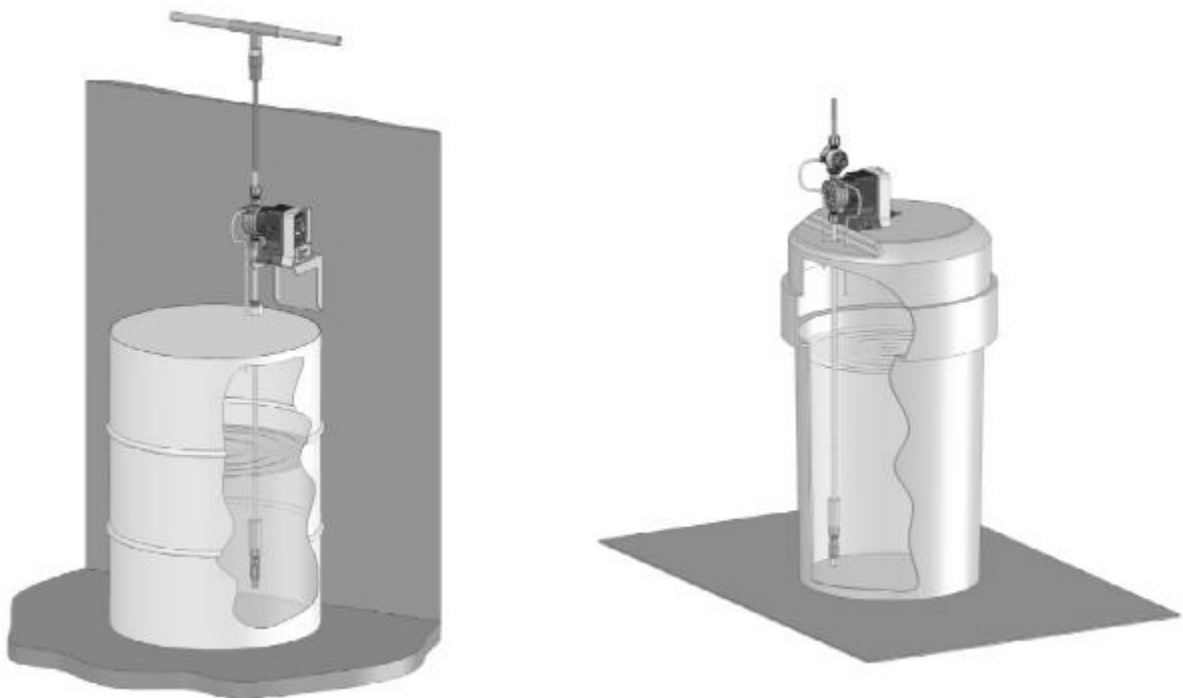

**Figure 3: Suction Lift Mounts**

## 3.3 Tubing Connections

Use only LMI® supplied tubing with your pump, as the tubing is specifically designed for use with the pump fittings. Before installation, all tubing must be cut with a clean square end. Valve and head connections from the factory are capped or plugged to retain pre-primed water. Remove and discard these caps or plugs before connecting tubing.

## Section 3.0 - Installation



**Do not use clear vinyl tubing on the discharge side of the pump. The pressure created by the pump can rupture vinyl tubing, which is only for connection to the return line of the FastPrime™ fitting.**

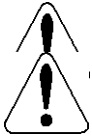

**Do not use pliers or pipe wrench on coupling nuts or fittings.**

**Do not reuse ferrules — use only new ferrules.**

The LMI® Tubing Connection System provides a reliable system to connect your pump to corresponding tubing sizes. To assemble tubing onto the fitting:

1. Insert tubing through coupling nut. Tubing should enter the smaller end of the coupling nut first, orienting the larger opening of the coupling nut toward the tubing end.
2. Position the ferrule
  - a. For 1/4" OD tubing: Position the Female Ferrule so that 1/4" to 3/8" (5-10 mm) of tubing protrudes from the Female Ferrule. Orient the raised collar of the Ferrule toward the Coupling Nut (reference Figure 4: 1/4" OD Tubing Connections).
  - b. For 3/8" or 1/2" OD tubing: Position a Female Ferrule about one inch (25 mm) from end of tubing. Orient the raised collar of the Female Ferrule toward the Coupling Nut. Then, insert the Male Ferrule onto the end of the tube, pushing the tube into the bottom of the groove in the Male Ferrule. Then slide the Female Ferrule down the tubing and with your fingers, press tightly into the Male Ferrule (reference Figure 5: 3/8" or 1/2" OD Tubing Connection).
3. Firmly hand tighten the Coupling Nut onto the fitting.
4. NOTE: Tightening with pliers may cause the ferrules to break.

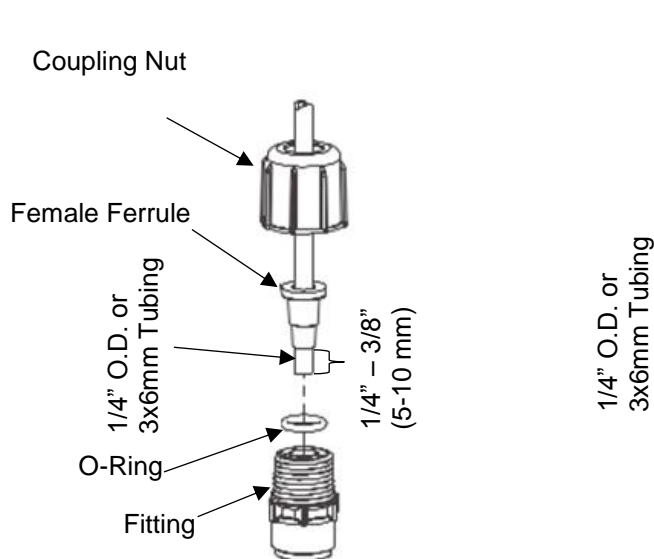

**Figure 4: 1/4" OD Tubing Connections**

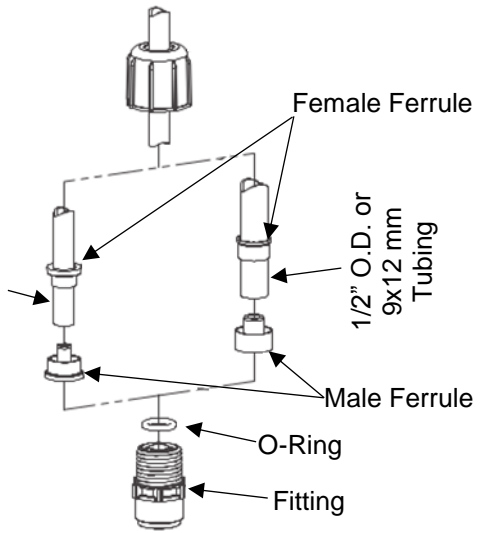
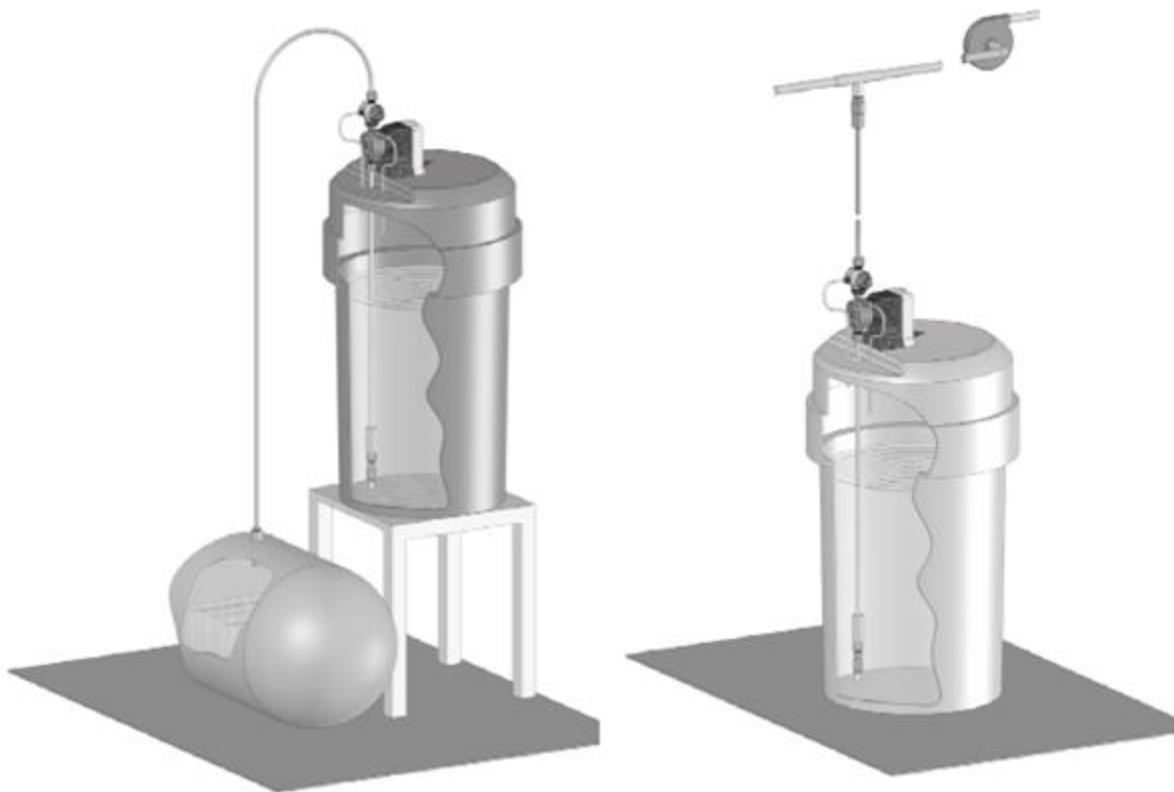

**Figure 5: 3/8" or 1/2" OD Tubing Connection**

### 3.4 Four – Function Valve (4-FV)

Your pump may be equipped with a 4-FV, or standard discharge valve. If your pump is not equipped with a 4-FV and you feel it is needed in your application, it can be purchased as an accessory. Contact your local LMI® stocking distributor. The features of a 4-FV are listed. 4-FV prevents syphoning when pumping downhill into low or no pressure. 4-FV prevents syphoning when pumping into a vacuum such as the suction side of recirculating pump.

1. **Pressure Relief:** If the discharge line is over pressurized, the valve opens sending solution back to the supply tank.
2. **Line Depressurization:** Opening the relief knob provides line drain back to the supply tank.
3. **Anti-Syphon:** Prevents syphoning when pumping solution downhill or into a vacuum.
4. **Back Pressure:** Supplies approximately 25 psi back pressure to prevent over pumping when little or no system back pressure is present.



4-FV prevents syphoning when pumping downhill into low or no pressure.

4-FV prevents syphoning when pumping into a vacuum such as the suction side of a recirculating pump.

**Figure 6: Typical Installations Requiring the Anti-Syphon Feature of a Four-Function Valve**



### 3.5 Four – Function Valve Installation

To install a 4-FV, the 4-FV Fitting and Coupling Nut should be assembled with the appropriate cartridges into the discharge port of the pump. Use a 13/16" or 20 mm socket to tighten fitting. Tightening to 50 inch-pounds is recommended. Do not over tighten. To assemble the 4-FV body, assemble the coupling nut and the threads at the bottom of the body. Firmly hand tighten the body in the desired orientation. Next, insert the 1/4" tubing through the bleed nut. Ensure that about 1/4" (6 mm) of tubing is protruding through the tip of the bleed nut. Firmly hand tighten the bleed nut in the hole on the side of the 4-FV. This tubing should be routed back to the supply tank. To ensure proper function of the priming function, the end of this tubing should not be submerged in the solution.



***This return line tubing must be secured to ensure pumped solution will safely return to supply tank.***

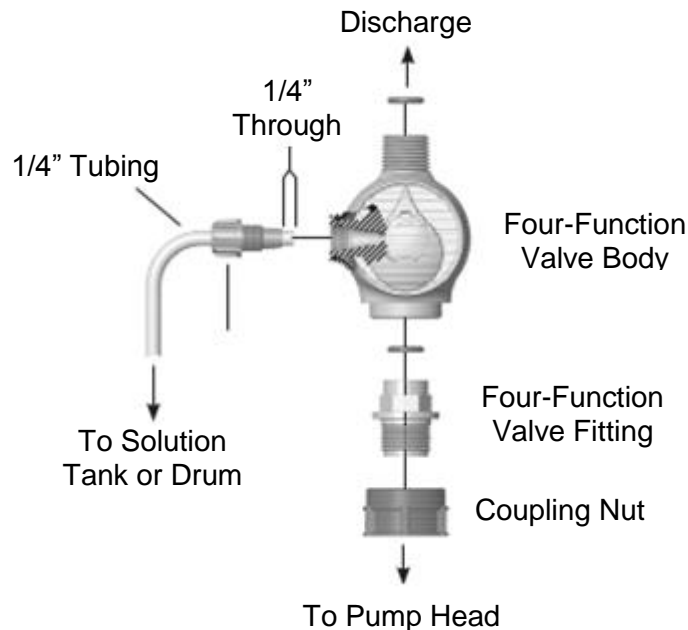

**Figure 7: Four – Function Valve Tubing Connection**

### 3.6 FastPrime™

The **FastPrime™** Head is equipped with a valve that allows for opening the head to atmospheric pressure. When installing a pump equipped with a **FastPrime™** Head connect the 3/8" outer diameter clear vinyl tubing provided with the pump to the barbed nozzle. Route the vinyl return line back to the solution tank. This tubing must not be submerged in the solution.

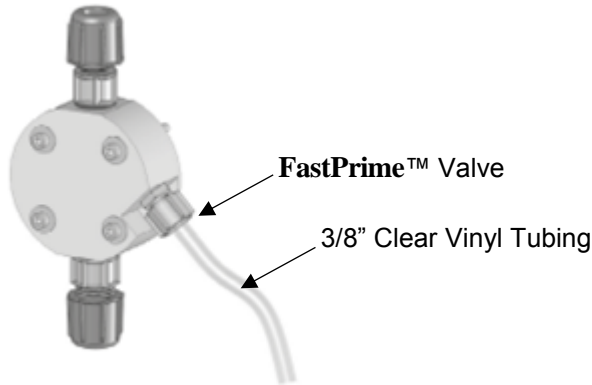

Figure 8: FastPrime™ Head

### 3.7 AUTOPRIME™

The **AUTOPRIME™** Liquid End is equipped with a valve that allows for constant removal of vapors and gasses inherent with effervescent chemicals such as sodium hypochlorite and hydrogen peroxide. The valve keeps the pump primed automatically. When installing a pump equipped with an **AutoPrime™** Liquid End connect the 1/2" OD polyethylene tubing to the top vertical fitting and route this line back to the supply tank. To ensure priming, this tubing should not be submerged in the solution. The horizontal fitting is the discharge and the bottom vertical fitting is the suction.

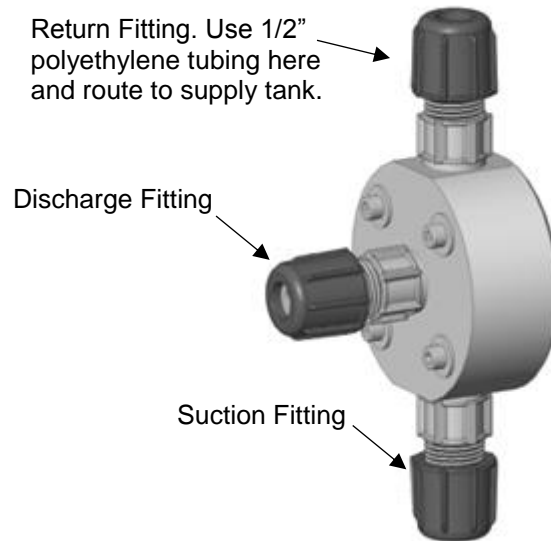

Figure 9: AutoPrime™

### 3.8 Foot Valve / Suction Tubing Installation

The foot valve acts as a check valve to keep the pump primed in suction lift applications.

The foot valve is designed to be submersed in the solution tank or drum and must sit in a vertical position at the bottom. Position approximately 2" (50 mm) above the bottom of the tank or drum sediment layer.

The ceramic weight, when installed, helps position the foot valve in a vertical position.

1. Attach the foot valve to one end of the suction tubing (see section 3.3 Tubing Connections).
2. Slide the ceramic weight over the tubing end until it contacts the top of the foot valve coupling nut.
3. Place foot valve and tubing into the solution tank. Check that the foot valve is vertical and approximately 2" (50 mm) from the bottom of the tank or drum (Figure 10). Connect the other end of the tubing to the suction side of the pump head (bottom side) (see section 3.3 Tubing Connections).

**Note:** Pump models equipped with high-viscosity liquid ends are not equipped with foot valves. Flooded suction is recommended. A 1/2" NPT connector is included for flooded suction installations.

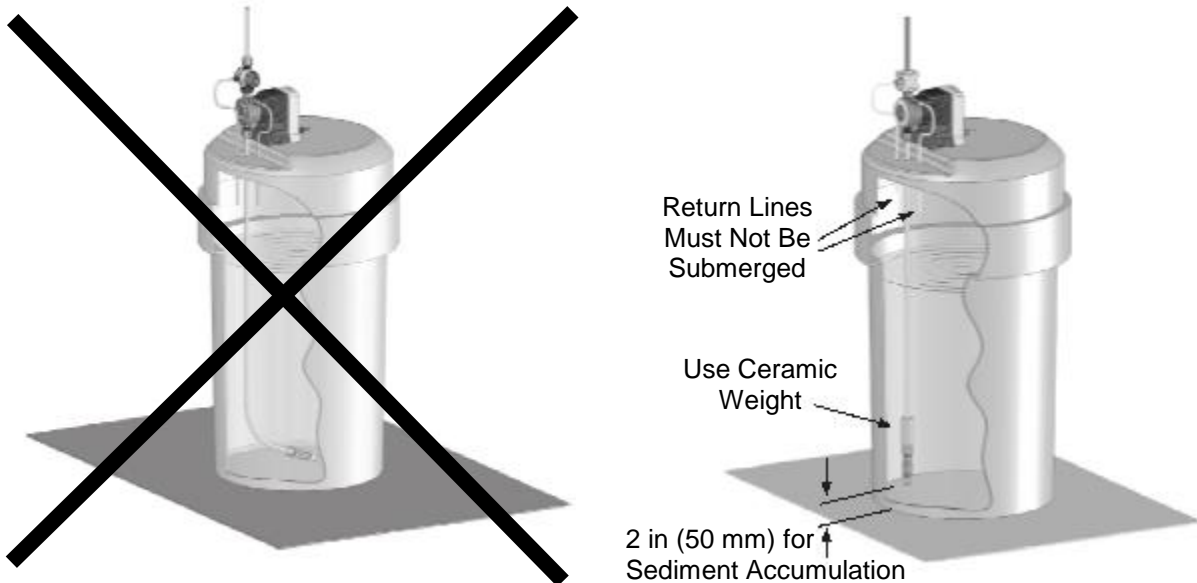

**INCORRECT**

Foot Valve tilted sideways *WILL NOT PRIME*

**CORRECT**

Foot Valve must remain vertical

**Figure 10: Foot Valve / Suction Tubing Installation**

### 3.9 Injection Check Valve and Discharge Tubing Installation

The injection check valve prevents backflow from a treated line.

1. Install the injection check valve at the location where chemical is being injected into the system. Any size female NPT fitting or pipe tee with a reducing bushing to 1/2" female NPT will accept the injection check valve. PTFE tape should only be used on threads that are connected with pipes.
2. When installing the injection check valve, be sure to position it so that the valve enters the bottom of your pipe in a vertical position. Variations left and right within 80° are acceptable (Figure 11).
3. After cutting an appropriate length of tubing, connect tubing to the injection check valve then back to the discharge side of the pump head. Make sure it does not crimp or come into contact with hot or sharp surfaces (see section 3.3 Tubing Connections).

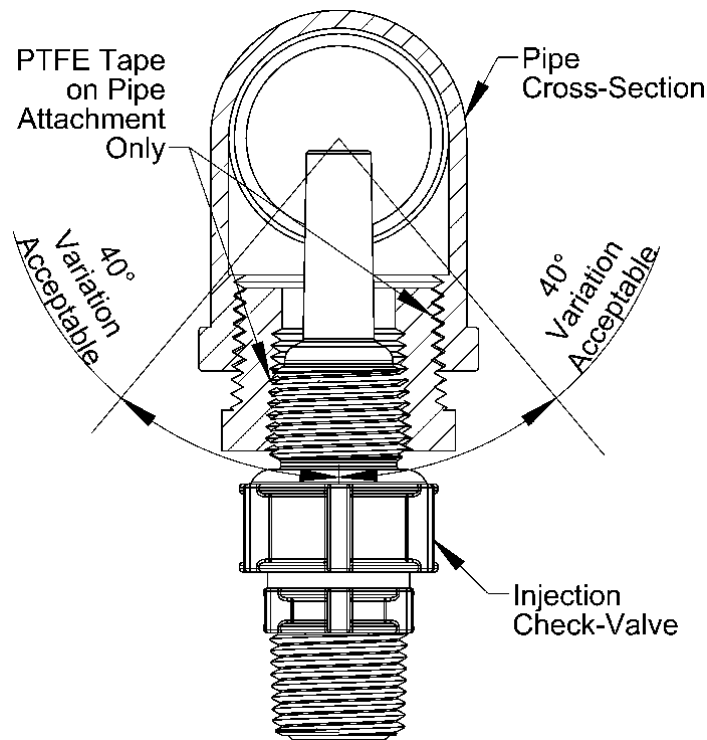

**Figure 11: Typical Injection Check Valve Installation**

## 4.0 Operation

### 4.1 Controls, Inputs and Outputs







Figure 12: PD0XX Adjustment Controls

1. **Speed Adjustment Knob:** This knob provides adjustment of the stroking speed. Turning this knob clockwise increases stroke frequency (speed) from a minimum of 0.8 strokes per minute to a maximum of 160 strokes per minute.



Figure 13: PD7XX Adjustment Controls

2. **Display:** The 2.4" Full Color Display will show the current operating mode, running status, stroke rate, estimated flow rate, percentage of maximum capacity, and alarm indication.
3. **Menu/Cancel Button:** The  **Menu Button** is used to enter the Settings Menu. The  **Menu Button** can also be used to exit the current Settings Menu or cancel an edit operation. The Menu can only be accessed while the pump is stopped.
4. **Enter Button:** The  **Enter Button** is used to select an option when in the Settings Menu. The  **Enter Button** can also be used to enter edit mode for a value in the Settings Menu.

5. **Play/Stop Button:** The  **Play/Stop Button** is used to turn the pump ON or OFF. If the pump is not running, pressing the  **Play/Stop Button** will cause the pump to start running. If the pump is running, pressing the  **Play/Stop Button** will stop the pump. The  **Play/Stop Button** can also be held for 1.5 seconds to begin Prime Mode that will cause the pump to run at maximum speed for 60 seconds then return to the previous state.

6. **↵ → Increase and Decrease Buttons:** The **↵ → Increase and Decrease Buttons** are used to increase or decrease the speed of the pump when in Manual Mode. These buttons can be pressed once to increment the capacity percentage by 0.5% or held to quickly change the value. The **↵ → Increase and Decrease Buttons** can also be used to navigate the Settings Menu and adjust values while in edit mode. 

7. **External Control Connector (5-Pin):**

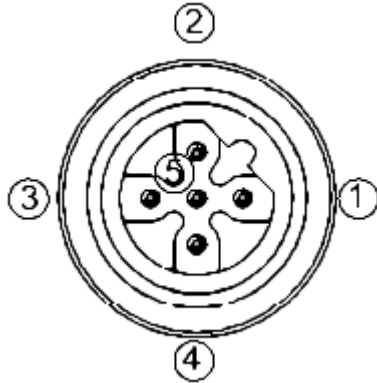

This connector is for the connection of various options and accessories that can be used to externally control the pump. This connector is compatible with the LMI® 5-Pin Cordset (48414) and the LMI® Connector 5-Pin (48490). Refer to Figure 15 for connection information and Sections 4.4.2 and 4.5 for details on using these functions.

The pin functions are as follows:

1. Remote On/Off Signal (Brown)
2. Ground/Return Connection (White)
3. External Pulse Signal (Blue)
4. 24 VDC, 75 mA Power Supply (Black)
5. NC (Gray or Green/Yellow)

8. **Low-Level Connector (3-Pin):**

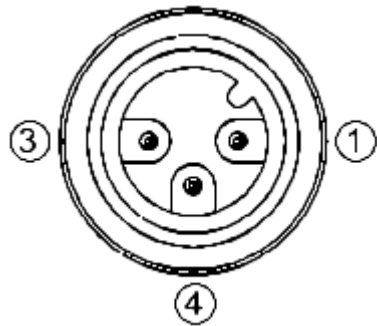

This connector is for the connection of a Low-Level Sensor (49246) or a Dual-Level Sensor (49249). Other tank level sensors can be integrated by using the LMI® Connector 3-Pin (49253). Refer to Section 4.6 for details on using these functions.

The pin functions are as follows:

1. Tank Empty Signal
3. Tank Low Signal
4. Ground/Return Connection

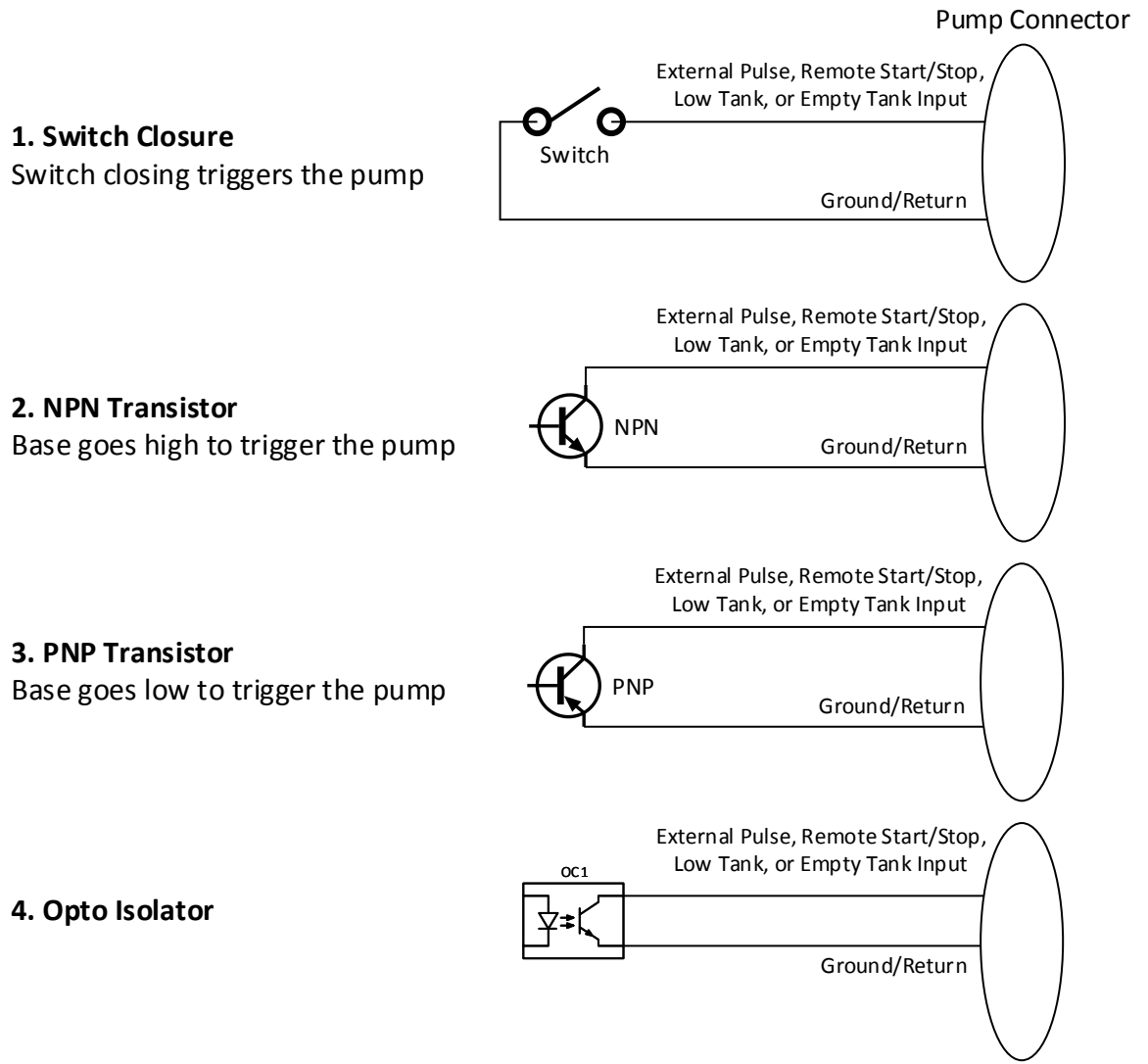

Figure 14: Methods of Externally Triggering the Pump

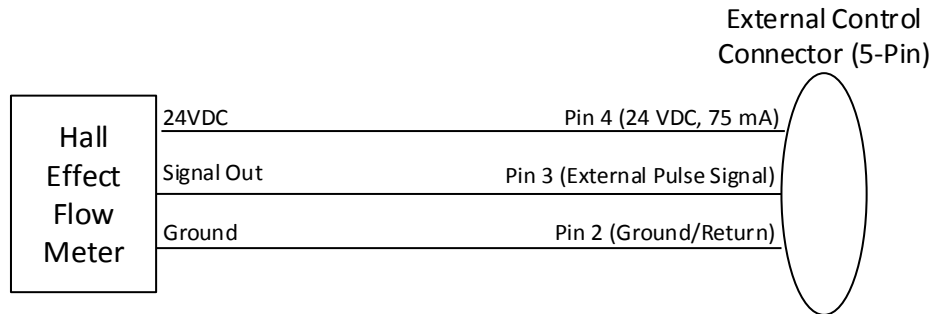
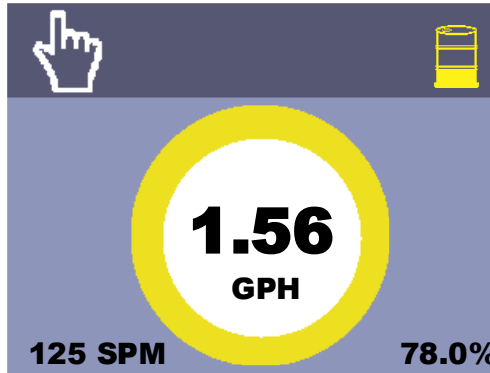

Figure 15: Hall Effect Flowmeter Input Connection Reference

## 4.2 Icons (PD7XX Pumps)

The PD7XX Pump is equipped with a color display. Table 3 shows the function of display screen icons.

**Table 3:** Pump Icons



**PD7XX Home Screen**



Manual Mode



External Pulse Mode



Pump Stopped by Remote Start/Stop Signal



Tank Empty (Pump will Stop)



Tank Low





Service Reminder (User Totalizer exceeds stroke count for diaphragm. Reset User Totalizer to clear Service Reminder.)







PD7XX Settings Menu

- 

Main Menu
- 

Calibration
- 

Play/Stop (Press the physical Play/Stop button to start/stop calibration. Screen icon highlights to show status)
- 

Minimum Pulse Width Setting
- 

Confirm
- 

Units
- 

Factory Totalizer (Cannot be reset)
- 

User Totalizer (Can be reset)
- 

**STAYPRIME™** Degassing Technology Enabled when in Menu and **StayPrime™** Degassing Technology active when on Homescreen



**StayPrime™** Degassing Technology Recurrence (Time between Priming Events)



**StayPrime™** Degassing Technology Duration (Length of Priming Events)



System Information



Reset (Used to return to factory calibration, restore software defaults, or clear User Totalizer)



Pump Stopped (Not Running)



Pump Running (In External Pulse Mode, the pump may be waiting for pulses.)



Low Tank Alarm



Empty Tank Alarm

### 4.3 START-UP AND ADJUSTMENT

The pump is normally self-priming if suction lift is 5 ft (1.5m) or less and the steps below are followed. Pumps are shipped from the factory with water in the pump head to aid in priming.

#### 4.3.1 Start-Up/Priming for FastPrime™ Heads (LE-XXXNX)



**READ THIS ENTIRE SECTION COMPLETELY BEFORE PROCEEDING.**

When all precautionary steps have been taken, the pump is mounted, and the tubing is securely attached, you may now start priming the pump.

1. Plug in or switch the pump on.

2. While the pump is running, set the Speed Adjustment Knob 100% on the PD0XX Pump or press and hold the **Play/Stop Button** for 1.5 seconds on the PD7XX Pump.
3. Turn the **FastPrime™** knob 1 to 2 turns counter-clockwise.
4. The suction tubing should begin to fill with solution from the tank.
5. A small amount of solution will begin to discharge out the return line of the **FastPrime™** valve.
6. Once this happens, turn the knob clockwise until hand tight and SHUT THE PUMP OFF.
7. The pump is now primed.
8. Proceed to Section 4.4 Output Adjustment.

Note: If the pump does not self-prime, remove the fitting on the discharge side of the pump head. Remove the check valve and pour water or solution into the port until the head is filled. Replace valve, then follow start up/priming steps.

### 4.3.2 Start-Up/Priming for Pump Supplied with 4-FV (LE-XXSX)



**READ THIS ENTIRE SECTION COMPLETELY BEFORE PROCEEDING.**

When all precautionary steps have been taken, the pump is mounted, and the tubing is securely attached, you may now start priming the pump.

1. Plug in or switch the pump on.
2. While the pump is running, set the Speed Adjustment Knob 100% on the PD0XX Pump or press and hold the **Play/Stop Button** for 1.5 seconds on the PD7XX Pump.
3. Open the relief side (black knob) of the 4-FV by turning to the stop (about 1/8 turn).
4. The suction tubing should begin to fill with solution from the tank.
5. A small amount of solution will begin to discharge out the return line of the 4-FV. Once this happens, return the knob to the 12:00 position and SHUT THE PUMP OFF.
6. The pump is now primed.
7. Proceed to Section 4.4 Output Adjustment.

Note: If the pump does not self-prime, remove the 4-FV on the discharge side of the pump head. Remove the check valve and pour water or solution into the port until the head is filled. Replace valve, then follow start up / priming steps.

### 4.3.3 Start-Up/Priming for AutoPrime™ Heads (LE-XXXAX)



**READ THIS ENTIRE SECTION COMPLETELY BEFORE PROCEEDING.**

When all precautionary steps have been taken, the pump is mounted, and the tubing is securely attached, you may prime the pump.

1. Plug in or switch on the pump.
2. While the pump is running, set the Speed Adjustment Knob 100% on the PD0XX Pump or press and hold the **Play/Stop Button** for 1.5 seconds on the PD7XX Pump.
3. The suction tubing should begin to fill with solution from the tank as the **AutoPrime™** valve purges air from the pump head.

4. Once the solution begins to exit the pump head through both the discharge valve and the **AutoPrime™** valve, SHUT THE PUMP OFF.
5. The pump is now primed.

### 4.4 Output Adjustment

Once the pump has been primed, an appropriate output adjustment **MUST** be made. Pump output should be calculated and adjustments made accordingly.

#### 4.4.1 Manual Mode

The PD Pump has a fixed stroke length and a maximum stroke speed of 160 SPM. The pump output can be adjusted by reducing the stroke speed. Calculate the approximate output of the pump as follows:

$$\text{Pump Output} = \text{Max Pump Output} * \text{Percent Speed}$$

##### **Example: PD061-948SI**

Use Max Output (from dataplate on side of pump) = 1.0 GPH (gallons per hour).

If the pump speed is set at 50%, the approximate pump output is:

$$1.0 * 0.50 = 0.5 \text{ GPH.}$$

Multiply by 24 (hours in one day) to calculate in gallons per day.

##### **Note:**

*When converting between different units, remember these conversion factors:*

- 1 Gallon = 3.785 Liters
- 1 Day = 1,440 Minutes
- 160 SPM = 9,600 SPH

**It is important to note that this is only an approximate output and it does not account for tolerance variations in pump components or flow variations due to pressure sensitivity, or viscosity effects. Variations due to these effects can be significant, necessitating calibration for your pump.**

The PD7XX Pump contains multiple operation modes. In Manual mode, the PD7XX Pump responds to the flow rate entered by the user. With the home screen displayed (Figure 16), press the **Start/Stop Button** to turn the pump ON and OFF. Press the **Left** or **Right Buttons** to decrease or increase the desired flow rate. Changes can be made while the pump is running or stopped. The estimated flow rate value will appear in the center of the display.

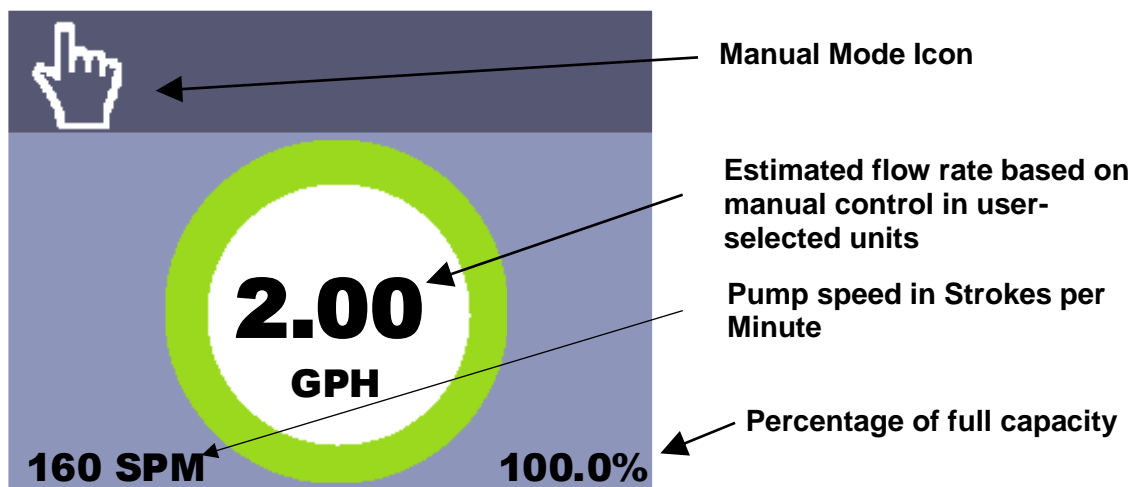

Figure 16: PD7XX Manual Mode Home Screen

#### 4.4.2 External Pulse Mode (PD7XX Pumps)

In External Pulse Mode, the pump relies on an incoming digital pulse to set the flow rate based on user settings. This allows for the pump speed to be set remotely by a controller such as the Liquitron DM7000, a PLC/SCADA system, or a flowmeter to dose a proportional amount of chemical to the process fluid. The pump will accumulate up to 500 pulses and continue to run until the demanded chemical is delivered. The External Pulse Signal Pin 3 is normally 24 VDC and must be connected to the Ground/Return Pin 2 to trigger a pulse. The switch or transistor used must be capable of switching 24 VDC at 15 mA. The minimum time in the low impedance state (ON) is configurable between 4 msec and 60 msec. Refer to Figure 14 for methods of externally triggering the pump.

With the home screen displayed and the pump stopped (Figure 18), press the **Menu Button** to enter the Settings Menu. Press the **Right Button** then the **Enter Button** to enter the External Pulse Settings (Figure 17). The number of pulses per event should be configured to match the characteristics of the triggering device (e.g. the number of pulses per Liter). Next, configure the volume of chemical to pump per event. The pump will calculate the required stroke rate based on the following equation:

$$SPM = \frac{Volume\ per\ Event * Incoming\ Pulse\ Rate}{Pulses\ per\ Event * Calibrated\ Volume\ per\ Stroke}$$

For example, for a PD71X that was calibrated at 0.1mL/stroke, a chemical concentration of 100mL per Liter is required, the flowmeter outputs 10 pulses per Liter, and the incoming pulse rate was 1 pulse per minute, the pump's stroke rate would be

$$\frac{10mL * 1\ pulse/min}{10\ Pulses\ per\ Event * 0.1mL/Stroke} = 100\ SPM.$$

The Maximum Capacity setting will limit the maximum speed while in External Pulse Mode. The speed of the pump is determined by the incoming pulse rate, but it will not exceed the

## Section 4.0 - Operation

Maximum Capacity setting. This will prevent an overdose of chemical if there is an error in triggering. The Minimum Pulse Width Setting should be set as long as possible to prevent false triggering. Any pulses shorter than the minimum threshold will be ignored.

When configuration is completed, highlight the ✓ **Checkmark Icon** to confirm settings and enter External Pulse Mode. The Home Screen will be displayed with the **Pulse Icon** (Figure 18).

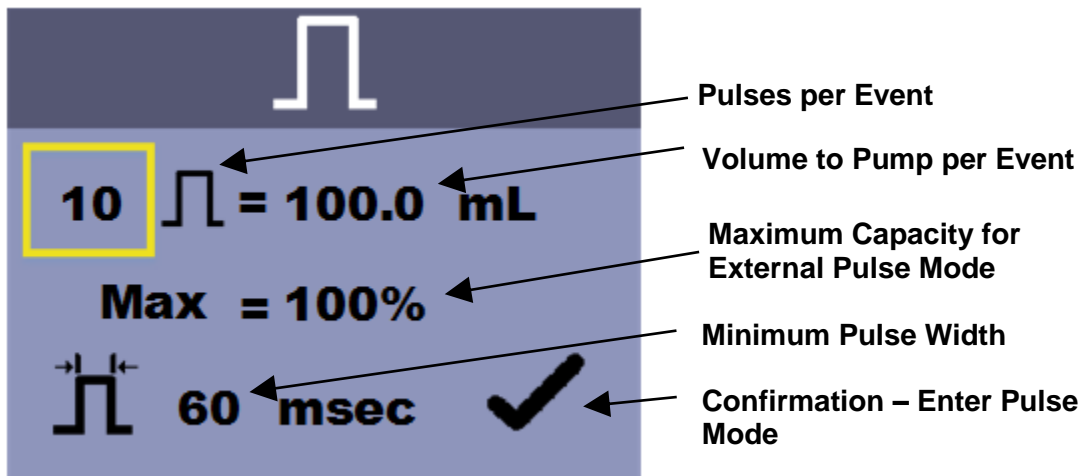

Figure 17: External Pulse Settings

Press the **Start/Stop Button** to place the pump in the Running State (Green Ring). When pulses are detected, the pump will begin running at the determined flow rate. If the pump is in the Stopped State (Gray Ring), the pump will display the flow rate determined by incoming pulses, but will not run the pump. Any queued pulses will be cleared when the **Start/Stop Button** is pressed.

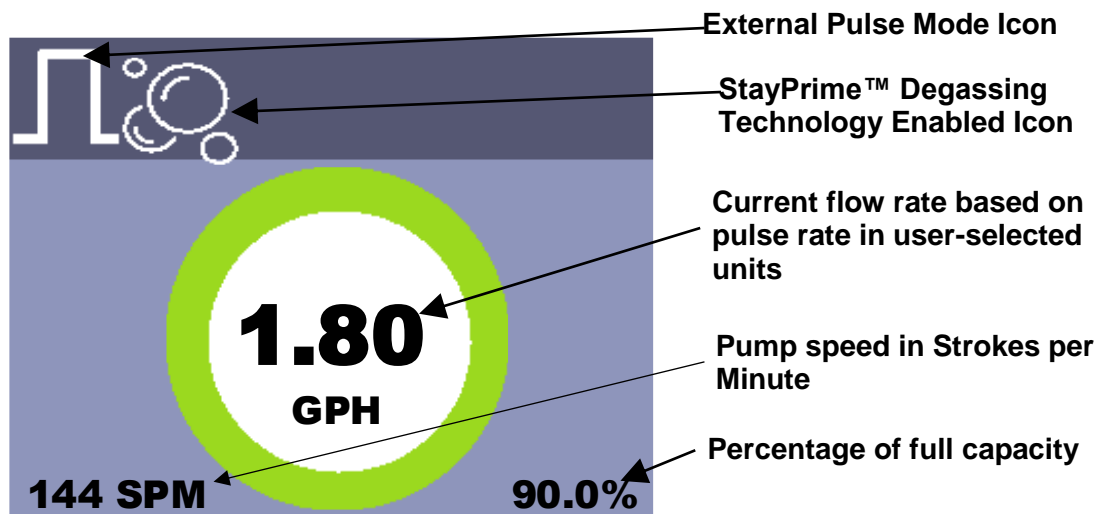

Figure 18: PD7XX External Pulse Home Screen

#### 4.5 Remote Start/Stop

The PD7XX Pump is equipped with a Remote Start/Stop input that can be used with Manual Mode or External Pulse Mode. When the pump is powered on, it will run as normal with the Remote Start/Stop Input OPEN. Once the Remote Start/Stop Input is CLOSED, the pump will enter Remote Mode and require the Remote Start/Stop Input to be CLOSED to run. When the input is OPENED, the pump will stop and display a **Remote Start/Stop Icon** on the Home Screen. When the Remote Start/Stop Input is CLOSED again, the pump will resume operation. The Remote Start/Stop Signal Pin 1 is normally 24 VDC and must be connected to the Ground/Return Pin 2 to indicate a pulse. The switch or transistor used must be capable of switching 24 VDC at 15 mA. Refer to Figure 14 for methods of externally triggering the pump.

#### 4.6 Low Level / Tank Empty

The PD7XX Pump is equipped with digital inputs for Low Level and Tank Empty Sensors. The Tank Empty and Tank Low input connections are always active in all functional modes. If the fluid level drops below the top float on a Dual-Level Sensor, the yellow **Low-Level Icon** will be shown on the top-right corner of the display and the status ring will turn yellow. If the fluid level drops below the float on a Low-Level Sensor, or the bottom float on a Dual- Level Sensor, the red **Tank Empty Icon** will be shown on the top-right corner of the display, the status ring will turn red, and the pump will stop. The pump is designed to recognize an OPEN circuit as full and a CLOSED circuit as low or empty. There is a five second delay between triggering the sensor and the pump's reaction. This is intended to avoid triggering during refilling your supply tank.

The Tank Empty Signal Pin 1 and Low Level Signal Pin 3 are normally 24 VDC and must be connected to the Ground/Return Pin 4 to trigger. If LMI® Liquid Level Switches are not used, the switch or transistor used must be capable of switching 24 VDC at 15 mA. Refer to Figure 14 for methods of externally triggering the pump.

### 4.7 Calibration

Once installation is complete and the approximate output has been determined, the pump should be calibrated. (Calibration cylinders may be purchased from your local LMI® distributor, ref. publication 1798). The PD7XX is equipped to display a theoretical flow rate based upon the pump's stroke speed. These calculations are based on factory test conditions, which may be significantly different from your application. The true flow rate for a given pump output setting can vary depending on many factors including: pressure, temperature, fluid medium, and system layout. It is recommended that the pump be calibrated before use under application conditions. This one-point calibration procedure will greatly improve the accuracy of the pump's theoretical flow rate display.

1. Prepare a device for accurately measuring volume such as a graduated cylinder or a scale sensitive to 1 gram. If using a graduated cylinder, make sure the fluid surface area remains constant during calibration, e.g., the fluid remains above the foot valve weight as shown in Figure 20.
2. Ensure the pump is primed and discharge tubing and Injection Check Valve are installed as they would be in normal service (i.e. including factors such as injection pressure, fluid viscosity and suction lift).
3. Place the Foot Valve in a graduated container or container on scale with a volume of at least 1000 mL.
4. PD0XX Calibration Procedure (If using PD7XX Pump, proceed to step 5):
  - a. Using a stopwatch or timer, turn the pump on for a measured amount of time (120 pump strokes minimum). The longer the time period, the more confident you can be of the results. Be sure to count the number of strokes during the calibration period when making comparisons.
  - b. Turn the pump OFF. Note the time elapsed in relation to volume displaced in the graduate. Now, calculate the output in the time unit you choose (minutes, hours, days, etc).
  - c. If the output is too low or too great, use the Speed Adjustment Knob to fine-tune the amount of flow, estimating required correction and repeat the calibration.
5. PD7XX Calibration Procedure:
  - a. From the Home Screen and the pump stopped, press the **Menu Button** and then the **Right Button** twice to select the **Calibration Icon**. Press the **Enter Button** to enter the Calibration Screen (Figure 19).
  - b. Take a beginning reading on the measuring device, e.g., starting fluid height, tare weight, set scale to zero, etc.
  - c. Press the physical **Start/Stop Button** and the pump will start at the currently set speed, the **Start/Stop Icon** will highlight, and the pump will begin counting strokes. Allow the pump to run as long as possible. Calibration accuracy improves with more strokes (the maximum number of strokes is 999). If using a graduated cylinder with a foot valve, keep the fluid level above the valve and weight.

**Note:**



If in Manual Mode, the pump will run at the currently configured speed. If in External Pulse Mode, incoming pulses will set the speed for calibration. If no pulses are received, the pump will not run. This allows for calibration to be performed under typical operating conditions.

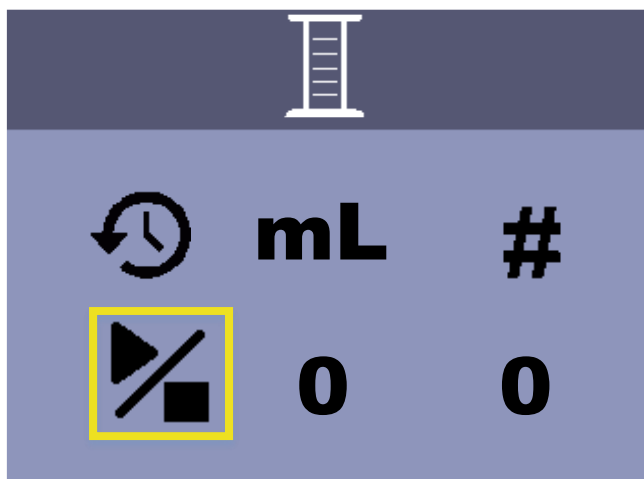

**Figure 19: Pump Calibration (Set Flow Rate)**

- d. Press the **Start / Stop Button** to stop the pump. The screen will display the number of strokes and the estimated Total Volume pumped. The units of total volume are always in mL to allow a direct reading from the cylinder.
- e. Take the final reading of fluid volume in mL. If using a scale, divide the difference between beginning and ending weights in grams by the specific gravity of the chemical solution being pumped. If using a graduated cylinder with a foot valve inserted (Figure 20), the readings will need to be adjusted to compensate for the presence of the suction tubing using the following formula:

$$V_{Actual} = V_{Observed} * \left( 1 - \left( \frac{D_{Tube}}{D_{Column}} \right)^2 \right)$$

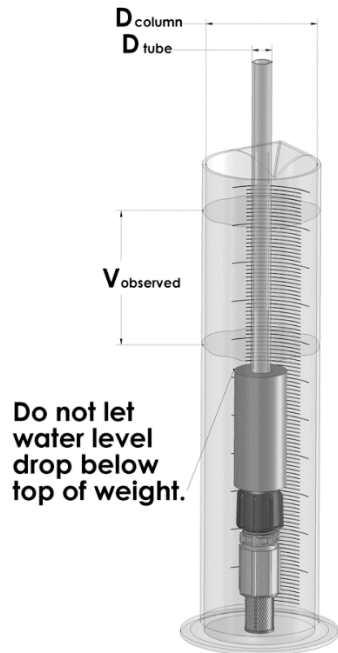

**Figure 20:** Graduated Cylinder

For accuracy, it is important that the water level does not drop below the top of the ceramic foot valve weight.

**Note:** If you will be using the pump at a different pressure, the pump should be recalibrated under those conditions using the procedure above to ensure accuracy.

- f. The total volume box will be highlighted (Figure 21). Using the **Left** or **Right Buttons**, enter the actual volume measured during the calibration then press the **Enter Button**.



**Figure 21:** Calibration Volume Adjustment

- g. Press the **Enter Button** to move to the Calibration Confirmation Screen (Figure 22) or press the **Menu Button** to cancel.

- h. Press the **Enter Button** to move to confirm the calibration settings or press the **Menu Button** to cancel.
- i. In order to restore the factory calibration, select the  **Reset Icon** and press the **Enter Button**.

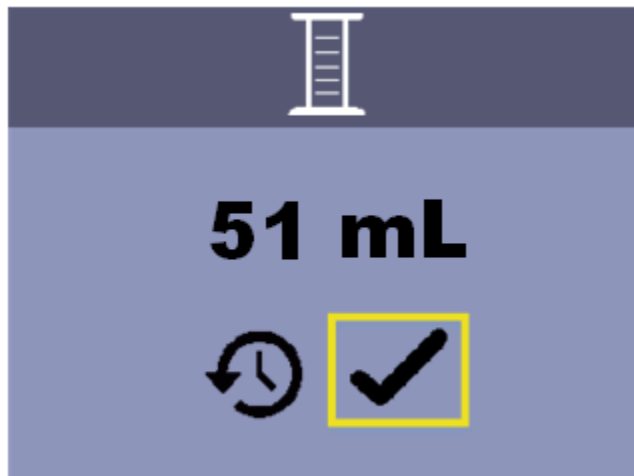
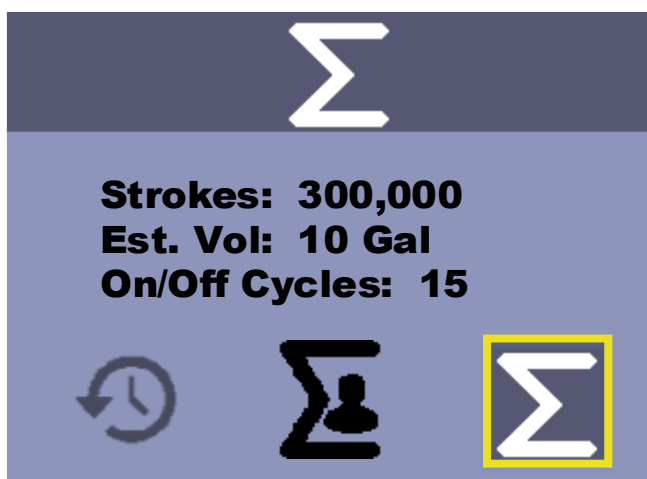

**Figure 22: Calibration Confirmation Screen**

***NOTE:** If the pump is subsequently used at a significantly different pressure, it should be recalibrated under the new conditions following the above procedure to ensure accuracy.*

## 4.8 Totalizer

The PD7XX Pump is equipped with a totalizer function that shows cumulative information in two modes: Pump totals and Totals since last user reset. Pump totals cannot be altered. From the Home Screen, press the **Menu Button** and then the **Right Button** three times to select the  **Totalizer Icon**. Press the **Enter Button** to view the Pump Totalizer Screen (Figure 23). The pump records the number of strokes, the estimated volume pumped, and the number of power cycles.



**Figure 23: Pump Totalizer Screen**

Press the **Left** or **Right Button** to switch to the User Totalizer Screen (Figure 24). When the User Totalizer reaches 40 million strokes, a **Service Reminder Icon** will be displayed on the Home Screen as a reminder to service the diaphragm. Select the **Reset Icon** on the User Totalizer Screen to clear the **Service Reminder Icon**.



Figure 24: User Totalizer Screen

### 4.9 StayPrime™ Degassing Technology

The PD7XX Pump is equipped with **StayPrime™** Degassing Technology that assists in maintaining prime by running the pump at 100% for a short duration when power is applied and after a specified idle time thereafter. The **StayPrime™** Degassing Technology is most useful in the following applications:

- Pump with **AutoPrime™** Liquid End in manual mode and controlled by a power relay – **StayPrime™** will run the pump at 100% when power is applied for fast priming
- Pump with in manual mode that is stopped at the end of a shift – **StayPrime™** will run the pump periodically overnight to maintain prime
- Pump that is externally controlled (Remote Start/Stop or External Pulse) – **StayPrime™** will run the pump periodically to maintain prime



**Once enabled, this feature will run the pump as long as the pump powered on, even if the pump is in Manual Mode with the stroke rate set to 0% or in External Pulse Mode with no incoming pulses. Ensure tubing is connected while feature is enabled.**

From the Home Screen, press the **Menu Button** while the pump is stopped. Then press the **Left Button** three times to select the  **StayPrime™** Degassing Technology Icon. Press the **Enter Button** to view the **StayPrime™** Degassing Technology Configuration (Figure 25). **StayPrime™** Degassing Technology is disabled by default.

When **StayPrime™** Degassing Technology is enabled, the pump will run at 100% stroke rate for the set duration when powered on. The pump will return to its set operating mode and monitor itself for inactivity. Once the **StayPrime™** Idle Timer has been reached (no strokes have occurred in the specified time), the pump will run at 100% for the

**StayPrime™** duration and return to its set operating mode. Select an Idle Timer based on the amount of time in which the pump may lose prime due to off-gassing of chemical. Select a Duration based on the time required to clear the suction line.

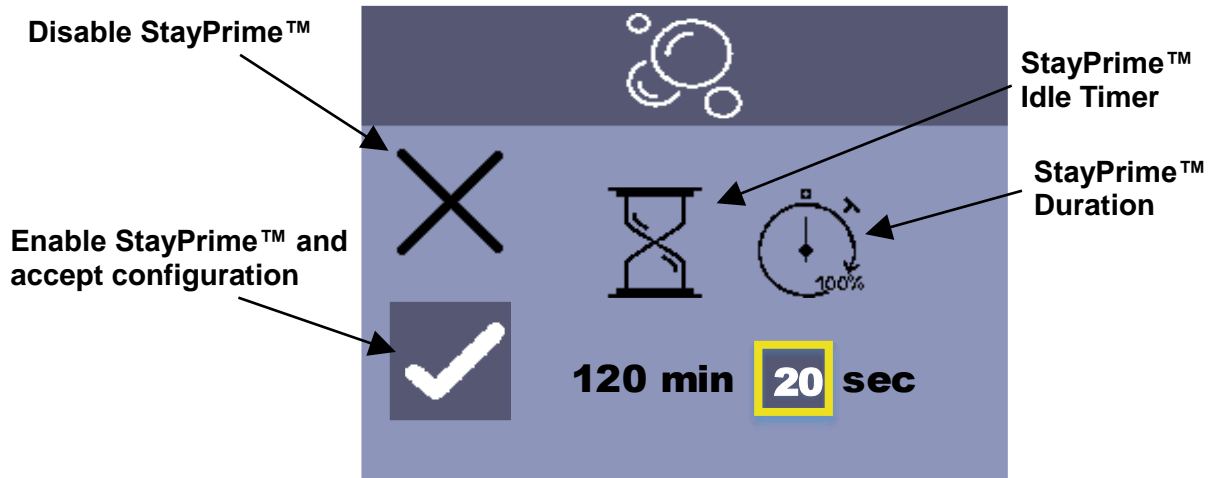

Figure 25: StayPrime™ Degassing Technology Configuration Screen

### 4.10 Units

The PD7XX is equipped to display a theoretical flow rate based upon the pump’s stroke speed. From the Home Screen and the pump stopped, press the **Menu Button** and then the **Right Button** three times to select the **Units Icon**. Press the **Enter Button** to enter the Units Screen (Figure 26). Changes made to the units will impact the flow rate displayed on the Home Screen, volume displayed in the Totalizer, and volume per event used for External Pulse Volume. The volume used in calibration will always use mL.

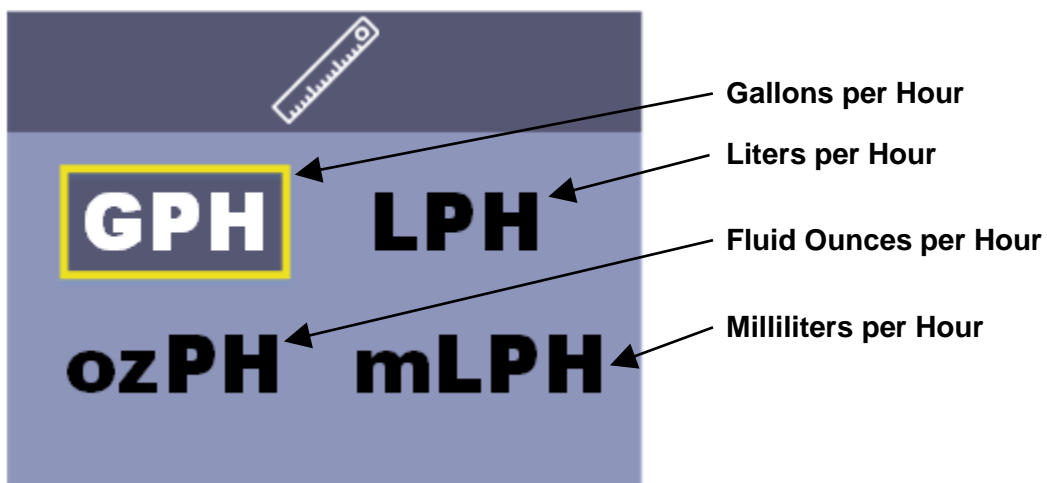

Figure 26: Units Screen

### 4.11 System Information

The PD7XX Pump is equipped with a display that indicates the Hardware and Firmware Versions. This information is useful in troubleshooting or when contacting Customer Service. From the Home Screen and the pump stopped, press the **Menu Button** and then the **Left Button** once to select the **System Information Icon**. Press the **Enter Button** to view the System Information Screen (Figure 27).

Select the **Reset Icon** on the Software Information Screen to restore software defaults. This will reset the operation mode, manual speed, pulse settings, calibration, **StayPrime™** settings, and units to factory defaults. The System and User Totalizer are not reset through this function. Refer to Figure 24 for details on resetting the User Totalizer.



Figure 27: System Information Screen

## 5.0 Spare Parts Replacement and Routine Maintenance

LMI® metering pumps are designed for trouble-free operation, yet routine maintenance of elastomeric parts is essential for optimum performance. This involves replacing the LIQUIFRAM™, cartridge valves, O-rings, and the injection check valve spring. LMI® recommends replacing these parts at least once a year; however, frequency will depend on your particular application.

### 5.1 Depressurizing the Discharge Line



**Always wear protective clothing, face shield, safety glasses and gloves when performing any maintenance or replacement on your pump.**



**To reduce the risk of chemical splash during disassembly or maintenance, all installations should be equipped with line depressurization capability. Using LMI's Four-Function Valve (4-FV) is one way to include this feature.**



**Read steps 1 and 2 below before proceeding.**

## Section 5.0 - Spare Parts Replacement and Routine Maintenance



1. Be sure the Injection Check Valve is properly installed and is operating. If a shut off valve has been installed downstream of the Injection Valve, it should be closed.



**Be sure your relief tubing is connected to your 4-FV and runs back to your solution drum or tank.**

2. If a Four-Function Valve is installed, turn the black knob on the 4-FV 1/8 turn to the stopped position. Turn and hold the yellow knob for a few seconds. The discharge line is now depressurized. Keep both valve knobs open until solution drains back down the discharge tubing into the solution tank or drum. Then release the yellow knob, and turn the black knob to its normal position.
3. If a Four-Function Valve is not installed, turn the **FastPrime™** knob one-and-a-half turns counter-clockwise. The discharge line is now depressurized. Keep valve open until solution drains back down the discharge tubing into solution drum or tank. Then turn the knob clockwise to tighten knob to closed position.

### 5.2 LIQUIFRAM™ (Diaphragm) Replacement

LMI® metering pumps are designed for trouble-free operation, yet routine maintenance of elastomeric parts is essential for optimum performance. This involves replacing the LIQUIFRAM™, cartridge valves, O-rings and the injection check valve spring. LMI® recommends replacing these parts at least once a year; however, frequency will depend on your particular application. The pump will display  **Service Reminder Icon** on the Home Screen when the User Totalizer exceeds 40 million strokes. Select the  **Reset Icon** on the User Totalizer Screen to clear the **Service Reminder Icon**.

When replacing the LIQUIFRAM™, the cartridge valves, or O-rings, the injection check valve spring should also be replaced (see Section 5.3). A Spare Parts Kit or RPM PRO PAC™ kit containing these parts may be obtained from your local distributor.

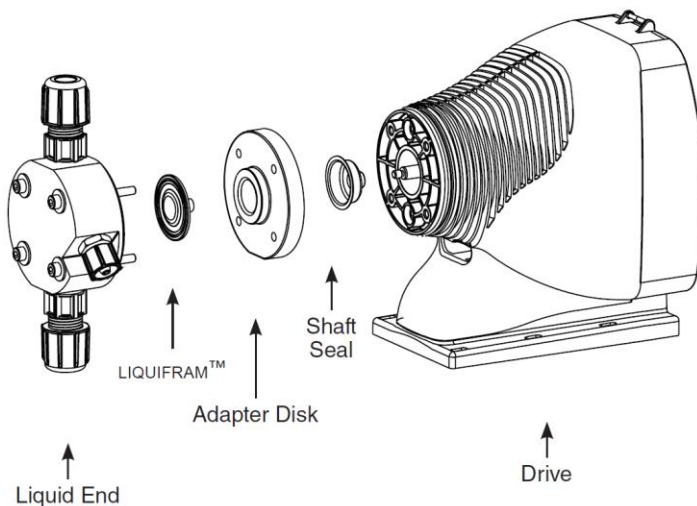

**Figure 28: LIQUIFRAM™ (Diaphragm) Replacement**

### Replacing the LIQUIFRAM™:

1. Carefully depressurize, drain, and disconnect the discharge line (see previous sections in this manual).
2. Place the Foot Valve into a container of water or other neutralizing solution. Turn the pump on to flush the head assembly. Once the pump head has been flushed, lift the Foot Valve out of the solution and continue to pump air into the pump head until the pump head is purged of water or neutralizing solution.

**Note:** If the liquid cannot be pumped due to LIQUIFRAM™ rupture, carefully disconnect the suction and discharge tubing using protective clothing, gloves and face shield, immerse the head in water or other neutralizing solution.

3. Remove the four metric screws and washers from the head using an M4 Allen wrench.
4. With the unit off, unscrew the LIQUIFRAM™ by carefully grasping the outer edge and turning it counter-clockwise. Discard old LIQUIFRAM™. Remove the Adapter Disk (located behind the LIQUIFRAM™) and ensure that the diameter of the raised section is the same as the diameter of the replacement LIQUIFRAM™.
5. Check condition of the Shaft Seal. Replace Shaft Seal if necessary.
6. Replace the Adapter Disk so that the drain hole of the disk is oriented downward and the mounting holes line up with the mounting holes of the pump.



**Be careful not to scratch the FLUOROFILM™ face of the new LIQUIFRAM™.**

7. Screw on the new LIQUIFRAM™ clockwise until turned all the way in.
8. Remount the pump head using the four (4) screws and washers. Loosely tighten the four screws in a crisscross pattern, then retighten each screw to 25 inch-pounds of torque. After one week of operation, recheck the screws and tighten if necessary.

### 5.3 Cartridge Valve and O-ring Replacement



**ALWAYS wear protective clothing, face shield, safety glasses and gloves when working on or performing any maintenance or replacement on your pump. See SDS information from solution supplier for additional precautions.**

Refer to the LMI® Metering Pump Price List for the proper Spare Parts Kit number or contact your local LMI® stocking distributor. Spare Part Replacement Kits include specific instructions for valve replacement. Please follow the instructions included with the replacement kit.

1. Carefully depressurize and disconnect the discharge line (see Section 5.1).
2. Place the foot valve or suction tube into a container of water or other neutralizing solution. Turn the pump on to flush the head assembly. Once the pump has been flushed, lift the foot valve out and continue to pump to let air into the pump head until pump is purged of water or neutralizing solution.



## Section 5.0 - Spare Parts Replacement and Routine Maintenance

**Note:** If the liquid cannot be pumped due to diaphragm rupture, carefully disconnect the suction and discharge tubing using protective clothing, gloves, and face shield. Remove the screws and washers from the head and immerse the head in water or other neutralizing solution.

3. Carefully disconnect one tubing connection and fitting one at a time, then remove and replace the worn valve and O-rings. If necessary, carefully loosen stuck valves by prying side to side using a small screwdriver through the center hole of the valve. Before disassembling the check valves, note the orientation of the valve.
4. Install new check valves in each location. Ensure that the cartridges are oriented correctly.

### 5.4 Injection Check Valve Parts Replacement



**ALWAYS wear protective clothing, face shield, safety glasses and gloves when working on or performing any maintenance or replacement on your pump. See SDS information from solution supplier for additional precautions.**

Refer to the LMI® Metering Pump Price List for the proper Spare Parts Kit number or contact your local LMI® representative. Spare Part Replacement Kits include specific instructions for valve replacement. Please follow the instructions included with the replacement kit.

Carefully depressurize and disconnect the discharge line (see Section 5.1) or isolate injection check valve point using valves so that injection check valve can safely be disassembled.

1. Isolate injection check valve point using valves so that injection check valve can safely be disassembled.
2. Carefully depressurize and disconnect the discharge line (see Section 5.1).

Spare part replacement kits include specific instructions for valve replacement. Please follow the instructions included with the replacement kit.

3. Carefully disconnect the tubing leading to the injection check valve (Figure 29).
4. Remove the injection check valve fitting.
5. Remove and replace the worn spring, seat, ball, and O-ring.

**Note:** Before disassembling the check valve, note the orientation of the parts.

6. Install a new spring, seat, ball, and O-ring. Ensure that the parts are oriented correctly.

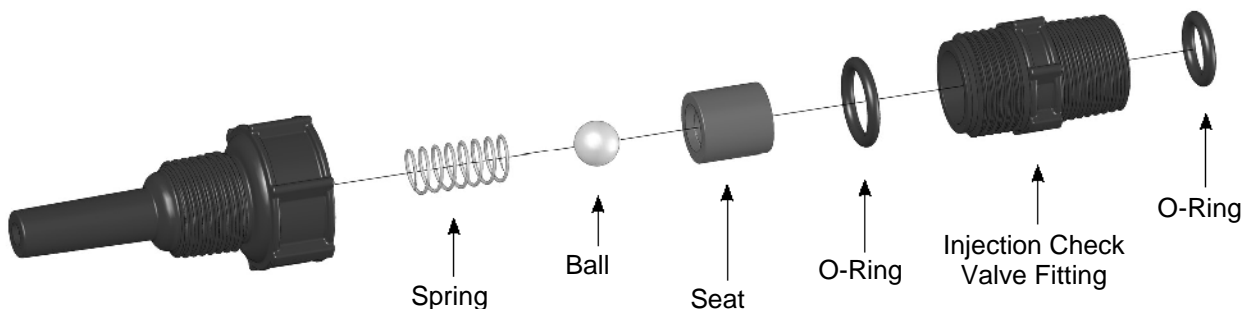

**Figure 29:** Injection Check Valve Assembly

### 5.5 FastPrime™ Valve O-Ring Replacement



**ALWAYS** wear protective clothing, face shield, safety glasses and gloves when working on or performing any maintenance or replacement on your pump. See SDS information from solution supplier for additional precautions.

Refer to the LMI® Metering Pump Price List for the proper Spare Parts Kit or RPM PRO PAC™ kit number or contact your local LMI® stocking distributor.

1. Be sure the Injection Check Valve is properly installed and is operating. If a shut off valve has been installed downstream of the Injection Valve, it should be closed.



**Be sure your relief tubing is connected to your 4-FV and runs back to your solution drum or tank.**

2. Turn the **FastPrime™** Knob one-and-a-half turns counter-clockwise. This will depressurize the head. Keep valve open. Carefully remove the return line by gently pulling tubing and moving it from side to side to gradually back tubing off of the barbed fitting.
3. Hold return line tubing upright until solution drains back into solution drum or tank.
4. Using a 3/4" (or 19mm) socket or wrench remove Retaining Nut, and pull out the entire **FastPrime™** Valve assembly. Remove and replace the two small O-rings.
5. Reinsert the **FastPrime™** Valve assembly and retighten the Retaining Nut. Then turn the **FastPrime™** Knob clockwise to tighten knob to closed position. To avoid damaging the parts, it is important that the flange on the **FastPrime™** Valve is flush with the Retaining Nut prior to reassembly.
6. Recut 1 to 2 inches off the tip of the return line and ensure the end is squared. Press the return line tubing on completely past the barbs.

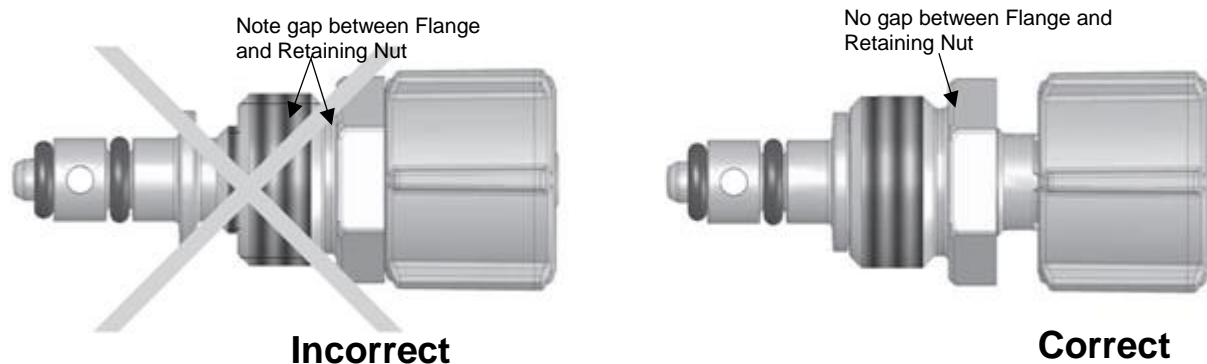

Figure 30: FastPrime™ Valve O-Ring Position

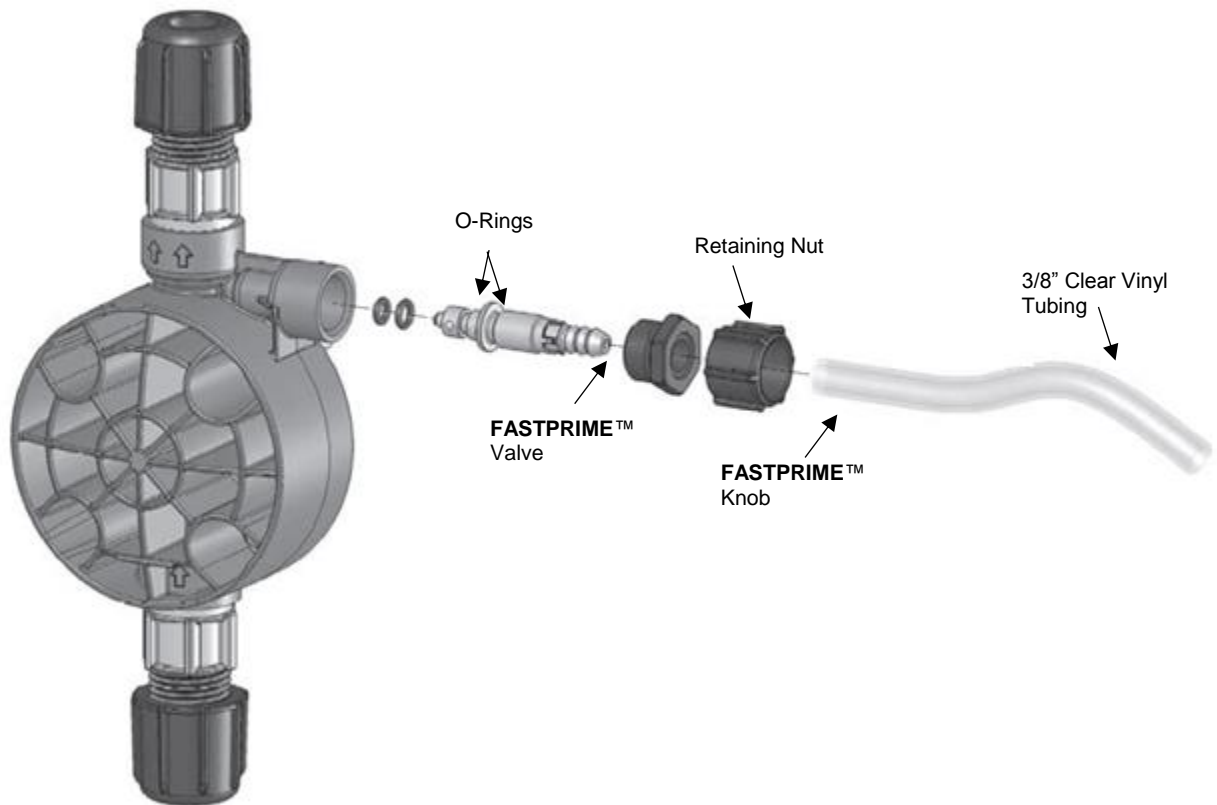

Figure 31: FastPrime™ Valve O-Ring Replacement

## 5.6 Liquid End Parts List

For the latest and most accurate information on your liquid end, please refer to the Liquid End Sheets available in the LMI® Online Library at: [www.support.lmipumps.com](http://www.support.lmipumps.com). Use “Product” drop down to select either “AutoPrime” or “FastPrime”.

The following images are for reference and may not represent your particular liquid end.

## Section 5.0 - Spare Parts Replacement and Routine Maintenance

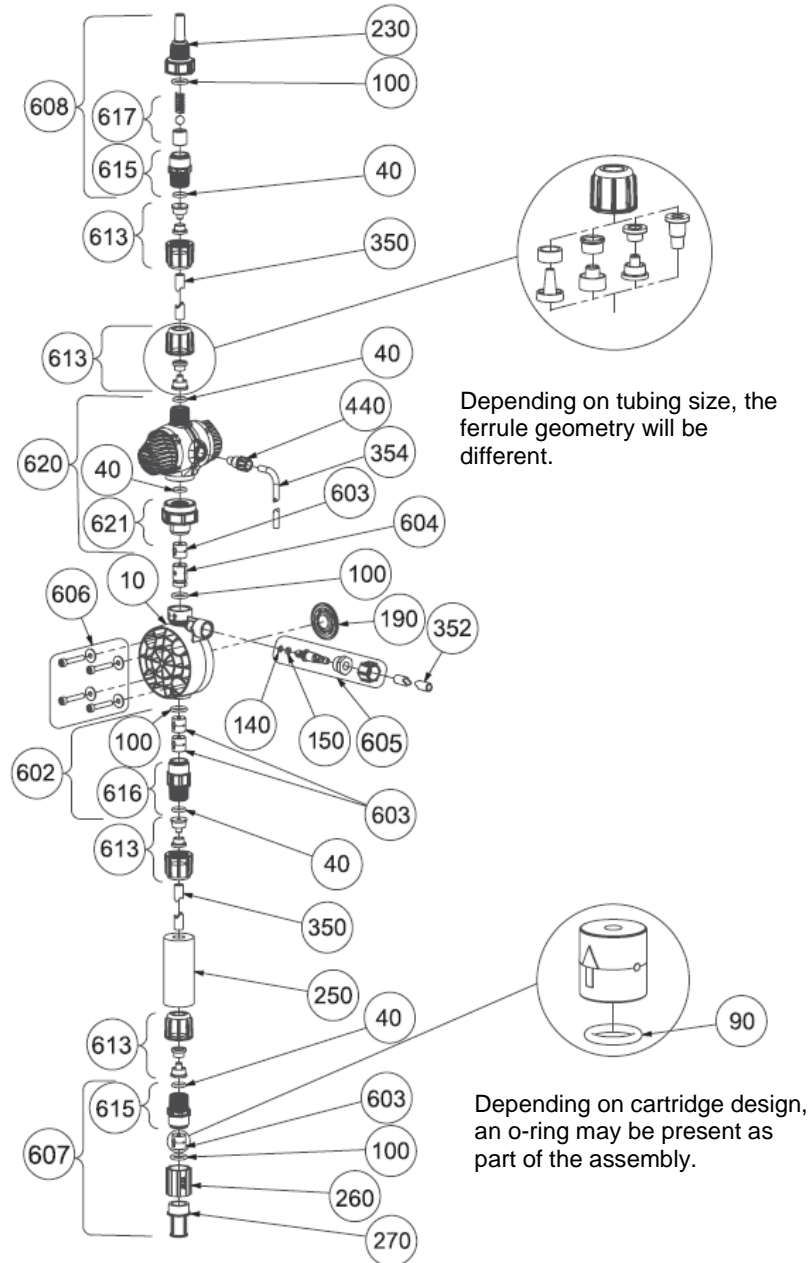

Figure 32: FastPrime™ Liquid End Assembly

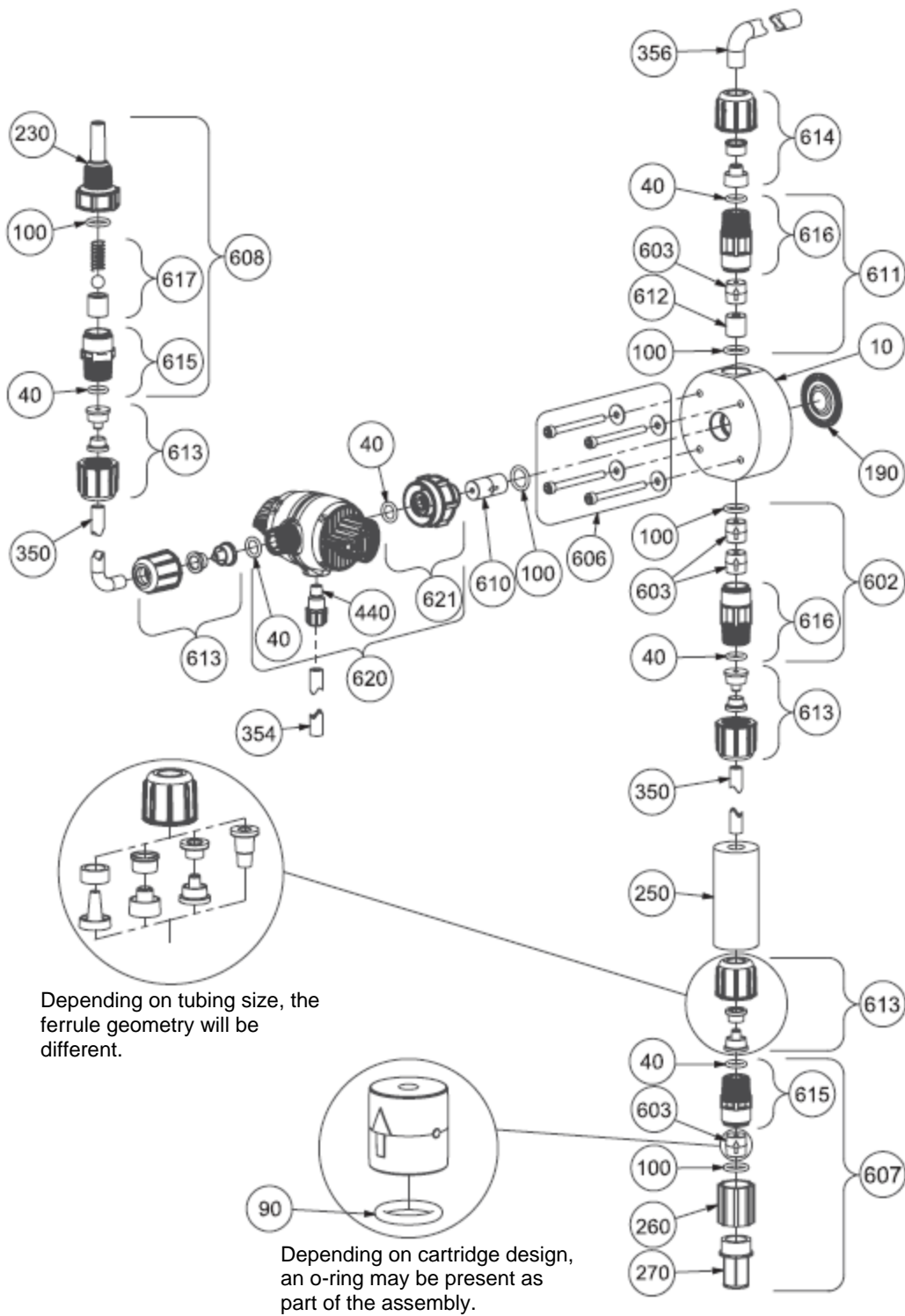
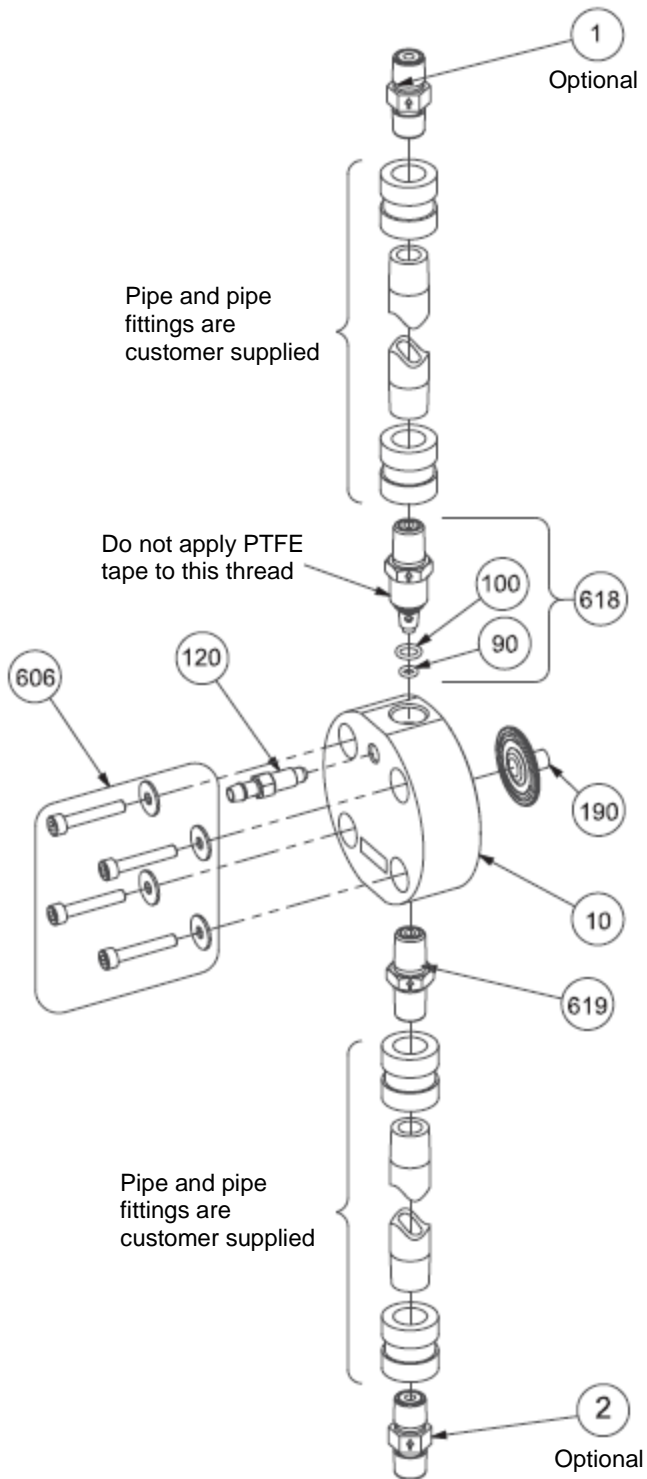

Figure 33: AutoPrime™ Liquid End Assembly

## Section 5.0 - Spare Parts Replacement and Routine Maintenance

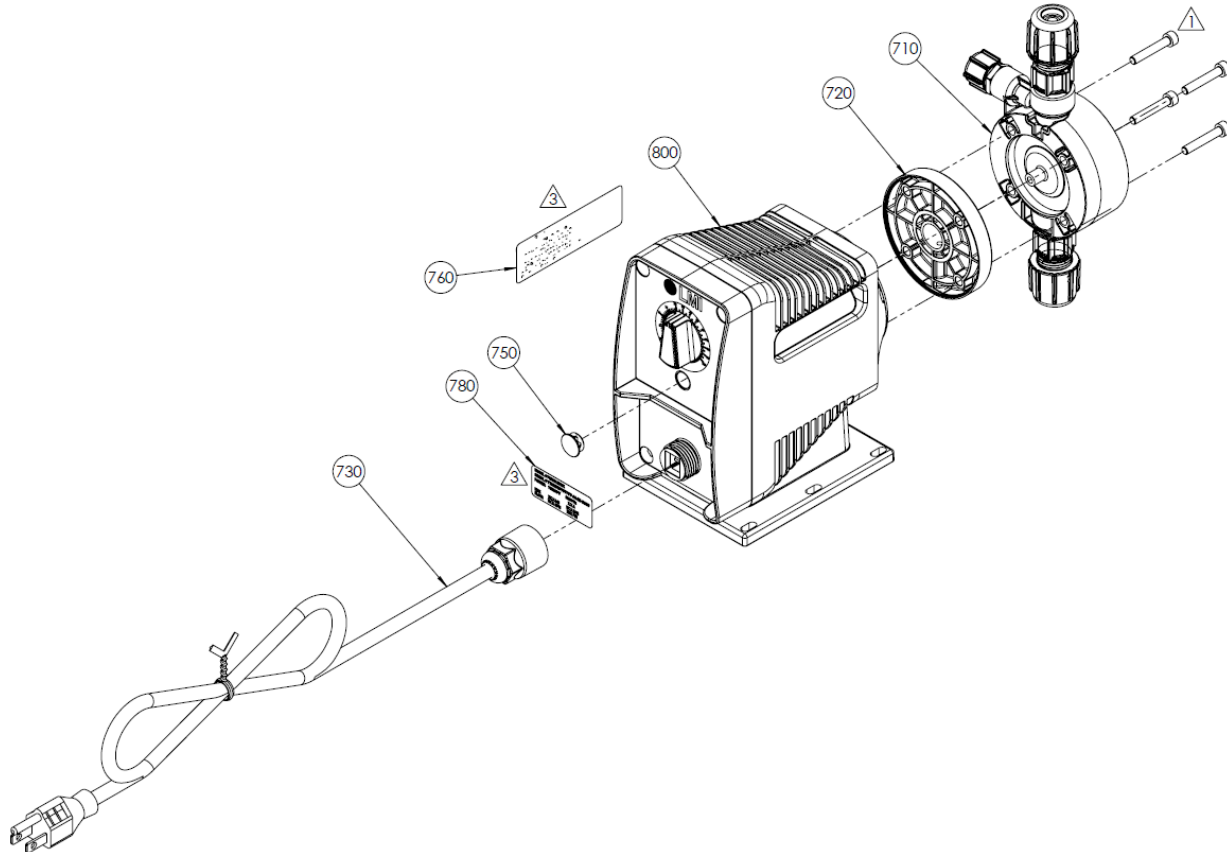

**Figure 34: Stainless Steel Liquid End Assembly**

## 5.7 Drive Assembly Parts List

For the latest and most accurate information on your liquid end, please refer to the Data Sheets available in the LMI® Online Library at: [www.support.lmipumps.com](http://www.support.lmipumps.com). Use “Product” drop down to select “Series PD”.

The following images are for reference and may not represent your particular liquid end.



BUBBLE NUMBER	PART NUMBER	DESCRIPTION	BILL OF MATERIAL FOR ASSEMBLY PART NUMBER											
			PD013-708NI	PD043-728NI	PD053-738NI	PD063-748NI	PD015-708NI	PD045-728NI	PD055-738NI	PD065-748NI	PD016-708NI	PD046-728NI	PD056-738NI	PD066-748NI
800	PD0XX	DRIVE ASM	1	1	1	1	1	1	1	1	1	1	1	
710	LE-708NI	LIQUID HANDLING ASM	1	0	0	0	1	0	0	0	1	0	0	
	LE-728NI		0	1	0	0	0	1	0	0	0	1	0	
	LE-738NI		0	0	1	0	0	0	1	0	0	0	1	0
	LE-748NI		0	0	0	1	0	0	0	1	0	0	0	1
720	48167	DISK, LE ADAPTER	1	0	0	0	1	0	0	0	1	0	0	
	48168		0	1	0	0	0	1	0	0	0	1	0	
	48169		0	0	1	0	0	0	1	0	0	0	1	0
	48170		0	0	0	1	0	0	0	1	0	0	0	1
730	48853	POWER CORD ASM	1	1	1	1	1	1	1	1	1	1	1	
	48855		0	0	0	0	1	1	1	1	1	1	1	
	48856		0	0	0	0	0	0	0	0	1	1	1	
750	55546	CAP PLUG	1	1	1	1	1	1	1	1	1	1		
740	55437	LABEL WARNING	1	1	1	1	1	1	1	1	1	1		
790	55439	SILVER LABEL PUMP DATA	1	1	1	1	1	1	1	1	1	1		
SEE NOTE	56383	QUICK START GUIDE	1	1	1	1	1	1	1	1	1	1		
	30414	BOX, U & P	1	1	1	1	1	1	1	1	1	1		
	55638	BOX INSERT	1	1	1	1	1	1	1	1	1	1		
		STROKE LENGTH SET POINT (INCH)	0.046"	0.051"	0.045"	0.042"	0.046"	0.051"	0.045"	0.042"	0.046"	0.051"	0.045"	

Figure 35: PD0XX Manual Drive Assembly



## Section 5.0 - Spare Parts Replacement and Routine Maintenance

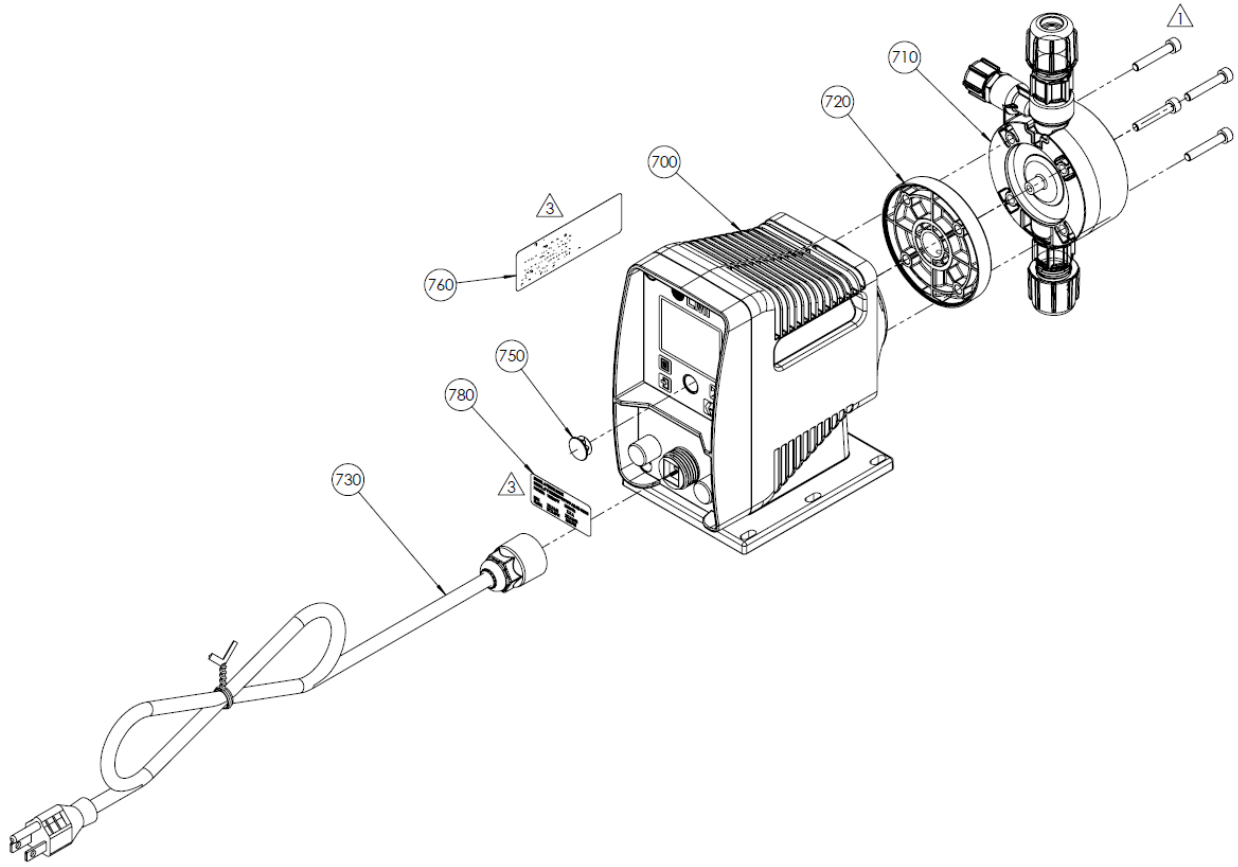

BUBBLE NUMBER	PART NUMBER	DESCRIPTION	BILL OF MATERIAL FOR ASSEMBLY PART NUMBER											
			PD713-708NI	PD743-728NI	PD753-738NI	PD763-748NI	PD715-708NI	PD745-728NI	PD755-738NI	PD765-748NI	PD716-708NI	PD746-728NI	PD756-738NI	PD766-748NI
700	PD7XX	DRIVE ASM	1	1	1	1	1	1	1	1	1	1	1	
710	LE-708NI	LIQUID HANDLING ASM	1	0	0	0	1	0	0	0	1	0	0	
	LE-728NI		0	1	0	0	0	1	0	0	0	1	0	
	LE-738NI		0	0	1	0	0	0	1	0	0	0	1	0
	LE-748NI		0	0	0	1	0	0	0	1	0	0	0	1
720	48167	DISK, LE ADAPTER	1	0	0	0	1	0	0	0	1	0	0	
	48168		0	1	0	0	0	1	0	0	0	1	0	
	48169		0	0	1	0	0	0	1	0	0	0	1	0
	48170		0	0	0	1	0	0	0	1	0	0	0	1
730	48853	POWER CORD ASM	1	1	1	1	0	0	0	0	0	0	0	
	48855		0	0	0	0	1	1	1	0	0	0	0	
	48856		0	0	0	0	0	0	0	1	1	1	1	
740	48414	CORDSET, 5-PIN REVERSE KEY	1	1	1	1	1	1	1	1	1	1		
750	55546	CAP PLUG	1	1	1	1	1	1	1	1	1	1		
760	55637	LABEL, WARNING	1	1	1	1	1	1	1	1	1	1		
780	55639	SILVER LABEL, PUMP DATA	1	1	1	1	1	1	1	1	1	1		
SEE NOTE	56383	QUICK START GUIDE	1	1	1	1	1	1	1	1	1	1		
	30414	BOX, U & P	1	1	1	1	1	1	1	1	1	1		
	55638	BOX INSERT	1	1	1	1	1	1	1	1	1	1		
STROKE LENGTH SET POINT (INCH)			0.046"	0.051"	0.045"	0.042"	0.046"	0.051"	0.045"	0.042"	0.046"	0.051"	0.045"	0.042"

**Figure 36: PD7XX Enhanced Drive Assembly**

### 6.0 Troubleshooting

PROBLEM	POSSIBLE CAUSE	SOLUTION
Pump Will Not Prime	1. Pump not turned on or plugged in.	1. Turn on pump/plug in pump.
	2. Output not set properly.	2. Always prime pump with speed and stroke at 100%.
	3. Foot Valve not in vertical position on bottom of tank.	3. Foot valve must be vertical (see Section 3.8 Foot Valve / Suction Tubing Installation).
	4. Pump suction lift too high.	4. Maximum suction lift, specified in Section 3.2.2 Suction Lift – Wall Bracket Mount. High viscosity liquid handling assemblies require flooded suction.
	5. Suction tubing is curved or coiled in tank.	5. Suction tubing must be vertical. Use LMI® ceramic weight supplied with pump (see Section 3.8 Foot Valve / Suction Tubing Installation).
	6. Fittings are overtightened.	6. <i>DO NOT OVERTIGHTEN FITTINGS!</i> This causes seal rings to distort and not seat properly which causes pump to leak back or lose prime.
	7. Air trapped in suction valve tubing.	7. Suction tubing should be as vertical as possible. <i>AVOID FALSE FLOODED SUCTION!</i> (see Section 3.2.1 Flooded Suction).
	8. Too much pressure at discharge.	8. Shut off valves in pressurized line. Disconnect tubing at injection check valve (see Section 4.3 START-UP AND ADJUSTMENT). When pump is primed, reconnect discharge tubing.
	9. Air leak around fitting.	9. Check for missing or damaged O-rings at ends of fittings.
Pump Loses Prime	1. Solution container ran dry.	1. Refill container with solution and re-prime (see Section 4.3 START-UP AND ADJUSTMENT).
	2. Foot Valve is not in a vertical position on the bottom of the tank.	2. Foot Valve must be vertical (see Section 3.8 Foot Valve / Suction Tubing Installation).
	3. Pump suction lift is too high.	3. Maximum suction lift, specified in Section 2.1 Electronic Metering Pump Specifications. High viscosity liquid handling assemblies require flooded suction.
	4. Suction tubing is curved or coiled in tank.	4. Suction tubing must be vertical. Use LMI® ceramic weight supplied with pump (see Section 3.8 Foot Valve / Suction Tubing Installation).

	5. Fittings are over tightened.	5. <i>DO NOT OVERTIGHTEN FITTINGS!</i> This causes seal rings to distort and not seat properly which caused pump to leak back or lose prime
	6. Air trap in suction valve tubing.	6. Suction tubing should be as vertical as possible. <i>AVOID FALSE FLOODED SUCTION!</i> (see Section 3.2.1 Flooded Suction).
	7. Air leak on suction side.	7. Check for pinholes, cracks. Replace if necessary.
Leakage at Tubing	1. Worn tubing ends.	1. Cut about 1 in (25 mm) off tubing and then replace as before.
	2. Loose or cracked fitting.	2. Replace fitting if cracked. Carefully hand tighten fittings. <i>DO NOT USE PIPE WRENCH.</i> An additional 1/8 or 1/4 turn may be necessary.
	3. Worn seal rings.	3. Replace balls and seal rings (see Section 5.3 Cartridge Valve and O-ring Replacement).
	4. Solution attacking Liquid Handling Assembly.	4. Consult your local distributor for alternate materials.
Low Output or Failure to Pump Against Pressure	1. Pump's maximum pressure rating is exceeded by injection pressure.	1. Injection pressure cannot exceed pump's maximum pressure. See pump data plate.
	2. Worn Seal Rings.	2. Worn seal rings or cartridge valves may need replacement (see Section 5.3 Cartridge Valve and O-ring Replacement).
	3. Ruptured Diaphragm.	3. Replace diaphragm (see Section 5.2 LIQUIFRAM™ (Diaphragm) Replacement).
	4. Tubing run on discharge may be too long.	4. Longer tubing runs may create frictional losses sufficient to reduce pump's pressure rating. Consult factory for more information.
	5. Clogged Foot Valve strainer.	5. Remove Foot Valve strainer when pumping slurries or when solution particles cause strainer to clog.
Failure to Run	1. Pump not turned on or plugged in.	1. Turn on or plug in pump.
	2. Electronic or Mechanical failure.	2. Consult supplier or factory.
Excessive Pump Output	1. Syphoning (Pumping downhill without an anti-siphon valve).	1. Move injection point to a pressurized location or install an anti-siphon valve
	2. Little or no pressure at injection point.	2. If pressure at injection point is less than 30 psi (2.0 Bar), a backpressure valve should be installed.

---

## Section 6.0 - Troubleshooting

---

*We are a proud member of Accudyne Industries, a leading global provider of precision-engineered, process-critical, and technologically advanced flow control systems and industrial compressors. Delivering consistently high levels of performance, we enable customers in the most important industries and harshest environments around the world to accomplish their missions.*



LMI is a registered trademark of Milton Roy, LLC.  
EXCEL is a trademark of Milton Roy, LLC  
Fluorofilm is a trademark of Milton Roy, LLC