

FOUNDATIONS™

BY PARK HARBOR®

Hidden Creek

PHFEL1000BLK/ADBR - EXTERIOR WALL LANTERN

PHFEL1001BLK/ADBR - EXTERIOR WALL LANTERN

PHFEL1002BLK/ADBR - EXTERIOR FLUSH LANTERN

PHFEL1003BLK/ADBR - EXTERIOR HANGING LANTERN

PHFEL1004BLK/ADBR - EXTERIOR POST LANTERN

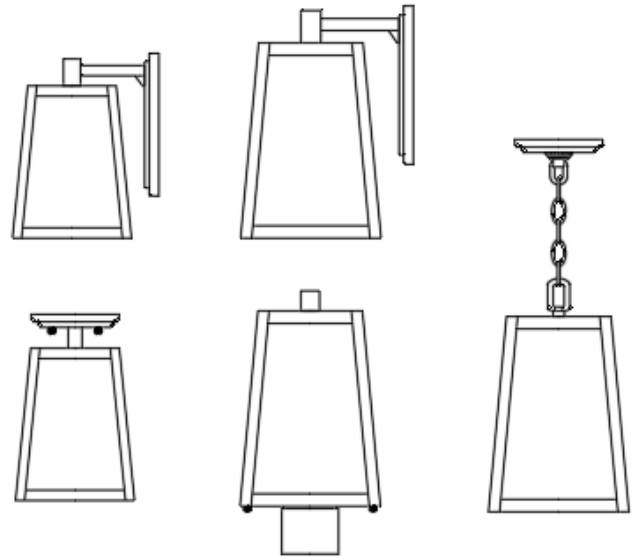

- 1-Light Wall in Black or Dark Bronze
- Clear Water Glass
- No special tools needed for assembly
- Certification:

ETL

PHFEL1000BLK/ADBR: Wet Rated

PHFEL1001BLK/ADBR: Wet Rated

PHFEL1002BLK/ADBR: Damp Rated

PHFEL1003BLK/ADBR: Damp Rated

PHFEL1004BLK/ADBR: Wet Rated

- Canopy dimensions:

PHFEL1002BLK/ADBR: 5" x 5"

- Backplate dimensions:

PHFEL1000BLK/ADBR: 8.1" x 5.4" x 0.75"

PHFEL1001BLK/ADBR: 9" x 6.2" x 0.75"

- Wattage:

PHFEL1000BLK/ADBR: Uses one 100W E26 medium base lamps max

PHFEL1001BLK/ADBR: Uses one 100W E26 medium base lamps max

PHFEL1002BLK/ADBR: Uses one 100W E26 medium base lamps max

PHFEL1003BLK/ADBR: Uses one 100W E26 medium base lamps max

PHFEL1004BLK/ADBR: Uses one 100W E26 medium base lamps max

See dimensional drawing on back.

© 2018 Ferguson Enterprises, Inc. 0000009/18

FERGUSONSHOWROOMS.COM

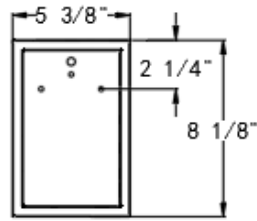
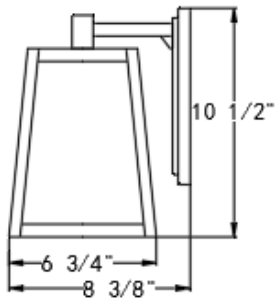
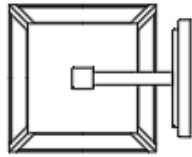

PHFEL1000BLK/ADBR

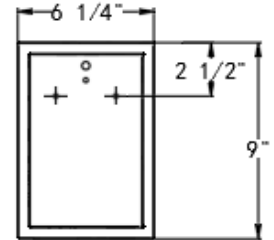
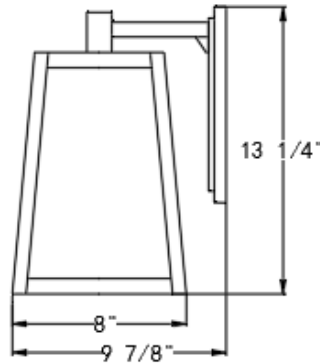
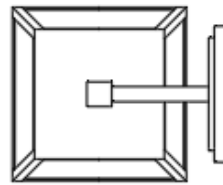

PHFEL1001BLK/ADBR

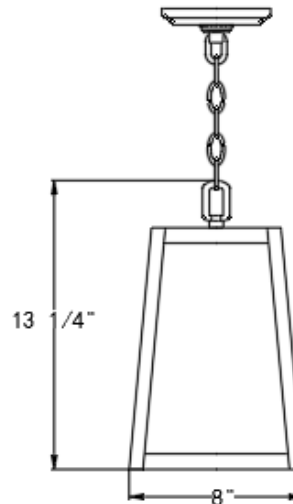
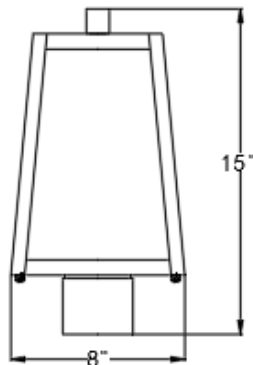
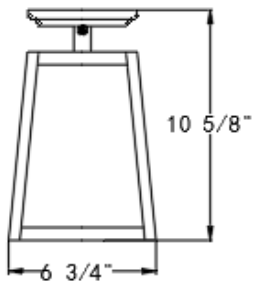
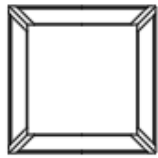

PHFEL1002BLK/ADBR

PHFEL1004BLK/ADBR

PHFEL1003BLK/ADBR