

---

*Comfort-Care*®

---

# OWNER'S MANUAL

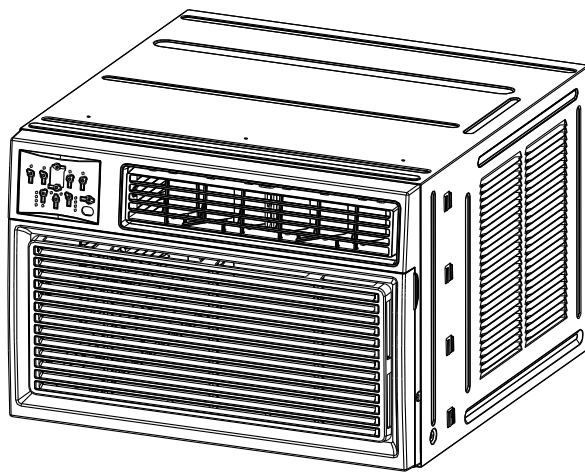

**Room Air Conditioner with R-410A:**  
REG-81M  
REG-123M



# CONTENTS

<b>1. SAFETY PRECAUTIONS.....</b>	<b>2</b>
<b>2. IMPORTANT SAFETY INSTRUCTIONS .....</b>	<b>4</b>
<b>3. NORMAL SOUNDS .....</b>	<b>5</b>
<b>4. AIR CONDITIONER FEATURES .....</b>	<b>5</b>
<b>5. INSTALLATION INSTRUCTIONS.....</b>	<b>10</b>
<b>6. CARE AND CLEANING .....</b>	<b>16</b>
<b>7. TROUBLESHOOTING TIPS.....</b>	<b>17</b>

## Read This Manual

Inside you will find many helpful hints on how to use and maintain your air conditioner properly. Just a little preventive care on your part can save you a great deal of time and money over the life of your air conditioner. You'll find many answers to common problems in the chart of troubleshooting tips. If you review our chart of Troubleshooting Tips first, you may not need to call for service at all.



### CAUTION

- Contact an authorized service technician for repair or maintenance of this unit.
- Contact an authorized installer for installation of this unit.
- If the power cord needs to be replaced, replacement work shall be performed by authorized service personnel only.
- Installation work must be performed in accordance with the national and local electric codes and must be performed by authorized personnel only.

**NOTE:** All the illustrations in this manual are for explanation purposes only. Your air conditioner may be slightly different.

# Safety Precautions

To prevent injury to the user and property damage, the following instructions must be followed. Incorrect operation due to ignoring instructions may cause harm or damage. The seriousness is classified by the following indications.

<b>WARNING</b>	This symbol indicates the possibility of death or serious injury.
<b>CAUTION</b>	This symbol indicates the possibility of injury or damage to property.

■ Meanings of symbols used in this manual are as shown below.

	<b>Never do this.</b>
	<b>Always do this.</b>

**WARNING**

<div style="background-color: #cccccc; padding: 5px; border: 1px solid black; margin-bottom: 5px;"> <b>Plug in power cord plug properly</b> </div> <ul style="list-style-type: none"> <li>• Otherwise, it may cause electric shock or fire due to excess heat generation</li> </ul>	<div style="background-color: #cccccc; padding: 5px; border: 1px solid black; margin-bottom: 5px;"> <b>Do not open the unit during operation</b> </div> <ul style="list-style-type: none"> <li>• It may cause electric shock</li> </ul>	<div style="background-color: #cccccc; padding: 5px; border: 1px solid black; margin-bottom: 5px;"> <b>Always ensure effective grounding</b> </div> <ul style="list-style-type: none"> <li>• Incorrect grounding may cause electric shock</li> </ul>
<div style="background-color: #cccccc; padding: 5px; border: 1px solid black; margin-bottom: 5px;"> <b>Do not modify power cord length or share the outlet with other appliances.</b> </div> <ul style="list-style-type: none"> <li>• It may cause electric shock or fire due to heat generation</li> </ul>	<div style="background-color: #cccccc; padding: 5px; border: 1px solid black; margin-bottom: 5px;"> <b>Do not operate or stop the unit by inserting or pulling out the power plug</b> </div> <ul style="list-style-type: none"> <li>• It may cause electric shock or fire due to heat generation</li> </ul>	<div style="background-color: #cccccc; padding: 5px; border: 1px solid black; margin-bottom: 5px;"> <b>Unplug the unit if strange sounds, odors or smoke comes from it.</b> </div> <ul style="list-style-type: none"> <li>• It may cause fire and electric shock</li> </ul>
<div style="background-color: #cccccc; padding: 5px; border: 1px solid black; margin-bottom: 5px;"> <b>Do not operate with wet hands or in a damp environment</b> </div> <ul style="list-style-type: none"> <li>• It may cause electric shock</li> </ul>	<div style="background-color: #cccccc; padding: 5px; border: 1px solid black; margin-bottom: 5px;"> <b>Do not use the power cord close to heating appliances</b> </div> <ul style="list-style-type: none"> <li>• It may cause fire and electric shock</li> </ul>	<div style="background-color: #cccccc; padding: 5px; border: 1px solid black; margin-bottom: 5px;"> <b>Do not allow water to run in to electric parts</b> </div> <ul style="list-style-type: none"> <li>• It may cause failure of machine or electric shock</li> </ul>
<div style="background-color: #cccccc; padding: 5px; border: 1px solid black; margin-bottom: 5px;"> <b>Unplug the unit if strange sounds, odors or smoke comes from it.</b> </div> <ul style="list-style-type: none"> <li>• It may cause fire and electric shock</li> </ul>	<div style="background-color: #cccccc; padding: 5px; border: 1px solid black; margin-bottom: 5px;"> <b>Always install circuit breaker and a dedicated power circuit</b> </div> <ul style="list-style-type: none"> <li>• Incorrect installation may cause fire and electric shock</li> </ul>	<div style="background-color: #cccccc; padding: 5px; border: 1px solid black; margin-bottom: 5px;"> <b>Do not use the socket if it is loose or damaged</b> </div> <ul style="list-style-type: none"> <li>• It may cause fire and electric shock</li> </ul>
<div style="background-color: #cccccc; padding: 5px; border: 1px solid black; margin-bottom: 5px;"> <b>Do not use a damaged or unspecified power cord</b> </div> <ul style="list-style-type: none"> <li>• It may cause electric shock or fire</li> <li>• If the power cord is damaged, it must be replaced by the manufacturer or an authorized service center or a qualified person in order to avoid a hazard</li> </ul>	<div style="background-color: #cccccc; padding: 5px; border: 1px solid black; margin-bottom: 5px;"> <b>Do not use the power cord near flammable gas or combustibles, such as gasoline, benzene, thinner, etc.</b> </div> <ul style="list-style-type: none"> <li>• It may cause an explosion or fire</li> </ul>	
<div style="background-color: #cccccc; padding: 5px; border: 1px solid black; margin-bottom: 5px;"> <b>Do not disassemble or modify unit.</b> </div> <ul style="list-style-type: none"> <li>• It may cause failure and electric shock</li> </ul>		

**CAUTION**

**When the air filter is to be removed, do not touch the metal parts of the unit**

- It may cause an injury due to sharp edges of components.

**Do not allow water to enter inside the unit during cleaning**

- Water may enter the unit and degrade the insulation. It may cause an electric shock

**Ventilate the room well when used together with a gas stove or if there is a gas leak**

- An oxygen shortage may occur
- May cause explosion, fire and/or burns

**When the unit is to be cleaned, switch off, and turn off the circuit breaker**

- Do not clean unit when power is on as it may cause fire and electric shock

**Hold the plug by the head of the power plug when taking it out**

- It may cause electric shock and damage

**Turn off the main power switch when not using the unit for a long time**

- It may cause failure of product or fire

**Stop operation and close the window in storm or hurricane**

- Operation with windows opened may allow rain to enter inside and damage property

**Ensure that the installation bracket of the outdoor appliance is not damaged**

- If bracket is damaged, there is concern of damage due to falling of unit.

**Always insert the filters securely. Clean filter once every two weeks**

- Operation without filters may cause failure
- Operation with dirty/clogged filters may cause failure

**Do not place obstacles around air-inlets or inside of air-outlet**

- It may cause failure of appliance or accident

**Do not place heavy object on the power cord and ensure that the cord is not compressed**

- There is danger of fire or electric shock

**Do not drink water drained from air conditioner**

- It contains contaminants and could make you sick

**Do not use strong detergents such as wax or thinner; use a damp, soft cloth**

- Appearance may be deteriorated due to change of product color or scratching of its surface

**Use caution when unpacking and installing**

- Sharp edges could cause injury

**If water enters the unit, turn the unit off at the power outlet and switch off the circuit breaker. Isolate supply by taking power-plug out and contact a qualified service technician**

- Water may enter the unit and degrade the insulation. It may cause an electric shock

# IMPORTANT SAFETY INSTRUCTIONS

**NOTE:** The power supply cord with this air conditioner contains a current detection device designed to reduce the risk of fire. Please refer to the section "Operation of Current Device" for details. In the event that the power supply cord is damaged, it cannot be repaired-it must be replaced with a cord from the Product Manufacturer.

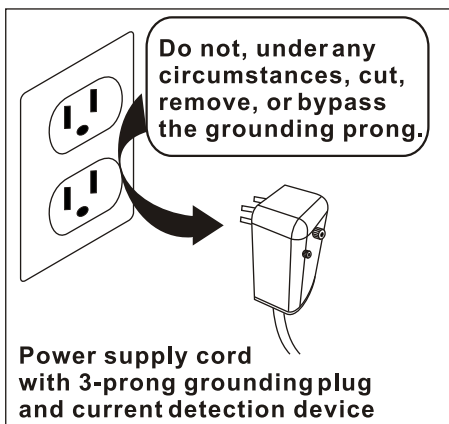

**▲ WARNING For your safety**

- Do not store or use gasoline or other flammable vapors and liquids in the vicinity of this or any other appliance.
- Avoid fire hazard or electric shock. Do not use an extension cord or an adaptor plug. Do not remove any prong from the power cord.

**▲ WARNING Electrical Information**

- Be sure the electrical service is adequate for the model you have chosen. This information can be found on the serial plate, which is located on the side of the cabinet and behind the grille.
- Be sure the air conditioner is properly grounded. To minimize shock and fire hazards, proper grounding is important. The power cord is equipped with a three-prong grounding plug for protection against shock hazards.
- Your air conditioner must be used in a properly grounded wall receptacle. If the wall receptacle you intend to use is not adequately grounded or protected by a time delay fuse or circuit breaker, have a qualified electrician install the proper receptacle.
- Ensure the receptacle is accessible after the unit installation.
- Do not run air conditioner without side protective cover in place. This could result in mechanical damage within the air conditioner.
- **Do not use an extension cord or an adapter plug.**

## Operation of Current Device

The power supply cord contains a current device that senses damage to the power cord. To test your power supply cord do the following:

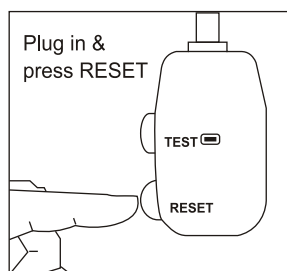

NOTE: Some plugs have buttons on the top.

1. Plug in the Air Conditioner.
2. The power supply cord will have TWO buttons on the plug head. Press the TEST button, you will notice a click as the RESET button pops out.
3. Press the RESET button, again you will notice a click as the button engages.
4. The power supply cord is now supplying electricity to the unit. (On some products this it also indicated by a light on the plug head.)

**NOTES:**

- Do not use this device to turn the unit on or off.
- Always make sure the RESET button is pushed in for correct operation.
- The power supply must be replaced if it fails reset when either the TEST button is pushed, or it cannot be reset. A new one can be obtained from the product manufacturer.
- If power supply cord is damaged, it cannot be repaired. It **MUST** be replaced by one obtained from the product manufacturer.

# NORMAL SOUNDS

**High Pitched Chatter**  
High efficiency compressors may have a high pitched chatter during the cooling cycle.

**Vibration**  
Unit may vibrate and make noise because of poor wall or window construction or incorrect installation.

**Pinging or Swishing**  
Droplets of water hitting condenser during normal operation may cause pinging or swishing sounds.

**Sound of Rushing Air**  
At the front of the unit, you may hear the sound of rushing air being moved by the fan

**Gurgle/Hiss**  
Gurgling or hissing noise may be heard due to refrigerant passing through evaporator during normal operation.

**NOTE:** This air conditioner is designed to be operated under condition as follows:

Cooling operation	Outdoor Temp:	64.4-109.4°F (18-43°C) (T <sub>1</sub> Environment)	69.8-125.6°F (21-52°C) (T <sub>3</sub> Environment)
	Indoor Temp:	62.6-89.6°F (17-32°C) (T <sub>1</sub> Environment)	62.6-89.6°F (17-32°C) (T <sub>3</sub> Environment)
Heat operation	Outdoor Temp:	23.0-75.2°F (-5-24°C) (T <sub>1</sub> Environment)	19.4-75.2°F (-7-24°C) (T <sub>3</sub> Environment)
	Indoor Temp:	32.0-80.6°F (0-27°C) (T <sub>1</sub> Environment)	32.0-86.0°F (0-30°C) (T <sub>3</sub> Environment)

Note: Performance may be reduced outside of these operating temperatures.

# AIR CONDITIONER FEATURES

## **ELECTRONIC CONTROL OPERATING INSTRUCTIONS**

Before you begin, thoroughly familiarize yourself with the control panel and remote as shown below and all its functions, then follow the symbol for the functions you desire. **The unit can be controlled by the unit control alone or with the remote.**

### UNIT CONTROL

(Electric Heating Models)

Remote signal receptor

**NOTE:** Clear Air and/or Follow Me features only apply to certain models. Your control panel may or may not have these features and display lights. Check the actual unit you purchased to determine if these options apply.

## AIR CONDITIONER FEATURES(CONTINUED)

**NOTE:** The following instructions represent the Unit Controls, the same instructions can be used for the Remote Control.

### TO TURN UNIT ON:

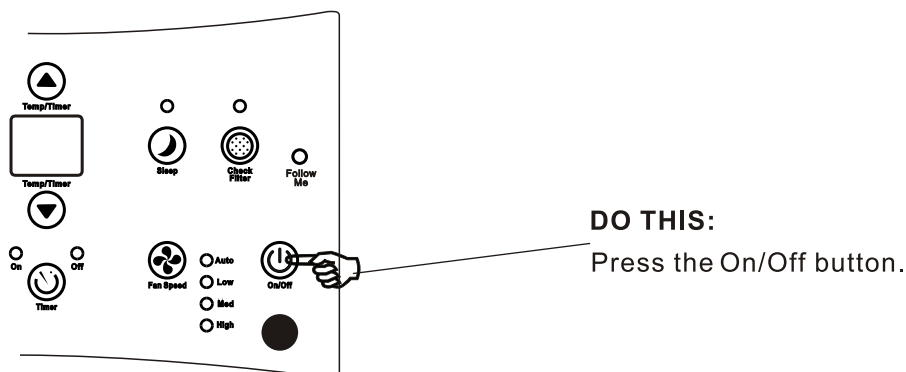

### TO CHANGE TEMPERATURE SETTING:

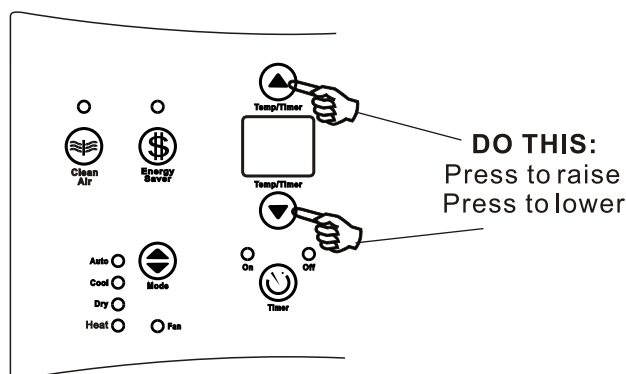

Press or hold either Temp/Timer Up (▲) or Down (▼) button until the desired temperature is seen on the display. This temperature will be automatically maintained anywhere between 62°F (17°C) and 86°F (30°C). If you want the display to read the actual room temperature, see to “Operate on Fan Only” section.

### TO ADJUST FAN SPEEDS:

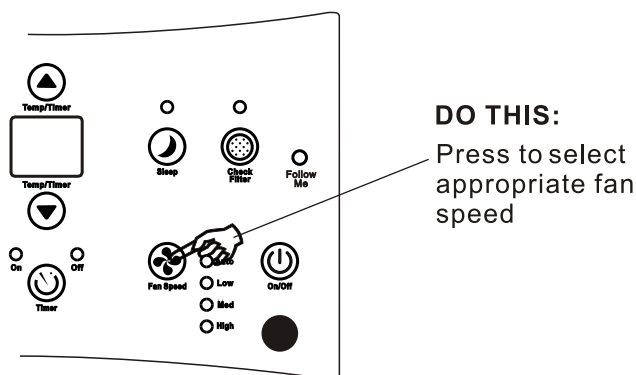

The fan speed button is used to select the Fan Speed in four steps: Auto, Low, Med or High. Each time the button is pressed, the fan speed mode is shifted. When the unit is operating in Dry mode, the fan speed is automatically controlled at Low fan speed.

## AIR CONDITIONER FEATURES(CONTINUED)

### TO SELECT THE OPERATING MODE:

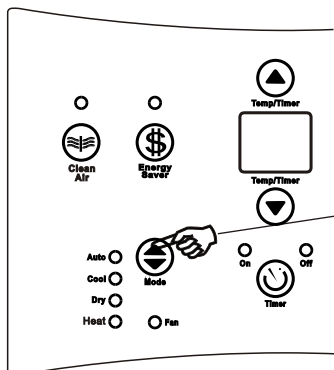

**DO THIS:**  
Press the Mode button.

#### NOTE:

- To choose operating mode, press the Mode button. Each time you press the button, a mode is selected in a sequence that goes from Auto, Cool, Dry, Heat and Fan. The indicator light beside the selected mode will illuminate and remain on once the mode is selected.

#### To operate in Auto feature:

- When you set the air conditioner to AUTO mode, it will automatically select cooling, heating or fan only depending on what temperature you have selected and the room temperature.
- The air conditioner will control room temperature automatically around the temperature set point selected.
- In this mode, the fan speed cannot be adjusted, it starts automatically at a speed according to the room temperature.

#### To operate in Fan only:

- Use this function when cooling is not desired, such as for room air circulation or to exhaust stale air (on some models). Remember to open the vent during this function, but keep it closed during cooling for maximum cooling efficiency. You can choose any fan speed you prefer.
- During this function, the display will show the actual room temperature, not the set temperature as in the cooling mode.
- In Fan only mode, the temperature is not adjusted.

#### To operate in Dry mode:

- In this mode, the air conditioner will generally operate in the form of a dehumidifier to remove humidity from the air. However, some degree of cooling will continue.

### TO USE THE ENERGY SAVER FEATURE:

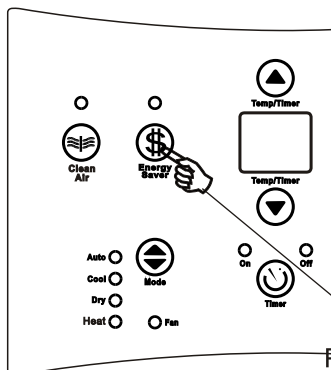

**DO THIS:**  
Press the button

This function is available on COOL mode. The fan will continue to run for 3 minutes after the compressor shuts off. The fan then cycles on for 2 minutes at 10 minute intervals until the room temperature is above the set temperature, at which time the compressor turns back on and Cooling Starts.



## AIR CONDITIONER FEATURES (CONTINUED)

### SLEEP FEATURE:

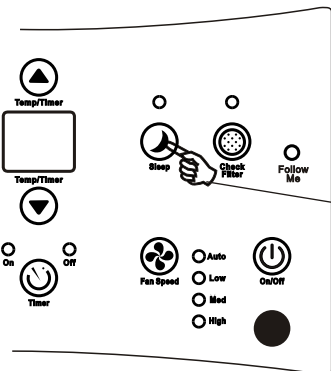

**DO THIS:**  
Press Sleep button

In this mode the selected temperature will increase (cooling) or decrease (heating) by 2°F/1(or 2)°C 30 minutes after the mode is selected. The temperature will then increase (cooling) or decrease (heating) by another 2°F/1(or 2)°C after an additional 30 minutes. This new temperature will be maintained for 6 hours before it returns to the originally selected temperature. This ends the Sleep mode and the unit will continue to operate as originally programmed. The Sleep mode program can be cancelled at any time during operation by again pressing the Sleep button.

### TIMER: AUTO START/STOP FEATURE

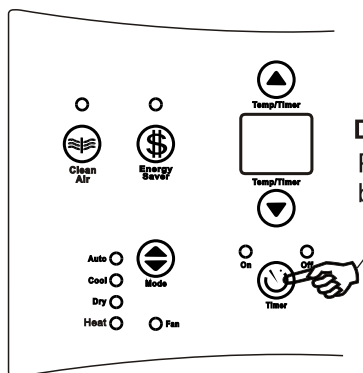

**DO THIS:**  
Press Timer button

- When the unit is on or off, first press the Timer button, the TIMER ON indicator light illuminates. It indicates the Auto Start program is initiated.
- When the time of TIMER ON is displayed, press the Timer button again, the TIMER OFF indicator light illuminates. It indicates the Auto Stop program is initiated.
- Press or hold the Temp/Timer UP or DOWN button to change the Auto time by 0.5 hour increments, up to 10 hours, then count down the time remaining until start.
- The selected time will register in 5 seconds, and the system will automatically revert back to display the previous temperature setting or room temperature when the unit is on. (when the unit is off, there is no display.)
- Turning the unit ON or OFF at any time or adjusting the timer setting to 0.0 will cancel the Auto Start/Stop timed program.

### CHECK FILTER FEATURE:

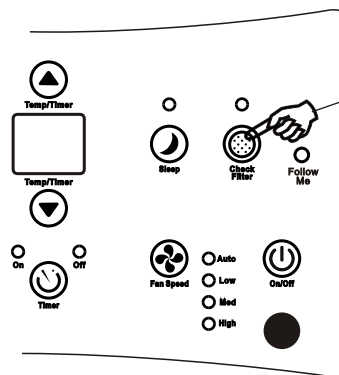

**DO THIS:**  
Press Check Filter button

This feature is a reminder to clean the Air Filter for more efficient operation. The LED (light) will illuminate after 250 hours of operation. To reset after cleaning the filter, press the Check Filter button and the light will go off.

## AIR CONDITIONER FEATURES (CONTINUED)

### DISPLAYS:

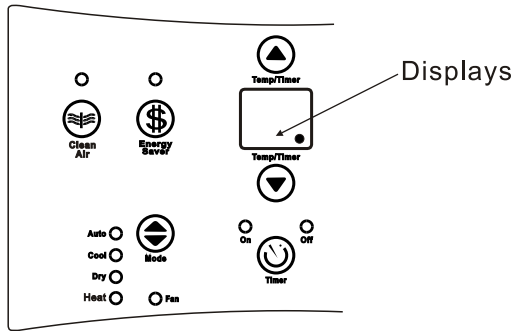

### THE DISPLAYS

\* The control is capable of displaying temperature in degree Fahrenheit or degrees Celsius. To convert from one to the other, press and hold the Left and Right Temp/Timer buttons at the same time, for 3 seconds.

Shows the set temperature in " °C" or " °F" and the Auto-timer settings. While on Fan only mode, it shows the room temperature.

#### Error codes:

**AS**-Room temperature sensor error-Unplug the unit and plug it back in. If error repeats, call for service.  
NOTE: In Fan only mode, it will display "LO" or "HI".

- -Evaporator temperature sensor error-Unplug the unit and plug it back in. If error repeats, call for service.  
NOTE: " • " is displayed as shown in the left picture.

### ADDITIONAL THINGS YOU SHOULD KNOW

Now that you have mastered the operating procedure, here are more features in your control that you should become familiar with.

- The Cool circuit has an automatic 3 minute time delayed start if the unit is turned off and on quickly. This prevents overheating of the compressor and possible circuit breaker tripping. The fan will continue to run during this time.

### Air Directional Louvers

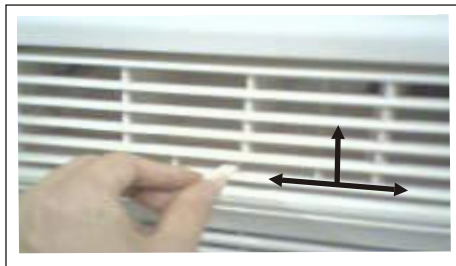

Air Direction(3- way)

The 3-way air directional louvers allow you to direct the air flow up and left or right throughout the room as needed. To adjust the air directional louvers side-to-side, use the center handles as you move it side-to-side.

# INSTALLATION INSTRUCTIONS



To avoid risk of personal injury, property damage, or product damage due to the weight of this device and sharp edges that may be exposed:

- Air conditioners covered in this manual pose an excessive weight hazard. Two or more people are needed to move and install the unit. To prevent injury or strain, use proper lifting and carrying techniques when moving unit.
- Carefully inspect the location where the air conditioner will be installed. Be sure it will support the weight of the unit.
- Handle air conditioner with care. Wear protective gloves whenever lifting or carrying the unit. AVOID the sharp metal fins of front and rear coils to prevent injury.
- Make sure the air conditioner does not fall and remains upright during installation.

### Tools and Parts:

Gather the required tools and parts before starting installation. Read and follow the instructions provided with any tools listed here.

TOOLS NEEDED	
<ul style="list-style-type: none"> <li>● Flat-blade and Phillips screwdrivers</li> </ul>	<ul style="list-style-type: none"> <li>● Tape measure</li> </ul>
<ul style="list-style-type: none"> <li>● Level</li> </ul>	<ul style="list-style-type: none"> <li>● Drill and 3/16", 1/8", 3/32", or smaller drill bit</li> </ul>

### Through-the-wall Installation:

In addition to the tools listed above, the following tools are needed for through-the-wall installation.

TOOLS NEEDED	
<ul style="list-style-type: none"> <li>● Saw</li> </ul>	<ul style="list-style-type: none"> <li>● Caulk</li> </ul>
<ul style="list-style-type: none"> <li>● 1" (2.5 cm) or thicker lumber</li> </ul>	<ul style="list-style-type: none"> <li>● #10 X 1" wood screws (7)</li> </ul>

### Parts Supplied:

Check that all parts are included in parts package:

Hardware	Qty.	Hardware	Qty.
 #10 X 1/2" pan - head Phillips screws	3	 Top channel	1
 #10 X 3/4" (or 1/2") Round - head Screws	7	 Window sash seal	1
 #10 X 1/4" pan - head Phillips screws	5	 Foam seal	1
 side curtains	2	 Window lock bracket	1
		 Safety Lock (for Vinyl-Clad window)	2
		 weather seals (6"X3/4"X1/12")	5
 Remote Control	1	 Remote Battery	2

# INSTALLATION INSTRUCTIONS

**NOTE**

- Installation parts are supplied for double-hung windows up to 36" (91.4 cm) wide.
- Do not use any screws other than those specified here.

**Location Requirements:**

**IMPORTANT:** Observe all governing codes and ordinances. Check the location where air conditioner will be installed. Proper installation is your responsibility. Make sure you have everything necessary for correct installation.

- Grounded electrical outlet within 4 ft (122 cm) of where the power cord exits the air conditioner.
- Free movement of air in room to be cooled. No obstacles blocking air inlets or outlets.
- A large enough opening for the air conditioner.
- Adequate wall support for weight of air conditioner.

**NOTE**

- Do not use an extension cord.
- Cabinet louvers must not be obstructed. Air must be able to pass freely through the cabinet louvers. (FIG.1)

**Window Installation:**

Window opening measurements (FIG.2):

- 26-7/8" to 36" (68.3 cm to 91.4 cm) opening width.
- 16-1/2" (41.9 cm) minimum opening height.

FIG.1

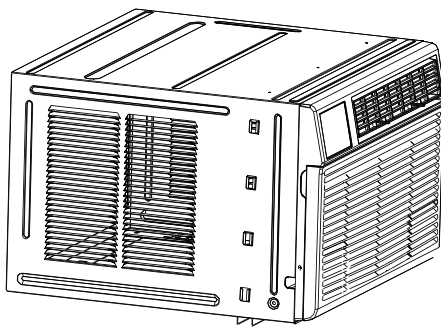

A. Cabinet louvers

FIG.2

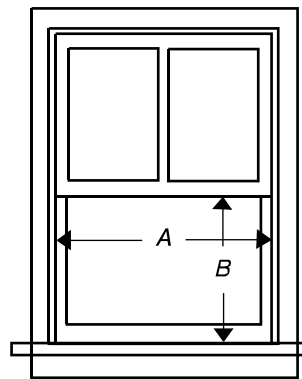

A. 26-7/8" (68.3 cm) minimum to 36" (91.4 cm) max.  
B. 16-1/2" (41.9 cm) minimum

**Remove packaging material:**

- Remove and dispose of / recycle packaging materials. Remove tape and glue residue from surfaces before installing the air conditioner. Rub a small amount of liquid dish soap over the adhesive with your fingers. Wipe with warm water and dry.
- Do not use sharp instruments, rubbing alcohol, flammable fluids, or abrasive cleaners to remove tape or glue. These products can damage the surface of your air conditioner.
- Handle the air conditioner gently.
  1. Remove the air conditioner from the carton and place it on cardboard.
  2. Loosen (1) shipping screw from each side of the cabinet (FIG. 3).
  3. Remove front panel by removing (1) Phillips screw from each side of the front panel. Set screws a side and save (FIG.4).
  4. Pull on the handles to slide the air conditioner out of the cabinet. Place the air conditioner on cardboard (FIG.5).

# INSTALLATION INSTRUCTIONS

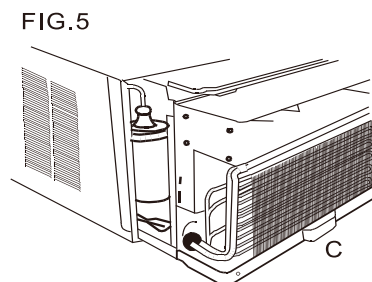
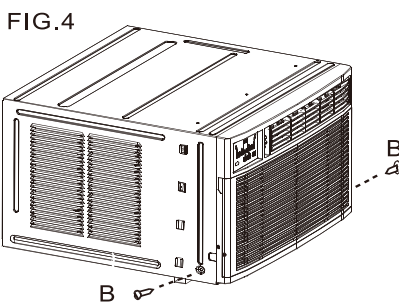
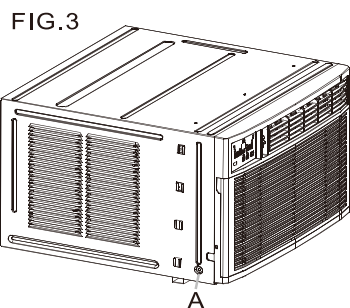

**NOTE**

- Handle the air conditioner gently.
- Be sure your air conditioner cabinet does not fall out of the opening during installation or removal.
- The place where the power cord exits the air conditioner should be no more than 4 ft (122 cm) from a grounded 3 prong outlet.
- Do not block the louvers on the front panel.
- Do not block the louvers on the outside of air conditioner.
- Do not lift, pull or remove any expanded polystyrene (foam) from inside of the air conditioner. It is not packing material

Attach Top Channel (FIG.6):

**NOTE**

Attach the top channel and side curtains to the air conditioner cabinet before placing the cabinet in the window.

1. Locate provided bag of screws.
2. Place the top channel on top of the air conditioner cabinet, lining up the three holes in the top channel with the three holes on top of the air conditioner cabinet.
3. Using three #10 X 1/4" pan-head Phillips thread cutting screws, attach the top channel to the air conditioner cabinet.

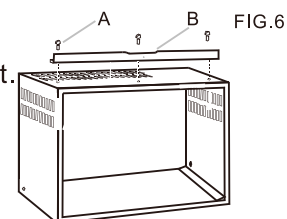

A. #10 X 1/4" pan-head Phillips thread cutting screws  
B. Top channel

Attach Side Curtains :

1. Insert the right-hand curtain connector tab into the curtain housing channels on the air conditioner (FIG.7A).
2. Insert the top and then the bottom of the right-hand curtain housing in the top and bottom curtain channels on their conditioner (FIG.7B, FIG.7C).
3. Slide the curtain housing into the curtain guides as far as it could go.
4. Repeat the above steps for the left-hand curtain.

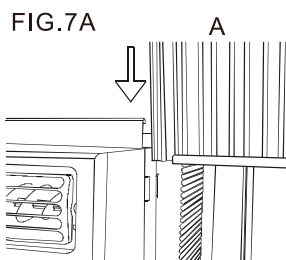

A. Side Curtain

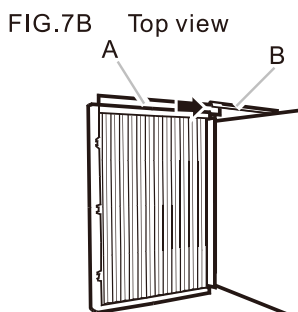

A. Curtain housing  
B. Curtain top channel on air conditioner

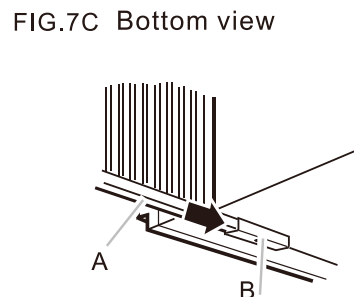

A. Curtain housing  
B. Curtain bottom channel on air conditioner

# INSTALLATION INSTRUCTIONS

## Attach foam adhesive seal:

Attach foam adhesive seal along the bottom of the curtain bottom channel (FIG.8).

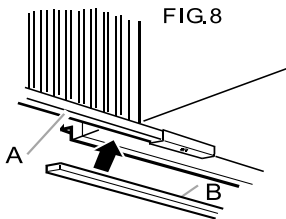

A. Curtain housing  
B. Foam adhesive seal

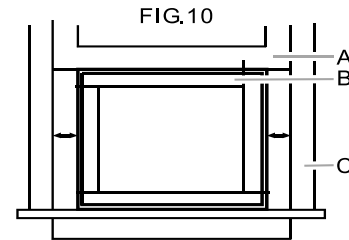
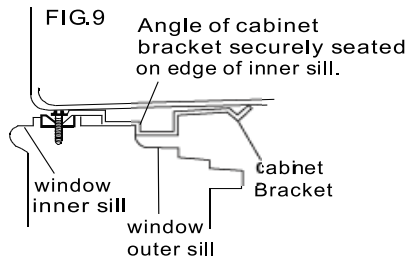

A. Window sash  
B. Empty cabinet  
C. Window channel

## Install Cabinet into Window:

1. Center empty cabinet in window:

Check that lower rail of air conditioner cabinet is behind and against back side of window sill. Maintain a firm hold on the air conditioner cabinet (FIG.9). Lower window sash to hold the cabinet in place. Measure the distance between the right side of the cabinet and the inside of the window channel (FIG.10). Repeat for the left side. Adjust the cabinet until the distance on each side is the same.

2. Attach the cabinet to window:

*A: For wooden window:*

Use a 3/16" drill bit to drill three starter holes 3/8" deep through the three holes in the cabinet and into the window sill, and drill one starter hole 3/8" deep through the hole in the middle of top rail and into the window frame (FIG.11). Attach cabinet to window with three #10 x 1/2" pan-head Phillips screws and one #10 X 3/4" or (1/2") round-head screw (FIG.11).

*B: For Vinyl-Clad window:*

Use a 1/8" drill bit to drill one hole through the hole in the middle of top rail and into the window frame. Attach cabinet to window with one #10 x 3/4" or (1/2") round-head Phillips screw (FIG.11). Place two safety locks into the holes that located in the bottom of the cabinet and drive two locking screws through the safety locks into the cabinet as shown (FIG.12)

3. Check that air conditioner cabinet is tilted back 5/16" to 3/8" so that water could run to the outside (See FIG.13).

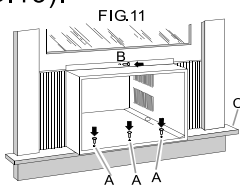

A. #10 X 1/2" pan-head Phillips screws  
B. #10 X 3/4" (or 1/2") round-head screw  
C. Window channel

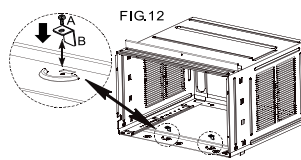

A. #10 X 1/4" Pan-head Phillips screws  
B. Safety Lock  
Only for Vinly-Clad Window

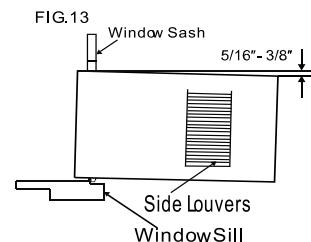

## Attach Side Curtains to Window Frame:

1. Extend the side curtains out against the window frame (FIG.11).

2. Drill holes and drive locking screws:

*A: For wooden windows:*

Use a 3/32" drill bit to drill 4 starter holes through the holes in the side curtains into the window. Drive four #10 X 3/4" or (1/2") Lockingscrews through the holes in the side curtains into the window sill and window frame (FIG.14A, FIG.14B).

*B: For Vinyl-Clad windows:*

Use a 1/8" drill bit to drill two holes through the holes in the side curtains into the window frame as shown (FIG.14A). Drive two #10 X 3/4" or (1/2") locking screws through the holes in the side curtains into the window sash (FIG.14A)

3. Trim the weather seal (6" X 3/4" X 1/12") with a proper length, peel off the protective backing and plug any gaps if needed as shown (FIG.14B).

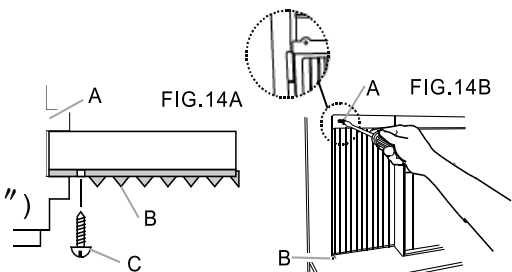

A. Window channel  
B. Left-hand curtain  
C. #10 X 3/4" (or 1/2") round-head screw

A. #10 X 3/4" (or 1/2") round-head screw  
B. Slotted hole in the bottom of the curtain

# INSTALLATION INSTRUCTIONS

## Complete Installation:

1. Insert window sash seal behind the top of the lower window sash and against the glass of the upper window (FIG.15).
2. Place the window-lock bracket on top of lower window and against upper window sash on right side of the window (FIG.15).
3. Use a 3/32" drill bit to drill starter holes through the holes in the bracket into the window sash (FIG.15).
4. Attach the window lock-bracket to the window sash with two #10 X 3/4" or (1/2") round-head screws to secure window in place (FIG.15).
5. Insert air conditioner into cabinet (FIG.16).
6. Insert front tabs of front panel into top of cabinet and swing front into place.
7. Attach bottom front of panel with front panel screws (FIG.17).
8. Plug into a grounded 3 prong outlet.
9. Press RESET on the power supply cord.

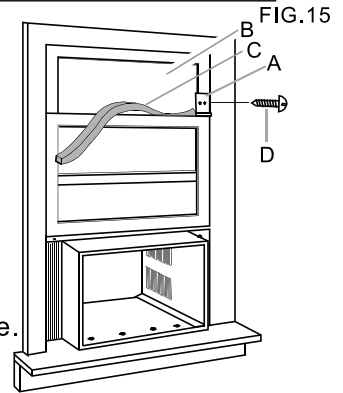

A. Window lock bracket  
 B. Upper window glass  
 C. Window sash seal  
 D. #10X3/4" or (1/2") round-head screws

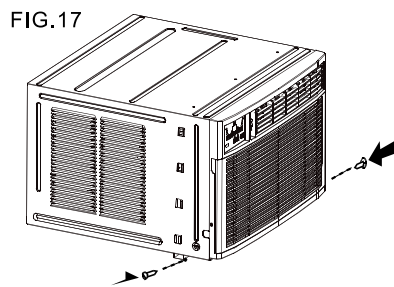
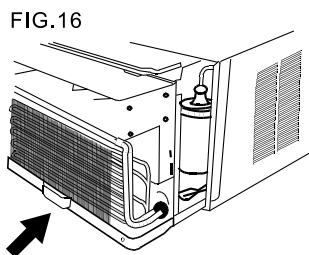

**\* NOTE:** Do not block the louvers on the air conditioner cabinet or your unit will not perform properly.

## Through-the-Wall Cabinet Installation:

### Option 1 — wood, metal or plastic molding:

When using a wood, metal or plastic molding, the wood frame should line up with the inside wall as shown FIG.18

### Option 2—Plastered wall with no molding:

If the plastered wall is to be flush with the cabinet and no molding is used, the wood frame must be set 1/2" (13mm) into the inside wall FIG.19.

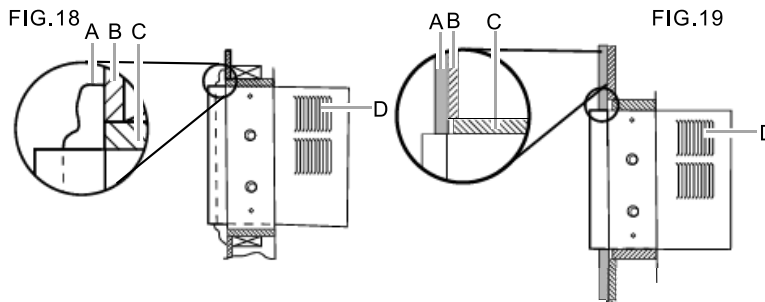

A. Molding    C. Wood frame    A. Plastered wall    C. Wood frame  
 B. Inside wall    D. Louvers    B. Inside wall    D. Louvers

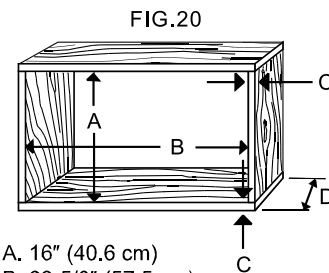

A. 16" (40.6 cm)  
 B. 22-5/8" (57.5 cm)  
 C. Wood thickness  
 D. 2-1/2" (6.4 cm) minimum to 6-1/2" (16.5 cm) maximum

## Install Wood Frame:

1. Construct the wood frame. See FIG.20 for dimensions.
2. Measure the outside width and height of frame to determine wall opening dimensions. The wall opening measurements should be :
  - Width : 22-5/8" (57.5 cm) plus twice thickness of wood used to build frame.
  - Height: 16" (40.6 cm) plus twice thickness of wood used to build frame.
  - Depth : 2-1/2" (6.4 cm) minimum to 6-1/2" (16.5 cm) maximum. **\* SEE NOTE ABOVE**
3. Cut the opening through the wall. Remove and save insulation.
4. Apply the wood preservative to the outside exposed surface.
5. Insert the frame in the wall opening. Square and level frame.
6. Attach frame securely to the wall.

**\* SEE NOTE ABOVE**

# INSTALLATION INSTRUCTIONS

**NOTE**

- Dimension for depth depends on wall thickness and type of molding (FIG.21).
- Do not block louvers in air conditioner cabinet.  
Use 1" (2.5 cm) or thicker lumber for wood frame.
- It is recommended to use 1" (2.5 cm) or thicker lumber for wood frame.

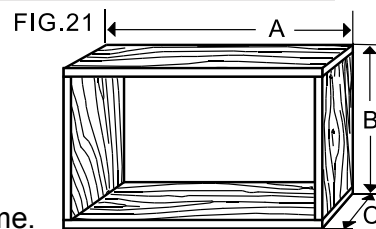

A. Outside width  
B. Outside height  
C. Depth\*

### Install Cabinet into Wood Frame:

1. Insert cabinet into the framed wall opening. The top of the cabinet should extend  $3/4''$  (19.1 mm) into the room. If there is trim, the cabinet should extend  $3/4''$  (19.1 mm) past trim (FIG.22).
2. Use a level to check that cabinet is level side to side (FIG.23).
3. Check that air conditioner cabinet is tilted to the outside so that water could run to the outside. The cabinet should slop at least half-a-bubble towards the rear.
4. Reuse the insulation to seal opening between cabinet and frame.
5. Use existing holes in sides and top of cabinet and seven #10 X 1" wood screws (not provided) to attach cabinet to frame.
6. Caulk all outside wall openings around cabinet.

**NOTE**

- Do not overtighten screws or the cabinet will distort and provide a poor air seal between cabinet and air conditioner.

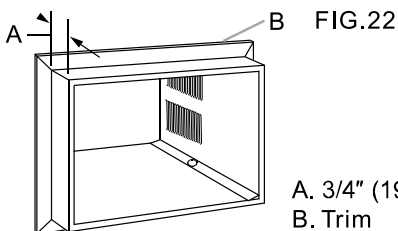

A.  $3/4''$  (19.1 mm) extending into room  
B. Trim

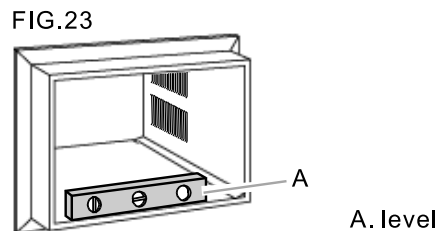

A. level

### Complete Installation:

1. Insert air conditioner into cabinet (FIG.24).
2. Insert front tabs of front panel into top of cabinet and swing front into place.
3. Attach bottom front of panel with front panel screws (FIG.25).
4. Plug into a grounded 3 prong outlet.
5. Press RESET on the power supply cord.

**NOTE**

- Handle the air conditioner gently .  
For through-the-wall installations, if needed, install molding (not provided) around the room side of cabinet.

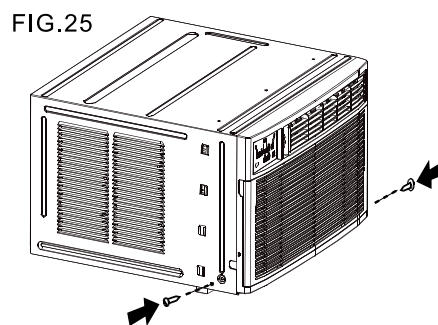
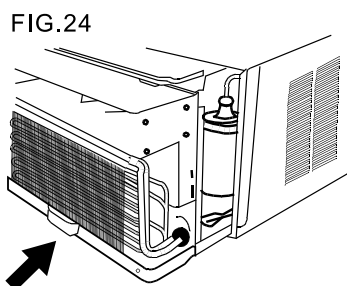



## CARE AND CLEANING

### CAUTION

Clean your air conditioner occasionally to keep it looking new. **Be sure to unplug the unit before cleaning to prevent shock or fire hazards.**

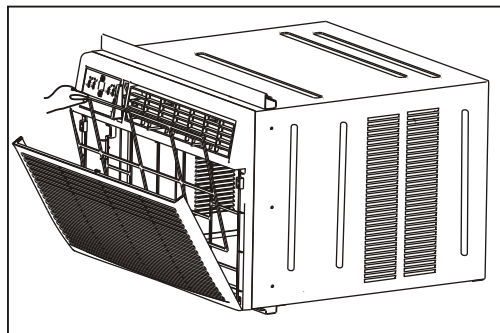

### Air Filter Cleaning

The air filter should be checked at least once a month to see if cleaning is necessary. Trapped particles in the filter can build up and cause an accumulation of frost on the cooling coils.

- Push the vent handle to the Vent Closed position (where applicable).
- Open the front panel.
- Grasp the filter, pull up and out.
- Wash the filter using liquid dishwashing detergent and warm water. Rinse filter thoroughly.
- Gently shake excess water from the filter. Be sure the filter is thoroughly dry before replacing.
- Or, instead of washing you may vacuum the filter clean.

**Note:** Never use hot water over 104°F (40°C) to clean the air filter. Never attempt to operate the unit without the air filter.

### Cabinet Cleaning

- Be sure to unplug the air conditioner to prevent shock or fire hazard. The cabinet and front may be dusted with an oil-free cloth or washed with a cloth dampened in a solution of warm water and mild liquid dishwashing detergent. Rinse thoroughly and wipe dry.
- Never use harsh cleaners, wax or polish on the cabinet front.
- Be sure to wring excess water from the cloth before wiping around the controls. Excess water in or around the controls may cause damage to the air conditioner.
- Plug in air conditioner.

### Winter Storage

If you plan to store the air conditioner during the winter, remove it carefully from the window according to the installation instructions. Cover it with plastic or return it to the original carton.

# TROUBLESHOOTING TIPS

Before calling for service, review this list. It may save you time and unnecessary expense. This list includes common occurrences that are not the result of defective workman-ship or materials in this appliance.

Problem	Solution
<b>Air conditioner does not start</b>	<p>Wall plug disconnected. Push plug firmly into wall outlet.</p> <p>Blown fuse or circuit breaker has tripped. Replace fuse with time delay type or reset circuit breaker.</p> <p>Current device has tripped on plug. Press the RESET button.</p> <p>Unit control is OFF. Turn control ON and set to desired setting.</p>
<b>Air from unit does not feel cold enough</b>	<p>Cooling may not occur until room temperature rises above 62°F (17°C), as unit will not work below room air temperature of 62°F (17°C)</p> <p>Temperature sensing element may be touching the coil, located behind air filter. Straighten sensing tube away from coil.</p> <p>Reset to a lower temperature set point on unit control.</p> <p>When mode button is pressed, the compressor may shut off. Wait approximately 3 minutes for compressor to turn on after time delay when in cool mode.</p>
<b>Air conditioner cooling, but room is too warm- ice forming on cooling coil behind decorative front.</b>	<p>Outdoor temp. may be below 62°F (17°C). To defrost coil, set unit to FAN ONLY mode.</p> <p>Air filter may be dirty, clean filter. Refer to Care and Cleaning section. To defrost, set unit to FAN ONLY mode.</p> <p>Thermostat set too cold for cooling. To defrost the coil, set unit to FAN ONLY mode. Then, set temperature to a higher setting.</p>
<b>Air conditioner cooling, but room is too warm- NO ice forming on cooling coil behind decorative front.</b>	<p>Dirty air filter- air restricted. Clean air filter. Refer to Care and Cleaning section.</p> <p>Temperature is set too High, set temperature to a Lower setting.</p> <p>Louvers positioned improperly. Position louvers for better air distribution. Ensure louvers are not closed.</p> <p>Front of units may be blocked by drapes, blinds, furniture, etc., restricting air distribution. Clear blockage in front of unit.</p> <p>Doors, windows, registers, etc., are open allowing air to escape. Close those open areas.</p> <p>Unit recently turned on in hot room. Allow additional time to remove "Stored heat" from walls, ceiling, floor and furniture.</p>
<b>Air conditioner turns on and off rapidly</b>	<p>Dirty air filter/air restricted. Clean air filter and remove any obstacles blocking air flow.</p> <p>Outside temperature extremely hot. Set FAN speed to a Higher setting to move air past cooling coils faster.</p>
<b>Noise when unit is cooling</b>	<p>Air movement sound. This is normal . If too loud, set to a slower FAN setting.</p> <p>Window vibration - poor installation. Refer to installation instructions or check with installer.</p>
<b>Water dripping INSIDE when unit is cooling.</b>	<p>Improper installation. Tilt air conditioner slightly to the the rear/outside to allow water drainage. Refer to installation instructions - check with installer.</p>
<b>Water dripping OUTSIDE when unit is cooling.</b>	<p>Unit removing large quantity of moisture from humid room. This is normal during excessively humid days.</p>
<b>Remote Sensing Deactivating Prematurely (some models)</b>	<p>Remote control not located within range. Place remote control within 20 feet &amp; 180°, radius of the front of the unit.</p> <p>Remote control signal obstructed. Remove obstruction.</p>
<b>Room too cold</b>	<p>Set temperature too low. Increase set temperature.</p>

## LIMITED EXPRESS WARRANTY

Congratulations on purchasing your new HVAC equipment. It's been designed for long life and reliable service, and is backed by one of the strongest warranties in the industry. Your unit automatically qualifies for the warranty coverage listed below, providing you keep your proof of purchase (receipt) for the equipment and meet the warranty conditions.

### LIMITED ONE (1) YEAR EXPRESS WARRANTY

Comfort-Aire warrants this Room Air Conditioner to be free from defects in workmanship and materials for normal use and maintenance for one (1) year from the date of purchase by the original consumer. This Express Limited Warranty applies only when the Room Air Conditioner is installed and operated per Comfort-Aire installation and operating instructions for normal use.

### EXCEPTIONS

The Limited Express Warranty does not cover normal maintenance. Comfort-Aire recommends that regular inspection/maintenance be performed at least once a season. Additionally, labor charges, diagnostic charges, transportation charges for replacement of refrigerant or filters, and any other service calls/repairs are not covered by this Limited Warranty. It also does not cover any portion or component of the system that is not supplied by Comfort-Aire, regardless of the cause of failure of such portion or component.

### CONDITIONS FOR WARRANTY COVERAGE

Unit must be operated according to Comfort-Aire operating instructions included with the unit and cannot have been subjected to accident, alteration, improper repair, neglect or misuse, or an act of God (such as a flood)

- Serial numbers and/or rating plate have not been altered or removed
- Performance cannot be impaired by use of any product not authorized by Comfort-Aire, or by any adjustments or adaptations to components
- Damage has not been a result of inadequate wiring or voltage conditions, use during brown-out conditions, or circuit interruptions
- Air flow around any section of the unit has not been restricted
- Unit remains in the original installation

### DURATION OF WARRANTY & REGISTRATION

The warranty begins on the date of purchase by the original consumer. The consumer must retain a receipted bill of sale as proof of warranty period. Without this proof, the express warranty begins on the date of shipment from the factory.

### REMEDY PROVIDED BY THE LIMITED EXPRESS WARRANTY

The sole remedy under the Limited Warranty is replacement of the defective unit. Labor to diagnose and replace the defective unit is not covered by this Limited Express Warranty. If for any reason the replacement product is no longer available during the warranty period, Comfort-Aire shall have the right to allow a credit in the amount of the current suggested retail price of the product instead of providing replacement.

### LIMITATION OF LIABILITY

1. There are no other express or implied warranties. Comfort-Aire makes no warranty of merchantability. We do not warrant that the unit is suitable for any particular purpose or can be used in buildings or rooms of any particular size or condition except as specifically provided in this document. There are no other warranties, express or implied, which extend beyond the description in this document.
2. All warranties implied by law are limited in duration to the one-term of the warranty. **We will not be liable for any consequential or incidental damages caused by any defect in this unit.**
3. This warranty gives you specific legal rights and you may also have other rights which vary from state to state. Some states do not allow limitation on how long an implied warranty lasts or do not allow the exclusion or limitation of incidental or consequential damages, so the above limitations or exclusions may not apply to you.
4. No warranties are made for units sold outside the continental United States and Canada. Your distributor or final seller may provide a warranty on units sold outside these areas.
5. Comfort-Aire will not be liable for damages if our performance regarding warranty resolution is delayed by events beyond our control including accident, alteration, abuse, war, government restrictions, strikes, fire, flood, or other acts of God.

### HOW TO SUBMIT A WARRANTY CLAIM

If you have a warranty claim, notify you installer or dealer promptly.



Please visit  
[www.marsdelivers.com](http://www.marsdelivers.com)  
to register your new product

### KEEP THIS INFORMATION AS A RECORD OF YOUR PURCHASE

#### PRODUCT IDENTIFICATION

Model Number

Serial Number

Date of Purchase

#### INSTALLATION

Installer Name (if used)

Phone Number/Contact Information

Date Installation Completed

Remember to retain your bill of sale as proof of warranty period.

---

Due to ongoing product improvements, specifications and dimensions are subject to change and correction without notice or incurring obligations. Determining the application and suitability for use of any product is the responsibility of the installer. Additionally, the installer is responsible for verifying dimensional data on the actual product prior to beginning any installation preparations.

Incentive and rebate programs have precise requirements as to product performance and certification. All products meet applicable regulations in effect on date of manufacture; however, certifications are not necessarily granted for the life of a product. Therefore, it is the responsibility of the applicant to determine whether a specific model qualifies for these incentive/rebate programs.

*Comfort-Cire*<sup>®</sup>

1900 Wellworth Ave., Jackson MI 49203 • Ph. 517-787-2100 • [www.marsdelivers.com](http://www.marsdelivers.com)

