



DV42H5400\*  
DV42H5200\*  
DV42H5000\*

# Gas and Electric Dryer

## User manual

### Imagine the possibilities

Thank you for purchasing this Samsung product.  
To receive more complete service or accessory parts,  
please register your product at or contact:

[www.samsung.com/register](http://www.samsung.com/register)  
1-800-SAMSUNG (726-7864)



## ■ Contents

### Safety instructions 4

What you need to know about safety instructions .....	4
Important safety symbols and precautions .....	4
Important safety instructions .....	6

### Installing your dryer 8

Unpacking your dryer .....	8
What's included .....	8
Accessories .....	8
Important to installer .....	9
Basic requirements .....	9
Grounding .....	9
Gas models .....	9
Electric models .....	9
Location considerations .....	10
Alcove or closet installations .....	10
Ducting requirements .....	12
Exhausting .....	13
Dryer exhaust tips .....	14
Gas requirements .....	15
Commonwealth of Massachusetts installation instructions .....	15
Electrical requirements .....	16
Electrical connections .....	16
Connecting the inlet hose .....	18
Replacement parts and accessories .....	19
Installation .....	19
Door reversal .....	20
Final installation checklist .....	21

### Operating instructions, tips 22

Overview of the control panel .....	22
Load the dryer properly .....	26
Getting started .....	26
Rack dry (DV42HS400* Only) .....	28
Child Lock .....	29
Drum Light .....	29

Sound Off .....	29
My Cycle .....	30
Smart Care .....	30

## Care and cleaning 31

Control panel .....	31
Tumbler .....	31
Stainless steel tumbler .....	31
Dryer exterior .....	31
Dryer exhaust system .....	31
Clean the lint filter .....	31

## Special laundry tips 32

Special laundry tips .....	32
----------------------------	----

## Troubleshooting 33

Check these points if your dryer .....	33
Information codes .....	34

## Appendix 35

Fabric care chart .....	35
Protecting the environment .....	36
Declaration of conformity .....	36
Specifications .....	36

## ■ Safety instructions



Congratulations on your new Samsung Dryer. This manual contains important information on the installation, use, and care of your appliance. Please take the time to read this manual to take full advantage of your dryer's many benefits and features.

### What you need to know about safety instructions

Please read this manual thoroughly to ensure that you know how to operate the extensive features and functions of your new appliance safely and efficiently. Retain the manual in a safe place near the appliance for future reference. Use this appliance only for its intended purpose as described in this instruction manual. The Warnings and Important Safety Instructions in this manual do not cover all possible conditions and situations that may occur. It is your responsibility to use common sense, caution, and care when installing, maintaining, or operating your dryer.

Always contact your manufacturer about problems or conditions you do not understand.

### ■ Important safety symbols and precautions

	<b>WARNING:</b> Hazards or unsafe practices that may result in <b>severe physical injury, death and/or property damage</b> . Follow the information in this manual to minimize the risk of fire or explosion or to prevent property damage, personal injury, or death.
	<b>CAUTION:</b> Hazards or unsafe practices that may result in <b>physical injury and/or property damage</b> .
	<b>NOTE</b>

These warning signs are here to prevent injury to you and others.

Please follow them explicitly.

After reading this section, keep it in a safe place for future reference.

**SAVE THESE INSTRUCTIONS**

English - 4

## **⚠ WARNING - RISK OF FIRE**

- Clothes dryer installation must be performed by a qualified installer.
- Install the clothes dryer according to the manufacturer's instructions and local codes.
- Do not install a clothes dryer with flexible plastic venting materials. If flexible metal (foil type) duct is installed, it must be of a specific type identified by the appliance manufacturer as suitable for use with clothes dryers. Flexible venting materials are known to collapse, be easily crushed, and trap lint. These conditions will obstruct clothes dryer airflow and increase the risk of fire.
- To reduce the risk of severe injury or death, follow all installation instructions.

### **⚠ TO REDUCE THE RISK OF FIRE OR EXPLOSION:**

- Do not dry items that have been previously cleaned, washed, soaked, or spotted with gasoline, dry cleaning solvents, or other flammable or explosive substances. They emit vapors that could ignite or explode. Any material that has been in contact with a cleaning solvent or flammable liquids or solids should not be placed in the dryer until all traces of these flammable liquids or solids and their fumes have been removed. There are many highly flammable items used in homes, such as acetone, denatured alcohol, gasoline, kerosene, some liquid household cleaners, some spot removers, turpentine, waxes, and wax removers.
- Do not dry items containing foam rubber (may be labeled latex foam) or similarly textured rubber-like materials on a heat setting. Heated foam rubber materials can, under certain circumstances, produce fire by spontaneous combustion.

### **⚠ WHAT TO DO IF YOU SMELL GAS:**

- Do not try to light any appliance.
- Do not turn on the appliance.
- Do not touch any electrical switch.
- Do not use any phone in your building.
- Clear the room, building or area of all occupants.
- Immediately call your gas supplier from a neighbor's phone. Follow the gas supplier's instructions.
- If you cannot reach your gas supplier, call the fire department.
- Installation and service must be performed by a qualified installer, service agency, or the gas supplier.

**SAVE THESE INSTRUCTIONS**

English - 5

## Important safety instructions

### WARNING

To reduce the risk of fire, electric shock, or injury to persons when using your appliance, follow basic precautions, including the following:

1. Read all instructions before using this appliance.
2. Do not use the dryer to dry clothes which have traces of any flammable substance, such as vegetable oil, cooking oil, machine oil, flammable chemicals, thinner, etc., or anything containing wax or chemicals, such as mops and cleaning cloths. Flammable substances may cause the fabric to catch fire by itself.
3. Do not store or use gasoline or other flammable vapors and liquids near this or any other appliance.
4. Do not allow children or pets to play on, in, or in front of the appliance. Close supervision is necessary when the appliance is used near children and pets.
5. Before the appliance is removed from service or discarded, remove the door to the drying compartment to prevent children or animals from becoming trapped inside.
6. Do not reach into the appliance when the drum is moving.
7. Do not install or store this appliance where it will be exposed to the weather.
8. Do not temper with the internal controls.
9. Do not repair or replace any part of the appliance or attempt any servicing unless specifically recommended in the user-maintenance instructions or published in the user-repair instructions that you understand and have the skills to carry out.
10. Do not use fabric softeners or products to eliminate static unless recommended by the manufacturer of the fabric softener or product.
11. Clean the lint screen before or after each load.
12. Do not use heat to dry articles containing foam rubber or similarly textured rubber-like materials.
13. Keep the area around the exhaust opening and surrounding areas free from lint, dust, and dirt.
14. The interior of the dryer and exhaust duct should be cleaned periodically by qualified service personnel.
15. Do not place items exposed to cooking oils in your dryer. Items contaminated with cooking oils may contribute to a chemical reaction that could cause a load to catch fire.
16. This appliance must be grounded. See "Electrical requirements" and "Grounding" in the "Installing your dryer" section.
17. This appliance must be properly grounded. Never plug the power cord into a receptacle that is not grounded adequately and in accordance with local and national codes. Refer to installation instructions for grounding this appliance.
18. Ensure pockets are free from small irregularly shaped hard objects and foreign material, i.e. coins, knives, pins, etc. These objects could damage your dryer.
19. Gas leaks may occur in your system, resulting in a dangerous situation.
20. Gas leaks may not be detected by smell alone.
21. Gas suppliers recommend you purchase and install a UL-approved gas detector.

## SAVE THESE INSTRUCTIONS

English - 6





## **⚠ WARNING**

### **|| Gas Appliances:**

**WARNING:** This product contains chemicals known to the State of California to cause cancer and reproductive toxicity.

Gas appliances can cause low-level exposure to Proposition 65 listed substances, including but not limited to, benzene, carbon monoxide, formaldehyde and soot, substances resulting from the incomplete combustion of natural gas or LP fuels.

## **⚠ CAUTION**

1. Do not sit on top of the dryer.
  2. Because of continuing product improvements, Samsung reserves the right to change specifications without notice. For complete details, see the Installation Instructions packed with your product before selecting cabinetry, making cutouts, or beginning installation.
  3. Do not wash clothing with large buckles, buttons, or other heavy metal or solid things.
  4. Install and use in accordance with the manufacturer's instructions.
  5. All washed and unwashed fabrics that contain vegetable oil or cooking oil can be dangerous. Washing these items in hot water with extra detergent will reduce, but not eliminate, the hazard. Always use the Cool Down cycle for these items to reduce their temperature. Never remove these items from the dryer hot or interrupt the drying cycle until the items have run through the Cool Down cycle. Never pile or stack these items when they are hot.
  6. Take care that children's fingers are not caught in the door when closing it. This may result in injury.
- 
- 

**SAVE THESE INSTRUCTIONS**

English - 7

## ■ Installing your dryer

### Unpacking your dryer

Unpack your Dryer and inspect it for shipping damage. Make sure you have received all the items shown below. If your Dryer was damaged during shipping, or you do not have all the items, contact 1-800-SAMSUNG (726-7864).

#### ⚠ WARNING

- The packing materials can be dangerous to children. Keep all packaging material (plastic bags, polystyrene, etc.) well out of the reach of children.
- To prevent personal injury or strain, wear protective gloves whenever lifting or carrying the unit.

### What's included

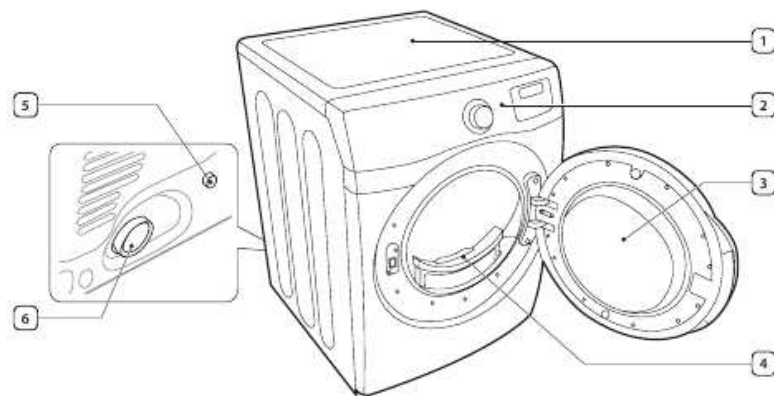

1	Top cover	4	Filter
2	Control panel	5	Water Inlet (Steam model only)
3	Door	6	Duct Exhaust

### ■ Accessories (Steam model only)



\*Y\*-connector



Short inlet hose



Long inlet hose



Rubber Washer



## Important to installer

Please read the following instructions carefully before installing the dryer. These instructions should be kept for future reference.

**⚠ WARNING:** Remove the door from all discarded appliances to avoid the danger of a child being trapped and suffocating.

## Basic requirements

Make sure you have everything necessary for the proper installation.

- A GROUNDED ELECTRICAL OUTLET is required.
- A POWER CORD electric dryer (except for Canada).
- GAS LINES (if a gas dryer) must meet national and local codes.
- The EXHAUST SYSTEM must be made of rigid metal or flexible stiff-walled metal exhaust ducting.

## Grounding

This dryer must be grounded. In the event of a malfunction or breakdown, grounding the product will reduce the risk of electrical shock by providing a path of least resistance for the electrical current.

### Gas models

Your dryer has a cord with an equipment-grounding conductor and a grounding plug.

- The plug must be plugged into an appropriate outlet that is properly installed and grounded in accordance with all local codes and ordinances.
- Do not modify the plug provided with your dryer – if it doesn't fit the outlet, have a proper outlet installed by a qualified electrician.
- Never connect the ground wire to the plastic plumbing lines, gas lines, or hot water pipes.

### Electric models

Your dryer has an optional cord with an equipment-grounding conductor and a grounding plug, which is sold separately.

- The plug must be plugged into an appropriate outlet that is properly installed and grounded in accordance with all local codes and ordinances.
- Do not modify the plug provided with your dryer – if it doesn't fit the outlet, have a proper outlet installed by a qualified electrician.
- If a power cord is not used and the electric dryer is to be permanently wired, the dryer must be connected to a permanently grounded metal wiring system, or an equipment grounding conductor must be run with the circuit conductors and connected to the equipment grounding terminal or lead on the dryer.



## Location considerations

The dryer should be located where there is enough space at the front for loading the dryer, and enough space behind for the exhaust system. This dryer is factory-ready for the rear-exhaust option. To exhaust out the bottom, right or the left, use the accessory exhaust kit. Instructions are included with the kit. Make sure the room in which the dryer is located has enough fresh air. The dryer must be located where there are no air-flow obstructions.

For gas dryers, adequate clearance must be maintained as noted on the data plate to ensure adequate air for combustion and the proper dryer operation.

The dryer must not be installed or stored in an area where it will be exposed to water and/or weather. The dryer area must be kept clear of combustible materials, gasoline, and other flammable vapors and liquids. A dryer produces combustible lint. The area around the dryer should be kept lint-free.

## Alcove or closet installations

### ⚠ WARNING

- The dryer must be exhausted to the outside to reduce the risk of fire when installed in an alcove or closet.
- No other fuel-burning appliance should be installed in the same closet as the dryer.

#### Minimum clearances between the dryer and adjacent walls or other surfaces:

Sides	1 in (25 mm)	Rear	5.9 in (150 mm)
Top	17 in (432 mm)	Closet front	2 in (51 mm)

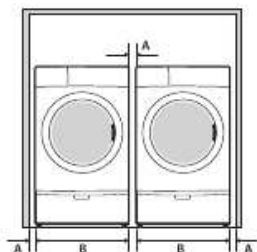

Recessed area

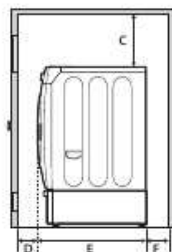

Side view  
(closet or confined area)

<b>A</b>	1 in. (25 mm)
<b>B</b>	27 in. (686 mm)
<b>C</b>	17 in. (432 mm)
<b>D</b>	2 in. (50 mm)
<b>E</b>	32.4 in. (823 mm)
<b>F</b>	5 in. (127 mm)

## Installation with pedestal

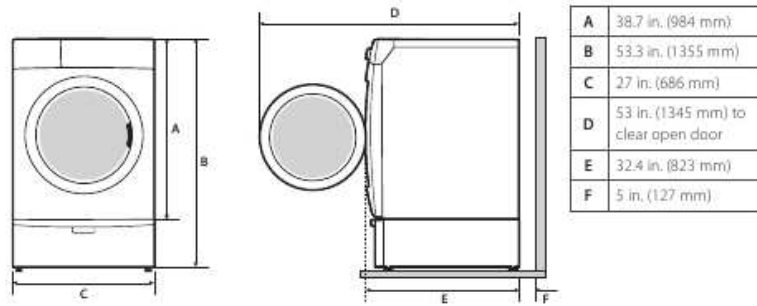

## Installation with stacked washing machine and dryer

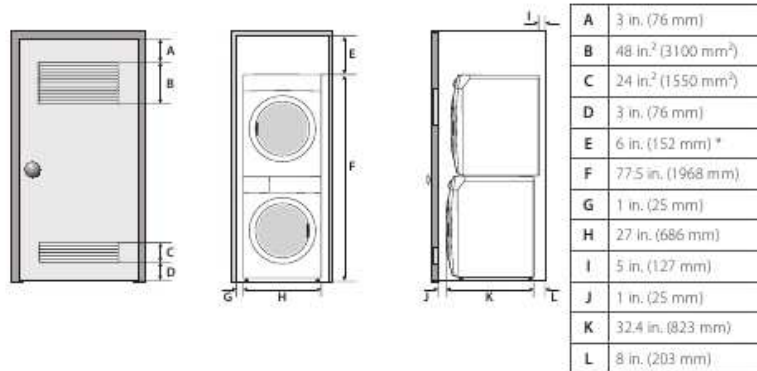

 The front of the closet must have two unobstructed air openings (**B, C**) for a combined minimum total area of 72 in<sup>2</sup> (465 cm<sup>2</sup>) with a minimum clearance of 3 in. (7.6 cm) at the top (**A**) and bottom (**D**). External exhaust elbow requires additional space (**L**).

 **Stacking (MODEL NO: SK-5A)**  
Samsung's Washer and Dryer can be stacked to maximize usable space.  
The dryer legs need to be removed to stack the Washer and Dryer. You can purchase an optional stacking kit from your Samsung retailer.

02 INSTALLATION

## Ducting requirements

No. of 90° elbows	Weather hood type			
	4" (10.16 cm)		2.5" (6.35 cm)	
	 Recommended		 Use only for short-run installation	
	Rigid	Metallic Flexible*	Rigid	Metallic Flexible*
0	24.4 m (80 ft.)	12.4 m (41 ft.)	22.6 m (74 ft.)	10.1 m (33 ft.)
1	20.7 m (68 ft.)	11.2 m (37 ft.)	18.9 m (62 ft.)	8.8 m (29 ft.)
2	17.4 m (57 ft.)	10.1 m (33 ft.)	15.5 m (51 ft.)	7.6 m (25 ft.)
3	14.3 m (47 ft.)	9.0 m (29 ft.)	12.5 m (41 ft.)	6.5 m (21 ft.)

 \* Do not use non-metallic flexible ducts.

- Use a 4 inch (10.2 cm) diameter rigid aluminum or rigid galvanized steel duct.
- Do not use a smaller duct.
- Ducts larger than 4 inches (10.2 cm) in diameter can result in increased accumulation of lint.
- Lint should be removed regularly.
- If a flexible metal duct must be used, use the type with a stiff sheet metal wall. Do not use a flexible duct with a thin foil wall. A serious blockage can result if the flexible metal duct is bent too sharply.
- Never install any type of flexible duct in walls, ceilings, or other concealed spaces.
- Keep the exhaust duct as straight and short as possible.
- Secure joints with duct tape. Do not use screws.
- Plastic flexible ducts can kink, sag, be punctured, reduce airflow, extend drying times, and affect the dryer operation.
- Exhaust systems longer than recommended can extend drying times, affect machine operations, and collect lint.
- The exhaust duct should end with an exhaust hood with a swing-out damper to prevent back drafts and entry of wildlife. Never use an exhaust hood with a magnetic damper.
- The hood should have at least 12 inches (30.5 cm) of clearance between the bottom of the hood and the ground or other obstruction. The hood opening should point down.
- Never install a screen over the exhaust outlet.
- To avoid lint buildup, do not exhaust the dryer directly into a window well. Do not exhaust under a house or porch.
- If the exhaust duct must run through an unheated area, the duct should be insulated and slope slightly down towards the exhaust hood to reduce condensation and lint buildup.
- Inspect and clean the interior of the exhaust system at least once a year. Unplug the power cord before cleaning.
- Check frequently to make sure the exhaust hood damper opens and closes freely.
- Check once per month, and clean at least once per year. Note: If your clothes are not getting dry, then check the duct for obstructions.
- Do not exhaust the dryer into a wall, ceiling, crawl space, or concealed space of a building, gas vent, or any other common duct or chimney. This could create a fire hazard from the lint expelled by the dryer.

If the new dryer is installed into an existing exhaust system you must make sure:

- The exhaust system meets all local, state, and national codes.
- That a flexible plastic duct is not used.
- To inspect and clean all lint buildup from inside the existing duct.
- The duct is not dented or crushed.
- The exhaust hood damper opens and closes freely.
- The static pressure in any exhaust system must not exceed 0.83 inches of water column, or be less than 0.
- This can be measured with the dryer running with a manometer at the point where the exhaust duct connects to the dryer. A no-heat setting should be used. The dryer tumbler should be empty and the lint filter clean.

## Exhausting

The dryer shall not be exhausted into a chimney, a wall, a ceiling, an attic, a crawl space, or a concealed space of a building.

Exhausting the dryer to the outside will prevent large amounts of lint and moisture from being blown into the room.



- All dryers must be exhausted to the outside.
- Do not assemble the duct with screws or other fastening means that extend into the duct and catch lint.
- The exhaust duct should be 4 inches (102 mm) in diameter.
- The total length of flexible metal duct shall not exceed 2.4 m (7.8 ft).

### In the United States:

Use only those foil-type flexible ducts, if any, specifically identified for use with the appliance by the manufacturer and that comply with the Outline for Clothes Dryer Transition Ducts, Subject 2158A.

### In Canada:

Use only those foil-type flexible ducts, if any, specifically identified for use with the appliance by the manufacturer.

### Outside the U.S. and Canada:

Refer to the local codes.



#### WARNING

- The dryer must be exhausted to the outside to reduce the risk of fire when installed in an alcove or closet.
- NEVER USE A PLASTIC OR NON-METAL FLEXIBLE DUCT.  
If your existing ductwork is plastic, non-metal, or combustible, replace it with metal.  
Use only a metal exhaust duct that is non-flammable to ensure containment of the exhaust air, heat, and lint.

## Dryer exhaust tips

**WARNING:** A plastic or non-metal flexible duct presents a potential fire hazard.

- Make sure your dryer is installed properly so it exhausts air easily.
- Use a 4" diameter rigid metal duct. Tape all joints, including at the dryer. Never use lint-trapping screws.
- Keep ducts as straight as possible.
- Clean all old ducts before installing your new dryer.
- Be sure the vent flap opens and closes freely.
- Inspect and clean the exhaust system annually.

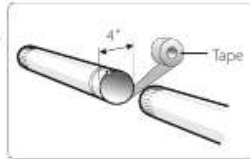

### Don't let a poor exhaust system slow the drying process by:

- Restricting your dryer with a poor exhaust system.

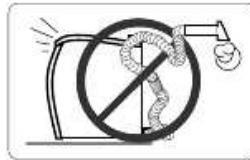

- Using a plastic, thin foil, or non-metal flexible duct.



- Unnecessarily using long ducts that have many elbows.

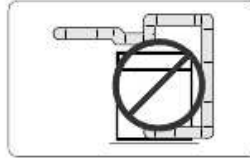

- Allowing dented or clogged ducts and vent.



## Gas requirements

**THE INSTALLATION MUST CONFORM WITH LOCAL CODES, OR IN THE ABSENCE OF LOCAL CODES, WITH THE NATIONAL FUEL GAS CODE ANSI/Z223.1, LATEST REVISION (FOR THE UNITED STATES), OR WITH THE CAN/CGA-B149 INSTALLATION CODES (FOR CANADA).**

- Use only natural or LP (liquid propane) gases.
- This dryer designed for use with natural gas. If you plan to use your dryer with LP gas (liquid propane), the conversion must be done by a qualified service technician in order to achieve safe and proper performance.
- A 1/2 inch (1.27 cm) gas supply line is recommended and must be reduced to connect to the 3/8 inch (1 cm) gas line on your dryer. The National Fuel Gas Code requires that an accessible, approved manual gas shut-off valve be installed within 6 inches of your dryer.
- **Gas dryers installed in residential garages must be raised 18 inches (46 cm) above the floor.**
- Additionally, a 1/8 inch (0.3 cm) N.P.T. (National Pipe Thread) plugged tapping, accessible for test gauge connection, must be installed immediately upstream of your dryer's gas supply connection.
- Your dryer must be disconnected from the gas supply pipe system during any pressure testing of the system.
- **DO NOT** reuse old flexible metal gas lines. Flexible gas lines must be design certified by the American Gas Association (CGA in Canada).
  - Any pipe joint compound used must be resistant to the action of any liquefied petroleum gas.
  - As a courtesy, most local gas utilities will inspect a gas appliance installation.
- **GAS IGNITION** - Your dryer uses an automatic ignition system to ignite the burner. There is no constant burning pilot.

## Commonwealth of Massachusetts installation instructions

Your dryer must be installed by a licensed plumber or gas fitter. A 1/2" handle manual gas valve must be installed in the gas supply line to your dryer. If a flexible gas connector is used to install your dryer, the connector may not be longer than 3 feet (36 inches).

### **WARNING**

- Gas leaks may occur in your system, creating a dangerous situation.
- Gas leaks may not be detected by smell alone.
- Gas suppliers recommend that you purchase and install a UL-approved gas detector.
- Install and use it in accordance with the manufacturer's instructions.



## Electrical requirements

The wiring diagram is located on the plate below the control panel.

### WARNING

- The improper connection of the equipment grounding conductor can result in a risk of electric shock. Check with a qualified electrician or serviceman if you are in doubt as to whether your dryer is properly grounded. Do not modify the plug provided with your dryer - if it doesn't fit the outlet, have a proper outlet installed by a qualified electrician.
- To prevent unnecessary risk of fire, electrical shock, or personal injury, all wiring and grounding must be done in accordance with local codes, or in the absence of local codes, with the National Electrical Code, ANSI/NFPA No. 70-Latest Revision (for the U.S.) or the Canadian Electrical Code CSA C22.1 - Latest Revisions and local codes and ordinances. It is your responsibility to provide adequate electrical services for your dryer.
- All gas installations must be done in accordance with the national Fuel Code ANSI/Z2231 - Latest Revision (for the U.S.) or CAN/CGA - B149 Installation Codes - Latest Revision (for Canada) and local codes and ordinances.

## Electrical connections

Before operating or testing, follow all grounding instructions in the **Grounding** section on page 13.

An individual branch (or separate) circuit serving only your dryer is recommended. DO NOT USE AN EXTENSION CORD.

### Gas models – U.S. and Canada

A 120 volt, 60 Hz AC approved electrical service, with a 15-ampere fuse or circuit breaker is required.

### Electric models – U.S. only

Most U.S. dryers require a 120/240 volt, 60 Hz AC approved electrical service. Some require 120/208 volt, 60 Hz approved electrical service. The electric service requirements can be found on the data label located behind the door. A 30-ampere fuse or circuit breaker on both sides of the line is required.

If a power cord is used, the cord should be plugged into a 30-ampere receptacle.

The power cord is NOT provided with U.S. electric model dryers.

### WARNING - RISK OF ELECTRIC SHOCK

When local codes allow, the electrical supply of the dryer may be connected by means of a new power supply cord kit, marked for use with a dryer, that is U.L. listed and rated at a minimum of 120/240 volts, 30-ampere with three No. 10 copper wire conductors terminated with closed loop terminals, open-end spade lugs with turned up ends, or with tinned leads.

- Do not reuse a power supply cord from an old dryer. The power cord electric supply wiring must be retained at the dryer cabinet with a suitable UL-listed strain relief.
- Grounding through the neutral conductor is prohibited for (1) new branch-circuit installations, (2) mobile homes, (3) recreational vehicles, and (4) areas where local codes prohibit grounding through the neutral conductor. (Use a 4-prong plug for 4 wire receptacles, NEMA type 14-30R.)

### Electric models – Canada Only

- A 120/240 volt, 60 Hz AC approved electrical service fused through a 30-ampere fuse or circuit breaker on both sides of the line is required.
- All Canadian models are shipped with the power cord attached. The power cord should be plugged into a 30-ampere receptacle.

 In Canada, you may not convert a dryer to 208 volts.



### 3-WIRE system connections

1. Loosen or remove the center terminal block screw.
2. Connect the neutral wire (white or center wire) of the power cord to the center, silver-colored terminal screw of the terminal block. Tighten the screw.
3. Connect the other wires to the outer terminal block screws. Tighten the screws.
4. Tighten the strain relief screws.
5. Insert the tab of the terminal block cover into your dryer's rear panel slot.
6. Secure the cover with a hold-down screw.

A	External ground connector
B	Neutral grounding wire (green/yellow)
C	Center silver-colored terminal block screw
D	Neutral wire (white or center wire)
E	3/4 in. (1.9 cm) UL-listed strain relief

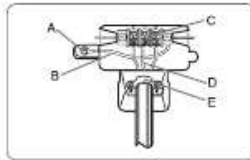

**⚠** If converting from a 4-wire electrical system to a 3-wire, the ground strap must be reconnected to the terminal block support to ground the dryer frame to the neutral conductor.

### 4-WIRE system connections

1. Remove the center terminal block screw.
2. Connect the ground wire (green or unwrapped) of the power cord to the external ground conductor screw.
3. Connect the neutral wire (white or center wire) of the power cord and the appliance ground wire (green with yellow stripes) under the central screw of the terminal block.
4. Connect the other wires to the outer terminal block screws. Tighten the screws.
5. Tighten the strain relief screws.
6. Insert the tab of the terminal block cover into your dryer's rear panel slot.
7. Secure the cover with a hold-down screw.

A	External ground connector
B	Green or bare copper wire of the power cord
C	3/4 in. (1.9 cm) UL-listed strain relief
D	Center silver-colored terminal block screw
E	Grounding wire (green/yellow)
F	Neutral wire (white or center wire)

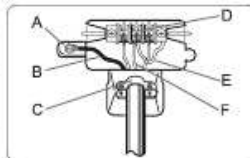

8. With a level, check your dryer and make the necessary adjustments to the leveling legs.
9. At this time, make sure all gas connections (on gas models), exhaust and electrical connections are complete. Plug in your dryer, and check its operation by using the checklist below.
10. (GAS MODELS ONLY)  
The burner may not ignite initially due to air in the gas line. Allowing your dryer to operate on a heat setting will purge the line. If the gas does not ignite within 5 minutes, turn your dryer off and wait 5 minutes. Be sure the gas supply to your dryer has been turned on. In order to confirm the gas ignition, check the exhaust for heat.

02 INSTALLATION

## Connecting the inlet hose (Steam model only)

The dryer must be connected to the cold water faucet using the new inlet hoses. Do not use old hoses.

1. Turn the cold water faucet off.
2. Attach the brass female end of the **Y connector (A)** to the cold water faucet.
3. Attach the straight end of **long hose (B)** to the Y connector.
4. Using pliers, tighten the coupling with an additional two-thirds turn.

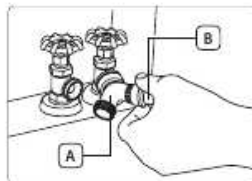

-  If the Y connector cannot be attached directly to the cold water faucet, the short hose must be used.  
**If space permits, please skip steps 5 to 8, and go directly to step 9.)**

5. Attach the **short inlet hose (C)** to the cold water faucet. Screw on the coupling by hand until it is seated on the faucet.
6. Using the pliers, tighten the coupling with an additional two-thirds turn.
7. Attach the **Y connector (A)** to the brass male end of the small hose. Screw on the coupling by hand until it is seated on the connector.
8. Using the pliers, tighten the coupling with an additional two-thirds turn.

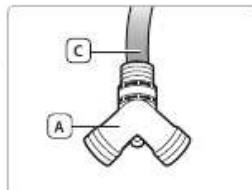

9. Attach the angled end of long hoses to the fill valve at the bottom of the dryer rear frame. Screw on the coupling by hand until it is seated on the fill valve connector.
10. Using pliers, tighten the coupling with an additional two-thirds turn.

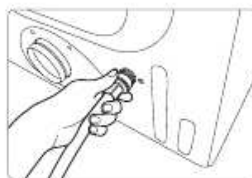

11. Attach the **washer hose (D)** to the other side of the **Y connector (A)**. Screw on the hose coupling until it is tight. Using pliers, tighten the coupling with an additional two thirds turn.
12. Check that the water faucets are on.
13. Check for leaks around the Y connector, faucets and hoses.

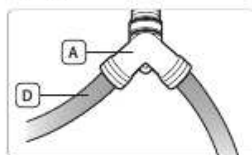

 When you tighten the coupling with pliers, do not overtighten. This may damage the coupling.

## Replacement parts and accessories

If your dryer requires replacement parts or accessories, contact the dealer where you purchased your dryer or the SAMSUNG customer care center at 1-800-SAMSUNG (726-7864).

## Installation

For the proper installation, we recommend that you hire a qualified installer.

1. Move your dryer to an appropriate location for the installation. Consider installing the dryer and washer side-by-side, to allow access to the gas, electrical, and exhaust connections. Place two of the carton cushion-tops on the floor. Tip your dryer on its side so it lies across both cushion-tops.
2. Set your dryer back in an upright position.
3. To ensure that the dryer provides the optimal drying performance, it must be level. To minimize vibrations, noise, and unwanted movement, the floor must be a perfectly level, solid surface. To set the dryer to the same height as the washer, fully retract the **leveling feet (A)** by turning them counterclockwise, then loosen the legs by turning them clockwise.

 Adjust the leveling feet only as much as necessary to level the dryer. Extending the leveling feet more than necessary can cause the dryer to vibrate.



4. Review the **"Exhausting"** section on page 13 before installing the exhaust system. Install the ductwork from your dryer to the exhaust hood. The crimped end of the duct sections must point away from your dryer.
  - DO NOT use sheet metal screws when assembling the ducting. These joints should be taped.
  - Never use plastic flexible exhaust material.
  - Tip for tight installations: install a section of the exhaust system onto your dryer before putting it in place.
  - Use duct tape to secure this section to your dryer, but do not cover the ventilation slots at the back of the unit in dryer cabinet.
5. Review the **"Electrical requirements"** section on page 16. BEFORE OPERATING OR TESTING, follow the grounding instructions in the **"Grounding"** section on page 9.

 **WARNING - U.S. MODELS**  
**RISK OF ELECTRIC SHOCK** - All U.S. models are produced for a **3-WIRE SYSTEM CONNECTION**.

The dryer frame is grounded to the neutral conductor at the terminal block.

A **4-WIRE SYSTEM CONNECTION** is required for new or remodeled construction, mobile homes, or if local codes do not permit grounding through the neutral conductor. If the 4-wire system is used, the dryer frame cannot be grounded to the neutral conductor at the terminal block.

Refer to the following instructions for **"Electrical connections"** on page 16.

Remove the terminal block cover plate.

Insert the power cord with a UL-listed strain relief through the hole provided in the cabinet near the terminal block.

 A strain relief must be used.

Do not loosen the nuts already installed on the terminal block. Be sure they are tight.

Use a 3/8 in. (1 cm) deep well socket.

6. Review the **"Gas requirements"** section on page 15.

Remove the pipe thread protective cap. Apply a pipe joint compound or about 1½ wraps of Teflon tape over all threaded connections.

 The pipe joint compound must be resistant to the actions of any liquefied petroleum gas.

Connect the gas supply to your dryer. An additional fitting is required to connect the 3/4" (1.9 cm) female thread end of a flexible connector to the 3/8" (1 cm) male threaded end on the dryer.

Securely tighten the gas line fitting over the threads.

Turn on the gas supply.

Check all gas connections for leaks using a soap solution.

If bubbles appear, tighten the connections and recheck. **DO NOT** use an open flame to check for gas leaks.

## Door reversal

1. Unplug the power cord.
2. Remove two door hinge screws.
3. Lift the door and remove it.

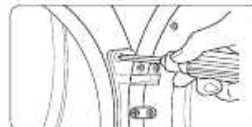

4. Remove two screws from the frame front.



5. Remove the two screws from the opposite side of the door hinge.

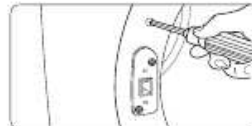

6. Remove the two screws from the holder lever.



7. Reassemble the two screws on the inside holes.



8. Remove a screw from the door hinge.



The screw is for pre-fixing the door to the frame front.

9. Reassemble the screw in the other hole.

10. Place the door on the other side and reattach it to the dryer.

11. Reattach the holder lever.

12. Reattach the screws in the remaining holes.

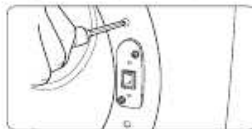
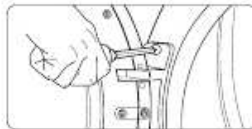
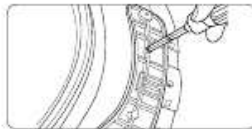
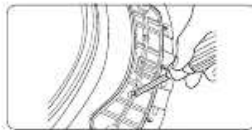

## Final installation checklist

- The dryer is plugged into an electrical outlet and is properly grounded.
- The exhaust ductwork is hooked up and the joints are taped.
- A plastic flexible duct is NOT used.
- Use rigid or stiff-walled flexible metal vent material.
- The dryer is level and is sitting firmly on the floor.
- Gas models – the gas is turned on with no gas leaks.
- Start your dryer to confirm that it runs, heats, and shuts off.

## ■ Operating instructions, tips

**▲** To reduce the risk of fire, electric shock, or injury to persons, read the **IMPORTANT SAFETY INSTRUCTIONS** before operating this appliance.

### Overview of the control panel

 The courses and functions differ depending on the model.  
Please check your model before proceeding.

#### DV52H5400\*

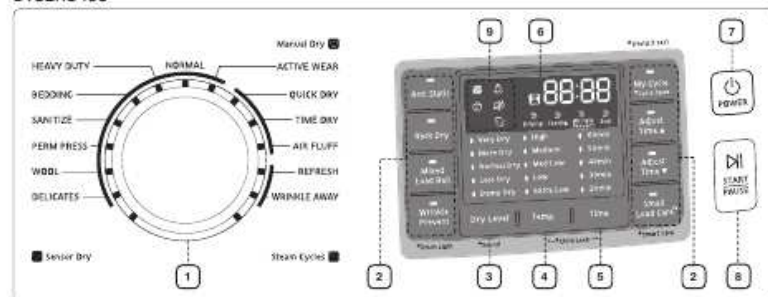

#### DV42H5200\*

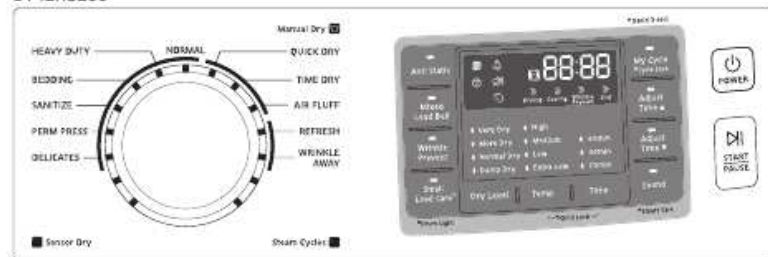

#### DV42H5000\*

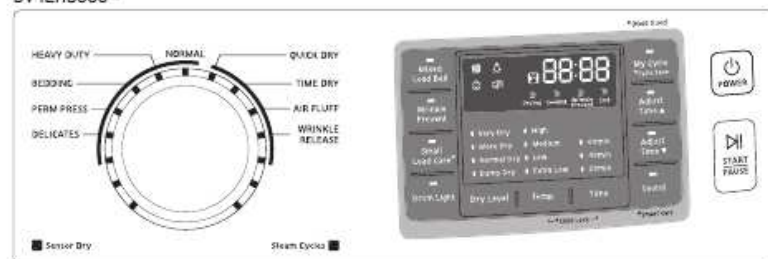

### 1. Cycle selector

To select a cycle, rotate the Cycle selector dial to the desired cycle.

The indicator light by the cycle name will illuminate. The ECO NORMAL, NORMAL, HEAVY DUTY, BEDDING, SANITIZE, PERM PRESS, WOOL and DELICATES cycles are Sensor Dry cycles.

Sensor Dry automatically senses the moisture in the load and shuts the dryer off when the selected dryness level (Very Dry to Damp Dry) is reached.

CYCLE	RECOMMENDED ITEMS	DETAILS
<b>NORMAL</b>	Cottons, Work clothes, Linen, Mixed loads	Use this cycle to dry loads such as cotton, underwear, and linen.
<b>HEAVY DUTY</b>	Heavy fabrics such as jean, Corduroys, Heavy work clothes	Use this cycle to get high heat for heavy fabrics such as jeans, corduroys, or work clothes.
<b>BEDDING</b>	Bulky items such as blankets, Sheets, Comforters, Pillows	For bulky items such as blankets, sheets, and comforters.
<b>SANITIZE</b>	Bedding, Curtains, Children's clothing	Sanitize garments by infusing high temperature heat deep into the fabric during the drying cycle. Use this course to keep your bedding and curtains clean through sanitization.
<b>PERM PRESS</b>	Shirts, Synthetic fabrics, Knits, Wrinkle-free cottons, Permanent	Dry wrinkle-free cottons, synthetic fabrics, knits, and permanent press fabrics automatically.
<b>WOOL</b>	For machine washable and tumble dryable wool only (Maximum amount : 3lb)	For machine washable and tumble dryable wool only.
<b>DELICATES</b>	Underwear, Blouses, Lingerie	The DELICATES cycle is designed to dry heat-sensitive items at a low drying temperature.
<b>ACTIVE WEAR</b>	Water-repellent wear, performance clothes, Sports wear (Maximum amount : 4lb)	The ACTIVE WEAR cycle is for exercise wear and outdoor wear such as sports jerseys, training pants, water-repellent jackets and other performance clothing. Thick fabrics like a zipper or velcro closure of a jacket, or training socks may not be completely dried.
<b>QUICK DRY</b>	Small loads	Provides a 30 minutes drying cycle.
<b>TIME DRY</b>	Any load	The TIME DRY allows you to select a cycle time in minutes. Turn the Cycle Selector dial to TIME DRY, then press the Adjust Time up arrow to set the drying time. Press the arrow repeatedly to scroll through the time settings.
<b>AIR FLUFF</b>	Foam, Rubber, Plastic	The AIR FLUFF cycle tumbles the load in room temperature air.
<b>WRINKLE RELEASE</b>	Shirts, Trouser, Blouses	The WRINKLE RELEASE cycle will release wrinkles from items that are clean, dry, and only slightly wrinkled, such as clothes from a crowded closet, suitcase or items that have been in the dryer too long after the cycle has ended. Wrinkle Release can be used with any temperature selection.

CYCLE	RECOMMENDED ITEMS	DETAILS
<b>REFRESH</b>	Shirts, Trouser, Comforter, Pillows	This cycle is best for smoothing out wrinkles and reducing odors from loads consisting of one to four dry items. In this cycle a small amount of water is sprayed into the dryer drum after several minutes of tumbling with heat.
<b>WRINKLE AWAY</b>	Shirts, Trouser, Blouses	The WRINKLE AWAY cycle removes wrinkles from clothes stored in closets, etc. It provides wrinkle release via optimized steam care. You can change the drying time. (Minimum time : 20 minutes) *For best results, load no more than 3 items.

## 2. Cycle options

<b>Anti Static (Steam Model Only)</b>	To reduce statics by clothing friction and spray steam at the later period of drying cycle. It is only available with: NORMAL, HEAVY DUTY, PERM PRESS, DELICATES (Dry level of every course exceeds Normal) and TIME DRY course. In order to reduce statics, the drum can be paused during operation.
<b>Rack Dry</b>	Rack Dry is available in the TIME DRY cycle. Temperature will be set to Extra Low only. (Refer to the "Rack dry (DV42H5400* Only)" section on page 28.)
<b>Mixed Load Bell</b>	The mixed load bell that notifies you when the average dry level in a load is damp dry (80% dried). This lets you take garments that you don't want fully dried or that dry quickly out of the dryer early while letting others continue to dry. You can select this function in all Sensor Dry cycles except WOOL, SANITIZE. The dry level selections are limited to Normal Dry, More Dry, and Very Dry.
<b>Wrinkle Prevent</b>	Wrinkle Prevent provides approximately 180 minutes of intermittent tumbling in unheated air at the end of the cycle to reduce wrinkling. Press the Wrinkle Prevent button to activate this feature. The indicator light above the pad will illuminate when Wrinkle Prevent is selected. The load is dry, and can be removed at any time during the Wrinkle Prevent cycle.
<b>My Cycle</b>	Choose your favorite cycle including cycle, temp, dry level option, etc. (Refer to the "My Cycle" section on page 30.)
<b>Adjust Time</b>	Time can be added or subtracted from the automatically set times in the Manual Dry cycles (TIME DRY, QUICK DRY, or AIR FLUFF cycles) and WRINKLE AWAY cycle. To add or subtract time from the cycle, press the Adjust Time arrow pad up or down until the desired time is displayed.
<b>Small Load Care™</b>	To control operation rate for drying a small loads at Sensor Dry course. It is only available with: NORMAL, HEAVY DUTY, PERM PRESS and DELICATES course. It can't be selected/cancelled when the drying course is running. In order to improve drying effect and control operation rate, the drum can be paused during operation.



**3. Dry Level**

To select the dry level in the NORMAL, HEAVY DUTY, or other Sensor Dry cycles, press the Dry Level button. An indicator light will illuminate next to the desired dryness level.

Press the button repeatedly to scroll through the settings. Larger or bulkier loads may require the Very Dry or More Dry setting for complete dryness.

The Less Dry setting is best suited for lightweight fabrics or for leaving some moisture in the clothing at the end of the cycle. Damp Dry is designed to partially dry items. Use for items that lay flat or hang to dry.

**4. Temp.**

To select the correct temperature for the load, press the Temp. button. An indicator light will illuminate next to the desired temperature. Press the button repeatedly to scroll through the settings.

<b>High</b>	For sturdy cottons or those labeled Tumble Dry.
<b>Medium</b>	For permanent press, synthetics, lightweight cottons, or items labeled Tumble Dry Medium.
<b>Med Low</b>	For lower heat than Medium to dry synthetic or washable knit fabrics.
<b>Low</b>	For heat sensitive items labeled Tumble Dry Low or Tumble Dry Warm.
<b>Extra Low</b>	Provides the lowest heated dry temperature possible.

**5. Time**

When using Manual Dry cycles, you can adjust the drying time by pressing the Time selection button.

During the Sensor Dry cycle, the time light indicator is off because exact drying times are determined by fluctuating humidity levels.

**6. LED Display**

The display window shows the estimated time remaining in the cycle after the Start/Pause button is pressed. The estimated time remaining may fluctuate as the cycle progresses.

The Drying light will illuminate and remain lit until the cycle is complete.

When your dryer is in the cool-down phase, the Cooling light will illuminate.

When your dryer is in the wrinkle prevent phase, the Wrinkle Prevent light will illuminate.

When the cycle is complete, "End" will appear in the display panel until the dryer door is opened or the Power button is pushed.

If your dryer is paused during a cycle, the indicator lights will blink until the Start/Pause button is pressed.





**7. Power**

Press once to turn your dryer on. Press again to turn it off. If your dryer is left on for more than 10 minutes without any buttons being touched, the power automatically turns off.

**8. Start/Pause**

Press to pause and restart programs.

**9. Indicators**

	Filter Check
	Drum Light
	Child Lock
	Sound Off
	Steam

## Load the dryer properly

- Place only one washload in your dryer at a time.
- Mixed loads of heavy and lightweight fabrics will dry differently, which may result in lightweight fabrics being dry while heavy fabrics remain damp at the end of a drying cycle.
- Add one or more similar items to your dryer when only one or two articles of clothing need drying. This improves the tumbling action and drying efficiency.
- Overloading restricts tumbling action, resulting in uneven drying as well as excessive wrinkling of some fabrics.



If you insert laundry into your dryer while it is extremely tangled immediately after your washer has finished a wash or spin cycle, it may degrade the drying efficiency or cause the door to open. We recommend that you untangle your laundry appropriately before inserting it.

## Getting started

1. Load your dryer loosely (DO NOT overload).
2. Close the door.
3. Select the appropriate cycle and options for the load. (For detail, refer to the "**Cycle overview**" on next page.)
4. Press the **Start/Pause** button.
5. The dryer indicator light will illuminate.
6. The estimated cycle time will appear in the display. The time may fluctuate as humidity levels fluctuate in the dryer.



- When the cycle is complete, "End" will appear in the display.
- Pressing Power cancels the cycle and stops your dryer.
- The Drying, Cooling, and Wrinkle Prevent indicator lights will illuminate during those portions of the cycle.



Do not place anything on top of your dryer while it is running.

## II Cycle overview

### Predefined

CYCLE	LOAD SIZE	DRY LEVEL		TEMPERATURE		
		Predefined	Adjustable	Predefined	Adjustable	
Sensor Dry	NORMAL	Large	Normal Dry	o	High	o
	HEAVY DUTY	Large	Normal Dry	o	High	-
	BEDDING	Large	Normal Dry	o	High	-
	SANITIZE	Large	Very Dry	-	High	-
	PERM PRESS	Medium	Normal Dry	o	Medium	-
	WOOL	Small	Normal Dry	-	Low	-
	DELICATES	Medium	Normal Dry	o	Extra Low	-
Manual Dry	ACTIVE WEAR	Small	Normal Dry	-	Medium	-
	QUICK DRY	Small	-	-	High	-
	TIME DRY	Large	-	-	High	o
	AIR FLUFF	Small	-	-	-	-
Steam Cycles	WRINKLE RELEASE	Small	-	-	Medium	-
	REFRESH	Small	-	-	High	-
	WRINKLE AWAY	Small	-	-	High	-



#### Load size recommendations

For best results, follow the load size recommendations for each drying cycle.

<b>Large</b>	Fill the drum to about ¾ full. Do not add items over this level as they need to tumble freely.
<b>Medium</b>	Fill the drum to about ½ full.
<b>Small</b>	Fill the drum with 3-5 items, not more than ¼ full.

### Options

CYCLE	AVAILABLE OPTIONS					
	Mixed Load Bell	Adjust time Up/Down	Small Load Care™	Anti Static	Wrinkle Prevent	
Sensor Dry	NORMAL	o	-	o	o	o
	HEAVY DUTY	o	-	o	o	o
	BEDDING	o	-	-	-	o
	SANITIZE	-	-	-	-	o
	PERM PRESS	o	-	o	o	o
	WOOL	-	-	-	-	o
	DELICATES	o	-	o	o	o
Manual Dry	ACTIVE WEAR	-	-	-	-	o
	QUICK DRY	-	o	-	-	o
	TIME DRY	-	o	-	o	o
	AIR FLUFF	-	o	-	-	o
Steam Cycles	WRINKLE RELEASE	-	o	-	-	o
	REFRESH	-	-	-	-	o
	WRINKLE AWAY	-	o	-	-	o

## I Rack dry (DV42H5400\* Only)

### I Installing the drying rack

1. Open the dryer door.
2. Position the drying rack in the tumbler, placing the front lip of the **drying rack (A)** on the top of the lint filter.
3. Place the rear legs in the two recessed areas of the dryer's back wall, and then push down the middle of the drying rack to fix in place.
4. Place the items to be dried on the rack, leaving space between them so air can circulate.
5. Close the dryer door.
6. Press the **Rack Dry** button in the TIME DRY cycle and then select the time according to the amount of moisture and the weight of the items. The drying rack can be also used at AIR FLUFF cycle.

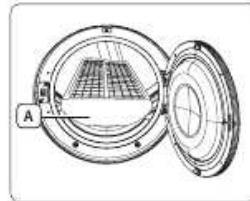

SUGGESTED ITEMS	SUGGESTED TEMP. SETTINGS
Washable sweaters (block to shape and lay flat on rack)	Extra Low (TIME DRY cycle)
Stuffed toys (cotton or polyester fiberfilled)	Extra Low (TIME DRY cycle)
Stuffed toys (foam or rubber-filled)	AIR FLUFF
Foam rubber pillows	AIR FLUFF
Sneakers	AIR FLUFF

 Drying foam rubber, plastic, or rubber on a heat setting may cause damage to the items and lead to a fire hazard.

 The drying rack is not included in the DV42H5200\* and DV42H5000\* models.  
You can purchase the drying rack (part code: DC61-02705A) at a local Samsung service center.

## Child Lock

Prevents children from playing with your dryer.

### Setting/Releasing

To turn Child Lock on or off, press both the **Temp.** and **Time** buttons simultaneously for 3 seconds.

### Child Lock Details

1. You can turn Child Lock on while your dryer is running.
2. Once you set the Child Lock function, no button, except for the Power button, will respond until you turn off the Child Lock function.
3. The "Child Lock" indicator will be lit.



- If the dryer is powered on again, the Child Lock function stays on.
- To turn off Child Lock, follow the instructions above.



When other buttons, except for the **Power** button, do not respond, check the Child Lock indicator. If Child Lock is on, follow the instructions above to turn Child Lock off.

## Drum Light

Lights the dryer drum while the dryer is running.

### Turning On and Off

To turn on or turn off the Drum Light, press and hold the **Wrinkle Prevent** (DV42HS400\*) / **Small Load Care™** (DV42HS200\*) button for 3 seconds; press the **Drum Light** (DV42HS000\*) button.



You can turn the Drum Light on and off while your dryer is running and when it is stopped.

If you do not turn the Drum Light off 5 minutes after turning it on, the Drum Light is automatically turned off.

## Sound Off

Use this function to mute the button and operating sounds.

### Setting and Releasing

To turn the Sound Off function on or off, press and hold the **Dry Level** button for 3 seconds (DV42HS400\*); press the **Sound** button (DV42HS200\*, DV42HS000\*).

### Sound Off Details:

1. You can set Sound Off while your dryer is running.
2. Once you have activated Sound Off, the button and operating sounds are muted until you deactivate it.
3. The "Sound Off" indicator will be lit.



If you do not turn the Sound Off function off before you turn your dryer off, it will still be on when you turn your dryer on again. To turn Sound Off off, follow the instructions above.



## My Cycle

### Load

- Press the **My Cycle** button for less than 3 seconds to activate My Cycle mode where all course settings and selected options are loaded.
- The My Cycle indicator turns on when the mode is active.
- If you have not configured any My Cycle settings, the default course settings are loaded.

### Save

You can add and save preferred options to My Cycle.

1. Turn the course dial to select a course.
2. Set necessary options for the selected course. For details on each course and options, see page 27.
3. Press and hold the **My Cycle** button for more than 3 seconds to save the course options. The My Cycle indicator blinks while the options are being saved.



The Wrinkle Prevent option is not available for the My Cycle function.

## Smart Care

This function enables you to check the status of the dryer using a smartphone.

1. Press and hold the **Small Load Care™** (DV42H5400\*) or **Sound** (DV42H5200\*, DV42H5000\*) button for 3 seconds when an error occurs or if you haven't pressed any buttons on the dryer after you turned the power on.
2. When the Smart Care function is activated, the LED on the window display rotates for 2 or 3 seconds and then the error code will appear in the display panel.
3. Run the **Smart Care app** on your smart phone.
  -  The Smart Care function has been optimized for: Galaxy & iPhone series (cannot be supported for some models).
4. If the smart phone's camera is focused on the display panel of the dryer, the panel and error message is automatically recognized and the error type and countermeasures are displayed on the smart phone.
5. If the smartphone fails to recognize the error code more than twice, please enter the error code displayed on the display panel of the dryer manually into the Smart Care app.

### Downloading the Smart Care app

Download the Samsung Laundry App into your mobile phone from the Android market or Apple App store.  
(Search word : Samsung Smart Washer/Dryer)

### Precautions when using Smart Care

- If light from a light bulb, fluorescent bulb, or lamp is reflected on the display panel of the washing machine, the smartphone may not be able to recognize the panel or error message easily.
- If you hold the smartphone at too large an angle relative to the front of the display panel, it may not be able to recognize the error code. For best results, hold the smartphone so that the front of the panel and the smartphone are parallel or nearly parallel.

## Care and cleaning

### Control panel

Clean with a soft, damp cloth. Do not use abrasive substances.

Do not spray cleaners directly on the panel.

The control panel finish may be damaged by some laundry pre-treatment soil and stain remover products.

Apply such products away from your dryer and wipe up any spills or overspray immediately.

### Tumbler

Remove any stains caused by crayon, ink, or fabric dye (from new items such as towels or jeans) with an all-purpose cleaner.

Tumble old towels or rags to remove any remaining stain or cleaning substance.

Once these steps are followed, stains may still be visible, but should not transfer to subsequent loads.

### Stainless steel tumbler

To clean the stainless steel tumbler, use a damp cloth with a mild, non-abrasive cleaner suitable for stainless steel surfaces.

Remove the cleaner residue and dry with a clean cloth.

### Dryer exterior

Clean with a soft, damp cloth. Do not use abrasive substances.

Protect the surface from sharp objects.

Do not place any heavy or sharp objects or a detergent box on the dryer. Keep them on the purchased pedestal or in a separate storage box. This may scratch or damage the top cover of the dryer.

Since the entire dryer has a high-gloss finish, the surface can be scratched or damaged.

Avoid scratching or damaging the surface when using the dryer.

### Dryer exhaust system

Should be inspected and cleaned yearly to maintain optimum performance.

The outside exhaust hood should be cleaned more frequently to ensure proper operation.

### Clean the lint filter

- After each load.
- To shorten drying time.
- To operate more energy efficiently.

 Do not operate your dryer without the lint filter in place.

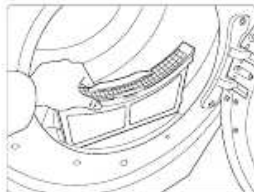

## ■ Special laundry tips

### Special laundry tips

Please follow the care label or manufacturer's instructions for drying special items. If care label instructions are not available, use the following information as a guide.

<b>Bedspreads &amp; Comforters</b>	Follow the care label instructions or dry on the <b>BEDDING</b> cycle. Make sure the item is thoroughly dry before using or storing. May require repositioning to ensure even drying.
<b>Blankets</b>	Use <b>NORMAL</b> cycle and dry only one blanket at a time for best tumbling action. Make sure the item is thoroughly dry before using or storing.
<b>Curtains &amp; Draperies</b>	Use the <b>PERM PRESS</b> cycle and Medium temperature to help minimize wrinkling. Dry these in small loads for best results and remove as soon as possible.
<b>Cloth Diapers</b>	Use the <b>NORMAL</b> cycle and the High temperature settings for soft, fluffy diapers.
<b>Down-filled Items (jackets, sleeping bags, comforters, etc.)</b>	Use the <b>NORMAL</b> cycle and the Medium temperature setting. Adding a couple of dry towels shortens drying time and absorbs moisture.
<b>Foam Rubber (rug backs, stuffed toys, shoulder pads, etc.)</b>	<b>DO NOT</b> dry on a heat setting. Use the <b>AIR FLUFF</b> cycle (no heat). <b>WARNING</b> – Drying a rubber item with heat may damage it or be a fire hazard.
<b>Pillows</b>	Use the <b>NORMAL</b> cycle. Add a couple of dry towels and a pair of clean sneakers to help the tumbling action and to fluff the item. <b>DO NOT</b> dry kapok or foam pillows in dryer. Use the <b>AIR FLUFF</b> cycle.
<b>Plastics (shower curtains, outdoor furniture covers, etc.)</b>	Use the <b>AIR FLUFF</b> cycle or the <b>TIME DRY</b> cycle and the Low or Extra Low temperature settings depending on the care label instructions.

#### THINGS TO AVOID PUTTING IN THE DRYER:

- Fiberglass items (curtains, draperies, etc.).
- Woolens, unless recommended on the label.
- Vegetable oil- or cooking oil-soaked, or gasoline-soaked items.



## ■ Troubleshooting

Check these points if your dryer...

PROBLEM	SOLUTION
<b>Doesn't run.</b>	<ul style="list-style-type: none"> <li>• Make sure the door is latched shut.</li> <li>• Be sure the power cord is plugged into a live electrical outlet.</li> <li>• Check the home's circuit breaker and fuses.</li> <li>• Press the Start/Pause button again if the door is opened during the cycle.</li> </ul>
<b>Doesn't heat.</b>	<ul style="list-style-type: none"> <li>• Check the home's circuit breaker and fuses.</li> <li>• Select a heat setting other than Air Fluff.</li> <li>• On a gas dryer, check that the gas supply is on.</li> <li>• Clean the lint filter and exhaust duct.</li> <li>• Dryer may have moved into the cool-down phase of the cycle.</li> </ul>
<b>Doesn't dry.</b>	<ul style="list-style-type: none"> <li>• Check all of the above, plus...</li> <li>• Be sure the exhaust hood outside the home can open and close freely.</li> <li>• Check exhaust system for lint buildup. Ducting should be inspected and cleaned annually.</li> <li>• Use a 4" rigid metal exhaust duct.</li> <li>• Do not overload. 1 wash load = 1 dryer load.</li> <li>• Sort heavy items from lightweight items.</li> <li>• Large, bulky items like blankets or comforters may require repositioning to ensure even drying.</li> <li>• Check that the dryer is draining properly to extract adequate water from the load.</li> <li>• Load may be too small to tumble properly. Add a few towels.</li> </ul>
<b>Is noisy.</b>	<ul style="list-style-type: none"> <li>• Check the load for objects such as coins, loose buttons, nails, etc. Remove promptly.</li> <li>• It is normal to hear the dryer gas valve or heating element cycle on and off during the drying cycle.</li> <li>• Be sure the dryer is leveled properly as outlined in the installation instruction.</li> <li>• It is normal for the dryer to hum due to the high velocity of air moving through the dryer drum and exhaust system.</li> </ul>
<b>Dries unevenly.</b>	<ul style="list-style-type: none"> <li>• Seams, pockets, and other similarly heavy areas may not be completely dry when the rest of the load has reached the selected dryness level. This is normal. Select the Very Dry setting if desired.</li> <li>• If one heavy item is dried with a lightweight load, such as one towel with sheets, it is possible that the heavy item will not be completely dry when the rest of the load has reached the selected dryness level. Sort heavy items from lightweight items for best drying results.</li> </ul>
<b>Has an odor.</b>	<ul style="list-style-type: none"> <li>• Household odors from painting, varnishing, strong cleaners, etc. may enter the dryer with the surrounding room air. This is normal as the dryer draws the air from the room, heats it, pulls it through the tumbler, and exhausts it outside.</li> <li>• When these odors linger in the air, ventilate the room completely before using the dryer.</li> </ul>
<b>Shuts off before load is dry</b>	<ul style="list-style-type: none"> <li>• Dryer load is too small. Add more items or a few towels and restart the cycle.</li> <li>• Dryer load is too large. Remove some items and restart the dryer.</li> </ul>

PROBLEM	SOLUTION
<b>Lint on clothes</b>	<ul style="list-style-type: none"> <li>• Make sure the lint filter is cleaned before every load. With some loads that produce high amounts of lint, it may be necessary to clean the filter during the cycle.</li> <li>• Some fabrics are lint producers (for example, a fuzzy white cotton towel) and they should be dried separately from clothes that are lint trappers (for example, a pair of lack linen pants)</li> <li>• Divide larger loads into smaller loads for drying.</li> <li>• Check pockets thoroughly before washing and drying clothes.</li> </ul>
<b>Garments still wrinkled after Wrinkle-Care</b>	<ul style="list-style-type: none"> <li>• Small loads of 1 to 4 items work best.</li> <li>• Load fewer garments. Load similar-type garments.</li> </ul>
<b>Odors remain in clothing after Refresh.</b>	<ul style="list-style-type: none"> <li>• Fabrics containing strong odors should be washed in a normal cycle.</li> </ul>
<b>Water drips from nozzle when Steam-Care starts</b>	<ul style="list-style-type: none"> <li>• This is steam condensation. The dripping water will stop after a short time.</li> </ul>
<b>Sprayed water is not visible during Steam-Care</b>	<ul style="list-style-type: none"> <li>• Sprayed water is difficult to see when the door is closed.</li> </ul>

## Information codes

Information codes may be displayed to help you better understand what is occurring with your Dryer.



































ERROR DISPLAY	MEANING	SOLUTION
<b>tE</b>	The thermistor resistance is very low or high.	Clean the screen or vent. If the problem continues, call for service.
<b>HE</b>	Invalid heating Temp when the dryer is running.	Call for service.
<b>dE</b>	Running the dryer with door open.	Clean the door and then restart. If the problem continues, call for service.
<b>bE2</b>	Invalid state of key.	Make sure a button is NOT being pressed continuously. Try restarting the cycle. If the problem continue, call for service.
<b>FE</b>	Invalid power source frequency.	Try restarting the cycle. If the problem continues, call for service.
<b>9E1</b>	Electronic Control Problem (Over Voltage Error.)	Call for service.
<b>AE</b>	Electronic Control Problem (Communication Error.)	Call for service.
<b>EEE</b>	Invalid state of Eeprom communication.	Call for service.
<b>dF</b>	Invalid door.	Call for service.

For any codes not listed above, call 1-800-SAMSUNG (726-7864)

## Appendix

### Fabric care chart

The following symbols provide garment care direction. The Clothing care labels include symbols for washing, bleaching, drying, and ironing, or dry cleaning when necessary. The use of symbols ensures consistency among garment manufacturers of domestic and imported items. Follow care label directions to maximize garment life and reduce laundering problems.

Wash Cycle		Special Instructions		Warning Symbols for Laundering	
	Normal		Line Dry/ Hang to Dry		Do Not Wash
	Permanent Press / Wrinkle Resistant / Wrinkle Control		Drip Dry		Do Not Wring
	Gentle/Delicates		Dry Flat		Do Not Bleach
	Hand Wash	<b>Heat Setting</b>			Do Not Tumble Dry
<b>Water Temperature**</b>			High		No Steam (added to iron)
	Hot		Medium		Do Not Iron
	Warm		Low	<b>Dryclean</b>	
	Cold		Any Heat		Dry Clean
<b>Bleach</b>			No Heat/Air		Do Not Dry Clean
	Any Bleach (when needed)	<b>Iron-Dry or Steam Temperatures</b>			Line Dry/ Hang to Dry
	Only Non-Chlorine (color-safe) Bleach (when needed)		High		Drip Dry
	Tumble Dry Cycle		Medium		Dry Flat
<b>Normal</b>			Low		
	Permanent Press/ Wrinkle Resistant/ Wrinkle Control				
	Gentle/Delicates				

\*\* The dot symbols represent appropriate wash water temperatures for various items. The temperature range for Hot is 105 – 125 °F (41 – 52 °C), for Warm 85 – 105 °F (29 – 41 °C) and for Cold 60 – 85 °F (16 – 29 °C). (Wash water temperature must be a minimum of 60 °F (16 °C) for detergent activation and effective cleaning.)

## Protecting the environment

This appliance is manufactured from recyclable materials. If you decide to dispose of this appliance, please observe local waste disposal regulations. Cut off the power cord so that the appliance cannot be connected to a power source. Remove the door so that animals and small children cannot get trapped inside the appliance.

## Declaration of conformity

This appliance complies with UL2158.

## Specifications

TYPE		FRONT LOADING DRYER
DIMENSIONS	Height	38.7" (98.4 cm)
	Width	27" (68.6 cm)
	Depth with door open 90°	53" (134.5 cm)
	Depth	32.4" (82.3 cm)
WEIGHT		125.6 lb (57 Kg)
HEATER RATING		5300 W (Elec.) 22000 BTU/hr (Gas)
EXTRA LARGE CAPACITY		7.5 cu.ft.

## ■ Warranty (U.S.A)

### SAMSUNG DRYER

#### LIMITED WARRANTY TO ORIGINAL PURCHASER

This SAMSUNG brand product, as supplied and distributed by SAMSUNG ELECTRONICS AMERICA, INC. (SAMSUNG) and delivered new, in the original carton to the original consumer purchaser, is warranted by SAMSUNG against manufacturing defects in materials and workmanship for a limited warranty period of:

- One (1) Year All Parts and Labor
- Two (2) Years Control Board Parts

This limited warranty begins on the original date of purchase, and is valid only on products purchased and used in the United States.

To receive warranty service, the purchaser must contact SAMSUNG for problem determination and service procedures.

Warranty service can only be performed by a SAMSUNG authorized service center.

The original dated bill of sale must be presented upon request as proof of purchase to SAMSUNG or SAMSUNG's authorized service center.

SAMSUNG will provide in-home service during the warranty period at no charge, subject to availability within the contiguous United States.

In-home service is not available in all areas.

To receive in-home service, product must be unobstructed and accessible to the service agent.

If service is not available, SAMSUNG may elect to provide transportation of the product to and from an authorized service center.

SAMSUNG will repair, replace, or refund this product at our option and at no charge as stipulated herein, with new or reconditioned parts or products if found to be defective during the limited warranty period specified above.

All replaced parts and products become the property of SAMSUNG and must be returned to SAMSUNG.

Replacement parts and products assume the remaining original warranty, or ninety (90) days, whichever is longer.

This limited warranty covers manufacturing defects in materials and workmanship encountered in normal, noncommercial use of this product and shall not apply to the following: damage that occurs in shipment; delivery and installation; applications and uses for which this product was not intended; altered product or serial numbers; cosmetic damage or exterior finish; accidents, abuse, neglect, fire, water, lightning, or other acts of nature or God; use of products, equipment, systems, utilities, services, parts, supplies, accessories, applications, installations, repairs, external wiring or connectors not supplied or authorized by SAMSUNG that damage this product or result in service problems; incorrect electrical line voltage, fluctuations and surges; customer adjustments and failure to follow operating instructions, maintenance and environmental instructions that are covered and prescribed in the instruction book; product removal and reinstallation; problems caused by pest infestations.

This limited warranty does not cover problems resulting from incorrect electric current, voltage or supply, light bulbs, house fuses, house wiring, cost of a service call for instructions, or fixing installation errors.

SAMSUNG does not warrant uninterrupted or error-free operation of the product.

Except as set forth herein, there are no warranties on this product either express or implied, and samsung disclaims all warranties including, but not limited to, any implied warranties of merchantability, infringement or fitness for a particular purpose.

No warranty or guarantee given by any person, firm, or corporation with respect to this product shall be binding on samsung.

Samsung shall not be liable for loss of revenue or profits, failure to realize savings or other benefits, or any other special, incidental or consequential damages caused by the use, misuse, or inability to use this product, regardless of the legal theory on which the claim is based, and even if samsung has been advised of the possibility of such damages.

Nor shall recovery of any kind against samsung be greater in amount than the purchase price of the product sold by samsung and causing the alleged damage.

Without limiting the foregoing, purchaser assumes all risk and liability for loss, damage, or injury to purchaser and purchaser's property and to others and their property arising out of the use, misuse, or inability to use this product. This limited warranty shall not extend to anyone other than the original purchaser of this product, is nontransferable and states your exclusive remedy.

Some states do not allow limitations on how long an implied warranty lasts, or the exclusion or limitation of incidental or consequential damages, so the above limitations or exclusions may not apply to you. This warranty gives you specific rights, and you may also have other rights, which vary from state to state.

**To obtain warranty service, please contact SAMSUNG at:**

**Samsung Electronics America, Inc.**

**85 Challenger Road Ridgefield Park, NJ 07660**

**1-800-SAMSUNG(726-7864)**

**[www.samsung.com](http://www.samsung.com)**