



TRAVIS

WHEEL MOVE

Western-Travis and A & M

DELUXE HYDRAULIC MOVER



Western and A&M Style available, specify color

ITEM #

2-8200

2-8200-P

2-8200-L (16' long, P motors)

Deluxe Hydraulic Movers feature an Industrial/Commercial Grade Hydraulic Pump driven by either a Genuine Briggs and Stratton 1450 Series Industrial/Commercial Grade Engine or a Genuine Honda GX 160 Industrial/Commercial Grade Engine at no additional cost, which powers fluid to two Char-Lynn Industrial/Commercial Grade Orbit Motors, which in turn power an 82 Tooth Bull Gear that transfers the power to the 4" or 5" Wheel Line and the axles via a Nickel Plated drive chain. Mover wheels require a 4" hub, and Hydraulic oil, cover and wheels are not included.

TWIN RAIL STYLE MOVER



Features 15' length and twin frame construction.
Engine has horizontal shaft and is part of an assembled power unit. All other hydraulic and engine components same as a standard A & M or Western unit.

<i>DESCRIPTION</i>	<i>DESIGNATION</i>	<i>WT.</i>
Mover only	TR 118000	460.00 lbs
Cover only	TR CVR/H	25.00

Product of: **TRAVIS PATTERN & FOUNDRY INC., SPOKANE, WASHINGTON**

Prices: SUBJECT TO CHANGE WITHOUT NOTICE

FAX: (509) 467-6465 - PHONE: (509) 466-3545

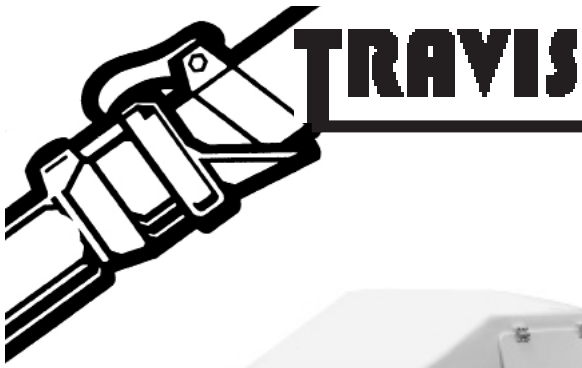

WHEEL MOVE

Western and A & M

HINGED PLASTIC COVER



<i>DESCRIPTION</i>	<i>PART #</i>	<i>WT.</i>
Cover Only	CVR	25.00 lbs
Cover w/Hinge	CVR/H	25.00

Heavy duty plastic cover fits twin rail, all movers shown above and all units sold as A & M and Western Style movers in previous years.

FLANGE ADAPTERS

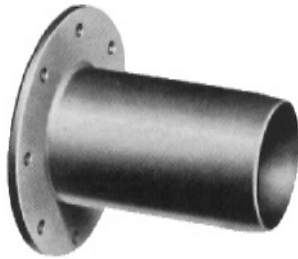

<i>ITEM #</i>	<i>WT.</i>	<i>SIZE</i>
AMRAD-4R	5.50 lbs	4"
AMRAD-5R	6.25	5"
AMRAD-4G	Gasket - 8 Hole	4" & 5'

Press in adapter used to connect tubing to mover.
Price includes nuts, bolts and flange gaskets.

Product of: **TRAVIS PATTERN & FOUNDRY INC., SPOKANE, WASHINGTON**

Prices: SUBJECT TO CHANGE WITHOUT NOTICE

FAX: (509) 467-6465 - PHONE: (509) 466-3545

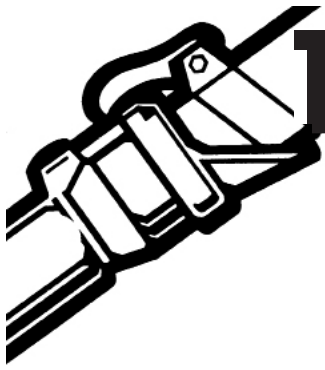

TRAVIS

WHEEL MOVE

Wade / Western and A & M

BIG GUN CART ASSEMBLY

Includes all steel welded main frame with 84" long, 4" diameter axle and two heavy duty galvanized wheels. Clamp on 4" diameter aluminum riser includes a sprinkler adaptor for 2" male or 2 1/2" female sprinkler. Available in 3" or 4" male inlet. Each cart is shipped with both knob style and hook style latches. Optional Independent Bearing Kit allows each wheel to turn independently on axle for easier manual maneuvering in tight spaces.

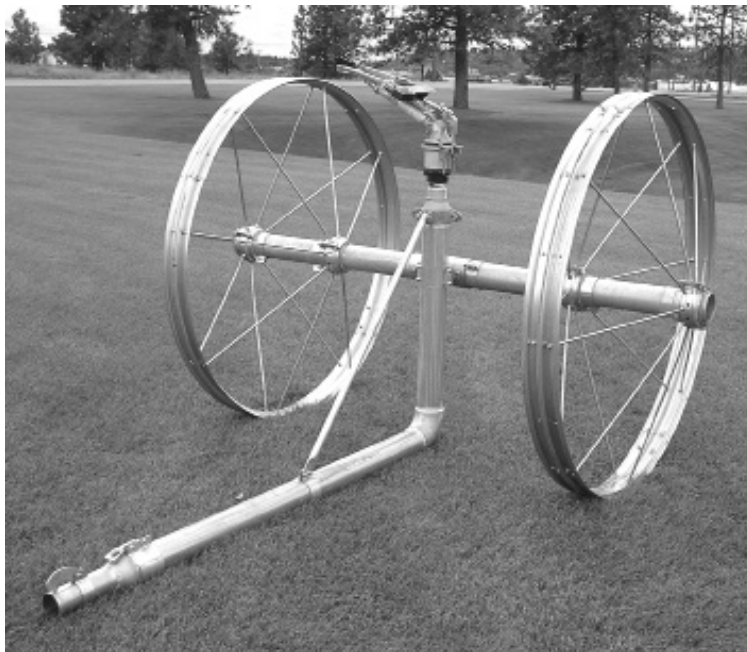

Big Gun® Cart Assembly recommended for use with Nelson 100 Series Big Gun® Sprinkler or equivalent.

<i>PART No.</i>	<i>DESCRIPTION</i>	<i>WT.</i>
Low Profile 46" Wheel		
5046-3	3" male inlet w/46" wheels	107.0 lbs
5046-4	4" male inlet w/46" wheels	115.0 lbs
Standard Profile 57" Wheel		
5057-3	3" male inlet w/57" wheels	116.0 lbs
5057-4	4" male inlet w/57" wheels	116.0 lbs
Big Gun Cart Less Wheels		
5000-3	3" male inlet without wheels	39 lbs
5000-4	4" male inlet without wheels	39 lbs
5000	Optional Independent Bearing Kit	30 lbs

Product of: **TRAVIS PATTERN & FOUNDRY INC., SPOKANE, WASHINGTON**

Prices: SUBJECT TO CHANGE WITHOUT NOTICE

FAX: (509) 467-6465 - PHONE: (509) 466-3545



TRAVIS

WHEEL MOVE

ALUMINUM WHEEL MOVE TORQUE COUPLER

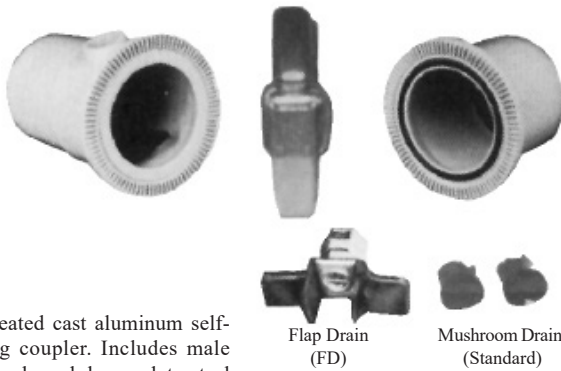

SIZE	DESIGNATION	WT.
4"	WMT 400	8.00 lbs
4"	WMT (FD) 400	8.00
5"	WMT 500	8.50
5"	WMT (FD) 500	8.50

Heat treated cast aluminum self-aligning coupler. Includes male end, female end, heavy duty steel torque clamp. 1" riser outlet, flap drain or two mushroom drains.

Flap Drain (FD)

Mushroom Drain (Standard)

****Western O-Ring style coupler**

MALE END—WMT—M

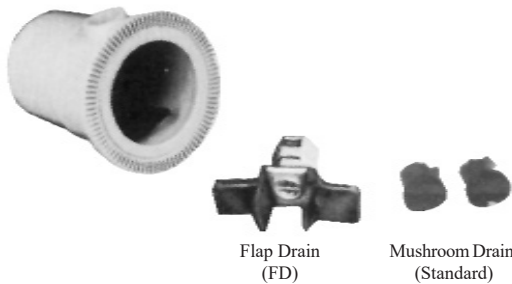

SIZE	DESIGNATION	WT.
4"	WMT-M 400	3.00 lbs
4"	WMT-M (FD) 400	3.00
5"	WMT-M 500	3.20
5"	WMT-M (FD) 500	3.20

Heat treated male end, two mushroom drains or flap drain, 1" riser outlet.

Flap Drain (FD)

Mushroom Drain (Standard)

****Western O-Ring style coupler**

FEMALE END—WMT—F



SIZE	DESIGNATION	WT.
4"	WMT-F 400	2.00 lbs
5"	WMT-F 500	2.20

Heat treated aluminum female end with "O" ring gasket.

****Western O-Ring style coupler**

Product of: **TRAVIS PATTERN & FOUNDRY INC., SPOKANE, WASHINGTON**

Prices: SUBJECT TO CHANGE WITHOUT NOTICE

FAX: (509) 467-6465 - PHONE: (509) 466-3545

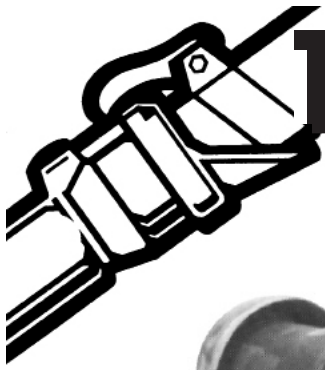

MANUAL FLUSHING END PLUG

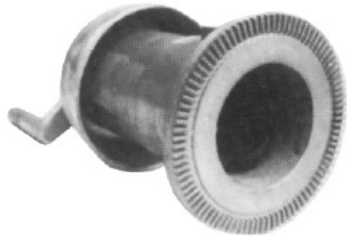

	<i>DESIGNATION</i>	<i>Wt.</i>
With O ring female	CEP-FF	5.50 lbs
With riser outlet male	CEP-FM	6.00
Splash pan	FEPC	
Handle & stem	FEPH&S	

****Western O-Ring style coupler**

Heat treated manual flushing end plug for 4" and 5" lines.

Same end plug fits both 4" and 5" coupler. Does not include locking clamp.

ALUMINUM TELESCOPING ADAPTER — WMT-T ALUMINUM HOSE ADAPTER — WMT-H



"M" with riser as shown.
"F" no riser with "O" ring.

	<i>DESIGNATION</i>	<i>Wt.</i>
	WMT-TF 403	5.00 lbs
	WMT-TM 403	5.00
	WMT-TF 504	5.00
	WMT-TM 504	5.00
	WMT-HF 403	5.00
	WMT-HM 403	5.00
	WMT-HF 504	5.00
	WMT-HM 504	5.00

****Western O-Ring style coupler**

Telescoping adapter and hose adapter heat treated. Does not include steel clamp.

*Press-in steel available—Contact Factory.

CENTER INLET TEE



<i>SIZE</i>	<i>DESIGNATION</i>	<i>Wt.</i>
4" or 5"	WMT-CFT 400	15.50 lbs

FITS EITHER 4" OR 5". 4" LATCH TYPE INLET STANDARD. OTHER INLET SIZES AVAILABLE. CONTACT FACTORY.

Used when wheel line straddles the main line.

****Western O-Ring style coupler**

STEEL TORQUE CLAMP

Heavy duty steel clamp for quick assembly.



	<i>DESIGNATION</i>	<i>Wt.</i>
(CLAMP)	WMT-C	3.00 lbs
(SPRING)	WMT-CBS	Repair spring

Same clamp used for WMT and WMT-W.
Fits both 4" and 5" coupler.

****Western O-Ring style coupler**

Product of: **TRAVIS PATTERN & FOUNDRY INC., SPOKANE, WASHINGTON**

Prices: SUBJECT TO CHANGE WITHOUT NOTICE

FAX: (509) 467-6465 - PHONE: (509) 466-3545

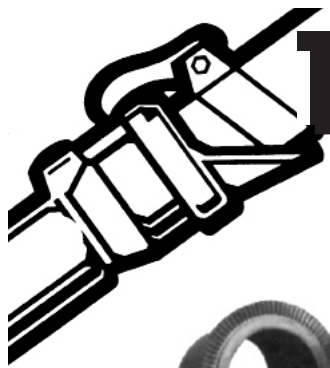

QUICK BREAKDOWN COUPLER ASSEMBLY



SIZE	DESIGNATION	WT.
4"	WMT-D 400	7.00 lbs
5"	WMT-D 500	7.00

Set includes one female end with "O" ring, one female end without "O" ring, one torque clamp.

STANDARD FEMALE COUPLER WITHOUT "O" RING GROOVE



Heat treated aluminum female end without "O" ring groove.

SIZE	DESIGNATION	WT.
4"	WMT-DF 400	2.00 lbs
5"	WMT-DF 500	2.00

****Western O-Ring style coupler**

Cast aluminum. Used for center risers. No part goes inside pipe.



RISER GROMMET ASSEMBLY

SIZE	DESIGNATION	WT.
3"	RG 300	1.25 lbs
4"	RG 400	1.25
5"	RG 500	1.50
6"	RG 600	2.00

DEMOUNTABLE FLANGE ADAPTER



Cast aluminum construction. To enable breakdown of demountable wheel line at mover. 5" fits both 4" & 5" coupler. Includes nuts, bolts, and flange gasket.

	SIZE	DESIGNATION	WT.
Female end	5"	WMT-DFA-F 500	4.00 lbs
Male end	5"	WMT-DFA-M 500	4.00
Flange only		DFA-FL	

****Western O-Ring style coupler**

Product of: **TRAVIS PATTERN & FOUNDRY INC., SPOKANE, WASHINGTON**

Prices: SUBJECT TO CHANGE WITHOUT NOTICE

FAX: (509) 467-6465 - PHONE: (509) 466-3545

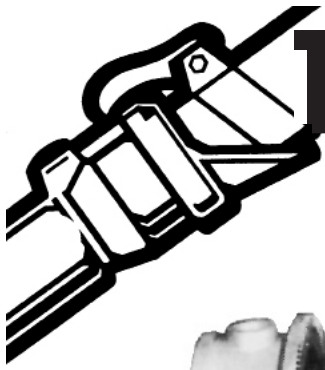

TRAVIS

WHEEL MOVE

WELD ON WHEEL MOVE TORQUE COUPLER

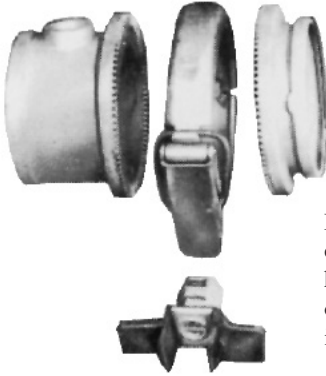

<i>SIZE</i>	<i>DESIGNATION</i>	<i>WT.</i>
5"	WMT-W 500	6.25 lbs

Heat treated cast aluminum self-aligning coupler. Includes male end, female end, heavy duty steel torque clamp. 1" riser outlet, flap drain. Welds to aluminum tubing. Interchangeable with press on coupler.

****Western O-Ring style coupler**

MALE END - WMT W-M

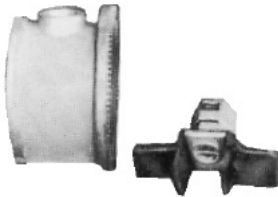

<i>SIZE</i>	<i>DESIGNATION</i>	<i>WT.</i>
5"	WMT W-M 500	2.00 lbs

Heat treated male end, flap drain, 1" riser outlet. Welds to aluminum tubing. Interchangeable with press-on coupler.

****Western O-Ring style coupler**

FEMALE END - WMT W-F



<i>SIZE</i>	<i>DESIGNATION</i>	<i>WT.</i>
5"	WMT W-F 500	1.25 lbs

Heat treated aluminum female end with "O" ring gasket. Welds to aluminum tubing. Interchangeable with press-on coupler.

****Western O-Ring style coupler**

Product of: **TRAVIS PATTERN & FOUNDRY INC., SPOKANE, WASHINGTON**

Prices: SUBJECT TO CHANGE WITHOUT NOTICE

FAX: (509) 467-6465 - PHONE: (509) 466-3545



ALUMINUM INTERNAL DRAIN COUPLER

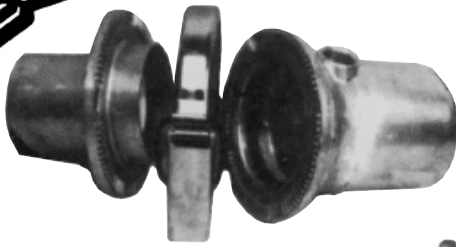

Hold bands recommended

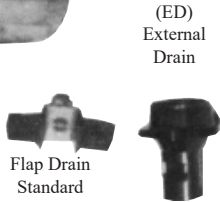

Cast aluminum coupler set. Includes male end, female end, gasket. Either clamp or nut & bolt connection available. Flap-drain standard, spring loaded external drain (ED) optional.

<i>SIZE</i>	<i>DESIGNATION</i>
4"	WID 400
4"	WID (ED) 400
5"	WID 500
5"	WID (ED) 500
CLAMP	WID-C
DRAIN	18-1

****Travis Internal drain couplers**

MALE END—WID—M



Male end, flapper drain standard, optional spring loaded external drain (ED) available. Includes drain and gasket.

Hold bands recommended

<i>SIZE</i>	<i>DESIGNATION</i>
4"	WID-M 400
4"	WID-M (ED) 400
5"	WID-M 500
5"	WID-M (ED) 500

****Travis Internal drain couplers**

FEMALE END—WID—F



Aluminum female with extension to provide sealing with the internal gasket.

Hold bands recommended

<i>SIZE</i>	<i>DESIGNATION</i>
4"	WID-F 400
5"	WID-F 500

****Travis Internal drain couplers**

Product of: **TRAVIS PATTERN & FOUNDRY INC., SPOKANE, WASHINGTON**

Prices: SUBJECT TO CHANGE WITHOUT NOTICE

FAX: (509) 467-6465 - PHONE: (509) 466-3545

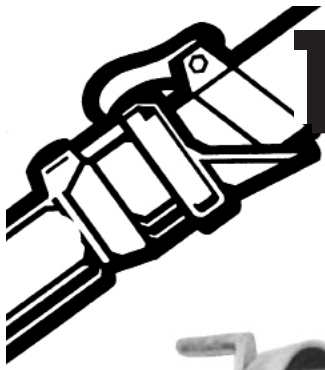

*Fits Only Internal Drain Style Couplers.

INTERNAL DRAIN MANUAL FLUSHING END PLUG

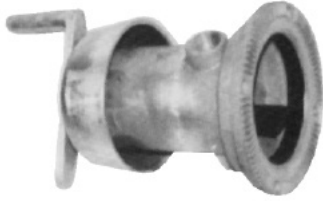

Manual flushing end plug for internal drain lines. Fits 4" or 5" lines.

With riser outlet & gasket

Splash pan
Handle and stem

**Travis Internal drain couplers

DESIGNATION

FEMALE CEP-WID-F

MALE CEP-WID-M

FEP C

FEP H & S

INTERNAL DRAIN TELESCOPING ADAPTER — WID—T INTERNAL DRAIN HOSE ADAPTER — WID—H



**Travis Internal drain couplers

SIZE

4x3

5x4

4x4

5x4

DESIGNATION

WID-TF 403

*WID-TM 403

WID-TF 504

*WID-TM 504

WID-HF 404

*WID-HM 404

WID-HF 504

*WID-HM 504

WT.

5.00 lbs

5.00

5.00

5.00

5.00

5.00

5.00

5.00

*End with riser outlet.

INTERNAL DRAIN CENTER INLET TEE



**Travis Internal drain couplers

SIZE

4"

DESIGNATION

WID-CFT 400

WT.

16.00 lbs

Fits either 4" or 5" line. 4" latch type inlet standard.
Other inlet sized available.
Contact Factory

Product of: **TRAVIS PATTERN & FOUNDRY INC., SPOKANE, WASHINGTON**

Prices: SUBJECT TO CHANGE WITHOUT NOTICE

FAX: (509) 467-6465 - PHONE: (509) 466-3545

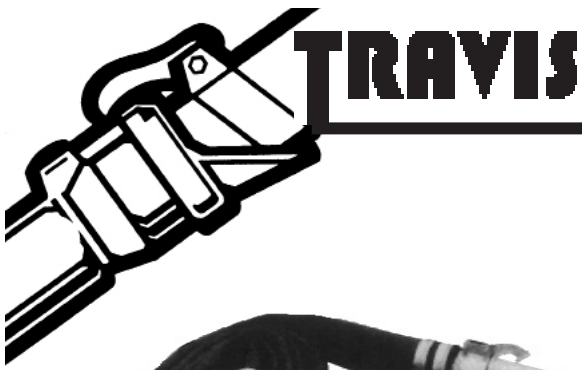

WHEEL MOVE

Universal Parts

STANDARD 20' LENGTH OF HOSE



MM-Male end x Male end
 MF-Male end x Female end
 Completely assembled to install in system.
 Other lengths available upon request.

<i>ITEM #</i>		<i>SIZE</i>
W670-4MM	Complete	4"
W670-4MF	Complete	4"

RAINWAY MALE HOSE END



<i>ITEM #</i>	<i>SIZE</i>
W660-4M	4"

INVERTED GROOVE IS STANDARD.
 INCLUDES 1 LOOSE FIT BAND & LATCH
 ASSEMBLY AND 2 HOSE CLAMPS.

RAINWAY FEMALE HOSE END

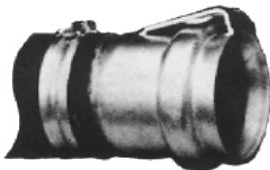

<i>ITEM #</i>	<i>WT.</i>	<i>SIZE</i>
W660-4F	3.50 lbs	4"

INVERTED GROOVE IS STANDARD.
 INCLUDES GASKET AND 2 HOSE CLAMPS.
 RAISED BEAD HOSE FITTINGS ALSO AVAILABLE.
 SEE PAGE 12 IN WESTERN FITTINGS & STEEL ROUND BACK
 FITTINGS.

HOSE CLAMP



Includes nuts & bolts

<i>ITEM #</i>	<i>WT.</i>	<i>SIZE</i>
WHC-4	.50 lbs	4"

For inverted hose ends only

HOSE



<i>ITEM #</i>	<i>WT.</i>	<i>SIZE</i>
W-670-4	1.25 lbs	4"

Product of: **TRAVIS PATTERN & FOUNDRY INC., SPOKANE, WASHINGTON**

Prices: SUBJECT TO CHANGE WITHOUT NOTICE

FAX: (509) 467-6465 - PHONE: (509) 466-3545

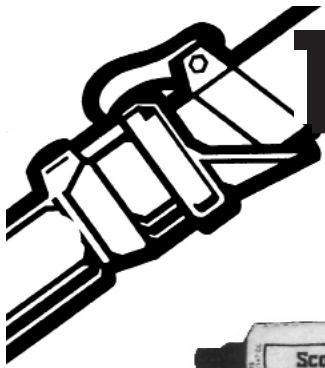

Universal Parts

3M CEMENT



Used to glue in center bolt-on riser outlet gaskets and torque coupler 'O' rings. Larger quantities available upon request.

<i>ITEM #</i>	<i>WT.</i>
A-88	5 oz

MUSHROOM DRAIN



<i>DESIGNATION</i>	<i>ITEM #</i>	<i>SIZE</i>	<i>BOX QTY.</i>
Drain	D-2-5	Long	100
Clip	D-2-4-SC		100

TORQUE COUPLER 'O' RING

'O' ring gasket for torque coupler. Specify when ordering for steel.

NOTE: ORG Box Quantity of 200



<i>DESIGNATION</i>	<i>SIZE</i>
ORG	fits 4" x 5"
*WID-E-1	4.5"
* Internal Drain Chevron Gasket Fits WID Couplers.	

PRESSING COMPOUND



Used in aluminum tube fabrication.

<i>ITEM #</i>	<i>DESCRIPTION</i>
Forrest WNA-1F	A & B
Part A	Paint
Part B	Catalyst
Epoxy thinner	1 gal.

FLAPPER TYPE DRAIN VALVE



<i>DESIGNATION</i>
FD 100

Product of: TRAVIS PATTERN & FOUNDRY INC., SPOKANE, WASHINGTON

Prices: SUBJECT TO CHANGE WITHOUT NOTICE

FAX: (509) 467-6465 - PHONE: (509) 466-3545

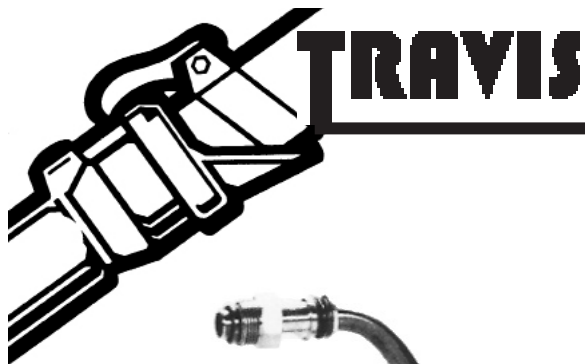

WHEEL MOVE

Universal Parts

SPRINKLER POSITIONERS



Jensen Style

Used to guarantee upright position of sprinkler at all times.

<i>ITEM #</i>		<i>WT.</i>
L-75	3/4" leveler	2.40 lbs

NOTE: Box Quantity of 33

REPAIR PARTS AVAILABLE. - SEE PARTS SECTION

*For Quantity Orders — Contact Factory.

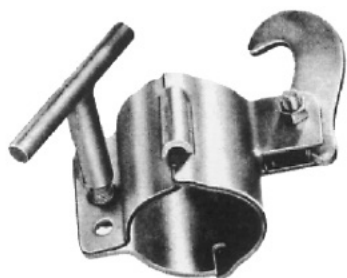

Adjustable band assembly for telescope.

SLIDE BAND

<i>SIZE</i>	<i>DESIGNATION</i>	<i>WT.</i>
3"	B 303	2.00 lbs
4"	B 404	2.25



RISER ELBOW

<i>MATERIAL</i>	<i>ITEM #</i>	<i>WT.</i>
Aluminum	RE 1x3/4	1.00 lbs
Steel	SLE 1-12S	1.00 lbs

NOTE: SLE 1-12S Box Quantity of 20



HOLD BANDS

<i>STEEL ITEM #</i>	<i>ALUM. ITEM #</i>	<i>WT. PER 100 ALUM.</i>	<i>SIZE</i>
	HB-300		3"
SHB-4	HB-400	13.00 lbs	4"
SHB-5	HB-500	16.00	5"
SHB-6	HB-600	19.00	6"
SHB-8	HB-800	44.00	8"
SHB-10	HB-1000	63.00	10"
SHB-12		—	12"

*Contact factory for prices on mill run orders

Product of: **TRAVIS PATTERN & FOUNDRY INC., SPOKANE, WASHINGTON**

Prices: SUBJECT TO CHANGE WITHOUT NOTICE

FAX: (509) 467-6465 - PHONE: (509) 466-3545



TRAVIS

WHEEL MOVE

Universal Parts WHEELS



Wheels shipped unassembled.

Includes 8 cleats for 5' & 6' wheels, 10 cleats for 7' and 8' wheels and 20 cleats for 10' wheels.

HUB	SIZE WHEEL	GAUGE	DESIGNATION	WT.
4"	58"	18	WXN 4152	42.00 lbs
5"	58"	18	WXN 5152	42.00
4"	64"	18	WXN 4162	44.00
5"	64"	18	WXN 5162	44.00
4"	76"	18	WXN 4172	56.00
5"	76"	18	WXN 5172	56.00
4"	96"	16	*WX 4184	78.00
5"	96"	16	*WX 5184	78.00
4"	120"	16	*WX 41101	113.00
5"	120"	16	*WX 51101	113.00

*Limited availability. Check with factory.



RIM HALF

Galvanized
Two required per wheel.

SIZE	DESIGNATION	WT.
58"/18ga	750088	9.00 lbs
64"/18ga	750091	10.00
76"/18ga	750094	12.00
96"/18ga	*100011	19.00
120"/18ga	*100060	23.00

*Limited availability. Check with factory.

HUB HALF



Galvanized
Four required per wheel.

SIZE	DESIGNATION	WT.
4"	750070	1.09 lbs
5"	750071	1.19

SPOKE



	LENGTH	SIZE WHEEL	HUB	DESIGNATION	WT.
	27- $\frac{1}{4}$ "	58"	4	WS 54	1.00 lbs
	26- $\frac{7}{8}$ "	58"	5	WS 55	.90
16 required for 58" & 64" wheel, 20 required for 76", 96" and 120" wheels. Measured end to end.	30- $\frac{1}{2}$ "	64"	4 & 5	WS 6	1.10
Zinc Plated.	37"	76"	4 & 5	WS 7	1.20
	46- $\frac{7}{8}$ "	96"	4 & 5	*100077	1.50
*Limited availability. Check with factory.	56- $\frac{3}{4}$ "	120"	4 & 5	*100078	2.40

Product of: **TRAVIS PATTERN & FOUNDRY INC., SPOKANE, WASHINGTON**

Prices: SUBJECT TO CHANGE WITHOUT NOTICE

FAX: (509) 467-6465 - PHONE: (509) 466-3545

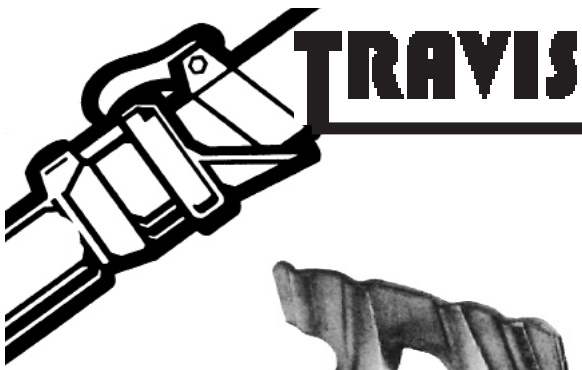

WHEEL MOVE

Universal Parts

STEEL CLEATS



Galvanized.

NOTE: Box Quantity of 500

DESIGNATION	WT. PER 10
WC-11-3	2.25 lbs

3/8" x 1" CAP SCREWS AND NUTS



There are 1,200 bolts and 4,000 nuts in a keg.

SIZE	DESIGNATION	WT. PER WHL
3/8" x 1"	C 1 3/8 x 1	1.50 lbs
3/8" hex	N 1 3/8	

WIND BRACE



SIZE	DESIGNATION	WT.
4"5'	WWB 405	8.30 lbs
4"6' & 7'	WWB 407	9.80
5"5'	WWB 505	8.90
5"6' & 7'	WWB 507	9.80

RATCHETED LINE ANCHOR STABILIZER BAR

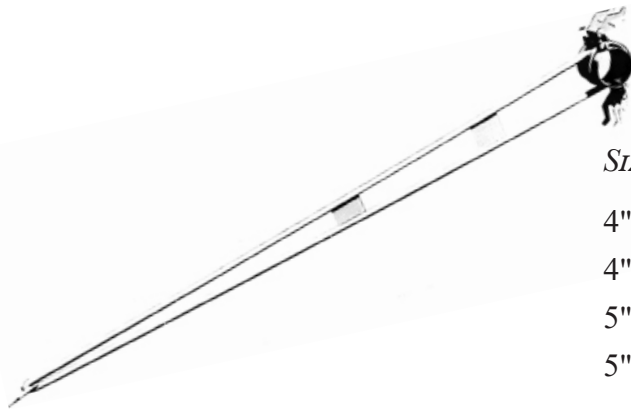

SIZE	DESIGNATION	WT.
4"5'	22-4-57	28.6 lbs
4"6' & 7'	22-4-76	29.8
5"5'	22-5-57	31.3
5"6' & 7'	22-5-76	32.1

SEE PARTS BREAKDOWN FOR MOVERS ON PAGES 19 - 22 OF THIS SECTION

Product of: TRAVIS PATTERN & FOUNDRY INC., SPOKANE, WASHINGTON

Prices: SUBJECT TO CHANGE WITHOUT NOTICE

FAX: (509) 467-6465 - PHONE: (509) 466-3545

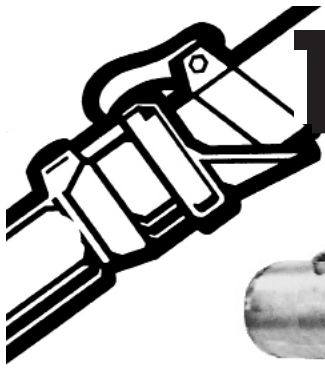

TRAVIS

WHEEL MOVE

ALUMINUM QUICK DISCONNECT COUPLER



SIZE	DESIGNATION	WT.
4"	CX 4463	8.00 lbs
5"	CX 5563	8.20

Square O-ring Standard. – PN 200470
 Includes heavy duty steel ring-lock clamp,
 and flapper type drain valve.
 Has 1" riser outlet. Press bands not included in price.



**** This part is for A & M wheel lines only**

MALE COUPLER

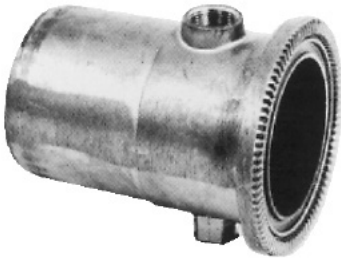

SIZE	DESIGNATION	WT.
4"	C 4463M	3.20 lbs
5"	C 5563M	3.40

Square O-ring gasket race standard. – PN 200470
 Includes flapper type drain valve.



**** This part is for A & M wheel lines only**

FEMALE COUPLER

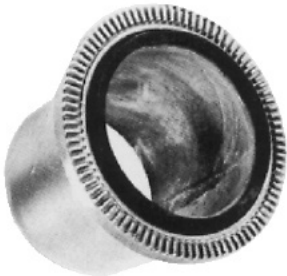

SIZE	DESIGNATION	WT.
4"	C 4463F	2.10 lbs
5"	C 5563F	2.00

Square O-ring standard.
 PN 200470



**** This part is for A & M wheel lines only**

HEAVY DUTY STEEL RING LOCK CLAMP



SIZE	DESIGNATION	WT.
—	RLT 4463	2.80 lbs



**** This part is for A & M wheel lines only**

Fits both 4" and 5" lateral roll couplers.

Product of: **TRAVIS PATTERN & FOUNDRY INC., SPOKANE, WASHINGTON**

Prices: SUBJECT TO CHANGE WITHOUT NOTICE

FAX: (509) 467-6465 - PHONE: (509) 466-3545

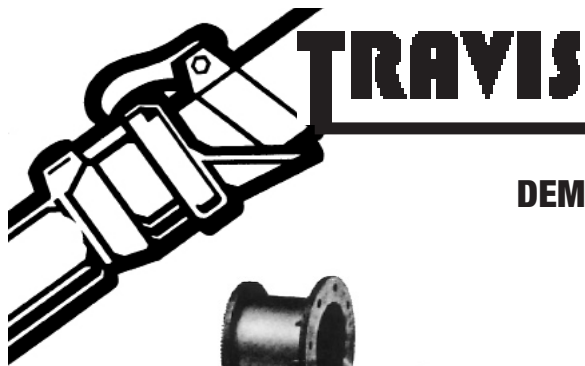

WHEEL MOVE

DEMOUNTABLE FLANGE ADAPTER

SIZE	DESIGNATION	WT.
4" x 5"	PMA 563	4.00 lbs

Square O-ring gasket race standard. Includes AMRAD 4G Flat Gasket.

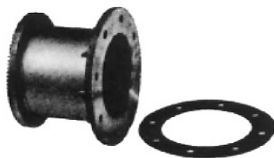

AM ** This part is for A & M wheel lines only

FLUSHING END PLUG

SIZE	DESIGNATION	WT.
4"	WEPV 4463M	6.10 lbs
4"	WEPV 4463F	5.10

Square O-ring standard. **Does not** include ring-lock clamp. Fits 4" and 5" couplers. Permits flushing of line without shutting off pressure.



WEPV 4463M

WEPV 4463F

AM ** This part is for A & M wheel lines only

ALUMINUM HOSE AND TELESCOPE ADAPTERS

SIZE	DESIGNATION	WT.
4" x 3"	MA 4363	2.10 lbs
4" x 4"	MA 4463	1.50
5" x 4"	MA 5463	3.20
5" x 5"	MA 5563	2.80
4" x 3"	FA 4363	2.50
4" x 4"	FA 4463	3.30
5" x 4"	FA 5463	3.20
5" x 5"	FA 5563	3.80

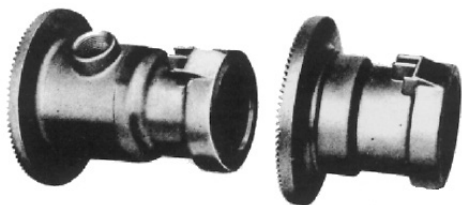

MA

FA

Square O-ring & Drain gasket included.

AM ** This part is for A & M wheel lines only

MALE ALUMINUM HOSE END

SIZE	DESIGNATION	WT.
4"	HAX 44	3.00 lbs

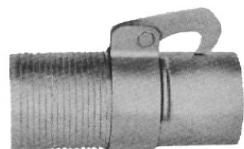

Includes one band and latch assembly.



** This part is for A & M wheel lines only

CENTER FEED TEE

SIZE	DESIGNATION	WT.
—	T 55463	15.50 lbs

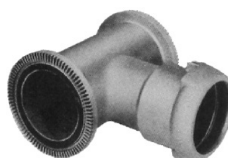

Includes 1 square O-ring & 1 non-drain gasket.

Fits 4" and 5" couplers. Used when wheel line straddles the mainline.



** This part is for A & M wheel lines only

Product of: TRAVIS PATTERN & FOUNDRY INC., SPOKANE, WASHINGTON

Prices: SUBJECT TO CHANGE WITHOUT NOTICE

FAX: (509) 467-6465 - PHONE: (509) 466-3545

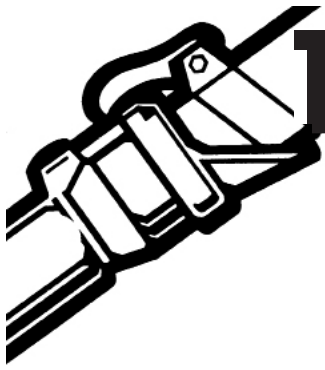

O RINGS

<i>PART No.</i>	<i>DESCRIPTION</i>	<i>FITS</i>	<i>SIZE</i>
ORG	Travis/Western Round	Travis/Western Aluminum	4 7/8" OD X 4 1/2" ID
NOTE: ORG Box Quantity of 200			
200463	A& M Round	A& M Round	5" OD X 4 3/8" ID
200470	A& M Square	A& M Square	5" OD X 4 1/2" ID
200424	Trunnell Quad	Trunnell 4" steel Approx. 4 ³ / ₈ " ctr. to ctr.	4 7/8" OD X 4 3/8" ID
200425	Trunnell Quad	Trunnell 5" steel Approx. 5 ¹ / ₂ " ctr. to ctr.	5 7/8" OD X 5 1/4" ID
200426	Trunnell Quad	Trunnell 4" & 5" Aluminum Approx. 4 ³ / ₄ " ctr. to ctr.	5" OD X 4 1/2" ID
300464	Western	Western Steel	5 " OD X 4 3/4" ID

Product of: **TRAVIS PATTERN & FOUNDRY INC., SPOKANE, WASHINGTON**

Prices: SUBJECT TO CHANGE WITHOUT NOTICE

FAX: (509) 467-6465 - PHONE: (509) 466-3545

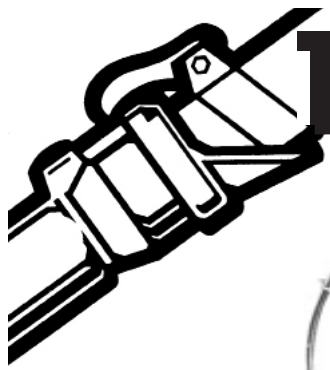

TRAVIS

WHEEL MOVE

WESTERN AND A & M HYDRAULIC MOVER PARTS

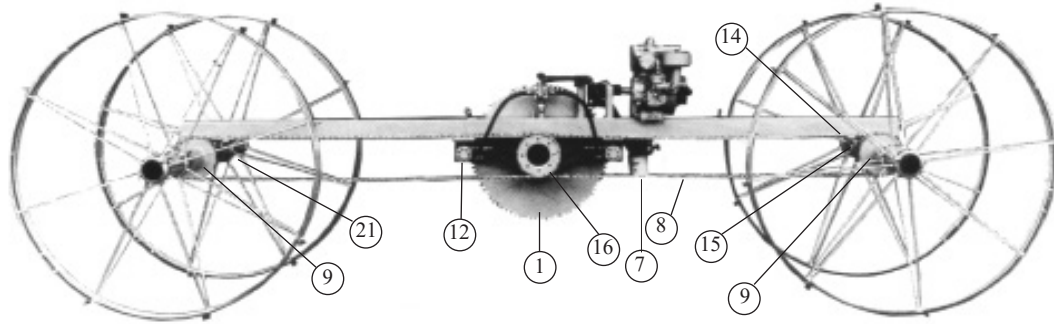

Vertical shaft to horizontal shaft engine conversion kits available consult factory.

ITEM No.	PART No.	DESCRIPTION
1	113046	Bull gear
2	113044	Orbit motor gear
3	113081	Hydraulic control valve assembly
3B	113010	Valve only
4	113083	Hydraulic pump assembly
4B	113011	Pump only
5	113309	4-J flange 1/2"
6	113260	1450 Series Briggs & Stratton & Engine
7	113016A	Canister filter only
7	113016	Canister filter assembly
8	113266	Roller chain no. 50
9	113070	Axle w/drive sprockets
10	113267	Breather cup
11	113308	4-J flange 1"
12	113013	Orbit motor K
13	113023	Discharge hose 3/8" x 20"
14	113186	Stringer adjust bolt
15	113072	Tail axle bearing assembly
16	113041	Standard main axle sprocket
17	117018	Hose 3/8" x 27"
18	GVB 3/4	3/4" shut off valve
19	113024	3/4" x 24" suction hose
21	113090	Nose axle bearing assembly
22	113282	4-J rubber sleeve
24	113228	Tee 1/2"
25	113235	Close nipple 1/2" sch 80
	113265	Flex coupling
	113550	Hinge replacement kit
	113199	Flat head orbit motor screw
	60023	Seal kit for Char-Lynn Series 7 orbit motor
	60036	Seal kit for Char-Lynn Series 5 orbit motor
	60540	Seal kit for Char-Lynn Series 9 orbit motor
	4144	Chain A2050 connecting link
	4153	Chain A2050 offset link
	113040	Nose and tail axle sprocket
	113015	Orbit Motor P
	113310	Complete Component Box
	TECH MM	Motor Mount Conversion Plate for Tech Engines
	6HP-SAE-AA-2	6HP C Face Pump Mount
	8HP-SAE-AA-2	8HP C Face Pump Mount
	113046A	2-8200 Single Rail Bull Gear Assembly
	CVR DOOR HNG	Cover Door Hinge Each
	CVR LATCH	Cover Rubber Latch Kit

Parts listed below fit Western Style movers manufactured prior to Sept. 1980

ITEM No.	PART No.	DESCRIPTION
7	117016	Flat filter
	117016S	Flat filter screen

Product of: **TRAVIS PATTERN & FOUNDRY INC., SPOKANE, WASHINGTON**

Prices: SUBJECT TO CHANGE WITHOUT NOTICE

FAX: (509) 467-6465 - PHONE: (509) 466-3545



TRAVIS

WHEEL MOVE

**WESTERN AND A & M HYDRAULIC MOVER PARTS
FOR MODELS MANUFACTURED IN 2004 OR LATER**

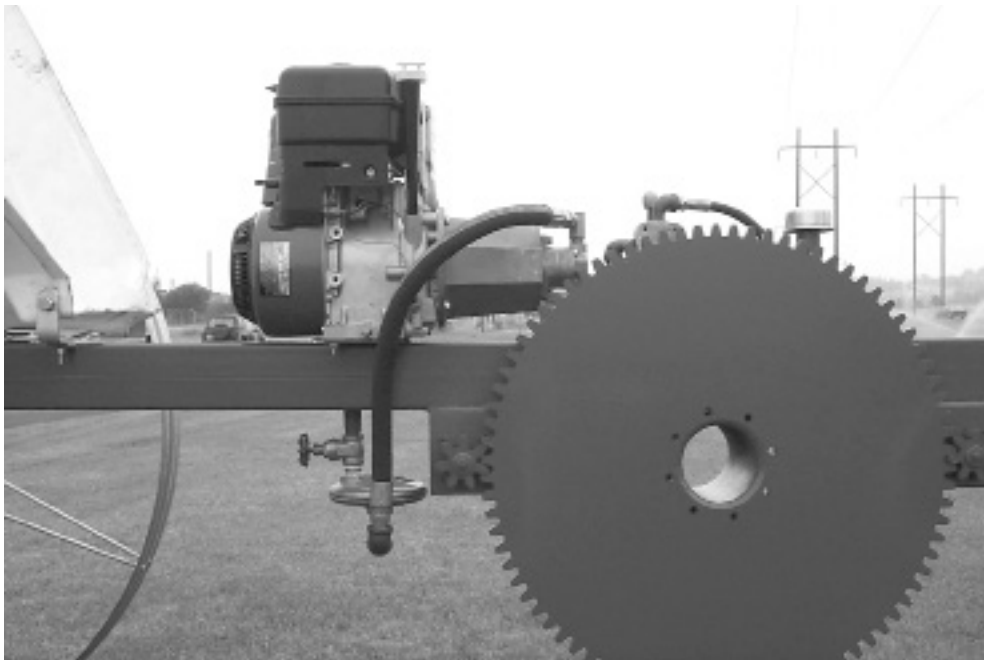

Product of: **TRAVIS PATTERN & FOUNDRY INC., SPOKANE, WASHINGTON**

Prices: SUBJECT TO CHANGE WITHOUT NOTICE

FAX: (509) 467-6465 - PHONE: (509) 466-3545

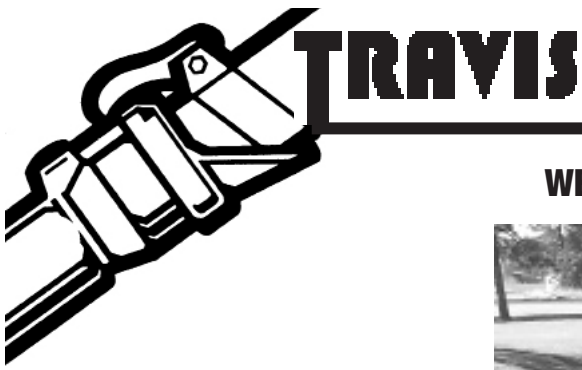

WHEEL MOVE

WESTERN AND A & M HYDRAULIC MOVER PARTS

All parts are the same as the standard 12' A & M and Western Mover, except for the ones listed below.



TWIN RAIN MOVER PARTS

<i>PART NO.</i>	<i>DESCRIPTION</i>
117016	Flat Filter
118023	$\frac{3}{8}$ " x 20" Hose (Connects pump to Valve)
118002	Power pack assembly (includes engine and pump assembly)
118260	Engine only (1450 Series Briggs & Stratton)
118266	Chains A2050 (154 pitch)
118072	Axle Bearing Assembly Left (Hole is on left side of bent portion of the plate when looking at the bearing assembly with the bent side closest to you.)
118090	Axle Bearing Assembly Right (Same as above only the hole is on the right side)
118070	Axle w/ Drive Sprockets (Standard length 6'8")
118046A	Twin Rail Bull Gear Assembly

Product of: **TRAVIS PATTERN & FOUNDRY INC., SPOKANE, WASHINGTON**

Prices: SUBJECT TO CHANGE WITHOUT NOTICE

FAX: (509) 467-6465 - PHONE: (509) 466-3545



TRAVIS

WHEEL MOVE

**WESTERN AND A & M HYDRAULIC MOVER PARTS
MODELS MANUFACTURED PRIOR TO 2004**

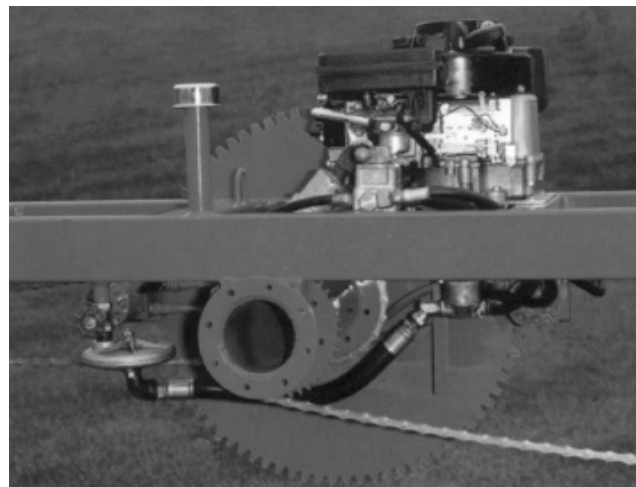
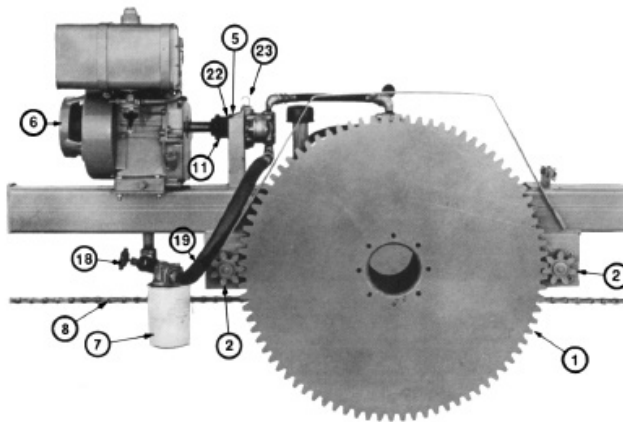
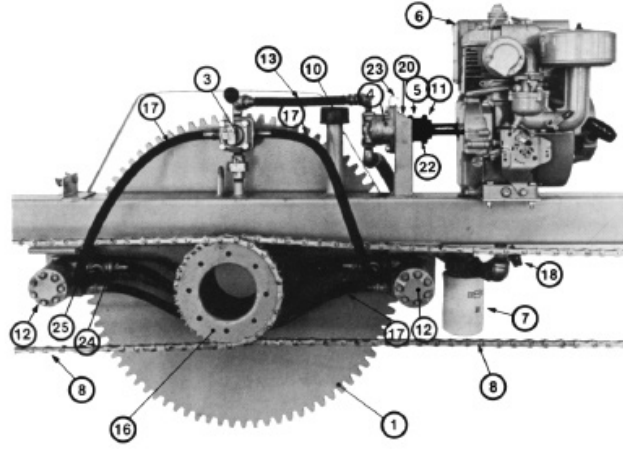

Product of: **TRAVIS PATTERN & FOUNDRY INC., SPOKANE, WASHINGTON**

Prices: SUBJECT TO CHANGE WITHOUT NOTICE

FAX: (509) 467-6465 - PHONE: (509) 466-3545



WHEEL MOVE

SINGLE RAIL MOVER ASSEMBLY

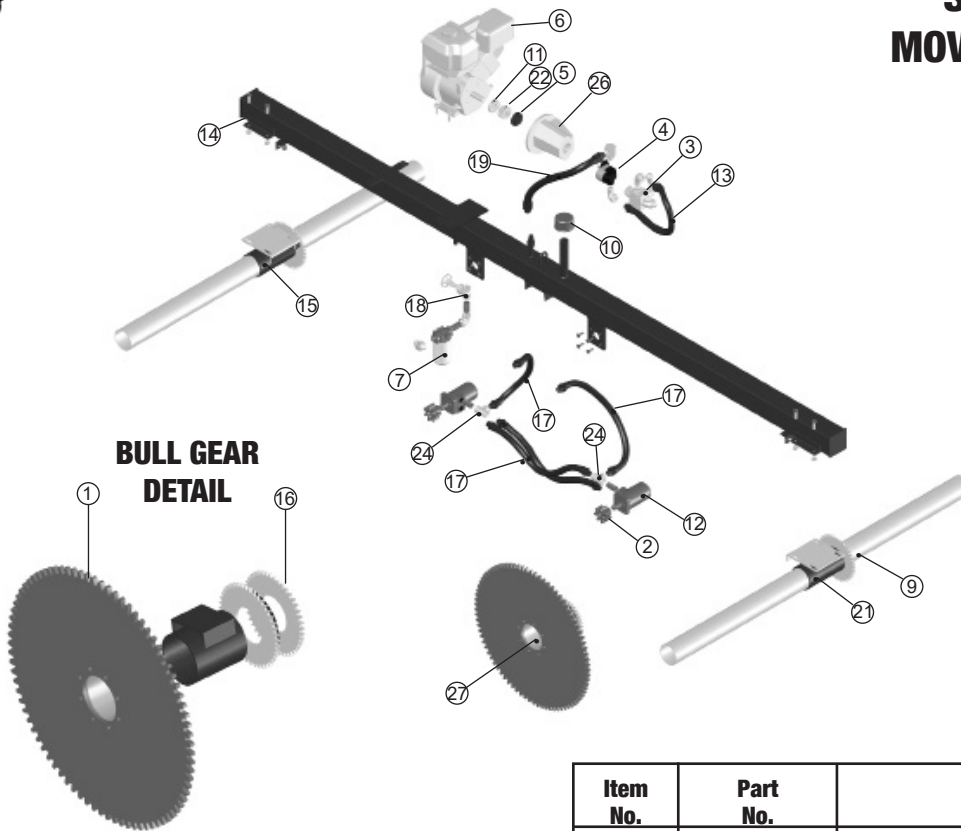

Item No.	Part No.	Description
1	113046	Bull gear
2	113044	Orbit motor gear
3	113081	Hydraulic control valve assem.
3B	113010	Valve only
4	113083	Hydraulic pump assem.
4B	113011	Pump only
5	113309	4-J Flange 1/2"
6	113260	1450 Series Briggs & Stratton Engine
7	113016	Canister filter assem.
8	113266	Roller chain #50 (not shown)
9	113070	Axle w/drive sprocket
10	113267	Breather cap
11	113308	4-J Flange 1"
12	113013	Orbit Motor K
13	113023	Discharge hose 3/8"x20"
14	113186	Stringer adjust. bolt
15	113072	Tail axle bearing assem.
16	113041	Standard main axle sprocket
17	117018	Hose 3/8"x27"

Item No.	Part No.	Description
18	GVB 3/4	3/4" Shut-off valve
19	113024	3/4"x24" suction hose
21	113090	Nose axle bearing assembly
22	113282	4-J Rubber sleeve
24	113228	Tee 1/2"
25	113235	Close nipple 1/2" sch 80
	113265	Flex coupling
	113550	Hinge replacement kit
	113199	Flat head orbit nose screw
	60023	Seal kit for Char-Lynn Series 7 orbit motor
	60036	Seal kit for Char-Lynn Series 5 orbit motor
	60540	Seal kit for Char-Lynn Series 9 orbit motor
	4144	Chain A2050 connecting link
	4153	Chain A2050 offset link
	113040	Nose and tail axle sprocket
	113015	Orbit Motor P
	113310	Complete component box
	Tech MM	Motor mount conversion plate for Tech Eng
26	6HP-SAE-AA-2	6HP C Face Pump Mount
26	8HP-SAE-AA-2	8HP C Face Pump Mount
27	113046A	Bull gear assembly

Product of: TRAVIS PATTERN & FOUNDRY INC., SPOKANE, WASHINGTON

Prices: SUBJECT TO CHANGE WITHOUT NOTICE

FAX: (509) 467-6465 - PHONE: (509) 466-3545

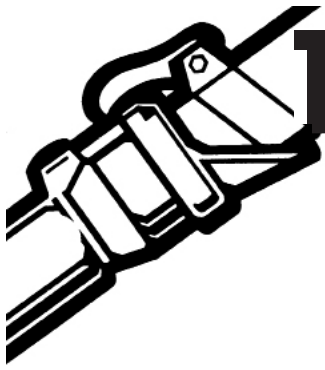

TRAVIS

WHEEL MOVE

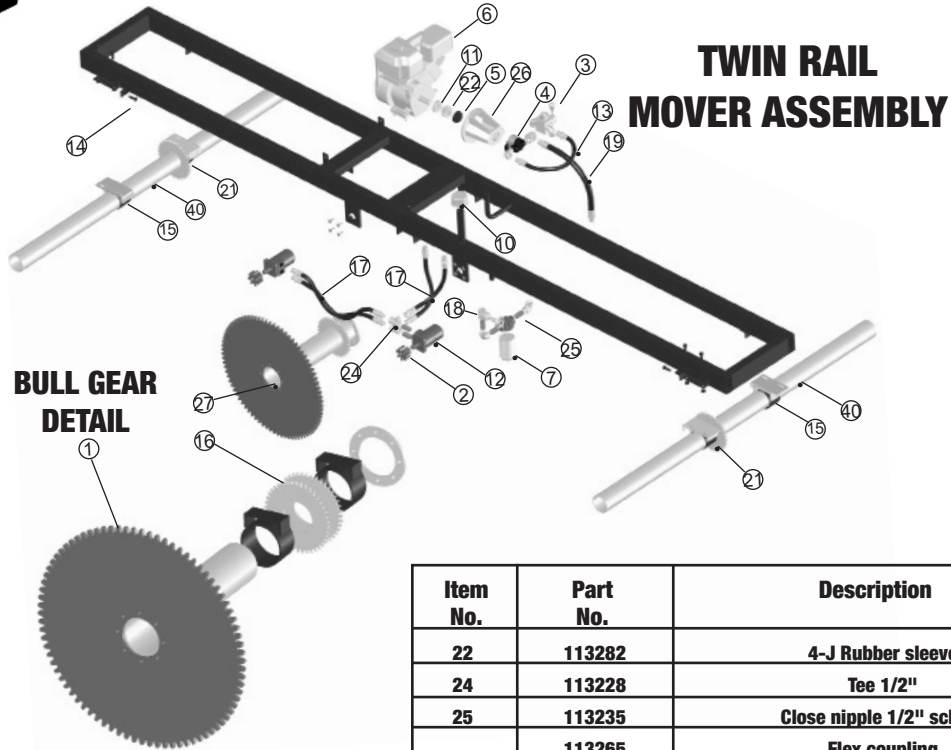

TWIN RAIL MOVER ASSEMBLY

BULL GEAR DETAIL

Item No.	Part No.	Description
1	113046	Bull gear
2	113044	Orbit motor gear
3	113081	Hydraulic control valve assem.
3B	113010	Valve only
4	113083	Hydraulic pump assem.
4B	113011	Pump only
5	113309	4-J Flange 1/2"
6	113260	1450 Series Briggs & Stratton Engine
7	113016	Canister filter assem.
8	118266	Roller chain #50 (not shown)
9	113070	Axle w/drive sprocket
10	113267	Breather cap
11	113308	4-J Flange 1"
12	113013	Orbit Motor K
13	113023	Discharge hose 3/8"x20"
14	113186	Stringer adjust. bolt
15	118072	Tail axle bearing assembly-left
16	113041	Standard main axle sprocket
17	117018	Hose 3/8"x27"
18	GVB 3/4	3/4" Shut-off valve
19	113024	3/4"x24" Suction hose
21	118090	Nose axle bearing assembly-right

Item No.	Part No.	Description
22	113282	4-J Rubber sleeve
24	113228	Tee 1/2"
25	113235	Close nipple 1/2" sch 80
	113265	Flex coupling
	113550	Hinge replacement kit
	113199	Flat head orbit nose screw
	60023	Seal kit for Char-Lynn Series 7 orbit motor
	60036	Seal kit for Char-Lynn Series 5 orbit motor
	60540	Seal kit for Char-Lynn Series 9 orbit motor
	4144	Chain A2050 connecting link
	4153	Chain A2050 offset link
	113040	Nose and tail axle sprocket
	113015	Orbit Motor P
	113310	Complete component box
	Tech MM	Motor mount conversion plate for Tech Eng
26	6HP-SAE-AA-2	6HP C Face Pump Mount
26	8HP-SAE-AA-2	8HP C Face Pump Mount
27	118046A	Bull gear assembly
	117016	Flat Filter
	118023	3/8"x20" hose (connects pump to valve)
	118002	Power pack assembly (includes engine and pump assembly)
	118260	Engine only (8HP)
	118266	Chains A2050 (154 pitch)
15	118072	Axle Bearing Assembly Left (Hole is on left side of bent portion of the plate when looking at the bearing assembly with the bent side closest to you.)
21	118090	Axle Bearing Assembly Right (as above, only with the hole is on right side)
40	118070	Axle with Drive Sprockets (Standard length 6'8")

All parts are the same as the standard 12' A&M and Western Mover, except for the ones listed on this page.

Product of: TRAVIS PATTERN & FOUNDRY INC., SPOKANE, WASHINGTON

Prices: SUBJECT TO CHANGE WITHOUT NOTICE

FAX: (509) 467-6465 - PHONE: (509) 466-3545



TRAVIS

WHEEL MOVE

3/4" BRASS AGRICULTURAL SPRINKLERS



WR-33



WR-32

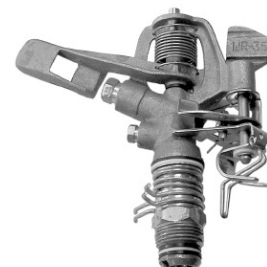

WR-35

NOTE: All sprinklers are double nozzle, but are shipped with the removable spreader nozzle plug installed and no range nozzle. All nozzles are ordered separately.

**See performance data on following pages.*

Part Number	Description	Weight	Pieces Per Box
WR-33	Brass Impact Sprinkler	1.0 lb	30/60
WR-32	Brass Sprinkler w/Aluminum Arm	1.0 lb	30/60
WR-35	Part-circle Adjustable Brass Sprinkler	1.4 lb	20

**See pages 5 and 6 in parts section for sprinkler parts.*

NOZZLES

Part Number	Description	GPM at 50 PSI	Application Rate (40 x 60)	Pieces Per Box
WR-7/64	7/64" Range Nozzle	2.45		30
WR-1/8	1/8" Range Nozzle	3.22		30
WR-9/64	9/64" Range Nozzle	4.07	.16"/hr	30
WR-5/32	5/32" Range Nozzle	4.98	.20"/hr	30
WR-11/64	11/64" Range Nozzle	6.01	.24"/hr	30
WR-3/16	3/16" Range Nozzle	7.16	.29"/hr	30
WR-13/64	13/64" Range Nozzle	8.45	.34"/hr	30
WR-7/32	7/32" Range Nozzle	9.90	.40"/hr	30
WR-1/4	1/4" Range Nozzle	12.80	.52"/hr	30
SSN-3/32	3/32" Spreader Nozzle	3.22		30
SSN-1/8	1/8" Spreader Nozzle	1.76		30
SNP	Spreader Nozzle Plug (included with sprinkler)			50
VANE	Stream Straightening Vane for Range Nozzle			100

Product of: **TRAVIS PATTERN & FOUNDRY INC., SPOKANE, WASHINGTON**

Prices: SUBJECT TO CHANGE WITHOUT NOTICE

FAX: (509) 467-6465 - PHONE: (509) 466-3545



TRAVIS

WHEEL MOVE

PERFORMANCE DATA



WR-33 BRASS IMPACT SPRINKLER

WR-33 SINGLE NOZZLE - 27 DEG. TRAJECTORY (NO VANE)

NOZ PSI	1/8"		9/64"		5/32"		11/64"		3/16"		13/64"		7/32"	
	GPM	DIA. FT.	GPM	DIA. FT.	GPM	DIA. FT.	GPM	DIA. FT.	GPM	DIA. FT.	GPM	DIA. FT.	GPM	DIA. FT.
25	—	—	2.88	80	3.52	82	4.24	83	5.0	85	5.90	86	6.85	88
30	—	—	3.15	81	3.85	85	4.64	88	5.5	91	6.50	94	7.55	96
35	—	—	3.40	82	4.16	87	5.02	90	6.0	94	7.05	97	8.20	100
40	—	—	3.64	83	4.45	88	5.37	92	6.4	96	7.55	99	8.80	102
45	3.05	82	3.86	84	4.72	89	5.70	94	6.8	98	8.00	101	9.35	104
50	3.22	83	4.07	85	4.98	90	6.01	95	7.2	100	8.45	103	9.90	106
55	3.38	84	4.27	86	5.22	91	6.30	96	7.5	101	8.85	104	10.40	107
60	3.53	85	4.46	87	5.45	92	6.57	97	7.9	102	9.25	105	10.75	108
65	3.68	86	4.65	88	5.68	93	6.83	98	8.2	103	9.60	106	11.10	109
70	3.82	86	4.83	89	5.90	94	7.09	99	8.5	104	9.95	107	11.40	110
75	3.96	87	5.00	90	6.11	95	7.34	100	8.8	105	10.25	108	11.70	111
80	4.09	87	5.17	91	6.30	96	7.58	101	9.1	106	10.50	109	12.00	112

WR-33 DOUBLE NOZZLE - 27 DEG. TRAJECTORY (NO VANE)

NOZ PSI	9/64"x 3/32"		5/32"x 3/32"		11/64"x 3/32"		3/16"x 3/32"		3/16"x 1/8"		13/64"x 1/8"		7/32"x 1/8"	
	GPM	DIA. FT.	GPM	DIA. FT.	GPM	DIA. FT.	GPM	DIA. FT.	GPM	DIA. FT.	GPM	DIA. FT.	GPM	DIA. FT.
25	4.18	80	4.83	82	5.55	83	6.31	85	7.40	85	8.30	86	9.25	88
30	4.58	81	5.28	85	6.07	88	6.93	91	8.15	91	9.15	94	10.20	96
35	4.95	82	5.71	87	6.57	90	7.51	94	8.83	94	9.93	97	11.10	100
40	5.29	83	6.11	88	7.03	92	8.03	96	9.46	96	10.65	99	11.90	102
45	5.61	84	6.48	89	7.46	94	8.53	98	10.05	98	11.30	101	12.65	104
50	5.91	85	6.82	90	7.87	95	9.00	100	10.60	100	11.90	103	13.35	106
55	6.20	86	7.15	91	8.25	96	9.45	101	11.10	101	12.50	104	14.00	107
60	6.48	87	7.47	92	8.60	97	9.86	102	11.60	102	13.00	105	14.50	108
65	6.75	88	7.78	93	8.93	98	10.27	103	12.10	103	13.50	106	15.00	109
70	7.00	89	8.08	94	9.25	99	10.66	104	12.50	104	14.00	107	15.45	110
75	7.25	90	8.37	95	9.56	100	11.02	105	12.90	105	14.40	108	15.90	111
80	7.49	91	8.65	96	9.87	101	11.36	106	13.25	106	14.80	109	16.30	112

NOTE:

- * Optional straightening vane will increase diameters by 4-8% at pressures of 40 psi and above.
- * Highest point of stream is 8 ft. above nozzle with 1/8" nozzle at normal operating pressure.
- * Performance stated at base pressure.

Product of: **TRAVIS PATTERN & FOUNDRY INC., SPOKANE, WASHINGTON**

Prices: SUBJECT TO CHANGE WITHOUT NOTICE

FAX: (509) 467-6465 - PHONE: (509) 466-3545



TRAVIS

WHEEL MOVE

PERFORMANCE DATA



WR-32 BRASS IMPACT SPRINKLER
ALUMINUM ARM FOR LOW
GALLONAGE APPLICATIONS

WR-32 SINGLE NOZZLE - ALUMINUM ARM

NOZ PSI	7/64"		1/8"		9/64"	
	GPM	DIA. FT.	GPM	DIA. FT.	GPM	DIA. FT.
25	1.73	77	2.25	78	2.88	80
30	1.89	78	2.47	79	3.15	81
35	2.05	78	2.68	80	3.40	82
40	2.19	79	2.87	81	3.64	83
45	2.32	80	3.05	82	3.86	84
50	2.45	80	3.22	83	4.07	85
55	2.57	81	3.38	84	4.27	86
60	2.68	82	3.53	85	4.46	87
65	2.79	82	3.68	86	4.65	88
70	2.90	83	3.82	86	4.83	89
75	3.00	83	3.96	87	5.00	90
80	3.10	84	4.09	87	5.17	91

WR-32 SINGLE NOZZLE - ALUMINUM ARM WITH STRAIGHTENING VANE

NOZ PSI	7/64"		1/8"		9/64"	
	GPM	DIA. FT.	GPM	DIA. FT.	GPM	DIA. FT.
25	1.73	78	2.25	82	2.88	85
30	1.89	79	2.47	84	3.15	87
35	2.05	80	2.68	85	3.40	89
40	2.19	81	2.87	86	3.64	91
45	2.32	82	3.05	87	3.86	92
50	2.45	83	3.22	88	4.07	93
55	2.57	84	3.38	89	4.27	94
60	2.68	85	3.53	90	4.46	95
65	2.79	86	3.68	91	4.65	96
70	2.90	87	3.82	92	4.83	97
75	3.00	88	3.96	93	5.00	98
80	3.10	89	4.09	94	5.17	100

Product of: **TRAVIS PATTERN & FOUNDRY INC., SPOKANE, WASHINGTON**

Prices: SUBJECT TO CHANGE WITHOUT NOTICE

FAX: (509) 467-6465 - PHONE: (509) 466-3545

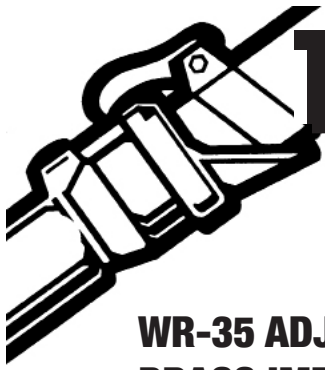

TRAVIS

WHEEL MOVE

PERFORMANCE DATA



WR-35 ADJUSTABLE PART-CIRCLE BRASS IMPACT SPRINKLER

WR-35 SINGLE NOZZLE - 25 DEG. TRAJECTORY (NO VANE)

NOZ PSI	5/23"		11/64"		3/16"		13/64"		7/32"	
	GPM	DIA. FT.	GPM	DIA. FT.	GPM	DIA. FT.	GPM	DIA. FT.	GPM	DIA. FT.
30	3.85	84	4.64	87	5.5	89	6.50	96	7.55	94
35	4.16	85	5.02	88	5.96	92	7.05	95	8.20	96
40	4.45	87	5.37	90	6.38	94	7.55	97	8.80	98
45	4.72	88	5.70	92	6.78	96	8.00	99	9.35	100
50	4.98	89	6.01	93	7.16	98	8.45	101	9.90	102
55	5.22	90	6.30	94	7.52	100	8.85	102	10.40	104
60	5.45	91	6.57	96	7.85	101	9.25	103	10.75	105
65	5.68	92	6.83	97	8.18	102	9.60	104	11.10	106
70	5.90	93	7.09	98	8.50	103	9.95	105	11.40	107

WR-35 DOUBLE NOZZLE - 25 DEG. TRAJECTORY (NO VANE)

NOZ PSI	9/64"x 3/32"		5/32"x 3/32"		11/64"x 3/32"		3/16"x 3/32"		3/16"x 1/8"		13/64"x 1/8"		7/32"x 1/8"	
	GPM	DIA. FT.	GPM	DIA. FT.	GPM	DIA. FT.	GPM	DIA. FT.	GPM	DIA. FT.	GPM	DIA. FT.	GPM	DIA. FT.
30	4.58	80	5.28	84	6.07	87	6.93	89	8.15	89	9.15	93	10.20	94
35	4.95	81	5.71	85	6.57	88	7.51	92	8.83	92	9.93	95	11.10	96
40	5.29	82	6.11	87	7.03	90	8.03	94	9.46	94	10.65	97	11.90	98
45	5.61	83	6.48	88	7.46	92	8.53	96	10.05	96	11.30	99	12.65	100
50	5.91	84	6.82	89	7.87	93	9.00	98	10.60	98	11.90	101	13.35	102
55	6.20	85	7.15	90	8.25	94	9.45	100	11.10	100	12.50	102	14.00	104
60	6.48	86	7.47	91	8.60	96	9.86	101	11.60	101	13.00	103	14.50	105
65	6.75	87	7.78	92	8.93	97	10.27	102	12.10	102	13.50	104	15.00	106
70	7.00	88	8.08	93	9.25	98	10.66	103	12.50	103	14.00	105	15.45	107

NOTE:

- * Optional straightening vane will increase diameters by 4-8% at pressures of 40 psi and above.
- * Highest point of stream is 7 ft. above nozzle with 1/8" nozzle at normal operating pressure.
- * Performance stated at base pressure.

Product of: **TRAVIS PATTERN & FOUNDRY INC., SPOKANE, WASHINGTON**

Prices: SUBJECT TO CHANGE WITHOUT NOTICE

FAX: (509) 467-6465 - PHONE: (509) 466-3545