

# TRAVIS

# STEEL

\*Western Style Available — See Western Section  
**LATERAL COUPLER SET — GALVANIZED**

Includes Band and Latch Assembly and Round Back Gasket

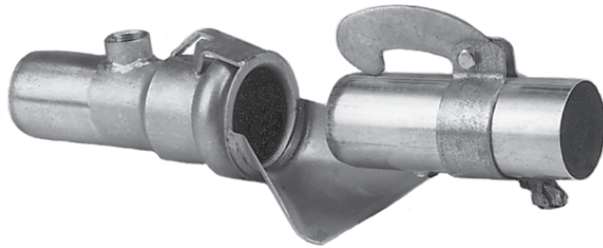

SIZE	DESIGNATION	WT.
2"	BLCR200	3.00 lbs
3"	BLCR300	4.50
4"	BLCR400	6.00

\*1" Outlet Standard, 3/4" Available upon request.

## STEEL BAND AND LATCH COUPLER SET

Press on Steel Band and Latch Mainline Sets Galvanized, includes Band and Latch.



SIZE	WT.	DESIGNATION	PRICE	WITH PAN DESIGNATION
2"	3.00 lbs	BLS200	\$ 21.56	BLSP200
3"	4.50	BLS300	21.80	BLSP300
4"	5.25	BLS400	27.92	BLSP400
5"	6.00	BLS500	37.17	BLSP500
6"	7.50	BLS600	45.70	BLSP600
7"	10.00	BLS700	56.90	
8"	12.50	BLS800	64.04	

## STEEL BAND AND LATCH — COUPLER ONLY

Press on Steel Mainline — Coupler only with gasket Galvanized

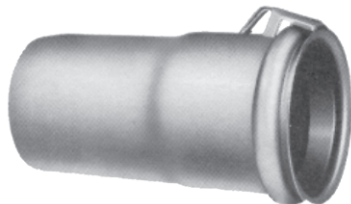

SIZE	DESIGNATION	WT.
2"	S200	2.00 lbs
3"	S300	3.00
4"	S400	4.00
5"	S500	5.00
6"	S600	6.50
7"	S700	8.00
8"	S800	10.00

Product of: **TRAVIS PATTERN & FOUNDRY INC., SPOKANE, WASHINGTON**

Prices: SUBJECT TO CHANGE WITHOUT NOTICE

**FAX: (509) 467-6465 - PHONE: (509) 466-3545**

Prices effective: August 2008

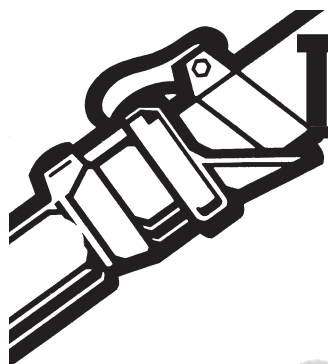

# TRAVIS

# STEEL

## STEEL BAND AND LATCH UNIVERSAL VALVE T SET

Press on Steel Universal Valve Sets with Stabilizer Foot — includes press in T, gasket and Band Latch

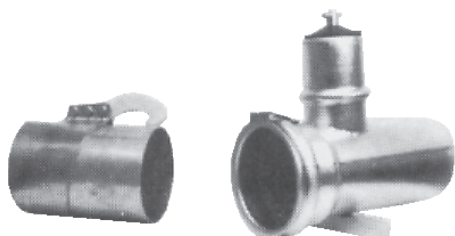

SIZE	DESIGNATION	WT.
3" x 3"	BLSUVT333	8.00 lbs
4" x 4"	BLSUVT444	10.00
5" x 4"	BLSUVT554	12.00
6" x 4"	BLSUVT664	14.00
7" x 4"	BLSUVT774	17.00
8" x 4"	BLSUVT884	20.00

\*for other sizes — contact factory

## STEEL BAND & LATCH IN-LINE VALVE T SET

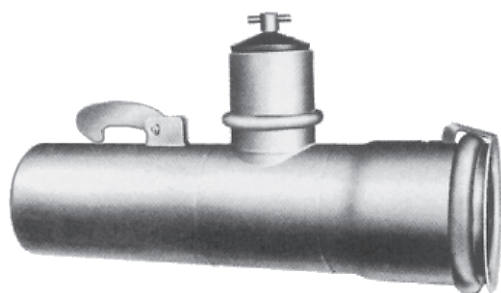

SIZE	DESIGNATION	WT.
3" x 3"	BLSUVT-L333	9.00 lbs
4" x 4"	BLSUVT-L444	10.00
5" x 4"	BLSUVT-L554	14.00
6" x 4"	BLSUVT-L664	18.00
7" x 4"	BLSUVT-L774	22.00
8" x 4"	BLSUVT-L884	24.00

## BAND AND LATCH FIELD TEE (Line Tee)

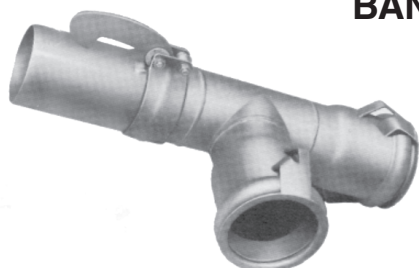

Connects to band and latch  
mainline for side take-off

SIZE	DESIGNATION	WT.
2"	BLSFT200	6.00 lbs
3"	BLSFT300	8.00
4"	BLSFT400	12.00
5"	BLSFT500	16.00
6"	BLSFT600	20.00
7"	BLSFT700	25.00
8"	BLSFT800	35.00

## BAND AND LATCH END TEE



90° take-off both directions  
- end of line

SIZE	DESIGNATION	WT.
2"	BLSET200	6.00 lbs
3"	BLSET300	8.00
4"	BLSET400	12.00
5"	BLSET500	14.00
6"	BLSET600	18.00
7"	BLSET700	23.00
8"	BLSET800	33.00

Product of: **TRAVIS PATTERN & FOUNDRY INC., SPOKANE, WASHINGTON**

Prices: SUBJECT TO CHANGE WITHOUT NOTICE

**FAX: (509) 467-6465 - PHONE: (509) 466-3545**

Prices effective: August 2008

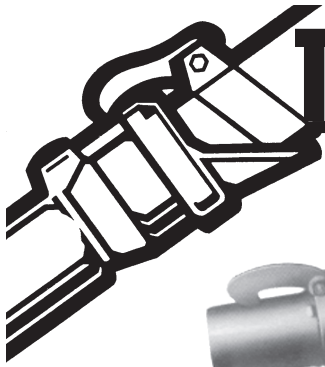

# TRAVIS

# STEEL

## 45° STEEL BAND AND LATCH ELBOW

45° elbow for band and latch lines



SIZE	DESIGNATION	WT.
2"	BLSFE-200-45	4.00 lbs
3"	BLSFE-300-45	5.00
4"	BLSFE-400-45	6.00
5"	BLSFE-500-45	7.00
6"	BLSFE-600-45	8.00
7"	BLSFE-700-45	12.00
8"	BLSFE-800-45	16.00

## 90° STEEL BAND AND LATCH ELBOW

90° elbow for band and latch lines



SIZE	DESIGNATION	WT.
2"	BLSFE200	4.00 lbs
3"	BLSFE300	5.00
4"	BLSFE400	7.00
5"	BLSFE500	9.00
6"	BLSFE600	10.00
7"	BLSFE700	15.00
8"	BLSFE800	19.00

## BAND AND LATCH REDUCER

Increasesers also available - contact factory

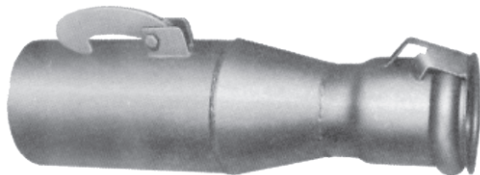

SIZE	DESIGNATION	WT.
2" x 3"	BLSR203	4.00 lbs
3" x 4"	BLSR304	6.00
4" x 5"	BLSR405	7.00
4" x 6"	BLSR406	9.00
5" x 6"	BLSR506	10.00
6" x 7"	BLSR607	11.50
6" x 8"	BLSR608	13.00
7" x 8"	BLSR708	16.00

## BAND AND LATCH END PLUGS

End Plug for band & latch lines.



SIZE	DESIGNATION	WT.
2"	BLSEP200	2.50 lbs
3"	BLSEP300	2.50
4"	BLSEP400	3.50
5"	BLSEP500	4.50
6"	BLSEP600	5.50
7"	BLSEP700	8.00
8"	BLSEP800	10.00

Product of: **TRAVIS PATTERN & FOUNDRY INC., SPOKANE, WASHINGTON**

Prices: SUBJECT TO CHANGE WITHOUT NOTICE

**FAX: (509) 467-6465 - PHONE: (509) 466-3545**

Prices effective: August 2008



# TRAVIS

# STEEL

## RING LOCK MAINLINE COUPLER SET, GALVANIZED



Includes press in female, male,  
gasket and clamp.

<i>SIZE</i>	<i>DESIGNATION</i>	<i>Wt.</i>
3"	SRL300	5.00 lbs
4"	SRL400	6.50
5"	SRL500	9.00
6"	SRL600	10.00
7"	SRL700	13.00
8"	SRL800	17.50
10"	SRL1000	25.00
12"	SRL1200	31.00

Hold bands recommended

## RING LOCK FEMALE COUPLER — (GALVANIZED)



Press in female, includes gasket

<i>SIZE</i>	<i>DESIGNATION</i>	<i>Wt.</i>
3"	SRL-F300	2.00 lbs
4"	SRL-F400	2.50
5"	SRL-F500	3.50
6"	SRL-F600	4.00
7"	SRL-F700	5.50
8"	SRL-F800	8.00
10"	SRL-F1000	10.50
12"	SRL-F1200	15.00

## RING LOCK MALE COUPLER — (GALVANIZED)

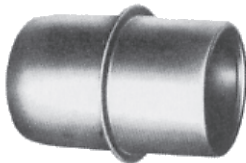

Press in male coupler

<i>SIZE</i>	<i>DESIGNATION</i>	<i>Wt.</i>
3"	SRL-M300	2.00 lbs
4"	SRL-M400	2.50
5"	SRL-M500	3.50
6"	SRL-M600	4.00
7"	SRL-M700	5.00
8"	SRL-M800	7.00
10"	SRL-M1000	11.00
12"	SRL-M1200	14.00

Product of: **TRAVIS PATTERN & FOUNDRY INC., SPOKANE, WASHINGTON**

Prices: SUBJECT TO CHANGE WITHOUT NOTICE

**FAX: (509) 467-6465 - PHONE: (509) 466-3545**

Prices effective: August 2008

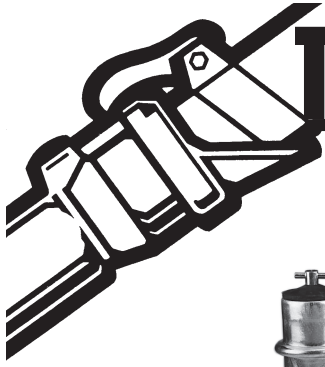

# TRAVIS

# STEEL

## UNIVERSAL VALVE TEE

\*Hold band recommended.

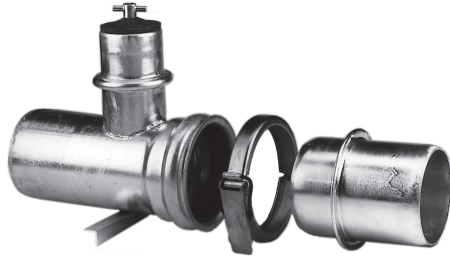

Press in valve T, male press in end gasket and clamp.

SIZE	DESIGNATION	WT.
3" x 3"	SRLUVT333	14.00
4" x 4"	SRLUVT444	17.00
5" x 4"	SRLUVT554	21.00
6" x 4"	SRLUVT664	23.00
7" x 4"	SRLUVT774	30.00
8" x 4"	SRLUVT884	35.00
10" x 4"	SRLUVT10104	50.00
12" x 4"	SRLUVT12124	52.00

## UNIVERSAL RING LOCK IN LINE VALVE TEE

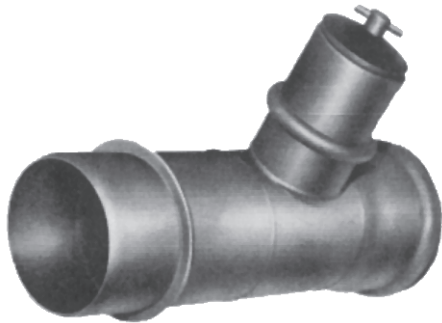

SIZE	DESIGNATION	WT.
4" x 4"	SRLUVT-L444	11.00 lbs
5" x 4"	SRLUVT-L554	12.00
6" x 4"	SRLUVT-L664	21.00
7" x 4"	SRLUVT-L774	26.00
8" x 4"	SRLUVT-L884	29.00
10" x 4"	SRLUVT-L10104	33.00
12" x 4"	SRLUVT-L12124	43.00

## HIGH PRESSURE RING LOCK CLAMP



FITS STEEL ONLY

FITS STEEL ONLY

SIZE	DESIGNATION	WT.
3"	HPRLC300	1.40 lbs
4"	HPRLC400	1.60
5"	HPRLC500	1.80
6"	HPRLC600	2.00
7"	HPRLC700	2.25
8"	HPRLC800	2.50
10"	HPRLC1000	3.50
10"	HPRLC1000 S	3.50
12"	HPRLC1200	5.25
12"	HPRLC1200 S	5.25

## HOLD BANDS



STEEL ITEM #	ALUM. ITEM #	WT. PER 100 ALUM.	WT. PER 100 STEEL	SIZE
	HB-300	—	—	—
SHB-4	HB-400	13.00 lbs	30.00 lbs	4"
SHB-5	HB-500	16.00	38.00	5"
	HB-600	19.00	50.00	6"
	HB-800	44.00	75.00	8"
SHB-10	HB-1000	63.00	88.00	10"
SHB-12	HB-1200	—	100.00	12"

Product of: **TRAVIS PATTERN & FOUNDRY INC., SPOKANE, WASHINGTON**

Prices: SUBJECT TO CHANGE WITHOUT NOTICE

**FAX: (509) 467-6465 - PHONE: (509) 466-3545**

Prices effective: August 2008

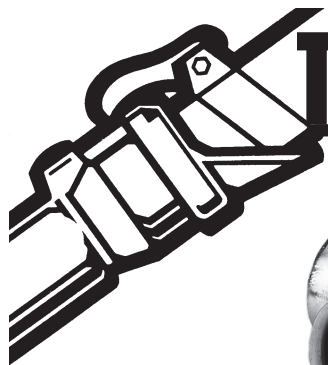

# TRAVIS

# STEEL

## RING LOCK FIELD T



Couples to mainline for side outlet  
take off gaskets included

SIZE	DESIGNATION	WT.
3"	SRLFT300	8.00 lbs
4"	SRLFT400	9.00
5"	SRLFT500	12.00
6"	SRLFT600	13.00
7"	SRLFT700	15.00
8"	SRLFT800	20.00
10"	SRLFT1000	33.00
12"	SRLFT1200	44.00

## RING LOCK END T



Galvanized, 90° take off  
both directions

SIZE	DESIGNATION	WT.
3"	SRLET300	8.00 lbs
4"	SRLET400	9.00
5"	SRLET500	12.00
6"	SRLET600	13.00
7"	SRLET700	15.00
8"	SRLET800	21.00
10"	SRLET1000	34.00
12"	SRLET1200	44.00

## STEEL RING LOCK FITTINGS 45° ELBOW



Steel ringlock 45° elbow standard

SIZE	DESIGNATION	WT.
3"	SRLFE300-45	5.00 lbs
4"	SRLFE400-45	6.00
5"	SRLFE500-45	7.00
6"	SRLFE600-45	9.00
7"	SRLFE700-45	13.00
8"	SRLFE800-45	16.00
10"	SRLFE1000-45	19.00
12"	SRLFE1200-45	26.00

## STEEL RING LOCK FITTINGS 90° ELBOW



Steel ringlock 90° elbow standard

SIZE	DESIGNATION	WT.
3"	SRLFE300	6.00 lbs
4"	SRLFE400	7.00
5"	SRLFE500	8.00
6"	SRLFE600	11.00
7"	SRLFE700	16.00
8"	SRLFE800	18.00
10"	SRLFE1000	22.00
12"	SRLFE1200	30.00

Product of: **TRAVIS PATTERN & FOUNDRY INC., SPOKANE, WASHINGTON**

Prices: SUBJECT TO CHANGE WITHOUT NOTICE

**FAX: (509) 467-6465 - PHONE: (509) 466-3545**

Prices effective: August 2008



# TRAVIS

# STEEL

## R-LOCK REDUCER

INCREASERS ALSO AVAILABLE.  
CONTACT FACTORY.



Gasket included connect  
larger diameter line to smaller

\*Other sizes available - contact factory

SIZE	DESIGNATION	WT.
4" x 3"	SRLR304	4.00 lbs
5" x 4"	SRLR405	5.00
5" x 6"	SRLR506	6.00
4" x 6"	SRLR406	7.00
6" x 7"	SRLR607	8.00
6" x 8"	SRLR608	10.00
6" x 10"	SRLR610	14.00
7" x 8"	SRLR708	12.00
8" x 10"	SRLR810	15.00
10" x 12"	SRLR1012	19.00

## R-LOCK END PLUG



SIZE	DESIGNATION	WT.
3"	SRLEP300	3.00 lbs
4"	SRLEP400	3.75
5"	SRLEP500	4.50
6"	SRLEP600	5.00
7"	SRLEP700	6.00
8"	SRLEP800	7.00
10"	SRLEP1000	13.00
12"	SRLEP1200	17.00

## ROUND BACK GASKETS

Gaskets for Rainway Steel Couplers  
(interchangeable with Pierce)

**FOR FULL BOX QUANTITIES ADD "FB" TO END OF PART NUMBER**

**example-E-3 2" FB**

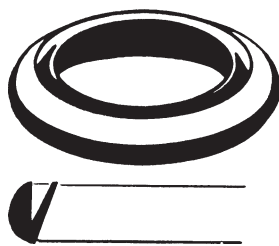

**E-3**

SIZE	DESIGNATION	APPROX. FULL BOX QTY.
2"	E-3 2"	900
3"	E-3 3"	500
4"	E-3 4"	250
5"	E-3 5"	200
6"	E-3 6"	150
7"	E-3 7"	150
8"	E-3 8"	100
10"	E-3 10"	100
12"	E-3 12"	75

Product of: **TRAVIS PATTERN & FOUNDRY INC., SPOKANE, WASHINGTON**

Prices: SUBJECT TO CHANGE WITHOUT NOTICE

**FAX: (509) 467-6465 - PHONE: (509) 466-3545**

Prices effective: August 2008



# STEEL

## R-LOCK DISCHARGE ADAPTOR



Connects pump to ringlock mainline

\*Available with flange — Contact factory.

SIZE	DESIGNATION	WT.
4" x 4"	SRLDA404	7.00 lbs
4" x 5"	SRLDA405	8.00
4" x 6"	SRLDA406	10.00
5" x 5"	SRLDA505	9.00
5" x 6"	SRLDA506	10.00
5" x 8"	SRLDA508	14.00
6" x 6"	SRLDA606	15.00
6" x 8"	SRLDA608	16.00
6" x 10"	SRLDA610	20.00
8" x 8"	SRLDA808	17.00
8" x 10"	SRLDA810	22.00

## BAND AND LATCH DISCHARGE ADAPTOR (Steel Nipple)



\*Please specify if for flange.  
Other sizes available upon request.

SIZE	DESIGNATION	WT.
2" x 3"	BLSDA203	3.00 lbs
3" x 3"	BLSDA303	4.00
3" x 4"	BLSDA304	5.00
4" x 4"	BLSDA404	6.00
4" x 5"	BLSDA405	7.00
4" x 6"	BLSDA406	9.00
4" x 7"	BLSDA407	11.00
5" x 5"	BLSDA505	7.00
5" x 6"	BLSDA506	9.00
5" x 7"	BLSDA507	12.00
5" x 8"	BLSDA508	14.00
6" x 6"	BLSDA606	15.00
6" x 7"	BLSDA607	16.00
6" x 8"	BLSDA608	17.00

## SUCTION ADAPTOR — STEEL\*



Connects pump to suction line

\*Other sizes available upon request.  
Please specify if for flange.

SIZE	DESIGNATION	WT.
3" x 3"	SSA3003	4.00 lbs
3" x 4"	SSA3004	4.00
4" x 4"	SSA4004	5.00
4" x 5"	SSA4005	7.00
4" x 6"	SSA4006	8.00
4" x 7"	SSA4007	10.00
5" x 5"	SSA5005	8.00
5" x 6"	SSA5006	9.00
5" x 7"	SSA5007	10.00
5" x 8"	SSA5008	12.00
6" x 6"	SSA6006	13.00
6" x 7"	SSA6007	14.00
6" x 8"	SSA6008	16.00
8" x 8"	SSA8008	17.00

Product of: **TRAVIS PATTERN & FOUNDRY INC., SPOKANE, WASHINGTON**

Prices: SUBJECT TO CHANGE WITHOUT NOTICE

**FAX: (509) 467-6465 - PHONE: (509) 466-3545**





# TRAVIS

# STEEL

AVAILABLE IN HEAVIER GAUGE - CALL FOR PRICING

## STEEL STARTER COUPLERS

### OPTIONS

SIZE	WT.	DESIGNATION	GALV.		
			DESIGNATION	W/Hook DESIGNATION	W/Hook DESIGNATION
2"	1.00 lbs	SCB200	SCG200	SCBHB200	SCGHB200
3"	1.00	SCB300	SCG300	SCBHB300	SCGHB300
4"	1.50	SCB400	SCG400	SCBHB400	SCGHB400
5"	2.00	SCB500	SCG500	SCBHB500	SCGHB500
6"	2.75	SCB600	SCG600	SCBHB600	SCGHB600
7"	3.50	SCB700	SCG700	SCBHB700	SCGHB700
8"	4.50	SCB800	SCG800	SCBHB800	SCGHB800
10"	5.50	SCB1000	SCG1000	SCBHB1000	SCGHB1000
12"	9.00	SCB1200	SCG1200	SCBHB1200	SCGHB1200



AVAILABLE IN HEAVIER GAUGE - CALL FOR PRICING

## STEEL STARTER

Black-Male



SIZE	WT.	DESIGNATION	GALV.	
			DESIGNATION	DESIGNATION
3"	1.20 lbs	SCBM300	SCGM300	SCGM300
4"	1.50	SCBM400	SCGM400	SCGM400
5"	2.00	SCBM500	SCGM500	SCGM500
6"	2.77	SCBM600	SCGM600	SCGM600
7"	3.50	SCBM700	SCGM700	SCGM700
8"	4.50	SCBM800	SCGM800	SCGM800
10"	5.50	SCBM1000	SCGM1000	SCGM1000
12"	9.00	SCBM1200	SCGM1200	SCGM1200

## STEEL STARTER DEEP AND EXTRA DEEP PUNCH

### DEEP 4"

SIZE	WT.	DESIGNATION
6"	3.7 lbs	SCB 600 D
8"	6.4	SCB 800 D
10"	9.1	SCB 1000 D

### EXTRA DEEP

SIZE	WT.	DEPTH	DESIGNATION
4"	3.1 lbs	7.0"	SCB 400 ED
6"	5.0	8.5"	SCB 600 ED
8"	10.9	11.5"	SCB 800 ED

## STEEL HOSE REPAIR FITTING

Features two hose beads welded back to back - galvanized



SIZE	DESIGNATION	WT.	SIZE	DESIGNATION	WT.
2"	HRC200	2.2 lbs	5"	HRC500	6.3 lbs
3"	HRC300	3.8	6"	HRC600	7.5
4"	HRC400	5.0	8"	HRC800	14.0

Product of: **TRAVIS PATTERN & FOUNDRY INC., SPOKANE, WASHINGTON**

Prices: SUBJECT TO CHANGE WITHOUT NOTICE

**FAX: (509) 467-6465 - PHONE: (509) 466-3545**

Prices effective: August 2008

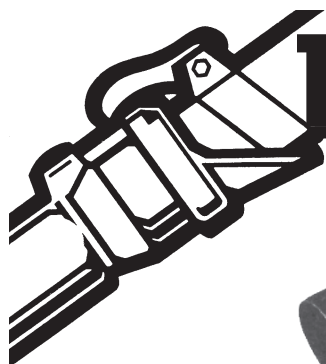

# TRAVIS

# STEEL

## BLACK STEEL WELD ELBOW - 90°

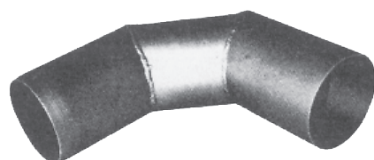

DESIGNATION	WT.
SWE300	4.00 lbs
SWE400	6.00
SWE500	8.00
SWE600	10.00
SWE700	11.00
SWE800	12.00
SWE1000	15.00

## BLACK WELD-ON 90° ELBOW

## BLACK STEEL WELD ELBOW - 45°

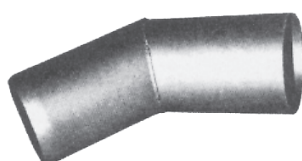

DESIGNATION	WT.
SWE-45300	3.00 lbs
SWE-45400	5.00
SWE-45500	7.00
SWE-45600	9.00
SWE-45700	10.00
SWE-45800	11.00
SWE-451000	13.00

## BLACK WELD-ON 45° ELBOW

## BLACK WELDING CONES



Size	Wt.		14 GA	10 GA	Size	Wt.				
	PER	100 PCS.				PER	100 PCS.	14GA	12GA	10GA
BWC-23		45.00 lbs			BWC-67		100.00 lbs			
BWC-24		100.00			BWC-48		390.00			
BWC-34		53.00			BWC-58		295.00			
BWC-35		150.00			BWC-68		210.00			
BWC-45		65.00			BWC-78		140.00			
BWC-36		195.00			BWC-89		170.00			
BWC-46		170.00			BWC-810		330.00			
BWC-56		85.00			BWC-910		215.00			
					BWC-1012		448.00			

Other sizes available upon request.

## BLACK ECCENTRIC WELDING CONES



SIZE	WT. PER 100 PIECES	SIZE	WT. PER 100 PIECES
BEC-32	225.00 lbs	BEC-84	1050.00 lbs
BEC-42	300.00	BEC-85	100.00
BEC-43	250.00	BEC-86	875.00
BEC-53	375.00	BEC-106	1400.00
BEC-54	325.00	BEC-108	1250.00
BEC-63	500.00	BEC-126	
BEC-64	425.00	BEC-128	
BEC-65	375.00	BEC-1210	

Other sizes available upon request.

Product of: **TRAVIS PATTERN & FOUNDRY INC., SPOKANE, WASHINGTON**

Prices: SUBJECT TO CHANGE WITHOUT NOTICE

**FAX: (509) 467-6465 - PHONE: (509) 466-3545**

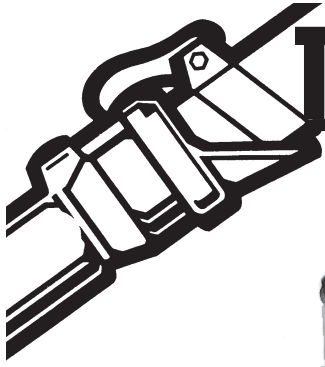

**TRAVIS**

**STEEL**

**STEEL UNIVERSAL VALVE STUB**



<i>SIZE</i>	<i>DESIGNATION</i>	<i>WT.</i>
3"	UVS-S300	2.00 lbs
4"	UVS-S400	2.80
5"	UVS-S500	3.80
6"	UVS-S600	5.80
8"	UVS-S800	15.00

**STEEL LUG-TYPE VALVE STUB**



<i>SIZE</i>	<i>DESIGNATION</i>	<i>WT.</i>
3"	UVS-SL300	2.00 lbs
4"	UVS-SL400	2.80
5"	UVS-SL500	3.80
6"	UVS-SL600	5.80

**STEEL VALVE STUB W/FIPT**

Second number designates thread size.



<i>DESIGNATION</i>	<i>WT.</i>
UVS-STF3002	4.00 lbs
UVS-STF3003	4.50
UVS-STF4003	5.00
UVS-STF4004	6.00
UVS-STF5005	7.00
UVS-STF6006	8.50
UVS-STF8008	28.00

**STEEL VALVE STUB W/MIPT**

Second number designates thread size.



<i>DESIGNATION</i>	<i>WT.</i>
UVS-STM3002	4.00 lbs
UVS-STM3003	4.50
UVS-STM4003	5.00
UVS-STM4004	6.00
UVS-STM5005	7.50
UVS-STM6006	9.00
UVS-STM8008	25.00

Product of: **TRAVIS PATTERN & FOUNDRY INC., SPOKANE, WASHINGTON**

Prices: SUBJECT TO CHANGE WITHOUT NOTICE

**FAX: (509) 467-6465 - PHONE: (509) 466-3545**

Prices effective: August 2008



# TRAVIS

# STEEL

## CIRCLE LOCK SURGE PLUG

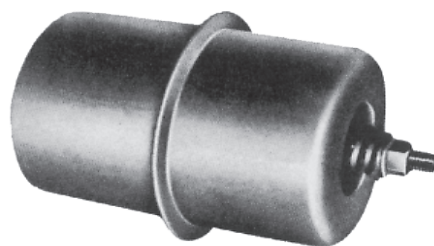

SIZE	WT.	DESIGNATION
4"	7.2 lbs	SRL-SP400
5"	7.8	SRL-SP500
6"	8.6	SRL-SP600
7"	9.0	SRL-SP700
8"	11.7	SRL-SP800
10"	12.7	SRL-SP1000

\*85 psi standard

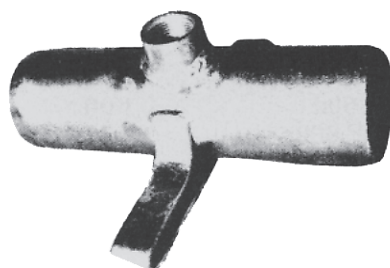

## PRESS-IN CENTER OUTLET

Presses into aluminum tubing sections to provide sprinkler outlet.

DESIGNATION	WT.
PCR300	3.50 lbs
PCR400	4.00

Available with riser outlet reinforcing bridge.

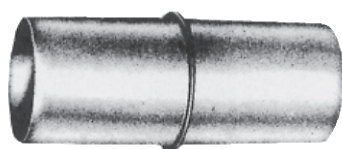

## STEEL REPAIR SLEEVE

\*LONG LENGTH

Standard length is 7" on 3", 4" & 5".  
Also available in 10" length.

\*For long length add "L" to Part #.

DESIGNATION	WT.
SRS300 L	2.00 lbs
SRS400 L	2.50
SRS500 L	3.50
SRS600	4.50
SRS700	5.50
SRS800	7.00
SRS1000	11.00

## STEEL HOSE ENDS RAISED BEAD



SIZE	Band & Latch Male*	
	DESIGNATION	WT.
2"	BLSHM200	1.9 lbs
3"	BLSHM300	3.3
4"	BLSHM400	4.3
5"	BLSHM500	5.4
6"	BLSHM600	6.5

SIZE	Female	
	DESIGNATION	WT.
2"	BLSHF200	2.6 lbs
3"	BLSHF300	4.5
4"	BLSHF400	6.0
5"	BLSHF500	7.5
6"	BLSHF600	9.0

SIZE	Ringlock Male	
	DESIGNATION	WT.
3"	SRLHM300	3.0 lbs
4"	SRLHM400	4.0
5"	SRLHM500	5.0
6"	SRLHM600	7.0
8"	SRLHM800	11.0
10"	SRLHM1000	15.0

SIZE	Female	
	DESIGNATION	WT.
3"	SRLHF300	3.4 lbs
4"	SRLHF400	4.5
5"	SRLHF500	5.6
6"	SRLHF600	6.5
8"	SRLHF800	10.5
10"	SRLHF1000	14.5

Product of: **TRAVIS PATTERN & FOUNDRY INC., SPOKANE, WASHINGTON**

Prices: SUBJECT TO CHANGE WITHOUT NOTICE

**FAX: (509) 467-6465 - PHONE: (509) 466-3545**

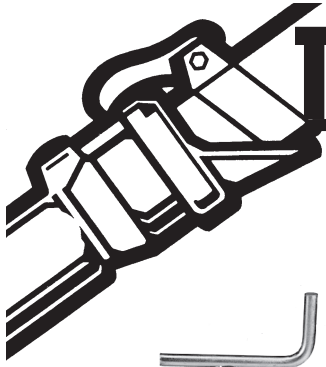

# TRAVIS

# STEEL

## STEEL UNIVERSAL VALVE OPENERS



**SUVEO**

### Steel Elbow Opener

	<i>SIZE</i>	<i>WT.</i>	<i>DESIGNATION</i>
	3" x 2"	8.0 lbs	SUVEO302
	3" x 3"	8.5	SUVEO303
	4" x 3"	10.0	SUVEO403
	4" x 4"	11.0	SUVEO404
	5" x 4"	13.0	SUVEO504
	5" x 5"	13.0	SUVEO505
	6" x 4"	14.0	SUVEO604
3/4" OUTLET AVAILABLE UPON REQUEST	6" x 5"	14.5	SUVEO605
Available with Ames ABC outlet.	6" x 6"	15.0	SUVEO606
	8" x 6"	23.0	SUVEO806
	8" x 8"	27.0	SUVEO808



**SUVEO-T**

### Steel Tee Opener

	<i>SIZE</i>	<i>WT.</i>	<i>DESIGNATION</i>
	3" x 2" x 2"	9.0 lbs	SUVEO-T322
	3" x 3" x 3"	10.0	SUVEO-T333
	4" x 3" x 3"	13.0	SUVEO-T433
	4" x 4" x 4"	14.0	SUVEO-T444
	5" x 4" x 4"	15.0	SUVEO-T544
3/4" OUTLET AVAILABLE UPON REQUEST	5" x 5" x 5"	16.0	SUVEO-T555
Available with Ames ABC outlet.	6" x 4" x 4"	17.0	SUVEO-T644
	6" x 5" x 5"	18.0	SUVEO-T655
	6" x 6" x 6"	18.0	SUVEO-T666
	8" x 6" x 6"	20.0	SUVEO-T866
	8" x 8" x 8"	23.0	SUVEO-T888



**SUVEO-GS**

### Steel Gun Stand Opener

	<i>SIZE</i>	<i>WT.</i>	<i>DESIGNATION</i>
	3" x 3"	8.5 lbs	SUVEO-GS303
	4" x 3"	10.0	SUVEO-GS403
	*3" ips standard		

Product of: **TRAVIS PATTERN & FOUNDRY INC., SPOKANE, WASHINGTON**

Prices: SUBJECT TO CHANGE WITHOUT NOTICE

**FAX: (509) 467-6465 - PHONE: (509) 466-3545**

Prices effective: August 2008

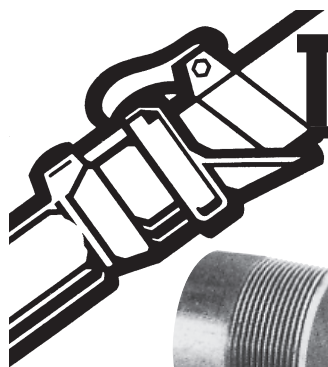

# TRAVIS

# STEEL

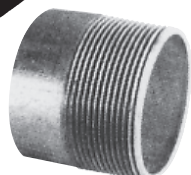

SIZE	1/2 NIPS
3/4"	
1"	
1 1/4"	
1 1/2"	
2"	
2 1/2"	
3"	
4"	
5"	
6"	

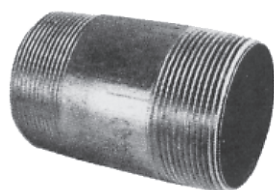

SIZE	FULL NIPS
3/4"	
1"	
1 1/4"	
1 1/2"	
2"	
2 1/2"	
3"	
4"	
5"	
6"	



SIZE	1/2 COUP.
3/4"	
1"	
1 1/4"	
1 1/2"	
2"	
2 1/2"	
3"	
4"	
5"	
6"	

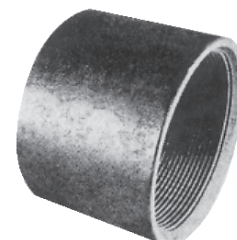

SIZE	FULL COUP.
3/4"	
1"	
1 1/4"	
1 1/2"	
2"	
2 1/2"	
3"	
4"	
5"	
6"	



SIZE	HOSE BEADS
2"	
2 1/2"	
3"	
4"	
5"	
6"	
8"	
10"	
12"	



SIZE	WELDING DISCS
2"	
3"	
4"	
5"	
6"	
7"	
8"	
10"	
12"	



**HOOK BOSS**  
LG.  
SM.



**HOOK BRACKET**  
SMALL



**HOOK BRACKET**  
LARGE

**LATCHSPRING**

**BAILSPRING**

## STEEL

### COUPLER PANS

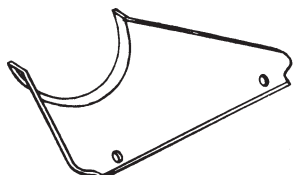

SIZE	ITEM #	STEEL	ITEM #	ALUM
2"	CP-2		ACP-2	
3"	CP-3		ACP-3	
4"	CP-4			
5"	CP-5			
6"	CP-6			

Product of: **TRAVIS PATTERN & FOUNDRY INC., SPOKANE, WASHINGTON**

Prices: SUBJECT TO CHANGE WITHOUT NOTICE

**FAX: (509) 467-6465 - PHONE: (509) 466-3545**

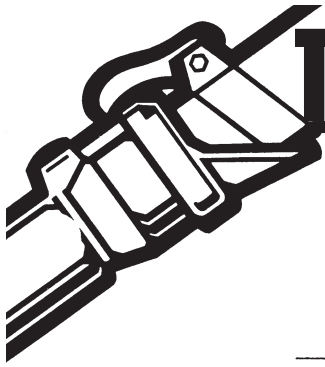

# TRAVIS

# STEEL

## Steel "Z" — Drop — Galvanized

### Band and Latch

BL-Z-4	4"
BL-Z-5	5"
BL-Z-6	6"
BL-Z-7	7"

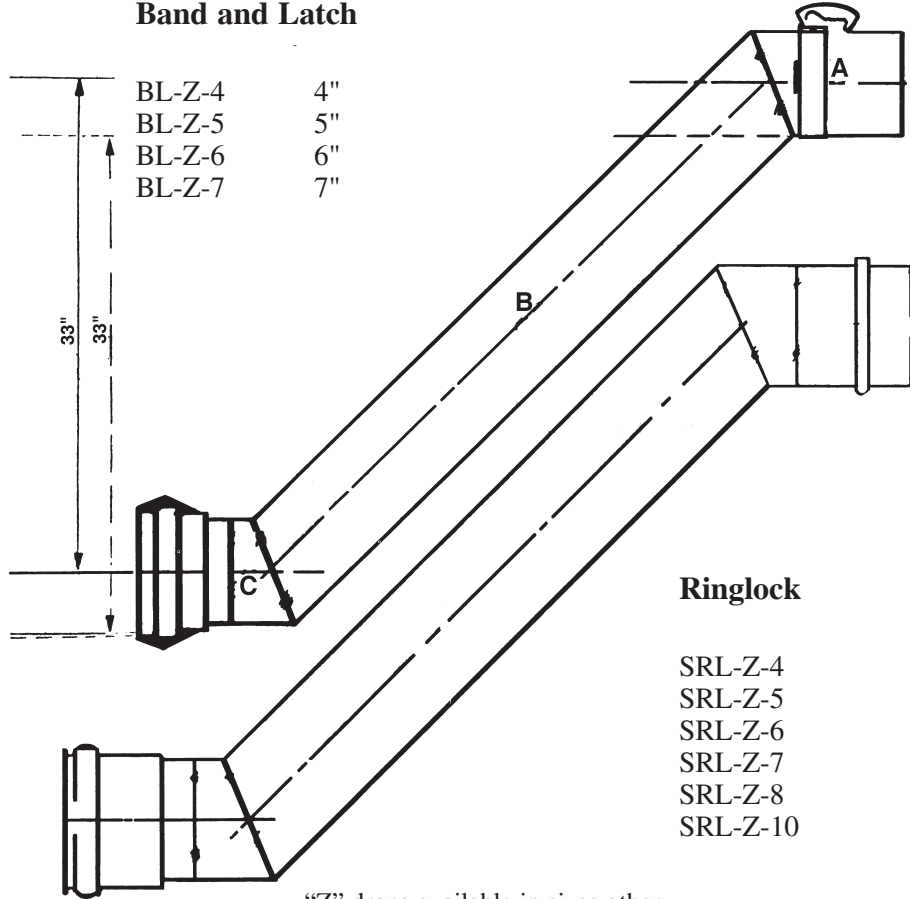

### Ringlock

SRL-Z-4	4"
SRL-Z-5	5"
SRL-Z-6	6"
SRL-Z-7	7"
SRL-Z-8	8"
SRL-Z-10	10"

"Z" drops available in sizes other than shown above. Call factory.

### FULL BAND AND LATCH

(including Nut, Bolt and Ferrule)  
Uses Pierce type hook.



SIZE	WT.	DESIGNATION
2"	1.0 lbs	PBL 200
3"	1.0	PBL 300
4"	1.5	PBL 400
5"	2.0	PBL 500
6"	2.5	PBL 600
7"	3.0	PBL 700
8"	3.0	PBL 800
10"	3.5	PBL 1000

### (A) FULL BAND ONLY

SIZE	WT.	DESIGNATION
2"	0.5 lbs	B 200
3"	0.5	B 300
4"	0.8	B 400
5"	1.5	B 500
6"	1.5	B 600
7"	2.0	B 700
8"	2.5	B 800
10"	3.0	B 1000

### (B) OUTSIDE LATCH

Pierce type galvanized steel hook

### (C) LATCH FERRULE

$\frac{5}{16}$ " FERRULE A  
 $\frac{1}{2}$ " FERRULE B

Product of: **TRAVIS PATTERN & FOUNDRY INC., SPOKANE, WASHINGTON**

Prices: SUBJECT TO CHANGE WITHOUT NOTICE

**FAX: (509) 467-6465 - PHONE: (509) 466-3545**

Prices effective: August 2008